

**ELECTROMAGNETIC EMISSIONS COMPLIANCE REPORT  
INTENTIONAL RADIATOR CERTIFICATION TO  
FCC PART 15 SUBPART C REQUIREMENT**

*OF*

**Reader**

**MODEL No.: XC-RF861**

**FCC ID: TQ4XC-RF861**

**Trademark: Invengo**

**REPORT NO: ES140324216E**

**ISSUE DATE: April 30, 2014**

*Prepared for*  
**INVENGO INFORMATION TECHNOLOGY CO., LTD.**

**3/F, No.T2-B, High-tech industrial Park South, Shenzhen 518057, china**

*Prepared by*  
**SHENZHEN EMTEK CO., LTD**

**Bldg 69, Majialong Industry Zone, Nanshan District,  
Shenzhen, Guangdong, China  
TEL: 86-755-26954280  
FAX: 86-755-26954282**

## VERIFICATION OF COMPLIANCE

Applicant:	INVENGO INFORMATION TECHNOLOGY CO., LTD. 3/F, No.T2-B, High-tech industrial Park South, Shenzhen 518057, china
Manufacturer:	INVENGO INFORMATION TECHNOLOGY CO., LTD. 3/F, No.T2-B, High-tech industrial Park South, Shenzhen 518057, china
Product Description:	Reader
Model Number:	XC-RF861
Serial Number:	N/A
File Number:	ES140324216E

### We hereby certify that:

The above equipment was tested by SHENZHEN EMTEK CO., LTD. The test data, data evaluation, test procedures, and equipment configurations shown in this report were made in accordance with the procedures given in ANSI C63.4 (2009) and the energy emitted by the sample EUT tested as described in this report is in compliance with conducted and radiated emission limits of FCC Rules Part 15.247.

The test results of this report relate only to the tested sample identified in this report.

Date of Test : February 27, 2014 to April 20, 2014

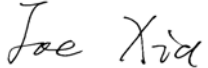
Prepared by :   
Joe Xia/Editor

Reviewer :   
June Xie/Supervisor

Approve & Authorized Signer :   
Lisa Wang/Manager

## Table of Contents

<b>1.</b>	<b>GENERAL INFORMATION .....</b>	<b>5</b>
1.1	PRODUCT DESCRIPTION .....	5
1.2	RELATED SUBMITTAL(S) / GRANT (S) .....	5
1.3	TEST METHODOLOGY .....	5
1.4	SPECIAL ACCESSORIES .....	5
1.5	EQUIPMENT MODIFICATIONS .....	5
1.6	TEST FACILITY .....	6
<b>2.</b>	<b>SYSTEM TEST CONFIGURATION .....</b>	<b>7</b>
2.1	EUT CONFIGURATION .....	7
2.2	EUT EXERCISE .....	7
2.3	TEST PROCEDURE .....	7
2.4	LIMITATION .....	7
2.5	CONFIGURATION OF TESTED SYSTEM .....	10
2.6	EQUIPMENT USED IN TESTED SYSTEM .....	11
2.7	DESCRIPTION OF TEST MODES .....	12
<b>3.</b>	<b>SUMMARY OF TEST RESULTS .....</b>	<b>13</b>
<b>4.</b>	<b>CONDUCTED EMISSIONS TEST .....</b>	<b>14</b>
4.1	MEASUREMENT PROCEDURE: .....	14
4.2	TEST SET-UP (BLOCK DIAGRAM OF CONFIGURATION) .....	14
4.3	MEASUREMENT EQUIPMENT USED: .....	14
4.4	CONDUCTED EMISSION LIMIT .....	14
4.5	MEASUREMENT RESULT: .....	15
<b>5.</b>	<b>RADIATED EMISSION TEST .....</b>	<b>17</b>
5.1	MEASUREMENT PROCEDURE .....	17
5.2	TEST SET-UP (BLOCK DIAGRAM OF CONFIGURATION) .....	18
5.3	MEASUREMENT EQUIPMENT USED: .....	19
5.4	MEASUREMENT RESULT .....	20
<b>6.</b>	<b>CHANNEL SEPARATION TEST .....</b>	<b>26</b>
6.1	MEASUREMENT PROCEDURE .....	26
6.2	TEST SET-UP (BLOCK DIAGRAM OF CONFIGURATION) .....	26
6.3	MEASUREMENT EQUIPMENT USED: .....	26
6.4	MEASUREMENT RESULTS: .....	26
<b>7.</b>	<b>20DB BANDWIDTH TEST .....</b>	<b>29</b>
7.1	MEASUREMENT PROCEDURE .....	29
7.2	TEST SET-UP (BLOCK DIAGRAM OF CONFIGURATION) .....	29
7.3	MEASUREMENT EQUIPMENT USED: .....	29
7.4	MEASUREMENT RESULTS: .....	29

<b>8.</b>	<b>QUANTITY OF HOPPING CHANNEL TEST.....</b>	<b>32</b>
8.1	MEASUREMENT PROCEDURE.....	32
8.2	TEST SET-UP (BLOCK DIAGRAM OF CONFIGURATION).....	32
8.3	MEASUREMENT EQUIPMENT USED: .....	32
8.4	MEASUREMENT RESULTS:.....	32
<b>9.</b>	<b>TIME OF OCCUPANCY (DWELL TIME) TEST .....</b>	<b>34</b>
9.1	MEASUREMENT PROCEDURE.....	34
9.2	LIMIT .....	34
9.3	TEST SET-UP (BLOCK DIAGRAM OF CONFIGURATION).....	34
9.4	MEASUREMENT EQUIPMENT USED: .....	34
9.5	MEASUREMENT RESULTS:.....	34
<b>10.</b>	<b>MAXIMUM PEAK OUTPUT POWER TEST.....</b>	<b>36</b>
10.1	MEASUREMENT PROCEDURE.....	36
10.2	TEST SET-UP (BLOCK DIAGRAM OF CONFIGURATION).....	36
10.3	MEASUREMENT EQUIPMENT USED: .....	36
10.4	MEASUREMENT RESULTS:.....	36
<b>11.</b>	<b>BAND EDGE TEST .....</b>	<b>37</b>
11.1	MEASUREMENT PROCEDURE.....	37
11.2	TEST SET-UP (BLOCK DIAGRAM OF CONFIGURATION).....	37
11.3	MEASUREMENT EQUIPMENT USED: .....	37
11.4	MEASUREMENT RESULTS:.....	37
<b>12.</b>	<b>ANTENNA PORT EMISSION.....</b>	<b>39</b>
12.1	TEST EQUIPMENT.....	39
12.2	MEASURING INSTRUMENTS AND SETTING.....	39
12.3	TEST PROCEDURES .....	39
12.4	BLOCK DIAGRAM OF TEST SETUP.....	39
12.5	TEST RESULT .....	39
<b>13.</b>	<b>ANTENNA APPLICATION.....</b>	<b>43</b>
13.1	ANTENNA REQUIREMENT .....	43
13.2	RESULT .....	43

## **1. GENERAL INFORMATION**

### **1.1 Product Description**

A major technical descriptions of EUT is described as following:

- A). Operation Frequency: 902.75-927.25 MHz
- B). Modulation: ASK
- C). Number of Channel: 50
- D). Channel space: 500kHz
- E). RF Output Power: 27.34 dBm Max
- F). Antenna Type: External antenna
- G). Antenna GAIN: 7.15dBi
- H). Power Supply: DC 24V from adapter
- I). Adapter: Model: FSP060-DBAB2  
AC Input: 100-240V~, 1.5A, 50-60Hz  
DC output: DC24V, 2.5Amax(60W max)

### **1.2 Related Submittal(s) / Grant (s)**

This submittal(s) (test report) is intended for FCC ID: TQ4XC-RF861 filing to comply with Section 15.247 of the FCC Part 15 Subpart C Rules.

### **1.3 Test Methodology**

Both conducted and radiated testing was performed according to the procedures in ANSI C63.4 (2009) and FCC Public Notice DA 00-705. Radiated testing was performed at an antenna to EUT distance 3 meters.

### **1.4 Special Accessories**

Not available for this EUT intended for grant.

### **1.5 Equipment Modifications**

Not available for this EUT intended for grant.

## 1.6 Test Facility

Site Description EMC Lab.	: Accredited by CNAS, 2013.10.29 The certificate is valid until 2016.10.28 The Laboratory has been assessed and proved to be in compliance with CNAS/CL01:2006(identical to ISO/IEC17025: 2005) The Certificate Registration Number is L2291  Accredited by TUV Rheinland Shenzhen 2010.5.25 The Laboratory has been assessed according to the requirements ISO/IEC 17025  Accredited by FCC, April 17, 2013 The Certificate Registration Number is 406365.  Accredited by Industry Canada, March 5, 2010 The Certificate Registration Number is 4480A-2.
Name of Firm	: SHENZHEN EMTEK CO., LTD
Site Location	: Bldg 69, Majialong Industry Zone, Nanshan District, Shenzhen, Guangdong, China

## 2. System Test Configuration

### 2.1 EUT Configuration

The EUT configuration for testing is installed on RF field strength measurement to meet the Commissions requirement and operating in a manner which intends to maximize its emission characteristics in a continuous normal application.

### 2.2 EUT Exercise

The Transmitter was operated in the normal operating mode. The TX frequency was fixed which was for the purpose of the measurements.

### 2.3 Test Procedure

#### 2.3.1 Conducted Emissions

The EUT is a placed on as turn table which is 0.8 m above ground plane. According to the requirements in Section 13.1.4.1 of ANSI C63.4-2009 Conducted emissions from the EUT measured in the frequency range between 0.15 MHz and 30MHz using CISPR Quasi-Peak and average detector mode.

#### 2.3.2 Radiated Emissions

The EUT is a placed on as turn table which is 0.8 m above ground plane. The turn table shall rotate 360 degrees to determine the position of maximum emission level. EUT is set 3m away from the receiving antenna which varied from 1m to 4m to find out the highest emission. And also, each emission was to be maximized by changing the polarization of receiving antenna both horizontal and vertical. In order to find out the max. emission, the relative positions of this hand-held transmitter(EUT) was rotated through three orthogonal axes according to the requirements in Section 13.1.4.1 of ANSI C63.4-2009.

### 2.4 Limitation

#### (1) Channel Separation test

FCC Part 15, Subpart C Section 15.247(a)(1) Frequency hopping systems shall have hopping channel carrier frequencies separated by a minimum of 25kHz or the 20 Bandwidth of the hopping channel, whichever is greater.

Frequency Range (MHz)	Limit(kHz)
902-928	>25kHz
2400-2483.5	>25kHz
5725-5850	>25kHz

(2)

Frequency Range(MHz)	Quantity of Hopping Channel	20dB Bandwidth Limit(kHz)			
		50	25	15	75
902-928		<250	>250	NA	NA
2400-2483.5		NA	NA	>1000	<1000

(3) Quantity of Hopping Channel

FCC Part 15, Subpart C Section 15.247

Frequency Range (MHz)	Limit(Quantity of Hopping Channel)			
	20dB bandwidth <250kHz	20dB bandwidth >250kHz	20dB bandwidth <1MHz	20dB bandwidth >1MHz
902-928	50	25	NA	NA
2400-2483.5	NA	NA	75	15
5725-5850	NA	NA	75	NA

(4) Time of Occupancy(Dwell Time)

FCC Part 15, Subpart C Section 15.247

Frequency Range (MHz)	LIMIT(rms)		
	20dB bandwidth <250kHz(50Channel)	20dB bandwidth >250kHz(25Channel)	20dB bandwidth <1MHz(75Channel)
902-928	400(20S)	400(10S)	NA
2400-2483.5	NA	NA	400(30S)
5725-5850	NA	NA	400(30S)

Note: The “()”is all channel’s average time of occupancy.

(5) Maximum Peak Output Power

FCC Part 15, Subpart C Section 15.247

Frequency Range (MHz)	Quantity of Hopping Channel	LIMIT(W)			
		50	25	15	75
902-928		1(30dBm)	0.125(21dBm)	NA	NA
2400-2483.5		NA	NA	0.125(21dBm)	1(30dBm)
5725-5850		NA	NA	NA	1(30dBm)



**(6) Band edge**

FCC Part15, Subpart C Section 15.247, In any 100kHz bandwidth outside the frequency band in with the spread spectrum intentional radiator is operating, the radio frequency power that is produced by the intentional radiator shall be at least 20dB below that in the 100kHz bandwidth within the band that contains the highest level of the desired power, based on either an RF conducted or a radiated measurement, attenuation below the general limits specified in section 15.209(a) is not required. In addition, radiated emissions which fall in the restricted bands, as defined in section 15.205(a), must also comply with the radiated emission limits specified in section 15.209(a).

Operating Frequency Range(MHz)	Spurious emission frequency	Limit	
		Peak power ration to emission(dBc)	Emission level(dBuV/m)
902-928	<902	>20	NA
	>928	>20	NA
	960-1240	NA	54
2400-2483.5	<2400	>20	NA
	>2483.5-2500	NA	54
5725-5850	<5350-5460	NA	54
	<5725	>20	NA
	>5850	>20	NA

**(7) Conducted Emission**

Frequency(MHz)	Quasi-peak	Average
0.15-0.5	66-56	56-46
0.5-5.0	56	46
5.0-30.0	60	50

**Note:**

1. The lower limit shall apply at the transition frequencies
2. The limit decreases in line with the logarithm of the frequency in the range of 0.15 to 0.50MHz.

**(8) Radiated Emission**

FCC Part 15, Subpart C Section 15.209 limit of radiated emission for frequency below 1000GHz. The emissions from an intentional radiator shall not exceed the field strength level specified in the following table:

Frequency (MHz)	Field strength $\mu\text{V/m}$	Distance(m)	Field strength at 3m $\text{dB}\mu\text{V/m}$
0.009~0.490	2400/F(KHz)	300	See the remark
0.490~1.705	2400/F(KHz)	30	
1.705~30.0	30	30	
30-88	100	3	40
88-216	150	3	43.5
216-960	200	3	46
Above 960	500	3	54

- Remark: 1. Emission level in  $\text{dB}\mu\text{V/m}=20 \log (\text{uV/m})$   
 2. Measurement was performed at an antenna to the closed point of EUT distance of meters.  
 3. Distance extrapolation factor  $=40\log(\text{Specific distance/ test distance})(\text{dB})$ ;  
 Limit line=Specific limits( $\text{dB}\mu\text{V}$ ) + distance extrapolation factor.

**2.5 Configuration of Tested System**

**Fig. 2-1 Configuration of Tested System**

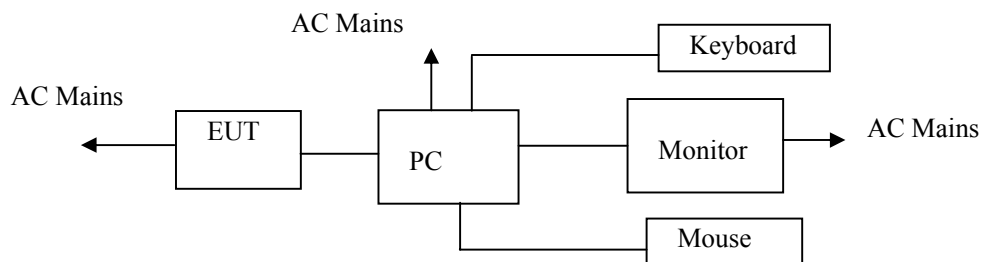

## 2.6 Equipment Used in Tested System

PC	:	Manufacturer: LENOVO M/N: 9702 S/N: L3C4410 CE, FCC: DOC Power cord : Unshielded, Detachabled, 1.5m
LCD Monitor	:	Manufacturer: LENOVO M/N: 9227-AE6 S/N:4M0293084302824 CE, FCC: DOC Power cord : Unshielded, Detachabled, 1.5m Data Cable: Unshielded, Undetachabled, 2.0m
Keyboard	:	Manufacturer: LENOVO M/N: KU-0225 S/N:0585494 CE, FCC: DOC Data Cable: Unshielded, Undetachabled, 2.0m
Mouse	:	Manufacturer: LENOVO M/N: MO28UOL S/N:44G7862 068 CE, FCC: DOC Data Cable: Unshielded, Undetachabled, 2.0m

### Note:

- (1) Unless otherwise denoted as EUT in 『Remark』 column , device(s) used in tested system is a support equipment.

## 2.7 Description of test modes

The EUT has been tested under TX operating condition.

50 Channels are provided by EUT. The 3 channels of lower, medium and higher were chosen for test.

<b>Channel</b>	<b>Frequency(MHz)</b>
1	902.75
26	915.25
50	927.25

### 3. Summary of Test Results

<b>FCC Rule</b>	<b>Description Of Test</b>	<b>Result</b>
15.247(a)(1)	Channel Separation test	Pass
15.247(a)(1)	20dB Bandwidth	Pass
15.247(a)(1)	Quantity of Hopping Channel	Pass
15.247(a)(1)	Time of Occupancy (Dwell Time)	Pass
15.247(b)(1)	Max Peak output Power test	Pass
15.247(d)	Band edge test	Pass
15.207	AC Power Conducted Emission	Pass
15.247(d)	Radiated Emission	Pass
§15.247(d)	Antenna Port Emission	Pass
15.203&15.247(b)	Antenna Application	Pass

## 4. Conducted Emissions Test

### 4.1 Measurement Procedure:

1. The EUT was placed on a table which is 0.8m above ground plane.
2. Maximum procedure was performed on the six highest emissions to ensure EUT compliance.
3. Repeat above procedures until all frequency measured were complete.

### 4.2 Test SET-UP (Block Diagram of Configuration)

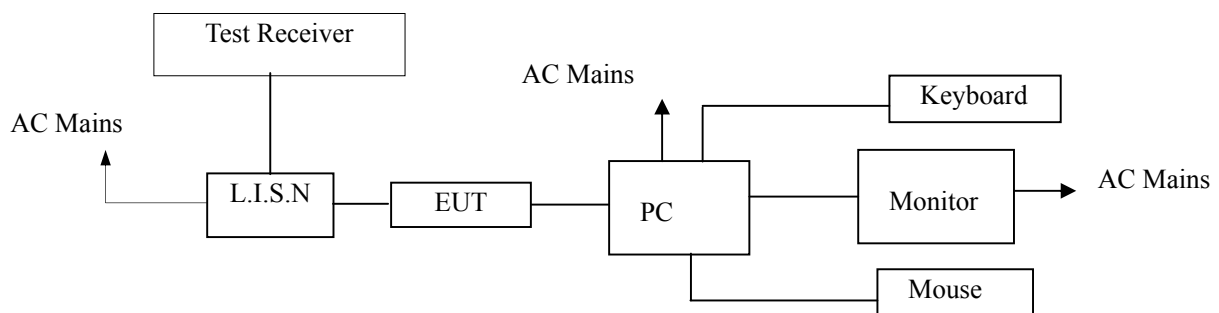

### 4.3 Measurement Equipment Used:

Conducted Emission Test Site # 4					
EQUIPMENT TYPE	MFR	MODEL NUMBER	SERIAL NUMBER	LAST CAL.	CAL DUE.
Test Receiver	Rohde & Schwarz	ESCS30	828985/018	05/29/2013	05/28/2014
L.I.S.N	Rohde & Schwarz	ESH2-Z5	834549/005	05/29/2013	05/28/2014
50ΩCoaxial Switch	Anritsu	MP59B	M20531	05/29/2013	05/28/2014

### 4.4 Conducted Emission Limit

#### (7) Conducted Emission

Frequency(MHz)	Quasi-peak	Average
0.15-0.5	66-56	56-46
0.5-5.0	56	46
5.0-30.0	60	50

#### Note:

1. The lower limit shall apply at the transition frequencies
2. The limit decreases in line with the logarithm of the frequency in the range of 0.15 to 0.50MHz.

**4.5 Measurement Result:**

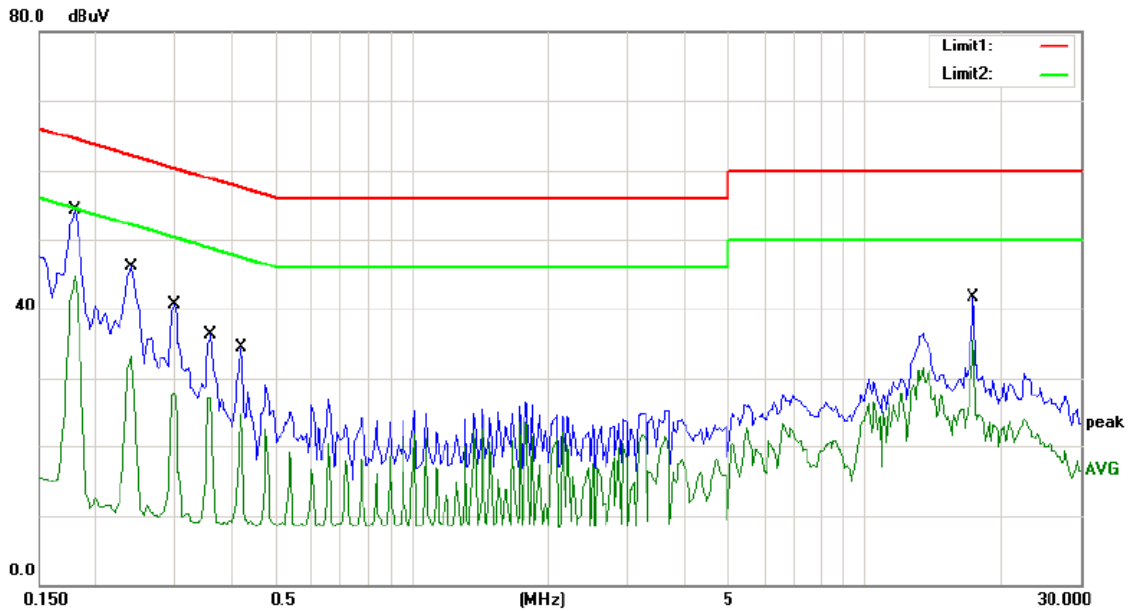

Site Conduction #2 Phase: **L1** Temperature: 22  
 Limit: (CE)FCC PART 15 class B\_QP Power: AC 120V/60Hz Humidity: 53 %  
 Mode: TX ON  
 Note:

No.	Mk.	Freq. MHz	Reading Level dBuV	Correct Factor dB	Measure- ment dBuV	Limit dBuV	Over dB	Detector	Comment
1		0.1800	54.29	0.00	54.29	64.49	-10.20	QP	
2	*	0.1800	44.69	0.00	44.69	54.49	-9.80	AVG	
3		0.2400	46.19	0.00	46.19	62.10	-15.91	QP	
4		0.2400	33.19	0.00	33.19	52.10	-18.91	AVG	
5		0.3000	40.64	0.00	40.64	60.24	-19.60	QP	
6		0.3000	28.00	0.00	28.00	50.24	-22.24	AVG	
7		0.3600	36.23	0.00	36.23	58.73	-22.50	QP	
8		0.3600	27.19	0.00	27.19	48.73	-21.54	AVG	
9		0.4200	34.51	0.00	34.51	57.45	-22.94	QP	
10		0.4200	24.80	0.00	24.80	47.45	-22.65	AVG	
11		17.4250	41.72	0.00	41.72	60.00	-18.28	QP	
12		17.4250	35.43	0.00	35.43	50.00	-14.57	AVG	

\*:Maximum data x:Over limit !:over margin Comment: Factor build in receiver. Operator: DK

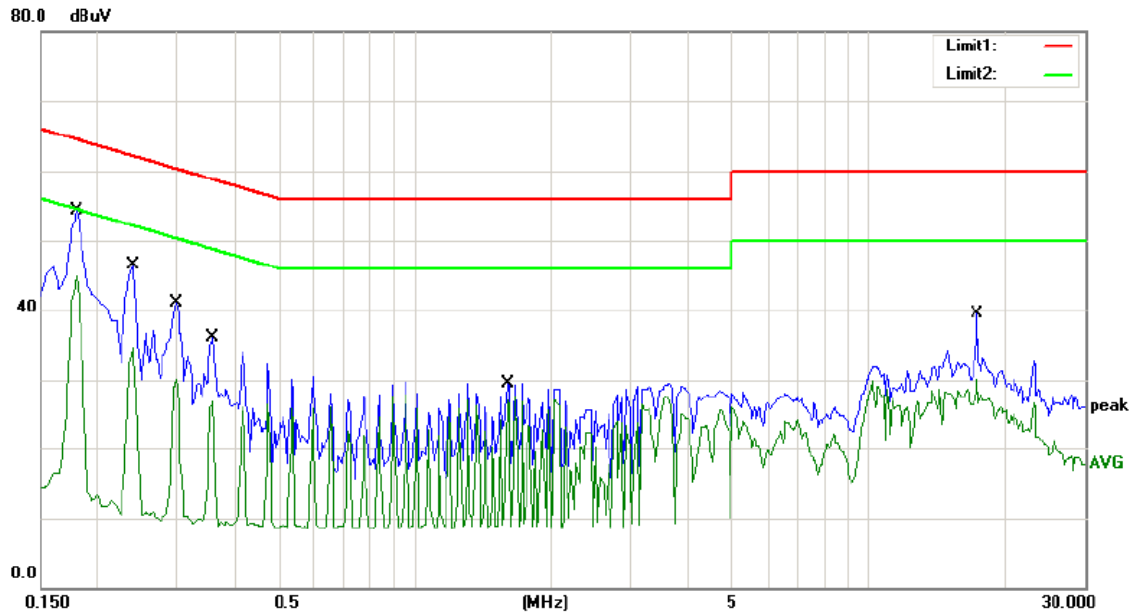

Site Conduction #2 Phase: **N** Temperature: 22  
 Limit: (CE)FCC PART 15 class B\_QP Power: AC 120V/60Hz Humidity: 53 %  
 Mode: TX ON  
 Note:

No.	Mk.	Freq. MHz	Reading Level dBuV	Correct Factor dB	Measure- ment dBuV	Limit dBuV	Over dB	Detector	Comment
1		0.1800	54.35	0.00	54.35	64.49	-10.14	QP	
2	*	0.1800	44.98	0.00	44.98	54.49	-9.51	AVG	
3		0.2400	46.55	0.00	46.55	62.10	-15.55	QP	
4		0.2400	34.61	0.00	34.61	52.10	-17.49	AVG	
5		0.3000	41.04	0.00	41.04	60.24	-19.20	QP	
6		0.3000	30.02	0.00	30.02	50.24	-20.22	AVG	
7		0.3600	36.19	0.00	36.19	58.73	-22.54	QP	
8		0.3600	26.97	0.00	26.97	48.73	-21.76	AVG	
9		1.6100	29.48	0.00	29.48	56.00	-26.52	QP	
10		1.6100	27.69	0.00	27.69	46.00	-18.31	AVG	
11		17.4250	39.46	0.00	39.46	60.00	-20.54	QP	
12		17.4250	30.18	0.00	30.18	50.00	-19.82	AVG	

\*:Maximum data x:Over limit !:over margin Comment: Factor build in receiver. Operator: DK



## **5. Radiated Emission Test**

### **5.1 Measurement Procedure**

1. The EUT was placed on a turn table which is 0.8m above ground plane.
2. Maximum procedure was performed on the six highest emissions to ensure EUT compliance.
3. And also, each emission was to be maximized by changing the polarization of receiving antenna both horizontal and vertical.
4. Repeat above procedures until all frequency measured was complete.

When spectrum scanned from 30 MHz to 1GHz setting resolution bandwidth 100 kHz and video bandwidth 300kHz. And spectrum scanned above 1GHz setting resolution bandwidth 1MHz, video bandwidth 3MHz.

**5.2 Test SET-UP (Block Diagram of Configuration)**

(A) Radiated Emission Test Set-Up, Frequency Below 30MHz

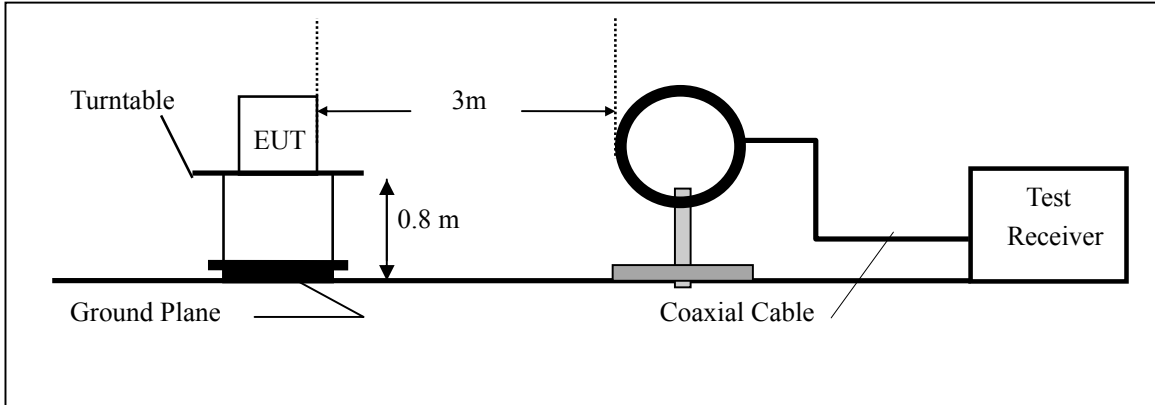

(B) Radiated Emission Test Set-Up, Frequency Below 1000MHz

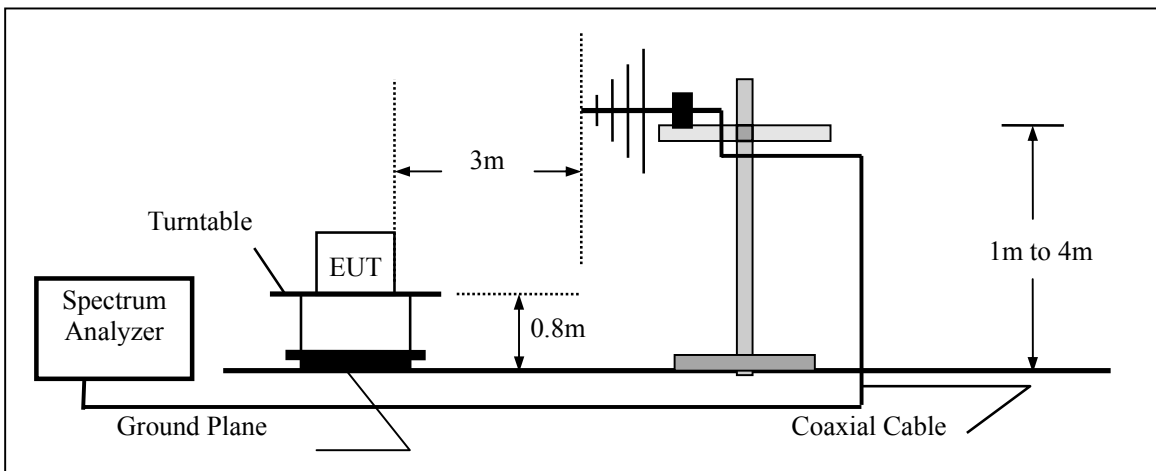

(C) Radiated Emission Test Set-Up, Frequency above 1000MHz

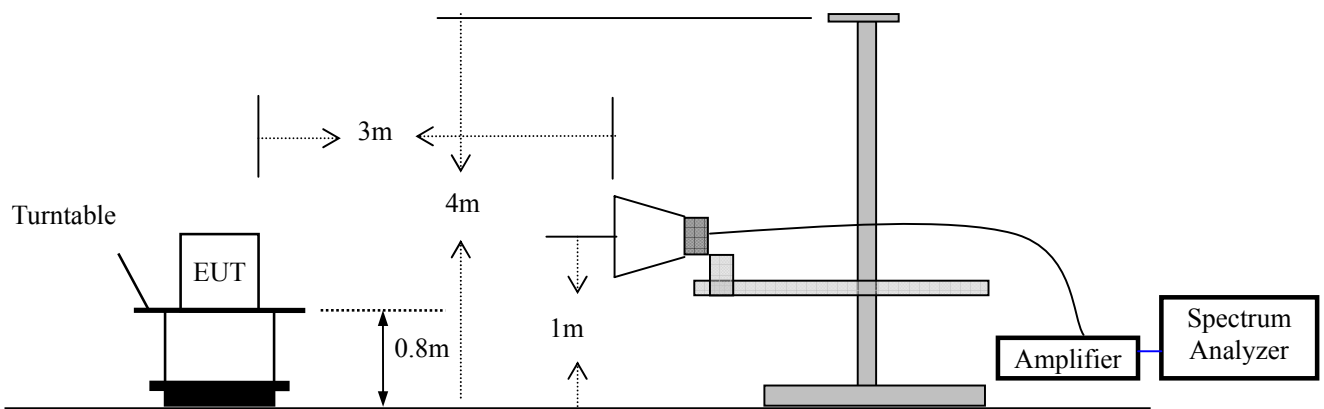

### 5.3 Measurement Equipment Used:

EQUIPMENT TYPE	MFR	MODEL NUMBER	SERIAL NUMBER	LAST CAL.	CAL DUE.
Spectrum Analyzer	Rohde & Schwarz	FSP7	839511/010	05/29/2013	05/28/2014
Spectrum Analyzer	HP	E4407B	839840481	05/29/2013	05/28/2014
EMI Test Receiver	Rohde & Schwarz	ESCS30	828985/018	05/29/2013	05/28/2014
Pre-Amplifier	HP	8447D	2944A07999	05/29/2013	05/28/2014
Bilog Antenna	Schwarzbeck	VULB9163	142	05/11/2013	05/10/2014
Loop Antenna	ARA	PLA-1030/B	1029	05/11/2013	05/10/2014
Horn Antenna	Schwarzbeck	BBHA 9170	BBHA9170399	05/11/2013	05/10/2014
Horn Antenna	Schwarzbeck	BBHA 9120	D143	05/11/2013	05/10/2014

## 5.4 Measurement Result

Operation Mode: TX Mode Test Date : April 19, 2014  
 Frequency Range: 9KHz~30MHz Temperature : 25°C  
 Test Result: PASS Humidity : 55 %  
 Measured Distance: 3m Test By: WOLF

Freq. (MHz)	Ant.Pol. H/V	Emission Level (dBuV/m)	Limit 3m (dBuV/m)	Over (dB)
--	--	--	--	--

Note: the amplitude of spurious emission that is attenuated by more than 20dB below the permissible limit has no need to be reported.

Operation Mode: CH1: 902.75MHz Test Date : April 19, 2014  
 Frequency Range: 30~1000MHz Temperature : 25°C  
 Test Result: PASS Humidity : 55 %  
 Measured Distance: 3m Test By: KL

Freq. (MHz)	Ant.Pol. H/V	Emission Level (dBuV/m)	Limit 3m (dBuV/m)	Margin (dB)	Note
59.54	V	21.37	40	59.54	QP
112.39	V	21.3	43.5	112.39	QP
196.33	V	21.69	43.5	196.33	QP
297.37	V	24.61	46	297.37	QP
350.22	V	25.62	46	350.22	QP
449.71	V	27.38	46	449.71	QP
53.32	H	21.71	40	53.32	QP
96.84	H	21.37	43.5	96.84	QP
190.11	H	22.19	43.5	190.11	QP
330.02	H	25.32	46	330.02	QP
465.26	H	27.69	46	465.26	QP
552.31	H	28.92	46	552.31	QP

- Note:**
- (1) All Readings are Peak Value.
  - (2) Emission Level= Reading Level+Probe Factor +Cable Loss.
  - (3) The average measurement was not performed when the peak measured data under the limit of average detection.
  - (4) EUT stood on the table position is the worst case result in the report.

Operation Mode:	CH26: 915.25MHz	Test Date :	April 19, 2014
Frequency Range:	30~1000MHz	Temperature :	25°C
Test Result:	PASS	Humidity :	55 %
Measured Distance:	3m	Test By:	KL

Freq. (MHz)	Ant.Pol. H/V	Emission Level (dBuV/m)	Limit 3m (dBuV/m)	Margin (dB)	Note
59.33	V	21.62	40	-18.38	QP
111.41	V	22.05	43.5	-21.45	QP
196.71	V	22.74	43.5	-20.76	QP
299.42	V	25.92	46	-20.08	QP
349.17	V	28.6	46	-17.4	QP
450.97	V	29.09	46	-16.91	QP
54.47	H	24.03	40	-15.97	QP
94.51	H	18.56	43.5	-24.94	QP
188.33	H	23.31	43.5	-20.19	QP
332.07	H	23.96	46	-22.04	QP
464.01	H	29.57	46	-16.43	QP
551.08	H	27.71	46	-18.29	QP

- Note:**
- (1) All Readings are Peak Value.
  - (2) Emission Level= Reading Level+Probe Factor +Cable Loss.
  - (3) The average measurement was not performed when the peak measured data under the limit of average detection.
  - (4) EUT stood on the table position is the worst case result in the report.

Operation Mode: CH50: 927.25MHz Test Date : April 19, 2014  
 Frequency Range: 30~1000MHz Temperature : 25°C  
 Test Result: PASS Humidity : 55 %  
 Measured Distance: 3m Test By: KL

Freq. (MHz)	Ant.Pol. H/V	Emission Level (dBuV/m)	Limit 3m (dBuV/m)	Margin (dB)	Note
59.35	V	21.72	40	-18.28	QP
113.44	V	21.18	43.5	-22.32	QP
198.45	V	20.71	43.5	-22.79	QP
295.02	V	20.92	46	-25.08	QP
350.34	V	22.51	46	-23.49	QP
450.15	V	28.46	46	-17.54	QP
51.96	H	22.73	40	-17.27	QP
95.36	H	20.64	43.5	-22.86	QP
192.63	H	21.69	43.5	-21.81	QP
329.77	H	19.77	46	-26.23	QP
464.55	H	26.55	46	-19.45	QP
550.98	H	26.58	46	-19.42	QP

- Note:**
- (1) All Readings are Peak Value.
  - (2) Emission Level= Reading Level+Probe Factor +Cable Loss.
  - (3) The average measurement was not performed when the peak measured data under the limit of average detection.
  - (4) EUT stood on the table position is the worst case result in the report.

Operation Mode: CH1: 902.75MHz Test Date : April 19, 2014  
 Frequency Range: 1-10GHz Temperature : 25°C  
 Test Result: PASS Humidity : 55 %  
 Measured Distance: 3m Test By: KL

Freq. (MHz)	Ant.Pol. H/V	Emission Level(dBuV/m)		Limit 3m(dBuV/m)		Margin(dB)	
		PK	AV	PK	AV	PK	AV
1805.75	V	54.37	50.21	74	54	-19.63	-3.79
2708.49	V	50.16	48.33	74	54	-23.84	-5.67
3610.01	V	49.52	47.01	74	54	-24.48	-6.99
--	--	--	--	--	--	--	--
--	--	--	--	--	--	--	--
--	--	--	--	--	--	--	--
1805.73	H	53.21	50.15	74	54	-20.79	-3.85
2708.55	H	51.52	47.88	74	54	-22.48	-6.12
3610.09	H	50.22	47.23	74	54	-23.78	-6.77

**No others harmonics emissions are higher than 20dB below the limits of 47 CFR Part 15.247.**

- Note:**
- (1) All Readings are Peak Value and AV.
  - (2) Emission Level= Reading Level+Probe Factor +Cable Loss.
  - (3) Data of measurement within this frequency range shown “ -- ” in the table above means the reading of emissions are attenuated more than 20dB below the permissible limits or the field strength is too small to be measured.

Operation Mode: CH26: 915.25MHz Test Date : April 19, 2014  
 Frequency Range: 1-10GHz Temperature : 25°C  
 Test Result: PASS Humidity : 55 %  
 Measured Distance: 3m Test By: KL

Freq. (MHz)	Ant.Pol. H/V	Emission Level(dBuV/m)		Limit 3m(dBuV/m)		Margin(dB)	
		PK	AV	PK	AV	PK	AV
1832.75	V	53.78	49.90	74.00	54.00	-20.22	-4.10
2747.91	V	49.31	47.60	74.00	54.00	-24.69	-6.40
3663.25	V	49.84	47.68	74.00	54.00	-24.16	-6.32
	--	--	--	--	--	--	--
	--	--	--	--	--	--	--
	--	--	--	--	--	--	--
1831.89	H	52.76	49.88	74.00	54.00	-21.24	-4.12
2747.35	H	50.84	47.56	74.00	54.00	-23.16	-6.44
3663.41	H	48.99	46.30	74.00	54.00	-25.01	-7.70

**No others harmonics emissions are higher than 20dB below the limits of 47 CFR Part 15.247.**

- Note:**
- (1) All Readings are Peak Value and AV.
  - (2) Emission Level= Reading Level+Probe Factor +Cable Loss.
  - (3) Data of measurement within this frequency range shown “ -- ” in the table above means the reading of emissions are attenuated more than 20dB below the permissible limits or the field strength is too small to be measured.



Operation Mode: CH50: 927.25MHz Test Date : April 19, 2014  
 Frequency Range: 1-10GHz Temperature : 25°C  
 Test Result: PASS Humidity : 55 %  
 Measured Distance: 3m Test By: KL

Freq. (MHz)	Ant.Pol. H/V	Emission Level(dBuV/m)		Limit 3m(dBuV/m)		Margin(dB)	
		PK	AV	PK	AV	PK	AV
1854.45	V	53.46	49.32	74.00	54.00	-20.54	-4.68
2781.39	V	49.11	47.65	74.00	54.00	-24.89	-6.35
3709.22	V	49.89	46.65	74.00	54.00	-24.11	-7.35
--	--	--	--	--	--	--	--
--	--	--	--	--	--	--	--
--	--	--	--	--	--	--	--
1854.68	H	53.67	50.44	74.00	54.00	-20.33	-3.56
2781.33	H	52.39	48.71	74.00	54.00	-21.61	-5.29
3708.19	H	49.41	46.67	74.00	54.00	-24.59	-7.33

**No others harmonics emissions are higher than 20dB below the limits of 47 CFR Part 15.247.**

- Note:**
- (1) All Readings are Peak Value and AV.
  - (2) Emission Level= Reading Level+Probe Factor +Cable Loss.
  - (3) Data of measurement within this frequency range shown “ -- ” in the table above means the reading of emissions are attenuated more than 20dB below the permissible limits or the field strength is too small to be measured.

## 6. Channel Separation test

### 6.1 Measurement Procedure

The EUT was operating in hopping mode or could be controlled its channel. Printed out the test result from the spectrum by hard copy function.

### 6.2 Test SET-UP (Block Diagram of Configuration)



### 6.3 Measurement Equipment Used:

EQUIPMENT TYPE	MFR	MODEL NUMBER	SERIAL NUMBER	LAST CAL.	CAL DUE.
Spectrum Analyzer	Agilent	E4407B	88156318	05/29/2013	05/28/2014

### 6.4 Measurement Results:

The following table is the setting of spectrum analyzer.

EMI Test Receiver	Setting
Attenuation	Auto
RB	100kHz
VB	300kHz
Detector	Peak
Trace	Max hold

Spectrum Detector: PK Test Date : April 20, 2014  
 Test By: Joe Temperature : 25°C  
 Test Result: PASS Humidity : 55 %

Channel number	Channel frequency (MHz)	Separation Read Value (kHz)	Separation Limit 20dB Down BW(kHz)
1	902.75	500.00	>355.306
26	915.25	500.00	>352.252
50	927.25	500.00	>357.786

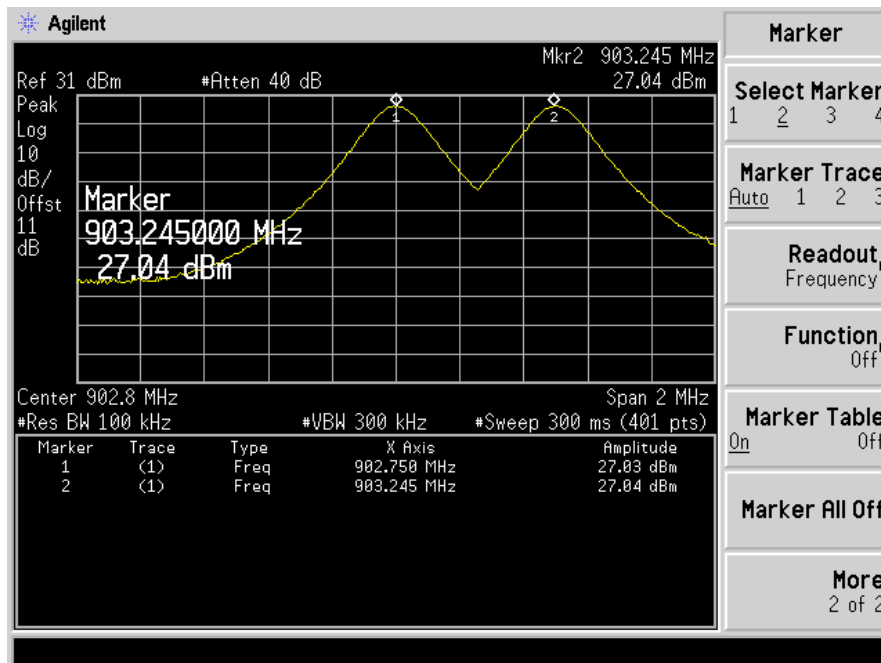

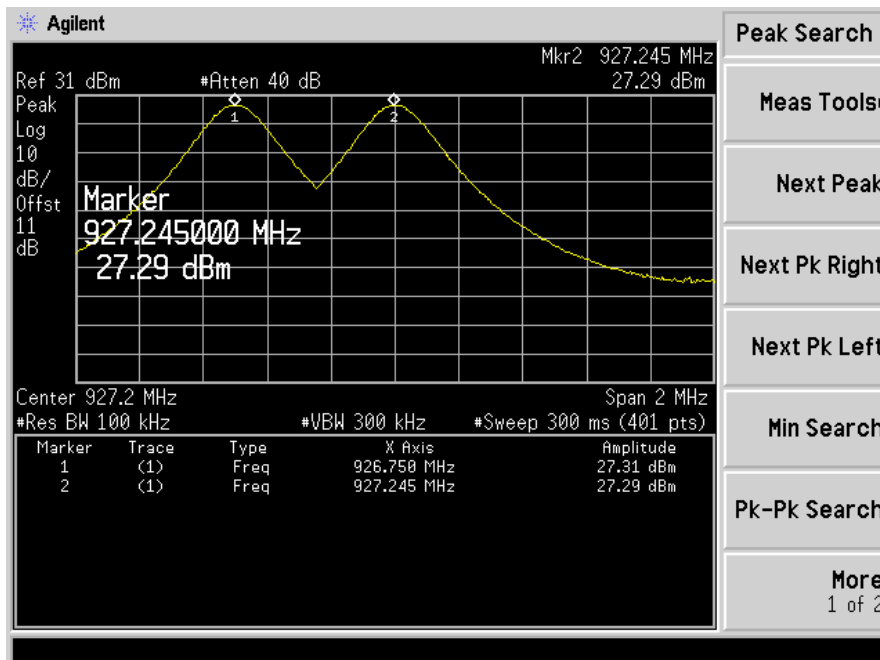
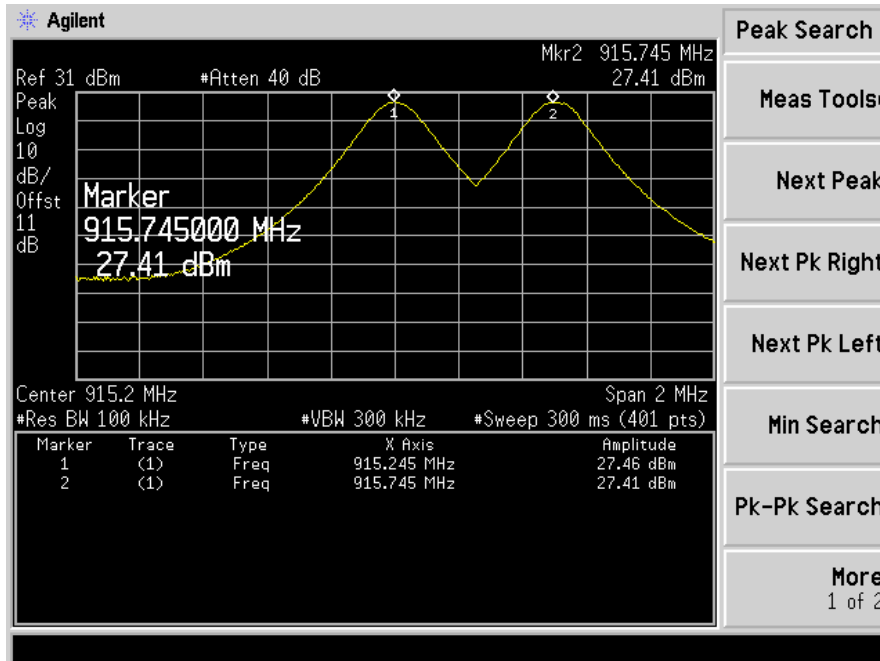

## 7. 20dB Bandwidth test

### 7.1 Measurement Procedure

The EUT was operating in hopping mode or could be controlled its channel. Printed out the test result from the spectrum by hard copy function.

### 7.2 Test SET-UP (Block Diagram of Configuration)

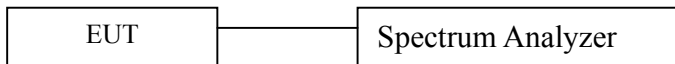

### 7.3 Measurement Equipment Used:

EQUIPMENT TYPE	MFR	MODEL NUMBER	SERIAL NUMBER	LAST CAL.	CAL DUE.
Spectrum Analyzer	Agilent	E4407B	88156318	05/29/2013	05/28/2014

### 7.4 Measurement Results:

The following table is the setting of spectrum analyzer.

EMI Test Receiver	Setting
Attenuation	Auto
Span	3MHz
RB	100kHz
VB	300kHz
Detector	Peak
Trace	Max hold

#### 7.4.1. 20dB Bandwidth test data Chart:

Refer to attached data chart.

Spectrum Detector: PK Test Date : April 20, 2014  
 Test By: Joe Temperature : 25°C  
 Test Result: PASS Humidity : 55 %

Channel number	Channel frequency (MHz)	20dB Down BW(kHz)
1	902.75	355.306
26	915.25	352.252
50	927.25	357.786

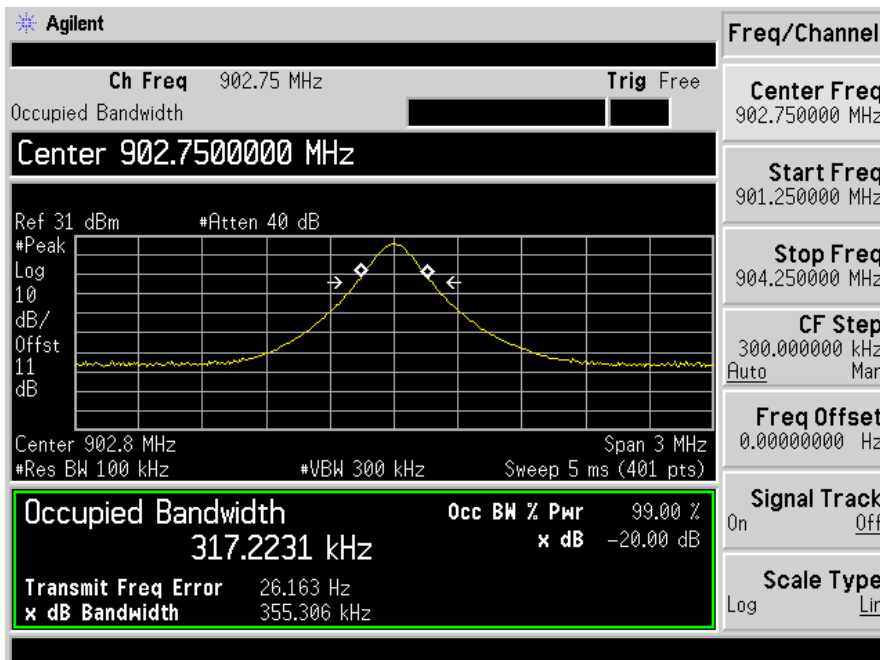

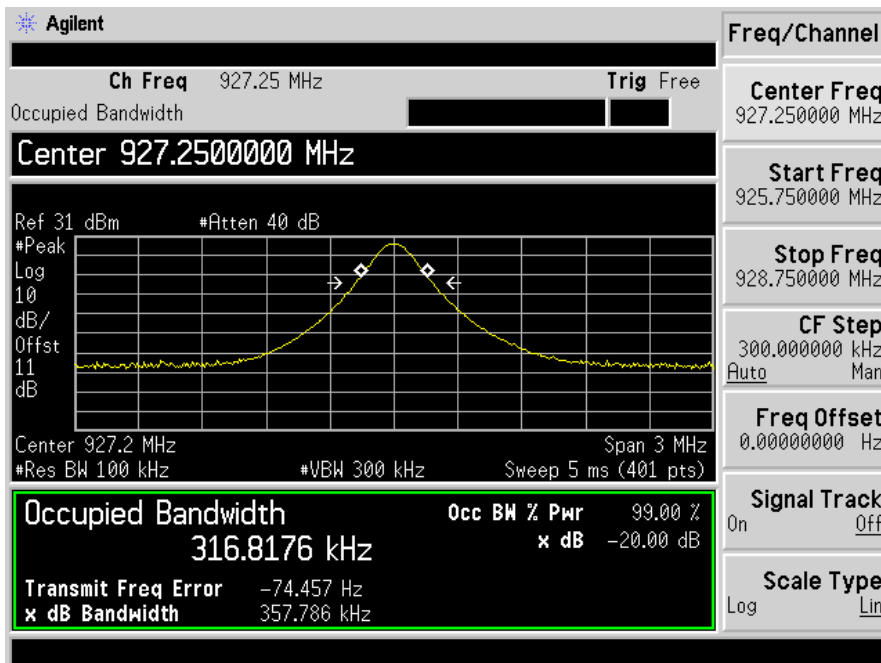
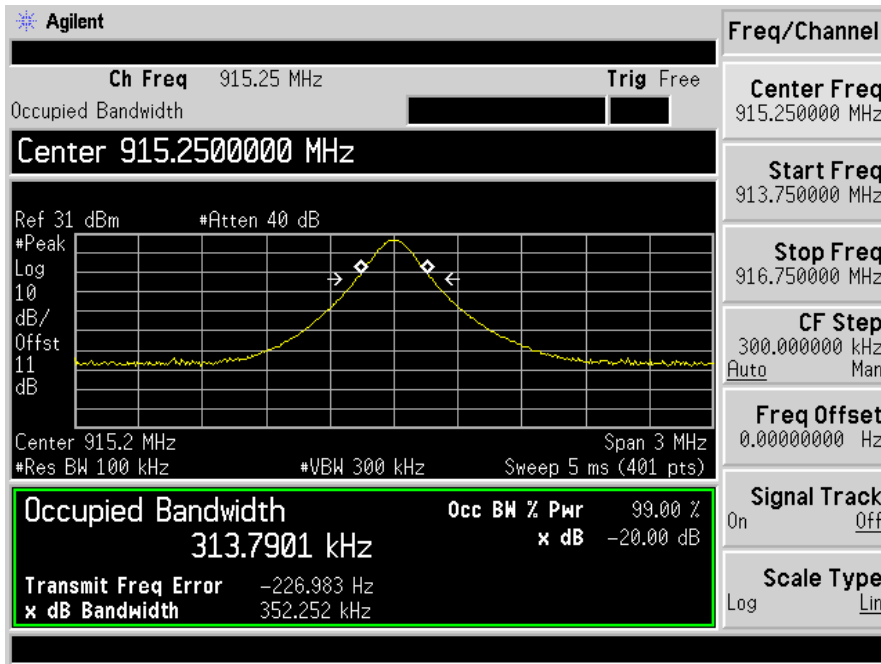

## 8. Quantity of Hopping Channel Test

### 8.1 Measurement Procedure

The EUT was operating in hopping mode or could be controlled its channel. Printed out the test result from the spectrum by hard copy function.

### 8.2 Test SET-UP (Block Diagram of Configuration)



### 8.3 Measurement Equipment Used:

EQUIPMENT TYPE	MFR	MODEL NUMBER	SERIAL NUMBER	LAST CAL.	CAL DUE.
Spectrum Analyzer	Agilent	E4407B	88156318	05/29/2013	05/28/2014

### 8.4 Measurement Results:

Spectrum Detector: PK                      Test Date :                      April 20, 2014  
 Test By: Joe                                      Temperature :                      25°C  
 Test Result: PASS                              Humidity :                              55 %

Hopping Channel Frequency Range	Quantity of Hopping Channel	Quantity of Hopping Channel limit
902.75-927.25	50	> 15



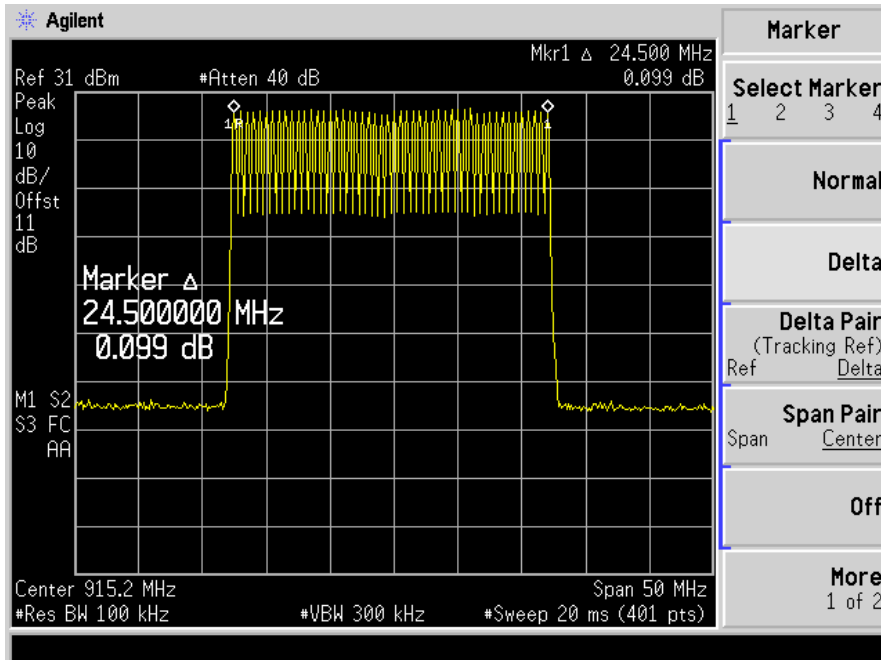

## 9. Time of Occupancy (Dwell Time) test

### 9.1 Measurement Procedure

- a. Check the calibration of the measuring instrument(SA) using either an internal calibrator or a known signal from an external generator.
- b. Turn on the EUT and connect its antenna terminal to measurement via a low loss cable. Then set it to any one measured frequency within its operating range and make sure the instrument is operated in its linear range.
- c. Adjust the center frequency of SA on any frequency be measured and set SA to zero span mode. And then, set RBW and VBW of spectrum analyzer to proper value.
- d. Measure the time duration of one transmission on the measured frequency. And then plot the result with time difference of this time duration.
- e. Repeat above procedures until all different time-slot modes have been completed.

### 9.2 Limit

According to 15.247(a)(1)(i), if the 20 dB bandwidth of the hopping channel is 250 kHz or greater, the system shall use at least 25 hopping frequencies and the average time of occupancy on any frequency shall not be greater than 0.4 seconds within a 10 second period.

### 9.3 Test SET-UP (Block Diagram of Configuration)

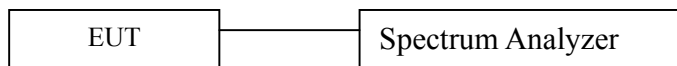

### 9.4 Measurement Equipment Used:

EQUIPMENT TYPE	MFR	MODEL NUMBER	SERIAL NUMBER	LAST CAL.	CAL DUE.
Spectrum Analyzer	Agilent	E4407B	88156318	05/29/2013	05/28/2014

### 9.5 Measurement Results:

Spectrum Detector: PK                      Test Date :                      April 19, 2014  
 Test By: Joe                                      Temperature :                      25°C  
 Test Result: PASS                              Humidity :                              55 %

Mode	Number of transmission in a 10s	Length of transmissions time(msec)	Result (msec)	Limit (msec)
TX	3	23.5	70.5	400

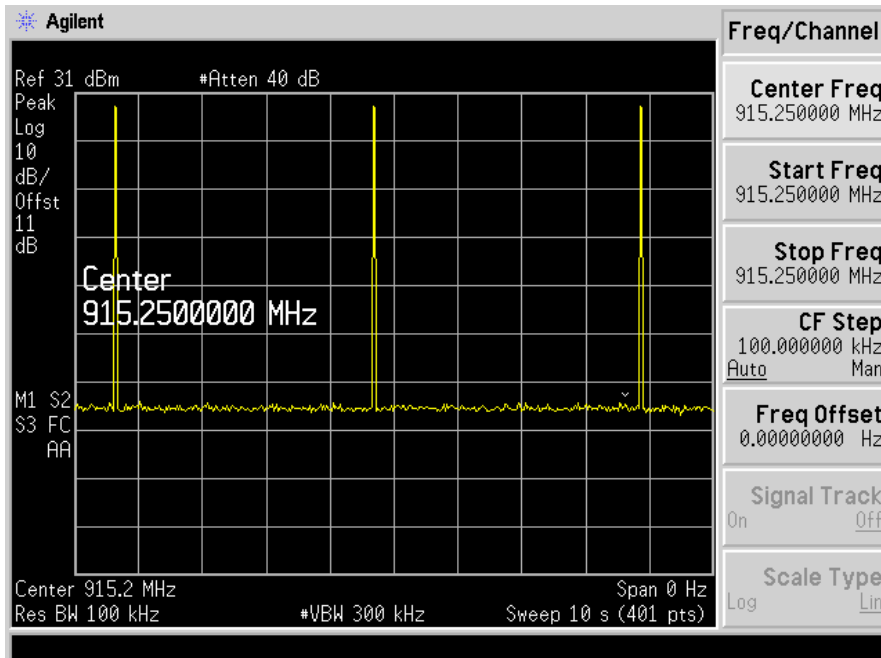
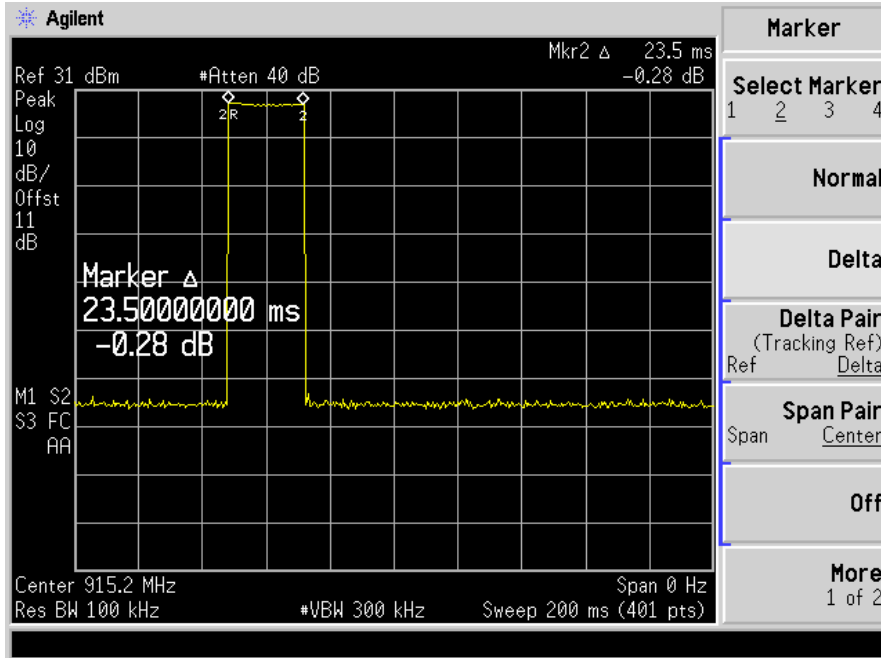

## 10. MAXIMUM PEAK OUTPUT POWER TEST

### 10.1 Measurement Procedure

- Check the calibration of the measuring instrument(Power meter) using either an internal calibrator or a known signal from an external generator.
- Turn on the EUT and connect it to measurement instrument. Then set it to any one convenient frequency within its operating range. Set a reference level on the measuring instrument equal to the highest peak value.
- The center frequency of the spectrum analyzer is set to the fundamental frequency and using proper RBW and VBW setting.
- Measure the captured power within the band and recording the plot.
- Repeat above procedures until all frequencies required were complete.

### 10.2 Test SET-UP (Block Diagram of Configuration)

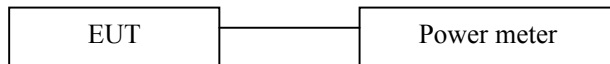

### 10.3 Measurement Equipment Used:

EQUIPMENT TYPE	MFR	MODEL NUMBER	SERIAL NUMBER	LAST CAL.	CAL DUE.
Power meter	Boonton	4232A	29001	05/29/2013	05/28/2014
Power sensor	Boonton	51011-EMC	31184	05/29/2013	05/28/2014

### 10.4 Measurement Results:

Spectrum Detector: PK                      Test Date : April 19, 2014  
 Test By: Joe                                      Temperature : 25°C  
 Test Result: PASS                              Humidity : 55 %

Channel number	Channel Frequency (MHz)	Peak Power output(dBm)	Peak Power Limit(mW)	Pass/Fail
1	902.75	27.27	1000mW	PASS
26	915.25	27.34	1000mW	PASS
50	927.25	27.13	1000mW	PASS

## 11. Band EDGE test

### 11.1 Measurement Procedure

1. The EUT was Operating in hopping mode or could be controlled its channel. Printed out test result from the spectrum by hard copy function.
2. The EUT was placed on a turn table which is 0.8m above ground plane.
3. Maximum procedure was performed on the six highest emissions to ensure EUT compliance.
4. And also, each emission was to be maximized by changing the polarization of receiving antenna both horizontal and vertical.
5. Repeat above procedures until all frequency measured were complete.

### 11.2 Test SET-UP (Block Diagram of Configuration)

As 5.2 Test set up (B) and (C)

### 11.3 Measurement Equipment Used:

Same as 5.3 Radiated Emission Measurement.

### 11.4 Measurement Results:

Spectrum Detector:	PK/AV	Test Date :	April 19, 2014
Test By:	Joe	Temperature :	25°C
Test channel:	1	Humidity :	55 %

Frequency (MHz)	Polarity	Level (dBuV/m)		Limited (dBuV/m)	
		PK	AV	PK	AV
902	H	46.73	35.84	74	54
902	V	46.95	35.93	74	54

Spectrum Detector:	PK/AV	Test Date :	April 19, 2014
Test By:	Joe	Temperature :	25°C
Test channel:	50	Humidity :	55 %

Frequency (MHz)	Polarity	Level (dBuV/m)		Limited (dBuV/m)	
		PK	AV	PK	AV
928	H	45.53	35.01	74	54
928	V	45.73	34.87	74	54

Spectrum Detector: PK/AV                      Test Date :                      April 19, 2014  
 Test By: Joe                                      Temperature :                      25°C  
 Mode: Hopping mode                      Humidity :                      55 %

Frequency (MHz)	Polarity	Level (dBuV/m)		Limited (dBuV/m)	
		PK	AV	PK	AV
902	H	46.37	35.30	74	54
902	V	45.68	34.45	74	54
928	H	45.69	34.62	74	54
928	V	45.56	34.33	74	54

## 12. Antenna Port Emission

### 12.1 Test Equipment

EQUIPMENT TYPE	MFR	MODEL NUMBER	SERIAL NUMBER	LAST CAL.	CAL DUE.
Spectrum Analyzer	Agilent	E4407B	88156318	05/29/2013	05/28/2014

### 12.2 Measuring Instruments and setting

The following table is the setting of spectrum analyzer.

EMI Test Receiver	Setting
Attenuation	Auto
RB	100kHz
VB	300kHz
Detector	Peak
Trace	Max hold

### 12.3 Test Procedures

The conducted spurious emissions were measured conducted using a spectrum analyzer at low, mid, and hi channels, the limit was determined by attenuation 20dB of the RF peak power output.

### 12.4 Block Diagram of Test setup

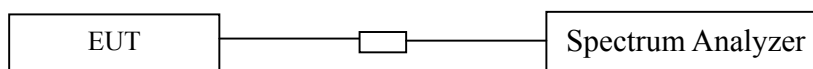

### 12.5 Test Result

PASS.

TX 902.75MHz

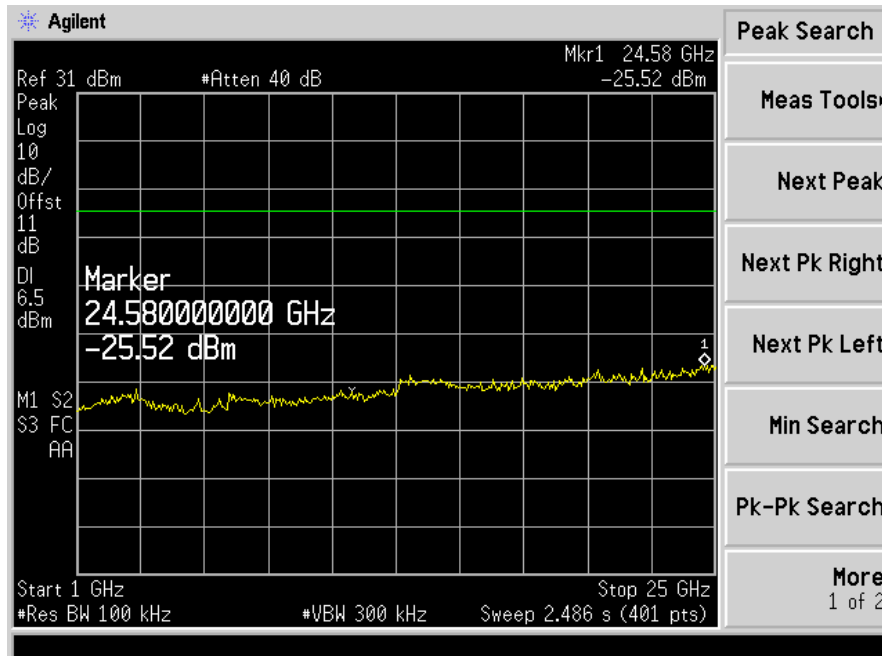
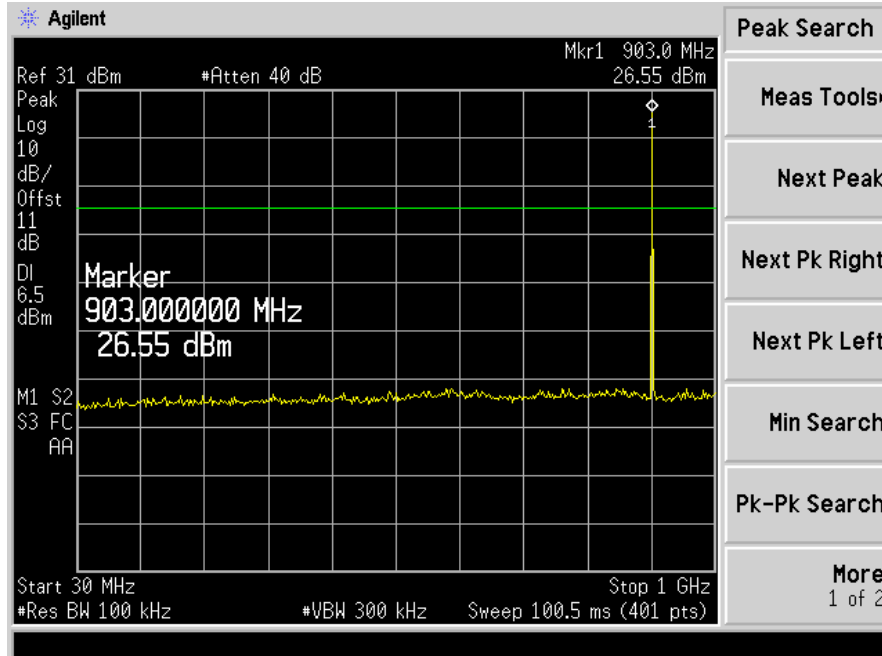



TX 915.25MHz

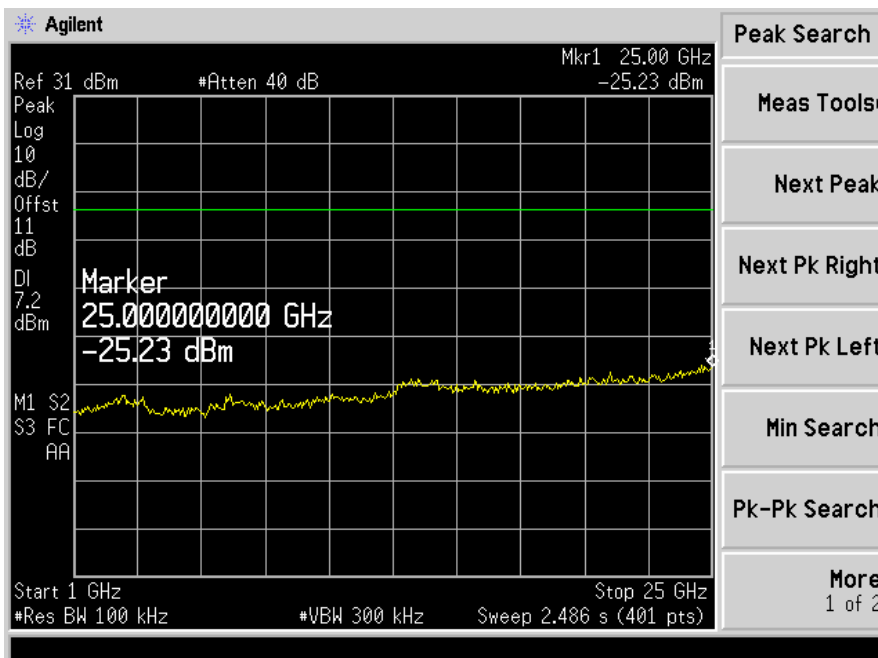
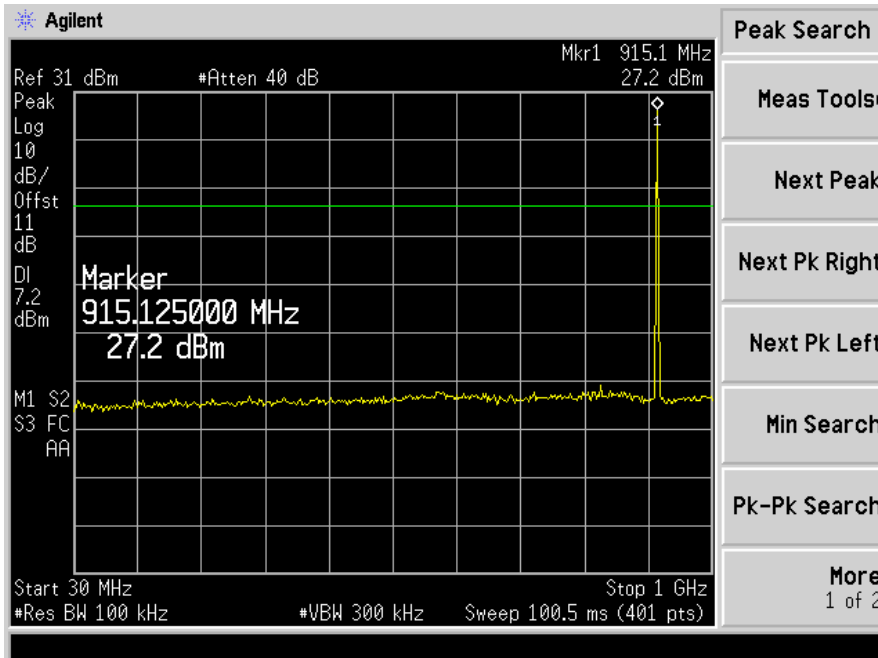

TX 927.25MHz

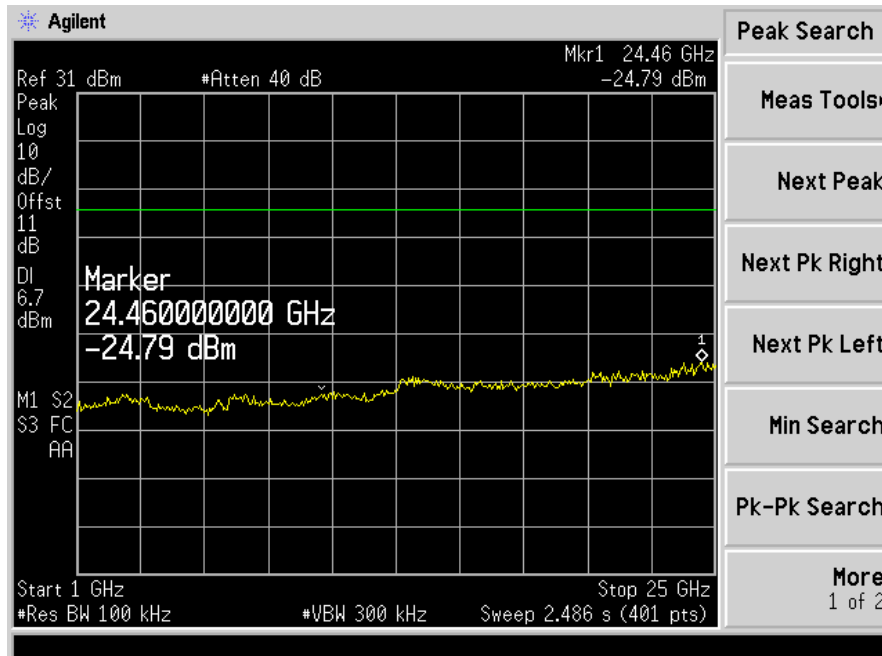
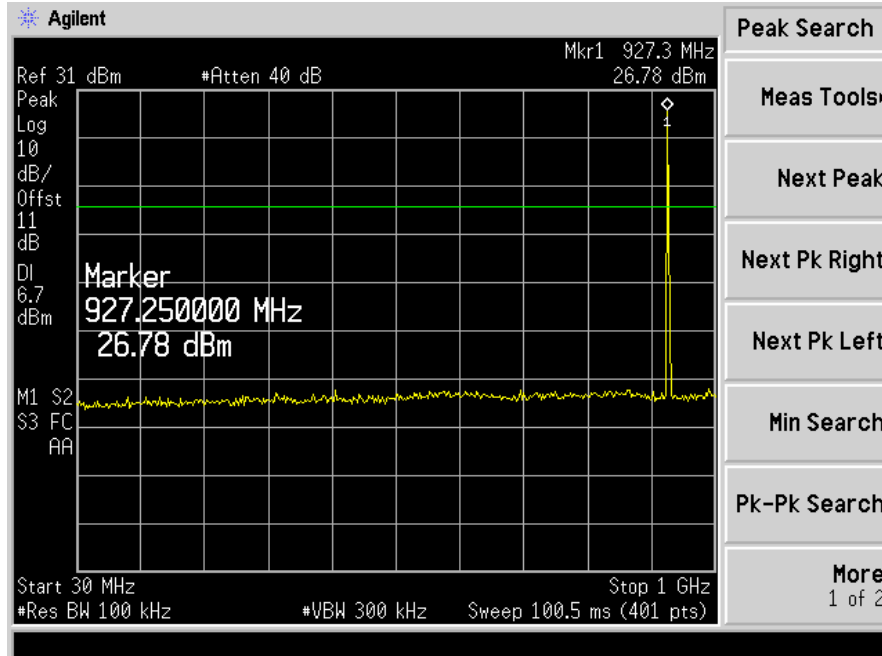

## **13. Antenna Application**

### **13.1 Antenna requirement**

For intentional device, according to FCC 47 CFR Section 15.203, an intentional radiator shall be designed to ensure that no antenna other than that furnished by the responsible party shall be used with the device. And according to FCC 47 CFR Section 15.247 (b) (4) , if transmitting antennas of directional gain greater than 6dBi are used, the power shall be reduced by the amount in dB that the directional gain of the antenna exceeds 6dBi. (4) The conducted output power limit specified in paragraph (b) of this section is based on the use of antennas with directional gains that do not exceed 6 dBi. Except as shown in paragraph (c) of this section, if transmitting antennas of directional gain greater than 6 dBi are used, the conducted output power from the intentional radiator shall be reduced below the stated values in paragraphs (b)(1), (b)(2), and (b)(3) of this section, as appropriate, by the amount in dB that the directional gain of the antenna exceeds 6 dBi.

### **13.2 Result**

The EUT's antenna is External antenna, and its gain is 7.5dBi and meets the requirement.