

**ELECTROMAGNETIC EMISSIONS COMPLIANCE REPORT
INTENTIONAL RADIATOR CERTIFICATION TO
FCC PART 15 SUBPART C REQUIREMENT**

OF

Reader

MODEL No.: XC-RF807

Brand Name: Invengo

FCC ID: TQ4XC-RF807

REPORT NO: ES120229145F

ISSUE DATE: April 23, 2012

Prepared for

**Invengo Information Technology Co., Ltd.
3/F, No.T2-B, High-tech industrial Park South, Shenzhen 518057, China**

Prepared by

SHENZHEN EMTEK CO., LTD

**Bldg 69, Majialong Industry Zone, Nanshan District,
Shenzhen, Guangdong, China**

TEL : 86-755-26954280

FAX: 86-755-26954282

VERIFICATION OF COMPLIANCE

Applicant:	Invengo Information Technology Co., Ltd. 3/F, No.T2-B, High-tech industrial Park South, Shenzhen 518057,China
Manufacturer:	Invengo Information Technology Co., Ltd. 3/F, No.T2-B, High-tech industrial Park South, Shenzhen 518057,China
Product Description:	Reader
Model Number:	XC-RF807
Serial Number:	N/A
File Number:	ES120229145F
Date of Test:	March 17, 2012 to April 20, 2012

We hereby certify that:

The above equipment was tested by SHENZHEN EMTEK CO., LTD. The test data, data evaluation, test procedures, and equipment configurations shown in this report were made in accordance with the procedures given in ANSI C63.4 (2009) and the energy emitted by the sample EUT tested as described in this report is in compliance with conducted and radiated emission limits of FCC Rules Part 15.247.

The test results of this report relate only to the tested sample identified in this report.

Date of Test : March 17, 2012 to April 20, 2012

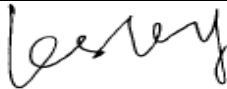
Prepared by : 
(Engineer, Moira)

Reviewer : 
(Manager, Violet)

Approve & Authorized Signer : 
(Quality Manager, David lee)

Table of Contents

1.	GENERAL INFORMATION.....	5
1.1	PRODUCT DESCRIPTION.....	5
1.2	RELATED SUBMITTAL(S) / GRANT (S)	5
1.3	TEST METHODOLOGY.....	5
1.4	SPECIAL ACCESSORIES	5
1.5	EQUIPMENT MODIFICATIONS	5
1.6	TEST FACILITY	6
2.	SYSTEM TEST CONFIGURATION	7
2.1	EUT CONFIGURATION.....	7
2.2	EUT EXERCISE	7
2.3	TEST PROCEDURE.....	7
2.4	LIMITATION	7
2.5	CONFIGURATION OF TESTED SYSTEM	11
2.6	EQUIPMENT USED IN TESTED SYSTEM.....	11
2.7	DESCRIPTION OF TEST MODES	12
3.	SUMMARY OF TEST RESULTS	13
4.	CONDUCTED EMISSIONS TEST	14
4.1	MEASUREMENT PROCEDURE:.....	14
4.2	TEST SET-UP (BLOCK DIAGRAM OF CONFIGURATION)	14
4.3	MEASUREMENT EQUIPMENT USED:	14
4.4	CONDUCTED EMISSION LIMIT.....	14
4.5	MEASUREMENT RESULT:.....	15
4.6	CONDUCTED MEASUREMENT PHOTOS:.....	16
5.	RADIATED EMISSION TEST	17
5.1	MEASUREMENT PROCEDURE.....	17
5.2	TEST SET-UP (BLOCK DIAGRAM OF CONFIGURATION)	18
5.3	MEASUREMENT EQUIPMENT USED:	19
5.4	MEASUREMENT RESULT.....	20
5.5	RADIATED MEASUREMENT PHOTOS:.....	24
6.	CHANNEL SEPARATION TEST	25
6.1	MEASUREMENT PROCEDURE.....	25
6.2	TEST SET-UP (BLOCK DIAGRAM OF CONFIGURATION)	25
6.3	MEASUREMENT EQUIPMENT USED:	25
6.4	MEASUREMENT RESULTS:.....	25
7.	BANDWIDTH TEST	28
7.1	MEASUREMENT PROCEDURE.....	28
7.2	TEST SET-UP (BLOCK DIAGRAM OF CONFIGURATION)	28

7.3	MEASUREMENT EQUIPMENT USED:	28
7.4	MEASUREMENT RESULTS:.....	28
8.	QUANTITY OF HOPPING CHANNEL TEST.....	31
8.1	MEASUREMENT PROCEDURE.....	31
8.2	TEST SET-UP (BLOCK DIAGRAM OF CONFIGURATION)	31
8.3	MEASUREMENT EQUIPMENT USED:	31
8.4	MEASUREMENT RESULTS:.....	31
9.	TIME OF OCCUPANCY (DWELL TIME) TEST	33
9.2	TEST SET-UP (BLOCK DIAGRAM OF CONFIGURATION)	33
9.3	MEASUREMENT EQUIPMENT USED:	33
9.4	MEASUREMENT RESULTS:.....	33
10.	MAXIMUM PEAK OUTPUT POWER TEST	35
10.1	MEASUREMENT PROCEDURE.....	35
10.2	TEST SET-UP (BLOCK DIAGRAM OF CONFIGURATION)	35
10.3	MEASUREMENT EQUIPMENT USED:	35
10.4	MEASUREMENT RESULTS:.....	35
11.	BAND EDGE TEST.....	36
11.1	MEASUREMENT PROCEDURE.....	36
11.2	TEST SET-UP (BLOCK DIAGRAM OF CONFIGURATION)	36
11.3	MEASUREMENT EQUIPMENT USED:	36
11.4	MEASUREMENT RESULTS:.....	36
11.	ANTENNA PORT EMISSION.....	37
12.1	TEST EQUIPMENT	37
12.2	MEASURING INSTRUMENTS AND SETTING	37
12.3	TEST PROCEDURES	37
12.4	BLOCK DIAGRAM OF TEST SETUP	37
12.5	TEST RESULT.....	37

1. GENERAL INFORMATION

1.1 Product Description

The Invengo Information Technology Co., Ltd.

Model: XC-RF807(referred to as the EUT in this report) The EUT is an short range, lower power, Reader designed as an Device. It is designed by way of utilizing the PR-ASK, DSB-ASK modulation achieves the system operating.

A major technical descriptions of EUT is described as following:

- A). Operation Frequency: 902-928 MHz
- B). Modulation: ASK
- C). Number of Channel: 50
- D). Channel space: 0.5MHz
- E). RF Output Power: 27.08 dBm
- F). Antenna GAIN: 7.15dBi
- G). Rating:100-240V~ 50/60Hz 2.5A

1.2 Related Submittal(s) / Grant (s)

This submittal(s) (test report) is intended for FCC ID: TQ4XC-RF807 filing to comply with Section 15.247 of the FCC Part 15 Subpart C Rules.

1.3 Test Methodology

Both conducted and radiated testing were performed according to the procedures in ANSI C63.4 (2009) and FCC Public Notice DA 00-705. Radiated testing was performed at an antenna to EUT distance 3 meters.

1.4 Special Accessories

Not available for this EUT intended for grant.

1.5 Equipment Modifications

Not available for this EUT intended for grant.

1.6 Test Facility

Site Description
EMC Lab. : Accredited by CNAS, 2010.10.29
The certificate is valid until 2013.10.28
The Laboratory has been assessed and proved to be in compliance
with CNAS/CL01:2006(identical to ISO/IEC17025: 2005)
The Certificate Registration Number is L2291

Accredited by TUV Rheinland Shenzhen 2010.5.25
The Laboratory has been assessed according to the requirements
ISO/IEC 17025

Accredited by FCC, October 28, 2010
The Certificate Registration Number is 406365.

Accredited by Industry Canada, March 5, 2010
The Certificate Registration Number is 46405-4480.

Name of Firm : SHENZHEN EMTEK CO., LTD
Site Location : Bldg 69, Majialong Industry Zone,
Nanshan District, Shenzhen, Guangdong, China

2. System Test Configuration

2.1 EUT Configuration

The EUT configuration for testing is installed on RF field strength measurement to meet the Commissions requirement and operating in a manner which intends to maximize its emission characteristics in a continuous normal application.

2.2 EUT Exercise

The Transmitter was operated in the normal operating mode. The Tx frequency was fixed which was for the purpose of the measurements.

2.3 Test Procedure

2.3.1 Conducted Emissions

The EUT is a placed on as turn table which is 0.8 m above ground plane. According to the requirements in Section 13.1.4.1 of ANSI C63.4-2009 Conducted emissions from the EUT measured in the **frequency range between 0.15 MHz and 30MHz** using **CISPR Quasi-Peak and average detector mode**.

2.3.2 Radiated Emissions

The EUT is a placed on as turn table which is 0.8 m above ground plane. The turn table shall rotate 360 degrees to determine the position of maximum emission level. EUT is set 3m away from the receiving antenna which varied from 1m to 4m to find out the highest emission. And also, each emission was to be maximized by changing the polarization of receiving antenna both horizontal and vertical. In order to find out the max. emission, the relative positions of this hand-held transmitter(EUT) was rotated through three orthogonal axes according to the requirements in Section 13.1.4.1 of ANSI C63.4-2009.

2.4 Limitation

(1) Channel Separation test

FCC Part 15, Subpart C Section 15.247(a)(1) Frequency hopping systems shall have hopping channel carrier frequencies separated by a minimum of 25kHz or the 20 Bandwidth of the hopping channel, whichever is greater.

Frequency Range (MHz)	Limit(kHz)
902-928	>25kHz
2400-2483.5	>25kHz
5725-5850	>25kHz

(2) **20dB Bandwidth**

Frequency Range(MHz)	Quantity of Hopping Channel	Limit(kHz)			
		50	25	15	75
902-928		<250	>250	NA	NA
2400-2483.5		NA	NA	>1000	<1000

(3) **Quantity of Hopping Channel**

FCC Part 15, Subpart C Section 15.247

Frequency Range (MHz)	Limit(Quantity of Hopping Channel)			
	20dB bandwidth <250kHz	20dB bandwidth >250kHz	20dB bandwidth <1MHz	20dB bandwidth >1MHz
902-928	50	25	NA	NA
2400-2483.5	NA	NA	75	15
5725-5850	NA	NA	75	NA

(4) **Time of Occupancy(Dwell Time)**

FCC Part 15, Subpart C Section 15.247

Frequency Range (MHz)	LIMIT(rms)		
	20dB bandwidth <250kHz(50Channel)	20dB bandwidth >250kHz(25Channel)	20dB bandwidth <1MHz(75Channel)
902-928	400(20S)	400(10S)	NA
2400-2483.5	NA	NA	400(30S)
5725-5850	NA	NA	400(30S)

Note: The “()” is all channel’s average time of occupancy.

(5) **Maximum Peak Output Power**

FCC Part 15, Subpart C Section 15.247

Frequency Range (MHz)	Quantity of Hopping Channel	LIMIT(W)			
		50	25	15	75
902-928		1(30dBm)	0.125(21dBm)	NA	NA
2400-2483.5		NA	NA	0.125(21dBm)	1(30dBm)
5725-5850		NA	NA	NA	1(30dBm)

(6) Band edge

FCC Part15, Subpart C Section 15.247, In any 100kHz bandwidth outside the frequency band in with the spread spectrum intentional radiator is operating, the radio frequency power that is produced by the intentional radiator shall be at least 20dB below that in the 100kHz bandwidth within the band that contains the highest level of the desired power, based on either an RF conducted or a radiated measurement, attenuation below the general limits specified in section 15.209(a) is not required. In addition, radiated emissions which fall in the restricted bands, as defined in section 15.205(a), must also comply with the radiated emission limits specified in section 15.209(a).

Operating Frequency Range(MHz)	Spurious emission frequency	Limit Peak power ration to emission(dBc)	Limit Emission level(dBuV/m)
902-928	<902	>20	NA
	>928	>20	NA
	960-1240	NA	54
2400-2483.5	<2400	>20	NA
	>2483.5-2500	NA	54
5725-5850	<5350-5460	NA	54
	<5725	>20	NA
	>5850	>20	NA

(7) Conducted Emission

Frequency(MHz)	Quasi-peak	Average
0.15-0.5	66-56	56-46
0.5-5.0	56	46
5.0-30.0	60	50

Note:

1. The lower limit shall apply at the transition frequencies
2. The limit decreases in line with the logarithm of the frequency in the range of 0.15 to 0.50MHz.

(8) Radiated Emission

FCC Part 15, Subpart C Section 15.209 limit of radiated emission for frequency below 1000GHz. The emissions from an intentional radiator shall not exceed the field strength level specified in the following table:

Frequency (MHz)	Field strength $\mu\text{V/m}$	Distance(m)	Field strength at 3m $\text{dB}\mu\text{V/m}$
0.009~0.490	2400/F(KHz)	300	See the remark
0.490~1.705	2400/F(KHz)	30	
1.705~30.0	30	30	
30-88	100	3	40
88-216	150	3	43.5
216-960	200	3	46
Above 960	500	3	54

- Remark:
1. Emission level in $\text{dB}\mu\text{V/m}=20 \log (\text{uV/m})$
 2. Measurement was performed at an antenna to the closed point of EUT distance of meters.
 3. Distance extrapolation factor $=40\log(\text{Specific distance/ test distance})(\text{dB})$;
Limit line=Specific limits($\text{dB}\mu\text{V}$) + distance extrapolation factor.

2.5 Configuration of Tested System

Fig. 2-1 Configuration of Tested System

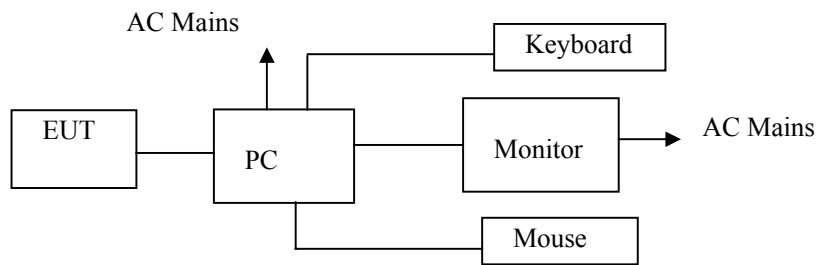

2.6 Equipment Used in Tested System

PC	:	Manufacturer: LENOVO M/N: 9702 S/N: L3C4410 CE, FCC: DOC Power cord : Unshielded, Detachabled, 1.5m
LCD Monitor	:	Manufacturer: LENOVO M/N: 9227-AE6 S/N:4M0293084302824 CE, FCC: DOC Power cord : Unshielded, Detachabled, 1.5m Data Cable: Unshielded, Undetachabled, 2.0m
Keyboard	:	Manufacturer: LENOVO M/N: KU-0225 S/N:0585494 CE, FCC: DOC Data Cable: Unshielded, Undetachabled, 2.0m
Mouse	:	Manufacturer: LENOVO M/N: MO28UOL S/N:44G7862 068 CE, FCC: DOC Data Cable: Unshielded, Undetachabled, 2.0m

Note:

- (1) Unless otherwise denoted as EUT in 『Remark』 column , device(s) used in tested system is a support equipment.

2.7 Description of test modes

The EUT (Reader) has been tested under normal operating condition.

This EUT is a FHSS system. Pre-scanned tests, X, Y, Z in the three orthogonal panels, were conducted to determine the final configuration from all possible combinations. We use blue test to control the EUT, Let EUT hopping on and transmit with highest power. 50 Channels are provided by EUT. The 3 channels of lower, medium and higher were chosen for test.

Channel	Frequency(MHz)
The Low Channel	902.75
The Middle Channel	915.25
The high Channel	927.25

3. Summary of Test Results

FCC Rule	Description Of Test	Result
15.247(a)(1)	Channel Separation test	Compliant
15.247(a)(1)	20dB Bandwidth	Compliant
15.247(a)(1)	Quantity of Hopping Channel	Compliant
15.247(a)(1)	Time of Occupancy (Dwell Time)	Compliant
15.247(b)(1)	Max Peak output Power test	Compliant
15.247(d)	Band edge test	Compliant
15.207	AC Power Conducted Emission	Compliant
15.247(d)	Radiated Emission	Compliant
§15.247(d)	Antenna Port Emission	Compliant
15.203&15.247(b)	Antenna Application	Compliant

4. Conducted Emissions Test

4.1 Measurement Procedure:

1. The EUT was placed on a table which is 0.8m above ground plane.
2. Maximum procedure was performed on the six highest emissions to ensure EUT compliance.
3. Repeat above procedures until all frequency measured were complete.

4.2 Test SET-UP (Block Diagram of Configuration)

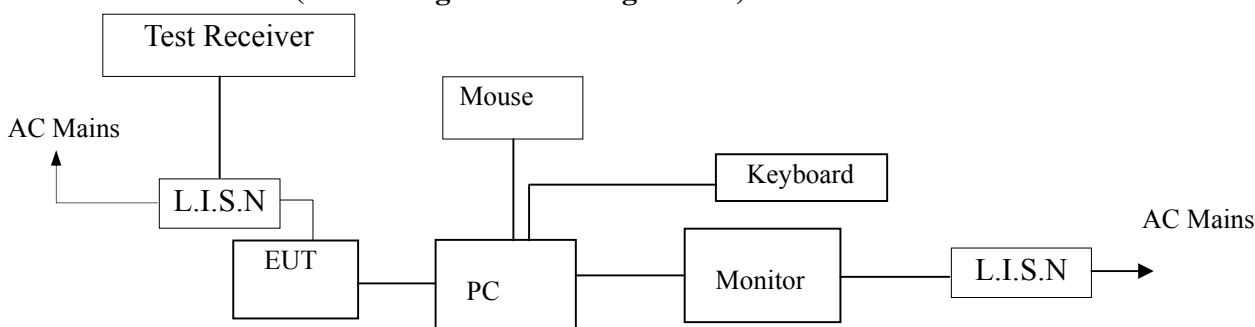

4.3 Measurement Equipment Used:

Conducted Emission Test Site # 4					
EQUIPMENT TYPE	MFR	MODEL NUMBER	SERIAL NUMBER	LAST CAL.	CAL DUE.
Test Receiver	Rohde & Schwarz	ESCS30	828985/018	05/29/2011	05/29/2012
L.I.S.N	Rohde & Schwarz	ESH2-Z5	834549/005	05/29/2011	05/29/2012
50ΩCoaxial Switch	Anritsu	MP59B	M20531	05/29/2011	05/29/2012

4.4 Conducted Emission Limit

(7) Conducted Emission

Frequency(MHz)	Quasi-peak	Average
0.15-0.5	66-56	56-46
0.5-5.0	56	46
5.0-30.0	60	50

Note:

1. The lower limit shall apply at the transition frequencies
2. The limit decreases in line with the logarithm of the frequency in the range of 0.15 to 0.50MHz.

4.5 Measurement Result:

Date of Test: 04/05/2012 Temperature: 22°C
 Frequency Detector: 0.15~30MHz Humidity: 50%
 Test Result: PASS Test Mode: Scan tag

Test Line	Frequency MHz	Emission Level QP dB(μV)	Emission Level AV dB(μV)	Limits QP dB(μV)	Limits AV dB(μV)	Margin QP dB(μV)	Margin AV dB(μV)
Line	0.19	50.44	37.93	64.04	54.04	-13.60	-16.11
	0.26	43.78	30.49	61.59	51.59	-17.81	-21.10
	0.38	36.14	35.58	58.28	48.28	-22.14	-12.70
	0.45	35.58	32.20	56.97	46.97	-21.39	-14.77
	13.53	40.91	35.57	60.00	50.00	-19.09	-14.43
	24.40	34.16	32.27	60.00	50.00	-25.84	-17.73
Neutral	0.19	51.59	38.54	64.04	54.04	-12.45	-15.50
	0.26	44.44	30.14	61.59	51.59	-17.15	-21.45
	0.32	39.70	36.22	59.71	49.71	-20.01	-13.49
	0.38	36.22	28.12	58.28	48.28	-22.06	-20.16
	0.45	35.27	32.74	56.97	46.97	-21.70	-14.23
	24.40	39.96	38.99	60.00	50.00	-20.04	-11.01

4.6 Conducted Measurement Photos:



5. Radiated Emission Test

5.1 Measurement Procedure

1. The EUT was placed on a turn table which is 0.8m above ground plane.
2. Maximum procedure was performed on the six highest emissions to ensure EUT compliance.
3. And also, each emission was to be maximized by changing the polarization of receiving antenna both horizontal and vertical.
4. Repeat above procedures until all frequency measured was complete.

When spectrum scanned from 30 MHz to 1GHz setting resolution bandwidth 100 kHz and video bandwidth 300kHz. And spectrum scanned above 1GHz setting resolution bandwidth 1MHz, video bandwidth 10Hz.

5.2 Test SET-UP (Block Diagram of Configuration)

(A) Radiated Emission Test Set-Up, Frequency Below 30MHz

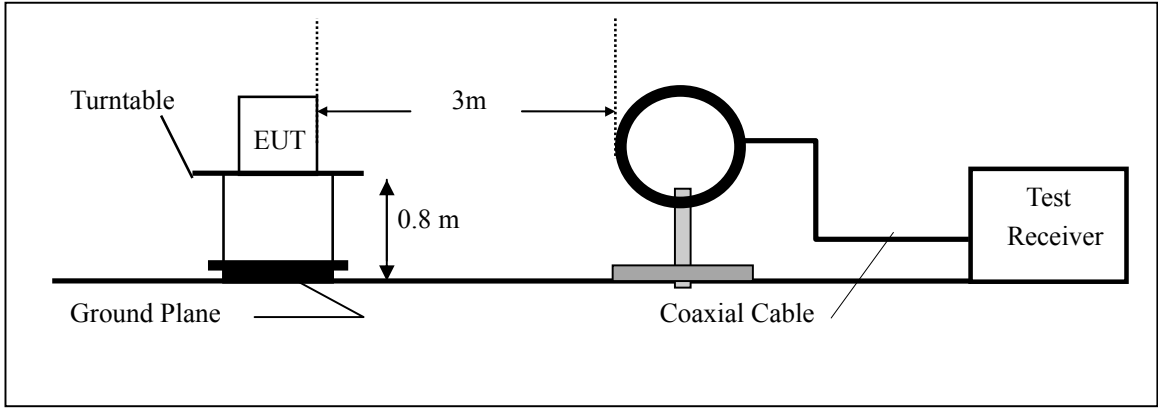

(B) Radiated Emission Test Set-Up, Frequency Below 1000MHz

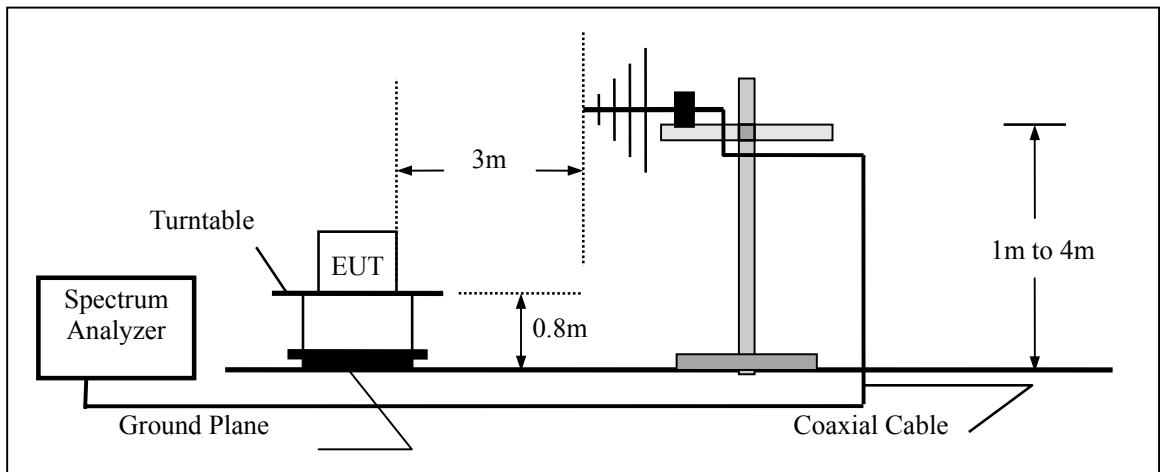

(C) Radiated Emission Test Set-Up, Frequency above 1000MHz

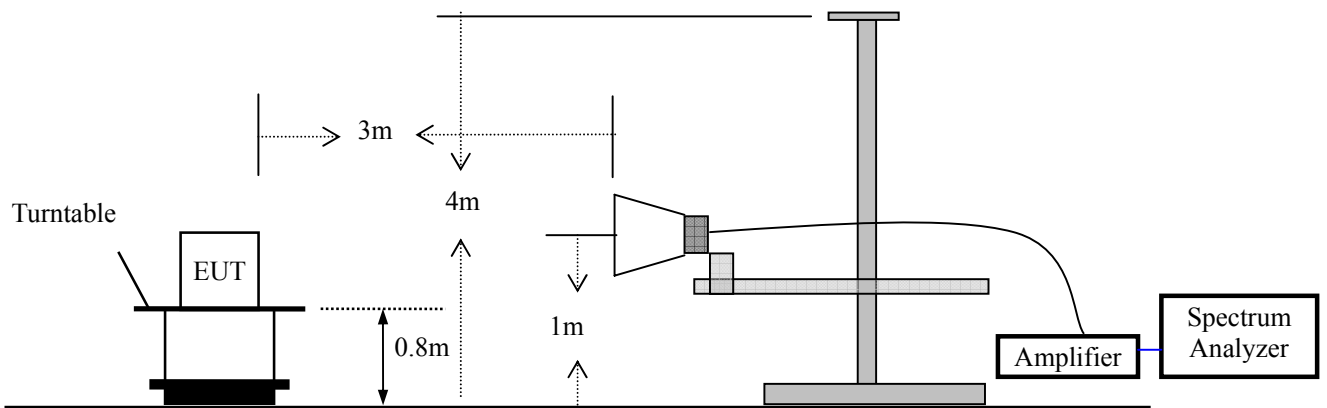

5.3 Measurement Equipment Used:

EQUIPMENT TYPE	MFR	MODEL NUMBER	SERIAL NUMBER	LAST CAL.	CAL DUE.
Spectrum Analyzer	Rohde & Schwarz	FSP7	839511/010	05/29/2011	05/29/2012
Spectrum Analyzer	HP	E4407B	839840481	05/29/2011	05/29/2012
EMI Test Receiver	Rohde & Schwarz	ESCS30	828985/018	05/29/2011	05/29/2012
Pre-Amplifier	HP	8447D	2944A07999	05/29/2011	05/29/2012
Bilog Antenna	Schwarzbeck	VULB9163	142	05/29/2011	05/29/2012
Loop Antenna	ARA	PLA-1030/B	1029	05/29/2011	05/29/2012
Horn Antenna	Schwarzbeck	BBHA 9170	BBHA9170399	05/29/2011	05/29/2012
Horn Antenna	Schwarzbeck	BBHA 9120	D143	05/29/2011	05/29/2012

5.4 Measurement Result

All the modes were tested and the data of the worst mode are recorded in the following pages.

Operation Mode: Scan tag Test Date : 04/05/2012
 Frequency Range: 9KHz~30MHz Temperature : 28°C
 Test Result: PASS Humidity : 65 %
 Measured Distance: 3m Test By: WOLF

Freq. (MHz)	Ant.Pol. H/V	Emission Level (dBuV/m)	Limit 3m (dBuV/m)	Over (dB)
--	--	--	--	--

Note: the amplitude of spurious emission that is attenuated by more than 20dB below the permissible limit has no need to be reported.

Operation Mode: 902.75MHz Test Date : 04/05/2012
 Frequency Range: 30~1000MHz Temperature : 28 °C
 Test Result: PASS Humidity : 65 %
 Measured Distance: 3m Test By: KL

Freq. (MHz)	Ant.Pol. H/V	Emission Level (dBuV/m)	Limit 3m (dBuV/m)	Margin (dB)	Note
31.55	V	25.47	40.00	-14.53	QP
149.70	V	26.90	43.50	-16.60	QP
249.18	V	29.84	46.00	-16.16	QP
625.37	V	31.67	46.00	-14.33	QP
866.31	V	35.25	46.00	-10.75	QP
956.47	V	38.17	46.00	-7.83	QP
31.55	H	23.10	40.00	-16.90	QP
149.70	H	26.99	43.50	-16.51	QP
249.18	H	33.75	46.00	-12.25	QP
275.61	H	36.23	46.00	-9.77	QP
625.37	H	34.63	46.00	-11.37	QP
866.31	H	35.15	46.00	-10.85	QP

Operation Mode: 915.25MHz Test Date : 04/05/2012
 Frequency Range: 30~1000MHz Temperature : 28 °C
 Test Result: PASS Humidity : 65 %
 Measured Distance: 3m Test By: KL

Freq. (MHz)	Ant.Pol. H/V	Emission Level (dBuV/m)	Limit 3m (dBuV/m)	Margin (dB)	Note
31.55	V	25.20	40.00	-14.80	QP
104.62	V	25.52	43.50	-17.98	QP
249.18	V	27.56	46.00	-18.44	QP
432.61	V	23.51	46.00	-22.49	QP
625.37	V	31.94	46.00	-14.06	QP
867.87	V	29.06	46.00	-16.94	QP
149.70	H	26.18	43.50	-17.32	QP
249.18	H	27.25	46.00	-18.75	QP
600.50	H	27.96	46.00	-18.04	QP
625.37	H	34.75	46.00	-11.25	QP
751.28	H	29.56	46.00	-16.44	QP
867.87	H	32.25	46.00	-13.75	QP

Operation Mode: 927.25MHz Test Date : 04/05/2012
 Frequency Range: 30~1000MHz Temperature : 28 °C
 Test Result: PASS Humidity : 65 %
 Measured Distance: 3m Test By: KL

Freq. (MHz)	Ant.Pol. H/V	Emission Level (dBuV/m)	Limit 3m (dBuV/m)	Margin (dB)	Note
53.32	V	29.09	40.00	-10.91	QP
123.27	V	32.22	43.50	-11.28	QP
152.80	V	33.69	43.50	-9.81	QP
205.66	V	31.52	43.50	-11.98	QP
410.85	V	33.92	46.00	-12.08	QP
452.82	V	34.88	46.00	-11.12	QP
53.32	H	28.70	40.00	-11.30	QP
163.69	H	33.40	43.50	-10.10	QP
179.23	H	35.00	43.50	-8.50	QP
370.43	H	37.64	46.00	-8.36	QP
527.44	H	35.05	46.00	-10.95	QP
699.98	H	36.96	46.00	-9.04	QP

- Note:**
- (1) All Readings are Peak Value.
 - (2) Emission Level= Reading Level+Probe Factor +Cable Loss
 - (3) The average measurement was not performed when the peak measured data under the limit of average detection.
 - (4) All the x/y/z orientation has been investigated, and only worst case is presented in this report.

Operation Mode: CH1: 915.75MHz Test Date : 04/05/2012
 Frequency Range: 1-25GHz Temperature : 28 °C
 Test Result: PASS Humidity : 65 %
 Measured Distance: 3m Test By: Andy

Freq. (MHz)	Ant.Pol. H/V	Emission Level(dBuV/m)		Limit 3m(dBuV/m)		Margin(dB)	
		PK	AV	PK	AV	PK	AV
1827.25	V	67.84	39.09	74.00	54.00	-18.77	-14.91
2745.20	V	53.23	40.66	74.00	54.00	-20.77	-13.34
4575.78	V	58.73	46.12	74.00	54.00	-15.27	-7.88
--	V	--	--	--	--	--	--
--	V	--	--	--	--	--	--
--	V	--	--	--	--	--	--
1825.10	H	67.18	44.55	74.00	54.00	-6.82	-9.45
3660.50	H	57.21	45.82	74.00	54.00	-16.79	-8.18
4573.89	H	57.65	46.31	74.00	54.00	-16.35	-7.69
--	H	--	--	--	--	--	--

Operation Mode: CH26: 915.25MHz Test Date : 04/05/2012
 Frequency Range: 1-25GHz Temperature : 28 °C
 Test Result: PASS Humidity : 65 %
 Measured Distance: 3m Test By: Andy

Freq. (MHz)	Ant.Pol. H/V	Emission Level(dBuV/m)		Limit 3m(dBuV/m)		Margin(dB)	
		PK	AV	PK	AV	PK	AV
1823.88	V	60.24	40.08	74	54	-13.76	-13.92
2747.00	V	52.88	41.19	74	54	-21.12	-12.81
4576.50	V	56.99	43.86	74	54	-17.01	-10.14
--	V	--	--	--	--	--	--
--	V	--	--	--	--	--	--
--	V	--	--	--	--	--	--
1820.33	H	60.11	40.11	74	54	-12.89	-13.89
3658.78	H	52.48	39.76	74	54	-21.52	-14.24
4577.19	H	57.08	45.91	74	54	-16.92	-8.09
--	H	--	--	--	--	--	--

Operation Mode: CH50: 927.25MHz Test Date : 04/05/2012
 Frequency Range: 1-25GHz Temperature : 28 °C
 Test Result: PASS Humidity : 65 %
 Measured Distance: 3m Test By: Andy

Freq. (MHz)	Ant.Pol. H/V	Emission Level(dBuV/m)		Limit 3m(dBuV/m)		Margin(dB)	
		PK	AV	PK	AV	PK	AV
1830.29	V	55.58	37.13	74.00	54.00	-18.42	-16.87
2745.58	V	53.64	40.98	74.00	54.00	-20.36	-13.02
4578.00	V	57.90	45.69	74.00	54.00	-16.10	-8.31
--	V	--	--	--	--	--	--
--	V	--	--	--	--	--	--
--	V	--	--	--	--	--	--
1827.63	H	53.10	35.90	74.00	54.00	-20.90	-18.10
3663.08	H	51.31	39.89	74.00	54.00	-22.69	-14.11
4576.89	H	57.47	45.31	74.00	54.00	-16.53	-8.69
--	H	--	--	--	--	--	--

- Note:**
- (1) All Readings are Peak Value and AV.
 - (2) Emission Level= Reading Level+Probe Factor +Cable Loss
 - (3) Data of measurement within this frequency range shown “ -- ” in the table above means the reading of emissions are attenuated more than 20dB below the permissible limits or the field strength is too small to be measured.
 - (4) All the x/y/z orientation has been investigated, and only worst case is presented in this report.

5.5 Radiated Measurement Photos:

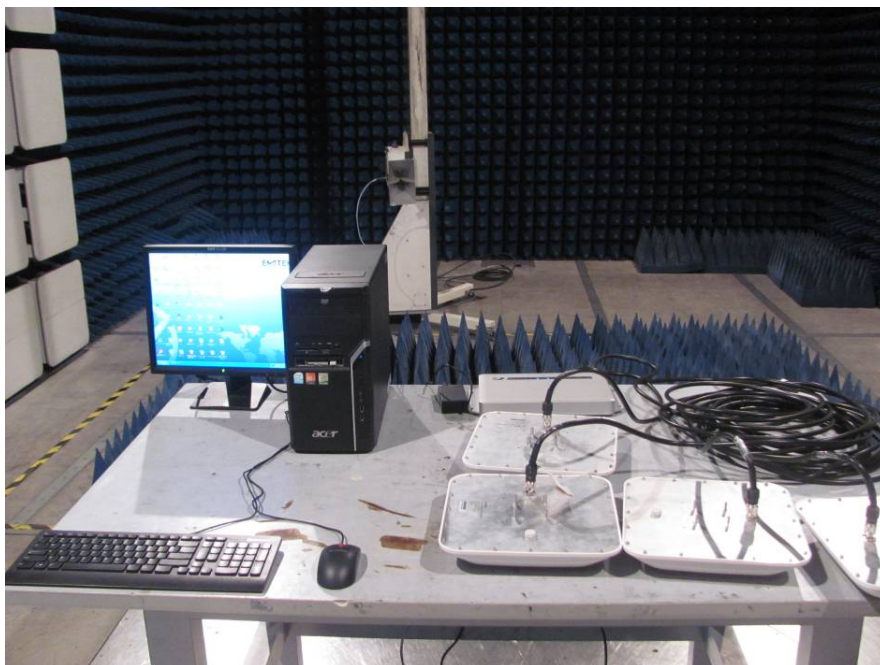
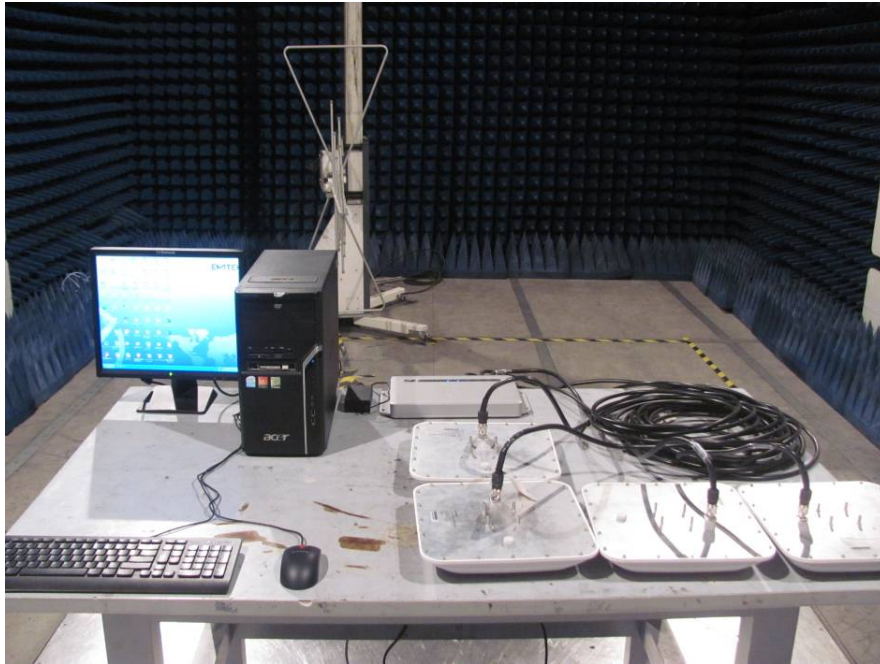

6. Channel Separation test

6.1 Measurement Procedure

The EUT was operating in hopping mode or could be controlled its channel. Printed out the test result from the spectrum by hard copy function.

6.2 Test SET-UP (Block Diagram of Configuration)

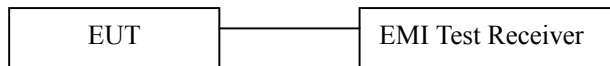

6.3 Measurement Equipment Used:

EQUIPMENT TYPE	MFR	MODEL NUMBER	SERIAL NUMBER	LAST CAL.	CAL DUE.
EMI Test Receiver	Rohde & Schwarz	ESU	1302.6005.26	05/29/2011	05/29/2012

6.4 Measurement Results:

The following table is the setting of spectrum analyzer.

EMI Test Receiver	Setting
Attenuation	Auto
RB	100kHz
VB	300kHz
Detector	Peak
Trace	Max hold

Refer to attached data chart.

Spectrum Detector: PK Test Date : 04/05/2012
 Test By: Andy Temperature : 28 °C
 Test Result: PASS Humidity : 65 %

Channel number	Channel frequency (MHz)	Separation Read Value (kHz)	Separation Limit 2/3 20dB Down BW(kHz)
1	902.27	500	>190.05 kHz
26	915.25	500	>183.51 kHz
50	927.25	500	>180.38 kHz

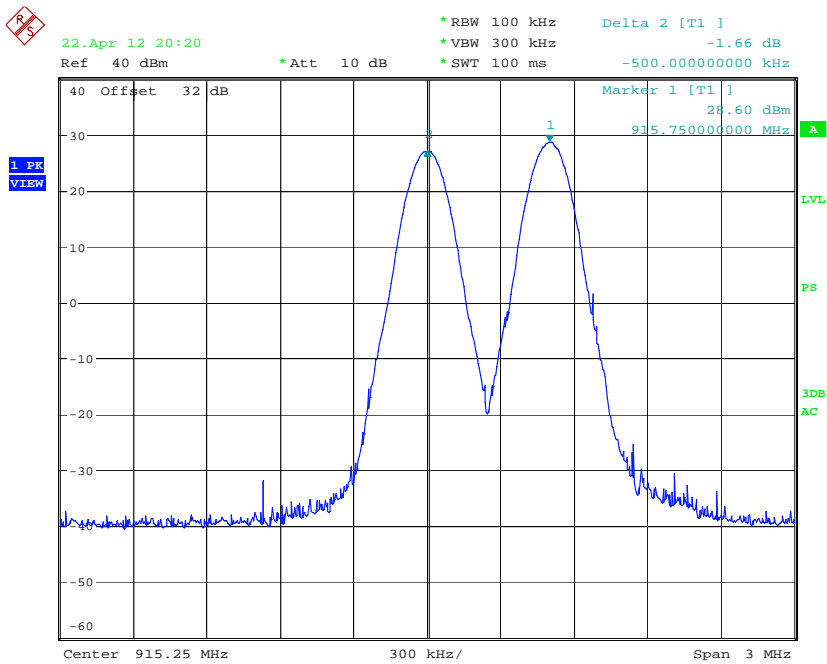
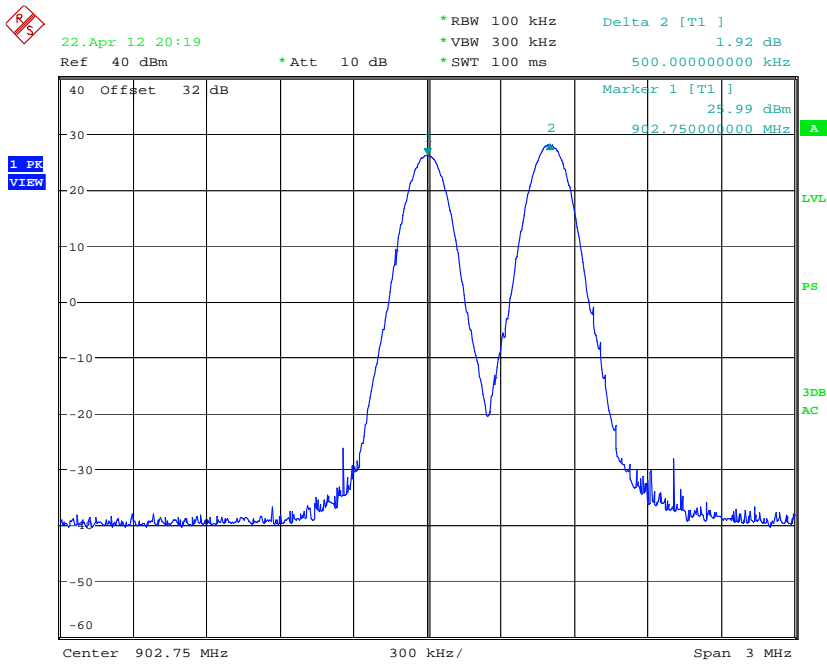

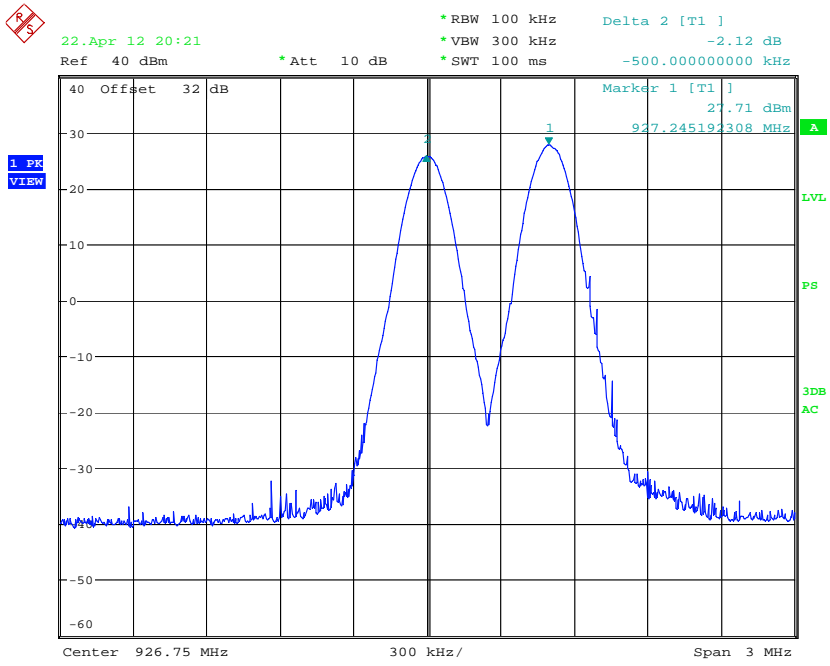

7. Bandwidth test

7.1 Measurement Procedure

The EUT was operating in hopping mode or could be controlled its channel. Printed out the test result from the spectrum by hard copy function.

7.2 Test SET-UP (Block Diagram of Configuration)

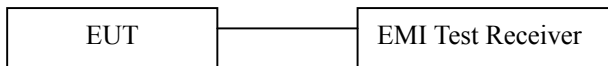

7.3 Measurement Equipment Used:

EQUIPMENT TYPE	MFR	MODEL NUMBER	SERIAL NUMBER	LAST CAL.	CAL DUE.
EMI Test Receiver	Rohde & Schwarz	ESU	1302.6005.26	05/29/2011	05/29/2012

7.4 Measurement Results:

7.4.1. 20dB Bandwidth test data Chart:

Refer to attached data chart.

Spectrum Detector:	PK	Test Date:	04/05/2012
Test By:	Andy	Temperature:	28 °C
Test Result:	PASS	Humidity:	65 %

Channel number	Channel frequency (MHz)	20dB Down BW(kHz)
1	902.27	283.65
26	915.25	274.04
50	927.25	269.23

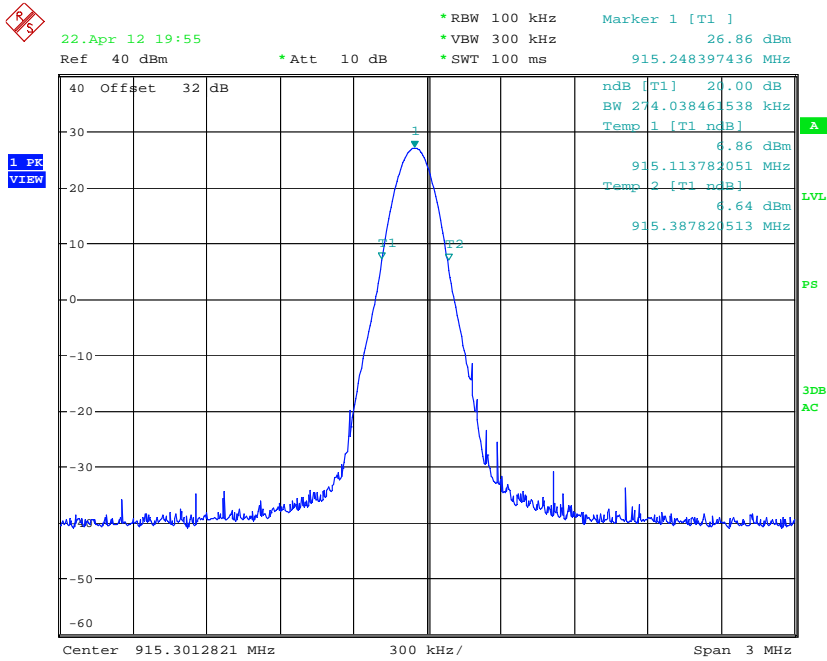
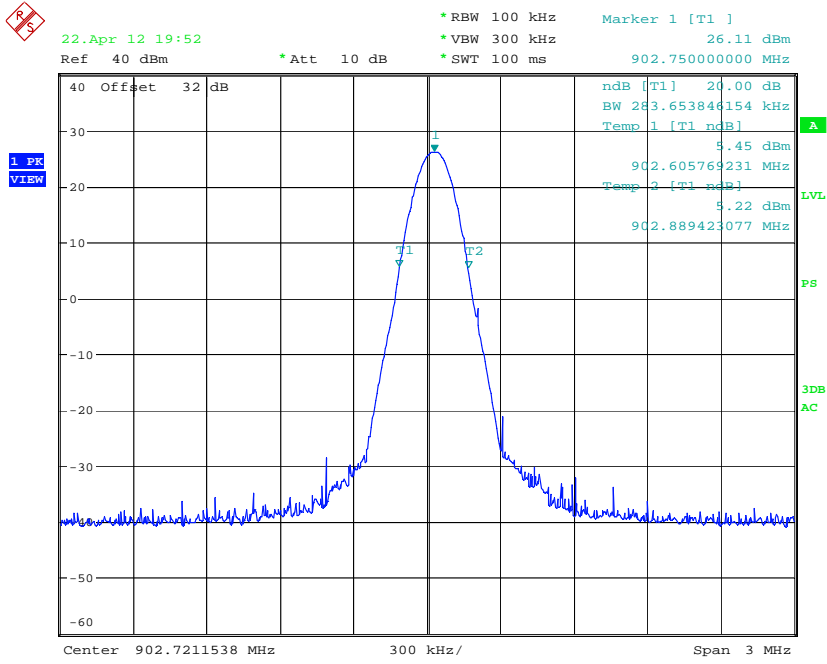

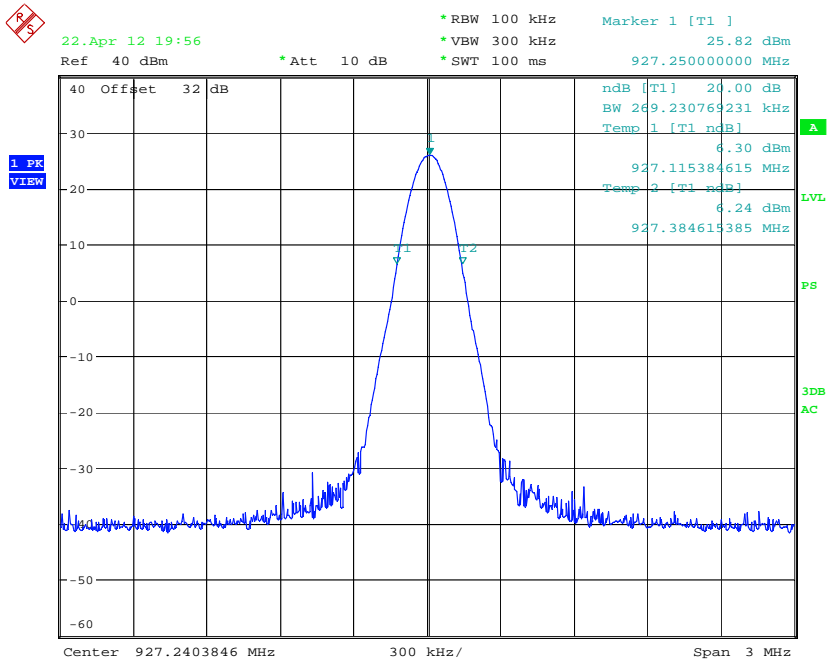

8. Quantity of Hopping Channel Test

8.1 Measurement Procedure

The EUT was operating in hopping mode or could be controlled its channel. Printed out the test result from the spectrum by hard copy function.

8.2 Test SET-UP (Block Diagram of Configuration)

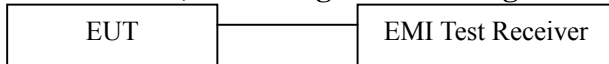

8.3 Measurement Equipment Used:

EQUIPMENT TYPE	MFR	MODEL NUMBER	SERIAL NUMBER	LAST CAL.	CAL DUE.
EMI Test Receiver	Rohde & Schwarz	ESU	1302.6005.26	05/29/2011	05/29/2012

8.4 Measurement Results:

All the modulation modes were tested and the data of the GFSK mode are recorded in the following page.

Spectrum Detector:	PK	Test Date :	04/05/2012
Test By:	Andy	Temperature :	28 °C
Test Result:	PASS	Humidity :	65 %

Hopping Channel Frequency Range	Quantity of Hopping Channel	Quantity of Hopping Channel limit
902.75-927.25	50	> 15



22.Apr 12 20:16

Ref 40 dBm

* Att 10 dB

* RBW 100 kHz

* VBW 300 kHz

* SWT 100 ms

Marker 1 [T1]

29.35 dBm

911.724358974 MHz

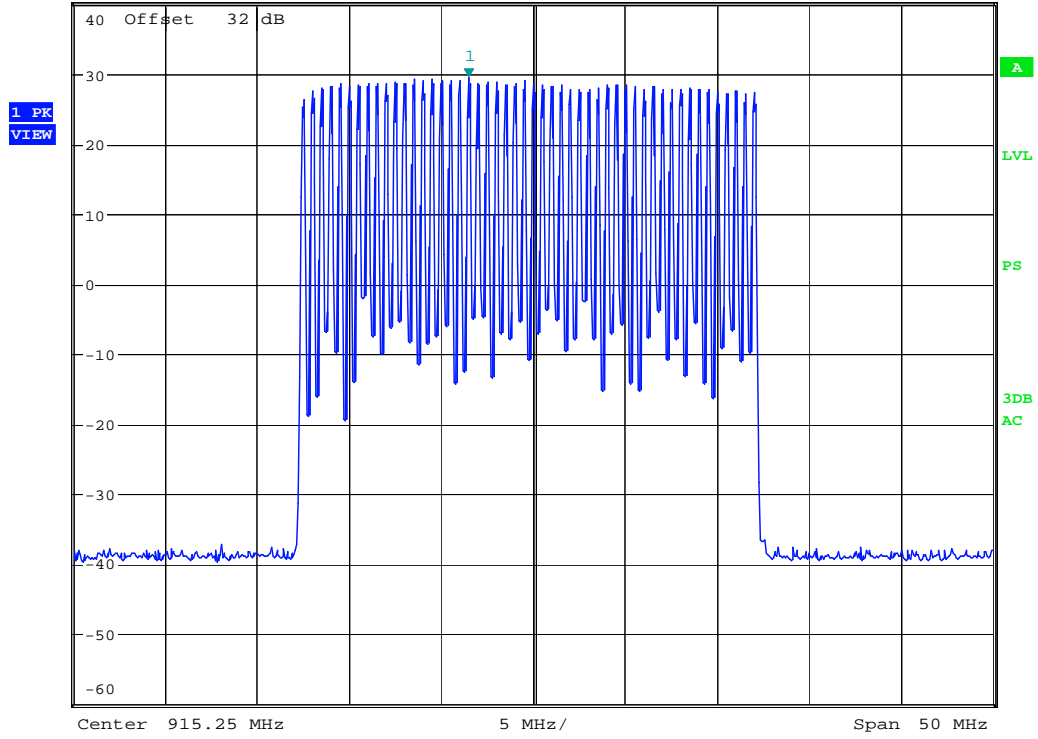

9. Time of Occupancy (Dwell Time) test

Test Method

1. Connect EUT antenna terminal to the spectrum analyzer with a low loss cable.
 Equipment mode: Spectrum analyzer
 RBW: 100kHz; VBW: 300kHz; SPAN: Zero Span
2. Adjust the center frequency of spectrum analyzer on any frequency be measured.
3. Measure the Dwell Time by spectrum analyzer Marker function.
4. Repeat above procedures until all frequencies measured were complete.

Limit

According to 15.247(a)(1)(i), if the 20 dB bandwidth of the hopping channel is 250 kHz or greater, the system shall use at least 25 hopping frequencies and the average time of occupancy on any frequency shall not be greater than 0.4 seconds within a 10 second period.

9.2 Test SET-UP (Block Diagram of Configuration)

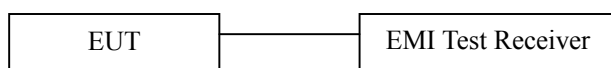

9.3 Measurement Equipment Used:

EQUIPMENT TYPE	MFR	MODEL NUMBER	SERIAL NUMBER	LAST CAL.	CAL DUE.
EMI Test Receiver	Rohde & Schwarz	ESU	1302.6005.26	05/29/2011	05/29/2012

9.4 Measurement Results:

Spectrum Detector:	PK	Test Date :	04/05/2012
Test By:	Andy	Temperature :	28 °C
Test Result:	PASS	Humidity :	65 %

In 10 S total 3 times to be found, per transmitting time are

Dwell Time: $3 \times 17.2\text{ms} = 51.60\text{ms} < 0.4\text{S}(\text{Limit})$

Test result: Pass

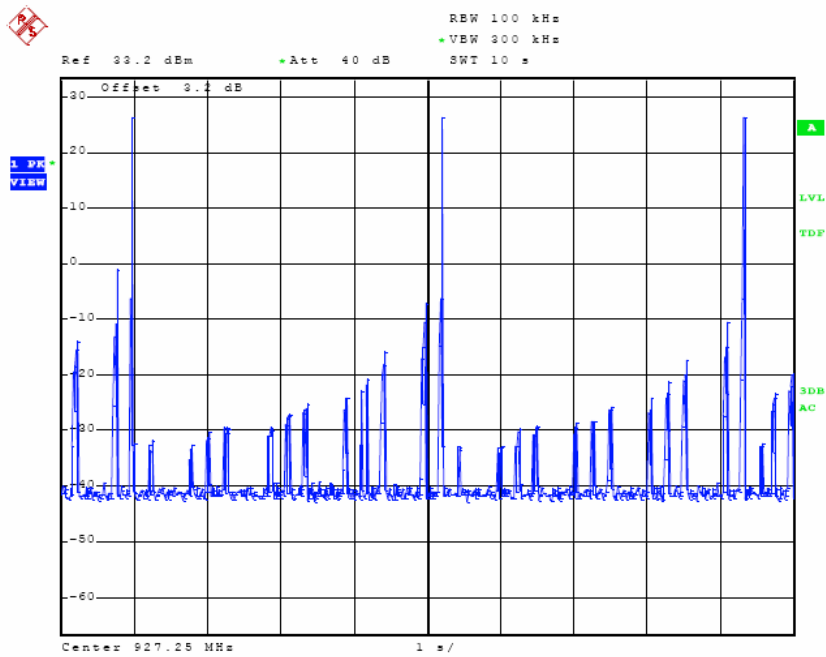
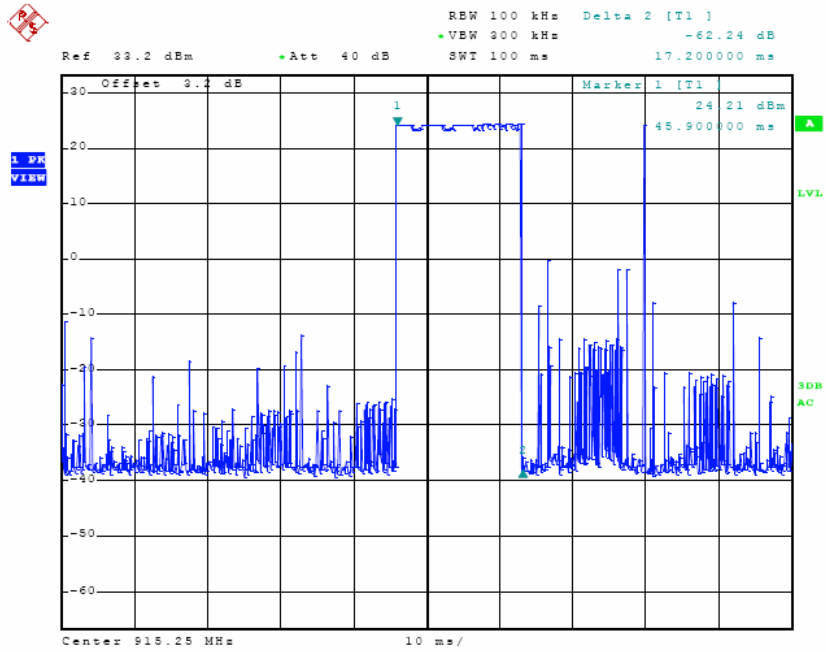

10. MAXIMUM PEAK OUTPUT POWER TEST

10.1 Measurement Procedure

- a. Check the calibration of the measuring instrument(RF Power Meter) using either an internal calibrator or a known signal from an external generator.
- b. Turn on the EUT and connect it to measurement instrument. Then set it to any one convenient frequency within its operating range. Set a reference level on the measuring instrument equal to the highest peak value.
- c. The center frequency of the spectrum analyzer is set to the fundamental frequency and using proper RBW and VBW setting.
- d. Measure the captured power within the band and recording the plot.
- e. Repeat above procedures until all frequencies required were complete.

10.2 Test SET-UP (Block Diagram of Configuration)

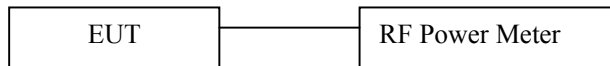

10.3 Measurement Equipment Used:

EQUIPMENT TYPE	MFR	MODEL NUMBER	SERIAL NUMBER	LAST CAL.	CAL DUE.
RF Power Meter. Dual Channel	BOONTON	4232A	10539	05/29/2011	05/29/2012
50ohm Diode Power Sensor	BOONTON	51011EMC	34236	05/29/2011	05/29/2012

10.4 Measurement Results:

Spectrum Detector: PK Test Date : 04/05/2012
 Test By: Andy Temperature : 28 °C
 Test Result: PASS Humidity : 65 %
 Modulation: GFSK

Channel number	Channel Frequency (MHz)	Peak Power output(dBm)	Peak Power output(mW)	Peak Power Limit(W)	Pass/Fail
1	902.75	27.08	510.51	1.00	PASS
26	915.25	27.06	508.16	1.00	PASS
50	927.25	27.02	503.50	1.00	PASS

11. Band EDGE test

11.1 Measurement Procedure

1. The EUT was Operating in hopping mode or could be controlled its channel. Printed out test result from the spectrum by hard copy function.
2. The EUT was placed on a turn table which is 0.8m above ground plane.
3. Maximum procedure was performed on the six highest emissions to ensure EUT compliance.
4. And also, each emission was to be maximized by changing the polarization of receiving antenna both horizontal and vertical.
5. Repeat above procedures until all frequency measured were complete.

11.2 Test SET-UP (Block Diagram of Configuration)

As 5.2 Test set up (B) and (C)

11.3 Measurement Equipment Used:

Same as 5.3 Radiated Emission Measurement.

11.4 Measurement Results:

All the modes were tested

Spectrum Detector:	PK/AV	Test Date :	04/05/2012
Test By:	Andy	Temperature :	28 °C
Test channel:	01	Humidity :	65 %
Channel unumber	902.27MHz		

Frequency (MHz)	Polarity	Level (dBuV/m)		Limited (dBuV/m)	
		PK	AV	PK	AV
902.00	H	48.83	35.34	74	54
902.00	V	49.37	36.42	74	54

Spectrum Detector:	PK/AV	Test Date :	04/05/2012
Test By:	Andy	Temperature :	28 °C
Test channel:	50	Humidity :	65 %
Channel unumber	927.25 MHz		

Frequency (MHz)	Polarity	Level (dBuV/m)		Limited (dBuV/m)	
		PK	AV	PK	AV
928.00	H	51.28	38.41	74	54
928.00	V	50.39	37.29	74	54

11. Antenna Port Emission

12.1 Test Equipment

EQUIPMENT TYPE	MFR	MODEL NUMBER	SERIAL NUMBER	LAST CAL.	CAL DUE.
EMI Test Receiver	Rohde & Schwarz	ESU	1302.6005.26	05/29/2011	05/29/2012

12.2 Measuring Instruments and setting

The following table is the setting of spectrum analyzer.

EMI Test Receiver	Setting
Attenuation	Auto
RB	100kHz
VB	300kHz
Detector	Peak
Trace	Max hold

12.3 Test Procedures

The conducted spurious emissions were measured conducted using a spectrum analyzer at low, mid, and hi channels, The limit was determined by attenuation 20dB of the RF peak power output.

12.4 Block Diagram of Test setup

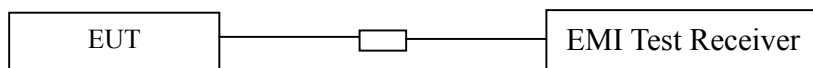

12.5 Test Result

PASS.

All the modes were tested and the data recorded in the following pages.

TX 902.75MHz

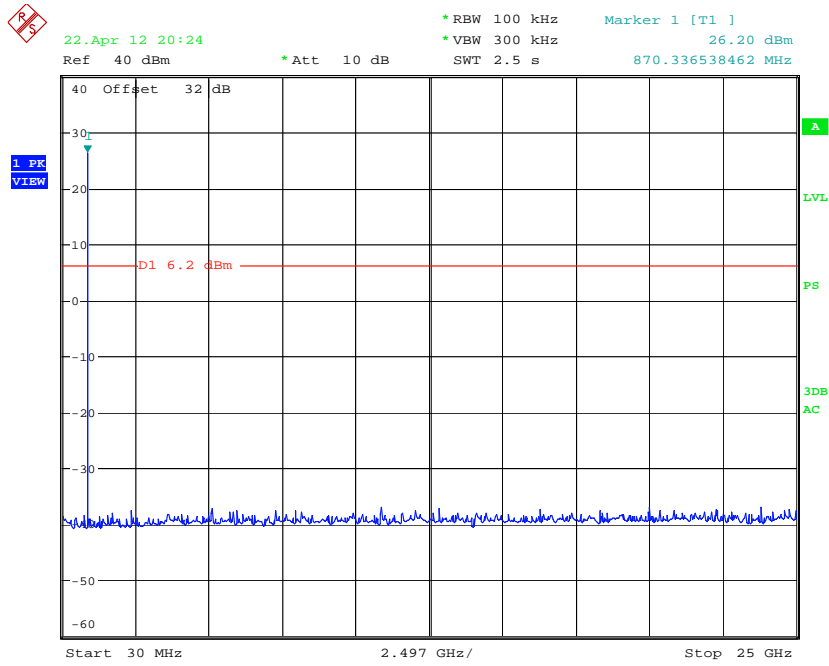

TX 912.25MHz

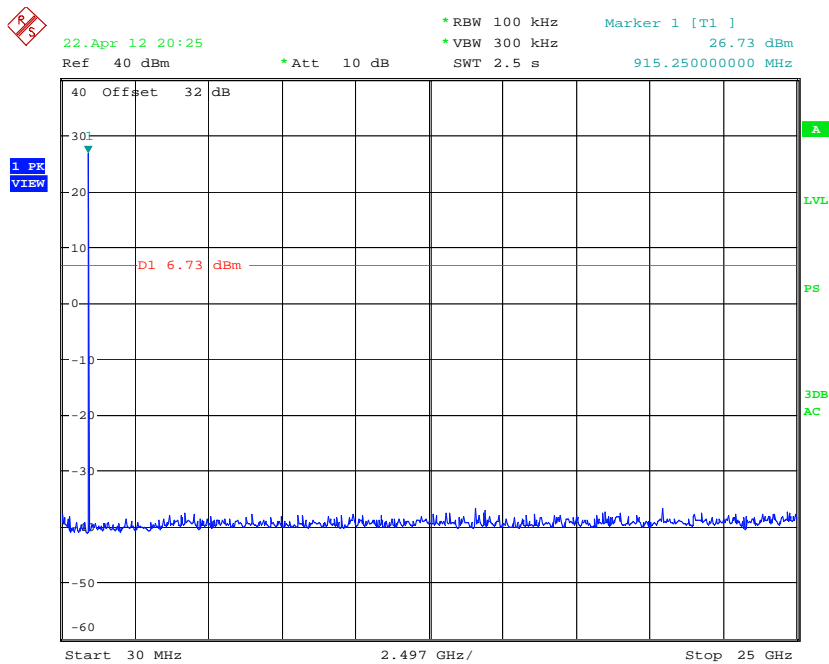

TX 927.25MHz

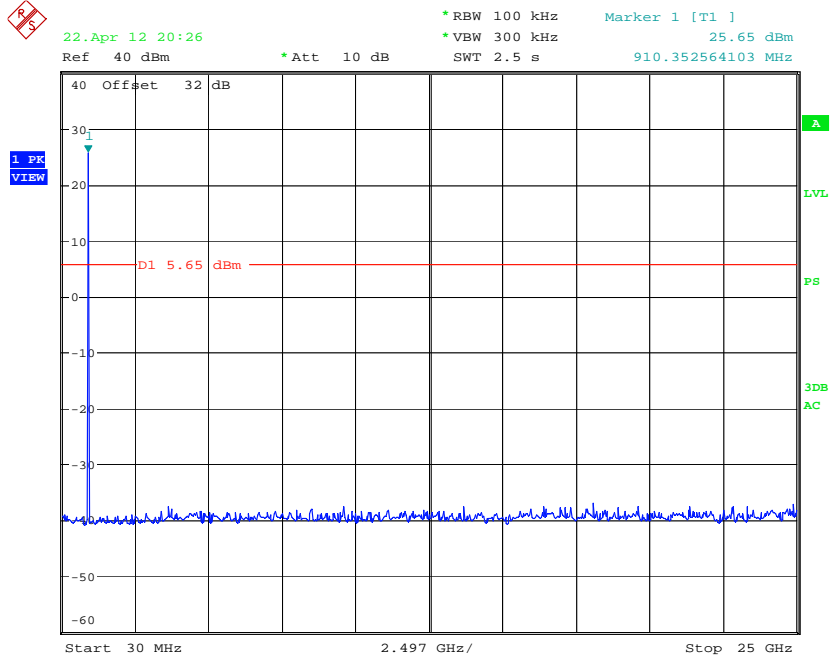

12. Antenna Application

12.1 Antenna Requirement

For intentional device, according to FCC 47 CFR Section 15.203, an intentional radiator shall be designed to ensure that no antenna other than that furnished by the responsible party shall be used with the device. And according to FCC 47 CFR Section 15.247 (b) (4) , if transmitting antennas of directional gain greater than 6dBi are used, the power shall be reduced by the amount in dB that the directional gain of the antenna exceeds 6dBi. (4) The conducted output power limit specified in paragraph (b) of this section is based on the use of antennas with directional gains that do not exceed 6 dBi. Except as shown in paragraph (c) of this section, if transmitting antennas of directional gain greater than 6 dBi are used, the conducted output power from the intentional radiator shall be reduced below the stated values in paragraphs (b)(1), (b)(2), and (b)(3) of this section, as appropriate, by the amount in dB that the directional gain of the antenna exceeds 6 dBi.

12.2 Result

The EUT'S antenna is Specific External Antenna. The antenna's gain is 7.5dBi and meets the requirement.