

User Manual



XC2908 Portable Reader

www.invengo.cn

Welcome to become a user of Invengo RFID products!

We are very glad that you choose the XC2908 Portable Reader. We hope that our equipment can bring convenience to your work.





Foreword

This manual is applicable to the following products:

XC2908 Portable Reader

The version number of this manual is V1.1. The revision history is shown in the table below:

Aug 5,2021	First draft V1.0
Jul 7, 2022	V1.1

 or  logo are owned by Invengo Company.

The introduction and description of product characteristics and functions and other information in this manual are the latest valid information at that time, and all information is accurate at the time of printing. Invengo reserves the right to correct or change the information and instructions in this manual without prior notice and assumes no responsibility for it.

Some of the features of the product may vary from configuration to configuration, depending on your particular needs.

Safety Instructions



Warning sign

Improper operation may do harm to your health.

Improper operation may cause damage to the equipment.



Caution sign

If it is ignored, your operation may not be conducted smoothly.

If it is ignored, it may bring you undesirable results.

Content

1、 Product Overview	1
1.1、 Product Introduction	1
1.2、 Main Application and Scope of Application	2
1.3、 Environmental Conditions	2
1.4、 Safety and Protective Measures	2
2、 Performance Parameters.....	4
2.1、 Main Functions.....	4
2.2、 Technical Parameters	4
3、 Structure & Operationtheory	8
3.1、 Functional Description	8
3.2、 Install and Remove the Battery.....	8
3.3、 Boot/Shutdown/Standby/Restart.....	9
4、 RFID 10	
4.1、 Function Introduction.....	10
4.2、 Technical Parameters	10
4.3、 RFID Demo	11
4.4、 Developing RFID Applications	13
5、 Barcode(optional).....	13
5.1 Specification Parameter	13
5.2 Barcode Type.....	13
6、 Common functions and Settings.....	15
6.1、 USB	15
6.2、 Display	16
6.3、 Sound.....	18
6.4、 System.....	18
6.5、 Mobile Network	20
6.6、 Bluetooth.....	22
6.7、 Ohter.....	24

7、 Other optional modules.....	27
7.1、 Camera	27
8、 Announcements	27
8.1、 Description of Power Saving.....	27
8.2、 Exception Declaration	27
9、 Daily Maintenance and FAQ	29
9.1、 Daily Maintenance.....	29
9.2、 FAQ.....	29
9.3、 Radio Frequency Communication Optimization.....	30
10、 Transport and Storage	34
10.1、 Transportation Requirement.....	34
10.2、 Storage Requirement.....	34
11、 Packaging & Unpacking.....	35
11.1、 Packing.....	35
11.2、 Unpacking.....	35
12、 After-sales	36
12.1、 After-sales Services.....	36
12.2、 Other Notes.....	36

1、 Product Overview

1.1、 Product Introduction

XC2908 Portable reader is the fourth-generation Portable reader developed by Invengo based on the requirements of the Internet of Things application scenarios.

It has eight core processor, Android 10、 11 system, 4G network (data), Wi-Fi, Bluetooth, GPS, PSAM and other functions, and can be equipped with cameras and various scanners.

Unique RFID technology (self-developed UHF module + four-arm spiral antenna + multi-tag algorithm), intelligent switching of dual batteries and ultra-long battery life function, make it stand out among similar products from many manufacturers.

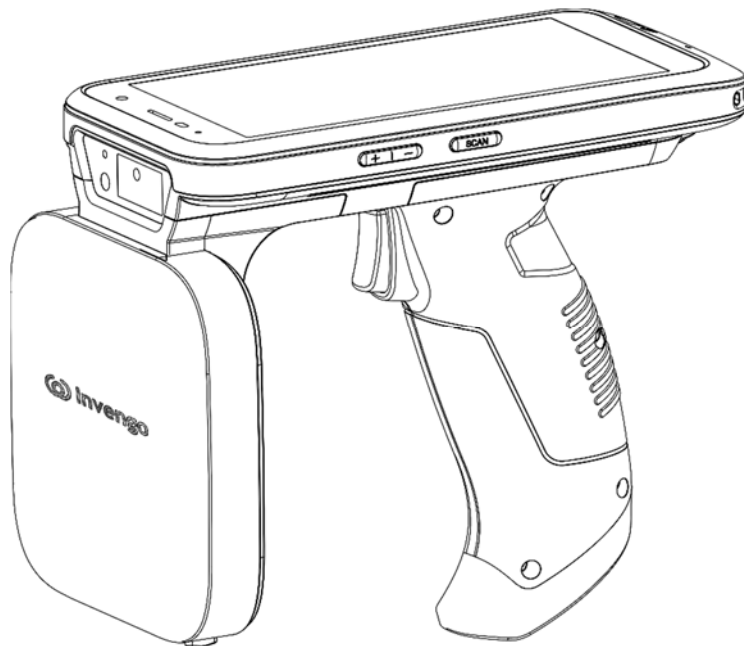

Figure 1.1 XC2908 Portable Reader

1.2、 Main Application and Scope of Application

The XC2908 Portable reader has rich functions and can be widely used in many fields, such as clothing retail, warehouse management, asset inventory, smart medical and so on.

1.3、 Environmental Conditions

Operating temperature: $-20^{\circ}\text{C}\sim 50^{\circ}\text{C}$

Operating temperature with Micro SD: $0^{\circ}\text{C}\sim 55^{\circ}\text{C}$

Storage temperature: $-40^{\circ}\text{C}\sim 70^{\circ}\text{C}$

Humidity range: 5% ~ 95% (without condensation)

1.4、 Safety and Protective Measures



When the reader is working (radiating microwave), do not aim at people and animals for a long time!



Please refer to the notes before use!



Any radio-transmitting equipment, including this equipment, is likely to interfere with the operation of medical equipment that is not properly protected. In case of such problems, the manufacturer of the medical device concerned can be consulted. The work of this equipment may also cause interference to other electronic equipment!

2、 Performance Parameters

2.1、 Main Functions

- Support EPC Global UHF Class 1 Gen 2/ISO18000-6C
- Support 4G network (data)
- Support Wi-Fi 802.11.a/b/g/n/ac, 2.4G+5G dual frequency
- Support Bluetooth 5.0
- Integration GPS, Support A-GPS, BDS, GLONASS
- Support 1D, 2D Scanner (optional)
- Support front and rear camera modules (optional)
- Provide the SDK development kit and demo code

2.2、 Technical Parameters

As shown in the following table:

Performance Parameters	
CPU	Cortex-A53 eight-core CPU, 2.3GHz
OS	Android 10, 11
RAM+ROM	3GB + 32GB (Standard) 4GB + 64GB (Optional) 6GB + 128GB (Optional)
Extended Memory	Support 256GB Micro SD
Physical Parameter	
Size	170×78×150±2mm
Weight	710g
Display Screen	5.5 inch IPS screen, 720*1440

User Manual of XC2908 Portable Reader

Touch Screen	Corning Gorilla III industrial-grade capacitive screen supports multi-touch, glove or wet hand operation
Keypress	One power keypress, two scan keypresses, and two volume keypresses
Audio	One receiver, one BOX cavity speaker, two microphones, including one for noise reduction
USB	USB 2.0 Type-C, support OTG, Type-C headset
Extend Slot	One SIM slot, and other supported SIM or TF
Notification	Vibration, charging, interactive indicators, sound
Sensor	Gravity sensor, distance sensor, light sensor
Power Supply Parameters	
Battery Capacity	Total capacity 10000mAh, dual battery intelligent power supply, Main battery 5000mAh, handle battery 5000mAh
Power Adapter	Input: AC 110V ~ 240V Output: DC 5V 3A
Work Time	>ten hours(Depends on usage)
Charge Time	three-four hours
Stand-by time	>250 hours
UHF RFID	
Portocol	EPC Global UHF class1 Gen2/ISO 18000-6C
Frequency Range	902.75-927.25MHz

User Manual of XC2908 Portable Reader

Power	-1dBm-30dBm(Some models support 33dBm)	
Scanning Distance	Indoor open environment istance up to 20 meters	
Writing Distance	0m~5m(Depends on the label and the working environment)	
Maximum read rate	600 t/s	
Antenna Parameter	Circular polarization / BT&wifi(1.18dBi),5G(1.29dBi), RFID(4dBi) GSM 850:0.65dBi,PCS1900:1.11dBi, WCDMA B2:1.11dBi,WCDMA B5:0.65dBi LTE B2:1.11dBi,B4:1.02dBi,B5:0.65dBi,B7:1.21dBi B12:0.53dBi,B17:0.53dBi,LTE B38:1.21dBi,B40:1.18dBi,B41:1.21dBi	
Network and wireless connection		
WWAN	4G	TDD:B38/B40/B41 FDD:B2/B4/B5/B7/B12 /B17
	3G	WCDMA:B2/B5
	2G	GSM/GPRS/Edge (850/1900MHz)
WLAN	support protocol: IEEE 802.11 a/b/g/n/ac Communication rate: 2.4GHz and 5GHz,dual-band Transmission distance: •Indoor 20m(No roadblock) •Outdoor 50m(No roadblock)	
Bluetooth	Bluetooth 5.0 (No roadblock) Within 10 meters, the Bluetooth headset can play music without noise. Within 8 meters, there is no noise when using Bluetooth headset. (No roadblock) Within 4 meters, files can be sent to other mobile phones through Bluetooth function.	
GNSS	Integrated GPS, support A-GPS, BDS, GLONASS (System reserved support)	
Environmental Conditions		
Operating temperature	-20℃ ~ 50℃	
Storage temperature	-40℃ ~ 70℃	

User Manual of XC2908 Portable Reader

Humidity range	5% ~95% RH(without condensation)
Optional	
Barcode module(optional)	Including SE4710, SE4750, NLS-N1 , CM30, CM60 readable code: PDF417, Micro PDF417 , QR Code, Micro QR , DataMatrix, AZTEC, Han Xin Code, Maxicode, Composite, EAN13, EAN8, UPCA, UPCE, Code 128, Code 39, Codabar, UCC/EAN128, RSS, ITF, ITF14, ITF6, ISSN, ISBN, Standard 25, Matrix 25, Industrial 25, Plessey, MSI Plessey, Code 11, Code 93
camera(optional)	front-facing camera: Five or eight megapixels rear camera: 13 or 16 megapixels, flashlight, auto-focusing
UHF RFID(optional)	Protocol:ISO14443A/B, ISO15693
PSAM(optional)	Protocol:ISO7816 T=0, T=1
attachment	Power adapter, USB cable, Screen protector, Wrist Strap, Charger (Optional)
Development and Support	
development environment	SDK: invengo api Language: Java IDE: Eclipse/Android Studio
applications	RFID Demo Barcode Demo

3、 Structure & Operationtheory

3.1、 Functional Description

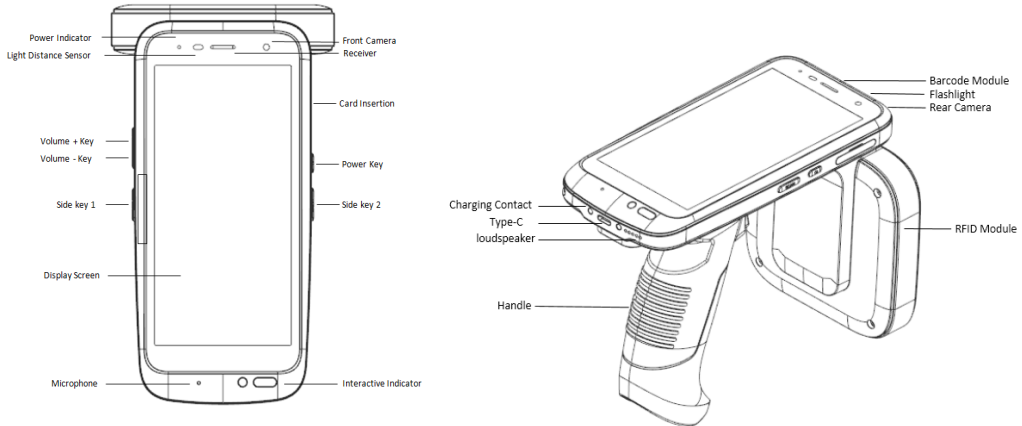

1) RFID

Including UHF antenna and UHF RFID module.

2) Barcode Module /Camera(Optional)

Barcode Scanner and camera are modular optional functions.The barcode scanner can be used to adaptively collect 1D and 2D barcode data.The camera takes photos and videos.

3) Battery

The main battery is located in the PDA and cannot be removed. The handle battery is located in the handle, which is removable.

4) Type-C

Power input port, support OTG function, can be used for data transmission with other devices, and support software debugging.

5) Side key 1/2

User can customize the development for RFID or barcode scan trigger keys.

6) Interactive indicator light

Users can customize the development for RFID or bar code scanning indicator.

7) Charging contact

Used for charging with the seat.

3.2、 Install and Remove the Battery

Installing and removing the battery is only applicable to handle battery operation.

【Install battery】

Place the handle to the position to be installed, align with the positioning cable, and PUSH forward until you hear a "click" sound. At the same time, the " PUSH " button is lifted. If the handle is pressed, the installation is successful.

【Remove battery】

Press the "PUSH" button, the handle will pop slightly, and then take it out.

The battery is charged through the Type-C port. Use the original adapter to charge the battery. Do not use adapters of other brands to charge the device.

3.3、 Boot/Shutdown/Standby/Restart

1) Boot

In the shutdown state, long press the power button for 3 seconds, the device startup interface starts, the device enters the system normally.

2) Wake up, standby

When the screen is off, tap the power button to display the system running interface and wake up the system. Tap the power button again to enter the standby state.

3) Shutdown/Restart Mode 1

Under normal conditions, long press the power button for 3 seconds, and the "Shutdown/Restart" menu will pop up on the right side of the device screen, as shown below:



- i. Select Shutdown, the device screen and system will be shut down.
- ii. Select Restart to close the device screen and restart the system.

4) Restart Mode 2

Equipment can't normal operation, and any keystrokes no response, more than 10 seconds long press the power button, the system automatically restart.

4、RFID

4.1、Function Introduction

The device can read tags made by different manufacturers in accordance with EPC Global UHF Class 1 Gen 2/ISO18000-6C and ISO18000-6B protocol standards(optional), This mode applies to the scenario where tags of different protocol types are used together.

4.2、Technical Parameters

- 1) Frequency band: 902MHz.75-927.25MHz
- 2) Power : -1dBm~30dBm , step-by-step 1dBm(The 33dBm module is optional)
- 3) Modulation system: GFSK
- 4) Working mode: Constant Frequency mode, frequency hopping mode

- 5) Read distance: 0m~20m(Related to the powergain and environment)
- 6) Write distance: 0m~5m(Related to the powergain and environment)
- 7) Direction of polarization: RHCP(circular polarization)
- 8) Antenna gain: See the P6
- 9) Standing-wave ratio: 1.5:1
- 10) Supported 6C tag data capacity: The maximum capacity of the EPC is 62 bytes, the maximum capacity of the TID is 14 bytes, and the maximum capacity of the user data area is 8K bytes
- 11) Supported 6B tag data capacity: The maximum capacity of the label ID is 8 bytes, and the maximum capacity of the user data area is 216 bytes
- 12)  The capacity of supported labels can be increased with software upgrades. This list is for reference only

4.3、RFID Demo

- ✧ Start Invengo Demo App
- ✧ Press the Start button or handle to scan the RFID tag
- ✧ Press the Clear button to clear all scanned RFID tag data

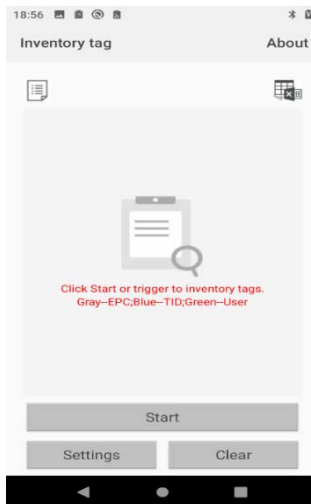

- ✧ Press the Settings button to set the scan tag parameters: tag data (EPC, TID, USER), read type (single read, cyclic read), scan prompt tone, tag data filtering, power gain, Q value, interface Settings (statistics, details).

User Manual of XC2908 Portable Reader

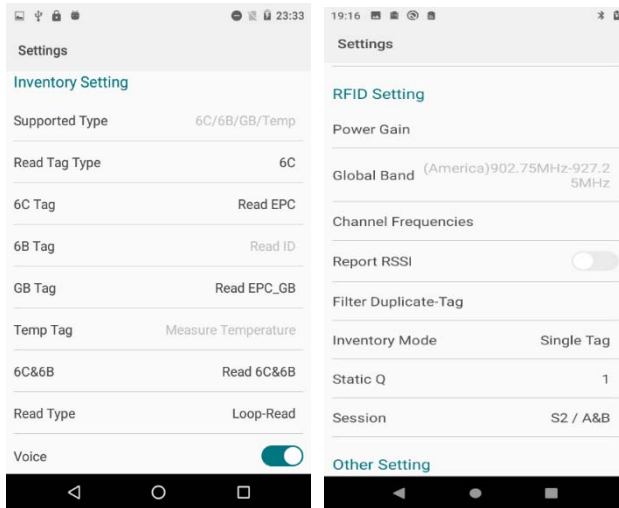

✧ Statistics screen: displays the number of tags, read times, maximum speed, average speed, and read time. You can click the icon in the upper left corner of the main page to switch between them.

✧ Detailed interface: tag data and reading times are displayed. You can select a tag record and click the "tag Information" area to enter the tag operation navigation interface, which supports operations such as writing EPC, reading user data, writing user data, and locking tags.

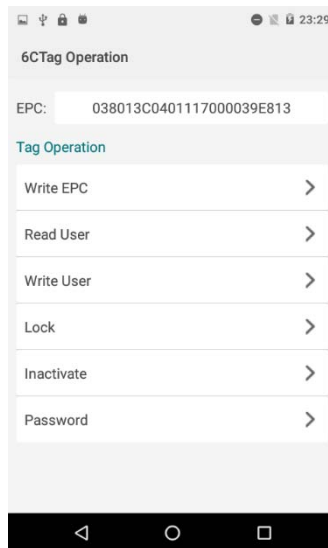

For more details, please refer to 《RFID Reader Demo User Guide》.

4.4、 Developing RFID Applications

Users can use the Invengo RFID SDK to develop their own applications for collecting tag data. The Invengo RFID SDK is the middle layer between the system and the background application software, and provides the software interface for the user's secondary development.



Please refer to 《Invengo Reader API Technical Reference Manual》 under SDK for the call and development instructions of API application interface program.

5、 Barcode(optional)

The reader can be equipped with a variety of high performance barcode scanner. Users can collect 1D or 2D barcode data through the built-in barcode demo, or can develop applications independently to collect barcode data.

5.1 Specification Parameter

Scanner(optional): SE4710、 SE4750、 N1、 CM30、 CM60

scanning angle: $\pm 40^\circ$

scan mode: trigger mode, interrupt mode

5.2 Barcode Type



Type	Code
1D	UPC, EAN, I2 of 5, Code39 , Code93, Code128, Codebar, GS1 Databar Stacked Omni-directional, GS1 Databar Omni-directional, GS1 Databar Stacked
2D	QRCode , Data Matrix, MaxiCode, Aztec Code, PDF417, MicroPDF417, Aztec

	Package label
--	---------------

1) Barcode demo

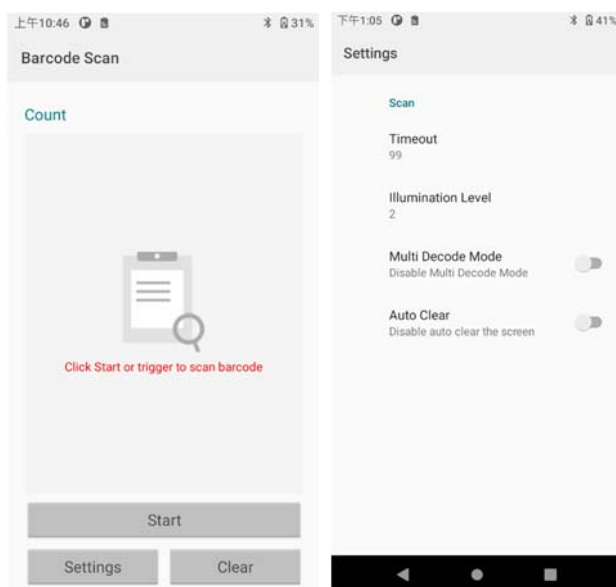
- ✧ Launch the Barcode App on reader.
- ✧ Press the Start button or handle to scan for barcodes.
- ✧ Press the Clear button to clear all scanned bar code data.
- ✧ Press the Setting button to set barcode parameters, such as timeout, illumination level, multi decode mode, clear mode.



-  For the secondary development method of barcode module, please refer to 《Invengo Barcode Service API Reference》
-  In order to ensure the correct reading rate and short reading response time, please ensure that the bar code window of the device is 20--30cm away from the target bar code. If the bar code is printed on a smooth reflective object, please keep the bar code window and the target bar code at an Angle of 15°--30° before reading. Otherwise it may have a certain impact on reading speed.

Note: Before using this function module, please ensure that the equipment you purchase has been installed with a dock module; If it is not installed, contact relevant personnel for further support.

6、 Common functions and Settings

6.1、 USB

- 1) User need to install a driver to connect the device to a PC through a USB cable. For Windows 7 or later, the USB driver will be automatically installed. On Windows XP, User need to manually install the USB driver.
- 2) After the connection is successful, users can browse open content on the PC.
- 3) The notification bar "Android • Charging your device through USB" will be added to the notification window.
- 4) Tap the notification bar to enter the USB Preferences screen. On this screen, user can set the USB Usage as required. As shown in the below:

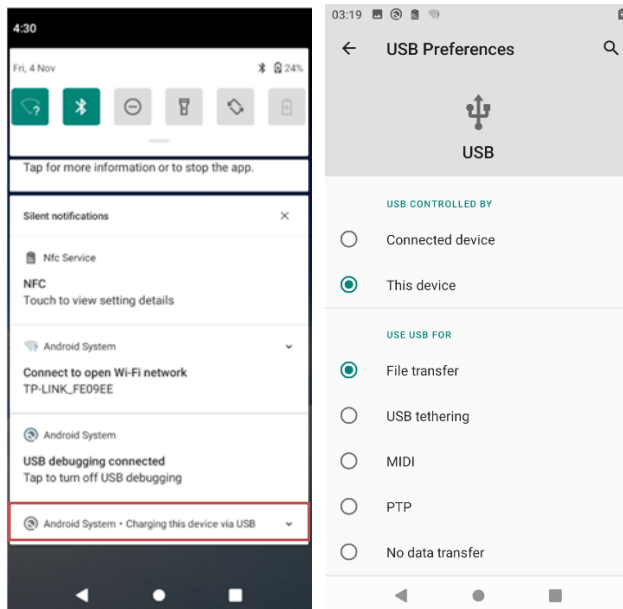



5) To obtain files from the device, select the option for transferring files.

6.2、 Display

The user can change the screen display Settings through Settings - Display

Menu -> Settings -> Display

Menu →  Settings →  Display

1) Brightness

Tap the Brightness menu to display a slider. By moving the slider, you can adjust the brightness of the screen.

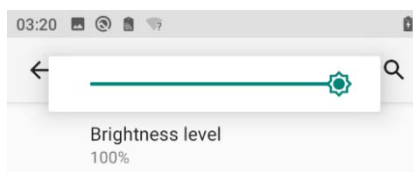

2) Night Mode

In night mode, the screen is dark, which relieves eye strain, makes it easier to read, and reduces the impact on sleep.

3) Automatic backlight

The system can adjust the screen brightness automatically according to the environment and activity. Users can manually move the slider in the "Brightness" setting to help the "Auto Adjust Brightness" function understand the user's preferred brightness.

4) Dark theme background

When the user checks "Dark theme", the home screen will be set to the dark color shown below.

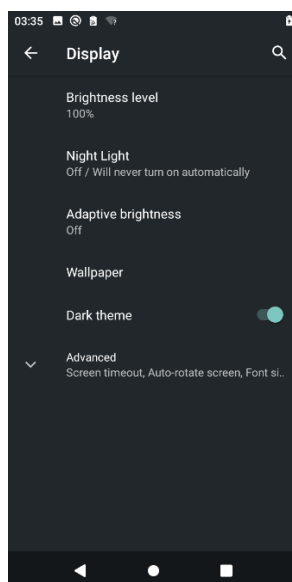

5) Advanced

The user taps the "Advanced" menu and an additional Settings menu will appear below:

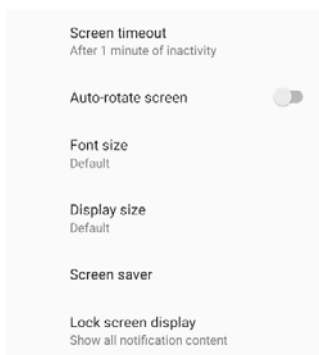

- ✧ Screen timeout: used to set the timeout period for automatic screen lock. If no operation is performed on the device within the specified period, the screen is automatically locked
- ✧ Auto-rotate screen: When checked, the screen display changes with the center of gravity of the device
- ✧ Font size: Used to reduce or enlarge text on the screen
- ✧ Display size: Used to reduce or enlarge the content on the screen. The position of some apps on the screen may change accordingly

6.3、Sound

Users can use Settings - Sound to change the volume and vibration Settings of the device. Menu -> Settings -> Sound

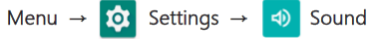

1) Volume Settings

Users can change the media volume, call volume, ringtone volume, and alarm volume by moving the slider.

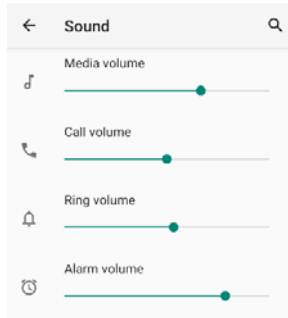

Note: The media volume is used to set the RFID inventory sound and the barcode scanner sound.

2) Advanced

Tap the "Advanced" menu and the following additional Settings menu will appear:

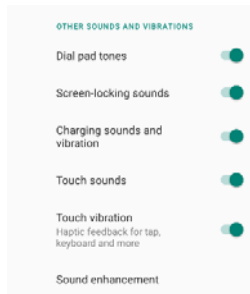

- ✧ Keypad prompt tone
- ✧ Screen-locking sounds
- ✧ Charging sounds and vibration
- ✧ Touch sounds
- ✧ Touch vibration

6.4、System

1) Language and input

✧ Language switch (e.g. adding English): Add a language -> Select **【English】** -> Select

region **【United States】** -> Hold  down/drag the added language English(United States) to the first row, that is, the language switch is successful.

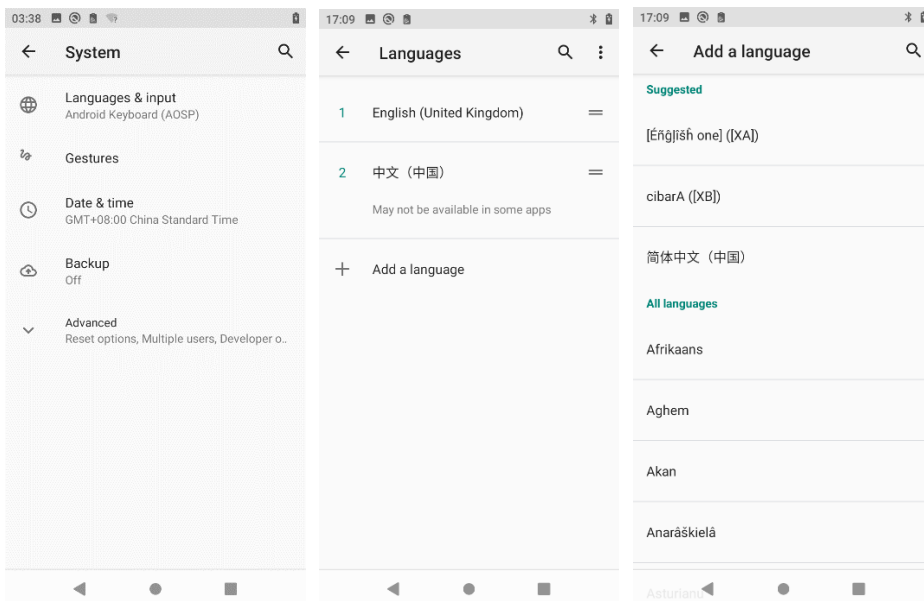

2) Date & time

Setting up the network to provide time or time zone, or manually set the date and time, select time zone, user can choose the time and date display format.

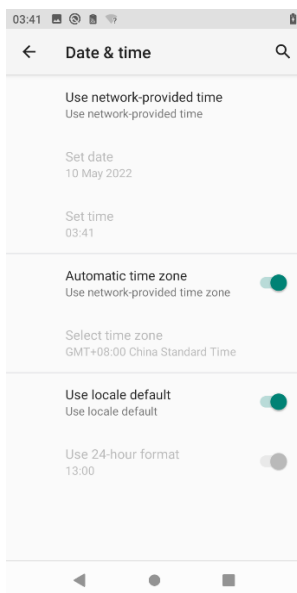

3) Restore factory setting

Advanced -> Reset options -> Erase all data(factory reset).

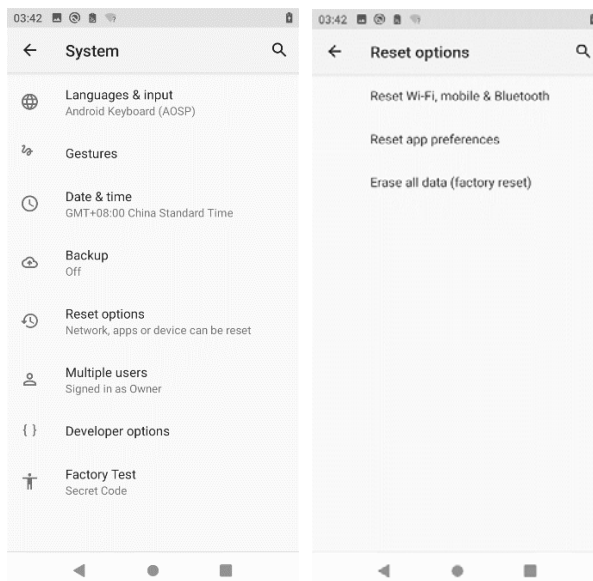

6.5、 Mobile Network

The reader supports mobile data, and Wi-Fi access mobile network.

1 Mobile data

Users can access the network through the mobile data.

- ✧ Insert a valid SIM card into the SIM card slot.
- ✧ User can check the mobile network connection status on the shortcut Settings screen.
- ✧ If no valid SIM card is inserted, No SIM card is displayed. After inserting a valid SIM card, the user can tap "Mobile Data" to launch the mobile network.

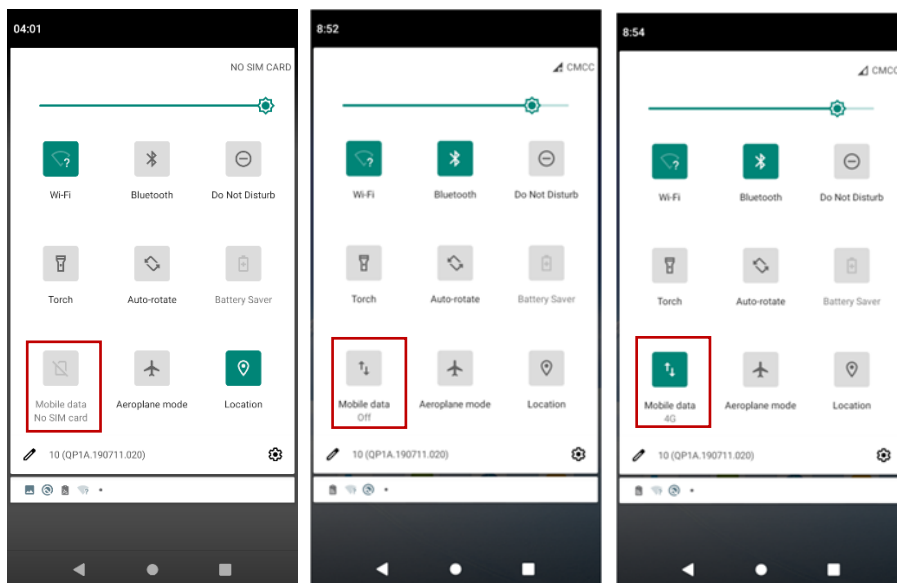

- ✧ I. Press and hold Mobile Data to enter the Mobile Network setting screen. You can also access the mobile network Settings page through the following path.

Menu -> Settings -> Network and Internet -> Mobile Network

Menu →  Settings →  Network & internet →  Mobile Network

II. mobile data

Sets whether to enable the mobile network.

2 Wi-Fi

Users can access the network by connecting to a Wi-Fi endpoint through a WLAN.

I. Wi-Fi state

- ✧ Users can check whether the device is connected to a Wi-Fi endpoint on the shortcut Settings screen.
- ✧ If Wi-Fi is disabled, the shortcut icon is displayed as  .

✧ If Wi-Fi is enabled, the shortcut icon is displayed as .

II. Users can press and hold down Wi-Fi to access the Wi-Fi setting page. Users can also access the setting page through the following path.

Menu -> Settings -> Network and Internet -> Wi-Fi

Menu →  Setting →  Network & internet → 

III. When the Wi-Fi is enabled, the reader automatically scans for and displays Wi-Fi endpoints.

IV. Select and click the target Wi-Fi endpoint, enter the correct Wi-Fi endpoint connection password in the pop-up window, click "connect", the device can access the network through the target Wi-Fi endpoint.

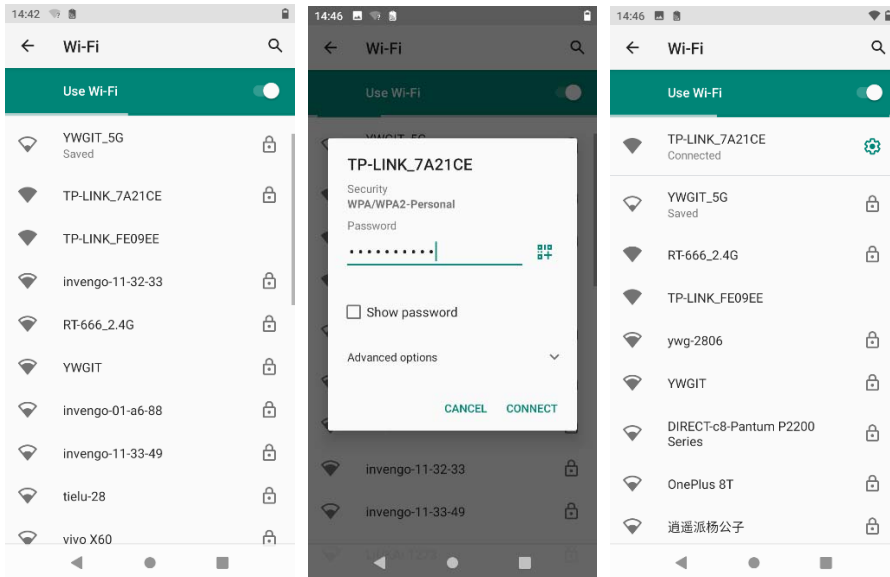

6.6、Bluetooth

Users can connect to Bluetooth devices and transmit data through the Bluetooth function.

1) Bluetooth state

✧ Users can check the Bluetooth connection status in the shortcut setting interface.

✧ When Bluetooth is disabled, the shortcut Settings icon is displayed as .

✧ When Bluetooth is enabled, the shortcut Settings icon is displayed as .

2) Long press Bluetooth to enter the Bluetooth setting screen. You can also go to the Settings page by going to -> Settings -> Connected devices

Menu →  Settings →  Connected devices

- 3) Tap "Pair new device" and the device will automatically search for available devices nearby. Bluetooth devices must request pairing.
- 4) If a nearby device is requesting a pairing, the device name will be in the Available Devices list.
- 5) Select and click the target device to start the connection with the target device. If no exception occurs during the connection, the matching code window is displayed.
- 6) Click "PAIR" to complete the pairing operation with the target device. The target device will be in the Paired list.

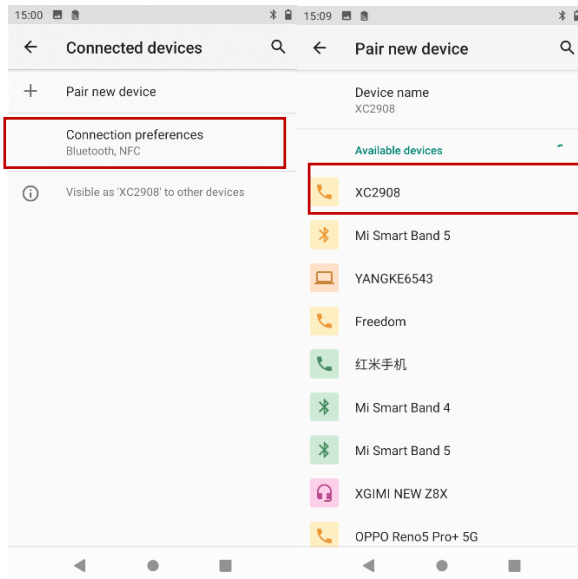

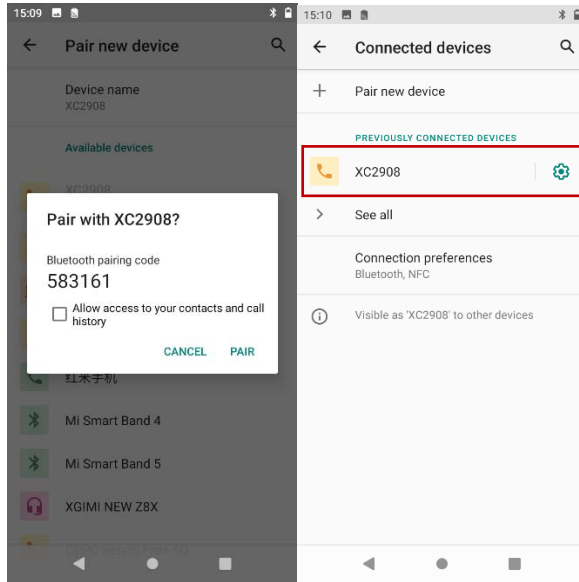

6.7、Ohter

1) Battery

Displays the device battery status and battery management configurations. Users can set the battery power percentage.

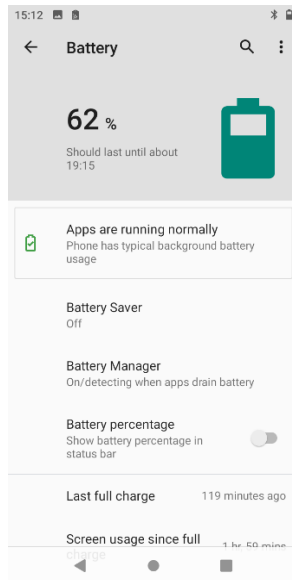

2) Storage

The internal storage space information is displayed.

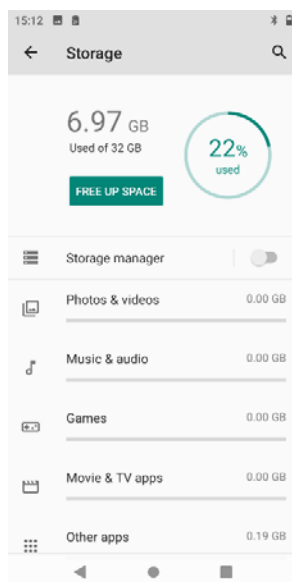

3) About

Users can query the device model, system version, IMEI, WLAN MAC address, and Ethernet MAC address.

4) Enable and disable developer mode

✧ Start Developer mode: Settings -> About Mobile -> Version -> Click **【Version】** 5 times to start developer mode. In Settings -> System -> Advanced, you can see one more item **【Developer Options】** .

✧ Enable Debug mode: Developer Options -> Enable USB Debug.

User Manual of XC2908 Portable Reader

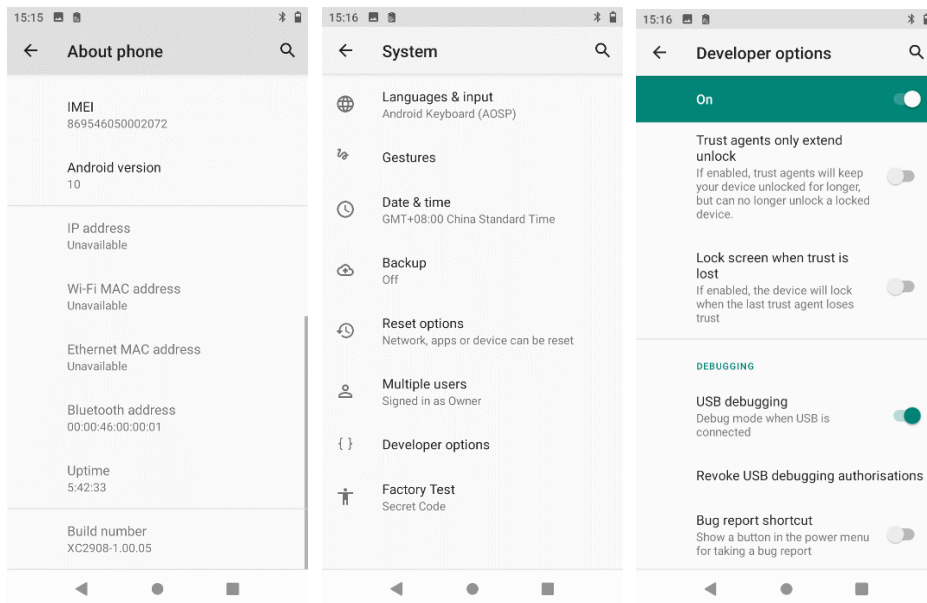

✧ Turn Developer mode off: Developer Options -> Turn it off, turn it on after turn it off, to turn it back on **【USB Debug】** .

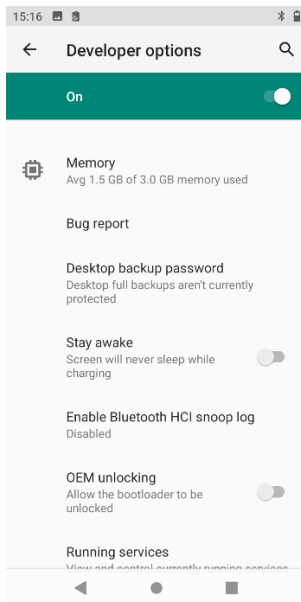

7、 Other optional modules

7.1、 Camera

The reader supports optional front camera and rear camera.

The front-facing camera supports 5 or 8 megapixels

The rear camera supports 13 or 16 megapixels and can be used to take photos.

Brightness, resolution and screen capture can be adjusted. At the same time, the rear camera supports autofocus and flash function.

7.2、 NFC & other UHF RFID

Frequency: 13.56MHz

Protocol: ISO14443A/B, ISO15693

Scan distance: 0-4cm(Related to labels and work environment)

Notice

Before using this function module, ensure that the equipment you purchase has been installed with NFC and other UHF RFID modules; If it is not installed, contact relevant personnel for further support.

8、 Announcements

8.1、 Description of Power Saving

In order to improve the battery life of the reader and enable users to better control the communication module to run for a long time, the device adopts a flexible power control scheme. Please follow the following suggestions according to your actual application.

① power consumption control: The reader can be set to automatically enter the power saving standby state of time. Enter the standby mode by setting the automatic sleep time (if no operation is performed within a certain period of time, it will automatically enter the standby mode). The setting method is as follows: Settings ->Display->Advanced ->Screen Timeout. Users can also enter standby mode by pressing the power button on the right.

②modular control: In standby mode, all modules are powered off, and the system is close to shutdown.



Note that if you want to prolong the normal service time of the device, it is recommended to charge it at any time when the idle time is long if the conditions allow.

8.2、 Exception Declaration

User Manual of XC2908 Portable Reader

If the reader suddenly fails to run, you must restart the device. Press and hold the power button on the right of the device for 10 seconds. The system automatically restarts.

9、 Daily Maintenance and FAQ

9.1、 Daily Maintenance

The reader must be stored in a dry and cool place, the temperature range is between 10℃ and 40 ℃, and avoid contact with corrosive substances, away from fire and heat sources (refer to chapter 10.2 ‘storage requirements’).



Because lithium battery itself has self-discharge characteristics, if you do not use the device for a long time (not less than 1 month), it is recommended that you store the device separately (40% of the power is the most suitable for long-term storage, if conditions should be charged and discharged every three months).

9.2、 FAQ

This section describes how to handle common problems or abnormal phenomena when using the XC2908 Portable reader.

- **What is "reboot" and how do I perform the "reboot" operation**

- ☆ Reboot is the most common system startup mode. It forcibly powers off the system and then restarts the system.

- **No backlight**

- ☆ Check whether the "backlight adjustment" button is clicked to the lowest.

- ☆ Check whether the power button is pressed.

- **no sound**

- ☆ check whether the system volume is set to the lowest.

- **The reader displays a black screen, and there is no response when users click the screen**

- ☆ If the system is in standby state, press the power button to wake up the system.

- **If the power adapter is plugged in, the reader does not start properly (black screen)**

- ☆ black screen:

1、 Check whether the power adapter is tightly inserted. It may be that the battery is low. It will take a few minutes to display.

2、 Check whether the PC is connected to the device through the USB cable. If yes, wait a few minutes.

● **Unable to read tags**

☆ Check whether the power configuration is normal.

☆ Check whether the electronic label is within the valid range of the device.

☆ Please confirm whether there is a space RF signal interference problem.

● **Can't write tags**

☆ Check whether the power configuration is normal.

☆ Check whether the electronic label is within the valid range of the device.

☆ Please check whether the data area of the electronic tag is locked.

☆ Please ensure that the parameters of the write command are correctly configured.

☆ Please confirm whether there is a space RF signal interference problem.

● **Why is the write label distance closer than the read label distance**

☆ This is determined by the characteristics of RFID technology itself. The energy required for tag writing is much greater than that of tag reading, so the distance and success rate of tag writing are lower than that of tag reading.

● **Why is there a big difference in the read distance between different labels**

☆ This is determined by the characteristics of RFID technology itself. Different tag chips and their packaging media make the tags have completely different sensitivities to readers, so the operation distance and success rate are also completely different.

For users can not solve the problem by themselves, please contact us to discuss maintenance matters, see after-sales service information.

9.3、 Radio Frequency Communication Optimization

In general, the system performance of the equipment that uses radio technology to communicate is very sensitive to signal interference and attenuation. This chapter gives some suggestions on the optimization of RF communication between XC2908 Portable reader and electronic tag.

9.3.1、Signal Interference

Signal interference refers to radio frequency (RF) signals that cause interference when information is exchanged between a Portable reader and an electronic tag. Signal interference can seriously reduce the ability of Portable readers to read electronic label data.

The source of interference signal can be:

- ⊗ Radio frequency (RF) systems, such as local radio data network (RF local-area network), adjacent interactive identification system;
- ⊗ RF signals radiated by safety doors, garage doors or other devices;
- ⊗ Other radio frequency (RF) radiation sources.

In the presence of radio frequency (RF) interference or noise, the performance of the Portable reader (exchanging data information with the electronic tag) is significantly degraded. A Portable reader can receive only one signal at any time, and by itself does not have the ability to distinguish unwanted ‘noise’ from desired ‘useful RF signals’.

9.3.2、Signal Attenuation/Reflection

Signal attenuation refers to the natural attenuation of signal strength with distance, and can also be the attenuation caused by obstacles encountered in the transmission path of the signal.

Examples of possible obstacles to RF signal transmission include:

- ⊗ Enclosed Spaces containing concrete walls, floors and ceilings.
- ⊗ A metal surface surrounding an antenna or tag.
- ⊗ Water or other liquid surrounding the antenna or tag;

Almost EVERY object (furniture or partition) in the path of an RF signal will attenuate the signal to some degree. By carefully adjusting the location of the antenna, the attenuation of the RF signal due to obstacles can be minimized.

Reflection from the metal or metallized surface behind the tag can also affect signal attenuation. In some cases, the effect can be to increase the reading distance slightly, while also creating blind spots in the reading area. When the electronic tag is in these blind spots, the communication between it and the Portable reader will be poor.

In general, it is not possible to accurately predict the performance of a Portable reader

system in any given environment (this is due to the complexity of electromagnetic radiation, including the frequency stability of the signal source, antenna pattern and antenna sidelobe problems, ambient factors, etc.). However, some suggestions given below have certain guiding significance for optimizing system performance in specific environment and application situations.

- ☞ Consider the radio frequency (RF) characteristics of the environment, including building materials, office hours, window and plumbing configurations. Radio frequency (RF) field patterns, reading distances may be affected by the proximity of metal objects, such as household appliances, equipment, metal frames, etc.
- ☞ Ensure that the object to be identified, which contains the electronic tag, remains within the valid reading area of the Portable reader for at least 100ms.
- ☞ The optimal antenna length of an electronic tag depends on the non-conducting material in which it is encapsulated or embedded. The basic concept is: Non-conductors embedded (its dielectric constant were greater than general dielectric constant in the air, the resulting media within the effective wavelength is shorter than the effective wavelength) in the air within the electronic label, if the effective length of electricity in the air for adjustment to the best length (and Portable, speaking, reading and writing with reading furthest distance), when puts the nonconductive within, or substrate, The electric length of the tag antenna should be adjusted in the direction of reduction to achieve the same as the best effect in the air; On the contrary, if the effective electric length of the electronic tag antenna is adjusted to the optimal electric length in the non-conductor medium, the optimal electric length in the air should be adjusted to increase the electric length.
- ☞ Do not contact bare, unsealed electronic tags with chemicals. Some chemicals, such as alcohol, have little effect on the electronic label at room temperature, but may have corrosive effect at high temperature.

10、 Transport and Storage

10.1、 Transportation Requirement

The Portable reader meets the requirements specified in the relevant standards for road, railway, air and water transportation.

10.2、 Storage Requirement

The warehouse for long-term storage of Portable readers shall have the following conditions:

- ☞ environment temperature: $-10^{\circ}\text{C} \sim 40^{\circ}\text{C}$.
- ☞ relative humidity: Not more than 80%.
- ☞ No sharp temperature change, no acidic and other harmful gases in the surrounding air.
- ☞ Because the lithium battery itself has self-discharge characteristics, such as long time does not use the equipment (not less than 1 month); It is recommended that you remove the battery from the Portable device and store it separately.

11、Packaging & Unpacking

11.1、Packing

The Portable reader is packed in a box and can be transported in a large turnover box.

11.2、Unpacking

For the convenience of future storage and transportation, please open the package and keep the packing case and packing materials properly.



Please carefully check whether the products and accessories are complete according to the packing list. If there is any discrepancy or damage, please contact our company in time.

12、After-sales

12.1、After-sales Services

When users encounter any problems that you could not solve during use of the Portable reader, please contact the customer service center of our company.

Before contacting the customer Service Center of the company, users are requested to keep the following information on hand:

- ✧ Type of Portable reader.
- ✧ serial number of Portable reader(Located at the bottom of the Portable reader).
- ✧ Any changes made to the Portable reader or tag.
- ✧ Status of RFID demo.

12.2、Other Notes

If the customer service personnel of our company decide that the user should return the reader for repair, the customer service representative will give you a goods return confirmation number RMA (return merchant authorization). Please write this number on the outside of the packaging box of the returned system, also write this number on a piece of paper and put it in the packaging box, so that the article returned by the user will be handled quickly.

When returning the Portable reader for repair, please follow the following steps:

- ✧ Carefully pack the reader and its accessories into the original anti-static foam packaging box. If the original packaging box is no longer available, please select a protective packaging box.
- ✧ Cover the contents in the box with filling materials.
- ✧ Put a note indicating the RMA number in the packaging box.
- ✧ Write the RMA number and the word “Fragile” on the outside of the packaging box.

FCC Caution:

Any Changes or modifications not expressly approved by the party responsible for compliance could void the user's authority to operate the equipment.

This device complies with part 15 of the FCC Rules. Operation is subject to the following two conditions: (1) This device may not cause harmful interference, and (2) this device must accept any interference received, including interference that may cause undesired operation.

IMPORTANT NOTE:

Note: This equipment has been tested and found to comply with the limits for a Class B digital device, pursuant to part 15 of the FCC Rules. These limits are designed to provide reasonable protection against harmful interference in a residential installation. This equipment generates, uses and can radiate radio frequency energy and, if not installed and used in accordance with the instructions, may cause harmful interference to radio communications. However, there is no guarantee that interference will not occur in a particular installation. If this equipment does cause harmful interference to radio or television reception, which can be determined by turning the equipment off and on, the user is encouraged to try to correct the interference by one or more of the following measures:

- Reorient or relocate the receiving antenna.
- Increase the separation between the equipment and receiver.
- Connect the equipment into an outlet on a circuit different from that to which the receiver is connected.
- Consult the dealer or an experienced radio/TV technician for help.

Specific Absorption Rate (SAR) information

SAR tests are conducted using standard operating positions accepted by the FCC with the device transmitting at its highest certified power level in all tested frequency bands, although the SAR is determined at the highest certified power level, the actual SAR level of the device while operating can be well below the maximum value. Before a new device is available for sale to the public, it must be tested and certified to the FCC that it does not exceed the exposure limit established by the FCC, tests for each device are performed in positions and locations as required by the FCC.

For body worn operation, this device has been tested and meets the FCC RF exposure guidelines when used with an accessory designated for this product or when used with an accessory that contains no metal and that positions the device a minimum of 10mm from the body.

Non-compliance with the above restrictions may result in violation of RF exposure guidelines.

Please do not disassemble the prototype, otherwise it will cause the prototype not to work normally.