

FCC Test Report

Report No.: RF180108C15A

FCC ID: TOR-W118

Test Model: W-118

Received Date: Jan. 08, 2018

Test Date: Feb. 22 ~ Mar. 20, 2018

Issued Date: Apr. 17, 2018

Applicant: Mojo Networks, Inc.

Address: 339 N. Bernardo Avenue, Suite #200, Mountain View, California United States 94043

Issued By: Bureau Veritas Consumer Products Services (H.K.) Ltd., Taoyuan Branch

Lab Address: No. 47-2, 14th Ling, Chia Pau Vil., Lin Kou Dist., New Taipei City, Taiwan (R.O.C.)

Test Location: No. 19, Hwa Ya 2nd Rd., Wen Hwa Vil., Kwei Shan Dist., Taoyuan City 33383, TAIWAN (R.O.C.)

**FCC Registration /
Designation Number:** 788550 / TW0003



This report is for your exclusive use. Any copying or replication of this report to or for any other person or entity, or use of our name or trademark, is permitted only with our prior written permission. This report sets forth our findings solely with respect to the test samples identified herein. The results set forth in this report are not indicative or representative of the quality or characteristics of the lot from which a test sample was taken or any similar or identical product specifically and expressly noted. Our report includes all of the tests requested by you and the results thereof based upon the information that you provided to us. You have 60 days from date of issuance of this report to notify us of any material error or omission caused by our negligence, provided, however, that such notice shall be in writing and shall specifically address the issue you wish to raise. A failure to raise such issue within the prescribed time shall constitute your unqualified acceptance of the completeness of this report, the tests conducted and the correctness of the report contents. Unless specific mention, the uncertainty of measurement has been explicitly taken into account to declare the compliance or non-compliance to the specification. The report must not be used by the client to claim product certification, approval, or endorsement by TAF or any government agencies.

Table of Contents

Release Control Record	4
1 Certificate of Conformity	5
2 Summary of Test Results	6
2.1 Measurement Uncertainty.....	6
2.2 Modification Record.....	6
3 General Information	7
3.1 General Description of EUT.....	7
3.2 Description of Test Modes.....	9
3.2.1 Test Mode Applicability and Tested Channel Detail.....	10
3.3 Duty Cycle of Test Signal.....	12
3.4 Description of Support Units.....	14
3.4.1 Configuration of System under Test.....	14
3.5 General Description of Applied Standards.....	15
4 Test Types and Results	16
4.1 Radiated Emission and Bandedge Measurement.....	16
4.1.1 Limits of Radiated Emission and Bandedge Measurement.....	16
4.1.2 Test Instruments.....	17
4.1.3 Test Procedures.....	18
4.1.4 Deviation from Test Standard.....	19
4.1.5 Test Set Up.....	19
4.1.6 EUT Operating Conditions.....	20
4.1.7 Test Results.....	21
4.2 Conducted Emission Measurement.....	65
4.2.1 Limits of Conducted Emission Measurement.....	65
4.2.2 Test Instruments.....	65
4.2.3 Test Procedures.....	66
4.2.4 Deviation from Test Standard.....	66
4.2.5 Test Setup.....	66
4.2.6 EUT Operating Conditions.....	66
4.2.7 Test Results.....	67
4.3 Transmit Power Measurement.....	75
4.3.1 Limits of Transmit Power Measurement.....	75
4.3.2 Test Setup.....	75
4.3.3 Test Instruments.....	76
4.3.4 Test Procedure.....	76
4.3.5 Deviation from Test Standard.....	76
4.3.6 EUT Operating Conditions.....	76
4.3.7 Test Result.....	77
4.4 Occupied Bandwidth Measurement.....	92
4.4.1 Test Setup.....	92
4.4.2 Test Instruments.....	92
4.4.3 Test Procedure.....	92
4.4.4 Test Result.....	93
4.5 Peak Power Spectral Density Measurement.....	97
4.5.1 Limits of Peak Power Spectral Density Measurement.....	97
4.5.2 Test Setup.....	97
4.5.3 Test Instruments.....	97
4.5.4 Test Procedures.....	98
4.5.5 Deviation from Test Standard.....	98
4.5.6 EUT Operating Conditions.....	98
4.5.7 Test Results.....	99
4.6 Frequency Stability.....	105
4.6.1 Limits of Frequency Stability Measurement.....	105

4.6.2 Test Setup.....	105
4.6.3 Test Instruments	105
4.6.4 Test Procedure	105
4.6.5 Deviation from Test Standard	105
4.6.6 EUT Operating Condition	105
4.6.7 Test Results	106
5 Pictures of Test Arrangements.....	107
Appendix – Information on the Testing Laboratories	108

Release Control Record

Issue No.	Description	Date Issued
RF180108C15A	Original release.	Apr. 17, 2018

1 Certificate of Conformity

Product: Wall Jack Access Point

Brand: Mojo

Test Model: W-118

Sample Status: Engineering sample

Applicant: Mojo Networks, Inc.

Test Date: Feb. 22 ~ Mar. 20, 2018

Standards: 47 CFR FCC Part 15, Subpart E (Section 15.407)
ANSI C63.10:2013

The above equipment has been tested by **Bureau Veritas Consumer Products Services (H.K.) Ltd., Taoyuan Branch**, and found compliance with the requirement of the above standards. The test record, data evaluation & Equipment Under Test (EUT) configurations represented herein are true and accurate accounts of the measurements of the sample's RF characteristics under the conditions specified in this report.

Prepared by : Pettie Chen, **Date:** Apr. 17, 2018
Pettie Chen / Senior Specialist

Approved by : Bruce Chen, **Date:** Apr. 17, 2018
Bruce Chen / Project Engineer

2 Summary of Test Results

47 CFR FCC Part 15, Subpart E (Section 15.407)			
FCC Clause	Test Item	Result	Remarks
15.407(b)(6)	AC Power Conducted Emissions	Pass	Meet the requirement of limit. Minimum passing margin is -5.40dB at 0.16172MHz.
15.407(b)(1/2/3/4(i/ii)/6)	Radiated Emissions & Band Edge Measurement	Pass	Meet the requirement of limit. Minimum passing margin is -1.1dB at 5725.00MHz.
15.407(a)(1/2/3)	Max Average Transmit Power	Pass	Meet the requirement of limit.
---	Occupied Bandwidth Measurement	Pass	Meet the requirement of limit.
15.407(a)(1/2/3)	Peak Power Spectral Density	Pass	Meet the requirement of limit. (U-NII-3 Band only)
15.407(e)	6dB bandwidth	Pass	Meet the requirement of limit.
15.407(g)	Frequency Stability	Pass	Meet the requirement of limit.
15.203	Antenna Requirement	Pass	Antenna connector is UFL not a standard connector.

2.1 Measurement Uncertainty

Where relevant, the following measurement uncertainty levels have been estimated for tests performed on the EUT as specified in CISPR 16-4-2:

Measurement	Frequency	Expanded Uncertainty (k=2) (±)
Conducted Emissions at mains ports	150kHz ~ 30MHz	2.94 dB
Radiated Emissions up to 1 GHz	30MHz ~ 200MHz	3.86 dB
	200MHz ~ 1000MHz	3.87 dB
Radiated Emissions above 1 GHz	1GHz ~ 18GHz	2.29 dB
	18GHz ~ 40GHz	2.29 dB

2.2 Modification Record

There were no modifications required for compliance.

3 General Information

3.1 General Description of EUT

Product	Wall Jack Access Point
Brand	Mojo
Test Model	W-118
Sample Status	Engineering sample
Power Supply Rating	12Vdc from Adapter 54Vdc from POE
Modulation Type	256QAM, 64QAM, 16QAM, QPSK, BPSK
Modulation Technology	OFDM
Transfer Rate	802.11a: 54/48/36/24/18/12/9/6Mbps 802.11n: up to 300Mbps 802.11ac: up to 867Mbps
Operating Frequency	5260~5320MHz, 5500~5700MHz
Number of Channel	5260~5320MHz: 802.11a, 802.11n (HT20), 802.11ac (VHT20): 4 802.11n (HT40), 802.11ac (VHT40): 2 802.11ac (VHT80): 1 5500~5700MHz: 802.11a, 802.11n (HT20), 802.11ac (VHT20): 11 802.11n (HT40), 802.11ac (VHT40): 5 802.11ac (VHT80): 2
Output Power	Radio 2: CDD Mode: 5260~5320MHz: 192.064mW 5500~5700MHz: 237.718mW Beamforming Mode: 5260~5320MHz: 95.940mW 5500~5700MHz: 118.850mW Radio 3: 5260~5320MHz: 53.888mW 5500~5700MHz: 55.371mW
Antenna Type	Refer to note
Antenna Connector	Refer to note
Accessory Device	NA
Cable Supplied	NA

Note:

1. This report is prepared for FCC class II permissive change. This report is a supplementary report to the original BVADT report no.: RF180108C15. Difference compared with the original report is adding 5260~5320MHz and 5500~5700MHz band. Therefore, the EUT was re-tested and presented in the test report.

2. The EUT incorporates a MIMO function. Physically, the EUT provides 2 completed transmitters and 2 receivers.

Modulation Mode	TX Function	Beamforming Mode	Remark
802.11a	2TX	Not Support	Radio 2
802.11n (HT20)	2TX	Support	
802.11n (HT40)	2TX	Support	
802.11ac (VHT20)	2TX	Support	
802.11ac (VHT40)	2TX	Support	
802.11ac (VHT80)	2TX	Support	
802.11a	2TX	Not Support	Radio 3
802.11n (HT20)	2TX	Not Support	
802.11n (HT40)	2TX	Not Support	
802.11ac (VHT20)	2TX	Not Support	
802.11ac (VHT40)	2TX	Not Support	
802.11ac (VHT80)	2TX	Not Support	

* The modulation and bandwidth are similar for 802.11n mode for HT20/HT40 and 802.11ac mode for VHT20/VHT40. After pre-testing, 802.11ac (VHT20/VHT40) power is lower than 802.11n (HT20/HT40), therefore 802.11n (HT20/HT40) is the worst case to representative mode in test report. (Final test mode refer section 3.2.1)

* For 802.11n and 802.11ac, CDD mode and Beamforming mode are presented in power output test item. For other test items, CDD mode is the worst case for final tests after pretesting.

3. The EUT consumes power from following Adapter and POE. (Support unit only)

Adapter	
Brand	Powertron Electronics Corp.
Model	PA1024-120IB200
Input Power	100-240Vac, 50-60Hz, 0.6A
Output Power	12Vdc / 2.0A 24W Max
Power Cord	1.5m non-shielded cable with one core 0.5m non-shielded cable without core

POE	
Brand	EnGenius
Model	EPA5006GAT
Input Power	100-240Vac, 50-60Hz, 0.8A
Output Power	54Vdc, 0.6A

4. The EUT uses following antennas.

Type	PIFA						PIFA
Connector	IPEX						-
Radio	1		2		3		BT/Zigbee
Frequency (MHz)	2400-2500		5150-5850		2400-2500 & 5150-5850		2400-2500
Antenna	1	2	3	4	5	6	BT/Zigbee
Gain (dBi)	3.67	4.31	5.72	5.99	2.51 / 4.83	2.78 / 4.80	2.76

5. Spurious emission of the simultaneous operation mode as below and the test data please refer to report no.: RF180108C15A-1.

No	Mode
1	Radio 1 + Radio 2 + Radio 3(2.4GHz) + BT LE
2	Radio 1 + Radio 3(5GHz) + BT LE
3	Radio 1 + Radio 2 + Radio 3(2.4GHz)+ Zigbee
4	Radio 1 + Radio 3(5GHz) + Zigbee

*The Radio 2 and Radio 3(5GHz) cannot transmit simultaneously.

6. The above EUT information is declared by manufacturer and for more detailed features description, please refer to the manufacturer's specifications or user's manual.

3.2 Description of Test Modes

5260~5320MHz:

4 channels are provided for 802.11a, 802.11n (HT20), 802.11ac (VHT20):

Channel	Frequency	Channel	Frequency
52	5260 MHz	60	5300 MHz
56	5280 MHz	64	5320 MHz

2 channels are provided for 802.11n (HT40), 802.11ac (VHT40):

Channel	Frequency	Channel	Frequency
54	5270 MHz	62	5310 MHz

1 channel is provided for 802.11ac (VHT80):

Channel	Frequency
58	5290MHz

5500~5700MHz:

11 channels are provided for 802.11a, 802.11n (HT20), 802.11ac (VHT20):

Channel	Frequency	Channel	Frequency
100	5500 MHz	124	5620 MHz
104	5520 MHz	128	5640 MHz
108	5540 MHz	132	5660 MHz
112	5560 MHz	136	5680 MHz
116	5580 MHz	140	5700 MHz
120	5600 MHz		

5 channels are provided for 802.11n (HT40), 802.11ac (VHT40):

Channel	Frequency	Channel	Frequency
102	5510 MHz	126	5630 MHz
110	5550 MHz	134	5670 MHz
118	5590 MHz		

2 channels are provided for 802.11ac (VHT80):

Channel	Frequency	Channel	Frequency
106	5530 MHz	122	5610 MHz

3.2.1 Test Mode Applicability and Tested Channel Detail

EUT Configure Mode	Applicable to				Description	
	RE \geq 1G	RE<1G	PLC	APCM	Radio	Power
A	√	√	√	√	Radio 2	Power from adapter
B	-	√	√	-		Power from PoE
C	√	√	√	√	Radio 3	Power from adapter
D	-	√	√	-		Power from PoE

Where RE \geq 1G: Radiated Emission above 1GHz & Bandedge Measurement
 RE<1G: Radiated Emission below 1GHz
 PLC: Power Line Conducted Emission
 APCM: Antenna Port Conducted Measurement

Note:

- The EUT had been pre-tested on the positioned of each 3 axis. The worst case was found when positioned on **Y-plane (For Test Mode A, B), Z-plane (For Test Mode C, D)**.
- "-" means no effect.

Radiated Emission Test (Above 1GHz):

- Pre-Scan has been conducted to determine the worst-case mode from all possible combinations between available modulations, data rates and antenna ports (if EUT with antenna diversity architecture).
- Following channel(s) was (were) selected for the final test as listed below.

EUT Configure Mode	Mode	Frequency Band (MHz)	Available Channel	Tested Channel	Modulation Technology	Data Rate (Mbps)
A, C	802.11a	5260-5320	52 to 64	52, 60, 64	OFDM	6.0
	802.11n (HT20)		52 to 64	52, 60, 64	OFDM	6.5
	802.11n (HT40)		54 to 62	54, 62	OFDM	13.5
	802.11ac (VHT80)		58	58	OFDM	58.5
A, C	802.11a	5500-5700	100 to 140	100, 116, 140	OFDM	6.0
	802.11n (HT20)		100 to 140	100, 116, 140	OFDM	6.5
	802.11n (HT40)		102 to 134	102, 110, 134	OFDM	13.5
	802.11ac (VHT80)		106, 122	106, 122	OFDM	58.5

Radiated Emission Test (Below 1GHz):

- Pre-Scan has been conducted to determine the worst-case mode from all possible combinations between available modulations, data rates and antenna ports (if EUT with antenna diversity architecture).
- Following channel(s) was (were) selected for the final test as listed below.

EUT Configure Mode	Mode	Frequency Band (MHz)	Available Channel	Tested Channel	Modulation Technology	Data Rate (Mbps)
A, B, C, D	802.11a	5260-5320	52 to 64	52	OFDM	6.0
		5500-5700	100 to 140		OFDM	6.0

Power Line Conducted Emission Test:

- Pre-Scan has been conducted to determine the worst-case mode from all possible combinations between available modulations, data rates and antenna ports (if EUT with antenna diversity architecture).
- Following channel(s) was (were) selected for the final test as listed below.

EUT Configure Mode	Mode	Frequency Band (MHz)	Available Channel	Tested Channel	Modulation Technology	Data Rate (Mbps)
A, B, C, D	802.11a	5260-5320	52 to 64	52	OFDM	6.0
		5500-5700	100 to 140		OFDM	6.0

Antenna Port Conducted Measurement:

- This item includes all test value of each mode, but only includes spectrum plot of worst value of each mode.
- Pre-Scan has been conducted to determine the worst-case mode from all possible combinations between available modulations, data rates and antenna ports (if EUT with antenna diversity architecture).
- Following channel(s) was (were) selected for the final test as listed below.

EUT Configure Mode	Mode	Frequency Band (MHz)	Available Channel	Tested Channel	Modulation Technology	Data Rate (Mbps)
A, C	802.11a	5260-5320	52 to 64	52, 60, 64	OFDM	6.0
	802.11n (HT20)		52 to 64	52, 60, 64	OFDM	6.5
	802.11n (HT40)		54 to 62	54, 62	OFDM	13.5
	802.11ac (VHT80)		58	58	OFDM	58.5
A, C	802.11a	5500-5700	100 to 140	100, 116, 140	OFDM	6.0
	802.11n (HT20)		100 to 140	100, 116, 140	OFDM	6.5
	802.11n (HT40)		102 to 134	102, 110, 134	OFDM	13.5
	802.11ac (VHT80)		106, 122	106, 122	OFDM	58.5

Test Condition:

Applicable to	Environmental Conditions	Input Power	Tested by
RE \geq 1G	20 deg. C, 68% RH 22 deg. C, 68% RH	120Vac, 60Hz	Adair Peng Jones Chang
RE $<$ 1G	22 deg. C, 68% RH	120Vac, 60Hz	Adair Peng
PLC	25 deg. C, 75% RH	120Vac, 60Hz	Noah Chang
APCM	25 deg. C, 60% RH	120Vac, 60Hz	Chris Lin

3.3 Duty Cycle of Test Signal

Test Mode A

Duty cycle of test signal is < 98%, duty factor is required.

802.11a: Duty cycle = $2.056/2.136 = 0.963$, Duty factor = $10 * \log(1/0.963) = 0.17$

802.11n (HT20): Duty cycle = $4.995/5.078 = 0.984$

802.11n (HT40): Duty cycle = $2.417/2.506 = 0.964$, Duty factor = $10 * \log(1/0.964) = 0.16$

802.11ac (VHT80): Duty cycle = $1.14/1.23 = 0.927$, Duty factor = $10 * \log(1/0.927) = 0.33$



Test Mode C

Duty cycle of test signal is < 98%, duty factor is required.

802.11a: Duty cycle = $2.054/2.130 = 0.964$, Duty factor = $10 * \log(1/0.964) = 0.16$

802.11n (HT20): Duty cycle = $1.915/1.993 = 0.961$, Duty factor = $10 * \log(1/0.961) = 0.17$

802.11n (HT40): Duty cycle = $0.942/1.029 = 0.915$, Duty factor = $10 * \log(1/0.915) = 0.38$

802.11ac (VHT80): Duty cycle = $0.462/0.539 = 0.857$, Duty factor = $10 * \log(1/0.857) = 0.67$



3.4 Description of Support Units

The EUT has been tested as an independent unit together with other necessary accessories or support units. The following support units or accessories were used to form a representative test configuration during the tests.

ID	Product	Brand	Model No.	Serial No.	FCC ID	Remarks
A.	Notebook	Lenovo	80Q7	PF0KUGU6	FCC DoC Approved	-
B.	Adapter	Powertron	PA1024-120IB200	NA	NA	Provided by manufacturer
C.	Load	NA	NA	NA	NA	-
D.	POE	EnGenius	EPA5006GAT	NA	NA	Provided by manufacturer

Note:

1. All power cords of the above support units are non-shielded (1.8m).
2. Item A acted as a communication partner to transfer data.

ID	Descriptions	Qty.	Length (m)	Shielding (Yes/No)	Cores (Qty.)	Remarks
1.	RJ45, Cat5e	1	10	N	0	-
2.	RJ45, Cat5e	4	3	N	0	-
3.	Power Cord	1	1.0	N	0	-
4.	RJ45, Cat5e	1	3	N	0	-

Note: The core(s) is(are) originally attached to the cable(s).

3.4.1 Configuration of System under Test

Test Mode A, C

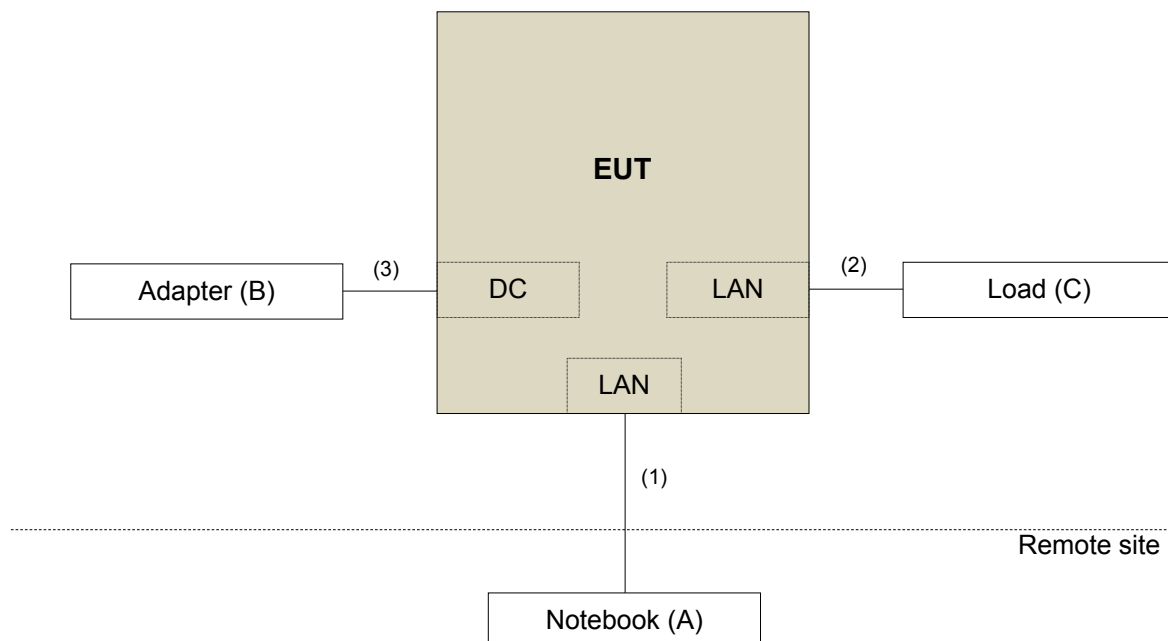

Test Mode B, D

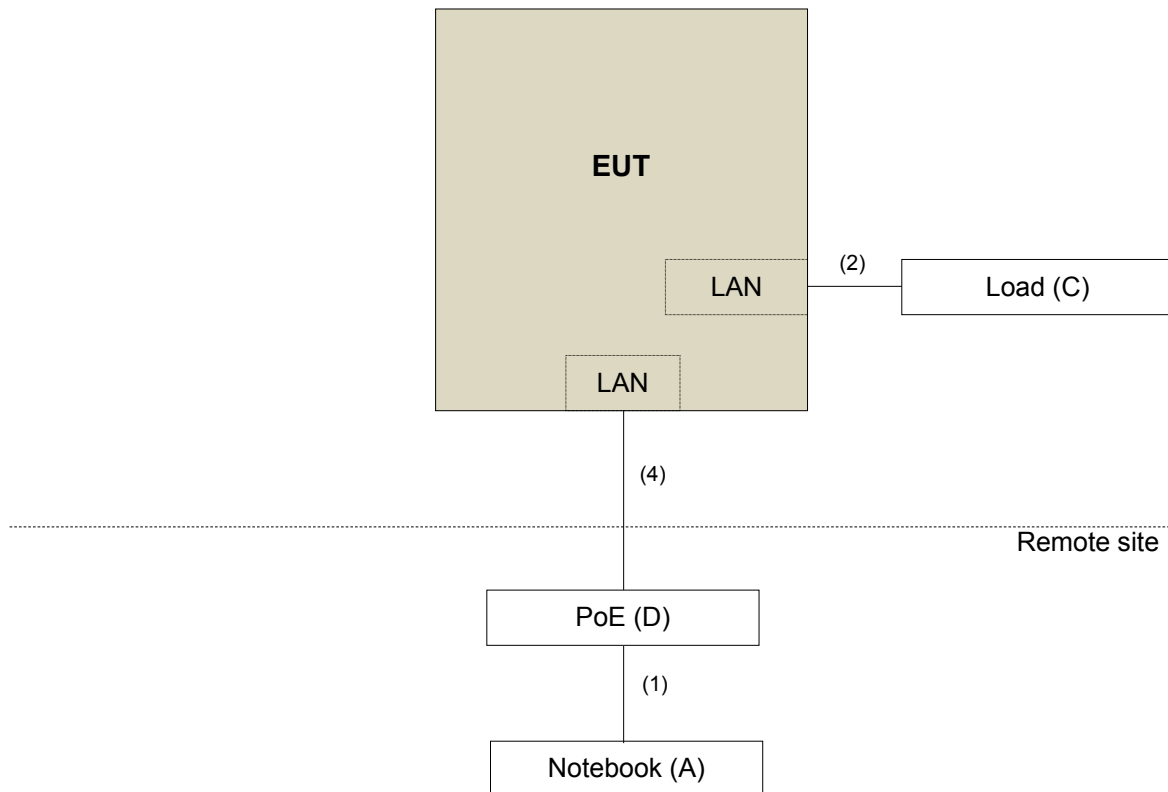

3.5 General Description of Applied Standards

The EUT is a RF Product. According to the specifications of the manufacturer, it must comply with the requirements of the following standards:

FCC Part 15, Subpart E (15.407)

KDB 789033 D02 General UNII Test Procedure New Rules v02r01

KDB 662911 D01 Multiple Transmitter Output v02r01

ANSI C63.10:2013

All test items have been performed and recorded as per the above standards.

4 Test Types and Results

4.1 Radiated Emission and Bandedge Measurement

4.1.1 Limits of Radiated Emission and Bandedge Measurement

Radiated emissions which fall in the restricted bands must comply with the radiated emission limits specified as below table.

Frequencies (MHz)	Field Strength (microvolts/meter)	Measurement Distance (meters)
0.009 ~ 0.490	2400/F(kHz)	300
0.490 ~ 1.705	24000/F(kHz)	30
1.705 ~ 30.0	30	30
30 ~ 88	100	3
88 ~ 216	150	3
216 ~ 960	200	3
Above 960	500	3

NOTE:

- The lower limit shall apply at the transition frequencies.
- Emission level (dBuV/m) = 20 log Emission level (uV/m).
- For frequencies above 1000MHz, the field strength limits are based on average detector, however, the peak field strength of any emission shall not exceed the maximum permitted average limits, specified above by more than 20dB under any condition of modulation.

Limits of unwanted emission out of the restricted bands

Applicable To		Limit	
789033 D02 General UNII Test Procedure New Rules v02r01		Field Strength at 3m	
		PK: 74 (dBµV/m)	AV: 54 (dBµV/m)
Frequency Band	Applicable To	EIRP Limit	Equivalent Field Strength at 3m
5150~5250 MHz	15.407(b)(1)	PK: -27 (dBm/MHz)	PK: 68.2(dBµV/m)
5250~5350 MHz	15.407(b)(2)		
5470~5725 MHz	15.407(b)(3)		
5725~5850 MHz	<input type="checkbox"/> 15.407(b)(4)(i)	PK: -27 (dBm/MHz) ^{*1} PK: 10 (dBm/MHz) ^{*2} PK: 15.6 (dBm/MHz) ^{*3} PK: 27 (dBm/MHz) ^{*4}	PK: 68.2(dBµV/m) ^{*1} PK: 105.2 (dBµV/m) ^{*2} PK: 110.8(dBµV/m) ^{*3} PK: 122.2 (dBµV/m) ^{*4}
	<input type="checkbox"/> 15.407(b)(4)(ii)	Emission limits in section 15.247(d)	
^{*1} beyond 75 MHz or more above of the band edge.		^{*2} below the band edge increasing linearly to 10 dBm/MHz at 25 MHz above.	
^{*3} below the band edge increasing linearly to a level of 15.6 dBm/MHz at 5 MHz above.		^{*4} from 5 MHz above or below the band edge increasing linearly to a level of 27 dBm/MHz at the band edge.	

Note: The following formula is used to convert the equipment isotropic radiated power (eirp) to field strength:

$$E = \frac{1000000 \sqrt{30P}}{3} \mu\text{V/m, where P is the eirp (Watts).}$$

4.1.2 Test Instruments

Description & Manufacturer	Model No.	Serial No.	Cal. Date	Cal. Due
Test Receiver ROHDE & SCHWARZ	ESIB7	100187	May 02, 2017	May 01, 2018
Spectrum Analyzer ROHDE & SCHWARZ	FSP40	100041	Dec. 12, 2017	Dec. 11, 2018
BILOG Antenna SCHWARZBECK	VULB9168	9168-171	Dec. 11, 2017	Dec. 10, 2018
HORN Antenna SCHWARZBECK	9120D	209	Dec. 13, 2017	Dec. 12, 2018
HORN Antenna SCHWARZBECK	BBHA 9170	BBHA9170241	Dec. 01, 2017	Nov. 30, 2018
Loop Antenna EMCI	EM-6879	269	Aug. 11, 2017	Aug. 10, 2018
Preamplifier Agilent (Below 1GHz)	8447D	2944A10738	Aug. 21, 2017	Aug. 20, 2018
Preamplifier Agilent (Above 1GHz)	8449B	3008A02465	Apr. 05, 2017	Apr. 04, 2018
RF signal cable HUBER+SUHNER	SUCOFLEX 104	Cable-CH3-03 (223653/4)	Aug. 21, 2017	Aug. 20, 2018
RF signal cable HUBER+SUHNER& EMCI	SUCOFLEX 104&EMC104-SM-S M-8000	Cable-CH3-03 (309224+170907)	Sep.11, 2017	Sep. 10, 2018
Software BV ADT	ADT_Radiated_ V7.6.15.9.4	NA	NA	NA
Antenna Tower inn-co GmbH	MA 4000	013303	NA	NA
Antenna Tower Controller BV ADT	AT100	AT93021702	NA	NA
Turn Table BV ADT	TT100	TT93021702	NA	NA
Turn Table Controller BV ADT	SC100	SC93021702	NA	NA
Boresight Antenna Fixture	FBA-01	FBA-SIP01	NA	NA
High Speed Peak Power Meter	ML2495A	0824012	Aug. 18, 2017	Aug. 17, 2018
Power Sensor	MA2411B	0738171	Aug. 18, 2017	Aug. 17, 2018
26GHz ~ 40GHz Amplifier Agilent	8449B	3008A1960	Aug. 08, 2017	Aug. 07, 2018

- Note:
1. The calibration interval of the above test instruments is 12 months and the calibrations are traceable to NML/ROC and NIST/USA.
 2. The test was performed in HwaYa Chamber 3.
 3. The horn antenna and preamplifier (model: 8449B) are used only for the measurement of emission frequency above 1GHz if tested.
 4. The FCC Designation Number is TW0003. The number will be varied with the Lab location and scope as attached.
 5. The IC Site Registration No. is IC 7450F-3.

4.1.3 Test Procedures

For Radiated emission below 30MHz

- a. The EUT was placed on the top of a rotating table 0.8 meters above the ground at a 3 meter chamber room. The table was rotated 360 degrees to determine the position of the highest radiation.
- b. The EUT was set 3 meters away from the interference-receiving antenna, which was mounted on the top of a variable-height antenna tower.
- c. Both X and Y axes of the antenna are set to make the measurement.
- d. For each suspected emission, the EUT was arranged to its worst case and the rotatable table was turned from 0 degrees to 360 degrees to find the maximum reading.
- e. The test-receiver system was set to Quasi-Peak Detect Function and Specified Bandwidth with Maximum Hold Mode.

Note:

1. The resolution bandwidth and video bandwidth of test receiver/spectrum analyzer is 9kHz at frequency below 30MHz.

For Radiated emission above 30MHz

- a. The EUT was placed on the top of a rotating table 0.8 meters (for 30MHz ~ 1GHz) / 1.5 meters (for above 1GHz) above the ground at 3 meter chamber room for test. The table was rotated 360 degrees to determine the position of the highest radiation.
- b. The EUT was set 3 meters away from the interference-receiving antenna, which was mounted on the top of a variable-height antenna tower.
- c. The height of antenna is varied from one meter to four meters above the ground to determine the maximum value of the field strength. Both horizontal and vertical polarizations of the antenna are set to make the measurement.
- d. For each suspected emission, the EUT was arranged to its worst case and then the antenna was tuned to heights from 1 meter to 4 meters and the rotatable table was turned from 0 degrees to 360 degrees to find the maximum reading.
- e. The test-receiver system was set to quasi-peak detect function and specified bandwidth with maximum hold mode when the test frequency is below 1 GHz.
- f. The test-receiver system was set to peak and average detect function and specified bandwidth with maximum hold mode when the test frequency is above 1 GHz. If the peak reading value also meets average limit, measurement with the average detector is unnecessary.

Note:

1. The resolution bandwidth and video bandwidth of test receiver/spectrum analyzer is 120kHz for Quasi-peak detection (QP) at frequency below 1GHz.
2. The resolution bandwidth of test receiver/spectrum analyzer is 1 MHz and the video bandwidth is 3 MHz for Peak detection (PK) at frequency above 1GHz.
3. The resolution bandwidth of test receiver/spectrum analyzer is 1MHz and the video bandwidth is $\geq 1/T$ (Duty cycle < 98%) or 10Hz (Duty cycle $\geq 98\%$) for Average detection (AV) at frequency above 1GHz.
4. All modes of operation were investigated and the worst-case emissions are reported.

4.1.4 Deviation from Test Standard

No deviation.

4.1.5 Test Set Up

For Radiated emission below 30MHz

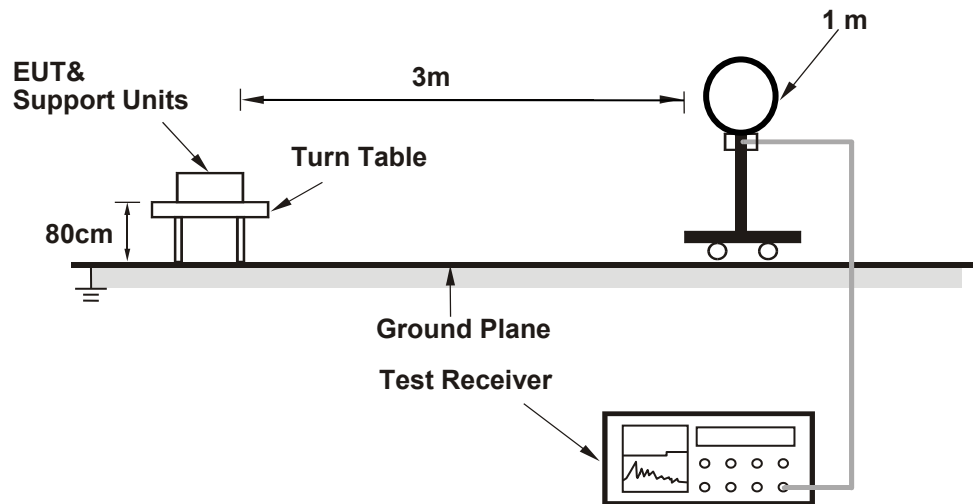

For Radiated emission 30MHz to 1GHz

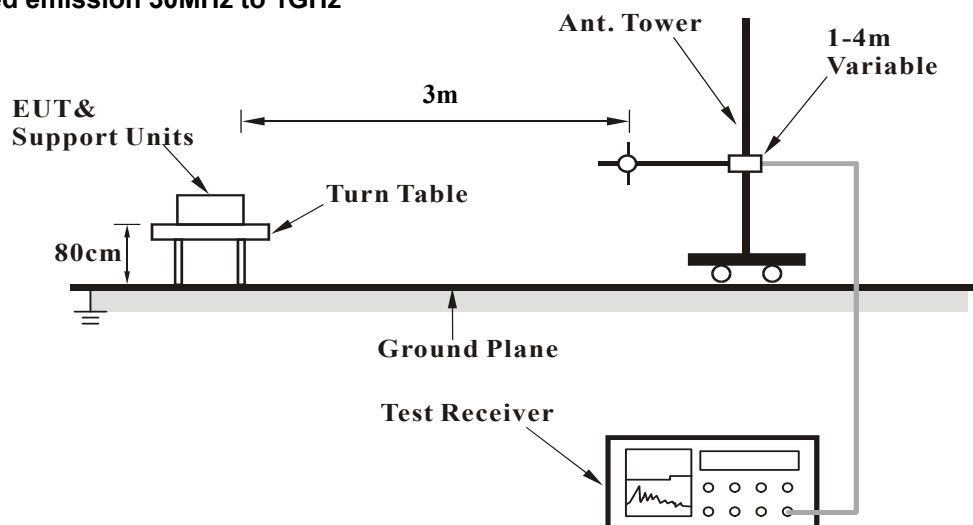

For Radiated emission above 1GHz

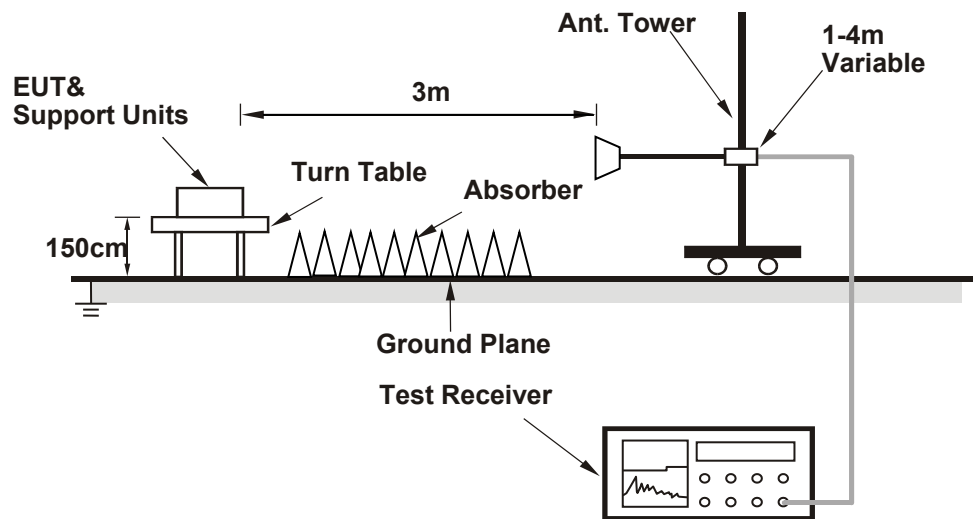

For the actual test configuration, please refer to the attached file (Test Setup Photo).

4.1.6 EUT Operating Conditions

- Placed the EUT on the testing table.
- Prepared a notebook to act as a communication partner and placed it outside of testing area.
- The communication partner connected with EUT via a RJ45 cable and ran a test program (provided by manufacturer) to enable EUT under transmission condition continuously at specific channel frequency.
- The communication partner sent data to EUT by command "PING".

4.1.7 Test Results

Above 1GHz data:

Test Mode A

802.11a

CHANNEL	TX Channel 52	DETECTOR FUNCTION	Peak (PK)
FREQUENCY RANGE	1GHz ~ 40GHz		Average (AV)

ANTENNA POLARITY & TEST DISTANCE: HORIZONTAL AT 3 M								
NO.	FREQ. (MHz)	EMISSION LEVEL (dBuV/m)	LIMIT (dBuV/m)	MARGIN (dB)	ANTENNA HEIGHT (m)	TABLE ANGLE (Degree)	RAW VALUE (dBuV)	CORRECTION FACTOR (dB/m)
1	5150.00	54.2 PK	74.0	-19.8	1.50 H	300	50.5	3.7
2	5150.00	42.7 AV	54.0	-11.3	1.50 H	300	39.0	3.7
3	*5260.00	117.8 PK			1.38 H	313	78.4	39.4
4	*5260.00	107.2 AV			1.38 H	313	67.8	39.4
5	5350.00	56.8 PK	74.0	-17.2	1.51 H	301	53.0	3.8
6	5350.00	43.2 AV	54.0	-10.8	1.51 H	301	39.4	3.8
7	#10520.00	59.3 PK	74.0	-14.7	1.87 H	266	42.5	16.8
8	#10520.00	45.8 AV	54.0	-8.2	1.87 H	266	29.0	16.8
ANTENNA POLARITY & TEST DISTANCE: VERTICAL AT 3 M								
NO.	FREQ. (MHz)	EMISSION LEVEL (dBuV/m)	LIMIT (dBuV/m)	MARGIN (dB)	ANTENNA HEIGHT (m)	TABLE ANGLE (Degree)	RAW VALUE (dBuV)	CORRECTION FACTOR (dB/m)
1	5150.00	54.3 PK	74.0	-19.7	2.10 V	350	50.6	3.7
2	5150.00	43.0 AV	54.0	-11.0	2.10 V	350	39.3	3.7
3	*5260.00	118.6 PK			2.09 V	355	79.2	39.4
4	*5260.00	108.4 AV			2.09 V	355	69.0	39.4
5	5350.00	55.7 PK	74.0	-18.3	2.08 V	353	51.9	3.8
6	5350.00	43.4 AV	54.0	-10.6	2.08 V	353	39.6	3.8
7	#10520.00	57.9 PK	74.0	-16.1	1.91 V	303	41.1	16.8
8	#10520.00	44.1 AV	54.0	-9.9	1.91 V	303	27.3	16.8

Remarks:

1. Emission Level(dBuV/m) = Raw Value(dBuV) + Correction Factor(dB/m)
2. Correction Factor(dB/m) = Antenna Factor(dB/m) + Cable Factor(dB) – Pre-Amplifier Factor(dB)
3. The other emission levels were very low against the limit.
4. Margin value = Emission Level – Limit value
5. " * ": Fundamental frequency.
6. " # ": The radiated frequency is out of the restricted band.

CHANNEL	TX Channel 60	DETECTOR FUNCTION	Peak (PK)
FREQUENCY RANGE	1GHz ~ 40GHz		Average (AV)

ANTENNA POLARITY & TEST DISTANCE: HORIZONTAL AT 3 M								
NO.	FREQ. (MHz)	EMISSION LEVEL (dBuV/m)	LIMIT (dBuV/m)	MARGIN (dB)	ANTENNA HEIGHT (m)	TABLE ANGLE (Degree)	RAW VALUE (dBuV)	CORRECTION FACTOR (dB/m)
1	*5300.00	117.4 PK			2.56 H	314	78.0	39.4
2	*5300.00	106.8 AV			2.56 H	314	67.4	39.4
3	5350.00	66.9 PK	74.0	-7.1	2.76 H	300	63.1	3.8
4	5350.00	49.3 AV	54.0	-4.7	2.76 H	300	45.5	3.8
5	10600.00	59.2 PK	74.0	-14.8	1.91 H	287	42.3	16.9
6	10600.00	46.0 AV	54.0	-8.0	1.91 H	287	29.1	16.9
ANTENNA POLARITY & TEST DISTANCE: VERTICAL AT 3 M								
NO.	FREQ. (MHz)	EMISSION LEVEL (dBuV/m)	LIMIT (dBuV/m)	MARGIN (dB)	ANTENNA HEIGHT (m)	TABLE ANGLE (Degree)	RAW VALUE (dBuV)	CORRECTION FACTOR (dB/m)
1	*5300.00	119.0 PK			2.24 V	346	79.6	39.4
2	*5300.00	108.6 AV			2.24 V	346	69.2	39.4
3	5350.00	71.0 PK	74.0	-3.0	2.00 V	355	67.2	3.8
4	5350.00	50.3 AV	54.0	-3.7	2.00 V	355	46.5	3.8
5	10600.00	57.3 PK	74.0	-16.7	1.93 V	294	40.4	16.9
6	10600.00	44.5 AV	54.0	-9.5	1.93 V	294	27.6	16.9

Remarks:

1. Emission Level(dBuV/m) = Raw Value(dBuV) + Correction Factor(dB/m)
2. Correction Factor(dB/m) = Antenna Factor(dB/m) + Cable Factor(dB) – Pre-Amplifier Factor(dB)
3. The other emission levels were very low against the limit.
4. Margin value = Emission Level – Limit value
5. " * ": Fundamental frequency.
6. " # ": The radiated frequency is out of the restricted band.

CHANNEL	TX Channel 64	DETECTOR FUNCTION	Peak (PK)
FREQUENCY RANGE	1GHz ~ 40GHz		Average (AV)

ANTENNA POLARITY & TEST DISTANCE: HORIZONTAL AT 3 M								
NO.	FREQ. (MHz)	EMISSION LEVEL (dBuV/m)	LIMIT (dBuV/m)	MARGIN (dB)	ANTENNA HEIGHT (m)	TABLE ANGLE (Degree)	RAW VALUE (dBuV)	CORRECTION FACTOR (dB/m)
1	*5320.00	115.8 PK			2.68 H	322	76.3	39.5
2	*5320.00	104.9 AV			2.68 H	322	65.4	39.5
3	5350.00	70.0 PK	74.0	-4.0	3.11 H	303	66.2	3.8
4	5350.00	52.1 AV	54.0	-1.9	3.11 H	303	48.3	3.8
5	10640.00	59.3 PK	74.0	-14.7	1.91 H	297	42.3	17.0
6	10640.00	46.1 AV	54.0	-7.9	1.91 H	297	29.1	17.0
ANTENNA POLARITY & TEST DISTANCE: VERTICAL AT 3 M								
NO.	FREQ. (MHz)	EMISSION LEVEL (dBuV/m)	LIMIT (dBuV/m)	MARGIN (dB)	ANTENNA HEIGHT (m)	TABLE ANGLE (Degree)	RAW VALUE (dBuV)	CORRECTION FACTOR (dB/m)
1	*5320.00	117.2 PK			1.40 V	1	77.7	39.5
2	*5320.00	106.8 AV			1.40 V	1	67.3	39.5
3	5350.00	69.9 PK	74.0	-4.1	1.96 V	353	66.1	3.8
4	5350.00	52.4 AV	54.0	-1.6	1.96 V	353	48.6	3.8
5	10640.00	55.5 PK	74.0	-18.5	1.81 V	255	38.5	17.0
6	10640.00	42.2 AV	54.0	-11.8	1.81 V	255	25.2	17.0

Remarks:

1. Emission Level(dBuV/m) = Raw Value(dBuV) + Correction Factor(dB/m)
2. Correction Factor(dB/m) = Antenna Factor(dB/m) + Cable Factor(dB) – Pre-Amplifier Factor(dB)
3. The other emission levels were very low against the limit.
4. Margin value = Emission Level – Limit value
5. " * ": Fundamental frequency.
6. " # ": The radiated frequency is out of the restricted band.

CHANNEL	TX Channel 100	DETECTOR FUNCTION	Peak (PK)
FREQUENCY RANGE	1GHz ~ 40GHz		Average (AV)

ANTENNA POLARITY & TEST DISTANCE: HORIZONTAL AT 3 M								
NO.	FREQ. (MHz)	EMISSION LEVEL (dBuV/m)	LIMIT (dBuV/m)	MARGIN (dB)	ANTENNA HEIGHT (m)	TABLE ANGLE (Degree)	RAW VALUE (dBuV)	CORRECTION FACTOR (dB/m)
1	5460.00	57.7 PK	74.0	-16.3	1.22 H	2	53.5	4.2
2	5460.00	43.2 AV	54.0	-10.8	1.22 H	2	39.0	4.2
3	#5470.00	67.6 PK	74.0	-6.4	1.15 H	16	63.4	4.2
4	#5470.00	48.4 AV	54.0	-5.6	1.15 H	16	44.2	4.2
5	*5500.00	115.3 PK			1.37 H	38	75.2	40.1
6	*5500.00	104.7 AV			1.37 H	38	64.6	40.1
7	11000.00	58.8 PK	74.0	-15.2	2.01 H	341	40.1	18.7
8	11000.00	46.2 AV	54.0	-7.8	2.01 H	341	27.5	18.7
ANTENNA POLARITY & TEST DISTANCE: VERTICAL AT 3 M								
NO.	FREQ. (MHz)	EMISSION LEVEL (dBuV/m)	LIMIT (dBuV/m)	MARGIN (dB)	ANTENNA HEIGHT (m)	TABLE ANGLE (Degree)	RAW VALUE (dBuV)	CORRECTION FACTOR (dB/m)
1	5460.00	60.3 PK	74.0	-13.7	2.00 V	1	56.1	4.2
2	5460.00	46.1 AV	54.0	-7.9	2.00 V	1	41.9	4.2
3	#5470.00	71.2 PK	74.0	-2.8	1.95 V	359	67.0	4.2
4	#5470.00	52.7 AV	54.0	-1.3	1.95 V	359	48.5	4.2
5	*5500.00	119.0 PK			1.62 V	0	78.9	40.1
6	*5500.00	108.5 AV			1.62 V	0	68.4	40.1
7	11000.00	59.4 PK	74.0	-14.6	1.99 V	323	40.7	18.7
8	11000.00	46.3 AV	54.0	-7.7	1.99 V	323	27.6	18.7

Remarks:

1. Emission Level(dBuV/m) = Raw Value(dBuV) + Correction Factor(dB/m)
2. Correction Factor(dB/m) = Antenna Factor(dB/m) + Cable Factor(dB) – Pre-Amplifier Factor(dB)
3. The other emission levels were very low against the limit.
4. Margin value = Emission Level – Limit value
5. " * ": Fundamental frequency.
6. " # ": The radiated frequency is out of the restricted band.

CHANNEL	TX Channel 116	DETECTOR	Peak (PK)
FREQUENCY RANGE	1GHz ~ 40GHz	FUNCTION	Average (AV)

ANTENNA POLARITY & TEST DISTANCE: HORIZONTAL AT 3 M								
NO.	FREQ. (MHz)	EMISSION LEVEL (dBuV/m)	LIMIT (dBuV/m)	MARGIN (dB)	ANTENNA HEIGHT (m)	TABLE ANGLE (Degree)	RAW VALUE (dBuV)	CORRECTION FACTOR (dB/m)
1	*5580.00	116.0 PK			1.32 H	49	76.0	40.0
2	*5580.00	105.7 AV			1.32 H	49	65.7	40.0
3	11160.00	58.0 PK	74.0	-16.0	1.74 H	234	40.3	17.7
4	11160.00	44.7 AV	54.0	-9.3	1.74 H	234	27.0	17.7
ANTENNA POLARITY & TEST DISTANCE: VERTICAL AT 3 M								
NO.	FREQ. (MHz)	EMISSION LEVEL (dBuV/m)	LIMIT (dBuV/m)	MARGIN (dB)	ANTENNA HEIGHT (m)	TABLE ANGLE (Degree)	RAW VALUE (dBuV)	CORRECTION FACTOR (dB/m)
1	*5580.00	120.2 PK			1.11 V	357	80.2	40.0
2	*5580.00	109.2 AV			1.11 V	357	69.2	40.0
3	11160.00	57.7 PK	74.0	-16.3	1.95 V	226	40.0	17.7
4	11160.00	45.0 AV	54.0	-9.0	1.95 V	226	27.3	17.7

Remarks:

1. Emission Level(dBuV/m) = Raw Value(dBuV) + Correction Factor(dB/m)
2. Correction Factor(dB/m) = Antenna Factor(dB/m) + Cable Factor(dB) – Pre-Amplifier Factor(dB)
3. The other emission levels were very low against the limit.
4. Margin value = Emission Level – Limit value
5. " * ": Fundamental frequency.
6. " # ": The radiated frequency is out of the restricted band.

CHANNEL	TX Channel 140	DETECTOR FUNCTION	Peak (PK)
FREQUENCY RANGE	1GHz ~ 40GHz		Average (AV)

ANTENNA POLARITY & TEST DISTANCE: HORIZONTAL AT 3 M								
NO.	FREQ. (MHz)	EMISSION LEVEL (dBuV/m)	LIMIT (dBuV/m)	MARGIN (dB)	ANTENNA HEIGHT (m)	TABLE ANGLE (Degree)	RAW VALUE (dBuV)	CORRECTION FACTOR (dB/m)
1	*5700.00	115.1 PK			1.22 H	15	75.1	40.0
2	*5700.00	104.5 AV			1.22 H	15	64.5	40.0
3	#5725.00	70.8 PK	74.0	-3.2	1.46 H	16	66.7	4.1
4	#5725.00	52.8 AV	54.0	-1.2	1.46 H	16	48.7	4.1
5	11400.00	59.4 PK	74.0	-14.6	1.69 H	219	41.7	17.7
6	11400.00	45.8 AV	54.0	-8.2	1.69 H	219	28.1	17.7
ANTENNA POLARITY & TEST DISTANCE: VERTICAL AT 3 M								
NO.	FREQ. (MHz)	EMISSION LEVEL (dBuV/m)	LIMIT (dBuV/m)	MARGIN (dB)	ANTENNA HEIGHT (m)	TABLE ANGLE (Degree)	RAW VALUE (dBuV)	CORRECTION FACTOR (dB/m)
1	*5700.00	116.6 PK			1.22 V	331	76.6	40.0
2	*5700.00	106.0 AV			1.22 V	331	66.0	40.0
3	#5725.00	71.0 PK	74.0	-3.0	1.83 V	330	66.9	4.1
4	#5725.00	52.9 AV	54.0	-1.1	1.83 V	330	48.8	4.1
5	11400.00	58.2 PK	74.0	-15.8	1.98 V	278	40.5	17.7
6	11400.00	45.2 AV	54.0	-8.8	1.98 V	278	27.5	17.7

Remarks:

1. Emission Level(dBuV/m) = Raw Value(dBuV) + Correction Factor(dB/m)
2. Correction Factor(dB/m) = Antenna Factor(dB/m) + Cable Factor(dB) – Pre-Amplifier Factor(dB)
3. The other emission levels were very low against the limit.
4. Margin value = Emission Level – Limit value
5. " * ": Fundamental frequency.
6. " # ": The radiated frequency is out of the restricted band.

802.11n (HT20)

CHANNEL	TX Channel 52	DETECTOR FUNCTION	Peak (PK)
FREQUENCY RANGE	1GHz ~ 40GHz		Average (AV)

ANTENNA POLARITY & TEST DISTANCE: HORIZONTAL AT 3 M								
NO.	FREQ. (MHz)	EMISSION LEVEL (dBuV/m)	LIMIT (dBuV/m)	MARGIN (dB)	ANTENNA HEIGHT (m)	TABLE ANGLE (Degree)	RAW VALUE (dBuV)	CORRECTION FACTOR (dB/m)
1	5150.00	54.7 PK	74.0	-19.3	1.55 H	321	51.0	3.7
2	5150.00	42.7 AV	54.0	-11.3	1.55 H	321	39.0	3.7
3	*5260.00	118.0 PK			1.12 H	314	78.6	39.4
4	*5260.00	107.0 AV			1.12 H	314	67.6	39.4
5	5350.00	57.8 PK	74.0	-16.2	1.56 H	319	54.0	3.8
6	5350.00	43.0 AV	54.0	-11.0	1.56 H	319	39.2	3.8
7	#10520.00	59.8 PK	74.0	-14.2	1.91 H	277	43.0	16.8
8	#10520.00	46.1 AV	54.0	-7.9	1.91 H	277	29.3	16.8
ANTENNA POLARITY & TEST DISTANCE: VERTICAL AT 3 M								
NO.	FREQ. (MHz)	EMISSION LEVEL (dBuV/m)	LIMIT (dBuV/m)	MARGIN (dB)	ANTENNA HEIGHT (m)	TABLE ANGLE (Degree)	RAW VALUE (dBuV)	CORRECTION FACTOR (dB/m)
1	5150.00	55.1 PK	74.0	-18.9	1.88 V	355	51.4	3.7
2	5150.00	43.6 AV	54.0	-10.4	1.88 V	355	39.9	3.7
3	*5260.00	119.5 PK			2.03 V	346	80.1	39.4
4	*5260.00	108.8 AV			2.03 V	346	69.4	39.4
5	5350.00	56.1 PK	74.0	-17.9	1.92 V	356	52.3	3.8
6	5350.00	44.5 AV	54.0	-9.5	1.92 V	356	40.7	3.8
7	#10520.00	56.8 PK	74.0	-17.2	1.87 V	297	40.0	16.8
8	#10520.00	44.0 AV	54.0	-10.0	1.87 V	297	27.2	16.8

Remarks:

1. Emission Level(dBuV/m) = Raw Value(dBuV) + Correction Factor(dB/m)
2. Correction Factor(dB/m) = Antenna Factor(dB/m) + Cable Factor(dB) – Pre-Amplifier Factor(dB)
3. The other emission levels were very low against the limit.
4. Margin value = Emission Level – Limit value
5. " * ": Fundamental frequency.
6. " # ": The radiated frequency is out of the restricted band.

CHANNEL	TX Channel 60	DETECTOR FUNCTION	Peak (PK)
FREQUENCY RANGE	1GHz ~ 40GHz		Average (AV)

ANTENNA POLARITY & TEST DISTANCE: HORIZONTAL AT 3 M								
NO.	FREQ. (MHz)	EMISSION LEVEL (dBuV/m)	LIMIT (dBuV/m)	MARGIN (dB)	ANTENNA HEIGHT (m)	TABLE ANGLE (Degree)	RAW VALUE (dBuV)	CORRECTION FACTOR (dB/m)
1	*5300.00	118.0 PK			1.55 H	18	78.6	39.4
2	*5300.00	106.8 AV			1.55 H	18	67.4	39.4
3	5350.00	70.1 PK	74.0	-3.9	1.70 H	320	66.3	3.8
4	5350.00	51.4 AV	54.0	-2.6	1.70 H	320	47.6	3.8
5	10600.00	58.7 PK	74.0	-15.3	1.85 H	280	41.8	16.9
6	10600.00	44.8 AV	54.0	-9.2	1.85 H	280	27.9	16.9
ANTENNA POLARITY & TEST DISTANCE: VERTICAL AT 3 M								
NO.	FREQ. (MHz)	EMISSION LEVEL (dBuV/m)	LIMIT (dBuV/m)	MARGIN (dB)	ANTENNA HEIGHT (m)	TABLE ANGLE (Degree)	RAW VALUE (dBuV)	CORRECTION FACTOR (dB/m)
1	*5300.00	119.1 PK			2.21 V	340	79.7	39.4
2	*5300.00	108.2 AV			2.21 V	340	68.8	39.4
3	5350.00	67.4 PK	74.0	-6.6	1.08 V	352	63.6	3.8
4	5350.00	49.7 AV	54.0	-4.3	1.08 V	352	45.9	3.8
5	10600.00	57.5 PK	74.0	-16.5	1.79 V	291	40.6	16.9
6	10600.00	44.2 AV	54.0	-9.8	1.79 V	291	27.3	16.9

Remarks:

1. Emission Level(dBuV/m) = Raw Value(dBuV) + Correction Factor(dB/m)
2. Correction Factor(dB/m) = Antenna Factor(dB/m) + Cable Factor(dB) – Pre-Amplifier Factor(dB)
3. The other emission levels were very low against the limit.
4. Margin value = Emission Level – Limit value
5. " * ": Fundamental frequency.
6. " # ": The radiated frequency is out of the restricted band.

CHANNEL	TX Channel 64	DETECTOR FUNCTION	Peak (PK)
FREQUENCY RANGE	1GHz ~ 40GHz		Average (AV)

ANTENNA POLARITY & TEST DISTANCE: HORIZONTAL AT 3 M								
NO.	FREQ. (MHz)	EMISSION LEVEL (dBuV/m)	LIMIT (dBuV/m)	MARGIN (dB)	ANTENNA HEIGHT (m)	TABLE ANGLE (Degree)	RAW VALUE (dBuV)	CORRECTION FACTOR (dB/m)
1	*5320.00	115.5 PK			1.64 H	51	76.0	39.5
2	*5320.00	104.1 AV			1.64 H	51	64.6	39.5
3	5350.00	69.4 PK	74.0	-4.6	2.01 H	12	65.6	3.8
4	5350.00	52.4 AV	54.0	-1.6	2.01 H	12	48.6	3.8
5	10640.00	57.6 PK	74.0	-16.4	1.93 H	178	40.6	17.0
6	10640.00	44.9 AV	54.0	-9.1	1.93 H	178	27.9	17.0
ANTENNA POLARITY & TEST DISTANCE: VERTICAL AT 3 M								
NO.	FREQ. (MHz)	EMISSION LEVEL (dBuV/m)	LIMIT (dBuV/m)	MARGIN (dB)	ANTENNA HEIGHT (m)	TABLE ANGLE (Degree)	RAW VALUE (dBuV)	CORRECTION FACTOR (dB/m)
1	*5320.00	115.3 PK			2.68 V	322	75.8	39.5
2	*5320.00	104.0 AV			2.68 V	322	64.5	39.5
3	5350.00	69.5 PK	74.0	-4.5	3.11 V	303	65.7	3.8
4	5350.00	51.6 AV	54.0	-2.4	3.11 V	303	47.8	3.8
5	10640.00	59.3 PK	74.0	-14.7	1.91 V	297	42.3	17.0
6	10640.00	46.1 AV	54.0	-7.9	1.91 V	297	29.1	17.0

Remarks:

1. Emission Level(dBuV/m) = Raw Value(dBuV) + Correction Factor(dB/m)
2. Correction Factor(dB/m) = Antenna Factor(dB/m) + Cable Factor(dB) – Pre-Amplifier Factor(dB)
3. The other emission levels were very low against the limit.
4. Margin value = Emission Level – Limit value
5. " * ": Fundamental frequency.
6. " # ": The radiated frequency is out of the restricted band.

CHANNEL	TX Channel 100	DETECTOR FUNCTION	Peak (PK)
FREQUENCY RANGE	1GHz ~ 40GHz		Average (AV)

ANTENNA POLARITY & TEST DISTANCE: HORIZONTAL AT 3 M								
NO.	FREQ. (MHz)	EMISSION LEVEL (dBuV/m)	LIMIT (dBuV/m)	MARGIN (dB)	ANTENNA HEIGHT (m)	TABLE ANGLE (Degree)	RAW VALUE (dBuV)	CORRECTION FACTOR (dB/m)
1	5460.00	57.9 PK	74.0	-16.1	2.54 H	301	53.7	4.2
2	5460.00	44.7 AV	54.0	-9.3	2.54 H	301	40.5	4.2
3	#5470.00	68.4 PK	74.0	-5.6	2.72 H	305	64.2	4.2
4	#5470.00	50.4 AV	54.0	-3.6	2.72 H	305	46.2	4.2
5	*5500.00	116.1 PK			3.00 H	323	76.0	40.1
6	*5500.00	105.0 AV			3.00 H	323	64.9	40.1
7	11000.00	58.9 PK	74.0	-15.1	1.93 H	287	40.2	18.7
8	11000.00	45.4 AV	54.0	-8.6	1.93 H	287	26.7	18.7
ANTENNA POLARITY & TEST DISTANCE: VERTICAL AT 3 M								
NO.	FREQ. (MHz)	EMISSION LEVEL (dBuV/m)	LIMIT (dBuV/m)	MARGIN (dB)	ANTENNA HEIGHT (m)	TABLE ANGLE (Degree)	RAW VALUE (dBuV)	CORRECTION FACTOR (dB/m)
1	5460.00	56.3 PK	74.0	-17.7	1.51 V	333	52.1	4.2
2	5460.00	43.5 AV	54.0	-10.5	1.51 V	333	39.3	4.2
3	#5470.00	71.0 PK	74.0	-3.0	1.29 V	357	66.8	4.2
4	#5470.00	52.5 AV	54.0	-1.5	1.29 V	357	48.3	4.2
5	*5500.00	117.4 PK			1.26 V	326	77.3	40.1
6	*5500.00	105.8 AV			1.26 V	326	65.7	40.1
7	11000.00	58.5 PK	74.0	-15.5	1.83 V	268	39.8	18.7
8	11000.00	45.7 AV	54.0	-8.3	1.83 V	268	27.0	18.7

Remarks:

1. Emission Level(dBuV/m) = Raw Value(dBuV) + Correction Factor(dB/m)
2. Correction Factor(dB/m) = Antenna Factor(dB/m) + Cable Factor(dB) – Pre-Amplifier Factor(dB)
3. The other emission levels were very low against the limit.
4. Margin value = Emission Level – Limit value
5. " * ": Fundamental frequency.
6. " # ": The radiated frequency is out of the restricted band.

CHANNEL	TX Channel 116	DETECTOR FUNCTION	Peak (PK)
FREQUENCY RANGE	1GHz ~ 40GHz		Average (AV)

ANTENNA POLARITY & TEST DISTANCE: HORIZONTAL AT 3 M								
NO.	FREQ. (MHz)	EMISSION LEVEL (dBuV/m)	LIMIT (dBuV/m)	MARGIN (dB)	ANTENNA HEIGHT (m)	TABLE ANGLE (Degree)	RAW VALUE (dBuV)	CORRECTION FACTOR (dB/m)
1	*5580.00	115.7 PK			2.70 H	311	75.7	40.0
2	*5580.00	104.5 AV			2.70 H	311	64.5	40.0
3	11160.00	58.6 PK	74.0	-15.4	2.11 H	287	40.9	17.7
4	11160.00	45.4 AV	54.0	-8.6	2.11 H	287	27.7	17.7
ANTENNA POLARITY & TEST DISTANCE: VERTICAL AT 3 M								
NO.	FREQ. (MHz)	EMISSION LEVEL (dBuV/m)	LIMIT (dBuV/m)	MARGIN (dB)	ANTENNA HEIGHT (m)	TABLE ANGLE (Degree)	RAW VALUE (dBuV)	CORRECTION FACTOR (dB/m)
1	*5580.00	117.9 PK			1.10 V	358	77.9	40.0
2	*5580.00	107.0 AV			1.10 V	358	67.0	40.0
3	11160.00	57.9 PK	74.0	-16.1	2.03 V	246	40.2	17.7
4	11160.00	44.7 AV	54.0	-9.3	2.03 V	246	27.0	17.7

Remarks:

1. Emission Level(dBuV/m) = Raw Value(dBuV) + Correction Factor(dB/m)
2. Correction Factor(dB/m) = Antenna Factor(dB/m) + Cable Factor(dB) – Pre-Amplifier Factor(dB)
3. The other emission levels were very low against the limit.
4. Margin value = Emission Level – Limit value
5. " * ": Fundamental frequency.
6. " # ": The radiated frequency is out of the restricted band.

CHANNEL	TX Channel 140	DETECTOR FUNCTION	Peak (PK)
FREQUENCY RANGE	1GHz ~ 40GHz		Average (AV)

ANTENNA POLARITY & TEST DISTANCE: HORIZONTAL AT 3 M								
NO.	FREQ. (MHz)	EMISSION LEVEL (dBuV/m)	LIMIT (dBuV/m)	MARGIN (dB)	ANTENNA HEIGHT (m)	TABLE ANGLE (Degree)	RAW VALUE (dBuV)	CORRECTION FACTOR (dB/m)
1	*5700.00	115.5 PK			2.66 H	329	75.5	40.0
2	*5700.00	104.0 AV			2.66 H	329	64.0	40.0
3	#5725.00	69.9 PK	74.0	-4.1	2.91 H	309	65.8	4.1
4	#5725.00	52.3 AV	54.0	-1.7	2.91 H	309	48.2	4.1
5	11400.00	59.4 PK	74.0	-14.6	1.87 H	279	41.7	17.7
6	11400.00	46.2 AV	54.0	-7.8	1.87 H	279	28.5	17.7
ANTENNA POLARITY & TEST DISTANCE: VERTICAL AT 3 M								
NO.	FREQ. (MHz)	EMISSION LEVEL (dBuV/m)	LIMIT (dBuV/m)	MARGIN (dB)	ANTENNA HEIGHT (m)	TABLE ANGLE (Degree)	RAW VALUE (dBuV)	CORRECTION FACTOR (dB/m)
1	*5700.00	116.1 PK			1.22 V	331	76.1	40.0
2	*5700.00	105.5 AV			1.22 V	331	65.5	40.0
3	#5725.00	70.5 PK	74.0	-3.5	1.83 V	330	66.4	4.1
4	#5725.00	52.4 AV	54.0	-1.6	1.83 V	330	48.3	4.1
5	11400.00	58.2 PK	74.0	-15.8	1.98 V	278	40.5	17.7
6	11400.00	45.2 AV	54.0	-8.8	1.98 V	278	27.5	17.7

Remarks:

1. Emission Level(dBuV/m) = Raw Value(dBuV) + Correction Factor(dB/m)
2. Correction Factor(dB/m) = Antenna Factor(dB/m) + Cable Factor(dB) – Pre-Amplifier Factor(dB)
3. The other emission levels were very low against the limit.
4. Margin value = Emission Level – Limit value
5. " * ": Fundamental frequency.
6. " # ": The radiated frequency is out of the restricted band.

802.11n (HT40)

CHANNEL	TX Channel 54	DETECTOR FUNCTION	Peak (PK)
FREQUENCY RANGE	1GHz ~ 40GHz		Average (AV)

ANTENNA POLARITY & TEST DISTANCE: HORIZONTAL AT 3 M

NO.	FREQ. (MHz)	EMISSION LEVEL (dBuV/m)	LIMIT (dBuV/m)	MARGIN (dB)	ANTENNA HEIGHT (m)	TABLE ANGLE (Degree)	RAW VALUE (dBuV)	CORRECTION FACTOR (dB/m)
1	5150.00	58.0 PK	74.0	-16.0	1.20 H	26	54.3	3.7
2	5150.00	45.9 AV	54.0	-8.1	1.20 H	26	42.2	3.7
3	*5270.00	114.0 PK			1.38 H	17	74.6	39.4
4	*5270.00	103.4 AV			1.38 H	17	64.0	39.4
5	5350.00	64.2 PK	74.0	-9.8	1.25 H	22	60.4	3.8
6	5350.00	48.9 AV	54.0	-5.1	1.25 H	22	45.1	3.8
7	#10540.00	58.4 PK	74.0	-15.6	1.86 H	254	41.5	16.9
8	#10540.00	44.6 AV	54.0	-9.4	1.86 H	254	27.7	16.9

ANTENNA POLARITY & TEST DISTANCE: VERTICAL AT 3 M

NO.	FREQ. (MHz)	EMISSION LEVEL (dBuV/m)	LIMIT (dBuV/m)	MARGIN (dB)	ANTENNA HEIGHT (m)	TABLE ANGLE (Degree)	RAW VALUE (dBuV)	CORRECTION FACTOR (dB/m)
1	5150.00	59.8 PK	74.0	-14.2	2.12 V	348	56.1	3.7
2	5150.00	47.8 AV	54.0	-6.2	2.12 V	348	44.1	3.7
3	*5270.00	114.2 PK			1.96 V	358	74.8	39.4
4	*5270.00	104.4 AV			1.96 V	358	65.0	39.4
5	5350.00	68.1 PK	74.0	-5.9	2.20 V	351	64.3	3.8
6	5350.00	52.4 AV	54.0	-1.6	2.20 V	351	48.6	3.8
7	#10540.00	57.4 PK	74.0	-16.6	1.88 V	311	40.5	16.9
8	#10540.00	44.4 AV	54.0	-9.6	1.88 V	311	27.5	16.9

Remarks:

1. Emission Level(dBuV/m) = Raw Value(dBuV) + Correction Factor(dB/m)
2. Correction Factor(dB/m) = Antenna Factor(dB/m) + Cable Factor(dB) – Pre-Amplifier Factor(dB)
3. The other emission levels were very low against the limit.
4. Margin value = Emission Level – Limit value
5. " * ": Fundamental frequency.
6. " # ": The radiated frequency is out of the restricted band.

CHANNEL	TX Channel 62	DETECTOR FUNCTION	Peak (PK)
FREQUENCY RANGE	1GHz ~ 40GHz		Average (AV)

ANTENNA POLARITY & TEST DISTANCE: HORIZONTAL AT 3 M								
NO.	FREQ. (MHz)	EMISSION LEVEL (dBuV/m)	LIMIT (dBuV/m)	MARGIN (dB)	ANTENNA HEIGHT (m)	TABLE ANGLE (Degree)	RAW VALUE (dBuV)	CORRECTION FACTOR (dB/m)
1	*5310.00	108.8 PK			2.81 H	321	69.4	39.4
2	*5310.00	98.5 AV			2.81 H	321	59.1	39.4
3	5350.00	66.3 PK	74.0	-7.7	2.78 H	301	62.5	3.8
4	5350.00	49.8 AV	54.0	-4.2	2.78 H	301	46.0	3.8
5	10620.00	56.7 PK	74.0	-17.3	1.93 H	287	39.6	17.1
6	10620.00	43.8 AV	54.0	-10.2	1.93 H	287	26.7	17.1
ANTENNA POLARITY & TEST DISTANCE: VERTICAL AT 3 M								
NO.	FREQ. (MHz)	EMISSION LEVEL (dBuV/m)	LIMIT (dBuV/m)	MARGIN (dB)	ANTENNA HEIGHT (m)	TABLE ANGLE (Degree)	RAW VALUE (dBuV)	CORRECTION FACTOR (dB/m)
1	*5310.00	110.7 PK			2.01 V	356	71.3	39.4
2	*5310.00	100.3 AV			2.01 V	356	60.9	39.4
3	5350.00	67.7 PK	74.0	-6.3	2.00 V	357	63.9	3.8
4	5350.00	52.4 AV	54.0	-1.6	2.00 V	357	48.6	3.8
5	10620.00	59.1 PK	74.0	-14.9	1.71 V	267	42.0	17.1
6	10620.00	44.8 AV	54.0	-9.2	1.71 V	267	27.7	17.1

Remarks:

1. Emission Level(dBuV/m) = Raw Value(dBuV) + Correction Factor(dB/m)
2. Correction Factor(dB/m) = Antenna Factor(dB/m) + Cable Factor(dB) – Pre-Amplifier Factor(dB)
3. The other emission levels were very low against the limit.
4. Margin value = Emission Level – Limit value
5. " * ": Fundamental frequency.
6. " # ": The radiated frequency is out of the restricted band.

CHANNEL	TX Channel 102	DETECTOR FUNCTION	Peak (PK)
FREQUENCY RANGE	1GHz ~ 40GHz		Average (AV)

ANTENNA POLARITY & TEST DISTANCE: HORIZONTAL AT 3 M								
NO.	FREQ. (MHz)	EMISSION LEVEL (dBuV/m)	LIMIT (dBuV/m)	MARGIN (dB)	ANTENNA HEIGHT (m)	TABLE ANGLE (Degree)	RAW VALUE (dBuV)	CORRECTION FACTOR (dB/m)
1	5460.00	60.0 PK	74.0	-14.0	2.39 H	347	55.8	4.2
2	5460.00	45.1 AV	54.0	-8.9	2.39 H	347	40.9	4.2
3	#5470.00	68.9 PK	74.0	-5.1	2.76 H	322	64.7	4.2
4	#5470.00	49.5 AV	54.0	-4.5	2.76 H	322	45.3	4.2
5	*5510.00	110.3 PK			2.60 H	315	70.2	40.1
6	*5510.00	99.9 AV			2.60 H	315	59.8	40.1
7	11020.00	58.8 PK	74.0	-15.2	1.99 H	222	40.3	18.5
8	11020.00	45.8 AV	54.0	-8.2	1.99 H	222	27.3	18.5
ANTENNA POLARITY & TEST DISTANCE: VERTICAL AT 3 M								
NO.	FREQ. (MHz)	EMISSION LEVEL (dBuV/m)	LIMIT (dBuV/m)	MARGIN (dB)	ANTENNA HEIGHT (m)	TABLE ANGLE (Degree)	RAW VALUE (dBuV)	CORRECTION FACTOR (dB/m)
1	5460.00	60.9 PK	74.0	-13.1	2.11 V	357	56.7	4.2
2	5460.00	45.2 AV	54.0	-8.8	2.11 V	357	41.0	4.2
3	#5470.00	71.2 PK	74.0	-2.8	2.00 V	352	67.0	4.2
4	#5470.00	52.8 AV	54.0	-1.2	2.00 V	352	48.6	4.2
5	*5510.00	114.5 PK			1.34 V	359	74.4	40.1
6	*5510.00	104.1 AV			1.34 V	359	64.0	40.1
7	11020.00	59.9 PK	74.0	-14.1	1.95 V	290	41.4	18.5
8	11020.00	46.3 AV	54.0	-7.7	1.95 V	290	27.8	18.5

Remarks:

1. Emission Level(dBuV/m) = Raw Value(dBuV) + Correction Factor(dB/m)
2. Correction Factor(dB/m) = Antenna Factor(dB/m) + Cable Factor(dB) – Pre-Amplifier Factor(dB)
3. The other emission levels were very low against the limit.
4. Margin value = Emission Level – Limit value
5. " * ": Fundamental frequency.
6. " # ": The radiated frequency is out of the restricted band.

CHANNEL	TX Channel 110	DETECTOR FUNCTION	Peak (PK)
FREQUENCY RANGE	1GHz ~ 40GHz		Average (AV)

ANTENNA POLARITY & TEST DISTANCE: HORIZONTAL AT 3 M								
NO.	FREQ. (MHz)	EMISSION LEVEL (dBuV/m)	LIMIT (dBuV/m)	MARGIN (dB)	ANTENNA HEIGHT (m)	TABLE ANGLE (Degree)	RAW VALUE (dBuV)	CORRECTION FACTOR (dB/m)
1	5460.00	62.5 PK	74.0	-11.5	2.44 H	319	58.3	4.2
2	5460.00	47.5 AV	54.0	-6.5	2.44 H	319	43.3	4.2
3	#5470.00	67.1 PK	74.0	-6.9	2.86 H	305	62.9	4.2
4	#5470.00	50.2 AV	54.0	-3.8	2.86 H	305	46.0	4.2
5	*5550.00	113.5 PK			2.64 H	310	73.5	40.0
6	*5550.00	102.7 AV			2.64 H	310	62.7	40.0
7	11100.00	58.4 PK	74.0	-15.6	1.97 H	246	40.8	17.6
8	11100.00	45.4 AV	54.0	-8.6	1.97 H	246	27.8	17.6
ANTENNA POLARITY & TEST DISTANCE: VERTICAL AT 3 M								
NO.	FREQ. (MHz)	EMISSION LEVEL (dBuV/m)	LIMIT (dBuV/m)	MARGIN (dB)	ANTENNA HEIGHT (m)	TABLE ANGLE (Degree)	RAW VALUE (dBuV)	CORRECTION FACTOR (dB/m)
1	5460.00	63.3 PK	74.0	-10.7	2.00 V	330	59.1	4.2
2	5460.00	43.1 AV	54.0	-10.9	2.00 V	330	38.9	4.2
3	#5470.00	68.4 PK	74.0	-5.6	2.21 V	359	64.2	4.2
4	#5470.00	52.4 AV	54.0	-1.6	2.21 V	359	48.2	4.2
5	*5550.00	115.6 PK			1.17 V	1	75.6	40.0
6	*5550.00	105.6 AV			1.17 V	1	65.6	40.0
7	11100.00	59.6 PK	74.0	-14.4	1.95 V	309	42.0	17.6
8	11100.00	45.6 AV	54.0	-8.4	1.95 V	309	28.0	17.6

Remarks:

1. Emission Level(dBuV/m) = Raw Value(dBuV) + Correction Factor(dB/m)
2. Correction Factor(dB/m) = Antenna Factor(dB/m) + Cable Factor(dB) – Pre-Amplifier Factor(dB)
3. The other emission levels were very low against the limit.
4. Margin value = Emission Level – Limit value
5. " * ": Fundamental frequency.
6. " # ": The radiated frequency is out of the restricted band.

CHANNEL	TX Channel 134	DETECTOR FUNCTION	Peak (PK)
FREQUENCY RANGE	1GHz ~ 40GHz		Average (AV)

ANTENNA POLARITY & TEST DISTANCE: HORIZONTAL AT 3 M								
NO.	FREQ. (MHz)	EMISSION LEVEL (dBuV/m)	LIMIT (dBuV/m)	MARGIN (dB)	ANTENNA HEIGHT (m)	TABLE ANGLE (Degree)	RAW VALUE (dBuV)	CORRECTION FACTOR (dB/m)
1	*5670.00	111.1 PK			2.70 H	330	71.0	40.1
2	*5670.00	101.0 AV			2.70 H	330	60.9	40.1
3	#5725.00	66.8 PK	74.0	-7.2	2.59 H	315	62.7	4.1
4	#5725.00	49.6 AV	54.0	-4.4	2.59 H	315	45.5	4.1
5	11340.00	59.6 PK	74.0	-14.4	2.08 H	229	41.7	17.9
6	11340.00	46.5 AV	54.0	-7.5	2.08 H	229	28.6	17.9
ANTENNA POLARITY & TEST DISTANCE: VERTICAL AT 3 M								
NO.	FREQ. (MHz)	EMISSION LEVEL (dBuV/m)	LIMIT (dBuV/m)	MARGIN (dB)	ANTENNA HEIGHT (m)	TABLE ANGLE (Degree)	RAW VALUE (dBuV)	CORRECTION FACTOR (dB/m)
1	*5670.00	112.8 PK			1.20 V	332	72.7	40.1
2	*5670.00	102.6 AV			1.20 V	332	62.5	40.1
3	#5725.00	68.1 PK	74.0	-5.9	1.22 V	357	64.0	4.1
4	#5725.00	52.2 AV	54.0	-1.8	1.22 V	357	48.1	4.1
5	11340.00	59.1 PK	74.0	-14.9	1.91 V	288	41.2	17.9
6	11340.00	45.8 AV	54.0	-8.2	1.91 V	288	27.9	17.9

Remarks:

1. Emission Level(dBuV/m) = Raw Value(dBuV) + Correction Factor(dB/m)
2. Correction Factor(dB/m) = Antenna Factor(dB/m) + Cable Factor(dB) – Pre-Amplifier Factor(dB)
3. The other emission levels were very low against the limit.
4. Margin value = Emission Level – Limit value
5. " * ": Fundamental frequency.
6. " # ": The radiated frequency is out of the restricted band.

802.11ac (VHT80)

CHANNEL	TX Channel 58	DETECTOR FUNCTION	Peak (PK)
FREQUENCY RANGE	1GHz ~ 40GHz		Average (AV)

ANTENNA POLARITY & TEST DISTANCE: HORIZONTAL AT 3 M

NO.	FREQ. (MHz)	EMISSION LEVEL (dBuV/m)	LIMIT (dBuV/m)	MARGIN (dB)	ANTENNA HEIGHT (m)	TABLE ANGLE (Degree)	RAW VALUE (dBuV)	CORRECTION FACTOR (dB/m)
1	5150.00	54.7 PK	74.0	-19.3	1.54 H	13	51.0	3.7
2	5150.00	42.5 AV	54.0	-11.5	1.54 H	13	38.8	3.7
3	*5290.00	104.7 PK			1.56 H	29	65.3	39.4
4	*5290.00	94.7 AV			1.56 H	29	55.3	39.4
5	5350.00	65.8 PK	74.0	-8.2	1.41 H	22	62.0	3.8
6	5350.00	50.7 AV	54.0	-3.3	1.41 H	22	46.9	3.8
7	#10580.00	58.5 PK	74.0	-15.5	1.93 H	294	41.5	17.0
8	#10580.00	45.0 AV	54.0	-9.0	1.93 H	294	28.0	17.0

ANTENNA POLARITY & TEST DISTANCE: VERTICAL AT 3 M

NO.	FREQ. (MHz)	EMISSION LEVEL (dBuV/m)	LIMIT (dBuV/m)	MARGIN (dB)	ANTENNA HEIGHT (m)	TABLE ANGLE (Degree)	RAW VALUE (dBuV)	CORRECTION FACTOR (dB/m)
1	5150.00	55.7 PK	74.0	-18.3	1.91 V	357	52.0	3.7
2	5150.00	43.0 AV	54.0	-11.0	1.91 V	357	39.3	3.7
3	*5290.00	104.3 PK			1.92 V	358	64.9	39.4
4	*5290.00	94.3 AV			1.92 V	358	54.9	39.4
5	5350.00	66.5 PK	74.0	-7.5	1.88 V	359	62.7	3.8
6	5350.00	52.3 AV	54.0	-1.7	1.88 V	359	48.5	3.8
7	#10580.00	58.7 PK	74.0	-15.3	1.73 V	313	41.7	17.0
8	#10580.00	45.3 AV	54.0	-8.7	1.73 V	313	28.3	17.0

Remarks:

1. Emission Level(dBuV/m) = Raw Value(dBuV) + Correction Factor(dB/m)
2. Correction Factor(dB/m) = Antenna Factor(dB/m) + Cable Factor(dB) – Pre-Amplifier Factor(dB)
3. The other emission levels were very low against the limit.
4. Margin value = Emission Level – Limit value
5. " * ": Fundamental frequency.
6. " # ": The radiated frequency is out of the restricted band.

CHANNEL	TX Channel 106	DETECTOR FUNCTION	Peak (PK)
FREQUENCY RANGE	1GHz ~ 40GHz		Average (AV)

ANTENNA POLARITY & TEST DISTANCE: HORIZONTAL AT 3 M								
NO.	FREQ. (MHz)	EMISSION LEVEL (dBuV/m)	LIMIT (dBuV/m)	MARGIN (dB)	ANTENNA HEIGHT (m)	TABLE ANGLE (Degree)	RAW VALUE (dBuV)	CORRECTION FACTOR (dB/m)
1	5460.00	57.9 PK	74.0	-16.1	1.44 H	19	53.7	4.2
2	5460.00	43.6 AV	54.0	-10.4	1.44 H	19	39.4	4.2
3	#5470.00	64.7 PK	74.0	-9.3	1.13 H	30	60.5	4.2
4	#5470.00	47.9 AV	54.0	-6.1	1.13 H	30	43.7	4.2
5	*5530.00	105.6 PK			1.42 H	35	65.5	40.1
6	*5530.00	95.9 AV			1.42 H	35	55.8	40.1
7	#5725.00	55.3 PK	74.0	-18.7	1.44 H	36	51.2	4.1
8	#5725.00	43.0 AV	54.0	-11.0	1.44 H	36	38.9	4.1
9	11060.00	58.5 PK	74.0	-15.5	1.77 H	343	40.5	18.0
10	11060.00	45.6 AV	54.0	-8.4	1.77 H	343	27.6	18.0

ANTENNA POLARITY & TEST DISTANCE: VERTICAL AT 3 M								
NO.	FREQ. (MHz)	EMISSION LEVEL (dBuV/m)	LIMIT (dBuV/m)	MARGIN (dB)	ANTENNA HEIGHT (m)	TABLE ANGLE (Degree)	RAW VALUE (dBuV)	CORRECTION FACTOR (dB/m)
1	5460.00	64.0 PK	74.0	-10.0	1.71 V	355	59.8	4.2
2	5460.00	47.5 AV	54.0	-6.5	1.71 V	355	43.3	4.2
3	#5470.00	69.7 PK	74.0	-4.3	1.53 V	359	65.5	4.2
4	#5470.00	52.6 AV	54.0	-1.4	1.53 V	359	48.4	4.2
5	*5530.00	110.7 PK			1.41 V	332	70.6	40.1
6	*5530.00	100.6 AV			1.41 V	332	60.5	40.1
7	#5725.00	55.8 PK	74.0	-18.2	1.69 V	353	51.7	4.1
8	#5725.00	43.8 AV	54.0	-10.2	1.69 V	353	39.7	4.1
9	11060.00	59.4 PK	74.0	-14.6	1.79 V	287	41.4	18.0
10	11060.00	46.4 AV	54.0	-7.6	1.79 V	287	28.4	18.0

Remarks:

1. Emission Level(dBuV/m) = Raw Value(dBuV) + Correction Factor(dB/m)
2. Correction Factor(dB/m) = Antenna Factor(dB/m) + Cable Factor(dB) – Pre-Amplifier Factor(dB)
3. The other emission levels were very low against the limit.
4. Margin value = Emission Level – Limit value
5. " * ": Fundamental frequency.
6. " # ": The radiated frequency is out of the restricted band.

CHANNEL	TX Channel 122	DETECTOR FUNCTION	Peak (PK)
FREQUENCY RANGE	1GHz ~ 40GHz		Average (AV)

ANTENNA POLARITY & TEST DISTANCE: HORIZONTAL AT 3 M								
NO.	FREQ. (MHz)	EMISSION LEVEL (dBuV/m)	LIMIT (dBuV/m)	MARGIN (dB)	ANTENNA HEIGHT (m)	TABLE ANGLE (Degree)	RAW VALUE (dBuV)	CORRECTION FACTOR (dB/m)
1	5460.00	58.7 PK	74.0	-15.3	1.56 H	30	54.5	4.2
2	5460.00	45.1 AV	54.0	-8.9	1.56 H	30	40.9	4.2
3	#5470.00	59.3 PK	74.0	-14.7	1.20 H	33	55.1	4.2
4	#5470.00	48.0 AV	54.0	-6.0	1.20 H	33	43.8	4.2
5	*5610.00	105.5 PK			1.51 H	40	65.4	40.1
6	*5610.00	95.4 AV			1.51 H	40	55.3	40.1
7	#5725.00	56.0 PK	74.0	-18.0	1.44 H	33	51.9	4.1
8	#5725.00	43.3 AV	54.0	-10.7	1.44 H	33	39.2	4.1
9	11060.00	59.9 PK	74.0	-14.1	1.80 H	333	41.9	18.0
10	11060.00	46.9 AV	54.0	-7.1	1.80 H	333	28.9	18.0

ANTENNA POLARITY & TEST DISTANCE: VERTICAL AT 3 M								
NO.	FREQ. (MHz)	EMISSION LEVEL (dBuV/m)	LIMIT (dBuV/m)	MARGIN (dB)	ANTENNA HEIGHT (m)	TABLE ANGLE (Degree)	RAW VALUE (dBuV)	CORRECTION FACTOR (dB/m)
1	5460.00	59.7 PK	74.0	-14.3	1.80 V	344	55.5	4.2
2	5460.00	46.5 AV	54.0	-7.5	1.80 V	344	42.3	4.2
3	#5470.00	60.7 PK	74.0	-13.3	1.61 V	354	56.5	4.2
4	#5470.00	49.0 AV	54.0	-5.0	1.61 V	354	44.8	4.2
5	*5610.00	110.6 PK			1.50 V	339	70.5	40.1
6	*5610.00	100.5 AV			1.50 V	339	60.4	40.1
7	#5725.00	56.1 PK	74.0	-17.9	1.71 V	333	52.0	4.1
8	#5725.00	44.0 AV	54.0	-10.0	1.71 V	333	39.9	4.1
9	11060.00	59.8 PK	74.0	-14.2	1.80 V	291	41.8	18.0
10	11060.00	47.0 AV	54.0	-7.0	1.80 V	291	29.0	18.0

Remarks:

1. Emission Level(dBuV/m) = Raw Value(dBuV) + Correction Factor(dB/m)
2. Correction Factor(dB/m) = Antenna Factor(dB/m) + Cable Factor(dB) – Pre-Amplifier Factor(dB)
3. The other emission levels were very low against the limit.
4. Margin value = Emission Level – Limit value
5. " * ": Fundamental frequency.
6. " # ": The radiated frequency is out of the restricted band.

Test Mode C

802.11a

CHANNEL	TX Channel 52	DETECTOR FUNCTION	Peak (PK) Average (AV)
FREQUENCY RANGE	1GHz ~ 40GHz		

ANTENNA POLARITY & TEST DISTANCE: HORIZONTAL AT 3 M								
NO.	FREQ. (MHz)	EMISSION LEVEL (dBuV/m)	LIMIT (dBuV/m)	MARGIN (dB)	ANTENNA HEIGHT (m)	TABLE ANGLE (Degree)	RAW VALUE (dBuV)	CORRECTION FACTOR (dB/m)
1	5150.00	55.4 PK	74.0	-18.6	1.90 H	300	51.7	3.7
2	5150.00	44.3 AV	54.0	-9.7	1.90 H	300	40.6	3.7
3	*5260.00	106.0 PK			1.70 H	11	66.6	39.4
4	*5260.00	95.9 AV			1.70 H	11	56.5	39.4
5	#10520.00	66.8 PK	74.0	-7.2	1.86 H	333	50.0	16.8
6	#10520.00	52.7 AV	54.0	-1.3	1.86 H	333	35.9	16.8
ANTENNA POLARITY & TEST DISTANCE: VERTICAL AT 3 M								
NO.	FREQ. (MHz)	EMISSION LEVEL (dBuV/m)	LIMIT (dBuV/m)	MARGIN (dB)	ANTENNA HEIGHT (m)	TABLE ANGLE (Degree)	RAW VALUE (dBuV)	CORRECTION FACTOR (dB/m)
1	5150.00	58.2 PK	74.0	-15.8	1.80 V	351	54.5	3.7
2	5150.00	46.8 AV	54.0	-7.2	1.80 V	351	43.1	3.7
3	*5260.00	112.5 PK			1.77 V	347	73.1	39.4
4	*5260.00	102.7 AV			1.77 V	347	63.3	39.4
5	#10520.00	59.2 PK	74.0	-14.8	2.00 V	313	42.4	16.8
6	#10520.00	46.1 AV	54.0	-7.9	2.00 V	313	29.3	16.8

Remarks:

1. Emission Level(dBuV/m) = Raw Value(dBuV) + Correction Factor(dB/m)
2. Correction Factor(dB/m) = Antenna Factor(dB/m) + Cable Factor(dB) – Pre-Amplifier Factor(dB)
3. The other emission levels were very low against the limit.
4. Margin value = Emission Level – Limit value
5. " * ": Fundamental frequency.
6. " # ": The radiated frequency is out of the restricted band.

CHANNEL	TX Channel 60	DETECTOR FUNCTION	Peak (PK)
FREQUENCY RANGE	1GHz ~ 40GHz		Average (AV)

ANTENNA POLARITY & TEST DISTANCE: HORIZONTAL AT 3 M								
NO.	FREQ. (MHz)	EMISSION LEVEL (dBuV/m)	LIMIT (dBuV/m)	MARGIN (dB)	ANTENNA HEIGHT (m)	TABLE ANGLE (Degree)	RAW VALUE (dBuV)	CORRECTION FACTOR (dB/m)
1	*5300.00	106.2 PK			1.72 H	14	66.8	39.4
2	*5300.00	95.9 AV			1.72 H	14	56.5	39.4
3	10600.00	64.9 PK	74.0	-9.1	1.85 H	330	48.0	16.9
4	10600.00	51.3 AV	54.0	-2.7	1.85 H	330	34.4	16.9
ANTENNA POLARITY & TEST DISTANCE: VERTICAL AT 3 M								
NO.	FREQ. (MHz)	EMISSION LEVEL (dBuV/m)	LIMIT (dBuV/m)	MARGIN (dB)	ANTENNA HEIGHT (m)	TABLE ANGLE (Degree)	RAW VALUE (dBuV)	CORRECTION FACTOR (dB/m)
1	*5300.00	113.1 PK			1.65 V	351	73.7	39.4
2	*5300.00	103.3 AV			1.65 V	351	63.9	39.4
3	10600.00	59.6 PK	74.0	-14.4	2.13 V	276	42.7	16.9
4	10600.00	46.5 AV	54.0	-7.5	2.13 V	276	29.6	16.9

Remarks:

1. Emission Level(dBuV/m) = Raw Value(dBuV) + Correction Factor(dB/m)
2. Correction Factor(dB/m) = Antenna Factor(dB/m) + Cable Factor(dB) – Pre-Amplifier Factor(dB)
3. The other emission levels were very low against the limit.
4. Margin value = Emission Level – Limit value
5. " * ": Fundamental frequency.
6. " # ": The radiated frequency is out of the restricted band.

CHANNEL	TX Channel 64	DETECTOR FUNCTION	Peak (PK)
FREQUENCY RANGE	1GHz ~ 40GHz		Average (AV)

ANTENNA POLARITY & TEST DISTANCE: HORIZONTAL AT 3 M								
NO.	FREQ. (MHz)	EMISSION LEVEL (dBuV/m)	LIMIT (dBuV/m)	MARGIN (dB)	ANTENNA HEIGHT (m)	TABLE ANGLE (Degree)	RAW VALUE (dBuV)	CORRECTION FACTOR (dB/m)
1	*5320.00	106.0 PK			1.72 H	15	66.6	39.4
2	*5320.00	96.4 AV			1.72 H	15	57.0	39.4
3	5350.00	58.3 PK	74.0	-15.7	1.67 H	313	54.5	3.8
4	5350.00	47.1 AV	54.0	-6.9	1.67 H	313	43.3	3.8
5	10640.00	62.3 PK	74.0	-11.7	1.85 H	333	45.3	17.0
6	10640.00	50.3 AV	54.0	-3.7	1.85 H	333	33.3	17.0
ANTENNA POLARITY & TEST DISTANCE: VERTICAL AT 3 M								
NO.	FREQ. (MHz)	EMISSION LEVEL (dBuV/m)	LIMIT (dBuV/m)	MARGIN (dB)	ANTENNA HEIGHT (m)	TABLE ANGLE (Degree)	RAW VALUE (dBuV)	CORRECTION FACTOR (dB/m)
1	*5320.00	111.8 PK			1.96 V	321	72.3	39.5
2	*5320.00	102.5 AV			1.96 V	321	63.0	39.5
3	5350.00	65.3 PK	74.0	-8.7	1.49 V	348	61.5	3.8
4	5350.00	51.7 AV	54.0	-2.3	1.49 V	348	47.9	3.8
5	10640.00	59.5 PK	74.0	-14.5	2.00 V	290	42.5	17.0
6	10640.00	46.4 AV	54.0	-7.6	2.00 V	290	29.4	17.0

Remarks:

1. Emission Level(dBuV/m) = Raw Value(dBuV) + Correction Factor(dB/m)
2. Correction Factor(dB/m) = Antenna Factor(dB/m) + Cable Factor(dB) – Pre-Amplifier Factor(dB)
3. The other emission levels were very low against the limit.
4. Margin value = Emission Level – Limit value
5. " * ": Fundamental frequency.
6. " # ": The radiated frequency is out of the restricted band.

CHANNEL	TX Channel 100	DETECTOR FUNCTION	Peak (PK)
FREQUENCY RANGE	1GHz ~ 40GHz		Average (AV)

ANTENNA POLARITY & TEST DISTANCE: HORIZONTAL AT 3 M								
NO.	FREQ. (MHz)	EMISSION LEVEL (dBuV/m)	LIMIT (dBuV/m)	MARGIN (dB)	ANTENNA HEIGHT (m)	TABLE ANGLE (Degree)	RAW VALUE (dBuV)	CORRECTION FACTOR (dB/m)
1	5460.00	58.5 PK	74.0	-15.5	2.00 H	317	54.3	4.2
2	5460.00	46.2 AV	54.0	-7.8	2.00 H	317	42.0	4.2
3	#5470.00	66.1 PK	74.0	-7.9	1.97 H	319	61.9	4.2
4	#5470.00	50.1 AV	54.0	-3.9	1.97 H	319	45.9	4.2
5	*5500.00	106.4 PK			1.84 H	324	66.3	40.1
6	*5500.00	96.4 AV			1.84 H	324	56.3	40.1
7	11000.00	63.7 PK	74.0	-10.3	1.82 H	20	45.0	18.7
8	11000.00	50.7 AV	54.0	-3.3	1.82 H	20	32.0	18.7
ANTENNA POLARITY & TEST DISTANCE: VERTICAL AT 3 M								
NO.	FREQ. (MHz)	EMISSION LEVEL (dBuV/m)	LIMIT (dBuV/m)	MARGIN (dB)	ANTENNA HEIGHT (m)	TABLE ANGLE (Degree)	RAW VALUE (dBuV)	CORRECTION FACTOR (dB/m)
1	5460.00	56.7 PK	74.0	-17.3	1.40 V	350	52.5	4.2
2	5460.00	45.5 AV	54.0	-8.5	1.40 V	350	41.3	4.2
3	#5470.00	69.6 PK	74.0	-4.4	1.34 V	333	65.4	4.2
4	#5470.00	52.4 AV	54.0	-1.6	1.34 V	333	48.2	4.2
5	*5500.00	109.8 PK			1.37 V	335	69.7	40.1
6	*5500.00	100.4 AV			1.37 V	335	60.3	40.1
7	11000.00	60.9 PK	74.0	-13.1	1.50 V	333	42.2	18.7
8	11000.00	47.7 AV	54.0	-6.3	1.50 V	333	29.0	18.7

Remarks:

1. Emission Level(dBuV/m) = Raw Value(dBuV) + Correction Factor(dB/m)
2. Correction Factor(dB/m) = Antenna Factor(dB/m) + Cable Factor(dB) – Pre-Amplifier Factor(dB)
3. The other emission levels were very low against the limit.
4. Margin value = Emission Level – Limit value
5. " * ": Fundamental frequency.
6. " # ": The radiated frequency is out of the restricted band.

CHANNEL	TX Channel 116	DETECTOR FUNCTION	Peak (PK)
FREQUENCY RANGE	1GHz ~ 40GHz		Average (AV)

ANTENNA POLARITY & TEST DISTANCE: HORIZONTAL AT 3 M								
NO.	FREQ. (MHz)	EMISSION LEVEL (dBuV/m)	LIMIT (dBuV/m)	MARGIN (dB)	ANTENNA HEIGHT (m)	TABLE ANGLE (Degree)	RAW VALUE (dBuV)	CORRECTION FACTOR (dB/m)
1	*5580.00	109.6 PK			2.60 H	343	69.6	40.0
2	*5580.00	99.7 AV			2.60 H	343	59.7	40.0
3	11160.00	64.5 PK	74.0	-9.5	1.56 H	344	46.8	17.7
4	11160.00	52.4 AV	54.0	-1.6	1.56 H	344	34.7	17.7
ANTENNA POLARITY & TEST DISTANCE: VERTICAL AT 3 M								
NO.	FREQ. (MHz)	EMISSION LEVEL (dBuV/m)	LIMIT (dBuV/m)	MARGIN (dB)	ANTENNA HEIGHT (m)	TABLE ANGLE (Degree)	RAW VALUE (dBuV)	CORRECTION FACTOR (dB/m)
1	*5580.00	110.7 PK			1.57 V	335	70.7	40.0
2	*5580.00	101.6 AV			1.57 V	335	61.6	40.0
3	11160.00	59.8 PK	74.0	-14.2	1.69 V	300	42.1	17.7
4	11160.00	47.2 AV	54.0	-6.8	1.69 V	300	29.5	17.7

Remarks:

1. Emission Level(dBuV/m) = Raw Value(dBuV) + Correction Factor(dB/m)
2. Correction Factor(dB/m) = Antenna Factor(dB/m) + Cable Factor(dB) – Pre-Amplifier Factor(dB)
3. The other emission levels were very low against the limit.
4. Margin value = Emission Level – Limit value
5. " * ": Fundamental frequency.
6. " # ": The radiated frequency is out of the restricted band.

CHANNEL	TX Channel 140	DETECTOR FUNCTION	Peak (PK)
FREQUENCY RANGE	1GHz ~ 40GHz		Average (AV)

ANTENNA POLARITY & TEST DISTANCE: HORIZONTAL AT 3 M								
NO.	FREQ. (MHz)	EMISSION LEVEL (dBuV/m)	LIMIT (dBuV/m)	MARGIN (dB)	ANTENNA HEIGHT (m)	TABLE ANGLE (Degree)	RAW VALUE (dBuV)	CORRECTION FACTOR (dB/m)
1	*5700.00	108.6 PK			2.09 H	318	68.6	40.0
2	*5700.00	99.3 AV			2.09 H	318	59.3	40.0
3	#5725.00	61.6 PK	74.0	-12.4	2.01 H	307	57.5	4.1
4	#5725.00	48.7 AV	54.0	-5.3	2.01 H	307	44.6	4.1
5	11400.00	65.2 PK	74.0	-8.8	1.83 H	356	47.5	17.7
6	11400.00	52.4 AV	54.0	-1.6	1.83 H	356	34.7	17.7
ANTENNA POLARITY & TEST DISTANCE: VERTICAL AT 3 M								
NO.	FREQ. (MHz)	EMISSION LEVEL (dBuV/m)	LIMIT (dBuV/m)	MARGIN (dB)	ANTENNA HEIGHT (m)	TABLE ANGLE (Degree)	RAW VALUE (dBuV)	CORRECTION FACTOR (dB/m)
1	*5700.00	111.3 PK			1.60 V	318	71.3	40.0
2	*5700.00	101.5 AV			1.60 V	318	61.5	40.0
3	#5725.00	66.1 PK	74.0	-7.9	1.80 V	19	62.0	4.1
4	#5725.00	52.1 AV	54.0	-1.9	1.80 V	19	48.0	4.1
5	11400.00	61.2 PK	74.0	-12.8	1.75 V	298	43.5	17.7
6	11400.00	48.2 AV	54.0	-5.8	1.75 V	298	30.5	17.7

Remarks:

1. Emission Level(dBuV/m) = Raw Value(dBuV) + Correction Factor(dB/m)
2. Correction Factor(dB/m) = Antenna Factor(dB/m) + Cable Factor(dB) – Pre-Amplifier Factor(dB)
3. The other emission levels were very low against the limit.
4. Margin value = Emission Level – Limit value
5. " * ": Fundamental frequency.
6. " # ": The radiated frequency is out of the restricted band.

802.11n (HT20)

CHANNEL	TX Channel 52	DETECTOR FUNCTION	Peak (PK)
FREQUENCY RANGE	1GHz ~ 40GHz		Average (AV)

ANTENNA POLARITY & TEST DISTANCE: HORIZONTAL AT 3 M								
NO.	FREQ. (MHz)	EMISSION LEVEL (dBuV/m)	LIMIT (dBuV/m)	MARGIN (dB)	ANTENNA HEIGHT (m)	TABLE ANGLE (Degree)	RAW VALUE (dBuV)	CORRECTION FACTOR (dB/m)
1	5150.00	56.3 PK	74.0	-17.7	1.70 H	333	52.6	3.7
2	5150.00	45.6 AV	54.0	-8.4	1.70 H	333	41.9	3.7
3	*5260.00	105.2 PK			1.72 H	339	65.8	39.4
4	*5260.00	95.7 AV			1.72 H	339	56.3	39.4
5	#10520.00	66.1 PK	74.0	-7.9	1.82 H	332	49.3	16.8
6	#10520.00	51.8 AV	54.0	-2.2	1.82 H	332	35.0	16.8
ANTENNA POLARITY & TEST DISTANCE: VERTICAL AT 3 M								
NO.	FREQ. (MHz)	EMISSION LEVEL (dBuV/m)	LIMIT (dBuV/m)	MARGIN (dB)	ANTENNA HEIGHT (m)	TABLE ANGLE (Degree)	RAW VALUE (dBuV)	CORRECTION FACTOR (dB/m)
1	5150.00	55.6 PK	74.0	-18.4	1.60 V	320	51.9	3.7
2	5150.00	44.2 AV	54.0	-9.8	1.60 V	320	40.5	3.7
3	*5260.00	112.7 PK			1.60 V	354	73.3	39.4
4	*5260.00	102.3 AV			1.60 V	354	62.9	39.4
5	#10520.00	59.4 PK	74.0	-14.6	2.11 V	322	42.6	16.8
6	#10520.00	46.2 AV	54.0	-7.8	2.11 V	322	29.4	16.8

Remarks:

1. Emission Level(dBuV/m) = Raw Value(dBuV) + Correction Factor(dB/m)
2. Correction Factor(dB/m) = Antenna Factor(dB/m) + Cable Factor(dB) – Pre-Amplifier Factor(dB)
3. The other emission levels were very low against the limit.
4. Margin value = Emission Level – Limit value
5. " * ": Fundamental frequency.
6. " # ": The radiated frequency is out of the restricted band.

CHANNEL	TX Channel 60	DETECTOR FUNCTION	Peak (PK)
FREQUENCY RANGE	1GHz ~ 40GHz		Average (AV)

ANTENNA POLARITY & TEST DISTANCE: HORIZONTAL AT 3 M								
NO.	FREQ. (MHz)	EMISSION LEVEL (dBuV/m)	LIMIT (dBuV/m)	MARGIN (dB)	ANTENNA HEIGHT (m)	TABLE ANGLE (Degree)	RAW VALUE (dBuV)	CORRECTION FACTOR (dB/m)
1	*5300.00	105.5 PK			1.76 H	341	66.1	39.4
2	*5300.00	95.7 AV			1.76 H	341	56.3	39.4
3	10600.00	66.5 PK	74.0	-7.5	1.96 H	312	49.6	16.9
4	10600.00	52.2 AV	54.0	-1.8	1.96 H	312	35.3	16.9
ANTENNA POLARITY & TEST DISTANCE: VERTICAL AT 3 M								
NO.	FREQ. (MHz)	EMISSION LEVEL (dBuV/m)	LIMIT (dBuV/m)	MARGIN (dB)	ANTENNA HEIGHT (m)	TABLE ANGLE (Degree)	RAW VALUE (dBuV)	CORRECTION FACTOR (dB/m)
1	*5300.00	113.7 PK			1.59 V	344	74.3	39.4
2	*5300.00	103.4 AV			1.59 V	344	64.0	39.4
3	10600.00	64.9 PK	74.0	-9.1	1.78 V	343	48.0	16.9
4	10600.00	49.4 AV	54.0	-4.6	1.78 V	343	32.5	16.9

Remarks:

1. Emission Level(dBuV/m) = Raw Value(dBuV) + Correction Factor(dB/m)
2. Correction Factor(dB/m) = Antenna Factor(dB/m) + Cable Factor(dB) – Pre-Amplifier Factor(dB)
3. The other emission levels were very low against the limit.
4. Margin value = Emission Level – Limit value
5. " * ": Fundamental frequency.
6. " # ": The radiated frequency is out of the restricted band.

CHANNEL	TX Channel 64	DETECTOR FUNCTION	Peak (PK)
FREQUENCY RANGE	1GHz ~ 40GHz		Average (AV)

ANTENNA POLARITY & TEST DISTANCE: HORIZONTAL AT 3 M								
NO.	FREQ. (MHz)	EMISSION LEVEL (dBuV/m)	LIMIT (dBuV/m)	MARGIN (dB)	ANTENNA HEIGHT (m)	TABLE ANGLE (Degree)	RAW VALUE (dBuV)	CORRECTION FACTOR (dB/m)
1	*5320.00	106.6 PK			1.87 H	327	67.1	39.5
2	*5320.00	97.1 AV			1.87 H	327	57.6	39.5
3	5350.00	58.5 PK	74.0	-15.5	1.66 H	329	54.7	3.8
4	5350.00	47.5 AV	54.0	-6.5	1.66 H	329	43.7	3.8
5	10640.00	62.6 PK	74.0	-11.4	1.71 H	332	45.6	17.0
6	10640.00	49.6 AV	54.0	-4.4	1.71 H	332	32.6	17.0
ANTENNA POLARITY & TEST DISTANCE: VERTICAL AT 3 M								
NO.	FREQ. (MHz)	EMISSION LEVEL (dBuV/m)	LIMIT (dBuV/m)	MARGIN (dB)	ANTENNA HEIGHT (m)	TABLE ANGLE (Degree)	RAW VALUE (dBuV)	CORRECTION FACTOR (dB/m)
1	*5320.00	114.4 PK			1.70 V	345	74.9	39.5
2	*5320.00	104.0 AV			1.70 V	345	64.5	39.5
3	5350.00	65.9 PK	74.0	-8.1	1.55 V	349	62.1	3.8
4	5350.00	50.9 AV	54.0	-3.1	1.55 V	349	47.1	3.8
5	10640.00	62.3 PK	74.0	-11.7	1.67 V	343	45.3	17.0
6	10640.00	49.2 AV	54.0	-4.8	1.67 V	343	32.2	17.0

Remarks:

1. Emission Level(dBuV/m) = Raw Value(dBuV) + Correction Factor(dB/m)
2. Correction Factor(dB/m) = Antenna Factor(dB/m) + Cable Factor(dB) – Pre-Amplifier Factor(dB)
3. The other emission levels were very low against the limit.
4. Margin value = Emission Level – Limit value
5. " * ": Fundamental frequency.
6. " # ": The radiated frequency is out of the restricted band.

CHANNEL	TX Channel 100	DETECTOR FUNCTION	Peak (PK)
FREQUENCY RANGE	1GHz ~ 40GHz		Average (AV)

ANTENNA POLARITY & TEST DISTANCE: HORIZONTAL AT 3 M								
NO.	FREQ. (MHz)	EMISSION LEVEL (dBuV/m)	LIMIT (dBuV/m)	MARGIN (dB)	ANTENNA HEIGHT (m)	TABLE ANGLE (Degree)	RAW VALUE (dBuV)	CORRECTION FACTOR (dB/m)
1	5460.00	55.4 PK	74.0	-18.6	1.56 H	347	51.2	4.2
2	5460.00	42.8 AV	54.0	-11.2	1.56 H	347	38.6	4.2
3	#5470.00	63.9 PK	74.0	-10.1	1.70 H	326	59.7	4.2
4	#5470.00	49.0 AV	54.0	-5.0	1.70 H	326	44.8	4.2
5	*5500.00	106.2 PK			2.05 H	330	66.1	40.1
6	*5500.00	95.8 AV			2.05 H	330	55.7	40.1
7	11000.00	63.2 PK	74.0	-10.8	1.36 H	63	44.5	18.7
8	11000.00	50.1 AV	54.0	-3.9	1.36 H	63	31.4	18.7
ANTENNA POLARITY & TEST DISTANCE: VERTICAL AT 3 M								
NO.	FREQ. (MHz)	EMISSION LEVEL (dBuV/m)	LIMIT (dBuV/m)	MARGIN (dB)	ANTENNA HEIGHT (m)	TABLE ANGLE (Degree)	RAW VALUE (dBuV)	CORRECTION FACTOR (dB/m)
1	5460.00	55.3 PK	74.0	-18.7	1.14 V	355	51.1	4.2
2	5460.00	43.1 AV	54.0	-10.9	1.14 V	355	38.9	4.2
3	#5470.00	66.8 PK	74.0	-7.2	1.13 V	359	62.6	4.2
4	#5470.00	52.2 AV	54.0	-1.8	1.13 V	359	48.0	4.2
5	*5500.00	111.6 PK			1.20 V	348	71.5	40.1
6	*5500.00	100.7 AV			1.20 V	348	60.6	40.1
7	11000.00	60.2 PK	74.0	-13.8	1.76 V	59	41.5	18.7
8	11000.00	47.1 AV	54.0	-6.9	1.76 V	59	28.4	18.7

Remarks:

1. Emission Level(dBuV/m) = Raw Value(dBuV) + Correction Factor(dB/m)
2. Correction Factor(dB/m) = Antenna Factor(dB/m) + Cable Factor(dB) – Pre-Amplifier Factor(dB)
3. The other emission levels were very low against the limit.
4. Margin value = Emission Level – Limit value
5. " * ": Fundamental frequency.
6. " # ": The radiated frequency is out of the restricted band.

CHANNEL	TX Channel 116	DETECTOR	Peak (PK)
FREQUENCY RANGE	1GHz ~ 40GHz	FUNCTION	Average (AV)

ANTENNA POLARITY & TEST DISTANCE: HORIZONTAL AT 3 M								
NO.	FREQ. (MHz)	EMISSION LEVEL (dBuV/m)	LIMIT (dBuV/m)	MARGIN (dB)	ANTENNA HEIGHT (m)	TABLE ANGLE (Degree)	RAW VALUE (dBuV)	CORRECTION FACTOR (dB/m)
1	*5580.00	107.9 PK			1.99 H	331	67.9	40.0
2	*5580.00	97.5 AV			1.99 H	331	57.5	40.0
3	11160.00	65.2 PK	74.0	-8.8	1.52 H	351	47.5	17.7
4	11160.00	51.4 AV	54.0	-2.6	1.52 H	351	33.7	17.7
ANTENNA POLARITY & TEST DISTANCE: VERTICAL AT 3 M								
NO.	FREQ. (MHz)	EMISSION LEVEL (dBuV/m)	LIMIT (dBuV/m)	MARGIN (dB)	ANTENNA HEIGHT (m)	TABLE ANGLE (Degree)	RAW VALUE (dBuV)	CORRECTION FACTOR (dB/m)
1	*5580.00	111.9 PK			1.14 V	344	71.9	40.0
2	*5580.00	101.3 AV			1.14 V	344	61.3	40.0
3	11160.00	59.9 PK	74.0	-14.1	1.76 V	353	42.2	17.7
4	11160.00	46.3 AV	54.0	-7.7	1.76 V	353	28.6	17.7

Remarks:

1. Emission Level(dBuV/m) = Raw Value(dBuV) + Correction Factor(dB/m)
2. Correction Factor(dB/m) = Antenna Factor(dB/m) + Cable Factor(dB) – Pre-Amplifier Factor(dB)
3. The other emission levels were very low against the limit.
4. Margin value = Emission Level – Limit value
5. " * ": Fundamental frequency.
6. " # ": The radiated frequency is out of the restricted band.

CHANNEL	TX Channel 140	DETECTOR FUNCTION	Peak (PK)
FREQUENCY RANGE	1GHz ~ 40GHz		Average (AV)

ANTENNA POLARITY & TEST DISTANCE: HORIZONTAL AT 3 M								
NO.	FREQ. (MHz)	EMISSION LEVEL (dBuV/m)	LIMIT (dBuV/m)	MARGIN (dB)	ANTENNA HEIGHT (m)	TABLE ANGLE (Degree)	RAW VALUE (dBuV)	CORRECTION FACTOR (dB/m)
1	*5700.00	108.3 PK			2.04 H	323	68.3	40.0
2	*5700.00	97.3 AV			2.04 H	323	57.3	40.0
3	#5725.00	57.7 PK	74.0	-16.3	2.58 H	321	53.6	4.1
4	#5725.00	47.3 AV	54.0	-6.7	2.58 H	321	43.2	4.1
5	11400.00	66.0 PK	74.0	-8.0	1.84 H	58	48.3	17.7
6	11400.00	52.3 AV	54.0	-1.7	1.84 H	58	34.6	17.7
ANTENNA POLARITY & TEST DISTANCE: VERTICAL AT 3 M								
NO.	FREQ. (MHz)	EMISSION LEVEL (dBuV/m)	LIMIT (dBuV/m)	MARGIN (dB)	ANTENNA HEIGHT (m)	TABLE ANGLE (Degree)	RAW VALUE (dBuV)	CORRECTION FACTOR (dB/m)
1	*5700.00	110.9 PK			1.45 V	329	70.9	40.0
2	*5700.00	100.1 AV			1.45 V	329	60.1	40.0
3	#5725.00	67.8 PK	74.0	-6.2	1.44 V	330	63.7	4.1
4	#5725.00	52.2 AV	54.0	-1.8	1.44 V	330	48.1	4.1
5	11400.00	60.5 PK	74.0	-13.5	1.89 V	344	42.8	17.7
6	11400.00	47.1 AV	54.0	-6.9	1.89 V	344	29.4	17.7

Remarks:

1. Emission Level(dBuV/m) = Raw Value(dBuV) + Correction Factor(dB/m)
2. Correction Factor(dB/m) = Antenna Factor(dB/m) + Cable Factor(dB) – Pre-Amplifier Factor(dB)
3. The other emission levels were very low against the limit.
4. Margin value = Emission Level – Limit value
5. " * ": Fundamental frequency.
6. " # ": The radiated frequency is out of the restricted band.

802.11n (HT40)

CHANNEL	TX Channel 54	DETECTOR	Peak (PK)
FREQUENCY RANGE	1GHz ~ 40GHz	FUNCTION	Average (AV)

ANTENNA POLARITY & TEST DISTANCE: HORIZONTAL AT 3 M								
NO.	FREQ. (MHz)	EMISSION LEVEL (dBuV/m)	LIMIT (dBuV/m)	MARGIN (dB)	ANTENNA HEIGHT (m)	TABLE ANGLE (Degree)	RAW VALUE (dBuV)	CORRECTION FACTOR (dB/m)
1	5150.00	55.8 PK	74.0	-18.2	3.18 H	346	52.1	3.7
2	5150.00	43.0 AV	54.0	-11.0	3.18 H	346	39.3	3.7
3	*5270.00	105.5 PK			3.54 H	330	66.1	39.4
4	*5270.00	95.9 AV			3.54 H	330	56.5	39.4
5	#10540.00	64.5 PK	74.0	-9.5	1.64 H	326	47.6	16.9
6	#10540.00	51.3 AV	54.0	-2.7	1.64 H	326	34.4	16.9
ANTENNA POLARITY & TEST DISTANCE: VERTICAL AT 3 M								
NO.	FREQ. (MHz)	EMISSION LEVEL (dBuV/m)	LIMIT (dBuV/m)	MARGIN (dB)	ANTENNA HEIGHT (m)	TABLE ANGLE (Degree)	RAW VALUE (dBuV)	CORRECTION FACTOR (dB/m)
1	5150.00	47.0 PK	74.0	-27.0	1.31 V	334	43.3	3.7
2	5150.00	42.9 AV	54.0	-11.1	1.31 V	334	39.2	3.7
3	*5270.00	110.2 PK			1.41 V	338	70.8	39.4
4	*5270.00	100.4 AV			1.41 V	338	61.0	39.4
5	#10540.00	59.5 PK	74.0	-14.5	1.57 V	258	42.6	16.9
6	#10540.00	46.7 AV	54.0	-7.3	1.57 V	258	29.8	16.9

Remarks:

1. Emission Level(dBuV/m) = Raw Value(dBuV) + Correction Factor(dB/m)
2. Correction Factor(dB/m) = Antenna Factor(dB/m) + Cable Factor(dB) – Pre-Amplifier Factor(dB)
3. The other emission levels were very low against the limit.
4. Margin value = Emission Level – Limit value
5. " * ": Fundamental frequency.
6. " # ": The radiated frequency is out of the restricted band.

CHANNEL	TX Channel 62	DETECTOR FUNCTION	Peak (PK)
FREQUENCY RANGE	1GHz ~ 40GHz		Average (AV)

ANTENNA POLARITY & TEST DISTANCE: HORIZONTAL AT 3 M								
NO.	FREQ. (MHz)	EMISSION LEVEL (dBuV/m)	LIMIT (dBuV/m)	MARGIN (dB)	ANTENNA HEIGHT (m)	TABLE ANGLE (Degree)	RAW VALUE (dBuV)	CORRECTION FACTOR (dB/m)
1	*5310.00	104.9 PK			3.70 H	329	65.5	39.4
2	*5310.00	95.4 AV			3.70 H	329	56.0	39.4
3	5350.00	65.3 PK	74.0	-8.7	1.79 H	9	61.5	3.8
4	5350.00	51.8 AV	54.0	-2.2	1.79 H	9	48.0	3.8
5	10620.00	59.4 PK	74.0	-14.6	2.24 H	11	42.3	17.1
6	10620.00	46.9 AV	54.0	-7.1	2.24 H	11	29.8	17.1
ANTENNA POLARITY & TEST DISTANCE: VERTICAL AT 3 M								
NO.	FREQ. (MHz)	EMISSION LEVEL (dBuV/m)	LIMIT (dBuV/m)	MARGIN (dB)	ANTENNA HEIGHT (m)	TABLE ANGLE (Degree)	RAW VALUE (dBuV)	CORRECTION FACTOR (dB/m)
1	*5310.00	107.9 PK			1.13 V	357	68.5	39.4
2	*5310.00	98.6 AV			1.13 V	357	59.2	39.4
3	5350.00	67.3 PK	74.0	-6.7	1.09 V	345	63.5	3.8
4	5350.00	52.3 AV	54.0	-1.7	1.09 V	345	48.5	3.8
5	10620.00	59.2 PK	74.0	-14.8	1.82 V	245	42.1	17.1
6	10620.00	46.1 AV	54.0	-7.9	1.82 V	245	29.0	17.1

Remarks:

1. Emission Level(dBuV/m) = Raw Value(dBuV) + Correction Factor(dB/m)
2. Correction Factor(dB/m) = Antenna Factor(dB/m) + Cable Factor(dB) – Pre-Amplifier Factor(dB)
3. The other emission levels were very low against the limit.
4. Margin value = Emission Level – Limit value
5. " * ": Fundamental frequency.
6. " # ": The radiated frequency is out of the restricted band.

CHANNEL	TX Channel 102	DETECTOR FUNCTION	Peak (PK)
FREQUENCY RANGE	1GHz ~ 40GHz		Average (AV)

ANTENNA POLARITY & TEST DISTANCE: HORIZONTAL AT 3 M								
NO.	FREQ. (MHz)	EMISSION LEVEL (dBuV/m)	LIMIT (dBuV/m)	MARGIN (dB)	ANTENNA HEIGHT (m)	TABLE ANGLE (Degree)	RAW VALUE (dBuV)	CORRECTION FACTOR (dB/m)
1	5460.00	55.1 PK	74.0	-18.9	2.11 H	294	50.9	4.2
2	5460.00	42.7 AV	54.0	-11.3	2.11 H	294	38.5	4.2
3	#5470.00	63.0 PK	74.0	-11.0	1.90 H	326	58.8	4.2
4	#5470.00	48.4 AV	54.0	-5.6	1.90 H	326	44.2	4.2
5	*5510.00	97.8 PK			1.86 H	328	57.7	40.1
6	*5510.00	87.5 AV			1.86 H	328	47.4	40.1
7	11020.00	60.0 PK	74.0	-14.0	1.94 H	106	41.5	18.5
8	11020.00	47.1 AV	54.0	-6.9	1.94 H	106	28.6	18.5
ANTENNA POLARITY & TEST DISTANCE: VERTICAL AT 3 M								
NO.	FREQ. (MHz)	EMISSION LEVEL (dBuV/m)	LIMIT (dBuV/m)	MARGIN (dB)	ANTENNA HEIGHT (m)	TABLE ANGLE (Degree)	RAW VALUE (dBuV)	CORRECTION FACTOR (dB/m)
1	5460.00	56.7 PK	74.0	-17.3	1.22 V	308	52.5	4.2
2	5460.00	43.1 AV	54.0	-10.9	1.22 V	308	38.9	4.2
3	#5470.00	67.6 PK	74.0	-6.4	1.00 V	344	63.4	4.2
4	#5470.00	52.4 AV	54.0	-1.6	1.00 V	344	48.2	4.2
5	*5510.00	101.8 PK			1.08 V	349	61.7	40.1
6	*5510.00	91.5 AV			1.08 V	349	51.4	40.1
7	11020.00	60.4 PK	74.0	-13.6	1.76 V	341	41.9	18.5
8	11020.00	47.1 AV	54.0	-6.9	1.76 V	341	28.6	18.5

Remarks:

1. Emission Level(dBuV/m) = Raw Value(dBuV) + Correction Factor(dB/m)
2. Correction Factor(dB/m) = Antenna Factor(dB/m) + Cable Factor(dB) – Pre-Amplifier Factor(dB)
3. The other emission levels were very low against the limit.
4. Margin value = Emission Level – Limit value
5. " * ": Fundamental frequency.
6. " # ": The radiated frequency is out of the restricted band.

CHANNEL	TX Channel 110	DETECTOR FUNCTION	Peak (PK)
FREQUENCY RANGE	1GHz ~ 40GHz		Average (AV)

ANTENNA POLARITY & TEST DISTANCE: HORIZONTAL AT 3 M								
NO.	FREQ. (MHz)	EMISSION LEVEL (dBuV/m)	LIMIT (dBuV/m)	MARGIN (dB)	ANTENNA HEIGHT (m)	TABLE ANGLE (Degree)	RAW VALUE (dBuV)	CORRECTION FACTOR (dB/m)
1	*5550.00	102.7 PK			2.02 H	331	62.7	40.0
2	*5550.00	92.8 AV			2.02 H	331	52.8	40.0
3	11100.00	62.5 PK	74.0	-11.5	1.58 H	58	44.9	17.6
4	11100.00	48.9 AV	54.0	-5.1	1.58 H	58	31.3	17.6
ANTENNA POLARITY & TEST DISTANCE: VERTICAL AT 3 M								
NO.	FREQ. (MHz)	EMISSION LEVEL (dBuV/m)	LIMIT (dBuV/m)	MARGIN (dB)	ANTENNA HEIGHT (m)	TABLE ANGLE (Degree)	RAW VALUE (dBuV)	CORRECTION FACTOR (dB/m)
1	*5550.00	107.7 PK			1.05 V	350	67.7	40.0
2	*5550.00	97.2 AV			1.05 V	350	57.2	40.0
3	11100.00	60.1 PK	74.0	-13.9	1.64 V	307	42.5	17.6
4	11100.00	46.5 AV	54.0	-7.5	1.64 V	307	28.9	17.6

Remarks:

1. Emission Level(dBuV/m) = Raw Value(dBuV) + Correction Factor(dB/m)
2. Correction Factor(dB/m) = Antenna Factor(dB/m) + Cable Factor(dB) – Pre-Amplifier Factor(dB)
3. The other emission levels were very low against the limit.
4. Margin value = Emission Level – Limit value
5. " * ": Fundamental frequency.
6. " # ": The radiated frequency is out of the restricted band.

CHANNEL	TX Channel 134	DETECTOR FUNCTION	Peak (PK)
FREQUENCY RANGE	1GHz ~ 40GHz		Average (AV)

ANTENNA POLARITY & TEST DISTANCE: HORIZONTAL AT 3 M								
NO.	FREQ. (MHz)	EMISSION LEVEL (dBuV/m)	LIMIT (dBuV/m)	MARGIN (dB)	ANTENNA HEIGHT (m)	TABLE ANGLE (Degree)	RAW VALUE (dBuV)	CORRECTION FACTOR (dB/m)
1	*5670.00	105.8 PK			1.95 H	327	65.7	40.1
2	*5670.00	96.0 AV			1.95 H	327	55.9	40.1
3	#5725.00	61.4 PK	74.0	-12.6	3.36 H	319	57.3	4.1
4	#5725.00	47.0 AV	54.0	-7.0	3.36 H	319	42.9	4.1
5	11340.00	64.4 PK	74.0	-9.6	1.54 H	61	46.5	17.9
6	11340.00	50.9 AV	54.0	-3.1	1.54 H	61	33.0	17.9
ANTENNA POLARITY & TEST DISTANCE: VERTICAL AT 3 M								
NO.	FREQ. (MHz)	EMISSION LEVEL (dBuV/m)	LIMIT (dBuV/m)	MARGIN (dB)	ANTENNA HEIGHT (m)	TABLE ANGLE (Degree)	RAW VALUE (dBuV)	CORRECTION FACTOR (dB/m)
1	*5670.00	108.3 PK			1.39 V	327	68.2	40.1
2	*5670.00	98.3 AV			1.39 V	327	58.2	40.1
3	#5725.00	62.7 PK	74.0	-11.3	1.42 V	330	58.6	4.1
4	#5725.00	48.4 AV	54.0	-5.6	1.42 V	330	44.3	4.1
5	11340.00	61.0 PK	74.0	-13.0	1.45 V	318	43.1	17.9
6	11340.00	46.9 AV	54.0	-7.1	1.45 V	318	29.0	17.9

Remarks:

1. Emission Level(dBuV/m) = Raw Value(dBuV) + Correction Factor(dB/m)
2. Correction Factor(dB/m) = Antenna Factor(dB/m) + Cable Factor(dB) – Pre-Amplifier Factor(dB)
3. The other emission levels were very low against the limit.
4. Margin value = Emission Level – Limit value
5. " * ": Fundamental frequency.
6. " # ": The radiated frequency is out of the restricted band.

802.11ac (VHT80)

CHANNEL	TX Channel 58	DETECTOR FUNCTION	Peak (PK)
FREQUENCY RANGE	1GHz ~ 40GHz		Average (AV)

ANTENNA POLARITY & TEST DISTANCE: HORIZONTAL AT 3 M								
NO.	FREQ. (MHz)	EMISSION LEVEL (dBuV/m)	LIMIT (dBuV/m)	MARGIN (dB)	ANTENNA HEIGHT (m)	TABLE ANGLE (Degree)	RAW VALUE (dBuV)	CORRECTION FACTOR (dB/m)
1	5150.00	55.5 PK	74.0	-18.5	2.54 H	326	51.8	3.7
2	5150.00	42.8 AV	54.0	-11.2	2.54 H	326	39.1	3.7
3	*5290.00	99.5 PK			3.01 H	294	60.1	39.4
4	*5290.00	88.1 AV			3.01 H	294	48.7	39.4
5	5350.00	64.3 PK	74.0	-9.7	2.74 H	345	60.5	3.8
6	5350.00	51.3 AV	54.0	-2.7	2.74 H	345	47.5	3.8
7	#10580.00	59.5 PK	74.0	-14.5	1.93 H	322	42.5	17.0
8	#10580.00	46.5 AV	54.0	-7.5	1.93 H	322	29.5	17.0
ANTENNA POLARITY & TEST DISTANCE: VERTICAL AT 3 M								
NO.	FREQ. (MHz)	EMISSION LEVEL (dBuV/m)	LIMIT (dBuV/m)	MARGIN (dB)	ANTENNA HEIGHT (m)	TABLE ANGLE (Degree)	RAW VALUE (dBuV)	CORRECTION FACTOR (dB/m)
1	5150.00	56.2 PK	74.0	-17.8	1.30 V	326	52.5	3.7
2	5150.00	42.8 AV	54.0	-11.2	1.30 V	326	39.1	3.7
3	*5290.00	103.8 PK			1.34 V	336	64.4	39.4
4	*5290.00	91.9 AV			1.34 V	336	52.5	39.4
5	5350.00	66.3 PK	74.0	-7.7	1.11 V	338	62.5	3.8
6	5350.00	52.3 AV	54.0	-1.7	1.11 V	338	48.5	3.8
7	#10580.00	59.0 PK	74.0	-15.0	1.91 V	287	42.0	17.0
8	#10580.00	46.6 AV	54.0	-7.4	1.91 V	287	29.6	17.0

Remarks:

1. Emission Level(dBuV/m) = Raw Value(dBuV) + Correction Factor(dB/m)
2. Correction Factor(dB/m) = Antenna Factor(dB/m) + Cable Factor(dB) – Pre-Amplifier Factor(dB)
3. The other emission levels were very low against the limit.
4. Margin value = Emission Level – Limit value
5. " * ": Fundamental frequency.
6. " # ": The radiated frequency is out of the restricted band.

CHANNEL	TX Channel 106	DETECTOR FUNCTION	Peak (PK)
FREQUENCY RANGE	1GHz ~ 40GHz		Average (AV)

ANTENNA POLARITY & TEST DISTANCE: HORIZONTAL AT 3 M								
NO.	FREQ. (MHz)	EMISSION LEVEL (dBuV/m)	LIMIT (dBuV/m)	MARGIN (dB)	ANTENNA HEIGHT (m)	TABLE ANGLE (Degree)	RAW VALUE (dBuV)	CORRECTION FACTOR (dB/m)
1	5460.00	60.4 PK	74.0	-13.6	3.18 H	297	56.2	4.2
2	5460.00	43.6 AV	54.0	-10.4	3.18 H	297	39.4	4.2
3	#5470.00	63.5 PK	74.0	-10.5	3.49 H	332	59.3	4.2
4	#5470.00	48.6 AV	54.0	-5.4	3.49 H	332	44.4	4.2
5	*5530.00	93.2 PK			2.95 H	311	53.1	40.1
6	*5530.00	82.0 AV			2.95 H	311	41.9	40.1
7	#5725.00	56.0 PK	74.0	-18.0	3.14 H	309	51.9	4.1
8	#5725.00	42.4 AV	54.0	-11.6	3.14 H	309	38.3	4.1
9	11060.00	60.1 PK	74.0	-13.9	2.59 H	77	42.1	18.0
10	11060.00	46.9 AV	54.0	-7.1	2.59 H	77	28.9	18.0
ANTENNA POLARITY & TEST DISTANCE: VERTICAL AT 3 M								
NO.	FREQ. (MHz)	EMISSION LEVEL (dBuV/m)	LIMIT (dBuV/m)	MARGIN (dB)	ANTENNA HEIGHT (m)	TABLE ANGLE (Degree)	RAW VALUE (dBuV)	CORRECTION FACTOR (dB/m)
1	5460.00	63.4 PK	74.0	-10.6	1.21 V	354	59.2	4.2
2	5460.00	44.3 AV	54.0	-9.7	1.21 V	354	40.1	4.2
3	#5470.00	67.4 PK	74.0	-6.6	1.15 V	343	63.2	4.2
4	#5470.00	52.5 AV	54.0	-1.5	1.15 V	343	48.3	4.2
5	*5530.00	98.1 PK			1.10 V	350	58.0	40.1
6	*5530.00	86.5 AV			1.10 V	350	46.4	40.1
7	#5725.00	56.5 PK	74.0	-17.5	1.63 V	313	52.4	4.1
8	#5725.00	42.6 AV	54.0	-11.4	1.63 V	313	38.5	4.1
9	11060.00	61.2 PK	74.0	-12.8	1.36 V	268	43.2	18.0
10	11060.00	46.9 AV	54.0	-7.1	1.36 V	268	28.9	18.0

Remarks:

1. Emission Level(dBuV/m) = Raw Value(dBuV) + Correction Factor(dB/m)
2. Correction Factor(dB/m) = Antenna Factor(dB/m) + Cable Factor(dB) – Pre-Amplifier Factor(dB)
3. The other emission levels were very low against the limit.
4. Margin value = Emission Level – Limit value
5. " * ": Fundamental frequency.
6. " # ": The radiated frequency is out of the restricted band.

CHANNEL	TX Channel 122	DETECTOR FUNCTION	Peak (PK)
FREQUENCY RANGE	1GHz ~ 40GHz		Average (AV)

ANTENNA POLARITY & TEST DISTANCE: HORIZONTAL AT 3 M								
NO.	FREQ. (MHz)	EMISSION LEVEL (dBuV/m)	LIMIT (dBuV/m)	MARGIN (dB)	ANTENNA HEIGHT (m)	TABLE ANGLE (Degree)	RAW VALUE (dBuV)	CORRECTION FACTOR (dB/m)
1	5460.00	59.3 PK	74.0	-14.7	3.11 H	300	55.1	4.2
2	5460.00	44.3 AV	54.0	-9.7	3.11 H	300	40.1	4.2
3	#5470.00	60.7 PK	74.0	-13.3	3.49 H	333	56.5	4.2
4	#5470.00	47.7 AV	54.0	-6.3	3.49 H	333	43.5	4.2
5	*5610.00	93.0 PK			3.03 H	319	52.9	40.1
6	*5610.00	81.7 AV			3.03 H	319	41.6	40.1
7	#5725.00	55.3 PK	74.0	-18.7	3.20 H	309	51.2	4.1
8	#5725.00	43.4 AV	54.0	-10.6	3.20 H	309	39.3	4.1
9	11060.00	61.0 PK	74.0	-13.0	2.66 H	100	43.0	18.0
10	11060.00	48.0 AV	54.0	-6.0	2.66 H	100	30.0	18.0

ANTENNA POLARITY & TEST DISTANCE: VERTICAL AT 3 M								
NO.	FREQ. (MHz)	EMISSION LEVEL (dBuV/m)	LIMIT (dBuV/m)	MARGIN (dB)	ANTENNA HEIGHT (m)	TABLE ANGLE (Degree)	RAW VALUE (dBuV)	CORRECTION FACTOR (dB/m)
1	5460.00	61.5 PK	74.0	-12.5	1.31 V	339	57.3	4.2
2	5460.00	45.4 AV	54.0	-8.6	1.31 V	339	41.2	4.2
3	#5470.00	63.2 PK	74.0	-10.8	1.20 V	351	59.0	4.2
4	#5470.00	49.3 AV	54.0	-4.7	1.20 V	351	45.1	4.2
5	*5610.00	98.1 PK			1.20 V	339	58.0	40.1
6	*5610.00	86.4 AV			1.20 V	339	46.3	40.1
7	#5725.00	57.1 PK	74.0	-16.9	1.77 V	299	53.0	4.1
8	#5725.00	43.1 AV	54.0	-10.9	1.77 V	299	39.0	4.1
9	11060.00	62.0 PK	74.0	-12.0	1.40 V	268	44.0	18.0
10	11060.00	49.3 AV	54.0	-4.7	1.40 V	268	31.3	18.0

Remarks:

1. Emission Level(dBuV/m) = Raw Value(dBuV) + Correction Factor(dB/m)
2. Correction Factor(dB/m) = Antenna Factor(dB/m) + Cable Factor(dB) – Pre-Amplifier Factor(dB)
3. The other emission levels were very low against the limit.
4. Margin value = Emission Level – Limit value
5. " * ": Fundamental frequency.
6. " # ": The radiated frequency is out of the restricted band.

Below 1GHz Worst-Case Data: 802.11a

CHANNEL	TX Channel 52	DETECTOR FUNCTION	Quasi-Peak (QP)
FREQUENCY RANGE	30MHz ~ 1GHz	TEST MODE	A

ANTENNA POLARITY & TEST DISTANCE: HORIZONTAL AT 3 M								
NO.	FREQ. (MHz)	EMISSION LEVEL (dBuV/m)	LIMIT (dBuV/m)	MARGIN (dB)	ANTENNA HEIGHT (m)	TABLE ANGLE (Degree)	RAW VALUE (dBuV)	CORRECTION FACTOR (dB/m)
1	92.12	27.0 QP	43.5	-16.5	1.99 H	104	46.6	-19.6
2	160.17	31.1 QP	43.5	-12.4	1.50 H	237	44.9	-13.8
3	432.37	29.8 QP	46.0	-16.2	1.00 H	36	40.1	-10.3
4	578.19	26.0 QP	46.0	-20.0	1.00 H	197	33.9	-7.9
5	834.84	30.5 QP	46.0	-15.5	1.99 H	204	34.0	-3.5
6	937.88	33.0 QP	46.0	-13.0	1.99 H	304	35.0	-2.0
ANTENNA POLARITY & TEST DISTANCE: VERTICAL AT 3 M								
NO.	FREQ. (MHz)	EMISSION LEVEL (dBuV/m)	LIMIT (dBuV/m)	MARGIN (dB)	ANTENNA HEIGHT (m)	TABLE ANGLE (Degree)	RAW VALUE (dBuV)	CORRECTION FACTOR (dB/m)
1	94.06	35.6 QP	43.5	-7.9	1.00 V	129	54.8	-19.2
2	160.17	28.2 QP	43.5	-15.3	1.00 V	135	42.0	-13.8
3	333.21	27.9 QP	46.0	-18.1	1.50 V	147	40.0	-12.1
4	562.64	28.9 QP	46.0	-17.1	1.00 V	10	37.3	-8.4
5	834.84	30.3 QP	46.0	-15.7	1.00 V	66	33.8	-3.5
6	939.83	34.2 QP	46.0	-11.8	1.99 V	244	36.2	-2.0

Remarks:

1. Emission Level(dBuV/m) = Raw Value(dBuV) + Correction Factor(dB/m)
2. Correction Factor(dB/m) = Antenna Factor(dB/m) + Cable Factor(dB) – Pre-Amplifier Factor(dB)
3. The other emission levels were very low against the limit.
4. Margin value = Emission Level – Limit value

CHANNEL	TX Channel 52	DETECTOR FUNCTION	Quasi-Peak (QP)
FREQUENCY RANGE	30MHz ~ 1GHz	TEST MODE	B

ANTENNA POLARITY & TEST DISTANCE: HORIZONTAL AT 3 M								
NO.	FREQ. (MHz)	EMISSION LEVEL (dBuV/m)	LIMIT (dBuV/m)	MARGIN (dB)	ANTENNA HEIGHT (m)	TABLE ANGLE (Degree)	RAW VALUE (dBuV)	CORRECTION FACTOR (dB/m)
1	70.73	25.4 QP	40.0	-14.6	1.00 H	81	41.6	-16.2
2	150.45	25.5 QP	43.5	-18.0	1.00 H	78	39.2	-13.7
3	319.60	26.7 QP	46.0	-19.3	1.00 H	210	38.9	-12.2
4	547.08	24.8 QP	46.0	-21.2	1.50 H	202	33.5	-8.7
5	729.84	39.6 QP	46.0	-6.4	1.00 H	49	44.8	-5.2
6	935.94	37.8 QP	46.0	-8.2	1.50 H	24	39.9	-2.1
ANTENNA POLARITY & TEST DISTANCE: VERTICAL AT 3 M								
NO.	FREQ. (MHz)	EMISSION LEVEL (dBuV/m)	LIMIT (dBuV/m)	MARGIN (dB)	ANTENNA HEIGHT (m)	TABLE ANGLE (Degree)	RAW VALUE (dBuV)	CORRECTION FACTOR (dB/m)
1	53.23	35.5 QP	40.0	-4.5	1.50 V	347	49.7	-14.2
2	189.33	25.8 QP	43.5	-17.7	1.00 V	195	42.0	-16.2
3	317.65	24.8 QP	46.0	-21.2	1.99 V	175	37.1	-12.3
4	442.09	25.8 QP	46.0	-20.2	1.00 V	350	36.0	-10.2
5	729.84	39.0 QP	46.0	-7.0	1.99 V	307	44.2	-5.2
6	897.05	40.7 QP	46.0	-5.3	1.00 V	160	43.4	-2.7

Remarks:

1. Emission Level(dBuV/m) = Raw Value(dBuV) + Correction Factor(dB/m)
2. Correction Factor(dB/m) = Antenna Factor(dB/m) + Cable Factor(dB) – Pre-Amplifier Factor(dB)
3. The other emission levels were very low against the limit.
4. Margin value = Emission Level – Limit value

CHANNEL	TX Channel 52	DETECTOR FUNCTION	Quasi-Peak (QP)
FREQUENCY RANGE	30MHz ~ 1GHz	TEST MODE	C

ANTENNA POLARITY & TEST DISTANCE: HORIZONTAL AT 3 M

NO.	FREQ. (MHz)	EMISSION LEVEL (dBuV/m)	LIMIT (dBuV/m)	MARGIN (dB)	ANTENNA HEIGHT (m)	TABLE ANGLE (Degree)	RAW VALUE (dBuV)	CORRECTION FACTOR (dB/m)
1	57.12	24.9 QP	40.0	-15.1	1.99 H	76	39.3	-14.4
2	162.11	27.0 QP	43.5	-16.5	1.50 H	260	40.9	-13.9
3	313.77	32.6 QP	46.0	-13.4	1.00 H	122	45.0	-12.4
4	541.25	27.3 QP	46.0	-18.7	1.50 H	173	36.1	-8.8
5	694.85	26.3 QP	46.0	-19.7	1.00 H	12	32.3	-6.0
6	939.83	29.5 QP	46.0	-16.5	1.99 H	87	31.5	-2.0

ANTENNA POLARITY & TEST DISTANCE: VERTICAL AT 3 M

NO.	FREQ. (MHz)	EMISSION LEVEL (dBuV/m)	LIMIT (dBuV/m)	MARGIN (dB)	ANTENNA HEIGHT (m)	TABLE ANGLE (Degree)	RAW VALUE (dBuV)	CORRECTION FACTOR (dB/m)
1	51.29	34.0 QP	40.0	-6.0	1.00 V	334	48.1	-14.1
2	101.84	33.3 QP	43.5	-10.2	1.00 V	136	51.6	-18.3
3	169.89	28.5 QP	43.5	-15.0	1.00 V	192	42.6	-14.1
4	331.26	28.0 QP	46.0	-18.0	1.50 V	163	40.1	-12.1
5	550.97	30.5 QP	46.0	-15.5	1.00 V	186	39.1	-8.6
6	932.05	30.2 QP	46.0	-15.8	1.00 V	141	32.2	-2.0

Remarks:

1. Emission Level(dBuV/m) = Raw Value(dBuV) + Correction Factor(dB/m)
2. Correction Factor(dB/m) = Antenna Factor(dB/m) + Cable Factor(dB) – Pre-Amplifier Factor(dB)
3. The other emission levels were very low against the limit.
4. Margin value = Emission Level – Limit value

CHANNEL	TX Channel 52	DETECTOR FUNCTION	Quasi-Peak (QP)
FREQUENCY RANGE	30MHz ~ 1GHz	TEST MODE	D

ANTENNA POLARITY & TEST DISTANCE: HORIZONTAL AT 3 M

NO.	FREQ. (MHz)	EMISSION LEVEL (dBuV/m)	LIMIT (dBuV/m)	MARGIN (dB)	ANTENNA HEIGHT (m)	TABLE ANGLE (Degree)	RAW VALUE (dBuV)	CORRECTION FACTOR (dB/m)
1	37.68	25.3 QP	40.0	-14.7	1.99 H	3	40.6	-15.3
2	140.72	26.0 QP	43.5	-17.5	1.00 H	78	40.4	-14.4
3	241.83	22.6 QP	46.0	-23.4	1.99 H	87	37.5	-14.9
4	346.82	27.6 QP	46.0	-18.4	1.00 H	218	39.8	-12.2
5	550.97	25.9 QP	46.0	-20.1	1.50 H	285	34.5	-8.6
6	935.94	35.7 QP	46.0	-10.3	1.00 H	151	37.8	-2.1

ANTENNA POLARITY & TEST DISTANCE: VERTICAL AT 3 M

NO.	FREQ. (MHz)	EMISSION LEVEL (dBuV/m)	LIMIT (dBuV/m)	MARGIN (dB)	ANTENNA HEIGHT (m)	TABLE ANGLE (Degree)	RAW VALUE (dBuV)	CORRECTION FACTOR (dB/m)
1	59.06	35.3 QP	40.0	-4.7	1.00 V	19	49.6	-14.3
2	160.17	26.1 QP	43.5	-17.4	1.00 V	190	39.9	-13.8
3	337.10	27.1 QP	46.0	-18.9	1.50 V	163	39.2	-12.1
4	550.97	30.5 QP	46.0	-15.5	1.00 V	77	39.1	-8.6
5	673.46	24.2 QP	46.0	-21.8	1.00 V	283	30.5	-6.3
6	935.94	36.3 QP	46.0	-9.7	1.50 V	269	38.4	-2.1

Remarks:

1. Emission Level(dBuV/m) = Raw Value(dBuV) + Correction Factor(dB/m)
2. Correction Factor(dB/m) = Antenna Factor(dB/m) + Cable Factor(dB) – Pre-Amplifier Factor(dB)
3. The other emission levels were very low against the limit.
4. Margin value = Emission Level – Limit value

4.2 Conducted Emission Measurement

4.2.1 Limits of Conducted Emission Measurement

Frequency (MHz)	Conducted Limit (dBuV)	
	Quasi-peak	Average
0.15 - 0.5	66 - 56	56 - 46
0.50 - 5.0	56	46
5.0 - 30.0	60	50

Note: 1. The lower limit shall apply at the transition frequencies.

2. The limit decreases in line with the logarithm of the frequency in the range of 0.15 to 0.50MHz.

4.2.2 Test Instruments

Tested date: Mar. 08, 2018

Description & Manufacturer	Model No.	Serial No.	Cal. Date	Cal. Due
Test Receiver ROHDE & SCHWARZ	ESCS 30	100288	Aug. 17, 2017	Aug. 16, 2018
RF signal cable (with 10dB PAD) Woken	5D-FB	Cable-cond2-01	Sep. 08, 2017	Sep. 07, 2018
LISN ROHDE & SCHWARZ (EUT)	ESH3-Z5	835239/001	Mar. 10, 2017	Mar. 09, 2018
LISN ROHDE & SCHWARZ (Peripheral)	ESH3-Z5	100312	Aug. 02, 2017	Aug. 01, 2018
Software ADT	BV ADT_Cond_ V7.3.7.3	NA	NA	NA

Note: 1. The calibration interval of the above test instruments is 12 months and the calibrations are traceable to NML/ROC and NIST/USA.

2. The test was performed in HwaYa Shielded Room 2.

3. The VCCI Site Registration No. is C-2047.

4.2.3 Test Procedures

- The EUT was placed 0.4 meters from the conducting wall of the shielded room with EUT being connected to the power mains through a line impedance stabilization network (LISN). Other support units were connected to the power mains through another LISN. The two LISNs provide 50 ohm/ 50uH of coupling impedance for the measuring instrument.
- Both lines of the power mains connected to the EUT were checked for maximum conducted interference.
- The frequency range from 150kHz to 30MHz was searched. Emission levels under (Limit - 20dB) was not recorded.

NOTE: The resolution bandwidth and video bandwidth of test receiver is 9kHz for quasi-peak detection (QP) and average detection (AV) at frequency 0.15MHz-30MHz.

4.2.4 Deviation from Test Standard

No deviation.

4.2.5 Test Setup

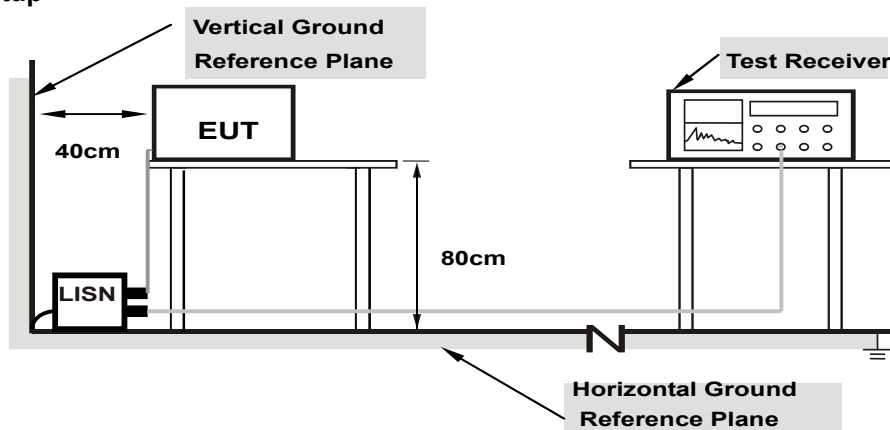

Note: 1.Support units were connected to second LISN.

For the actual test configuration, please refer to the attached file (Test Setup Photo).

4.2.6 EUT Operating Conditions

Same as 4.1.6.

4.2.7 Test Results

Phase	Line (L)	Detector Function	Quasi-Peak (QP) / Average (AV)
Test Mode	A		

No	Freq. [MHz]	Corr. Factor (dB)	Reading Value		Emission Level		Limit		Margin	
			[dB (uV)]		[dB (uV)]		[dB (uV)]		(dB)	
			Q.P.	AV.	Q.P.	AV.	Q.P.	AV.	Q.P.	AV.
1	0.15781	10.30	48.55	36.11	58.85	46.41	65.58	55.58	-6.73	-9.17
2	0.20469	10.32	42.33	27.69	52.65	38.01	63.42	53.42	-10.77	-15.41
3	0.53281	10.36	26.22	20.49	36.58	30.85	56.00	46.00	-19.42	-15.15
4	2.59766	10.47	23.31	18.69	33.78	29.16	56.00	46.00	-22.22	-16.84
5	4.62891	10.58	25.11	16.13	35.69	26.71	56.00	46.00	-20.31	-19.29
6	10.44141	10.87	29.14	22.29	40.01	33.16	60.00	50.00	-19.99	-16.84

REMARKS:

1. Q.P. and AV. are abbreviations of quasi-peak and average individually.
2. The emission levels of other frequencies were very low against the limit.
3. Margin value = Emission level - Limit value
4. Correction factor = Insertion loss + Cable loss
5. Emission Level = Correction Factor + Reading Value.

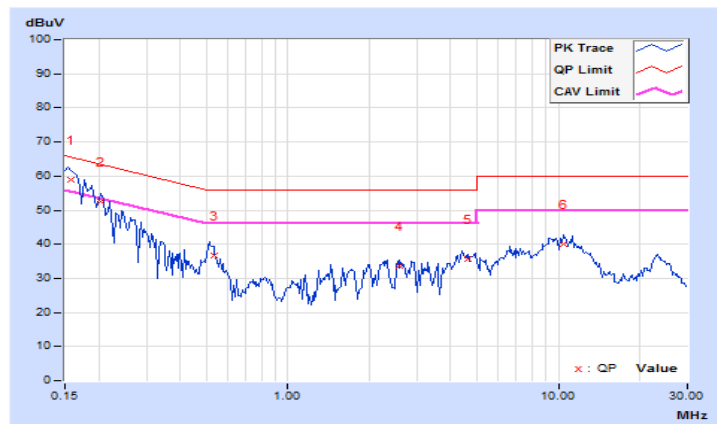

Phase	Neutral (N)	Detector Function	Quasi-Peak (QP) / Average (AV)
Test Mode	A		

No	Freq. [MHz]	Corr. Factor (dB)	Reading Value [dB (uV)]		Emission Level [dB (uV)]		Limit [dB (uV)]		Margin (dB)	
			Q.P.	AV.	Q.P.	AV.	Q.P.	AV.	Q.P.	AV.
			1	0.15781	10.33	48.99	35.44	59.32	45.77	65.58
2	0.21641	10.29	39.11	21.54	49.40	31.83	62.96	52.96	-13.56	-21.13
3	0.51328	10.32	29.33	22.44	39.65	32.76	56.00	46.00	-16.35	-13.24
4	1.35938	10.42	23.47	18.41	33.89	28.83	56.00	46.00	-22.11	-17.17
5	6.39453	10.64	20.20	14.55	30.84	25.19	60.00	50.00	-29.16	-24.81
6	9.50781	10.77	22.29	15.87	33.06	26.64	60.00	50.00	-26.94	-23.36

REMARKS:

1. Q.P. and AV. are abbreviations of quasi-peak and average individually.
2. The emission levels of other frequencies were very low against the limit.
3. Margin value = Emission level - Limit value
4. Correction factor = Insertion loss + Cable loss
5. Emission Level = Correction Factor + Reading Value.

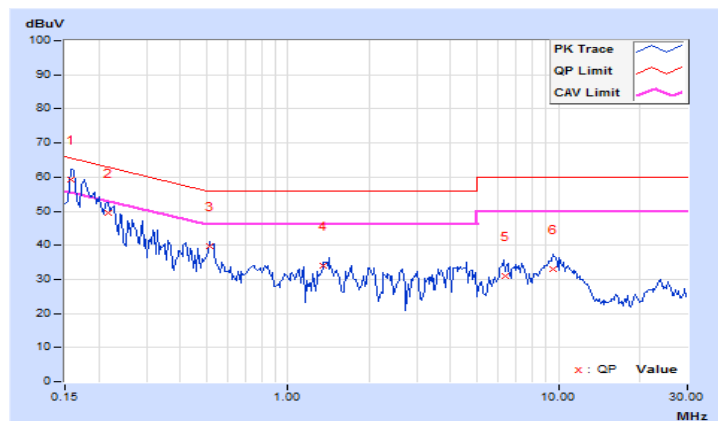

Phase	Line (L)	Detector Function	Quasi-Peak (QP) / Average (AV)
Test Mode	B		

No	Freq. [MHz]	Corr. Factor (dB)	Reading Value [dB (uV)]		Emission Level [dB (uV)]		Limit [dB (uV)]		Margin (dB)	
			Q.P.	AV.	Q.P.	AV.	Q.P.	AV.	Q.P.	AV.
			1	0.15781	10.30	35.11	20.33	45.41	30.63	65.58
2	0.30625	10.33	21.22	19.12	31.55	29.45	60.07	50.07	-28.52	-20.62
3	0.81016	10.38	25.33	19.17	35.71	29.55	56.00	46.00	-20.29	-16.45
4	1.44141	10.41	23.31	19.13	33.72	29.54	56.00	46.00	-22.28	-16.46
5	2.98438	10.49	26.12	19.54	36.61	30.03	56.00	46.00	-19.39	-15.97
6	10.56641	10.88	33.11	27.36	43.99	38.24	60.00	50.00	-16.01	-11.76

REMARKS:

1. Q.P. and AV. are abbreviations of quasi-peak and average individually.
2. The emission levels of other frequencies were very low against the limit.
3. Margin value = Emission level - Limit value
4. Correction factor = Insertion loss + Cable loss
5. Emission Level = Correction Factor + Reading Value.

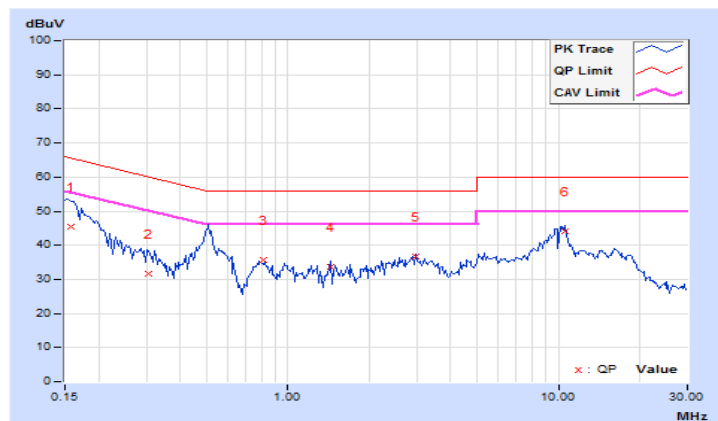

Phase	Neutral (N)	Detector Function	Quasi-Peak (QP) / Average (AV)
Test Mode	B		

No	Freq. [MHz]	Corr. Factor (dB)	Reading Value [dB (uV)]		Emission Level [dB (uV)]		Limit [dB (uV)]		Margin (dB)	
			Q.P.	AV.	Q.P.	AV.	Q.P.	AV.	Q.P.	AV.
			1	0.17344	10.32	35.66	21.39	45.98	31.71	64.79
2	0.51328	10.32	36.31	30.11	46.63	40.43	56.00	46.00	-9.37	-5.57
3	1.23047	10.41	20.17	16.93	30.58	27.34	56.00	46.00	-25.42	-18.66
4	3.06641	10.51	21.22	16.21	31.73	26.72	56.00	46.00	-24.27	-19.28
5	5.46875	10.61	22.21	15.07	32.82	25.68	60.00	50.00	-27.18	-24.32
6	10.40625	10.80	30.87	26.74	41.67	37.54	60.00	50.00	-18.33	-12.46

REMARKS:

1. Q.P. and AV. are abbreviations of quasi-peak and average individually.
2. The emission levels of other frequencies were very low against the limit.
3. Margin value = Emission level - Limit value
4. Correction factor = Insertion loss + Cable loss
5. Emission Level = Correction Factor + Reading Value.

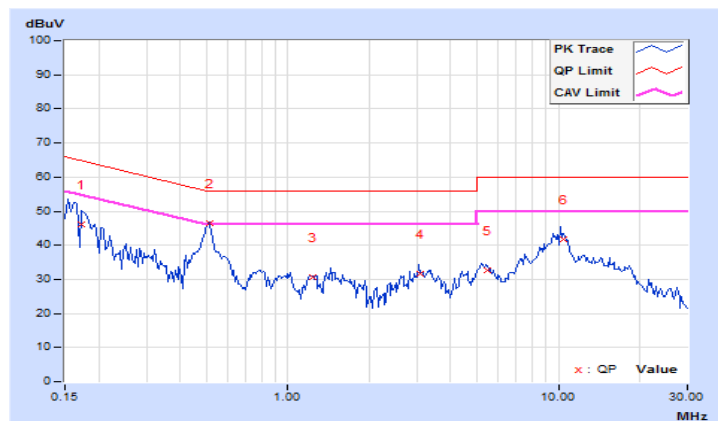

Phase	Line (L)	Detector Function	Quasi-Peak (QP) / Average (AV)
Test Mode	C		

No	Freq. [MHz]	Corr. Factor (dB)	Reading Value [dB (uV)]		Emission Level [dB (uV)]		Limit [dB (uV)]		Margin (dB)	
			Q.P.	AV.	Q.P.	AV.	Q.P.	AV.	Q.P.	AV.
			1	0.16172	10.30	48.11	33.54	58.41	43.84	65.38
2	0.22812	10.33	39.54	23.11	49.87	33.44	62.52	52.52	-12.65	-19.08
3	0.53672	10.36	25.87	21.36	36.23	31.72	56.00	46.00	-19.77	-14.28
4	2.60156	10.47	23.54	20.20	34.01	30.67	56.00	46.00	-21.99	-15.33
5	4.91406	10.60	25.10	16.98	35.70	27.58	56.00	46.00	-20.30	-18.42
6	10.83203	10.90	29.11	23.54	40.01	34.44	60.00	50.00	-19.99	-15.56

REMARKS:

1. Q.P. and AV. are abbreviations of quasi-peak and average individually.
2. The emission levels of other frequencies were very low against the limit.
3. Margin value = Emission level - Limit value
4. Correction factor = Insertion loss + Cable loss
5. Emission Level = Correction Factor + Reading Value.

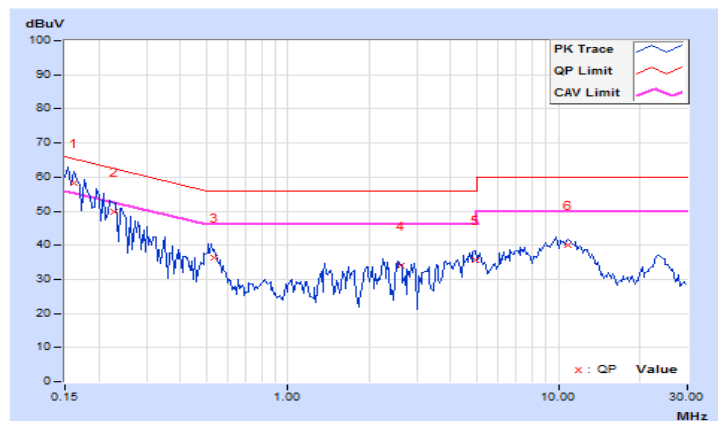

Phase	Neutral (N)	Detector Function	Quasi-Peak (QP) / Average (AV)
Test Mode	C		

No	Freq. [MHz]	Corr. Factor (dB)	Reading Value [dB (uV)]		Emission Level [dB (uV)]		Limit [dB (uV)]		Margin (dB)	
			Q.P.	AV.	Q.P.	AV.	Q.P.	AV.	Q.P.	AV.
			1	0.16172	10.33	49.65	32.36	59.98	42.69	65.38
2	0.22812	10.30	38.47	22.54	48.77	32.84	62.52	52.52	-13.75	-19.68
3	0.51719	10.32	28.32	22.54	38.64	32.86	56.00	46.00	-17.36	-13.14
4	1.44141	10.42	23.14	18.51	33.56	28.93	56.00	46.00	-22.44	-17.07
5	4.00781	10.55	21.11	13.56	31.66	24.11	56.00	46.00	-24.34	-21.89
6	9.57813	10.77	23.11	15.78	33.88	26.55	60.00	50.00	-26.12	-23.45

REMARKS:

1. Q.P. and AV. are abbreviations of quasi-peak and average individually.
2. The emission levels of other frequencies were very low against the limit.
3. Margin value = Emission level - Limit value
4. Correction factor = Insertion loss + Cable loss
5. Emission Level = Correction Factor + Reading Value.

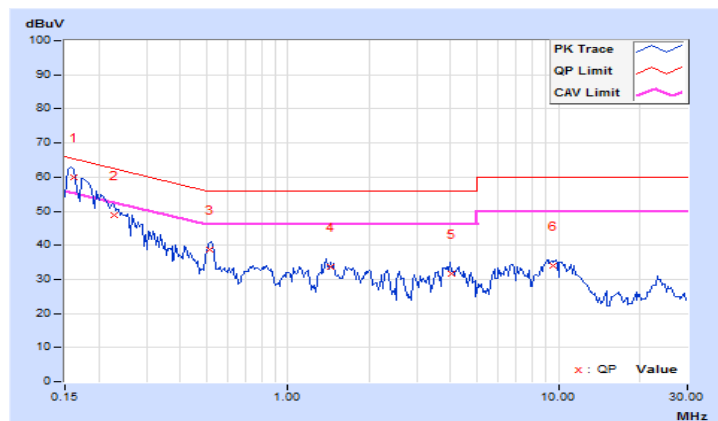

Phase	Line (L)	Detector Function	Quasi-Peak (QP) / Average (AV)
Test Mode	D		

No	Freq. [MHz]	Corr. Factor (dB)	Reading Value [dB (uV)]		Emission Level [dB (uV)]		Limit [dB (uV)]		Margin (dB)	
			Q.P.	AV.	Q.P.	AV.	Q.P.	AV.	Q.P.	AV.
			1	0.17734	10.31	35.55	19.31	45.86	29.62	64.61
2	0.51328	10.35	34.13	29.17	44.48	39.52	56.00	46.00	-11.52	-6.48
3	0.80625	10.38	22.54	18.13	32.92	28.51	56.00	46.00	-23.08	-17.49
4	5.13281	10.61	25.26	19.11	35.87	29.72	60.00	50.00	-24.13	-20.28
5	10.20313	10.86	33.21	27.87	44.07	38.73	60.00	50.00	-15.93	-11.27
6	16.87891	11.29	25.13	19.22	36.42	30.51	60.00	50.00	-23.58	-19.49

REMARKS:

1. Q.P. and AV. are abbreviations of quasi-peak and average individually.
2. The emission levels of other frequencies were very low against the limit.
3. Margin value = Emission level - Limit value
4. Correction factor = Insertion loss + Cable loss
5. Emission Level = Correction Factor + Reading Value.

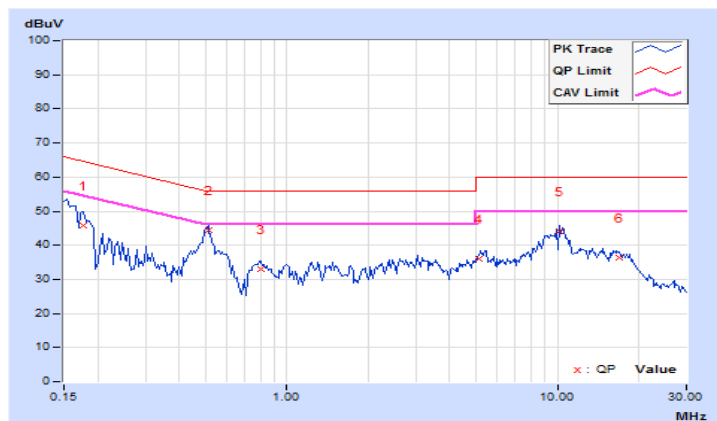

Phase	Neutral (N)	Detector Function	Quasi-Peak (QP) / Average (AV)
Test Mode	D		

No	Freq. [MHz]	Corr. Factor (dB)	Reading Value [dB (uV)]		Emission Level [dB (uV)]		Limit [dB (uV)]		Margin (dB)	
			Q.P.	AV.	Q.P.	AV.	Q.P.	AV.	Q.P.	AV.
			1	0.20078	10.29	30.11	14.54	40.40	24.83	63.58
2	0.50547	10.32	33.33	29.87	43.65	40.19	56.00	46.00	-12.35	-5.81
3	0.76328	10.36	18.54	15.22	28.90	25.58	56.00	46.00	-27.10	-20.42
4	1.45313	10.42	20.11	15.31	30.53	25.73	56.00	46.00	-25.47	-20.27
5	5.20703	10.60	22.22	16.25	32.82	26.85	60.00	50.00	-27.18	-23.15
6	10.35547	10.80	30.29	26.17	41.09	36.97	60.00	50.00	-18.91	-13.03

REMARKS:

1. Q.P. and AV. are abbreviations of quasi-peak and average individually.
2. The emission levels of other frequencies were very low against the limit.
3. Margin value = Emission level - Limit value
4. Correction factor = Insertion loss + Cable loss
5. Emission Level = Correction Factor + Reading Value.

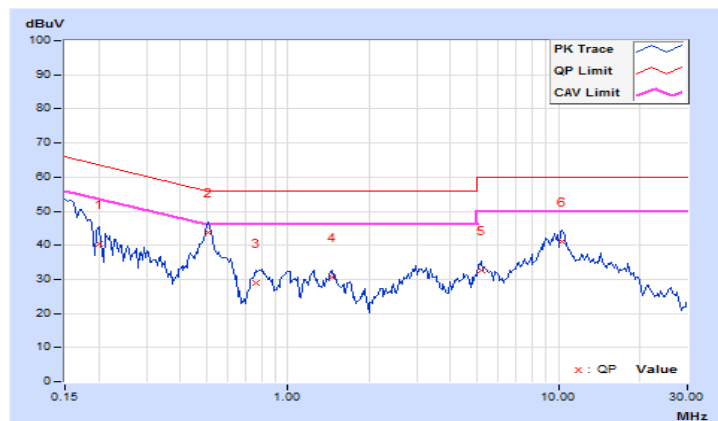

4.3 Transmit Power Measurement

4.3.1 Limits of Transmit Power Measurement

Operation Band	EUT Category		LIMIT
U-NII-1	-	Outdoor Access Point	1 Watt (30 dBm) (Max. e.i.r.p \leq 125mW(21 dBm) at any elevation angle above 30 degrees as measured from the horizon)
	-	Fixed point-to-point Access Point	1 Watt (30 dBm)
	-	Indoor Access Point	1 Watt (30 dBm)
	-	Mobile and Portable client device	250mW (24 dBm)
U-NII-2A	√		250mW (24 dBm) or 11 dBm+10 log B*
U-NII-2C	√		250mW (24 dBm) or 11 dBm+10 log B*
U-NII-3	-		1 Watt (30 dBm)

*B is the 26 dB emission bandwidth in megahertz

Per KDB 662911 Method of conducted output power measurement on IEEE 802.11 devices,

Array Gain = 0 dB (i.e., no array gain) for $N_{ANT} \leq 4$;

Array Gain = 0 dB (i.e., no array gain) for channel widths ≥ 40 MHz for any N_{ANT} ;

Array Gain = $5 \log(N_{ANT}/N_{SS})$ dB or 3 dB, whichever is less for 20-MHz channel widths with $N_{ANT} \geq 5$.

For power measurements on all other devices: Array Gain = $10 \log(N_{ANT}/N_{SS})$ dB.

4.3.2 Test Setup

For Power Output

802.11a, 802.11n (HT20), 802.11n (HT40)

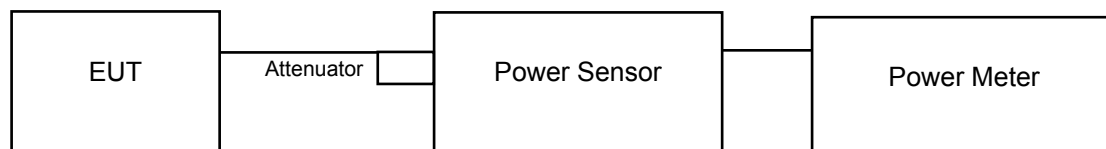

802.11ac (VHT80)

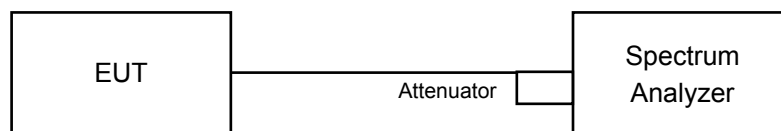

For 26dB and Occupied Bandwidth

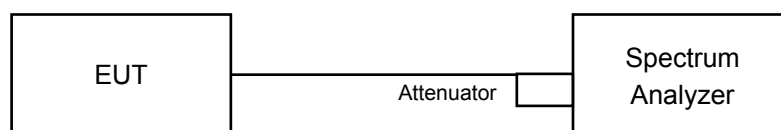

4.3.3 Test Instruments

Refer to section 4.1.2 to get information of above instrument.

4.3.4 Test Procedure

For Average Power Measurement

For 802.11a, 802.11n (HT20), 802.11n (HT40)

Method PM is used to perform output power measurement, trigger and gating function of wide band power meter is enabled to measure max output power of TX on burst. Duty factor is not added to measured value.

For 802.11ac (VHT80)

- a. Set span to encompass the entire 26 dB EBW (or, alternatively, the entire 99% occupied bandwidth) of the signal.
- b. Set sweep trigger to "free run".
- c. Set RBW = 1 MHz
- d. Set VBW \geq 3 MHz
- e. Number of points in sweep \geq 2 Span / RBW
- f. Sweep time \leq (number of points in sweep) * T
- g. Using emission bandwidth to determine the frequency span for integration the channel bandwidth.
- h. Detector = RMS
- i. Trace mode = max hold
- j. Allow max hold to run for at least 60 seconds, or longer as needed to allow the trace to stabilize.
- k. Compute power by integrating the spectrum across the EBW (or, alternatively, the entire 99% occupied bandwidth) of the signal using the instrument's band power measurement function with band limits set equal to the EBW (or occupied bandwidth) band edges. If the instrument does not have a band power function, sum the spectrum levels (in power units) at 1 MHz intervals extending across the EBW (or, alternatively, the entire 99% occupied bandwidth) of the spectrum.

For 26dB Bandwidth

- a. Set RBW = approximately 1% of the emission bandwidth.
- b. Set the VBW > RBW.
- c. Detector = Peak.
- d. Trace mode = max hold.
- e. Measure the maximum width of the emission that is 26 dB down from the peak of the emission. Compare this with the RBW setting of the analyzer. Readjust RBW and repeat measurement as needed until the RBW/EBW ratio is approximately 1%.

For Occupied Bandwidth

The transmitter output was connected to the spectrum analyzer through an attenuator. The bandwidth of the fundamental frequency was measured by spectrum analyzer with resolution bandwidth in the range of 1% to 5% of the anticipated emission bandwidth, and a video bandwidth at least 3x the resolution bandwidth and set the detector to Sampling. The width of a frequency band such that, below the lower and above the upper frequency limits, the mean powers emitted are each equal to a specified percentage 0.5 % of the total mean power of a given emission.

4.3.5 Deviation from Test Standard

No deviation.

4.3.6 EUT Operating Conditions

The software provided by client to enable the EUT under transmission condition continuously at lowest, middle and highest channel frequencies individually.

4.3.7 Test Result

Power Output:

Test Mode A

CDD Mode

For U-NII-2A, U-NII-2C Band

802.11a

Chan.	Freq. (MHz)	Maximum Conducted Power (dBm)		Total Power (mW)	Total Power (dBm)	Power Limit (dBm)	Pass / Fail
		Chain 0	Chain 1				
52	5260	17.86	18.01	124.335	20.95	24.00	Pass
60	5300	17.58	18.13	122.293	20.87	24.00	Pass
64	5320	17.68	17.99	121.565	20.85	24.00	Pass
100	5500	17.88	18.06	125.349	20.98	24.00	Pass
116	5580	17.69	18.03	122.282	20.87	23.87	Pass
140	5700	17.84	18.08	125.083	20.97	23.86	Pass

Note:

For U-NII-2A, U-NII-2C Band:

Chain 0

1. $11\text{dBm} + 10\log(21.35) = 24.29\text{ dBm} > 24\text{dBm}$
2. $11\text{dBm} + 10\log(23.38) = 24.69\text{ dBm} > 24\text{dBm}$
3. $11\text{dBm} + 10\log(23.98) = 24.80\text{ dBm} > 24\text{dBm}$
4. $11\text{dBm} + 10\log(20.65) = 24.15\text{ dBm} > 24\text{dBm}$
5. $11\text{dBm} + 10\log(19.55) = 23.91\text{ dBm} < 24\text{dBm}$
6. $11\text{dBm} + 10\log(19.51) = 23.90\text{ dBm} < 24\text{dBm}$

Chain 1

1. $11\text{dBm} + 10\log(21.46) = 24.32\text{ dBm} > 24\text{dBm}$
2. $11\text{dBm} + 10\log(23.17) = 24.65\text{ dBm} > 24\text{dBm}$
3. $11\text{dBm} + 10\log(22.49) = 24.52\text{ dBm} > 24\text{dBm}$
4. $11\text{dBm} + 10\log(20.86) = 24.19\text{ dBm} > 24\text{dBm}$
5. $11\text{dBm} + 10\log(19.39) = 23.87\text{ dBm} < 24\text{dBm}$
6. $11\text{dBm} + 10\log(19.33) = 23.86\text{ dBm} < 24\text{dBm}$

802.11n (HT20)

Chan.	Freq. (MHz)	Maximum Conducted Power (dBm)		Total Power (mW)	Total Power (dBm)	Power Limit (dBm)	Pass / Fail
		Chain 0	Chain 1				
52	5260	17.85	18.06	124.927	20.97	24.00	Pass
60	5300	17.66	18.01	121.586	20.85	24.00	Pass
64	5320	17.93	18.04	125.767	21.00	24.00	Pass
100	5500	17.95	18.03	125.906	21.00	24.00	Pass
116	5580	17.66	18.11	123.059	20.90	24.00	Pass
140	5700	17.91	18.53	133.087	21.24	24.00	Pass

Note:

For U-NII-2A, U-NII-2C Band:

Chain 0

1. $11\text{dBm} + 10\log(22.47) = 24.52\text{ dBm} > 24\text{dBm}$
2. $11\text{dBm} + 10\log(22.42) = 24.51\text{ dBm} > 24\text{dBm}$
3. $11\text{dBm} + 10\log(22.89) = 24.60\text{ dBm} > 24\text{dBm}$
4. $11\text{dBm} + 10\log(20.47) = 24.11\text{ dBm} > 24\text{dBm}$
5. $11\text{dBm} + 10\log(20.35) = 24.09\text{ dBm} > 24\text{dBm}$
6. $11\text{dBm} + 10\log(20.26) = 24.07\text{ dBm} > 24\text{dBm}$

Chain 1

1. $11\text{dBm} + 10\log(23.47) = 24.71\text{ dBm} > 24\text{dBm}$
2. $11\text{dBm} + 10\log(28.30) = 25.52\text{ dBm} > 24\text{dBm}$
3. $11\text{dBm} + 10\log(28.18) = 25.50\text{ dBm} > 24\text{dBm}$
4. $11\text{dBm} + 10\log(21.15) = 24.25\text{ dBm} > 24\text{dBm}$
5. $11\text{dBm} + 10\log(20.46) = 24.11\text{ dBm} > 24\text{dBm}$
6. $11\text{dBm} + 10\log(20.37) = 24.09\text{ dBm} > 24\text{dBm}$

802.11n (HT40)

Chan.	Freq. (MHz)	Maximum Conducted Power (dBm)		Total Power (mW)	Total Power (dBm)	Power Limit (dBm)	Pass / Fail
		Chain 0	Chain 1				
54	5270	19.63	20.01	192.064	22.83	24.00	Pass
62	5310	14.95	14.86	61.881	17.92	24.00	Pass
102	5510	15.92	16.60	84.793	19.28	24.00	Pass
110	5550	20.53	20.96	237.718	23.76	24.00	Pass
134	5670	18.35	18.76	143.553	21.57	24.00	Pass

Note:

For U-NII-2A, U-NII-2C Band:

Chain 0

1. $11\text{dBm} + 10\log(77.05) = 29.87\text{ dBm} > 24\text{dBm}$
2. $11\text{dBm} + 10\log(40.82) = 27.11\text{ dBm} > 24\text{dBm}$
3. $11\text{dBm} + 10\log(40.82) = 27.11\text{ dBm} > 24\text{dBm}$
4. $11\text{dBm} + 10\log(75.15) = 29.76\text{ dBm} > 24\text{dBm}$
5. $11\text{dBm} + 10\log(40.75) = 27.10\text{ dBm} > 24\text{dBm}$

Chain 1

1. $11\text{dBm} + 10\log(80.05) = 30.03\text{ dBm} > 24\text{dBm}$
2. $11\text{dBm} + 10\log(40.88) = 27.12\text{ dBm} > 24\text{dBm}$
3. $11\text{dBm} + 10\log(41.18) = 27.15\text{ dBm} > 24\text{dBm}$
4. $11\text{dBm} + 10\log(81.19) = 30.10\text{ dBm} > 24\text{dBm}$
5. $11\text{dBm} + 10\log(41.33) = 27.16\text{ dBm} > 24\text{dBm}$

802.11ac (VHT80)

Chan.	Freq. (MHz)	Maximum Conducted Power (dBm)		Total Power (mW)	Total Power (dBm)	Power Limit (dBm)	Pass / Fail
		Chain 0	Chain 1				
58	5290	13.97	14.12	50.769	17.06	24.00	Pass
106	5530	15.75	16.38	81.035	19.09	24.00	Pass
122	5610	15.63	16.24	78.632	18.96	24.00	Pass

Note:

For U-NII-2A, U-NII-2C Band:

Chain 0

1. $11\text{dBm} + 10\log(84.23) = 30.25\text{ dBm} > 24\text{dBm}$
2. $11\text{dBm} + 10\log(84.08) = 30.25\text{ dBm} > 24\text{dBm}$
3. $11\text{dBm} + 10\log(84.42) = 30.26\text{ dBm} > 24\text{dBm}$

Chain 1

1. $11\text{dBm} + 10\log(83.69) = 30.23\text{ dBm} > 24\text{dBm}$
2. $11\text{dBm} + 10\log(83.56) = 30.22\text{ dBm} > 24\text{dBm}$
3. $11\text{dBm} + 10\log(84.10) = 30.25\text{ dBm} > 24\text{dBm}$

Beamforming Mode

For U-NII-2A, U-NII-2C Band

802.11n (HT20)

Chan.	Freq. (MHz)	Maximum Conducted Power (dBm)		Total Power (mW)	Total Power (dBm)	Power Limit (dBm)	Pass / Fail
		Chain 0	Chain 1				
52	5260	14.84	15.05	62.517	17.96	21.00	Pass
60	5300	14.65	15.00	60.814	17.84	21.00	Pass
64	5320	14.92	15.03	62.951	17.99	21.00	Pass
100	5500	14.94	15.02	62.951	17.99	21.00	Pass
116	5580	14.65	15.10	61.518	17.89	21.00	Pass
140	5700	14.90	15.52	66.527	18.23	21.00	Pass

Note: Directional Gain = $5.99 + 10\log(2) = 9\text{dBi} > 6\text{dBi}$, so the limit shall be reduced to $24 - (9 - 6) = 21\text{dBm}$.

* Determined Limit means compare the minimum value after 24dBm and $11\text{ dBm} + 10\log(26\text{ dB bandwidth})$

For U-NII-2A, U-NII-2C Band:

Chain 0

1. $11\text{dBm} + 10\log(22.47) = 24.52\text{ dBm} > 24\text{dBm}$
2. $11\text{dBm} + 10\log(22.42) = 24.51\text{ dBm} > 24\text{dBm}$
3. $11\text{dBm} + 10\log(22.89) = 24.60\text{ dBm} > 24\text{dBm}$
4. $11\text{dBm} + 10\log(20.47) = 24.11\text{ dBm} > 24\text{dBm}$
5. $11\text{dBm} + 10\log(20.35) = 24.09\text{ dBm} > 24\text{dBm}$
6. $11\text{dBm} + 10\log(20.26) = 24.07\text{ dBm} > 24\text{dBm}$

Chain 1

1. $11\text{dBm} + 10\log(23.47) = 24.71\text{ dBm} > 24\text{dBm}$
2. $11\text{dBm} + 10\log(28.30) = 25.52\text{ dBm} > 24\text{dBm}$
3. $11\text{dBm} + 10\log(28.18) = 25.50\text{ dBm} > 24\text{dBm}$
4. $11\text{dBm} + 10\log(21.15) = 24.25\text{ dBm} > 24\text{dBm}$
5. $11\text{dBm} + 10\log(20.46) = 24.11\text{ dBm} > 24\text{dBm}$
6. $11\text{dBm} + 10\log(20.37) = 24.09\text{ dBm} > 24\text{dBm}$

802.11n (HT40)

Chan.	Freq. (MHz)	Maximum Conducted Power (dBm)		Total Power (mW)	Total Power (dBm)	Power Limit (dBm)	Pass / Fail
		Chain 0	Chain 1				
54	5270	16.62	17.00	95.940	19.82	21.00	Pass
62	5310	11.94	11.85	30.974	14.91	21.00	Pass
102	5510	12.91	13.59	42.364	16.27	21.00	Pass
110	5550	17.52	17.95	118.850	20.75	21.00	Pass
134	5670	15.34	15.75	71.779	18.56	21.00	Pass

Note: Directional Gain = $5.99 + 10\log(2) = 9\text{dBi} > 6\text{dBi}$, so the limit shall be reduced to $24 - (9 - 6) = 21\text{dBm}$.

* Determined Limit means compare the minimum value after 24dBm and $11\text{ dBm} + 10\log(26\text{ dB bandwidth})$

For U-NII-2A, U-NII-2C Band:

Chain 0

- $11\text{dBm} + 10\log(77.05) = 29.87\text{ dBm} > 24\text{dBm}$
- $11\text{dBm} + 10\log(40.82) = 27.11\text{ dBm} > 24\text{dBm}$
- $11\text{dBm} + 10\log(40.82) = 27.11\text{ dBm} > 24\text{dBm}$
- $11\text{dBm} + 10\log(75.15) = 29.76\text{ dBm} > 24\text{dBm}$
- $11\text{dBm} + 10\log(40.75) = 27.10\text{ dBm} > 24\text{dBm}$

Chain 1

- $11\text{dBm} + 10\log(80.05) = 30.03\text{ dBm} > 24\text{dBm}$
- $11\text{dBm} + 10\log(40.88) = 27.12\text{ dBm} > 24\text{dBm}$
- $11\text{dBm} + 10\log(41.18) = 27.15\text{ dBm} > 24\text{dBm}$
- $11\text{dBm} + 10\log(81.19) = 30.10\text{ dBm} > 24\text{dBm}$
- $11\text{dBm} + 10\log(41.33) = 27.16\text{ dBm} > 24\text{dBm}$

802.11ac (VHT80)

Chan.	Freq. (MHz)	Maximum Conducted Power (dBm)		Total Power (mW)	Total Power (dBm)	Power Limit (dBm)	Pass / Fail
		Chain 0	Chain 1				
58	5290	10.96	11.11	25.410	14.05	21.00	Pass
106	5530	12.74	13.37	40.551	16.08	21.00	Pass
122	5610	12.62	13.23	39.355	15.95	21.00	Pass

Note: Directional Gain = $5.99 + 10\log(2) = 9\text{dBi} > 6\text{dBi}$, so the limit shall be reduced to $24 - (9 - 6) = 21\text{dBm}$.

* Determined Limit means compare the minimum value after 24dBm and $11\text{ dBm} + 10\log(26\text{ dB bandwidth})$

For U-NII-2A, U-NII-2C Band:

Chain 0

- $11\text{dBm} + 10\log(84.23) = 30.25\text{ dBm} > 24\text{dBm}$
- $11\text{dBm} + 10\log(84.08) = 30.25\text{ dBm} > 24\text{dBm}$
- $11\text{dBm} + 10\log(84.42) = 30.26\text{ dBm} > 24\text{dBm}$

Chain 1

- $11\text{dBm} + 10\log(83.69) = 30.23\text{ dBm} > 24\text{dBm}$
- $11\text{dBm} + 10\log(83.56) = 30.22\text{ dBm} > 24\text{dBm}$
- $11\text{dBm} + 10\log(84.10) = 30.25\text{ dBm} > 24\text{dBm}$

Test Mode C

CDD Mode

For U-NII-2A, U-NII-2C Band

802.11a

Chan.	Freq. (MHz)	Maximum Conducted Power (dBm)		Total Power (mW)	Total Power (dBm)	Power Limit (dBm)	Pass / Fail
		Chain 0	Chain 1				
52	5260	14.50	14.10	53.888	17.31	24.00	Pass
60	5300	14.50	13.72	51.734	17.14	24.00	Pass
64	5320	14.50	13.81	52.228	17.18	24.00	Pass
100	5500	13.76	13.52	46.259	16.65	24.00	Pass
116	5580	14.06	14.17	51.590	17.13	24.00	Pass
140	5700	13.49	13.51	44.775	16.51	24.00	Pass

Note:

For U-NII-2A, U-NII-2C Band:

Chain 0

1. $11\text{dBm} + 10\log(25.16) = 25.01\text{ dBm} > 24\text{dBm}$
2. $11\text{dBm} + 10\log(24.95) = 24.97\text{ dBm} > 24\text{dBm}$
3. $11\text{dBm} + 10\log(25.08) = 24.99\text{ dBm} > 24\text{dBm}$
4. $11\text{dBm} + 10\log(23.75) = 24.76\text{ dBm} > 24\text{dBm}$
5. $11\text{dBm} + 10\log(25.20) = 25.01\text{ dBm} > 24\text{dBm}$
6. $11\text{dBm} + 10\log(23.71) = 24.75\text{ dBm} > 24\text{dBm}$

Chain 1

1. $11\text{dBm} + 10\log(24.09) = 24.82\text{ dBm} > 24\text{dBm}$
2. $11\text{dBm} + 10\log(24.18) = 24.83\text{ dBm} > 24\text{dBm}$
3. $11\text{dBm} + 10\log(24.12) = 24.82\text{ dBm} > 24\text{dBm}$
4. $11\text{dBm} + 10\log(23.05) = 24.63\text{ dBm} > 24\text{dBm}$
5. $11\text{dBm} + 10\log(25.08) = 24.99\text{ dBm} > 24\text{dBm}$
6. $11\text{dBm} + 10\log(22.86) = 24.59\text{ dBm} > 24\text{dBm}$

802.11n (HT20)

Chan.	Freq. (MHz)	Maximum Conducted Power (dBm)		Total Power (mW)	Total Power (dBm)	Power Limit (dBm)	Pass / Fail
		Chain 0	Chain 1				
52	5260	14.02	14.23	51.720	17.14	24.00	Pass
60	5300	13.64	14.47	51.111	17.09	24.00	Pass
64	5320	13.82	14.35	51.326	17.10	24.00	Pass
100	5500	14.46	14.01	53.102	17.25	24.00	Pass
116	5580	14.05	14.19	51.652	17.13	24.00	Pass
140	5700	13.46	13.49	44.518	16.49	24.00	Pass

Note:

For U-NII-2A, U-NII-2C Band:

Chain 0

1. $11\text{dBm} + 10\log(24.54) = 24.90\text{ dBm} > 24\text{dBm}$
2. $11\text{dBm} + 10\log(25.40) = 25.05\text{ dBm} > 24\text{dBm}$
3. $11\text{dBm} + 10\log(24.68) = 24.92\text{ dBm} > 24\text{dBm}$
4. $11\text{dBm} + 10\log(23.22) = 24.66\text{ dBm} > 24\text{dBm}$
5. $11\text{dBm} + 10\log(26.53) = 25.24\text{ dBm} > 24\text{dBm}$
6. $11\text{dBm} + 10\log(22.84) = 24.59\text{ dBm} > 24\text{dBm}$

Chain 1

1. $11\text{dBm} + 10\log(23.24) = 24.66\text{ dBm} > 24\text{dBm}$
2. $11\text{dBm} + 10\log(23.79) = 24.76\text{ dBm} > 24\text{dBm}$
3. $11\text{dBm} + 10\log(23.07) = 24.63\text{ dBm} > 24\text{dBm}$
4. $11\text{dBm} + 10\log(23.21) = 24.66\text{ dBm} > 24\text{dBm}$
5. $11\text{dBm} + 10\log(24.51) = 24.89\text{ dBm} > 24\text{dBm}$
6. $11\text{dBm} + 10\log(23.16) = 24.65\text{ dBm} > 24\text{dBm}$

802.11n (HT40)

Chan.	Freq. (MHz)	Maximum Conducted Power (dBm)		Total Power (mW)	Total Power (dBm)	Power Limit (dBm)	Pass / Fail
		Chain 0	Chain 1				
54	5270	13.71	14.59	52.270	17.18	24.00	Pass
62	5310	12.52	12.85	37.140	15.70	24.00	Pass
102	5510	8.89	8.18	14.322	11.56	24.00	Pass
110	5550	14.67	14.16	55.371	17.43	24.00	Pass
134	5670	14.55	13.97	53.456	17.28	24.00	Pass

Note:

For U-NII-2A, U-NII-2C Band:

Chain 0

1. $11\text{dBm} + 10\log(48.78) = 27.88\text{ dBm} > 24\text{dBm}$
2. $11\text{dBm} + 10\log(47.56) = 27.77\text{ dBm} > 24\text{dBm}$
3. $11\text{dBm} + 10\log(47.68) = 27.78\text{ dBm} > 24\text{dBm}$
4. $11\text{dBm} + 10\log(54.59) = 28.37\text{ dBm} > 24\text{dBm}$
5. $11\text{dBm} + 10\log(53.90) = 28.32\text{ dBm} > 24\text{dBm}$

Chain 1

1. $11\text{dBm} + 10\log(56.72) = 28.54\text{ dBm} > 24\text{dBm}$
2. $11\text{dBm} + 10\log(46.31) = 27.66\text{ dBm} > 24\text{dBm}$
3. $11\text{dBm} + 10\log(45.98) = 27.63\text{ dBm} > 24\text{dBm}$
4. $11\text{dBm} + 10\log(47.83) = 27.80\text{ dBm} > 24\text{dBm}$
5. $11\text{dBm} + 10\log(47.38) = 27.76\text{ dBm} > 24\text{dBm}$

802.11ac (VHT80)

Chan.	Freq. (MHz)	Maximum Conducted Power (dBm)		Total Power (mW)	Total Power (dBm)	Power Limit (dBm)	Pass / Fail
		Chain 0	Chain 1				
58	5290	9.71	10.08	19.540	12.91	24.00	Pass
106	5530	7.57	6.62	10.307	10.13	24.00	Pass
122	5610	7.43	6.27	9.770	9.90	24.00	Pass

Note:

For U-NII-2A, U-NII-2C Band:

Chain 0

1. $11\text{dBm} + 10\log(89.23) = 30.51\text{ dBm} > 24\text{dBm}$
2. $11\text{dBm} + 10\log(90.85) = 30.58\text{ dBm} > 24\text{dBm}$
3. $11\text{dBm} + 10\log(84.47) = 30.27\text{ dBm} > 24\text{dBm}$

Chain 1

1. $11\text{dBm} + 10\log(87.95) = 30.44\text{ dBm} > 24\text{dBm}$
2. $11\text{dBm} + 10\log(90.17) = 30.55\text{ dBm} > 24\text{dBm}$
3. $11\text{dBm} + 10\log(83.72) = 30.23\text{ dBm} > 24\text{dBm}$

26dB Bandwidth:

Test Mode A

802.11a

Chan.	Freq. (MHz)	26dBc Bandwidth (MHz)	
		Chain 0	Chain 1
52	5260	21.35	21.46
60	5300	23.38	23.17
64	5320	23.98	22.49
100	5500	20.65	20.86
116	5580	19.55	19.39
140	5700	19.51	19.33

802.11n (HT20)

Chan.	Freq. (MHz)	26dBc Bandwidth (MHz)	
		Chain 0	Chain 1
52	5260	22.47	23.47
60	5300	22.42	28.30
64	5320	22.89	28.18
100	5500	20.47	21.15
116	5580	20.35	20.46
140	5700	20.26	20.37

802.11n (HT40)

Chan.	Freq. (MHz)	26dBc Bandwidth (MHz)	
		Chain 0	Chain 1
54	5270	77.05	80.05
62	5310	40.82	40.88
102	5510	40.82	41.18
110	5550	75.15	81.19
134	5670	40.75	41.33

802.11ac (VHT80)

Chan.	Freq. (MHz)	26dBc Bandwidth (MHz)	
		Chain 0	Chain 1
58	5290	84.23	83.69
106	5530	84.08	83.56
122	5610	84.42	84.10

Spectrum Plot of Worst Value

802.11a

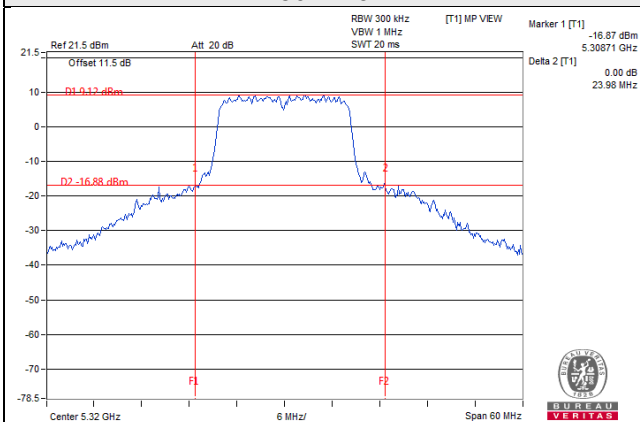

802.11n (HT20)

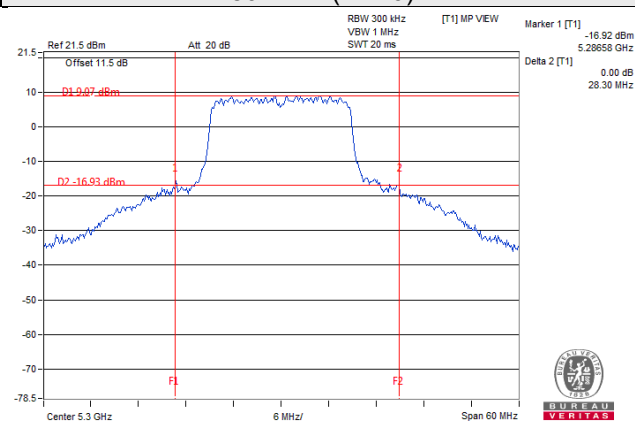

802.11n (HT40)

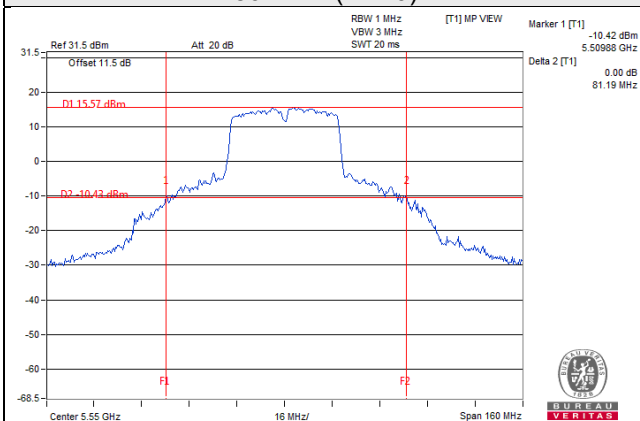

802.11ac (VHT80)

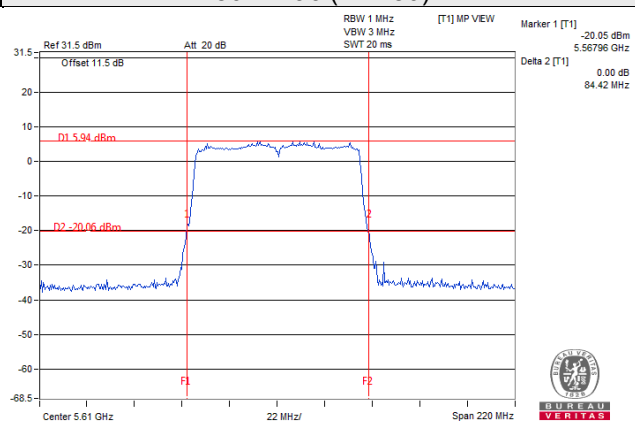

Test Mode C

802.11a

Chan.	Freq. (MHz)	26dBc Bandwidth (MHz)	
		Chain 0	Chain 1
52	5260	25.16	24.09
60	5300	24.95	24.18
64	5320	25.08	24.12
100	5500	23.75	23.05
116	5580	25.20	25.08
140	5700	23.71	22.86

802.11n (HT20)

Chan.	Freq. (MHz)	26dBc Bandwidth (MHz)	
		Chain 0	Chain 1
52	5260	24.54	23.24
60	5300	25.40	23.79
64	5320	24.68	23.07
100	5500	23.22	23.21
116	5580	26.53	24.51
140	5700	22.84	23.16

802.11n (HT40)

Chan.	Freq. (MHz)	26dBc Bandwidth (MHz)	
		Chain 0	Chain 1
54	5270	48.78	56.72
62	5310	47.56	46.31
102	5510	47.68	45.98
110	5550	54.59	47.83
134	5670	53.90	47.38

802.11ac (VHT80)

Chan.	Freq. (MHz)	26dBc Bandwidth (MHz)	
		Chain 0	Chain 1
58	5290	89.23	87.95
106	5530	90.85	90.17
122	5610	84.47	83.72

Spectrum Plot of Worst Value

802.11a

802.11n (HT20)

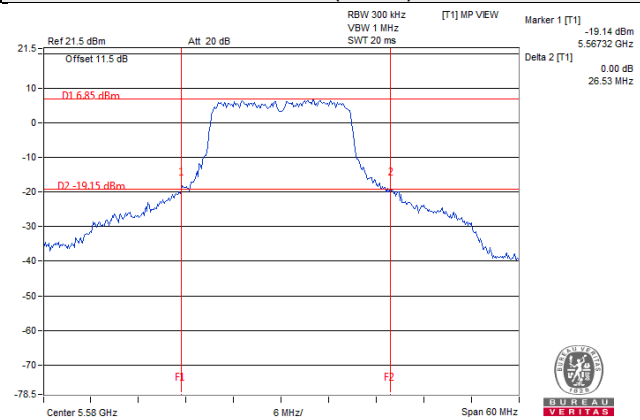
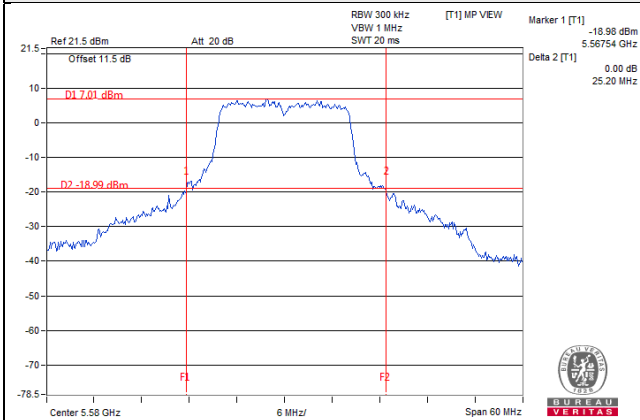

802.11n (HT40)

802.11ac (VHT80)

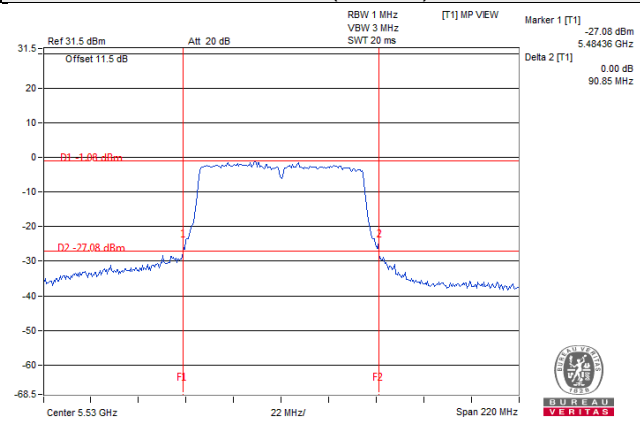
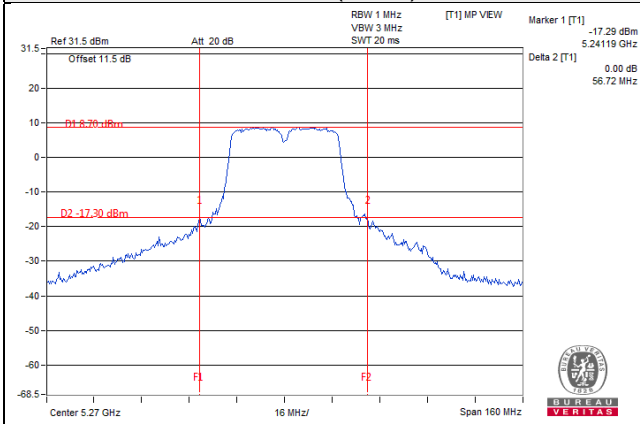

EUT Maximum Conducted Power

Test Mode A

CDD Mode

802.11a

Frequency Band (MHz)	Max. Power	
	Output Power (mW)	Output Power (dBm)
5250~5350	124.335	20.95
5470~5725	125.349	20.98

Note: Manufacturer provides Transmit Power Control description to meet this requirement.

802.11n (HT20)

Frequency Band (MHz)	Max. Power	
	Output Power (mW)	Output Power (dBm)
5250~5350	125.767	21.00
5470~5725	133.087	21.24

Note: Manufacturer provides Transmit Power Control description to meet this requirement.

802.11n (HT40)

Frequency Band (MHz)	Max. Power	
	Output Power (mW)	Output Power (dBm)
5250~5350	192.064	22.83
5470~5725	237.718	23.76

Note: Manufacturer provides Transmit Power Control description to meet this requirement.

802.11ac (VHT80)

Frequency Band (MHz)	Max. Power	
	Output Power (mW)	Output Power (dBm)
5250~5350	50.769	17.06
5470~5725	81.035	19.09

Note: Manufacturer provides Transmit Power Control description to meet this requirement.

Beamforming Mode

802.11n (HT20)

Frequency Band (MHz)	Max. Power	
	Output Power (mW)	Output Power (dBm)
5250~5350	62.951	17.99
5470~5725	66.527	18.23

Note: Manufacturer provides Transmit Power Control description to meet this requirement.

802.11n (HT40)

Frequency Band (MHz)	Max. Power	
	Output Power (mW)	Output Power (dBm)
5250~5350	95.940	19.82
5470~5725	118.850	20.75

Note: Manufacturer provides Transmit Power Control description to meet this requirement.

802.11ac (VHT80)

Frequency Band (MHz)	Max. Power	
	Output Power (mW)	Output Power (dBm)
5250~5350	25.410	14.05
5470~5725	40.551	16.08

Note: Manufacturer provides Transmit Power Control description to meet this requirement.

Test Mode C

CDD Mode

802.11a

Frequency Band (MHz)	Max. Power	
	Output Power (mW)	Output Power (dBm)
5250~5350	53.888	17.31
5470~5725	51.590	17.13

Note: Manufacturer provides Transmit Power Control description to meet this requirement.

802.11n (HT20)

Frequency Band (MHz)	Max. Power	
	Output Power (mW)	Output Power (dBm)
5250~5350	51.720	17.14
5470~5725	53.102	17.25

Note: Manufacturer provides Transmit Power Control description to meet this requirement.

802.11n (HT40)

Frequency Band (MHz)	Max. Power	
	Output Power (mW)	Output Power (dBm)
5250~5350	52.270	17.18
5470~5725	55.371	17.43

Note: Manufacturer provides Transmit Power Control description to meet this requirement.

802.11ac (VHT80)

Frequency Band (MHz)	Max. Power	
	Output Power (mW)	Output Power (dBm)
5250~5350	19.540	12.91
5470~5725	10.307	10.13

Note: Manufacturer provides Transmit Power Control description to meet this requirement.

4.4 Occupied Bandwidth Measurement

4.4.1 Test Setup

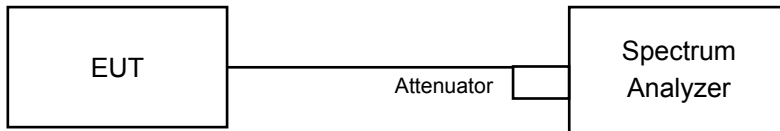

4.4.2 Test Instruments

Refer to section 4.1.2 to get information of above instrument.

4.4.3 Test Procedure

The transmitter output was connected to the spectrum analyzer through an attenuator. The bandwidth of the fundamental frequency was measured by spectrum analyzer with resolution bandwidth in the range of 1% to 5% of the anticipated emission bandwidth, and a video bandwidth at least 3x the resolution bandwidth and set the detector to sampling. The width of a frequency band such that, below the lower and above the upper frequency limits, the mean powers emitted are each equal to a specified percentage 0.5 %of the total mean power of a given emission.

4.4.4 Test Result

Test Mode A

802.11a

Chan.	Freq. (MHz)	Occupied Bandwidth (MHz)	
		Chain 0	Chain 1
52	5260	16.68	16.56
60	5300	16.56	16.56
64	5320	16.68	16.56
100	5500	16.44	16.44
116	5580	16.44	16.44
140	5700	16.56	16.44

802.11n (HT20)

Chan.	Freq. (MHz)	Occupied Bandwidth (MHz)	
		Chain 0	Chain 1
52	5260	17.76	17.76
60	5300	17.64	17.76
64	5320	17.76	17.76
100	5500	17.64	17.64
116	5580	17.64	17.64
140	5700	17.64	17.64

802.11n (HT40)

Chan.	Freq. (MHz)	Occupied Bandwidth (MHz)	
		Chain 0	Chain 1
54	5270	36.72	36.84
62	5310	36.12	36.12
102	5510	36.12	36.12
110	5550	36.72	36.96
134	5670	36.12	36.24

802.11ac (VHT80)

Chan.	Freq. (MHz)	Occupied Bandwidth (MHz)	
		Chain 0	Chain 1
58	5290	75.84	75.84
106	5530	75.84	75.84
122	5610	76.32	75.84

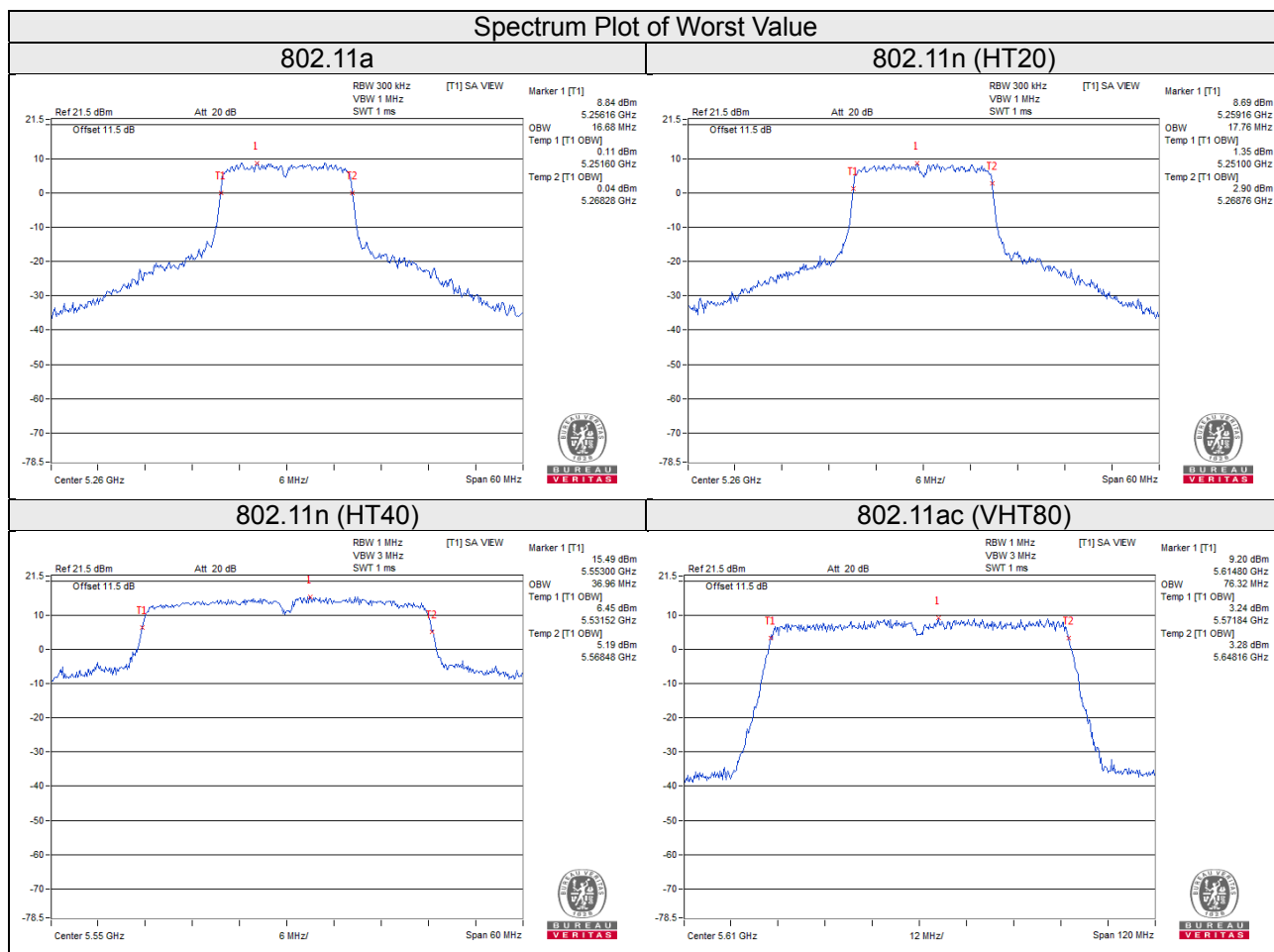

Test Mode C

802.11a

Chan.	Freq. (MHz)	Occupied Bandwidth (MHz)	
		Chain 0	Chain 1
52	5260	16.80	16.68
60	5300	16.80	16.68
64	5320	16.80	16.68
100	5500	16.80	16.68
116	5580	16.92	16.80
140	5700	16.80	16.56

802.11n (HT20)

Chan.	Freq. (MHz)	Occupied Bandwidth (MHz)	
		Chain 0	Chain 1
52	5260	18.00	18.00
60	5300	17.88	17.88
64	5320	17.88	17.88
100	5500	18.00	18.00
116	5580	18.12	18.00
140	5700	17.88	18.00

802.11n (HT40)

Chan.	Freq. (MHz)	Occupied Bandwidth (MHz)	
		Chain 0	Chain 1
54	5270	37.08	36.96
62	5310	36.96	36.84
102	5510	37.32	36.96
110	5550	37.32	36.84
134	5670	37.20	36.84

802.11ac (VHT80)

Chan.	Freq. (MHz)	Occupied Bandwidth (MHz)	
		Chain 0	Chain 1
58	5290	76.08	76.08
106	5530	76.32	76.08
122	5610	76.32	76.32

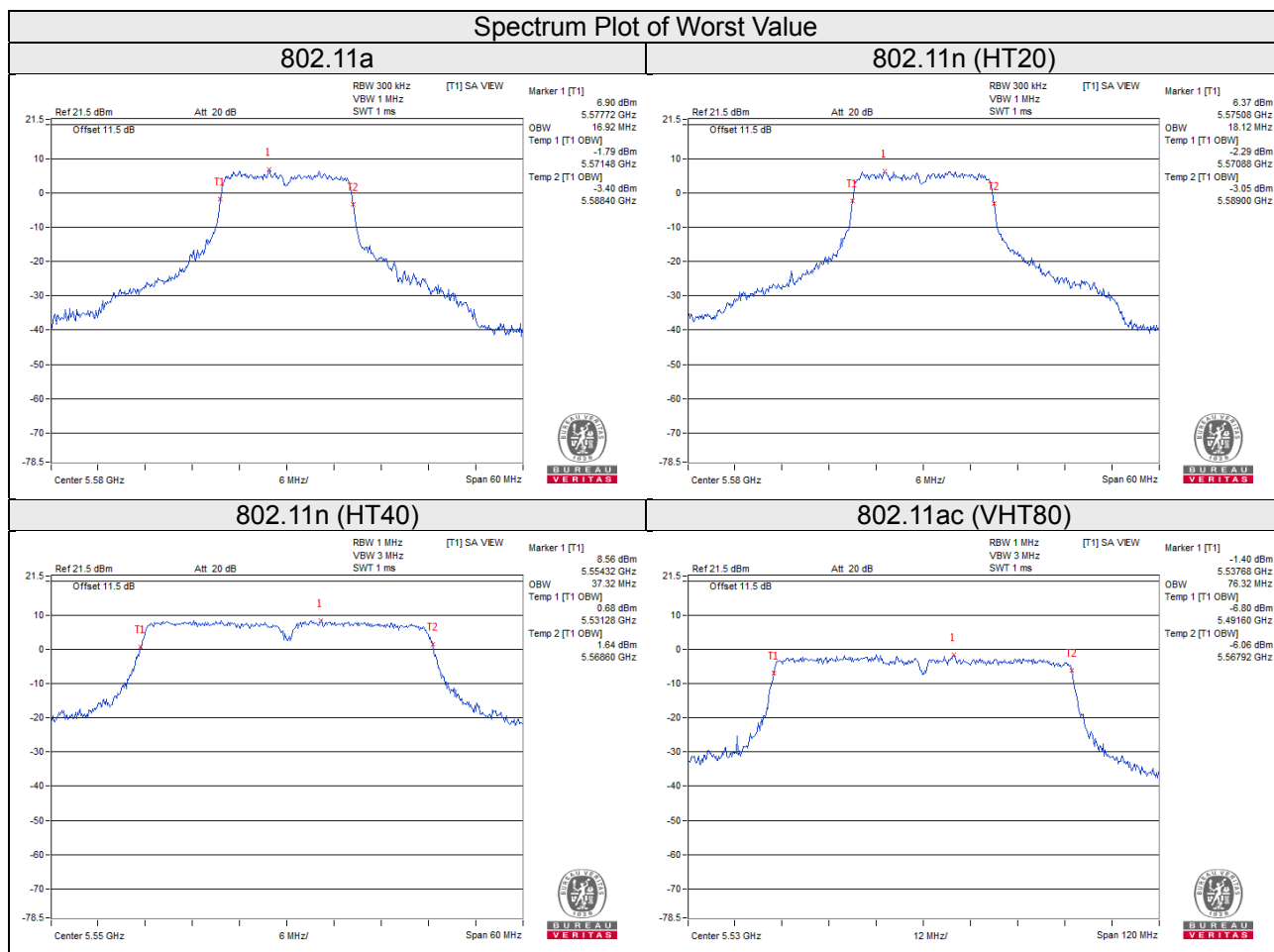

4.5 Peak Power Spectral Density Measurement

4.5.1 Limits of Peak Power Spectral Density Measurement

Operation Band	EUT Category		LIMIT
U-NII-1	-	Outdoor Access Point	17dBm/ MHz
	-	Fixed point-to-point Access Point	
	-	Indoor Access Point	
	-	Mobile and Portable client device	11dBm/ MHz
U-NII-2A	√		11dBm/ MHz
U-NII-2C	√		11dBm/ MHz
U-NII-3	-		30dBm/ 500kHz

4.5.2 Test Setup

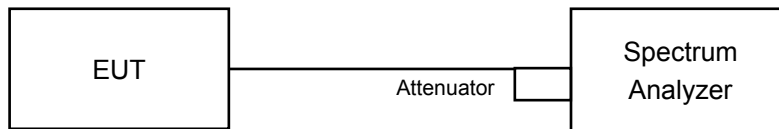

4.5.3 Test Instruments

Refer to section 4.1.2 to get information of above instrument.

4.5.4 Test Procedures

For U-NII-2A, U-NII-2C band:

Duty cycle of test signal is $\geq 98\%$

Using method SA-1

- 1) Set span to encompass the entire emission bandwidth (EBW) of the signal.
- 2) Set RBW = 1MHz, Set VBW ≥ 3 MHz, Detector = RMS
- 3) Set Channel power measure = 1MHz
- 4) Sweep time = auto, trigger set to "free run".
- 5) Trace average at least 100 traces in power averaging mode.
- 6) Record the max value

For U-NII-3 band:

Duty cycle of test signal is $\geq 98\%$

Using method SA-1

- 1) Set span to encompass the entire emission bandwidth (EBW) of the signal.
- 2) Set RBW = 300 kHz, Set VBW ≥ 1 MHz, Detector = RMS.
- 3) Use the peak marker function to determine the maximum power level in any 300 kHz band segment within the fundamental EBW.
- 4) Scale the observed power level to an equivalent value in 500 kHz by adjusting (reducing) the measured 1) power by a bandwidth correction factor (BWCF) where $BWCF = 10\log(500 \text{ kHz} / 300 \text{ kHz})$.
- 5) Sweep time = auto, trigger set to "free run".
- 6) Trace average at least 100 traces in power averaging mode.
- 7) Record the max value.

4.5.5 Deviation from Test Standard

No deviation.

4.5.6 EUT Operating Conditions

Same as 4.3.6.

4.5.7 Test Results

For U-NII-2A, U-NII-2C band

Test Mode A

802.11a

Chan.	Frequency (MHz)	PSD (dBm/MHz)		Duty Factor	Total PSD With Duty Factor (dBm/MHz)	Maximum Limit (dBm/MHz)	Pass / Fail
		Chain 0	Chain 1				
52	5260	4.52	4.42	0.17	7.65	8.00	Pass
60	5300	4.36	4.57	0.17	7.64	8.00	Pass
64	5320	4.51	4.50	0.17	7.68	8.00	Pass
100	5500	4.52	4.84	0.17	7.86	8.00	Pass
116	5580	4.93	4.58	0.17	7.93	8.00	Pass
140	5700	4.94	4.61	0.17	7.95	8.00	Pass

Note:

- Method 1 of power density measurement of KDB 662911 is using for calculating total power density. Total power density is summing entire spectra across corresponding frequency bins on the various outputs by computer.
- For U-NII-2A, U-NII-2C:** Directional gain = $5.99\text{dBi} + 10\log(2) = 9\text{dBi} > 6\text{dBi}$, so the power density limit shall be reduced to $11 - (9 - 6) = 8\text{dBm}$.
- Refer to section 3.3 for duty cycle spectrum plot.

802.11n (HT20)

Chan.	Frequency (MHz)	PSD (dBm/MHz)		Total PSD (dBm/MHz)	Maximum Limit (dBm/MHz)	Pass / Fail
		Chain 0	Chain 1			
52	5260	4.37	4.30	7.35	8.00	Pass
60	5300	4.26	4.39	7.34	8.00	Pass
64	5320	4.35	4.38	7.38	8.00	Pass
100	5500	4.32	5.06	7.72	8.00	Pass
116	5580	4.79	4.83	7.82	8.00	Pass
140	5700	4.46	4.78	7.63	8.00	Pass

Note:

- Method 1 of power density measurement of KDB 662911 is using for calculating total power density. Total power density is summing entire spectra across corresponding frequency bins on the various outputs by computer.
- For U-NII-2A, U-NII-2C:** Directional gain = $5.99\text{dBi} + 10\log(2) = 9\text{dBi} > 6\text{dBi}$, so the power density limit shall be reduced to $11 - (9 - 6) = 8\text{dBm}$.

802.11n (HT40)

Chan.	Frequency (MHz)	PSD (dBm/MHz)		Duty Factor	Total PSD With Duty Factor (dBm/MHz)	Maximum Limit (dBm/MHz)	Pass / Fail
		Chain 0	Chain 1				
54	5270	3.23	3.55	0.16	6.56	8.00	Pass
62	5310	-1.28	-1.08	0.16	1.99	8.00	Pass
102	5510	0.02	0.68	0.16	3.53	8.00	Pass
110	5550	4.61	5.00	0.16	7.98	8.00	Pass
134	5670	2.30	2.52	0.16	5.58	8.00	Pass

Note:

- Method 1 of power density measurement of KDB 662911 is using for calculating total power density. Total power density is summing entire spectra across corresponding frequency bins on the various outputs by computer.
- For U-NII-2A, U-NII-2C:** Directional gain = $5.99\text{dBi} + 10\log(2) = 9\text{dBi} > 6\text{dBi}$, so the power density limit shall be reduced to $11 - (9 - 6) = 8\text{dBm}$.
- Refer to section 3.3 for duty cycle spectrum plot.

802.11ac (VHT80)

Chan.	Frequency (MHz)	PSD (dBm/MHz)		Duty Factor	Total PSD With Duty Factor (dBm/MHz)	Maximum Limit (dBm/MHz)	Pass / Fail
		Chain 0	Chain 1				
58	5290	-5.89	-5.79	0.33	-2.50	8.00	Pass
106	5530	-3.60	-3.19	0.33	-0.05	8.00	Pass
122	5610	-5.11	-5.07	0.33	-1.75	8.00	Pass

Note:

- Method 1 of power density measurement of KDB 662911 is using for calculating total power density. Total power density is summing entire spectra across corresponding frequency bins on the various outputs by computer.
- For U-NII-2A, U-NII-2C:** Directional gain = $5.99\text{dBi} + 10\log(2) = 9\text{dBi} > 6\text{dBi}$, so the power density limit shall be reduced to $11 - (9 - 6) = 8\text{dBm}$.
- Refer to section 3.3 for duty cycle spectrum plot.

Spectrum Plot of Worst Value

802.11a / Chain 0 / Ch 140

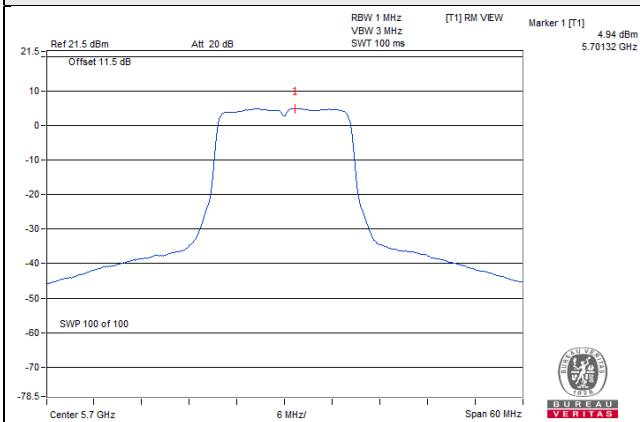

802.11n (HT20) / Chain 1 / Ch 100

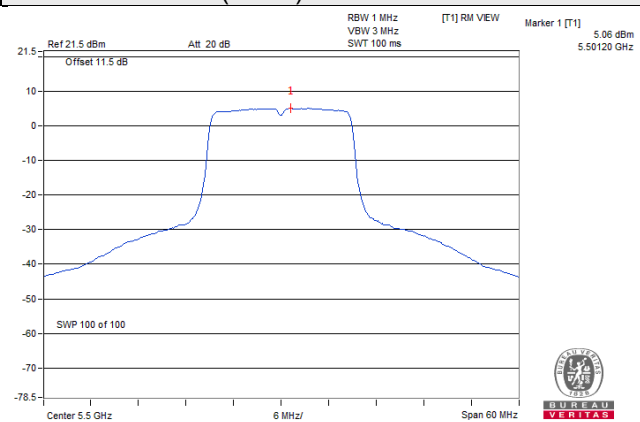

802.11n (HT40) / Chain 1 / Ch 110

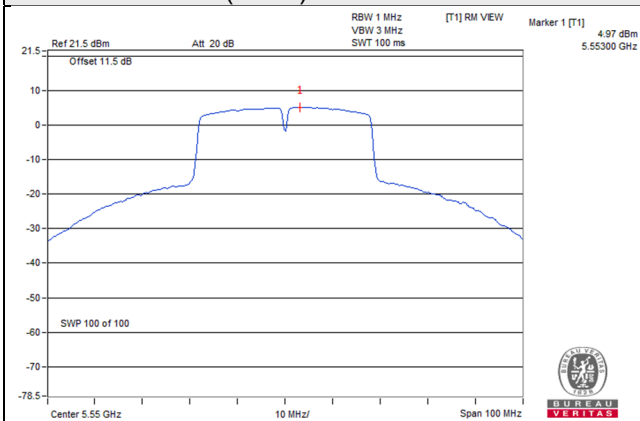

802.11ac (VHT80) / Chain 1 / Ch 106

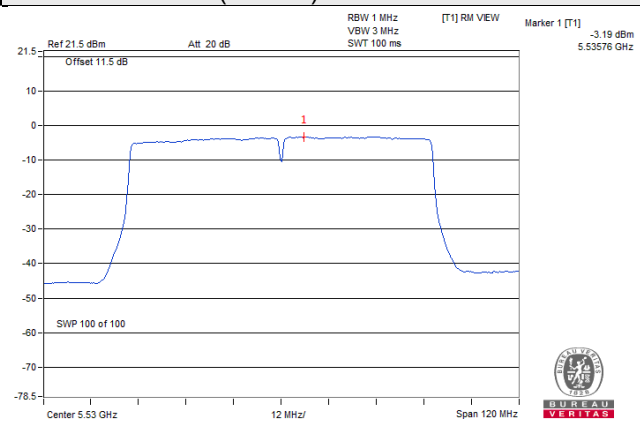

Test Mode C

802.11a

Chan.	Frequency (MHz)	PSD (dBm/MHz)		Duty Factor	Total PSD With Duty Factor (dBm/MHz)	Maximum Limit (dBm/MHz)	Pass / Fail
		Chain 0	Chain 1				
52	5260	1.39	1.56	0.16	4.64	9.16	Pass
60	5300	1.40	1.35	0.16	4.54	9.16	Pass
64	5320	1.51	1.57	0.16	4.71	9.16	Pass
100	5500	0.59	0.16	0.16	3.55	9.16	Pass
116	5580	2.02	1.98	0.16	5.17	9.16	Pass
140	5700	0.02	0.00	0.16	3.18	9.16	Pass

Note:

- Method 1 of power density measurement of KDB 662911 is using for calculating total power density. Total power density is summing entire spectra across corresponding frequency bins on the various outputs by computer.
- For U-NII-2A, U-NII-2C:** Directional gain = 4.83dBi + 10log (2) = 7.84dBi > 6dBi, so the limit shall be reduced to 11-(7.84-6) = 9.16dBm.
- Refer to section 3.3 for duty cycle spectrum plot.

802.11n (HT20)

Chan.	Frequency (MHz)	PSD (dBm/MHz)		Duty Factor	Total PSD With Duty Factor (dBm/MHz)	Maximum Limit (dBm/MHz)	Pass / Fail
		Chain 0	Chain 1				
52	5260	1.29	1.18	0.17	4.42	9.16	Pass
60	5300	1.22	1.12	0.17	4.35	9.16	Pass
64	5320	1.38	1.27	0.17	4.51	9.16	Pass
100	5500	0.67	0.33	0.17	3.69	9.16	Pass
116	5580	2.26	1.41	0.17	5.04	9.16	Pass
140	5700	0.34	-0.33	0.17	3.20	9.16	Pass

Note:

- Method 1 of power density measurement of KDB 662911 is using for calculating total power density. Total power density is summing entire spectra across corresponding frequency bins on the various outputs by computer.
- For U-NII-2A, U-NII-2C:** Directional gain = 4.83dBi + 10log (2) = 7.84dBi > 6dBi, so the limit shall be reduced to 11-(7.84-6) = 9.16dBm.
- Refer to section 3.3 for duty cycle spectrum plot.

802.11n (HT40)

Chan.	Frequency (MHz)	PSD (dBm/MHz)		Duty Factor	Total PSD With Duty Factor (dBm/MHz)	Maximum Limit (dBm/MHz)	Pass / Fail
		Chain 0	Chain 1				
54	5270	-2.08	-1.68	0.38	1.52	9.16	Pass
62	5310	-4.01	-3.51	0.38	-0.36	9.16	Pass
102	5510	-7.98	-8.91	0.38	-5.03	9.16	Pass
110	5550	-1.61	-2.47	0.38	1.37	9.16	Pass
134	5670	-1.44	-2.30	0.38	1.55	9.16	Pass

Note:

- Method 1 of power density measurement of KDB 662911 is using for calculating total power density. Total power density is summing entire spectra across corresponding frequency bins on the various outputs by computer.
- For U-NII-2A, U-NII-2C:** Directional gain = 4.83dBi +10log (2) = 7.84dBi > 6dBi, so the limit shall be reduced to 11-(7.84-6) = 9.16dBm.
- Refer to section 3.3 for duty cycle spectrum plot.

802.11ac (VHT80)

Chan.	Frequency (MHz)	PSD (dBm/MHz)		Duty Factor	Total PSD With Duty Factor (dBm/MHz)	Maximum Limit (dBm/MHz)	Pass / Fail
		Chain 0	Chain 1				
58	5290	-10.46	-9.85	0.67	-6.46	9.16	Pass
106	5530	-12.75	-13.71	0.67	-9.52	9.16	Pass
122	5610	-12.77	-13.80	0.67	-9.57	9.16	Pass

Note:

- Method 1 of power density measurement of KDB 662911 is using for calculating total power density. Total power density is summing entire spectra across corresponding frequency bins on the various outputs by computer.
- For U-NII-2A, U-NII-2C:** Directional gain = 4.83dBi +10log (2) = 7.84dBi > 6dBi, so the limit shall be reduced to 11-(7.84-6) = 9.16dBm.
- Refer to section 3.3 for duty cycle spectrum plot.

Spectrum Plot of Worst Value

802.11a / Chain 0 / Ch 116

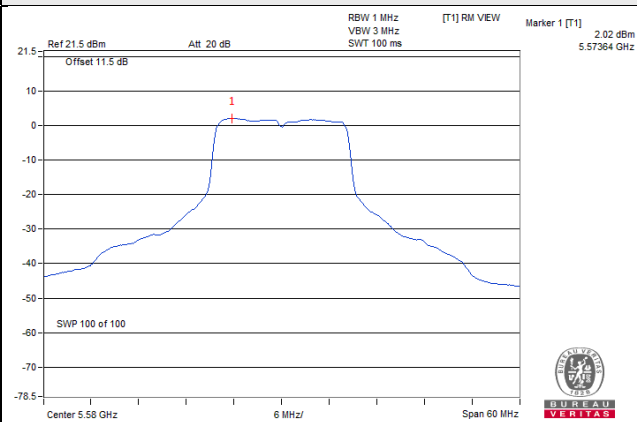

802.11n (HT20) / Chain 0 / Ch 116

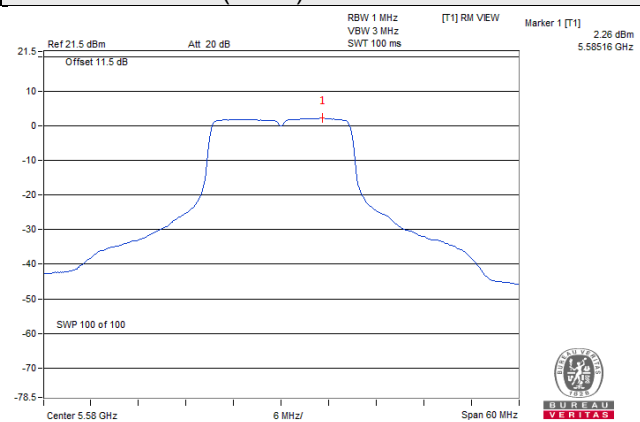

802.11n (HT40) / Chain 0 / Ch 134

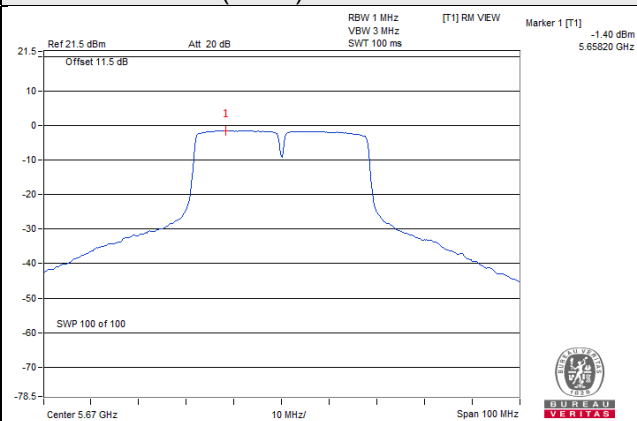

802.11ac (VHT80) / Chain 1 / Ch 58

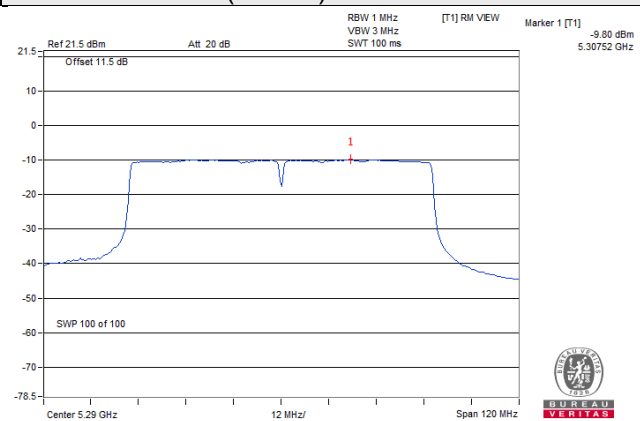

4.6 Frequency Stability

4.6.1 Limits of Frequency Stability Measurement

The frequency of the carrier signal shall be maintained within band of operation

4.6.2 Test Setup

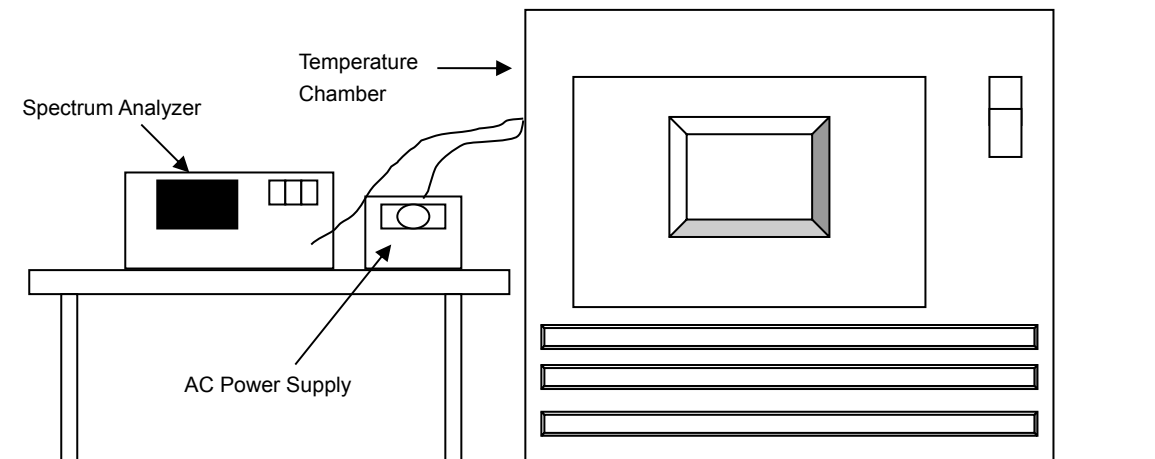

4.6.3 Test Instruments

Refer to section 4.1.2 to get information of above instrument.

4.6.4 Test Procedure

- The EUT was placed inside the environmental test chamber and powered by nominal AC voltage.
- Turn the EUT on and couple its output to a spectrum analyzer.
- Turn the EUT off and set the chamber to the highest temperature specified.
- Allow sufficient time (approximately 30 min) for the temperature of the chamber to stabilize, turn the EUT on and measure the operating frequency after 2, 5, and 10 minutes.
- Repeat step 2 and 3 with the temperature chamber set to the lowest temperature.
- The test chamber was allowed to stabilize at +20 degree C for a minimum of 30 minutes. The supply voltage was then adjusted on the EUT from 85% to 115% and the frequency record.

4.6.5 Deviation from Test Standard

No deviation.

4.6.6 EUT Operating Condition

Set the EUT transmit at un-modulation mode to test frequency stability.

4.6.7 Test Results

Frequency Stability Versus Temp.									
Operating Frequency: 5260MHz									
Temp. (°C)	Power Supply (Vac)	0 Minute		2 Minute		5 Minute		10 Minute	
		Measured Frequency (MHz)	Result	Measured Frequency (MHz)	Result	Measured Frequency (MHz)	Result	Measured Frequency (MHz)	Result
50	120	5260.0076	Pass	5260.0074	Pass	5260.0035	Pass	5260.0059	Pass
40	120	5260.0011	Pass	5260.0025	Pass	5260.0054	Pass	5260.0014	Pass
30	120	5259.9714	Pass	5259.9743	Pass	5259.9713	Pass	5259.9746	Pass
20	120	5259.9966	Pass	5259.9934	Pass	5259.9928	Pass	5259.9967	Pass
10	120	5259.9803	Pass	5259.9800	Pass	5259.9796	Pass	5259.9784	Pass
0	120	5259.9995	Pass	5260.0027	Pass	5260.0024	Pass	5260.0016	Pass
-10	120	5259.9775	Pass	5259.9793	Pass	5259.9766	Pass	5259.9778	Pass
-20	120	5259.9737	Pass	5259.9757	Pass	5259.9733	Pass	5259.9722	Pass
-30	120	5259.9844	Pass	5259.9836	Pass	5259.9841	Pass	5259.9860	Pass

Frequency Stability Versus Voltage									
Operating Frequency: 5260MHz									
Temp. (°C)	Power Supply (Vac)	0 Minute		2 Minute		5 Minute		10 Minute	
		Measured Frequency (MHz)	Result	Measured Frequency (MHz)	Result	Measured Frequency (MHz)	Result	Measured Frequency (MHz)	Result
20	138	5259.9966	Pass	5259.9943	Pass	5259.9923	Pass	5259.9959	Pass
	120	5259.9966	Pass	5259.9934	Pass	5259.9928	Pass	5259.9967	Pass
	102	5259.9973	Pass	5259.9929	Pass	5259.9925	Pass	5259.9958	Pass

5 Pictures of Test Arrangements

Please refer to the attached file (Test Setup Photo).

Appendix – Information on the Testing Laboratories

We, Bureau Veritas Consumer Products Services (H.K.) Ltd., Taoyuan Branch, were founded in 1988 to provide our best service in EMC, Radio, Telecom and Safety consultation. Our laboratories are accredited and approved according to ISO/IEC 17025.

If you have any comments, please feel free to contact us at the following:

Linko EMC/RF Lab

Tel: 886-2-26052180

Fax: 886-2-26051924

Hsin Chu EMC/RF/Telecom Lab

Tel: 886-3-6668565

Fax: 886-3-6668323

Hwa Ya EMC/RF/Safety

Tel: 886-3-3183232

Fax: 886-3-3270892

Email: service.adt@tw.bureauveritas.com

Web Site: www.bureauveritas-adt.com

The address and road map of all our labs can be found in our web site also.

--- END ---