

FCC Test Report

Report No.: RF180108C15-1

FCC ID: TOR-W118

Test Model: W-118

Received Date: Jan. 08, 2018

Test Date: Mar. 06 ~ Mar. 16, 2018

Issued Date: Mar. 20, 2018

Applicant: Mojo Networks, Inc.

Address: 339 N. Bernardo Avenue, Suite #200, Mountain View, California United States 94043

Issued By: Bureau Veritas Consumer Products Services (H.K.) Ltd., Taoyuan Branch

Lab Address: No. 47-2, 14th Ling, Chia Pau Vil., Lin Kou Dist., New Taipei City, Taiwan, R.O.C.

Test Location: No. 19, Hwa Ya 2nd Rd., Wen Hwa Vil., Kwei Shan Dist., Taoyuan City 33383, TAIWAN (R.O.C.)

**FCC Registration /
Designation Number:** 788550 / TW0003



This report is for your exclusive use. Any copying or replication of this report to or for any other person or entity, or use of our name or trademark, is permitted only with our prior written permission. This report sets forth our findings solely with respect to the test samples identified herein. The results set forth in this report are not indicative or representative of the quality or characteristics of the lot from which a test sample was taken or any similar or identical product unless specifically and expressly noted. Our report includes all of the tests requested by you and the results thereof based upon the information that you provided to us. You have 60 days from date of issuance of this report to notify us of any material error or omission caused by our negligence, provided, however, that such notice shall be in writing and shall specifically address the issue you wish to raise. A failure to raise such issue within the prescribed time shall constitute your unqualified acceptance of the completeness of this report, the tests conducted and the correctness of the report contents. Unless specific mention, the uncertainty of measurement has been explicitly taken into account to declare the compliance or non-compliance to the specification. This report should not be used by the client to claim product certification, approval, or endorsement by TAF or any government agencies.

Table of Contents

Release Control Record	4
1 Certificate of Conformity	5
2 Summary of Test Results	6
2.1 Measurement Uncertainty.....	6
2.2 Modification Record.....	6
3 General Information	7
3.1 General Description of EUT.....	7
3.2 Description of Test Modes.....	8
3.2.1 Test Mode Applicability and Tested Channel Detail.....	9
3.1 Duty Cycle of Test Signal.....	10
3.2 Description of Support Units.....	11
3.2.1 Configuration of System under Test.....	11
3.3 General Description of Applied Standards.....	12
4 Test Types and Results	13
4.1 Radiated Emission and Bandedge Measurement.....	13
4.1.1 Limits of Radiated Emission and Bandedge Measurement.....	13
4.1.2 Test Instruments.....	14
4.1.3 Test Procedures.....	15
4.1.4 Deviation from Test Standard.....	15
4.1.5 Test Set Up.....	16
4.1.6 EUT Operating Conditions.....	16
4.1.7 Test Results.....	17
4.2 Conducted Emission Measurement.....	22
4.2.1 Limits of Conducted Emission Measurement.....	22
4.2.2 Test Instruments.....	22
4.2.3 Test Procedures.....	23
4.2.4 Deviation from Test Standard.....	23
4.2.5 Test Setup.....	23
4.2.6 EUT Operating Conditions.....	23
4.2.7 Test Results.....	24
4.3 6dB Bandwidth Measurement.....	28
4.3.1 Limits of 6dB Bandwidth Measurement.....	28
4.3.2 Test Setup.....	28
4.3.3 Test Instruments.....	28
4.3.4 Test Procedure.....	28
4.3.5 Deviation from Test Standard.....	28
4.3.6 EUT Operating Conditions.....	28
4.3.7 Test Result.....	29
4.4 Conducted Output Power Measurement.....	30
4.4.1 Limits of Conducted Output Power Measurement.....	30
4.4.2 Test Setup.....	30
4.4.3 Test Instruments.....	30
4.4.4 Test Procedures.....	30
4.4.5 Deviation from Test Standard.....	30
4.4.6 EUT Operating Conditions.....	30
4.4.7 Test Results.....	30
4.5 Power Spectral Density Measurement.....	31
4.5.1 Limits of Power Spectral Density Measurement.....	31
4.5.2 Test Setup.....	31
4.5.3 Test Instruments.....	31
4.5.4 Test Procedure.....	31
4.5.5 Deviation from Test Standard.....	31
4.5.6 EUT Operating Condition.....	31

4.5.7 Test Results	32
4.6 Conducted Out of Band Emission Measurement.....	33
4.6.1 Limits of Conducted Out of Band Emission Measurement	33
4.6.2 Test Setup.....	33
4.6.3 Test Instruments	33
4.6.4 Test Procedure	33
4.6.5 Deviation from Test Standard	33
4.6.6 EUT Operating Condition	33
4.6.7 Test Results	34
5 Pictures of Test Arrangements.....	35
Appendix – Information on the Testing Laboratories	36

Release Control Record

Issue No.	Description	Date Issued
RF180108C15-1	Original release	Mar. 20, 2018

1 Certificate of Conformity

Product: Wall Jack Access Point

Brand: Mojo

Test Model: W-118

Sample Status: Engineering sample

Applicant: Mojo Networks, Inc.

Test Date: Mar. 06 ~ Mar. 16, 2018

Standards: 47 CFR FCC Part 15, Subpart C (Section 15.247)
ANSI C63.10:2013

The above equipment has been tested by **Bureau Veritas Consumer Products Services (H.K.) Ltd., Taoyuan Branch**, and found compliance with the requirement of the above standards. The test record, data evaluation & Equipment Under Test (EUT) configurations represented herein are true and accurate accounts of the measurements of the sample's RF characteristics under the conditions specified in this report.

Prepared by :  , **Date:** Mar. 20, 2018
Pettie Chen / Senior Specialist

Approved by :  , **Date:** Mar. 20, 2018
Bruce Chen / Project Engineer

2 Summary of Test Results

47 CFR FCC Part 15, Subpart C (Section 15.247)			
FCC Clause	Test Item	Result	Remarks
15.207	AC Power Conducted Emission	Pass	Meet the requirement of limit. Minimum passing margin is -3.94dB at 0.15781MHz.
15.205 / 15.209 / 15.247(d)	Radiated Emissions and Band Edge Measurement	Pass	Meet the requirement of limit. Minimum passing margin is -1.6dB at 2483.50MHz.
15.247(d)	Antenna Port Emission	Pass	Meet the requirement of limit.
15.247(a)(2)	6dB bandwidth	Pass	Meet the requirement of limit.
15.247(b)	Conducted power	Pass	Meet the requirement of limit.
15.247(e)	Power Spectral Density	Pass	Meet the requirement of limit.
15.203	Antenna Requirement	Pass	No antenna connector is used

2.1 Measurement Uncertainty

Where relevant, the following measurement uncertainty levels have been estimated for tests performed on the EUT as specified in CISPR 16-4-2:

Measurement	Frequency	Expanded Uncertainty (k=2) (\pm)
Conducted Emissions at mains ports	150kHz ~ 30MHz	2.94 dB
Radiated Emissions up to 1 GHz	30MHz ~ 200MHz	3.86 dB
	200MHz ~ 1000MHz	3.87 dB
Radiated Emissions above 1 GHz	1GHz ~ 18GHz	2.29 dB
	18GHz ~ 40GHz	2.29 dB

2.2 Modification Record

There were no modifications required for compliance.

3 General Information

3.1 General Description of EUT

Product	Wall Jack Access Point
Brand	Mojo
Test Model	W-118
Status of EUT	Engineering sample
Power Supply Rating	12Vdc from Adapter 54Vdc from POE
Modulation Type	O-QPSK
Operating Frequency	2405 ~ 2480MHz
Number of Channel	16
Output Power	1.722mW
Antenna Type	Refer to Note
Antenna Connector	Refer to Note
Accessory Device	NA
Data Cable Supplied	NA

Note:

- The EUT consumes power from following Adapter and POE. (Support unit only)

Adapter	
Brand	Powertron Electronics Corp.
Model	PA1024-120IB200
Input Power	100-240Vac, 50-60Hz, 0.6A
Output Power	12Vdc / 2.0A 24W Max
Power Cord	1.5m non-shielded cable with one core 0.5m non-shielded cable without core

POE	
Brand	EnGenius
Model	EPA5006GAT
Input Power	100-240Vac, 50-60Hz, 0.8A
Output Power	54Vdc, 0.6A

- The EUT uses following antennas.

Type	PIFA						PIFA
Connector	IPEX						-
Radio	1		2		3		BT/Zigbee
Frequency (MHz)	2400-2500		5150-5850		2400-2500 & 5150-5850		2400-2500
Antenna	1	2	3	4	5	6	BT/Zigbee
Gain (dBi)	3.67	4.31	5.72	5.99	2.51 / 4.83	2.78 / 4.80	2.76

3. Spurious emission of the simultaneous operation mode as below and the test data please refer to report no.: RF180108C15-4.

No	Mode
1	Radio 1 + Radio 2 + Radio 3(2.4GHz) + BT LE
2	Radio 1 + Radio 3(5GHz) + BT LE
3	Radio 1 + Radio 2 + Radio 3(2.4GHz)+ Zigbee
4	Radio 1 + Radio 3(5GHz) + Zigbee

*The Radio 2 and Radio 3(5GHz) cannot transmit simultaneously.

3.2 Description of Test Modes

16 channels are provided to this EUT:

Channel	Freq. (MHz)	Channel	Freq. (MHz)	Channel	Freq. (MHz)	Channel	Freq. (MHz)
11	2405	15	2425	19	2445	23	2465
12	2410	16	2430	20	2450	24	2470
13	2415	17	2435	21	2455	25	2475
14	2420	18	2440	22	2460	26	2480

3.2.1 Test Mode Applicability and Tested Channel Detail

EUT CONFIGURE MODE	APPLICABLE TO				DESCRIPTION
	RE \geq 1G	RE<1G	PLC	APCM	
A	√	√	√	√	Power from adapter
B	-	√	√	-	Power from PoE

Where **RE \geq 1G**: Radiated Emission above 1GHz & Bandedge Measurement
RE<1G: Radiated Emission below 1GHz
PLC: Power Line Conducted Emission
APCM: Antenna Port Conducted Measurement

Note:

1. The EUT had been pre-tested on the positioned of each 3 axis. The worst case was found when positioned on **Z-plane**.
2. "-": Means no effect.

Radiated Emission Test (Above 1GHz):

- Pre-Scan has been conducted to determine the worst-case mode from all possible combinations between available modulations, data rates and antenna ports (if EUT with antenna diversity architecture).
- Following channel(s) was (were) selected for the final test as listed below.

EUT CONFIGURE MODE	AVAILABLE CHANNEL	TESTED CHANNEL	MODULATION TYPE
A	11 to 26	11, 18, 26	O-QPSK

Radiated Emission Test (Below 1GHz):

- Pre-Scan has been conducted to determine the worst-case mode from all possible combinations between available modulations, data rates and antenna ports (if EUT with antenna diversity architecture).
- Following channel(s) was (were) selected for the final test as listed below.

EUT CONFIGURE MODE	AVAILABLE CHANNEL	TESTED CHANNEL	MODULATION TYPE
A, B	11 to 26	11	O-QPSK

Power Line Conducted Emission Test:

- Pre-Scan has been conducted to determine the worst-case mode from all possible combinations between available modulations, data rates and antenna ports (if EUT with antenna diversity architecture).
- Following channel(s) was (were) selected for the final test as listed below.

EUT CONFIGURE MODE	AVAILABLE CHANNEL	TESTED CHANNEL	MODULATION TYPE
A, B	11 to 26	11	O-QPSK

Antenna Port Conducted Measurement:

- This item includes all test value of each mode, but only includes spectrum plot of worst value of each mode.
- Pre-Scan has been conducted to determine the worst-case mode from all possible combinations between available modulations, data rates and antenna ports (if EUT with antenna diversity architecture).
- Following channel(s) was (were) selected for the final test as listed below.

EUT CONFIGUURE MODE	AVAILABLE CHANNEL	TESTED CHANNEL	MODULATION TYPE
A	11 to 26	11, 18, 26	O-QPSK

Test Condition:

APPLICABLE TO	ENVIRONMENTAL CONDITIONS	INPUT POWER	TESTED BY
RE≥1G	22 deg. C, 68% RH	120Vac, 60Hz	Adair Peng
RE<1G	22 deg. C, 68% RH	120Vac, 60Hz	Adair Peng
PLC	25 deg. C, 75% RH	120Vac, 60Hz	Noah Chang
APCM	25 deg. C, 60% RH	120Vac, 60Hz	Alan Wu

3.1 Duty Cycle of Test Signal

Duty cycle of test signal is < 98%, duty factor is required.

Duty cycle = $2.66/3.012 = 0.883$, Duty factor = $10 * \log(1/0.883) = 0.54$

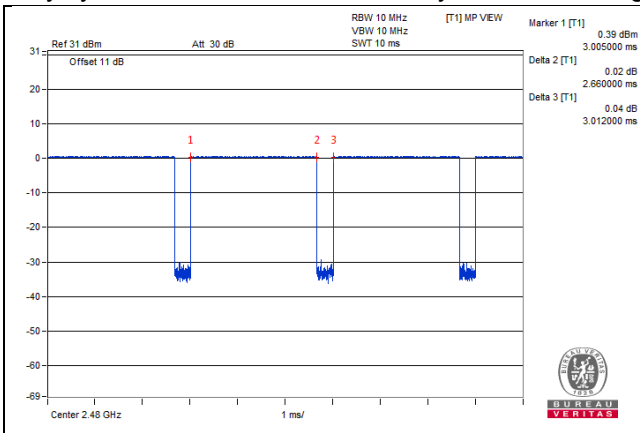

3.2 Description of Support Units

The EUT has been tested as an independent unit together with other necessary accessories or support units. The following support units or accessories were used to form a representative test configuration during the tests.

ID	Product	Brand	Model No.	Serial No.	FCC ID	Remarks
A.	Notebook	Lenovo	80Q7	PF0KUGU6	FCC DoC Approved	-
B.	Adapter	Powertron	PA1024-120IB200	NA	NA	Provided by manufacturer
C.	Load	NA	NA	NA	NA	-
D.	POE	EnGenius	EPA5006GAT	NA	NA	Provided by manufacturer

Note:

1. All power cords of the above support units are non-shielded (1.8m).
2. Item A acted as a communication partner to transfer data.

ID	Descriptions	Qty.	Length (m)	Shielding (Yes/No)	Cores (Qty.)	Remarks
1.	RJ45, Cat5e	1	10	N	0	-
2.	RJ45, Cat5e	4	3	N	0	-
3.	Power Cord	1	1.0	N	0	-
4.	RJ45, Cat5e	1	3	N	0	-

Note: The core(s) is(are) originally attached to the cable(s).

3.2.1 Configuration of System under Test

Test Mode A

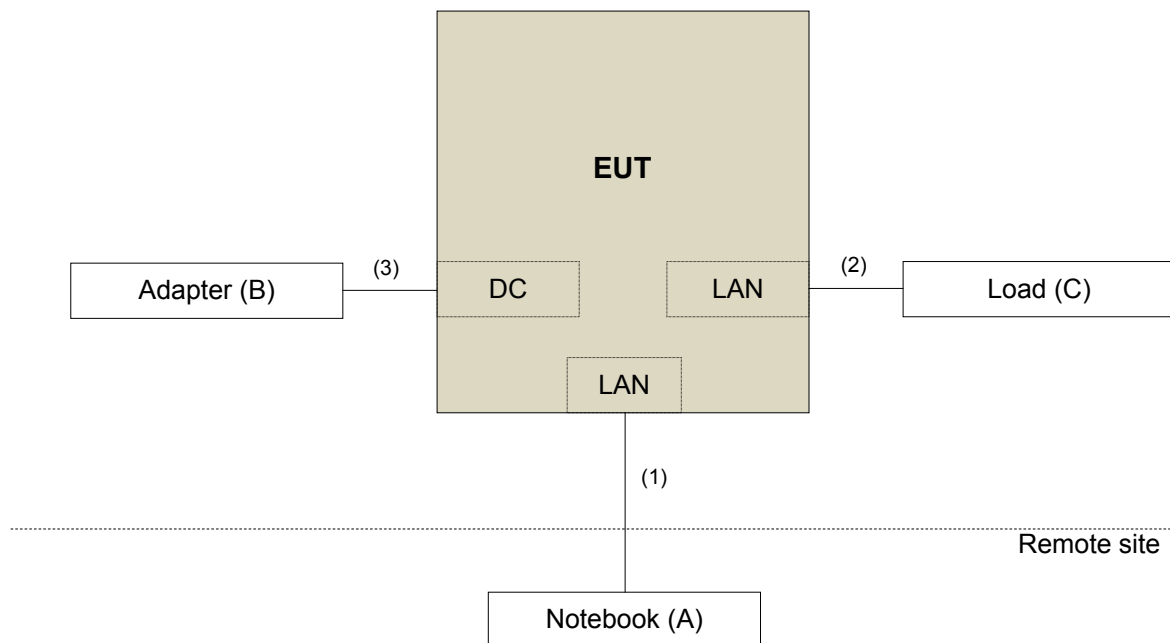

Test Mode B

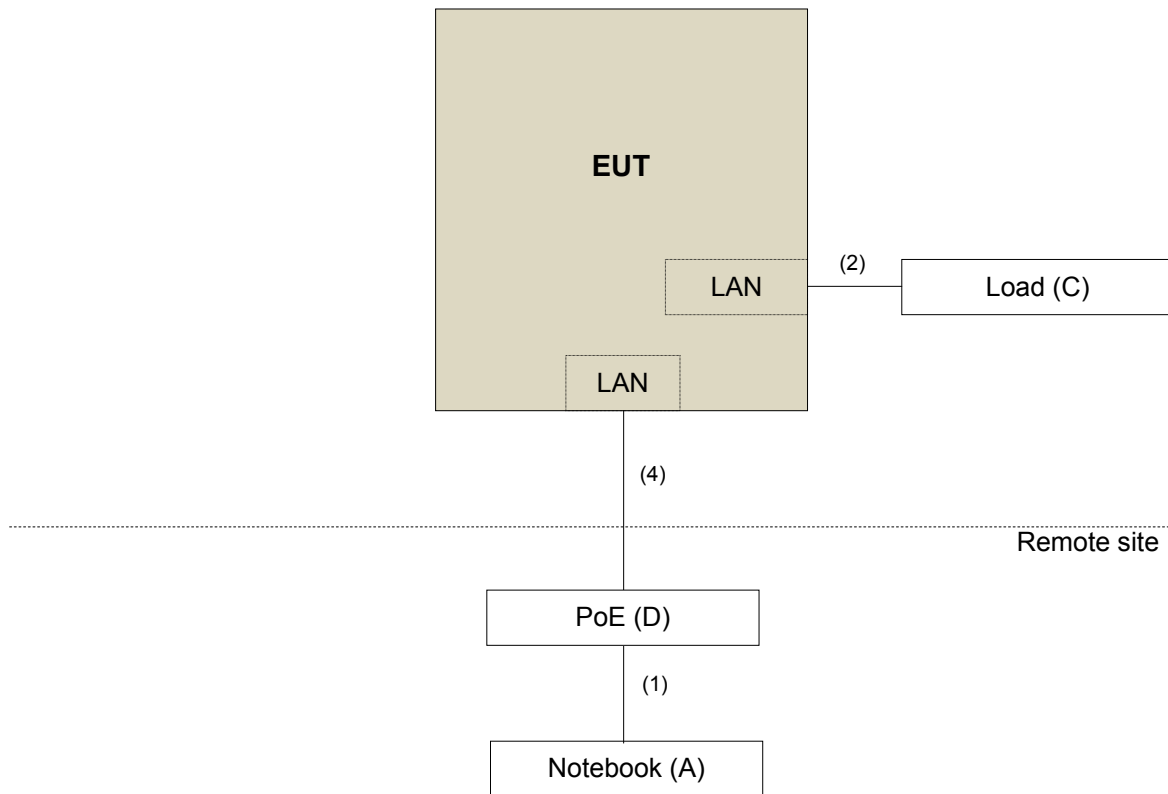

3.3 General Description of Applied Standards

The EUT is a RF Product. According to the specifications of the manufacturer, it must comply with the requirements of the following standards:

FCC Part 15, Subpart C (15.247)

KDB 558074 D01 DTS Meas Guidance v04

ANSI C63.10-2013

All test items have been performed and recorded as per the above standards.

4 Test Types and Results

4.1 Radiated Emission and Bandedge Measurement

4.1.1 Limits of Radiated Emission and Bandedge Measurement

Radiated emissions which fall in the restricted bands must comply with the radiated emission limits specified as below table. Other emissions shall be at least 20dB below the highest level of the desired power:

Frequencies (MHz)	Field Strength (microvolts/meter)	Measurement Distance (meters)
0.009 ~ 0.490	2400/F(kHz)	300
0.490 ~ 1.705	24000/F(kHz)	30
1.705 ~ 30.0	30	30
30 ~ 88	100	3
88 ~ 216	150	3
216 ~ 960	200	3
Above 960	500	3

Note:

1. The lower limit shall apply at the transition frequencies.
2. Emission level (dBuV/m) = 20 log Emission level (uV/m).
3. For frequencies above 1000MHz, the field strength limits are based on average detector, however, the peak field strength of any emission shall not exceed the maximum permitted average limits, specified above by more than 20dB under any condition of modulation.

4.1.2 Test Instruments

Description & Manufacturer	Model No.	Serial No.	Date Of Calibration	Due Date Of Calibration
Test Receiver ROHDE & SCHWARZ	ESIB7	100187	May 02, 2017	May 01, 2018
Spectrum Analyzer ROHDE & SCHWARZ	FSP40	100041	Dec. 12, 2017	Dec. 11, 2018
BILOG Antenna SCHWARZBECK	VULB9168	9168-171	Dec. 11, 2017	Dec. 10, 2018
HORN Antenna SCHWARZBECK	9120D	209	Dec. 13, 2017	Dec. 12, 2018
HORN Antenna SCHWARZBECK	BBHA 9170	BBHA9170241	Dec. 01, 2017	Nov. 30, 2018
Loop Antenna EMCI	EM-6879	269	Aug. 11, 2017	Aug. 10, 2018
Preamplifier Agilent (Below 1GHz)	8447D	2944A10738	Aug. 21, 2017	Aug. 20, 2018
Preamplifier Agilent (Above 1GHz)	8449B	3008A02465	Apr. 05, 2017	Apr. 04, 2018
RF signal cable HUBER+SUHNER	SUCOFLEX 104	Cable-CH3-03 (223653/4)	Aug. 21, 2017	Aug. 20, 2018
RF signal cable HUBER+SUHNER& EMCI	SUCOFLEX 104&EMC104-SM- SM-8000	Cable-CH3-03 (309224+170907)	Sep.11, 2017	Sep. 10, 2018
Software BV ADT	ADT_Radiated_ V7.6.15.9.4	NA	NA	NA
Antenna Tower inn-co GmbH	MA 4000	013303	NA	NA
Antenna Tower Controller BV ADT	AT100	AT93021702	NA	NA
Turn Table BV ADT	TT100	TT93021702	NA	NA
Turn Table Controller BV ADT	SC100	SC93021702	NA	NA
Boresight Antenna Fixture	FBA-01	FBA-SIP01	NA	NA
High Speed Peak Power Meter	ML2495A	0824012	Aug. 18, 2017	Aug. 17, 2018
Power Sensor	MA2411B	0738171	Aug. 18, 2017	Aug. 17, 2018

- Note: 1. The calibration interval of the above test instruments is 12 months and the calibrations are traceable to NML/ROC and NIST/USA.
2. The test was performed in HwaYa Chamber 3.
3. The horn antenna and preamplifier (model: 8449B) are used only for the measurement of emission frequency above 1GHz if tested.
4. The FCC Designation Number is TW0003. The number will be varied with the Lab location and scope as attached.
5. The IC Site Registration No. is IC 7450F-3.

4.1.3 Test Procedures

- a. The EUT was placed on the top of a rotating table 0.8 meters above the ground at 3 meter chamber room for test. The table was rotated 360 degrees to determine the position of the highest radiation.
- b. The EUT was set 3 meters away from the interference-receiving antenna, which was mounted on the top of a variable-height antenna tower.
- c. The height of antenna is varied from one meter to four meters above the ground to determine the maximum value of the field strength. Both horizontal and vertical polarizations of the antenna are set to make the measurement.
- d. For each suspected emission, the EUT was arranged to its worst case and then the antenna was tuned to heights from 1 meter to 4 meters and the rotatable table was turned from 0 degrees to 360 degrees to find the maximum reading.
- e. The test-receiver system was set to quasi-peak detect function and specified bandwidth with maximum hold mode when the test frequency is below 1 GHz.
- f. The test-receiver system was set to peak and average detect function and specified bandwidth with maximum hold mode when the test frequency is above 1 GHz. If the peak reading value also meets average limit, measurement with the average detector is unnecessary.

Note:

1. For emission measurements above 1 GHz, the EUT shall be placed at a height of 1.5 m above the ground at 3 meter chamber room for test.
2. The resolution bandwidth and video bandwidth of test receiver/spectrum analyzer is 120kHz for Quasi-peak detection (QP) at frequency below 1GHz.
3. The resolution bandwidth of test receiver/spectrum analyzer is 1 MHz and the video bandwidth is 3 MHz for Peak detection (PK) at frequency above 1GHz.
4. The resolution bandwidth of test receiver/spectrum analyzer is 1MHz and the video bandwidth is 3MHz for RMS Average (Duty cycle < 98%) for Average detection (AV) at frequency above 1GHz, then the measurement results was added to a correction factor ($10 \log(1/\text{duty cycle})$).
5. The resolution bandwidth of test receiver/spectrum analyzer is 1MHz and the video bandwidth is 10Hz (Duty cycle \geq 98%) for Average detection (AV) at frequency above 1GHz.
6. All modes of operation were investigated and the worst-case emissions are reported.

4.1.4 Deviation from Test Standard

No deviation.

4.1.5 Test Set Up

<Frequency Range below 1GHz>

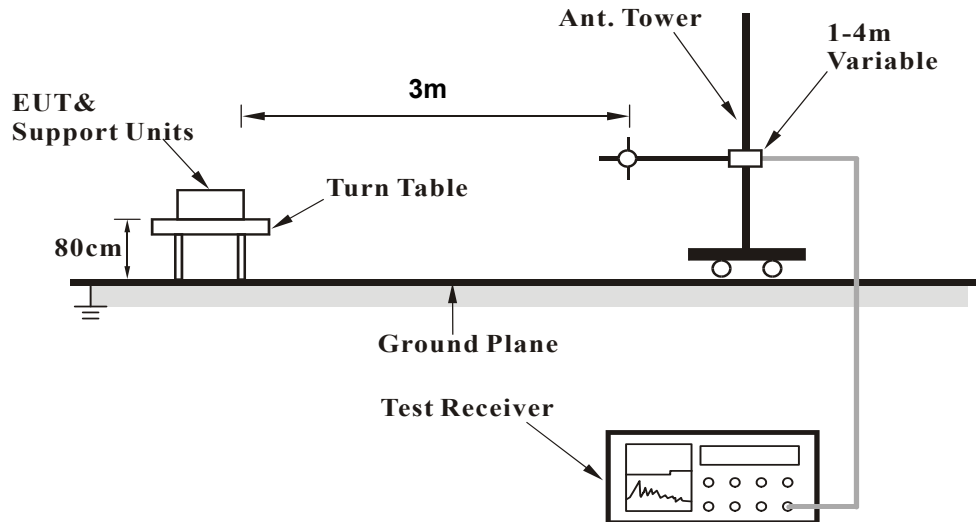

<Frequency Range above 1GHz>

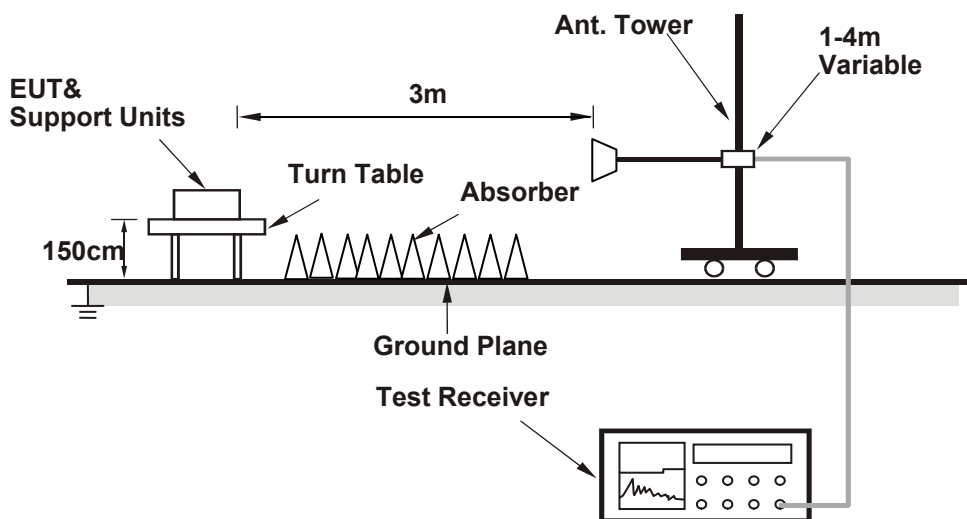

For the actual test configuration, please refer to the attached file (Test Setup Photo).

4.1.6 EUT Operating Conditions

- Placed the EUT on the testing table.
- Prepared a notebook to act as a communication partner and placed it outside of testing area.
- The communication partner connected with EUT via a RJ45 cable and ran a test program (provided by manufacturer) to enable EUT under transmission condition continuously at specific channel frequency.
- The communication partner sent data to EUT by command "PING".

4.1.7 Test Results

Above 1GHz Data

CHANNEL	TX Channel 11	DETECTOR FUNCTION	Peak (PK)
FREQUENCY RANGE	1GHz ~ 25GHz		Average (AV)

ANTENNA POLARITY & TEST DISTANCE: HORIZONTAL AT 3 M

NO.	FREQ. (MHz)	EMISSION LEVEL (dBuV/m)	LIMIT (dBuV/m)	MARGIN (dB)	ANTENNA HEIGHT (m)	TABLE ANGLE (Degree)	RAW VALUE (dBuV)	CORRECTION FACTOR (dB/m)
1	2390.00	58.5 PK	74.0	-15.5	2.07 H	343	25.0	33.5
2	2390.00	46.5 AV	54.0	-7.5	2.07 H	343	13.0	33.5
3	*2405.00	99.0 PK			1.87 H	317	65.6	33.4
4	*2405.00	95.2 AV			1.87 H	317	61.8	33.4
5	4810.00	46.2 PK	74.0	-27.8	1.77 H	287	42.6	3.6
6	4810.00	34.7 AV	54.0	-19.3	1.77 H	287	31.1	3.6

ANTENNA POLARITY & TEST DISTANCE: VERTICAL AT 3 M

NO.	FREQ. (MHz)	EMISSION LEVEL (dBuV/m)	LIMIT (dBuV/m)	MARGIN (dB)	ANTENNA HEIGHT (m)	TABLE ANGLE (Degree)	RAW VALUE (dBuV)	CORRECTION FACTOR (dB/m)
1	2390.00	58.1 PK	74.0	-15.9	2.08 V	343	24.6	33.5
2	2390.00	46.4 AV	54.0	-7.6	2.08 V	343	12.9	33.5
3	*2405.00	90.8 PK			2.28 V	351	57.4	33.4
4	*2405.00	86.9 AV			2.28 V	351	53.5	33.4
5	4810.00	48.0 PK	74.0	-26.0	2.39 V	10	44.4	3.6
6	4810.00	37.0 AV	54.0	-17.0	2.39 V	10	33.4	3.6

Remarks:

1. Emission Level(dBuV/m) = Raw Value(dBuV) + Correction Factor(dB/m)
2. Correction Factor(dB/m) = Antenna Factor(dB/m) + Cable Factor(dB)
3. The other emission levels were very low against the limit.
4. Margin value = Emission Level – Limit value
5. " * ": Fundamental frequency.

CHANNEL	TX Channel 18	DETECTOR	Peak (PK)
FREQUENCY RANGE	1GHz ~ 25GHz	FUNCTION	Average (AV)

ANTENNA POLARITY & TEST DISTANCE: HORIZONTAL AT 3 M

NO.	FREQ. (MHz)	EMISSION LEVEL (dBuV/m)	LIMIT (dBuV/m)	MARGIN (dB)	ANTENNA HEIGHT (m)	TABLE ANGLE (Degree)	RAW VALUE (dBuV)	CORRECTION FACTOR (dB/m)
1	*2440.00	97.7 PK			1.79 H	315	64.3	33.4
2	*2440.00	93.9 AV			1.79 H	315	60.5	33.4
3	4880.00	47.1 PK	74.0	-26.9	2.05 H	110	43.6	3.5
4	4880.00	35.3 AV	54.0	-18.7	2.05 H	110	31.8	3.5

ANTENNA POLARITY & TEST DISTANCE: VERTICAL AT 3 M

NO.	FREQ. (MHz)	EMISSION LEVEL (dBuV/m)	LIMIT (dBuV/m)	MARGIN (dB)	ANTENNA HEIGHT (m)	TABLE ANGLE (Degree)	RAW VALUE (dBuV)	CORRECTION FACTOR (dB/m)
1	*2440.00	91.6 PK			3.22 V	322	58.2	33.4
2	*2440.00	87.9 AV			3.22 V	322	54.5	33.4
3	4880.00	48.2 PK	74.0	-25.8	2.49 V	7	44.7	3.5
4	4880.00	37.2 AV	54.0	-16.8	2.49 V	7	33.7	3.5

Remarks:

1. Emission Level(dBuV/m) = Raw Value(dBuV) + Correction Factor(dB/m)
2. Correction Factor(dB/m) = Antenna Factor(dB/m) + Cable Factor(dB)
3. The other emission levels were very low against the limit.
4. Margin value = Emission Level – Limit value
5. " * ": Fundamental frequency.

CHANNEL	TX Channel 26	DETECTOR FUNCTION	Peak (PK)
FREQUENCY RANGE	1GHz ~ 25GHz		Average (AV)

ANTENNA POLARITY & TEST DISTANCE: HORIZONTAL AT 3 M

NO.	FREQ. (MHz)	EMISSION LEVEL (dBuV/m)	LIMIT (dBuV/m)	MARGIN (dB)	ANTENNA HEIGHT (m)	TABLE ANGLE (Degree)	RAW VALUE (dBuV)	CORRECTION FACTOR (dB/m)
1	*2480.00	95.2 PK			2.09 H	311	62.0	33.2
2	*2480.00	91.7 AV			2.09 H	311	58.5	33.2
3	2483.50	62.9 PK	74.0	-11.1	2.07 H	308	29.7	33.2
4	2483.50	52.4 AV	54.0	-1.6	2.07 H	308	19.2	33.2
5	4960.00	47.5 PK	74.0	-26.5	1.84 H	179	44.0	3.5
6	4960.00	35.7 AV	54.0	-18.3	1.84 H	179	32.2	3.5

ANTENNA POLARITY & TEST DISTANCE: VERTICAL AT 3 M

NO.	FREQ. (MHz)	EMISSION LEVEL (dBuV/m)	LIMIT (dBuV/m)	MARGIN (dB)	ANTENNA HEIGHT (m)	TABLE ANGLE (Degree)	RAW VALUE (dBuV)	CORRECTION FACTOR (dB/m)
1	*2480.00	88.3 PK			2.94 V	311	55.1	33.2
2	*2480.00	84.5 AV			2.94 V	311	51.3	33.2
3	2483.50	59.0 PK	74.0	-15.0	3.03 V	315	25.8	33.2
4	2483.50	48.3 AV	54.0	-5.7	3.03 V	315	15.1	33.2
5	4960.00	48.9 PK	74.0	-25.1	2.87 V	1	45.4	3.5
6	4960.00	38.6 AV	54.0	-15.4	2.87 V	1	35.1	3.5

Remarks:

1. Emission Level(dBuV/m) = Raw Value(dBuV) + Correction Factor(dB/m)
2. Correction Factor(dB/m) = Antenna Factor(dB/m) + Cable Factor(dB)
3. The other emission levels were very low against the limit.
4. Margin value = Emission Level – Limit value
5. " * ": Fundamental frequency.

Below 1GHz worst-case data

CHANNEL	TX Channel 11	DETECTOR FUNCTION	Quasi-Peak (QP)
FREQUENCY RANGE	30MHz ~ 1GHz	TEST MODE	A

ANTENNA POLARITY & TEST DISTANCE: HORIZONTAL AT 3 M								
NO.	FREQ. (MHz)	EMISSION LEVEL (dBuV/m)	LIMIT (dBuV/m)	MARGIN (dB)	ANTENNA HEIGHT (m)	TABLE ANGLE (Degree)	RAW VALUE (dBuV)	CORRECTION FACTOR (dB/m)
1	57.12	24.1 QP	40.0	-15.9	1.99 H	239	38.5	-14.4
2	169.89	25.0 QP	43.5	-18.5	1.00 H	277	39.1	-14.1
3	317.65	28.4 QP	46.0	-17.6	1.50 H	117	40.7	-12.3
4	547.08	27.0 QP	46.0	-19.0	1.00 H	173	35.7	-8.7
5	640.41	27.3 QP	46.0	-18.7	1.99 H	9	33.9	-6.6
6	932.05	31.6 QP	46.0	-14.4	1.00 H	5	33.6	-2.0
ANTENNA POLARITY & TEST DISTANCE: VERTICAL AT 3 M								
NO.	FREQ. (MHz)	EMISSION LEVEL (dBuV/m)	LIMIT (dBuV/m)	MARGIN (dB)	ANTENNA HEIGHT (m)	TABLE ANGLE (Degree)	RAW VALUE (dBuV)	CORRECTION FACTOR (dB/m)
1	51.29	34.5 QP	40.0	-5.5	1.00 V	343	48.6	-14.1
2	162.11	30.8 QP	43.5	-12.7	1.00 V	207	44.7	-13.9
3	337.10	29.1 QP	46.0	-16.9	1.50 V	154	41.2	-12.1
4	547.08	30.4 QP	46.0	-15.6	1.00 V	182	39.1	-8.7
5	722.07	31.4 QP	46.0	-14.6	1.00 V	7	36.9	-5.5
6	932.05	31.4 QP	46.0	-14.6	1.00 V	90	33.4	-2.0

Remarks:

1. Emission Level(dBuV/m) = Raw Value(dBuV) + Correction Factor(dB/m)
2. Correction Factor(dB/m) = Antenna Factor(dB/m) + Cable Factor(dB) – Pre-Amplifier Factor(dB)
3. The other emission levels were very low against the limit of frequency range 30MHz ~ 1000MHz.
4. Margin value = Emission Level – Limit value
5. The emission levels were very low against the limit of frequency range 9kHz ~ 30MHz.

CHANNEL	TX Channel 11	DETECTOR FUNCTION	Quasi-Peak (QP)
FREQUENCY RANGE	30MHz ~ 1GHz	TEST MODE	B

ANTENNA POLARITY & TEST DISTANCE: HORIZONTAL AT 3 M

NO.	FREQ. (MHz)	EMISSION LEVEL (dBuV/m)	LIMIT (dBuV/m)	MARGIN (dB)	ANTENNA HEIGHT (m)	TABLE ANGLE (Degree)	RAW VALUE (dBuV)	CORRECTION FACTOR (dB/m)
1	37.68	26.0 QP	40.0	-14.0	1.00 H	51	41.3	-15.3
2	189.33	26.8 QP	43.5	-16.7	1.00 H	235	43.0	-16.2
3	313.77	27.2 QP	46.0	-18.8	1.50 H	147	39.6	-12.4
4	385.70	23.0 QP	46.0	-23.0	1.00 H	283	34.4	-11.4
5	572.36	26.3 QP	46.0	-19.7	1.99 H	288	34.5	-8.2
6	937.88	31.0 QP	46.0	-15.0	1.00 H	110	33.0	-2.0

ANTENNA POLARITY & TEST DISTANCE: VERTICAL AT 3 M

NO.	FREQ. (MHz)	EMISSION LEVEL (dBuV/m)	LIMIT (dBuV/m)	MARGIN (dB)	ANTENNA HEIGHT (m)	TABLE ANGLE (Degree)	RAW VALUE (dBuV)	CORRECTION FACTOR (dB/m)
1	37.68	34.6 QP	40.0	-5.4	1.00 V	155	49.9	-15.3
2	189.33	26.9 QP	43.5	-16.6	1.00 V	213	43.1	-16.2
3	255.44	25.2 QP	46.0	-20.8	1.00 V	307	39.6	-14.4
4	323.49	26.6 QP	46.0	-19.4	1.50 V	196	38.8	-12.2
5	556.80	30.7 QP	46.0	-15.3	1.00 V	61	39.2	-8.5
6	935.94	31.7 QP	46.0	-14.3	1.50 V	275	33.8	-2.1

Remarks:

1. Emission Level(dBuV/m) = Raw Value(dBuV) + Correction Factor(dB/m)
2. Correction Factor(dB/m) = Antenna Factor(dB/m) + Cable Factor(dB) – Pre-Amplifier Factor(dB)
3. The other emission levels were very low against the limit of frequency range 30MHz ~ 1000MHz.
4. Margin value = Emission Level – Limit value
5. The emission levels were very low against the limit of frequency range 9kHz ~ 30MHz.

4.2 Conducted Emission Measurement

4.2.1 Limits of Conducted Emission Measurement

Frequency (MHz)	Conducted Limit (dBuV)	
	Quasi-peak	Average
0.15 - 0.5	66 - 56	56 - 46
0.50 - 5.0	56	46
5.0 - 30.0	60	50

- Note:** 1. The lower limit shall apply at the transition frequencies.
 2. The limit decreases in line with the logarithm of the frequency in the range of 0.15 to 0.50MHz.

4.2.2 Test Instruments

Tested date: Mar. 08, 2018

Description & Manufacturer	Model No.	Serial No.	Date Of Calibration	Due Date Of Calibration
Test Receiver ROHDE & SCHWARZ	ESCS 30	100288	Aug. 17, 2017	Aug. 16, 2018
RF signal cable (with 10dB PAD) Woken	5D-FB	Cable-cond2-01	Sep. 08, 2017	Sep. 07, 2018
LISN ROHDE & SCHWARZ (EUT)	ESH3-Z5	835239/001	Mar. 10, 2017	Mar. 09, 2018
LISN ROHDE & SCHWARZ (Peripheral)	ESH3-Z5	100312	Aug. 02, 2017	Aug. 01, 2018
Software ADT	BV ADT_Cond_ V7.3.7.3	NA	NA	NA

- Note:** 1. The calibration interval of the above test instruments is 12 months and the calibrations are traceable to NML/ROC and NIST/USA.
 2. The test was performed in HwaYa Shielded Room 2.
 3. The VCCI Site Registration No. is C-2047.

4.2.3 Test Procedures

- The EUT was placed 0.4 meters from the conducting wall of the shielded room with EUT being connected to the power mains through a line impedance stabilization network (LISN). Other support units were connected to the power mains through another LISN. The two LISNs provide 50 ohm/ 50uH of coupling impedance for the measuring instrument.
- Both lines of the power mains connected to the EUT were checked for maximum conducted interference.
- The frequency range from 150kHz to 30MHz was searched. Emission levels under (Limit - 20dB) was not recorded.

Note: The resolution bandwidth and video bandwidth of test receiver is 9kHz for quasi-peak detection (QP) and average detection (AV) at frequency 0.15MHz-30MHz.

4.2.4 Deviation from Test Standard

No deviation.

4.2.5 Test Setup

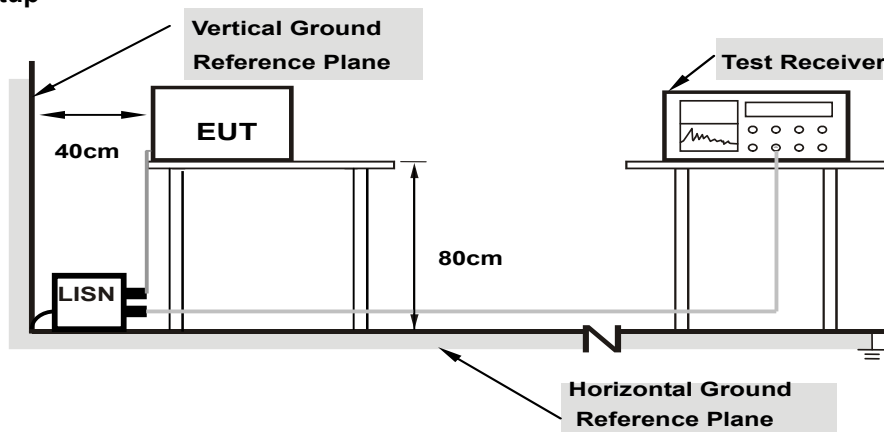

Note: 1.Support units were connected to second LISN.

For the actual test configuration, please refer to the attached file (Test Setup Photo).

4.2.6 EUT Operating Conditions

Same as 4.1.6.

4.2.7 Test Results

Phase	Line (L)	Detector Function	Quasi-Peak (QP) / Average (AV)
Test Mode	A		

No	Freq. [MHz]	Corr. Factor (dB)	Reading Value		Emission Level		Limit		Margin	
			[dB (uV)]		[dB (uV)]		[dB (uV)]		(dB)	
			Q.P.	AV.	Q.P.	AV.	Q.P.	AV.	Q.P.	AV.
1	0.16562	10.30	49.03	27.93	59.33	38.23	65.18	55.18	-5.85	-16.95
2	0.23203	10.33	39.25	21.21	49.58	31.54	62.38	52.38	-12.80	-20.84
3	0.52500	10.35	26.98	20.25	37.33	30.60	56.00	46.00	-18.67	-15.40
4	3.75781	10.54	19.89	12.67	30.43	23.21	56.00	46.00	-25.57	-22.79
5	10.55859	10.88	28.26	23.19	39.14	34.07	60.00	50.00	-20.86	-15.93
6	23.59766	11.67	21.92	16.95	33.59	28.62	60.00	50.00	-26.41	-21.38

Remarks:

1. Q.P. and AV. are abbreviations of quasi-peak and average individually.
2. The emission levels of other frequencies were very low against the limit.
3. Margin value = Emission level - Limit value
4. Correction factor = Insertion loss + Cable loss
5. Emission Level = Correction Factor + Reading Value.

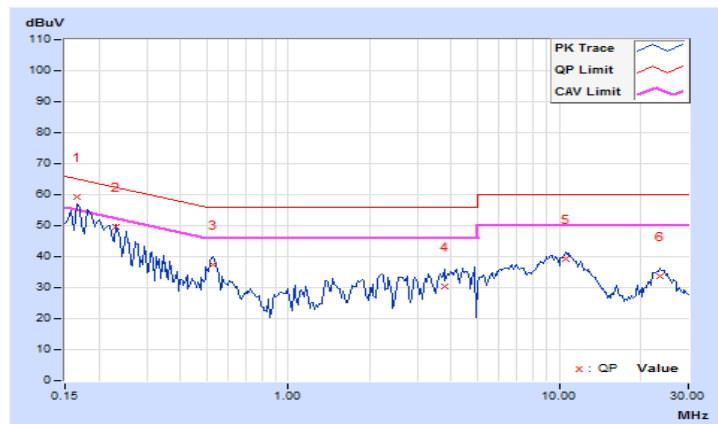

Phase	Neutral (N)	Detector Function	Quasi-Peak (QP) / Average (AV)
Test Mode	A		

No	Freq. [MHz]	Corr. Factor (dB)	Reading Value [dB (uV)]		Emission Level [dB (uV)]		Limit [dB (uV)]		Margin (dB)	
			Q.P.	AV.	Q.P.	AV.	Q.P.	AV.	Q.P.	AV.
			1	0.15781	10.33	51.31	34.97	61.64	45.30	65.58
2	0.20469	10.29	43.15	26.81	53.44	37.10	63.42	53.42	-9.98	-16.32
3	0.28281	10.30	32.73	16.76	43.03	27.06	60.73	50.73	-17.70	-23.67
4	1.73438	10.44	21.35	17.09	31.79	27.53	56.00	46.00	-24.21	-18.47
5	9.54688	10.77	21.97	15.01	32.74	25.78	60.00	50.00	-27.26	-24.22
6	24.32813	11.37	13.31	8.69	24.68	20.06	60.00	50.00	-35.32	-29.94

Remarks:

1. Q.P. and AV. are abbreviations of quasi-peak and average individually.
2. The emission levels of other frequencies were very low against the limit.
3. Margin value = Emission level - Limit value
4. Correction factor = Insertion loss + Cable loss
5. Emission Level = Correction Factor + Reading Value.

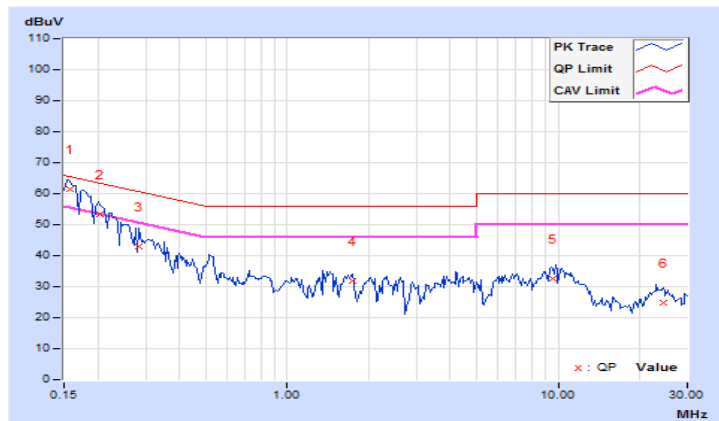

Phase	Line (L)	Detector Function	Quasi-Peak (QP) / Average (AV)
Test Mode	B		

No	Freq. [MHz]	Corr. Factor (dB)	Reading Value [dB (uV)]		Emission Level [dB (uV)]		Limit [dB (uV)]		Margin (dB)	
			Q.P.	AV.	Q.P.	AV.	Q.P.	AV.	Q.P.	AV.
			1	0.17734	10.31	35.50	18.68	45.81	28.99	64.61
2	0.49375	10.35	31.10	25.57	41.45	35.92	56.10	46.10	-14.65	-10.18
3	0.98984	10.40	20.53	16.60	30.93	27.00	56.00	46.00	-25.07	-19.00
4	5.19531	10.61	24.63	19.63	35.24	30.24	60.00	50.00	-24.76	-19.76
5	10.16797	10.86	31.57	26.84	42.43	37.70	60.00	50.00	-17.57	-12.30
6	16.90625	11.30	23.24	18.64	34.54	29.94	60.00	50.00	-25.46	-20.06

Remarks:

1. Q.P. and AV. are abbreviations of quasi-peak and average individually.
2. The emission levels of other frequencies were very low against the limit.
3. Margin value = Emission level - Limit value
4. Correction factor = Insertion loss + Cable loss
5. Emission Level = Correction Factor + Reading Value.

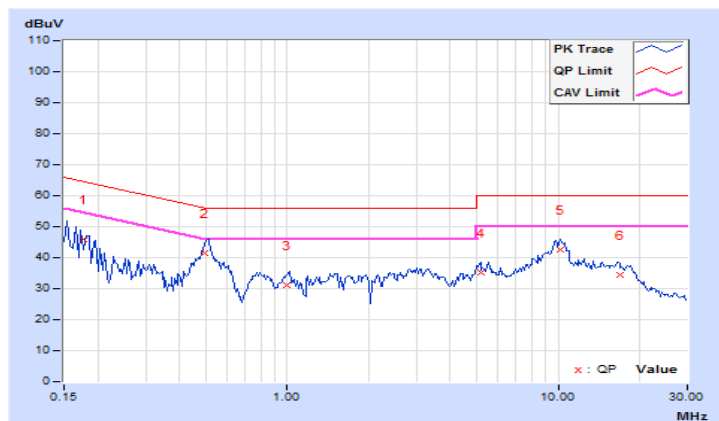

Phase	Neutral (N)	Detector Function	Quasi-Peak (QP) / Average (AV)
Test Mode	B		

No	Freq. [MHz]	Corr. Factor (dB)	Reading Value [dB (uV)]		Emission Level [dB (uV)]		Limit [dB (uV)]		Margin (dB)	
			Q.P.	AV.	Q.P.	AV.	Q.P.	AV.	Q.P.	AV.
			1	0.16562	10.33	37.02	18.73	47.35	29.06	65.18
2	0.25547	10.30	25.44	14.99	35.74	25.29	61.58	51.58	-25.84	-26.29
3	0.51328	10.32	33.89	29.27	44.21	39.59	56.00	46.00	-11.79	-6.41
4	1.68359	10.44	17.17	12.75	27.61	23.19	56.00	46.00	-28.39	-22.81
5	3.22656	10.52	19.95	14.65	30.47	25.17	56.00	46.00	-25.53	-20.83
6	10.11328	10.79	30.00	25.26	40.79	36.05	60.00	50.00	-19.21	-13.95

Remarks:

1. Q.P. and AV. are abbreviations of quasi-peak and average individually.
2. The emission levels of other frequencies were very low against the limit.
3. Margin value = Emission level - Limit value
4. Correction factor = Insertion loss + Cable loss
5. Emission Level = Correction Factor + Reading Value.

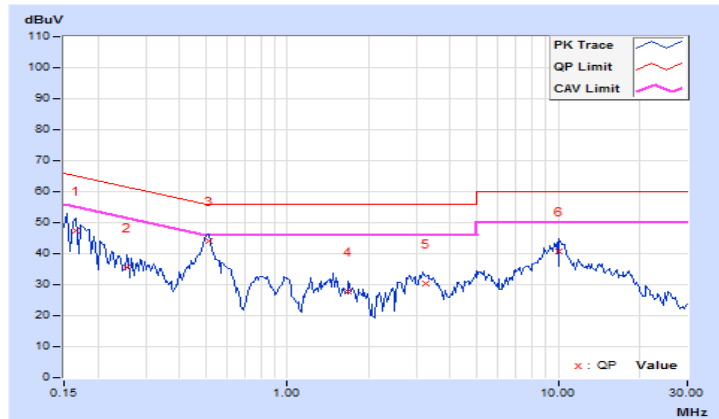

4.3 6dB Bandwidth Measurement

4.3.1 Limits of 6dB Bandwidth Measurement

The minimum of 6dB Bandwidth Measurement is 0.5 MHz.

4.3.2 Test Setup

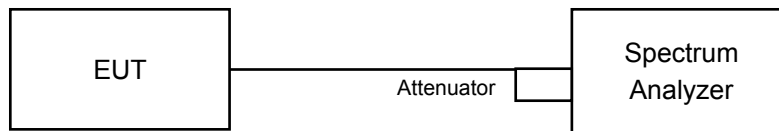

4.3.3 Test Instruments

Refer to section 4.1.2 to get information of above instrument.

4.3.4 Test Procedure

- Set resolution bandwidth (RBW) = 100kHz
- Set the video bandwidth (VBW) $\geq 3 \times$ RBW, Detector = Peak.
- Trace mode = max hold.
- Sweep = auto couple.
- Measure the maximum width of the emission that is constrained by the frequencies associated with the two amplitude points (upper and lower) that are attenuated by 6 dB relative to the maximum level measured in the fundamental emission

4.3.5 Deviation from Test Standard

No deviation.

4.3.6 EUT Operating Conditions

The software provided by client to enable the EUT under transmission condition continuously at lowest, middle and highest channel frequencies individually.

4.3.7 Test Result

Channel	Frequency (MHz)	6dB Bandwidth (MHz)	Minimum Limit (MHz)	Pass / Fail
11	2405	1.61	0.5	Pass
18	2440	1.60	0.5	Pass
26	2480	1.63	0.5	Pass

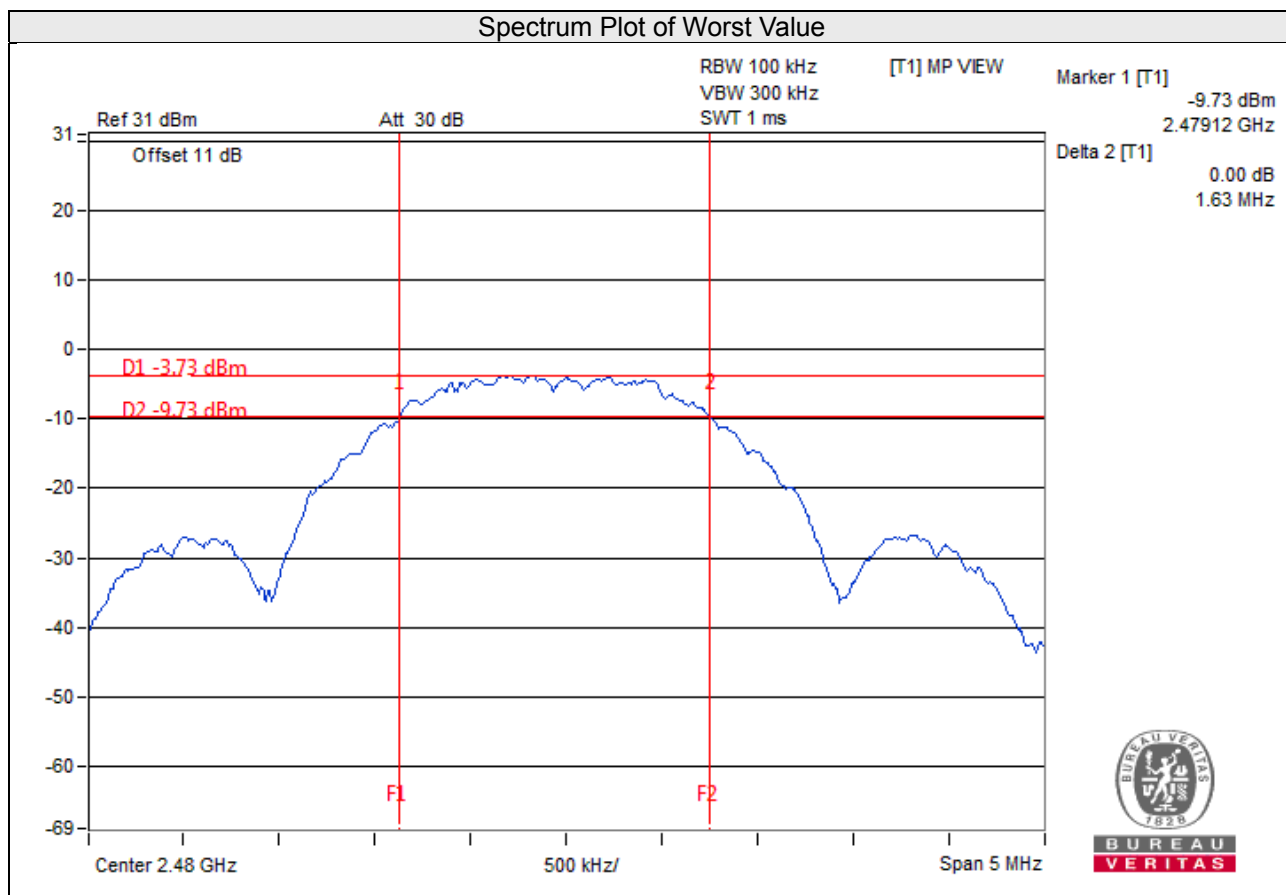

4.4 Conducted Output Power Measurement

4.4.1 Limits of Conducted Output Power Measurement

For systems using digital modulation in the 2400–2483.5 MHz bands: 1 Watt (30dBm)

4.4.2 Test Setup

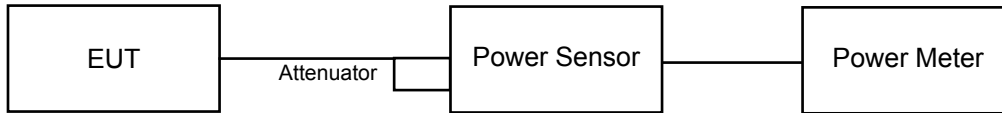

4.4.3 Test Instruments

Refer to section 4.1.2 to get information of above instrument.

4.4.4 Test Procedures

A peak power sensor was used on the output port of the EUT. A power meter was used to read the response of the peak power sensor. Record the power level.

4.4.5 Deviation from Test Standard

No deviation.

4.4.6 EUT Operating Conditions

Same as Item 4.3.6.

4.4.7 Test Results

Channel	Frequency (MHz)	Peak Power (mW)	Peak Power (dBm)	Limit (dBm)	Pass/Fail
11	2405	1.714	2.34	30	Pass
18	2440	1.722	2.36	30	Pass
26	2480	1.245	0.95	30	Pass

4.5 Power Spectral Density Measurement

4.5.1 Limits of Power Spectral Density Measurement

The Maximum of Power Spectral Density Measurement is 8dBm.

4.5.2 Test Setup

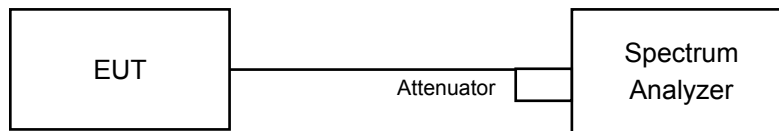

4.5.3 Test Instruments

Refer to section 4.1.2 to get information of above instrument.

4.5.4 Test Procedure

- Set analyzer center frequency to DTS channel center frequency.
- Set the span to 1.5 times the DTS bandwidth.
- Set the RBW to: $3 \text{ kHz} \leq \text{RBW} \leq 100 \text{ kHz}$.
- Set the VBW $\geq 3 \times \text{RBW}$.
- Detector = peak.
- Sweep time = auto couple.
- Trace mode = max hold.
- Allow trace to fully stabilize.
- Use the peak marker function to determine the maximum amplitude level within the RBW.

4.5.5 Deviation from Test Standard

No deviation.

4.5.6 EUT Operating Condition

Same as Item 4.3.6

4.5.7 Test Results

Channel	Frequency (MHz)	PSD w/o Duty Factor (dBm/3kHz)	Duty Factor (dB)	Total PSD With Duty Factor (dBm/3kHz)	Limit (dBm/3kHz)	Pass / Fail
11	2405	-12.87	0.54	-12.33	8.00	Pass
18	2440	-13.04	0.54	-12.50	8.00	Pass
26	2480	-14.70	0.54	-14.16	8.00	Pass

Spectrum Plot of Worst Value

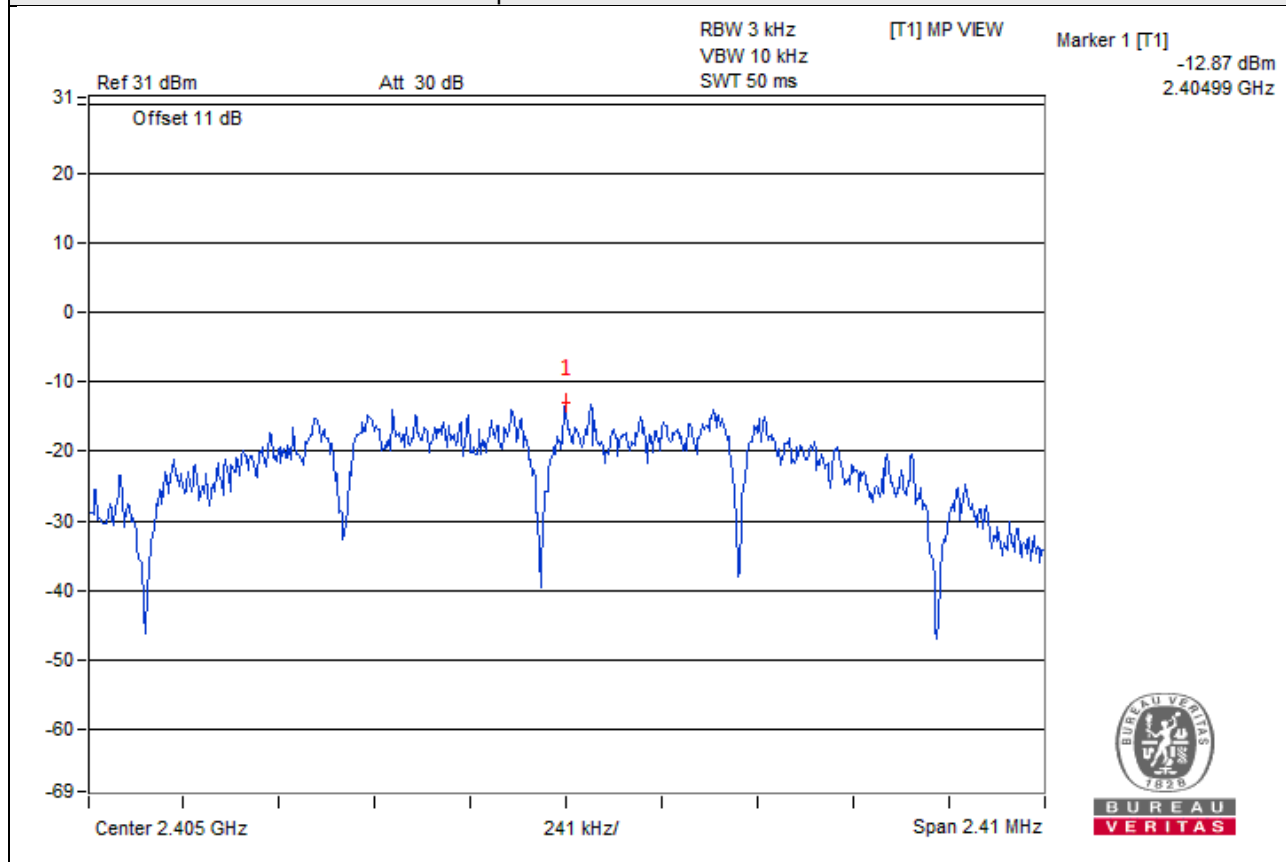

4.6 Conducted Out of Band Emission Measurement

4.6.1 Limits of Conducted Out of Band Emission Measurement

Below 20dB of the highest emission level of operating band (in 100kHz Resolution Bandwidth).

4.6.2 Test Setup

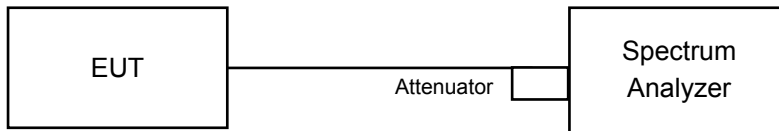

4.6.3 Test Instruments

Refer to section 4.1.2 to get information of above instrument.

4.6.4 Test Procedure

MEASUREMENT PROCEDURE REF

- Set the RBW = 100 kHz.
- Set the VBW \geq 300 kHz.
- Detector = peak.
- Sweep time = auto couple.
- Trace mode = max hold.
- Allow trace to fully stabilize.
- Use the peak marker function to determine the maximum power level in any 100 kHz band segment within the fundamental EBW.

MEASUREMENT PROCEDURE OOBE

- Set RBW = 100 kHz.
- Set VBW \geq 300 kHz.
- Detector = peak.
- Sweep = auto couple.
- Trace Mode = max hold.
- Allow trace to fully stabilize.
- Use the peak marker function to determine the maximum amplitude level.

4.6.5 Deviation from Test Standard

No deviation.

4.6.6 EUT Operating Condition

Same as Item 4.3.6

4.6.7 Test Results

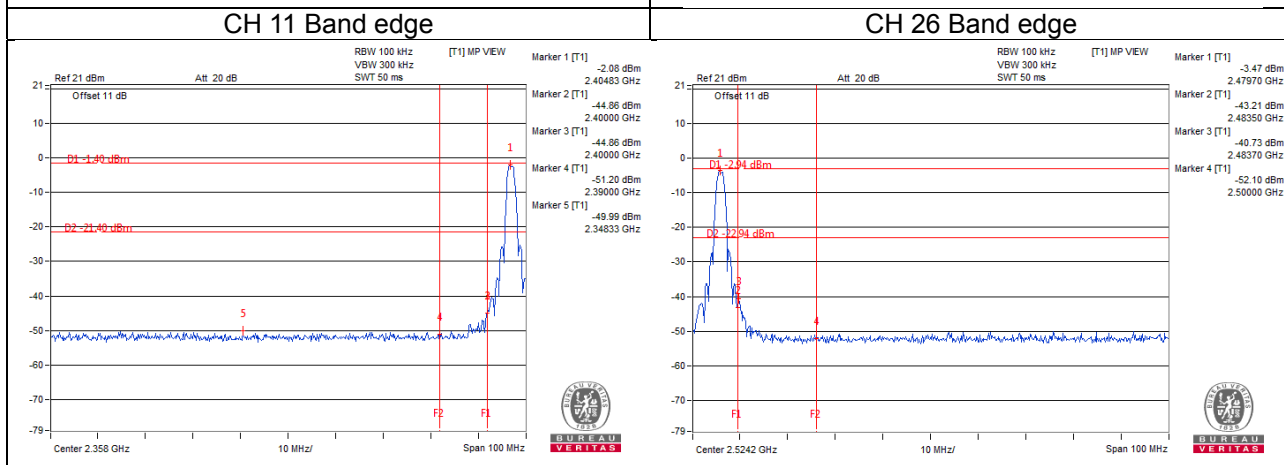
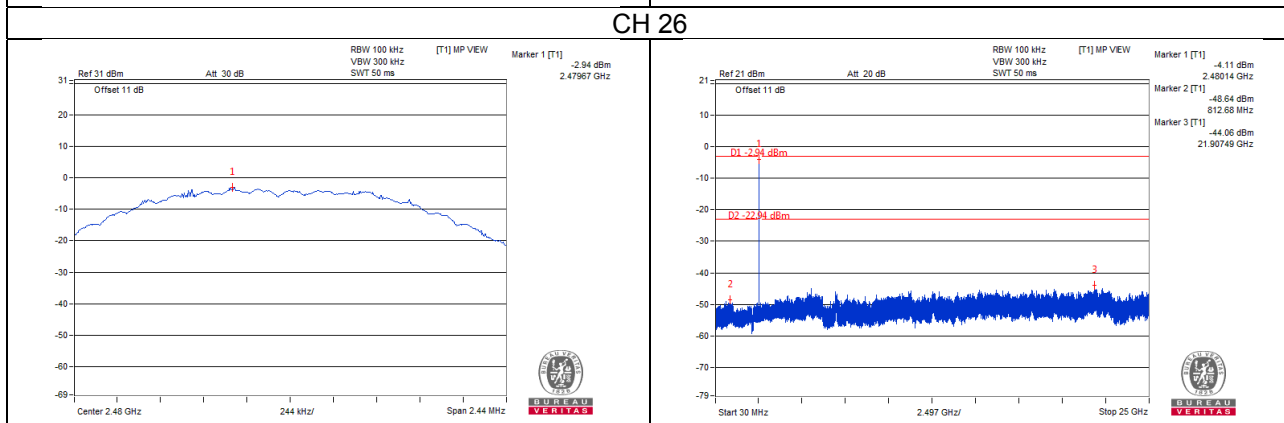
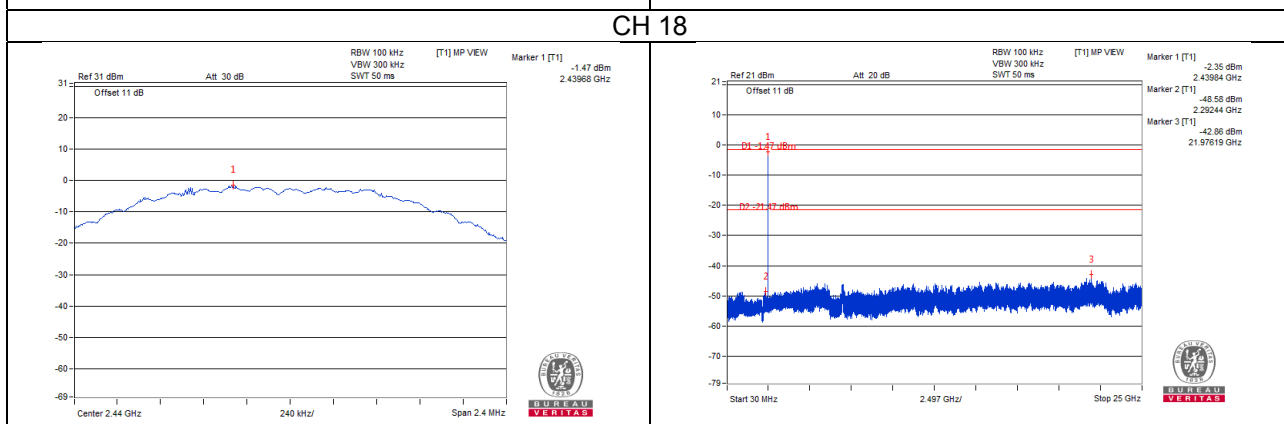
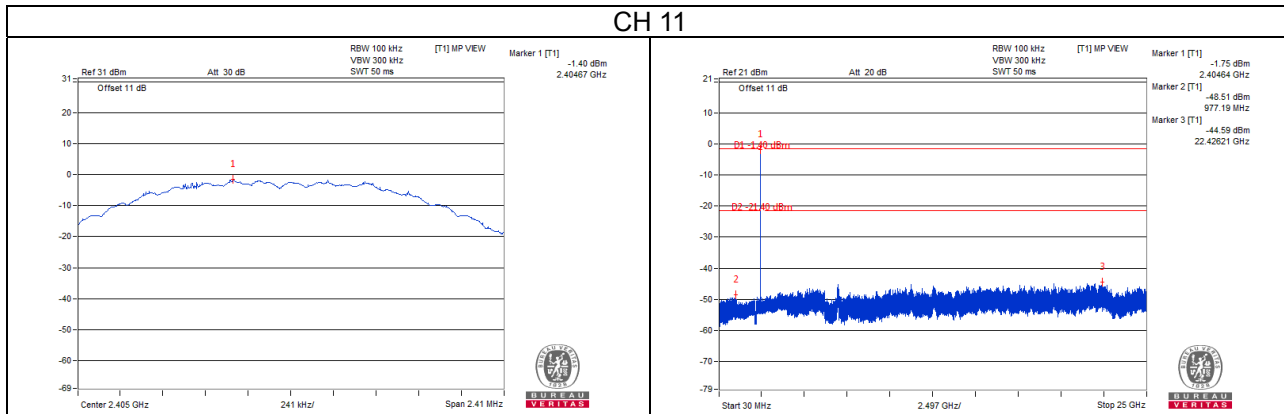

5 Pictures of Test Arrangements

Please refer to the attached file (Test Setup Photo).

Appendix – Information on the Testing Laboratories

We, Bureau Veritas Consumer Products Services (H.K.) Ltd., Taoyuan Branch, were founded in 1988 to provide our best service in EMC, Radio, Telecom and Safety consultation. Our laboratories are accredited and approved according to ISO/IEC 17025.

If you have any comments, please feel free to contact us at the following:

Linko EMC/RF Lab

Tel: 886-2-26052180

Fax: 886-2-26051924

Hsin Chu EMC/RF/Telecom Lab

Tel: 886-3-6668565

Fax: 886-3-6668323

Hwa Ya EMC/RF/Safety Lab

Tel: 886-3-3183232

Fax: 886-3-3270892

Email: service.adt@tw.bureauveritas.com

Web Site: www.bureauveritas-adt.com

The address and road map of all our labs can be found in our web site also.

--- END ---