

FCC Test Report (Co-Located)

Report No.: RF180108C15-4

FCC ID: TOR-W118

Test Model: W-118

Received Date: Jan. 08, 2018

Test Date: Mar. 22 ~ Mar. 27, 2018

Issued Date: Mar. 27, 2018

Applicant: Mojo Networks, Inc.

Address: 339 N. Bernardo Avenue, Suite #200, Mountain View, California United States 94043

Issued By: Bureau Veritas Consumer Products Services (H.K.) Ltd., Taoyuan Branch

Lab Address: No. 47-2, 14th Ling, Chia Pau Vil., Lin Kou Dist., New Taipei City, Taiwan, R.O.C.

Test Location: No. 19, Hwa Ya 2nd Rd., Wen Hwa Vil., Kwei Shan Dist., Taoyuan City 33383, TAIWAN (R.O.C.)

**FCC Registration /
Designation Number:** 788550 / TW0003



This report is for your exclusive use. Any copying or replication of this report to or for any other person or entity, or use of our name or trademark, is permitted only with our prior written permission. This report sets forth our findings solely with respect to the test samples identified herein. The results set forth in this report are not indicative or representative of the quality or characteristics of the lot from which a test sample was taken or any similar or identical product unless specifically and expressly noted. Our report includes all of the tests requested by you and the results thereof based upon the information that you provided to us. You have 60 days from date of issuance of this report to notify us of any material error or omission caused by our negligence, provided, however, that such notice shall be in writing and shall specifically address the issue you wish to raise. A failure to raise such issue within the prescribed time shall constitute your unqualified acceptance of the completeness of this report, the tests conducted and the correctness of the report contents. Unless specific mention, the uncertainty of measurement has been explicitly taken into account to declare the compliance or non-compliance to the specification. The report must not be used by the client to claim product certification, approval, or endorsement by TAF or any government agencies.

Table of Contents

Release Control Record	3
1 Certificate of Conformity	4
2 Summary of Test Results	5
2.1 Measurement Uncertainty.....	5
2.2 Modification Record.....	5
3 General Information	6
3.1 General Description of EUT.....	6
3.2 Description of Test Modes.....	9
3.2.1 Test Mode Applicability and Tested Channel Detail.....	11
3.3 Description of Support Units.....	13
3.3.1 Configuration of System under Test.....	13
3.4 General Description of Applied Standards.....	14
4 Test Types and Results	15
4.1 Radiated Emission and Bandedge Measurement.....	15
4.1.1 Limits of Radiated Emission and Bandedge Measurement.....	15
4.1.2 Test Instruments.....	16
4.1.3 Test Procedures.....	17
4.1.4 Deviation from Test Standard.....	17
4.1.5 Test Setup.....	18
4.1.6 EUT Operating Conditions.....	19
4.1.7 Test Results.....	20
5 Pictures of Test Arrangements	36
Annex A- Radiated Out of Band Emission (OOBE) Measurement (For U-NII-3 band)	37
Appendix – Information on the Testing Laboratories	44

Release Control Record

Issue No.	Description	Date Issued
RF180108C15-4	Original release.	Mar. 27, 2018

1 Certificate of Conformity

Product: Wall Jack Access Point

Brand: Mojo

Test Model: W-118

Sample Status: Engineering sample

Applicant: Mojo Networks, Inc.

Test Date: Mar. 22 ~ Mar. 27, 2018

Standards: 47 CFR FCC Part 15, Subpart C (Section 15.247)
47 CFR FCC Part 15, Subpart E (Section 15.407)
ANSI C63.10-2013

The above equipment has been tested by **Bureau Veritas Consumer Products Services (H.K.) Ltd., Taoyuan Branch**, and found compliance with the requirement of the above standards. The test record, data evaluation & Equipment Under Test (EUT) configurations represented herein are true and accurate accounts of the measurements of the sample's RF characteristics under the conditions specified in this report.

Prepared by :  _____, **Date:** _____ Mar. 27, 2018
Pettie Chen / Senior Specialist

Approved by :  _____, **Date:** _____ Mar. 27, 2018
Bruce Chen / Project Engineer

2 Summary of Test Results

Applied Standard:	47 CFR FCC Part 15, Subpart C (Section 15.247) 47 CFR FCC Part 15, Subpart E (Section 15.407)		
FCC Clause	Test Item	Result	Remarks
15.205 / 15.209 / 15.247(d) 15.407(b) (1/2/3/4(i/ii)/6)	Radiated Emissions	Pass	Meet the requirement of limit. Minimum passing margin is -0.2dB at 30.90MHz.

*For U-NII-3 band compliance with rule part 15.407(b)(4)(i), the OOB test plots were recorded in Annex A.

2.1 Measurement Uncertainty

Where relevant, the following measurement uncertainty levels have been estimated for tests performed on the EUT as specified in CISPR 16-4-2:

Measurement	Frequency	Expanded Uncertainty (k=2) (\pm)
Radiated Emissions up to 1 GHz	30MHz ~ 200MHz	3.86 dB
	200MHz ~1000MHz	3.87 dB
Radiated Emissions above 1 GHz	1GHz ~ 18GHz	2.29 dB
	18GHz ~ 40GHz	2.29 dB

2.2 Modification Record

There were no modifications required for compliance.

3 General Information

3.1 General Description of EUT

Product	Wall Jack Access Point	
Brand	Mojo	
Test Model	W-118	
Status of EUT	Engineering sample	
Power Supply Rating	12Vdc from Adapter 54Vdc from POE	
Modulation Type	WLAN	CCK, DQPSK, DBPSK for DSSS 256QAM, 64QAM, 16QAM, QPSK, BPSK for OFDM
	Bluetooth LE	GFSK
	Zigbee	O-QPSK
Modulation Technology	WLAN	DSSS, OFDM
Transfer Rate	WLAN	802.11b: 11/5.5/2/1Mbps 802.11a/g: 54/48/36/24/18/12/9/6Mbps 802.11n: up to 600Mbps 802.11ac: up to 867Mbps
	Bluetooth LE	1Mbps
	Zigbee	250kbps
Operating Frequency	WLAN	2.4GHz: 2412 ~ 2462MHz 5.0GHz: 5180 ~ 5240MHz, 5745 ~ 5825MHz
	Bluetooth LE	2402 ~ 2480MHz
	Zigbee	2405 ~ 2480MHz
Number of Channel	WLAN	2412 ~ 2462MHz: 11 for 802.11b, 802.11g, 802.11n (HT20) 7 for 802.11n (HT40) 5180 ~ 5240MHz: 4 for 802.11a, 802.11n (HT20), 802.11ac (VHT20) 2 for 802.11n (HT40), 802.11ac (VHT40) 1 for 802.11ac (VHT80) 5745 ~ 5825MHz: 5 for 802.11a, 802.11n (HT20), 802.11ac (VHT20) 2 for 802.11n (HT40), 802.11ac (VHT40) 1 for 802.11ac (VHT80)
	Bluetooth LE	40
	Zigbee	16

Output Power	WLAN	2.4GHz Band: Radio 1: CDD Mode: 406.510mW Beamforming Mode: 147.911mW Radio 3: 75.873mW 5GHz Band: Radio 2: CDD Mode: 5180 ~ 5240MHz: 277.997mW 5745 ~ 5825MHz: 460.176mW Beamforming Mode: 5180 ~ 5240MHz: 139.008mW 5745 ~ 5825MHz: 230.104mW Radio 3: CDD Mode: 5180 ~ 5240MHz: 53.633mW 5745 ~ 5825MHz: 51.192mW
	Bluetooth LE	1.730mW
	Zigbee	1.722mW
	Antenna Type	Refer to Note
Antenna Connector	Refer to Note	
Accessory Device	NA	
Cable Supplied	NA	

Note:

1. The EUT incorporates a MIMO function. Physically, the EUT provides 2 completed transmitters and 2 receivers.

2.4GHz Band			
Modulation Mode	TX Function	Beamforming	Remark
802.11b	2TX	Not Support	Radio 1
802.11g	2TX	Not Support	
802.11n (HT20)	2TX	Support	
802.11n (HT40)	2TX	Support	
802.11b	2TX	Not Support	Radio 3
802.11g	2TX	Not Support	
802.11n (HT20)	2TX	Not Support	
802.11n (HT40)	2TX	Not Support	

5GHz Band			
Modulation Mode	TX Function	Beamforming Mode	Remark
802.11a	2TX	Not Support	Radio 2 (Master)
802.11n (HT20)	2TX	Support	
802.11n (HT40)	2TX	Support	
802.11ac (VHT20)	2TX	Support	
802.11ac (VHT40)	2TX	Support	
802.11ac (VHT80)	2TX	Support	
802.11a	2TX	Not Support	Radio 3 (Client)
802.11n (HT20)	2TX	Not Support	
802.11n (HT40)	2TX	Not Support	
802.11ac (VHT20)	2TX	Not Support	
802.11ac (VHT40)	2TX	Not Support	
802.11ac (VHT80)	2TX	Not Support	

* The modulation and bandwidth are similar for 802.11n mode for 20MHz/40MHz and 802.11ac mode for 20MHz/40MHz, therefore investigated worst case to representative mode in test report. (Final test mode refer section 3.2.1)

* For 802.11n, CDD mode is the worst case for final radiated emission and power line conducted emission tests after pretesting CDD mode and beamforming mode.

2. The EUT consumes power from following Adapter and POE. (Support unit only)

Adapter	
Brand	Powertron Electronics Corp.
Model	PA1024-120IB200
Input Power	100-240Vac, 50-60Hz, 0.6A
Output Power	12Vdc / 2.0A 24W Max
Power Cord	1.5m non-shielded cable with one core 0.5m non-shielded cable without core

POE	
Brand	EnGenius
Model	EPA5006GAT
Input Power	100-240Vac, 50-60Hz, 0.8A
Output Power	54Vdc, 0.6A

3. The EUT uses following antennas.

Type	PIFA						PIFA
Connector	IPEX						-
Radio	1		2		3		BT/Zigbee
Frequency (MHz)	2400-2500		5150-5850		2400-2500 & 5150-5850		2400-2500
Antenna	1	2	3	4	5	6	BT/Zigbee
Gain (dBi)	3.67	4.31	5.72	5.99	2.51 / 4.83	2.78 / 4.80	2.76

3.2 Description of Test Modes

For 2.4GHz

11 channels are provided for 802.11b, 802.11g and 802.11n (HT20):

Channel	Frequency	Channel	Frequency
1	2412MHz	7	2442MHz
2	2417MHz	8	2447MHz
3	2422MHz	9	2452MHz
4	2427MHz	10	2457MHz
5	2432MHz	11	2462MHz
6	2437MHz		

7 channels are provided for 802.11n (HT40):

Channel	Frequency	Channel	Frequency
3	2422MHz	7	2442MHz
4	2427MHz	8	2447MHz
5	2432MHz	9	2452MHz
6	2437MHz		

For 5180~5240MHz:

4 channels are provided for 802.11a, 802.11n (HT20), 802.11ac (VHT20):

Channel	Frequency	Channel	Frequency
36	5180 MHz	44	5220 MHz
40	5200 MHz	48	5240 MHz

2 channels are provided for 802.11n (HT40), 802.11ac (VHT40):

Channel	Frequency	Channel	Frequency
38	5190 MHz	46	5230 MHz

1 channel is provided for 802.11ac (VHT80):

Channel	Frequency
42	5210MHz

5745~5825MHz:

5 channels are provided for 802.11a, 802.11n (HT20), 802.11ac (VHT20):

Channel	Frequency	Channel	Frequency
149	5745MHz	161	5805MHz
153	5765MHz	165	5825MHz
157	5785MHz		

2 channels are provided for 802.11n (HT40), 802.11ac (VHT40):

Channel	Frequency	Channel	Frequency
151	5755MHz	159	5795MHz

1 channel is provided for 802.11ac (VHT80):

Channel	Frequency
155	5775MHz

For Bluetooth LE:

40 channels are provided to this EUT:

Channel	Freq. (MHz)	Channel	Freq. (MHz)	Channel	Freq. (MHz)	Channel	Freq. (MHz)
0	2402	10	2422	20	2442	30	2462
1	2404	11	2424	21	2444	31	2464
2	2406	12	2426	22	2446	32	2466
3	2408	13	2428	23	2448	33	2468
4	2410	14	2430	24	2450	34	2470
5	2412	15	2432	25	2452	35	2472
6	2414	16	2434	26	2454	36	2474
7	2416	17	2436	27	2456	37	2476
8	2418	18	2438	28	2458	38	2478
9	2420	19	2440	29	2460	39	2480

For Zigbee:

16 channels are provided to this EUT:

Channel	Freq. (MHz)	Channel	Freq. (MHz)	Channel	Freq. (MHz)	Channel	Freq. (MHz)
11	2405	15	2425	19	2445	23	2465
12	2410	16	2430	20	2450	24	2470
13	2415	17	2435	21	2455	25	2475
14	2420	18	2440	22	2460	26	2480

3.2.1 Test Mode Applicability and Tested Channel Detail

EUT Configure Mode	Applicable to		Description
	RE \geq 1G	RE<1G	
A	√	√	Power from adapter
B	-	√	Power from PoE

Where **RE \geq 1G**: Radiated Emission above 1GHz & Bandedge Measurement **RE<1G**: Radiated Emission below 1GHz

Note:

1. The EUT had been pre-tested on the positioned of each 3 axis. The worst case was found when positioned on **Z-plane**.
2. "-": Means no effect.

Radiated Emission Test (Above 1GHz):

- Pre-Scan has been conducted to determine the worst-case mode from all possible combinations between available modulations, data rates and antenna ports (if EUT with antenna diversity architecture).
- Following channel(s) was (were) selected for the final test as listed below.

EUT Configure Mode	Mode	Freq. Range (MHz)	Available Channel	Tested Channel	Modulation Technology
A	Radio 1: 802.11g	2412~2462	1 to 11	CH 6 + CH 48 + CH 1 + CH 0	BPSK
	Radio 2: 802.11n (HT20)	5180~5240 5745~5825	36 to 48 149 to 165		OFDM
	Radio 3: 802.11g	2412~2462	1 to 11		BPSK
	BT LE	2402~2480	0 to 39		GFSK
A	Radio 1: 802.11g	2412~2462	1 to 11	CH 6 + CH 48 + CH 0	BPSK
	Radio 3: 802.11n (HT20)	5180~5240 5745~5825	36 to 48 149 to 165		OFDM
	BT LE	2402~2480	0 to 39		GFSK
A	Radio 1: 802.11g	2412~2462	1 to 11	CH 6 + CH 48 + CH 1 + CH 11	BPSK
	Radio 2: 802.11n (HT20)	5180~5240	36 to 48		OFDM
	Radio 3: 802.11g	2412~2462	1 to 11		BPSK
	Zigbee	2405~2480	11 to 26		O-QPSK
A	Radio 1: 802.11g	2412~2462	1 to 11	CH 6 + CH 48 + CH 11	BPSK
	Radio 3: 802.11n (HT20)	5180~5240 5745~5825	36 to 48 149 to 165		OFDM
	Zigbee	2405~2480	11 to 26		O-QPSK

Radiated Emission Test (Below 1GHz):

- Pre-Scan has been conducted to determine the worst-case mode from all possible combinations between available modulations, data rates and antenna ports (if EUT with antenna diversity architecture).
- Following channel(s) was (were) selected for the final test as listed below.

EUT Configure Mode	Mode	Freq. Range (MHz)	Available Channel	Tested Channel	Modulation Technology
A, B	Radio 1: 802.11g	2412~2462	1 to 11	CH 6 + CH 48 + CH 1 + CH 0	BPSK
	Radio 2: 802.11n (HT20)	5180~5240 5745~5825	36 to 48 149 to 165		OFDM
	Radio 3: 802.11g	2412~2462	1 to 11		BPSK
	BT LE	2402~2480	0 to 39		GFSK
A, B	Radio 1: 802.11g	2412~2462	1 to 11	CH 6 + CH 48 + CH 0	BPSK
	Radio 3: 802.11n (HT20)	5180~5240 5745~5825	36 to 48 149 to 165		OFDM
	BT LE	2402~2480	0 to 39		GFSK
A, B	Radio 1: 802.11g	2412~2462	1 to 11	CH 6 + CH 48 + CH 1 + CH 11	BPSK
	Radio 2: 802.11n (HT20)	5180~5240	36 to 48		OFDM
	Radio 3: 802.11g	2412~2462	1 to 11		BPSK
	Zigbee	2405~2480	11 to 26		O-QPSK
A, B	Radio 1: 802.11g	2412~2462	1 to 11	CH 6 + CH 48 + CH 11	BPSK
	Radio 3: 802.11n (HT20)	5180~5240 5745~5825	36 to 48 149 to 165		OFDM
	Zigbee	2405~2480	11 to 26		O-QPSK

Test Condition:

Applicable to	Environmental Conditions	Input Power	Tested by
RE≥1G	22 deg. C, 66% RH 23 deg. C, 64% RH	120Vac, 60Hz	Adair Peng, Willy Cheng
RE<1G	26 deg. C, 68% RH	120Vac, 60Hz	Adair Peng

3.3 Description of Support Units

The EUT has been tested as an independent unit together with other necessary accessories or support units. The following support units or accessories were used to form a representative test configuration during the tests.

ID	Product	Brand	Model No.	Serial No.	FCC ID	Remarks
A.	Notebook	Lenovo	80Q7	PF0KUGU6	FCC DoC Approved	-
B.	Adapter	Powertron	PA1024-120IB200	NA	NA	Provided by manufacturer
C.	Load	NA	NA	NA	NA	-
D.	POE	EnGenius	EPA5006GAT	NA	NA	Provided by manufacturer

Note:

1. All power cords of the above support units are non-shielded (1.8m).
2. Item A acted as a communication partner to transfer data.

ID	Descriptions	Qty.	Length (m)	Shielding (Yes/No)	Cores (Qty.)	Remarks
1.	RJ45, Cat5e	1	10	N	0	-
2.	RJ45, Cat5e	4	3	N	0	-
3.	Power Cord	1	1.0	N	0	-
4.	RJ45, Cat5e	1	3	N	0	-

Note: The core(s) is(are) originally attached to the cable(s).

3.3.1 Configuration of System under Test

Test Mode A

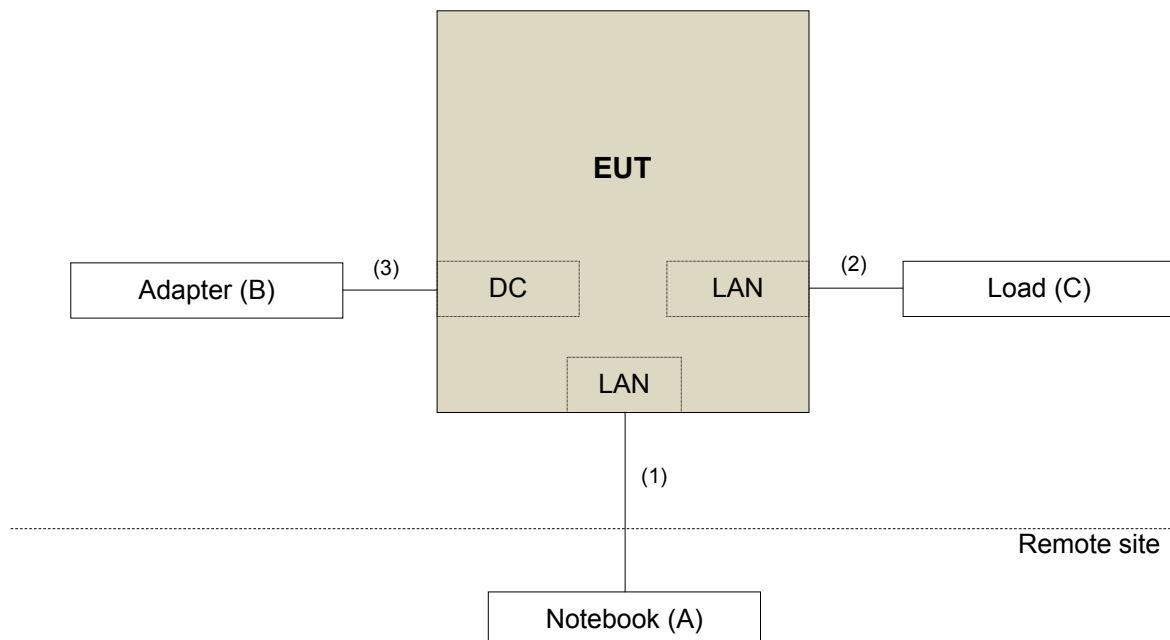

Test Mode B

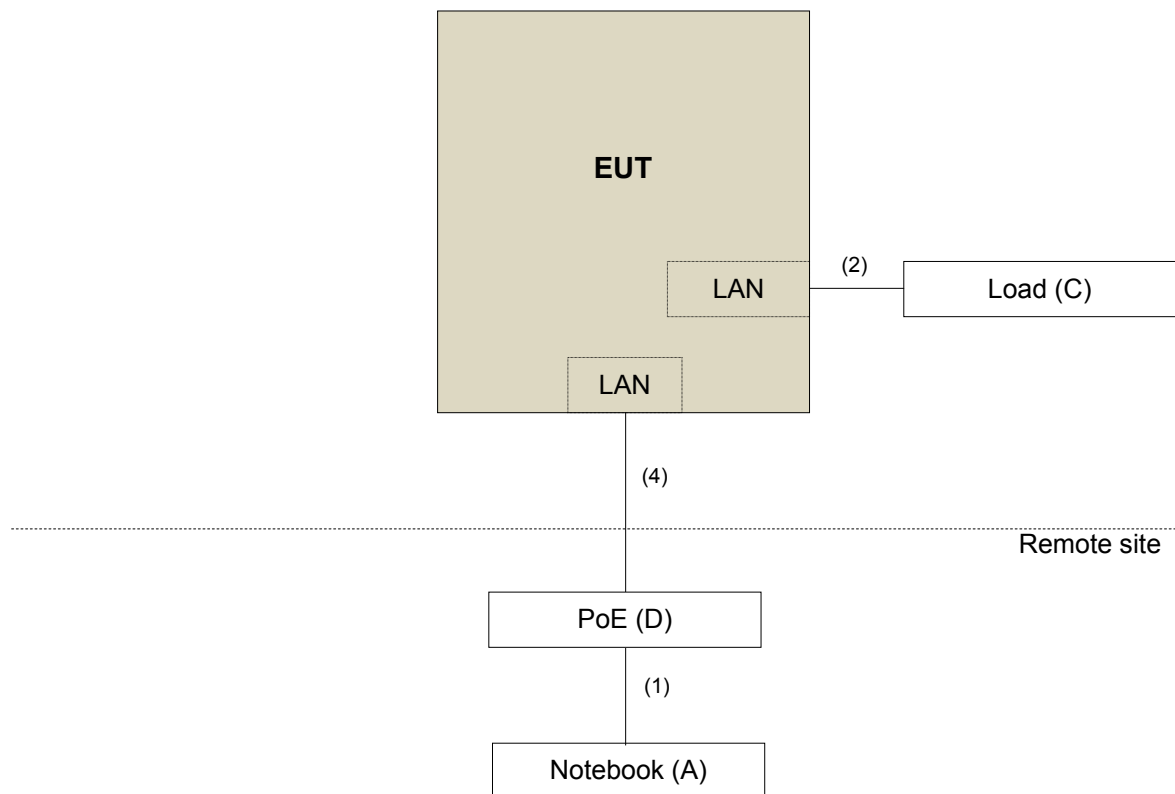

3.4 General Description of Applied Standards

The EUT is a RF Product. According to the specification of the EUT declared by the manufacturer, it must comply with the requirements of the following standards:

FCC Part 15, Subpart C (15.247)

FCC Part 15, Subpart E (15.407)

ANSI C63.10-2013

All test items have been performed and recorded as per the above standards.

4 Test Types and Results

4.1 Radiated Emission and Bandedge Measurement

4.1.1 Limits of Radiated Emission and Bandedge Measurement

Radiated emissions which fall in the restricted bands must comply with the radiated emission limits specified as below table. Other emissions shall be at least 20dB below the highest level of the desired power:

Frequencies (MHz)	Field Strength (microvolts/meter)	Measurement Distance (meters)
0.009 ~ 0.490	2400/F(kHz)	300
0.490 ~ 1.705	24000/F(kHz)	30
1.705 ~ 30.0	30	30
30 ~ 88	100	3
88 ~ 216	150	3
216 ~ 960	200	3
Above 960	500	3

NOTE:

1. The lower limit shall apply at the transition frequencies.
2. Emission level (dBuV/m) = 20 log Emission level (uV/m).
3. For frequencies above 1000MHz, the field strength limits are based on average detector, however, the peak field strength of any emission shall not exceed the maximum permitted average limits, specified above by more than 20dB under any condition of modulation.

Limits of unwanted emission out of the restricted bands

Applicable To		Limit	
789033 D02 General UNII Test Procedure New Rules v02r01		Field Strength at 3m	
		PK: 74 (dBµV/m)	AV: 54 (dBµV/m)
Frequency Band	Applicable To	EIRP Limit	Equivalent Field Strength at 3m
5150~5250 MHz	15.407(b)(1)	PK: -27 (dBm/MHz)	PK: 68.2(dBµV/m)
5250~5350 MHz	15.407(b)(2)		
5470~5725 MHz	15.407(b)(3)		
5725~5850 MHz	<input checked="" type="checkbox"/> 15.407(b)(4)(i)	PK: -27 (dBm/MHz) ^{*1} PK: 10 (dBm/MHz) ^{*2} PK: 15.6 (dBm/MHz) ^{*3} PK: 27 (dBm/MHz) ^{*4}	PK: 68.2(dBµV/m) ^{*1} PK: 105.2 (dBµV/m) ^{*2} PK: 110.8(dBµV/m) ^{*3} PK: 122.2 (dBµV/m) ^{*4}
	<input type="checkbox"/> 15.407(b)(4)(ii)	Emission limits in section 15.247(d)	
^{*1} beyond 75 MHz or more above of the band edge.		^{*2} below the band edge increasing linearly to 10 dBm/MHz at 25 MHz above.	
^{*3} below the band edge increasing linearly to a level of 15.6 dBm/MHz at 5 MHz above.		^{*4} from 5 MHz above or below the band edge increasing linearly to a level of 27 dBm/MHz at the band edge.	

Note: The following formula is used to convert the equipment isotropic radiated power (eirp) to field strength:

$$E = \frac{1000000 \sqrt{30 P}}{3} \mu\text{V/m, where } P \text{ is the eirp (Watts).}$$

4.1.2 Test Instruments

Description & Manufacturer	Model No.	Serial No.	Cal. Date	Cal. Due
Test Receiver ROHDE & SCHWARZ	ESIB7	100187	May 02, 2017	May 01, 2018
Spectrum Analyzer ROHDE & SCHWARZ	FSP40	100041	Dec. 12, 2017	Dec. 11, 2018
BILOG Antenna SCHWARZBECK	VULB9168	9168-171	Dec. 11, 2017	Dec. 10, 2018
HORN Antenna SCHWARZBECK	9120D	209	Dec. 13, 2017	Dec. 12, 2018
HORN Antenna SCHWARZBECK	BBHA 9170	BBHA9170241	Dec. 01, 2017	Nov. 30, 2018
Loop Antenna EMCI	EM-6879	269	Aug. 11, 2017	Aug. 10, 2018
Preamplifier Agilent (Below 1GHz)	8447D	2944A10738	Aug. 21, 2017	Aug. 20, 2018
Preamplifier Agilent (Above 1GHz)	8449B	3008A02465	Apr. 05, 2017	Apr. 04, 2018
RF signal cable HUBER+SUHNER	SUCOFLEX 104	Cable-CH3-03 (223653/4)	Aug. 21, 2017	Aug. 20, 2018
RF signal cable HUBER+SUHNER& EMCI	SUCOFLEX 104&EMC104-SM-S M-8000	Cable-CH3-03 (309224+170907)	Sep.11, 2017	Sep. 10, 2018
Software BV ADT	ADT_Radiated_ V7.6.15.9.4	NA	NA	NA
Antenna Tower inn-co GmbH	MA 4000	013303	NA	NA
Antenna Tower Controller BV ADT	AT100	AT93021702	NA	NA
Turn Table BV ADT	TT100	TT93021702	NA	NA
Turn Table Controller BV ADT	SC100	SC93021702	NA	NA
Boresight Antenna Fixture	FBA-01	FBA-SIP01	NA	NA
26GHz ~ 40GHz Amplifier Agilent	8449B	3008A1960	Aug. 08, 2017	Aug. 07, 2018

- Note:
1. The calibration interval of the above test instruments is 12 months and the calibrations are traceable to NML/ROC and NIST/USA.
 2. The test was performed in HwaYa Chamber 3.
 3. The horn antenna and preamplifier (model: 8449B) are used only for the measurement of emission frequency above 1GHz if tested.
 4. The FCC Designation Number is TW0003. The number will be varied with the Lab location and scope as attached.
 5. The IC Site Registration No. is IC 7450F-3.

4.1.3 Test Procedures

For Radiated emission below 30MHz

- a. The EUT was placed on the top of a rotating table 0.8 meters above the ground at a 3 meter chamber room. The table was rotated 360 degrees to determine the position of the highest radiation.
- b. The EUT was set 3 meters away from the interference-receiving antenna, which was mounted on the top of a variable-height antenna tower.
- c. Both X and Y axes of the antenna are set to make the measurement.
- d. For each suspected emission, the EUT was arranged to its worst case and the rotatable table was turned from 0 degrees to 360 degrees to find the maximum reading.
- e. The test-receiver system was set to Quasi-Peak Detect Function and Specified Bandwidth with Maximum Hold Mode.

Note:

1. The resolution bandwidth and video bandwidth of test receiver/spectrum analyzer is 9kHz at frequency below 30MHz.

For Radiated emission above 30MHz

- a. The EUT was placed on the top of a rotating table 0.8 meters (for 30MHz ~ 1GHz) / 1.5 meters (for above 1GHz) above the ground at 3 meter chamber room for test. The table was rotated 360 degrees to determine the position of the highest radiation.
- b. The EUT was set 3 meters away from the interference-receiving antenna, which was mounted on the top of a variable-height antenna tower.
- c. The height of antenna is varied from one meter to four meters above the ground to determine the maximum value of the field strength. Both horizontal and vertical polarizations of the antenna are set to make the measurement.
- d. For each suspected emission, the EUT was arranged to its worst case and then the antenna was tuned to heights from 1 meter to 4 meters and the rotatable table was turned from 0 degrees to 360 degrees to find the maximum reading.
- e. The test-receiver system was set to quasi-peak detect function and specified bandwidth with maximum hold mode when the test frequency is below 1 GHz.
- f. The test-receiver system was set to peak and average detect function and specified bandwidth with maximum hold mode when the test frequency is above 1 GHz. If the peak reading value also meets average limit, measurement with the average detector is unnecessary.

Note:

1. The resolution bandwidth and video bandwidth of test receiver/spectrum analyzer is 120kHz for Quasi-peak detection (QP) at frequency below 1GHz.
2. The resolution bandwidth of test receiver/spectrum analyzer is 1 MHz and the video bandwidth is 3 MHz for Peak detection (PK) at frequency above 1GHz.
3. The resolution bandwidth of test receiver/spectrum analyzer is 1MHz and the video bandwidth is $\geq 1/T$ (Duty cycle < 98%) or 10Hz (Duty cycle $\geq 98\%$) for Average detection (AV) at frequency above 1GHz.
4. All modes of operation were investigated and the worst-case emissions are reported.

4.1.4 Deviation from Test Standard

No deviation.

4.1.5 Test Setup

For Radiated emission below 30MHz

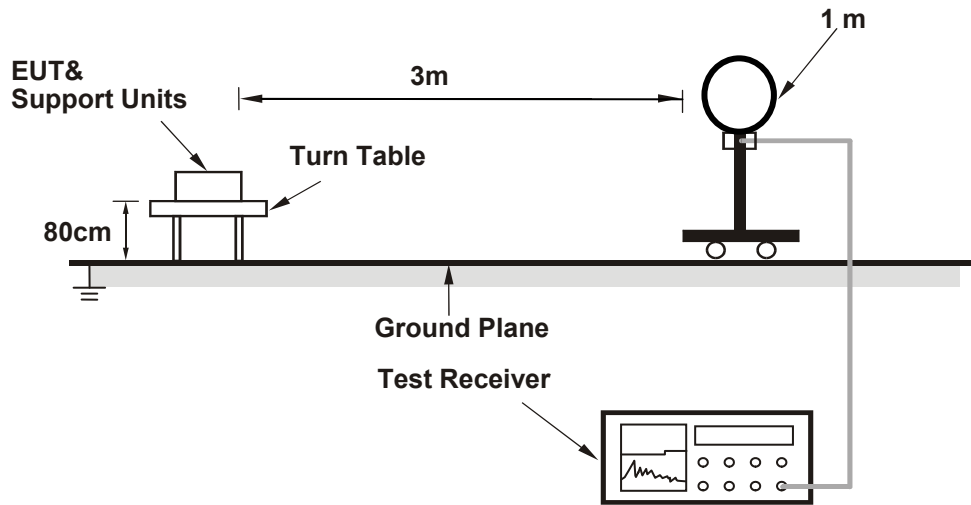

For Radiated emission 30MHz to 1GHz

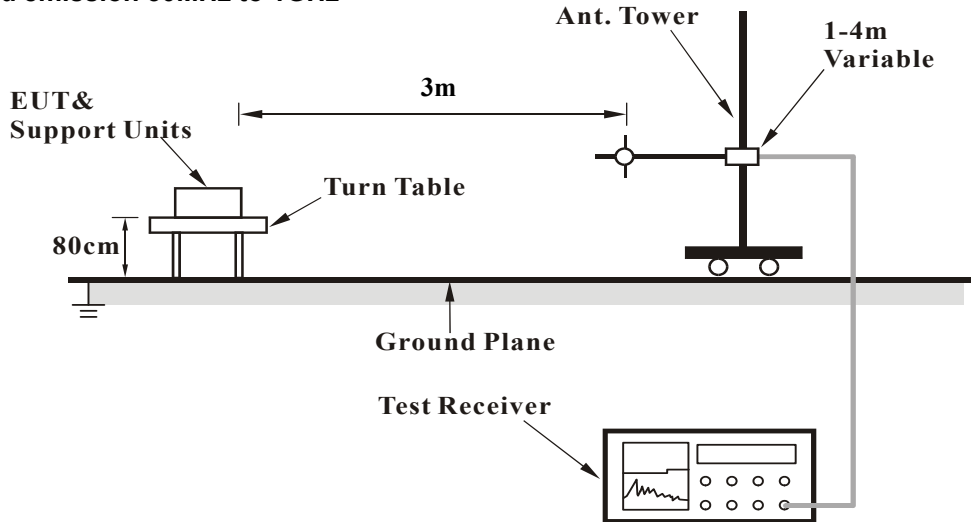

For Radiated emission above 1GHz

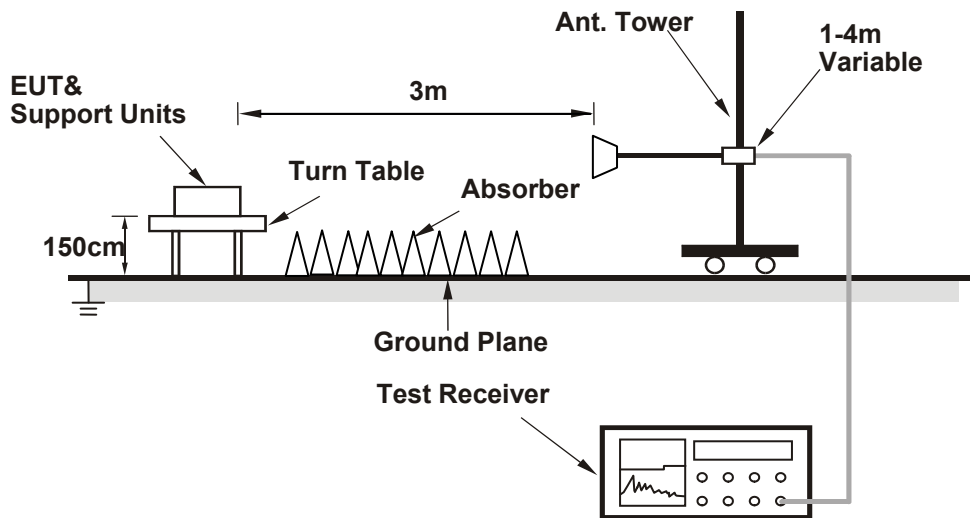

For the actual test configuration, please refer to the attached file (Test Setup Photo).

4.1.6 EUT Operating Conditions

- a. Placed the EUT on the testing table.
- b. Prepared a notebook to act as a communication partner and placed it outside of testing area.
- c. The communication partner connected with EUT via a RJ45 cable and ran a test program (provided by manufacturer) to enable EUT under transmission condition continuously at specific channel frequency.
- d. The communication partner sent data to EUT by command "PING".

4.1.7 Test Results

Above 1GHz Data:

Radio 1: 802.11g + Radio 2: 802.11n (HT20) + Radio 3: 802.11g + BT LE

CHANNEL	CH 6 + CH 48 + CH 1 + CH 0	DETECTOR FUNCTION	Peak (PK) Average (AV)
FREQUENCY RANGE	1GHz ~ 40GHz		

ANTENNA POLARITY & TEST DISTANCE: HORIZONTAL AT 3 M								
NO.	FREQ. (MHz)	EMISSION LEVEL (dBuV/m)	LIMIT (dBuV/m)	MARGIN (dB)	ANTENNA HEIGHT (m)	TABLE ANGLE (Degree)	RAW VALUE (dBuV)	CORRECTION FACTOR (dB/m)
1	2390.00	71.0 PK	74.0	-3.0	1.37 H	352	37.5	33.5
2	2390.00	52.9 AV	54.0	-1.1	1.37 H	352	19.4	33.5
3	*2402.00	90.0 PK			1.13 H	314	56.6	33.4
4	*2402.00	83.1 AV			1.13 H	314	49.7	33.4
5	*2412.00	107.7 PK			1.49 H	352	74.3	33.4
6	*2412.00	98.0 AV			1.49 H	352	64.6	33.4
7	*2437.00	115.2 PK			1.12 H	328	81.8	33.4
8	*2437.00	104.0 AV			1.12 H	328	70.6	33.4
9	2483.50	64.3 PK	74.0	-9.7	1.34 H	335	31.1	33.2
10	2483.50	48.4 AV	54.0	-5.6	1.34 H	335	15.2	33.2
11	4804.00	48.2 PK	74.0	-25.8	2.02 H	33	44.6	3.6
12	4804.00	36.8 AV	54.0	-17.2	2.02 H	33	33.2	3.6
13	4824.00	51.1 PK	74.0	-22.9	1.91 H	15	47.4	3.7
14	4824.00	38.0 AV	54.0	-16.0	1.91 H	15	34.3	3.7
15	4874.00	51.0 PK	74.0	-23.0	2.06 H	18	47.5	3.5
16	4874.00	45.1 AV	54.0	-8.9	2.06 H	18	41.6	3.5
17	*5240.00	119.6 PK			1.87 H	27	80.2	39.4
18	*5240.00	108.6 AV			1.87 H	27	69.2	39.4
19	5350.00	57.0 PK	74.0	-17.0	2.01 H	48	53.2	3.8
20	5350.00	42.1 AV	54.0	-11.9	2.01 H	48	38.3	3.8
21	#10480.00	59.2 PK	74.0	-14.8	2.22 H	183	42.6	16.6
22	#10480.00	45.4 AV	54.0	-8.6	2.22 H	183	28.8	16.6

Remarks:

1. Emission Level(dBuV/m) = Raw Value(dBuV) + Correction Factor(dB/m)
2. Correction Factor(dB/m) = Antenna Factor(dB/m) + Cable Factor(dB) – Pre-Amplifier Factor(dB)
3. The other emission levels were very low against the limit.
4. Margin value = Emission Level – Limit value
5. " * ": Fundamental frequency.
6. " # ": The radiated frequency is out of the restricted band.

CHANNEL	CH 6 + CH 48 + CH 1 + CH 0	DETECTOR FUNCTION	Peak (PK) Average (AV)
FREQUENCY RANGE	1GHz ~ 40GHz		

ANTENNA POLARITY & TEST DISTANCE: VERTICAL AT 3 M								
NO.	FREQ. (MHz)	EMISSION LEVEL (dBuV/m)	LIMIT (dBuV/m)	MARGIN (dB)	ANTENNA HEIGHT (m)	TABLE ANGLE (Degree)	RAW VALUE (dBuV)	CORRECTION FACTOR (dB/m)
1	2390.00	61.8 PK	74.0	-12.2	3.58 V	335	28.3	33.5
2	2390.00	47.2 AV	54.0	-6.8	3.58 V	335	13.7	33.5
3	*2402.00	93.2 PK			1.00 V	359	59.8	33.4
4	*2402.00	89.0 AV			1.00 V	359	55.6	33.4
5	*2412.00	97.7 PK			1.53 V	112	64.3	33.4
6	*2412.00	87.7 AV			1.53 V	112	54.3	33.4
7	*2437.00	109.7 PK			1.44 V	90	76.3	33.4
8	*2437.00	98.7 AV			1.44 V	90	65.3	33.4
9	2483.50	60.9 PK	74.0	-13.1	3.19 V	326	27.7	33.2
10	2483.50	46.1 AV	54.0	-7.9	3.19 V	326	12.9	33.2
11	4804.00	54.3 PK	74.0	-19.7	1.76 V	312	50.7	3.6
12	4804.00	40.2 AV	54.0	-13.8	1.76 V	312	36.6	3.6
13	4824.00	54.9 PK	74.0	-19.1	1.89 V	359	51.2	3.7
14	4824.00	41.2 AV	54.0	-12.8	1.89 V	359	37.5	3.7
15	4874.00	50.3 PK	74.0	-23.7	3.04 V	332	46.8	3.5
16	4874.00	43.3 AV	54.0	-10.7	3.04 V	332	39.8	3.5
17	*5240.00	121.8 PK			2.06 V	351	82.4	39.4
18	*5240.00	110.5 AV			2.06 V	351	71.1	39.4
19	5350.00	54.6 PK	74.0	-19.4	1.88 V	326	50.8	3.8
20	5350.00	42.4 AV	54.0	-11.6	1.88 V	326	38.6	3.8
21	#10480.00	58.4 PK	74.0	-15.6	2.46 V	188	41.8	16.6
22	#10480.00	44.8 AV	54.0	-9.2	2.46 V	188	28.2	16.6

Remarks:

1. Emission Level(dBuV/m) = Raw Value(dBuV) + Correction Factor(dB/m)
2. Correction Factor(dB/m) = Antenna Factor(dB/m) + Cable Factor(dB) – Pre-Amplifier Factor(dB)
3. The other emission levels were very low against the limit.
4. Margin value = Emission Level – Limit value
5. " * ": Fundamental frequency.
6. " # ": The radiated frequency is out of the restricted band.

Radio 1: 802.11g + Radio 3: 802.11n (HT20) + BT LE

CHANNEL	CH 6 + CH 48 + CH 0	DETECTOR FUNCTION	Peak (PK) Average (AV)
FREQUENCY RANGE	1GHz ~ 40GHz		

ANTENNA POLARITY & TEST DISTANCE: HORIZONTAL AT 3 M								
NO.	FREQ. (MHz)	EMISSION LEVEL (dBuV/m)	LIMIT (dBuV/m)	MARGIN (dB)	ANTENNA HEIGHT (m)	TABLE ANGLE (Degree)	RAW VALUE (dBuV)	CORRECTION FACTOR (dB/m)
1	2390.00	60.3 PK	74.0	-13.7	1.69 H	342	26.8	33.5
2	2390.00	47.4 AV	54.0	-6.6	1.69 H	342	13.9	33.5
3	*2402.00	90.1 PK			1.08 H	309	56.7	33.4
4	*2402.00	83.0 AV			1.08 H	309	49.6	33.4
5	*2437.00	115.2 PK			1.31 H	301	81.8	33.4
6	*2437.00	104.1 AV			1.31 H	301	70.7	33.4
7	2483.50	62.0 PK	74.0	-12.0	1.42 H	308	28.8	33.2
8	2483.50	49.5 AV	54.0	-4.5	1.42 H	308	16.3	33.2
9	4804.00	48.7 PK	74.0	-25.3	1.99 H	55	45.1	3.6
10	4804.00	35.9 AV	54.0	-18.1	1.99 H	55	32.3	3.6
11	4874.00	50.1 PK	74.0	-23.9	2.01 H	21	46.6	3.5
12	4874.00	43.8 AV	54.0	-10.2	2.01 H	21	40.3	3.5
13	*5240.00	109.8 PK			1.29 H	17	70.4	39.4
14	*5240.00	99.7 AV			1.29 H	17	60.3	39.4
15	5350.00	55.1 PK	74.0	-18.9	1.33 H	49	51.3	3.8
16	5350.00	42.2 AV	54.0	-11.8	1.33 H	49	38.4	3.8
17	#10480.00	59.9 PK	74.0	-14.1	1.83 H	196	43.3	16.6
18	#10480.00	45.2 AV	54.0	-8.8	1.83 H	196	28.6	16.6

Remarks:

1. Emission Level(dBuV/m) = Raw Value(dBuV) + Correction Factor(dB/m)
2. Correction Factor(dB/m) = Antenna Factor(dB/m) + Cable Factor(dB) – Pre-Amplifier Factor(dB)
3. The other emission levels were very low against the limit.
4. Margin value = Emission Level – Limit value
5. " * ": Fundamental frequency.
6. " # ": The radiated frequency is out of the restricted band.

CHANNEL	CH 6 + CH 48 + CH 0	DETECTOR FUNCTION	Peak (PK) Average (AV)
FREQUENCY RANGE	1GHz ~ 40GHz		

ANTENNA POLARITY & TEST DISTANCE: VERTICAL AT 3 M								
NO.	FREQ. (MHz)	EMISSION LEVEL (dBuV/m)	LIMIT (dBuV/m)	MARGIN (dB)	ANTENNA HEIGHT (m)	TABLE ANGLE (Degree)	RAW VALUE (dBuV)	CORRECTION FACTOR (dB/m)
1	2390.00	62.3 PK	74.0	-11.7	3.13 V	309	28.8	33.5
2	2390.00	47.3 AV	54.0	-6.7	3.13 V	309	13.8	33.5
3	*2402.00	94.1 PK			1.02 V	355	60.7	33.4
4	*2402.00	90.0 AV			1.02 V	355	56.6	33.4
5	*2437.00	110.7 PK			1.54 V	100	77.3	33.4
6	*2437.00	100.3 AV			1.54 V	100	66.9	33.4
7	2483.50	61.8 PK	74.0	-12.2	3.02 V	318	28.6	33.2
8	2483.50	47.2 AV	54.0	-6.8	3.02 V	318	14.0	33.2
9	4804.00	54.1 PK	74.0	-19.9	1.96 V	303	50.5	3.6
10	4804.00	41.2 AV	54.0	-12.8	1.96 V	303	37.6	3.6
11	4874.00	50.1 PK	74.0	-23.9	2.99 V	317	46.6	3.5
12	4874.00	43.0 AV	54.0	-11.0	2.99 V	317	39.5	3.5
13	*5240.00	107.1 PK			1.00 V	314	67.7	39.4
14	*5240.00	96.7 AV			1.00 V	314	57.3	39.4
15	5350.00	56.0 PK	74.0	-18.0	1.08 V	299	52.2	3.8
16	5350.00	42.1 AV	54.0	-11.9	1.08 V	299	38.3	3.8
17	#10480.00	62.2 PK	74.0	-11.8	2.67 V	198	45.6	16.6
18	#10480.00	45.9 AV	54.0	-8.1	2.67 V	198	29.3	16.6

Remarks:

1. Emission Level(dBuV/m) = Raw Value(dBuV) + Correction Factor(dB/m)
2. Correction Factor(dB/m) = Antenna Factor(dB/m) + Cable Factor(dB) – Pre-Amplifier Factor(dB)
3. The other emission levels were very low against the limit.
4. Margin value = Emission Level – Limit value
5. " * ": Fundamental frequency.
6. " # ": The radiated frequency is out of the restricted band.

Radio 1: 802.11g + Radio 2: 802.11n (HT20) + Radio 3: 802.11g + Zigbee

CHANNEL	CH 6 + CH 48 + CH 1 + CH 11	DETECTOR FUNCTION	Peak (PK) Average (AV)
FREQUENCY RANGE	1GHz ~ 40GHz		

ANTENNA POLARITY & TEST DISTANCE: HORIZONTAL AT 3 M								
NO.	FREQ. (MHz)	EMISSION LEVEL (dBuV/m)	LIMIT (dBuV/m)	MARGIN (dB)	ANTENNA HEIGHT (m)	TABLE ANGLE (Degree)	RAW VALUE (dBuV)	CORRECTION FACTOR (dB/m)
1	2390.00	64.1 PK	74.0	-9.9	1.44 H	328	30.6	33.5
2	2390.00	52.7 AV	54.0	-1.3	1.44 H	328	19.2	33.5
3	*2405.00	98.5 PK			2.23 H	284	65.1	33.4
4	*2405.00	94.1 AV			2.23 H	284	60.7	33.4
5	*2412.00	108.5 PK			1.56 H	329	75.1	33.4
6	*2412.00	98.5 AV			1.56 H	329	65.1	33.4
7	*2437.00	114.8 PK			1.21 H	318	81.4	33.4
8	*2437.00	104.5 AV			1.21 H	318	71.1	33.4
9	2483.50	60.0 PK	74.0	-14.0	1.34 H	335	26.8	33.2
10	2483.50	48.6 AV	54.0	-5.4	1.34 H	335	15.4	33.2
11	4810.00	45.4 PK	74.0	-28.6	1.89 H	222	41.8	3.6
12	4810.00	34.1 AV	54.0	-19.9	1.89 H	222	30.5	3.6
13	4824.00	51.9 PK	74.0	-22.1	2.05 H	34	48.2	3.7
14	4824.00	39.3 AV	54.0	-14.7	2.05 H	34	35.6	3.7
15	4874.00	50.6 PK	74.0	-23.4	1.98 H	22	47.1	3.5
16	4874.00	44.8 AV	54.0	-9.2	1.98 H	22	41.3	3.5
17	*5240.00	119.8 PK			1.89 H	31	80.4	39.4
18	*5240.00	108.6 AV			1.89 H	31	69.2	39.4
19	5350.00	56.6 PK	74.0	-17.4	2.10 H	88	52.8	3.8
20	5350.00	42.3 AV	54.0	-11.7	2.10 H	88	38.5	3.8
21	#10480.00	59.7 PK	74.0	-14.3	2.41 H	188	43.1	16.6
22	#10480.00	46.5 AV	54.0	-7.5	2.41 H	188	29.9	16.6

Remarks:

1. Emission Level(dBuV/m) = Raw Value(dBuV) + Correction Factor(dB/m)
2. Correction Factor(dB/m) = Antenna Factor(dB/m) + Cable Factor(dB) – Pre-Amplifier Factor(dB)
3. The other emission levels were very low against the limit.
4. Margin value = Emission Level – Limit value
5. " * ": Fundamental frequency.
6. " # ": The radiated frequency is out of the restricted band.

CHANNEL	CH 6 + CH 48 + CH 1 + CH 11	DETECTOR FUNCTION	Peak (PK) Average (AV)
FREQUENCY RANGE	1GHz ~ 40GHz		

ANTENNA POLARITY & TEST DISTANCE: VERTICAL AT 3 M								
NO.	FREQ. (MHz)	EMISSION LEVEL (dBuV/m)	LIMIT (dBuV/m)	MARGIN (dB)	ANTENNA HEIGHT (m)	TABLE ANGLE (Degree)	RAW VALUE (dBuV)	CORRECTION FACTOR (dB/m)
1	2390.00	61.7 PK	74.0	-12.3	3.57 V	335	28.2	33.5
2	2390.00	47.2 AV	54.0	-6.8	3.57 V	335	13.7	33.5
3	*2405.00	90.5 PK			1.86 V	294	57.1	33.4
4	*2405.00	86.3 AV			1.86 V	294	52.9	33.4
5	*2412.00	97.8 PK			1.54 V	118	64.4	33.4
6	*2412.00	87.8 AV			1.54 V	118	54.4	33.4
7	*2437.00	110.0 PK			1.56 V	91	76.6	33.4
8	*2437.00	98.8 AV			1.56 V	91	65.4	33.4
9	2483.50	60.7 PK	74.0	-13.3	3.11 V	296	27.5	33.2
10	2483.50	45.7 AV	54.0	-8.3	3.11 V	296	12.5	33.2
11	4810.00	48.8 PK	74.0	-25.2	1.88 V	164	45.2	3.6
12	4810.00	37.7 AV	54.0	-16.3	1.88 V	164	34.1	3.6
13	4824.00	55.1 PK	74.0	-18.9	1.89 V	359	51.4	3.7
14	4824.00	41.3 AV	54.0	-12.7	1.89 V	359	37.6	3.7
15	4874.00	50.3 PK	74.0	-23.7	3.24 V	332	46.8	3.5
16	4874.00	42.6 AV	54.0	-11.4	3.24 V	332	39.1	3.5
17	*5240.00	122.0 PK			2.06 V	354	82.6	39.4
18	*5240.00	110.5 AV			2.06 V	354	71.1	39.4
19	5350.00	54.2 PK	74.0	-19.8	1.64 V	315	50.4	3.8
20	5350.00	42.2 AV	54.0	-11.8	1.64 V	315	38.4	3.8
21	#10480.00	58.5 PK	74.0	-15.5	2.44 V	212	41.9	16.6
22	#10480.00	45.0 AV	54.0	-9.0	2.44 V	212	28.4	16.6

Remarks:

1. Emission Level(dBuV/m) = Raw Value(dBuV) + Correction Factor(dB/m)
2. Correction Factor(dB/m) = Antenna Factor(dB/m) + Cable Factor(dB) – Pre-Amplifier Factor(dB)
3. The other emission levels were very low against the limit.
4. Margin value = Emission Level – Limit value
5. " * ": Fundamental frequency.
6. " # ": The radiated frequency is out of the restricted band.

Radio 1: 802.11g + Radio 3: 802.11n (HT20) + Zigbee

CHANNEL	CH 6 + CH 48 + CH 11	DETECTOR FUNCTION	Peak (PK) Average (AV)
FREQUENCY RANGE	1GHz ~ 40GHz		

ANTENNA POLARITY & TEST DISTANCE: HORIZONTAL AT 3 M								
NO.	FREQ. (MHz)	EMISSION LEVEL (dBuV/m)	LIMIT (dBuV/m)	MARGIN (dB)	ANTENNA HEIGHT (m)	TABLE ANGLE (Degree)	RAW VALUE (dBuV)	CORRECTION FACTOR (dB/m)
1	2390.00	59.9 PK	74.0	-14.1	1.77 H	331	26.4	33.5
2	2390.00	47.1 AV	54.0	-6.9	1.77 H	331	13.6	33.5
3	*2405.00	93.3 PK			1.10 H	311	59.9	33.4
4	*2405.00	96.1 AV			1.10 H	311	62.7	33.4
5	*2437.00	114.8 PK			1.42 H	305	81.4	33.4
6	*2437.00	103.9 AV			1.42 H	305	70.5	33.4
7	2483.50	61.7 PK	74.0	-12.3	1.44 H	311	28.5	33.2
8	2483.50	49.2 AV	54.0	-4.8	1.44 H	311	16.0	33.2
9	4810.00	48.4 PK	74.0	-25.6	2.01 H	69	44.8	3.6
10	4810.00	36.2 AV	54.0	-17.8	2.01 H	69	32.6	3.6
11	4874.00	50.3 PK	74.0	-23.7	1.96 H	35	46.8	3.5
12	4874.00	44.2 AV	54.0	-9.8	1.96 H	35	40.7	3.5
13	*5240.00	110.1 PK			1.33 H	22	70.7	39.4
14	*5240.00	100.0 AV			1.33 H	22	60.6	39.4
15	5350.00	56.0 PK	74.0	-18.0	1.46 H	69	52.2	3.8
16	5350.00	42.0 AV	54.0	-12.0	1.46 H	69	38.2	3.8
17	#10480.00	59.7 PK	74.0	-14.3	1.88 H	201	43.1	16.6
18	#10480.00	45.4 AV	54.0	-8.6	1.88 H	201	28.8	16.6

Remarks:

1. Emission Level(dBuV/m) = Raw Value(dBuV) + Correction Factor(dB/m)
2. Correction Factor(dB/m) = Antenna Factor(dB/m) + Cable Factor(dB) – Pre-Amplifier Factor(dB)
3. The other emission levels were very low against the limit.
4. Margin value = Emission Level – Limit value
5. " * ": Fundamental frequency.
6. " # ": The radiated frequency is out of the restricted band.

CHANNEL	CH 6 + CH 48 + CH 11	DETECTOR FUNCTION	Peak (PK) Average (AV)
FREQUENCY RANGE	1GHz ~ 40GHz		

ANTENNA POLARITY & TEST DISTANCE: VERTICAL AT 3 M								
NO.	FREQ. (MHz)	EMISSION LEVEL (dBuV/m)	LIMIT (dBuV/m)	MARGIN (dB)	ANTENNA HEIGHT (m)	TABLE ANGLE (Degree)	RAW VALUE (dBuV)	CORRECTION FACTOR (dB/m)
1	2390.00	60.6 PK	74.0	-13.4	3.09 V	268	27.1	33.5
2	2390.00	46.7 AV	54.0	-7.3	3.09 V	268	13.2	33.5
3	*2405.00	89.3 PK			1.08 V	342	55.9	33.4
4	*2405.00	85.8 AV			1.08 V	342	52.4	33.4
5	*2437.00	110.4 PK			1.55 V	124	77.0	33.4
6	*2437.00	99.6 AV			1.55 V	124	66.2	33.4
7	2483.50	62.0 PK	74.0	-12.0	2.95 V	308	28.8	33.2
8	2483.50	47.2 AV	54.0	-6.8	2.95 V	308	14.0	33.2
9	4810.00	52.1 PK	74.0	-21.9	1.88 V	296	48.5	3.6
10	4810.00	41.2 AV	54.0	-12.8	1.88 V	296	37.6	3.6
11	4874.00	49.4 PK	74.0	-24.6	3.05 V	298	45.9	3.5
12	4874.00	43.0 AV	54.0	-11.0	3.05 V	298	39.5	3.5
13	*5240.00	107.3 PK			1.12 V	316	67.9	39.4
14	*5240.00	96.9 AV			1.12 V	316	57.5	39.4
15	5350.00	56.2 PK	74.0	-17.8	1.21 V	300	52.4	3.8
16	5350.00	42.0 AV	54.0	-12.0	1.21 V	300	38.2	3.8
17	#10480.00	61.7 PK	74.0	-12.3	2.84 V	199	45.1	16.6
18	#10480.00	45.5 AV	54.0	-8.5	2.84 V	199	28.9	16.6

Remarks:

1. Emission Level(dBuV/m) = Raw Value(dBuV) + Correction Factor(dB/m)
2. Correction Factor(dB/m) = Antenna Factor(dB/m) + Cable Factor(dB) – Pre-Amplifier Factor(dB)
3. The other emission levels were very low against the limit.
4. Margin value = Emission Level – Limit value
5. " * ": Fundamental frequency.
6. " # ": The radiated frequency is out of the restricted band.

Below 1GHz data

Radio 1: 802.11g + Radio 2: 802.11n (HT20) + Radio 3: 802.11g + BT LE

CHANNEL	CH 6 + CH 48 + CH 1 + CH 0	DETECTOR FUNCTION	Quasi-Peak (QP)
FREQUENCY RANGE	9kHz ~ 1GHz	TEST MODE	A

ANTENNA POLARITY & TEST DISTANCE: HORIZONTAL AT 3 M								
NO.	FREQ. (MHz)	EMISSION LEVEL (dBuV/m)	LIMIT (dBuV/m)	MARGIN (dB)	ANTENNA HEIGHT (m)	TABLE ANGLE (Degree)	RAW VALUE (dBuV)	CORRECTION FACTOR (dB/m)
1	29.90	38.2 QP	40.0	-1.8	1.00 H	193	54.3	-16.1
2	84.34	38.1 QP	40.0	-1.9	1.49 H	359	57.2	-19.1
3	216.55	34.0 QP	46.0	-12.0	1.49 H	359	50.4	-16.4
4	294.32	36.9 QP	46.0	-9.1	1.00 H	225	49.8	-12.9
5	397.37	32.9 QP	46.0	-13.1	1.00 H	290	44.1	-11.2
6	933.99	38.4 QP	46.0	-7.6	1.00 H	6	40.5	-2.1
ANTENNA POLARITY & TEST DISTANCE: VERTICAL AT 3 M								
NO.	FREQ. (MHz)	EMISSION LEVEL (dBuV/m)	LIMIT (dBuV/m)	MARGIN (dB)	ANTENNA HEIGHT (m)	TABLE ANGLE (Degree)	RAW VALUE (dBuV)	CORRECTION FACTOR (dB/m)
1	41.57	36.2 QP	40.0	-3.8	1.00 V	29	50.8	-14.6
2	90.17	40.0 QP	43.5	-3.5	1.50 V	133	59.5	-19.5
3	204.89	37.1 QP	43.5	-6.4	1.00 V	169	54.0	-16.9
4	288.49	39.7 QP	46.0	-6.3	1.00 V	222	52.7	-13.0
5	414.87	35.4 QP	46.0	-10.6	1.00 V	309	46.4	-11.0
6	933.99	34.9 QP	46.0	-11.1	1.50 V	233	37.0	-2.1

Remarks:

1. Emission Level(dBuV/m) = Raw Value(dBuV) + Correction Factor(dB/m)
2. Correction Factor(dB/m) = Antenna Factor(dB/m) + Cable Factor(dB) – Pre-Amplifier Factor(dB)
3. The other emission levels were very low against the limit.
4. Margin value = Emission Level – Limit value

Radio 1: 802.11g + Radio 3: 802.11n (HT20) + BT LE

CHANNEL	CH 6 + CH 48 + CH 0	DETECTOR FUNCTION	Quasi-Peak (QP)
FREQUENCY RANGE	9kHz ~ 1GHz	TEST MODE	A

ANTENNA POLARITY & TEST DISTANCE: HORIZONTAL AT 3 M

NO.	FREQ. (MHz)	EMISSION LEVEL (dBuV/m)	LIMIT (dBuV/m)	MARGIN (dB)	ANTENNA HEIGHT (m)	TABLE ANGLE (Degree)	RAW VALUE (dBuV)	CORRECTION FACTOR (dB/m)
1	57.12	38.9 QP	40.0	-1.1	1.49 H	331	53.3	-14.4
2	84.34	38.1 QP	40.0	-1.9	1.49 H	359	57.2	-19.1
3	146.56	33.8 QP	43.5	-9.7	1.00 H	132	47.8	-14.0
4	241.83	33.1 QP	46.0	-12.9	1.00 H	85	48.0	-14.9
5	294.32	36.9 QP	46.0	-9.1	1.00 H	122	49.8	-12.9
6	397.37	32.9 QP	46.0	-13.1	1.00 H	203	44.1	-11.2

ANTENNA POLARITY & TEST DISTANCE: VERTICAL AT 3 M

NO.	FREQ. (MHz)	EMISSION LEVEL (dBuV/m)	LIMIT (dBuV/m)	MARGIN (dB)	ANTENNA HEIGHT (m)	TABLE ANGLE (Degree)	RAW VALUE (dBuV)	CORRECTION FACTOR (dB/m)
1	41.57	36.2 QP	40.0	-3.8	1.50 V	133	50.8	-14.6
2	84.34	38.9 QP	40.0	-1.1	1.00 V	266	58.0	-19.1
3	109.62	32.0 QP	43.5	-11.5	1.00 V	319	49.3	-17.3
4	199.05	35.0 QP	43.5	-8.5	1.50 V	77	51.8	-16.8
5	294.32	39.2 QP	46.0	-6.8	1.00 V	187	52.1	-12.9
6	385.70	34.1 QP	46.0	-11.9	1.00 V	6	45.5	-11.4

Remarks:

1. Emission Level(dBuV/m) = Raw Value(dBuV) + Correction Factor(dB/m)
2. Correction Factor(dB/m) = Antenna Factor(dB/m) + Cable Factor(dB) – Pre-Amplifier Factor(dB)
3. The other emission levels were very low against the limit.
4. Margin value = Emission Level – Limit value

Radio 1: 802.11g + Radio 2: 802.11n (HT20) + Radio 3: 802.11g + Zigbee

CHANNEL	CH 6 + CH 48 + CH 1 + CH 11	DETECTOR FUNCTION	Quasi-Peak (QP)
FREQUENCY RANGE	9kHz ~ 1GHz	TEST MODE	A

ANTENNA POLARITY & TEST DISTANCE: HORIZONTAL AT 3 M

NO.	FREQ. (MHz)	EMISSION LEVEL (dBuV/m)	LIMIT (dBuV/m)	MARGIN (dB)	ANTENNA HEIGHT (m)	TABLE ANGLE (Degree)	RAW VALUE (dBuV)	CORRECTION FACTOR (dB/m)
1	30.90	39.1 QP	40.0	-0.9	1.00 H	349	55.1	-16.0
2	84.34	34.7 QP	40.0	-5.3	1.00 H	158	53.8	-19.1
3	156.28	30.7 QP	43.5	-12.8	1.50 H	266	44.4	-13.7
4	270.99	31.6 QP	46.0	-14.4	1.00 H	197	45.1	-13.5
5	496.53	29.5 QP	46.0	-16.5	1.50 H	311	39.0	-9.5
6	622.91	30.4 QP	46.0	-15.6	1.00 H	197	37.3	-6.9

ANTENNA POLARITY & TEST DISTANCE: VERTICAL AT 3 M

NO.	FREQ. (MHz)	EMISSION LEVEL (dBuV/m)	LIMIT (dBuV/m)	MARGIN (dB)	ANTENNA HEIGHT (m)	TABLE ANGLE (Degree)	RAW VALUE (dBuV)	CORRECTION FACTOR (dB/m)
1	41.57	36.2 QP	40.0	-3.8	1.50 V	79	50.8	-14.6
2	84.34	38.9 QP	40.0	-1.1	1.00 V	309	58.0	-19.1
3	284.60	37.8 QP	46.0	-8.2	1.00 V	278	50.8	-13.0
4	298.21	36.8 QP	46.0	-9.2	1.50 V	71	49.6	-12.8
5	414.87	35.4 QP	46.0	-10.6	1.00 V	33	46.4	-11.0
6	698.74	31.3 QP	46.0	-14.7	1.50 V	6	37.2	-5.9

Remarks:

1. Emission Level(dBuV/m) = Raw Value(dBuV) + Correction Factor(dB/m)
2. Correction Factor(dB/m) = Antenna Factor(dB/m) + Cable Factor(dB) – Pre-Amplifier Factor(dB)
3. The other emission levels were very low against the limit.
4. Margin value = Emission Level – Limit value

Radio 1: 802.11g + Radio 3: 802.11n (HT20) + Zigbee

CHANNEL	CH 6 + CH 48 + CH 11	DETECTOR FUNCTION	Quasi-Peak (QP)
FREQUENCY RANGE	9kHz ~ 1GHz	TEST MODE	A

ANTENNA POLARITY & TEST DISTANCE: HORIZONTAL AT 3 M

NO.	FREQ. (MHz)	EMISSION LEVEL (dBuV/m)	LIMIT (dBuV/m)	MARGIN (dB)	ANTENNA HEIGHT (m)	TABLE ANGLE (Degree)	RAW VALUE (dBuV)	CORRECTION FACTOR (dB/m)
1	30.90	39.8 QP	40.0	-0.2	1.50 H	193	55.8	-16.0
2	57.12	38.9 QP	40.0	-1.1	1.50 H	203	53.3	-14.4
3	99.89	32.0 QP	43.5	-11.5	1.00 H	221	50.5	-18.5
4	212.66	32.4 QP	43.5	-11.1	1.00 H	309	48.9	-16.5
5	298.21	34.8 QP	46.0	-11.2	1.00 H	132	47.6	-12.8
6	747.34	39.0 QP	46.0	-7.0	1.50 H	85	43.8	-4.8

ANTENNA POLARITY & TEST DISTANCE: VERTICAL AT 3 M

NO.	FREQ. (MHz)	EMISSION LEVEL (dBuV/m)	LIMIT (dBuV/m)	MARGIN (dB)	ANTENNA HEIGHT (m)	TABLE ANGLE (Degree)	RAW VALUE (dBuV)	CORRECTION FACTOR (dB/m)
1	57.12	34.6 QP	40.0	-5.4	1.00 V	177	49.0	-14.4
2	90.17	40.0 QP	43.5	-3.5	1.00 V	258	59.5	-19.5
3	199.05	35.0 QP	43.5	-8.5	1.50 V	6	51.8	-16.8
4	241.83	32.5 QP	46.0	-13.5	1.50 V	344	47.4	-14.9
5	286.55	38.5 QP	46.0	-7.5	1.00 V	297	51.5	-13.0
6	414.87	35.4 QP	46.0	-10.6	1.00 V	101	46.4	-11.0

Remarks:

1. Emission Level(dBuV/m) = Raw Value(dBuV) + Correction Factor(dB/m)
2. Correction Factor(dB/m) = Antenna Factor(dB/m) + Cable Factor(dB) – Pre-Amplifier Factor(dB)
3. The other emission levels were very low against the limit.
4. Margin value = Emission Level – Limit value

Radio 1: 802.11g + Radio 2: 802.11n (HT20) + Radio 3: 802.11g + BT LE

CHANNEL	CH 6 + CH 48 + CH 1 + CH 0	DETECTOR FUNCTION	Quasi-Peak (QP)
FREQUENCY RANGE	9kHz ~ 1GHz	TEST MODE	B

ANTENNA POLARITY & TEST DISTANCE: HORIZONTAL AT 3 M

NO.	FREQ. (MHz)	EMISSION LEVEL (dBuV/m)	LIMIT (dBuV/m)	MARGIN (dB)	ANTENNA HEIGHT (m)	TABLE ANGLE (Degree)	RAW VALUE (dBuV)	CORRECTION FACTOR (dB/m)
1	82.40	26.8 QP	40.0	-13.2	1.99 H	114	45.5	-18.7
2	162.11	31.4 QP	43.5	-12.1	1.49 H	244	45.3	-13.9
3	340.99	34.9 QP	46.0	-11.1	1.00 H	208	47.0	-12.1
4	438.20	28.9 QP	46.0	-17.1	1.99 H	16	39.2	-10.3
5	582.08	29.7 QP	46.0	-16.3	1.49 H	207	37.6	-7.9
6	729.84	29.3 QP	46.0	-16.7	1.49 H	10	34.5	-5.2

ANTENNA POLARITY & TEST DISTANCE: VERTICAL AT 3 M

NO.	FREQ. (MHz)	EMISSION LEVEL (dBuV/m)	LIMIT (dBuV/m)	MARGIN (dB)	ANTENNA HEIGHT (m)	TABLE ANGLE (Degree)	RAW VALUE (dBuV)	CORRECTION FACTOR (dB/m)
1	51.29	34.2 QP	40.0	-5.8	1.00 V	301	48.3	-14.1
2	82.40	36.6 QP	40.0	-3.4	1.00 V	148	55.3	-18.7
3	107.67	31.8 QP	43.5	-11.7	1.00 V	63	49.4	-17.6
4	335.15	29.4 QP	46.0	-16.6	1.00 V	120	41.5	-12.1
5	836.78	36.7 QP	46.0	-9.3	1.99 V	114	40.2	-3.5
6	935.94	33.1 QP	46.0	-12.9	1.00 V	181	35.2	-2.1

Remarks:

1. Emission Level(dBuV/m) = Raw Value(dBuV) + Correction Factor(dB/m)
2. Correction Factor(dB/m) = Antenna Factor(dB/m) + Cable Factor(dB) – Pre-Amplifier Factor(dB)
3. The other emission levels were very low against the limit.
4. Margin value = Emission Level – Limit value

Radio 1: 802.11g + Radio 3: 802.11n (HT20) + BT LE

CHANNEL	CH 6 + CH 48 + CH 0	DETECTOR FUNCTION	Quasi-Peak (QP)
FREQUENCY RANGE	9kHz ~ 1GHz	TEST MODE	B

ANTENNA POLARITY & TEST DISTANCE: HORIZONTAL AT 3 M

NO.	FREQ. (MHz)	EMISSION LEVEL (dBuV/m)	LIMIT (dBuV/m)	MARGIN (dB)	ANTENNA HEIGHT (m)	TABLE ANGLE (Degree)	RAW VALUE (dBuV)	CORRECTION FACTOR (dB/m)
1	57.12	28.4 QP	40.0	-11.6	1.99 H	213	42.8	-14.4
2	111.56	25.0 QP	43.5	-18.5	1.49 H	242	42.2	-17.2
3	171.83	27.7 QP	43.5	-15.8	1.99 H	246	42.0	-14.3
4	348.76	31.8 QP	46.0	-14.2	1.00 H	208	43.9	-12.1
5	428.48	30.2 QP	46.0	-15.8	1.99 H	52	40.6	-10.4
6	609.30	29.0 QP	46.0	-17.0	1.49 H	286	36.2	-7.2

ANTENNA POLARITY & TEST DISTANCE: VERTICAL AT 3 M

NO.	FREQ. (MHz)	EMISSION LEVEL (dBuV/m)	LIMIT (dBuV/m)	MARGIN (dB)	ANTENNA HEIGHT (m)	TABLE ANGLE (Degree)	RAW VALUE (dBuV)	CORRECTION FACTOR (dB/m)
1	49.34	32.2 QP	40.0	-7.8	1.00 V	313	46.3	-14.1
2	84.34	35.5 QP	40.0	-4.5	1.00 V	110	54.6	-19.1
3	160.17	28.2 QP	43.5	-15.3	1.00 V	135	42.0	-13.8
4	333.21	27.9 QP	46.0	-18.1	1.00 V	147	40.0	-12.1
5	665.68	28.2 QP	46.0	-17.8	1.00 V	350	34.7	-6.5
6	939.83	34.2 QP	46.0	-11.8	1.00 V	244	36.2	-2.0

Remarks:

1. Emission Level(dBuV/m) = Raw Value(dBuV) + Correction Factor(dB/m)
2. Correction Factor(dB/m) = Antenna Factor(dB/m) + Cable Factor(dB) – Pre-Amplifier Factor(dB)
3. The other emission levels were very low against the limit.
4. Margin value = Emission Level – Limit value

Radio 1: 802.11g + Radio 2: 802.11n (HT20) + Radio 3: 802.11g + Zigbee

CHANNEL	CH 6 + CH 48 + CH 1 + CH 11	DETECTOR FUNCTION	Quasi-Peak (QP)
FREQUENCY RANGE	9kHz ~ 1GHz	TEST MODE	B

ANTENNA POLARITY & TEST DISTANCE: HORIZONTAL AT 3 M

NO.	FREQ. (MHz)	EMISSION LEVEL (dBuV/m)	LIMIT (dBuV/m)	MARGIN (dB)	ANTENNA HEIGHT (m)	TABLE ANGLE (Degree)	RAW VALUE (dBuV)	CORRECTION FACTOR (dB/m)
1	82.40	26.8 QP	40.0	-13.2	1.99 H	114	45.5	-18.7
2	150.45	29.1 QP	43.5	-14.4	1.99 H	258	42.8	-13.7
3	181.55	28.4 QP	43.5	-15.1	1.49 H	230	43.7	-15.3
4	335.15	34.8 QP	46.0	-11.2	1.00 H	200	46.9	-12.1
5	428.48	30.2 QP	46.0	-15.8	1.99 H	52	40.6	-10.4
6	747.34	31.0 QP	46.0	-15.0	1.99 H	19	35.8	-4.8

ANTENNA POLARITY & TEST DISTANCE: VERTICAL AT 3 M

NO.	FREQ. (MHz)	EMISSION LEVEL (dBuV/m)	LIMIT (dBuV/m)	MARGIN (dB)	ANTENNA HEIGHT (m)	TABLE ANGLE (Degree)	RAW VALUE (dBuV)	CORRECTION FACTOR (dB/m)
1	51.29	33.3 QP	40.0	-6.7	1.00 V	357	47.4	-14.1
2	97.95	33.8 QP	43.5	-9.7	1.00 V	84	52.4	-18.6
3	313.77	25.8 QP	46.0	-20.2	1.00 V	132	38.2	-12.4
4	562.64	28.9 QP	46.0	-17.1	1.00 V	10	37.3	-8.4
5	735.68	29.6 QP	46.0	-16.4	1.00 V	72	34.5	-4.9
6	834.84	30.3 QP	46.0	-15.7	1.00 V	66	33.8	-3.5

Remarks:

1. Emission Level(dBuV/m) = Raw Value(dBuV) + Correction Factor(dB/m)
2. Correction Factor(dB/m) = Antenna Factor(dB/m) + Cable Factor(dB) – Pre-Amplifier Factor(dB)
3. The other emission levels were very low against the limit.
4. Margin value = Emission Level – Limit value

Radio 1: 802.11g + Radio 3: 802.11n (HT20) + Zigbee

CHANNEL	CH 6 + CH 48 + CH 11	DETECTOR FUNCTION	Quasi-Peak (QP)
FREQUENCY RANGE	9kHz ~ 1GHz	TEST MODE	B

ANTENNA POLARITY & TEST DISTANCE: HORIZONTAL AT 3 M

NO.	FREQ. (MHz)	EMISSION LEVEL (dBuV/m)	LIMIT (dBuV/m)	MARGIN (dB)	ANTENNA HEIGHT (m)	TABLE ANGLE (Degree)	RAW VALUE (dBuV)	CORRECTION FACTOR (dB/m)
1	57.12	25.0 QP	40.0	-15.0	1.50 H	102	39.4	-14.4
2	160.17	26.7 QP	43.5	-16.8	1.00 H	258	40.5	-13.8
3	321.54	28.3 QP	46.0	-17.7	1.99 H	127	40.6	-12.3
4	430.42	24.7 QP	46.0	-21.3	1.99 H	289	35.1	-10.4
5	640.41	27.6 QP	46.0	-18.4	1.00 H	18	34.2	-6.6
6	937.88	30.7 QP	46.0	-15.3	1.00 H	133	32.7	-2.0

ANTENNA POLARITY & TEST DISTANCE: VERTICAL AT 3 M

NO.	FREQ. (MHz)	EMISSION LEVEL (dBuV/m)	LIMIT (dBuV/m)	MARGIN (dB)	ANTENNA HEIGHT (m)	TABLE ANGLE (Degree)	RAW VALUE (dBuV)	CORRECTION FACTOR (dB/m)
1	49.34	35.7 QP	40.0	-4.3	1.50 V	16	49.8	-14.1
2	72.67	29.2 QP	40.0	-10.8	1.00 V	187	45.7	-16.5
3	152.39	26.4 QP	43.5	-17.1	1.99 V	184	40.2	-13.8
4	329.32	26.9 QP	46.0	-19.1	1.00 V	145	39.0	-12.1
5	550.97	30.6 QP	46.0	-15.4	1.50 V	55	39.2	-8.6
6	939.83	30.3 QP	46.0	-15.7	1.00 V	177	32.3	-2.0

Remarks:

1. Emission Level(dBuV/m) = Raw Value(dBuV) + Correction Factor(dB/m)
2. Correction Factor(dB/m) = Antenna Factor(dB/m) + Cable Factor(dB) – Pre-Amplifier Factor(dB)
3. The other emission levels were very low against the limit.
4. Margin value = Emission Level – Limit value

5 Pictures of Test Arrangements

Please refer to the attached file (Test Setup Photo).

Annex A- Radiated Out of Band Emission (OOBE) Measurement (For U-NII-3 band)

ML-5299-FHPA6-01R Ant. + ML-2499-HPA8-01Ant.

802.11a

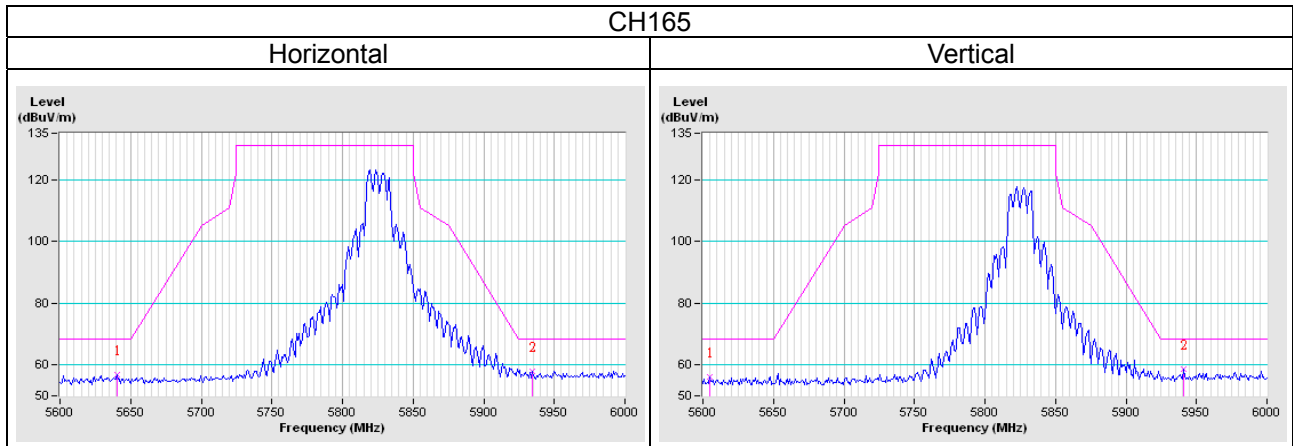

ML-5299-FHPA6-01R Ant. + ML-2499-HPA8-01Ant.

802.11a

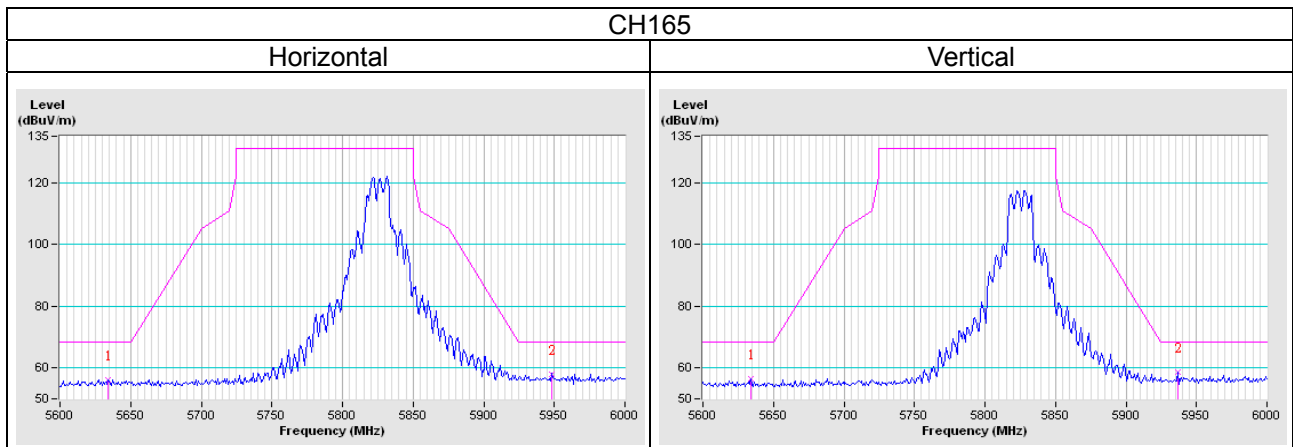

ML-5299-FHPA6-01R Ant. + ML-2452-PNA7-01R Ant.

802.11a

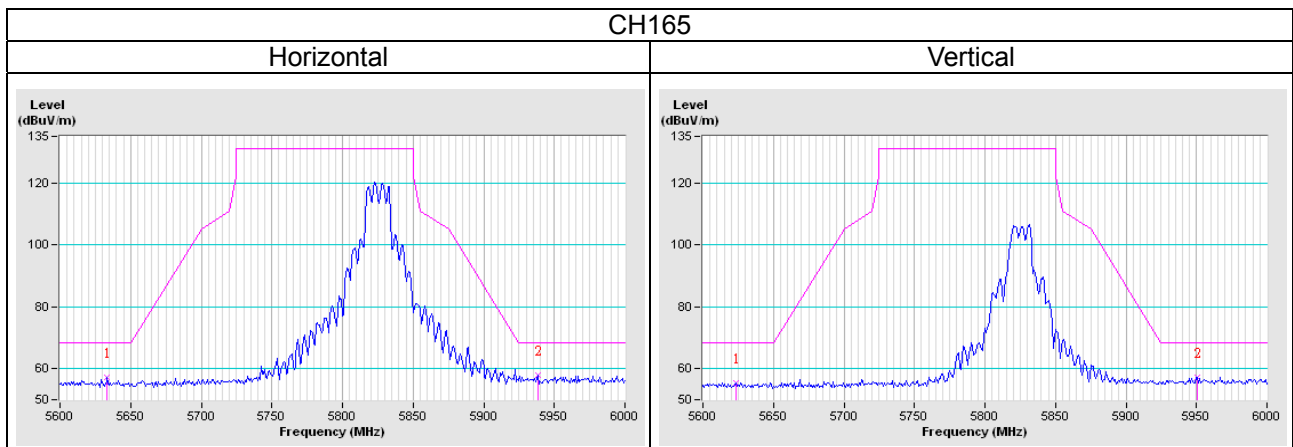

ML-5299-FHPA6-01R Ant. + ML-2452-PNA7-01R Ant.

802.11a

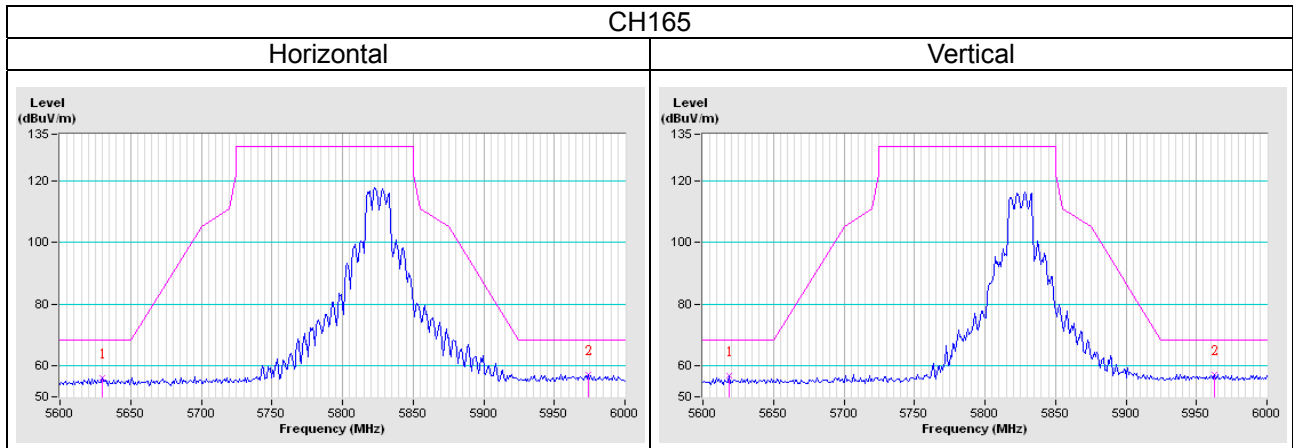

ML-2452-PNA5-01R Ant. + ML-2499-HPA8-01 Ant.

802.11a

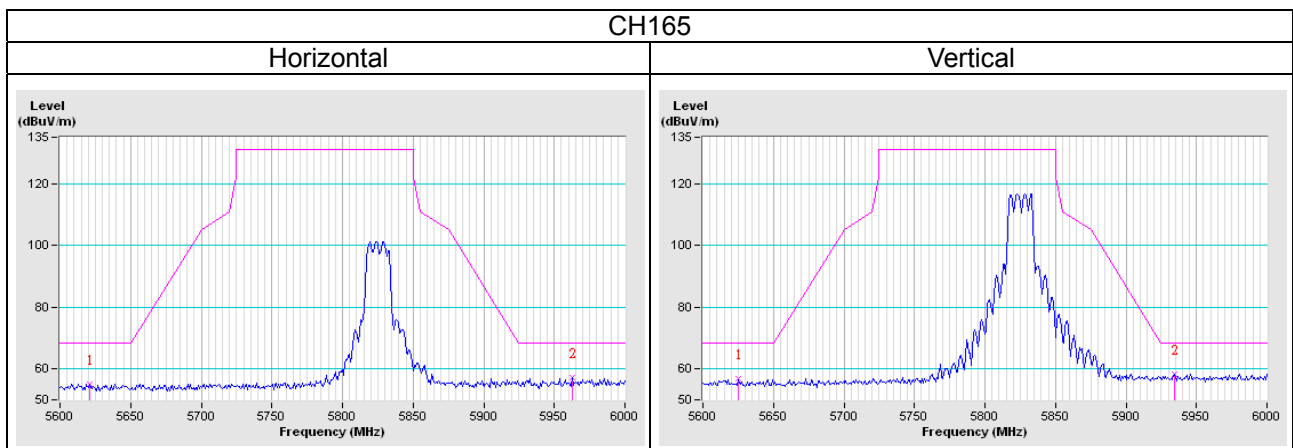

ML-2452-PNA5-01R Ant. + ML-2499-HPA8-01 Ant.

802.11a

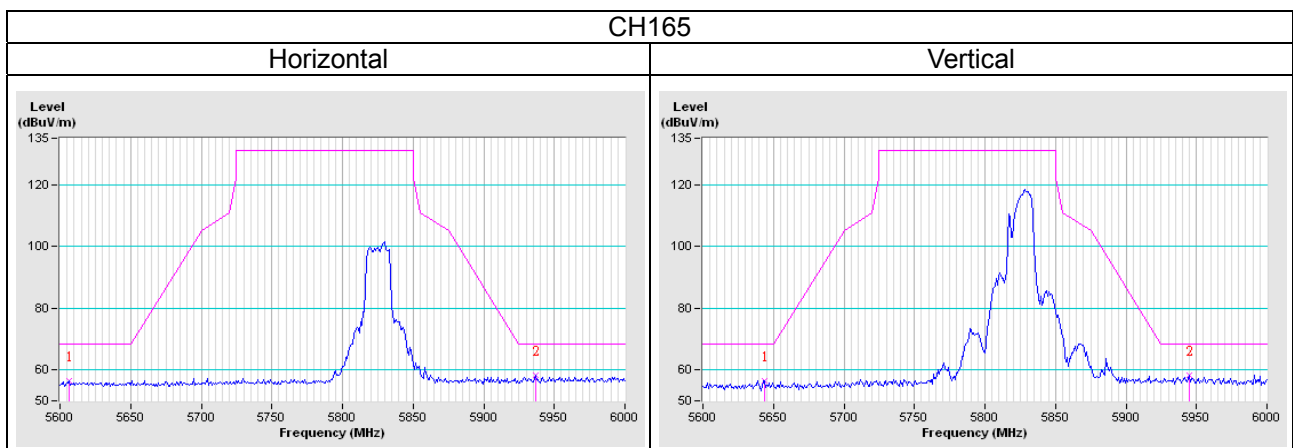

ML-2452-PNA5-01R Ant. + ML-2452-PNA7-01R Ant.

802.11a

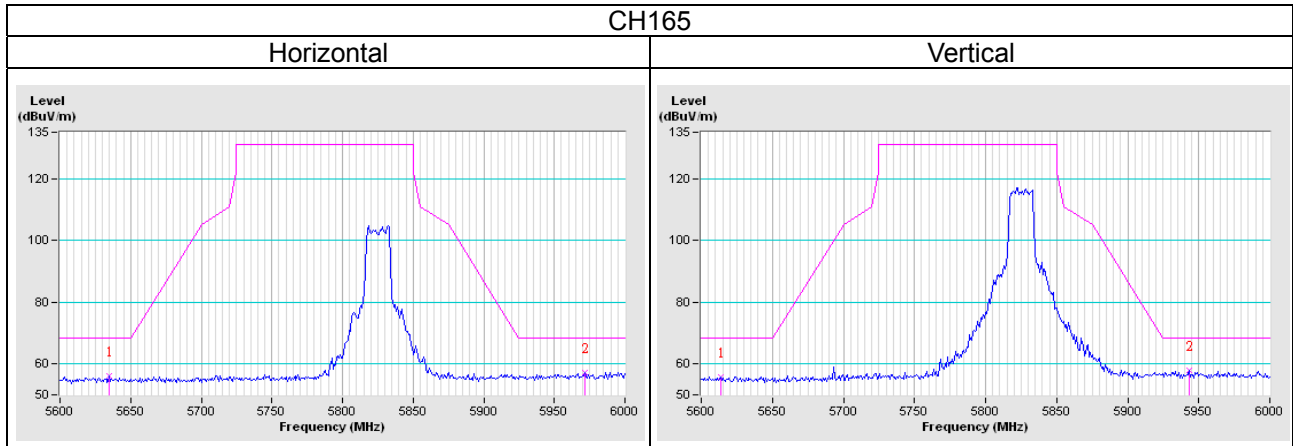

ML-2452-PNA5-01R Ant. + ML-2452-PNA7-01R Ant.

802.11a

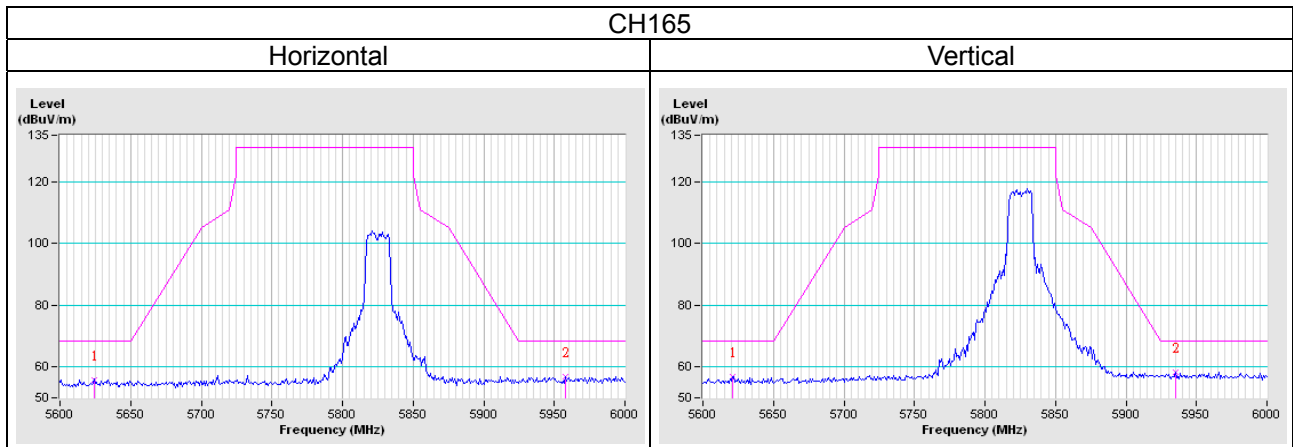

ML-2452-PNA7-01R Ant. + ML-2499-HPA8-01 Ant.

802.11n (HT20)

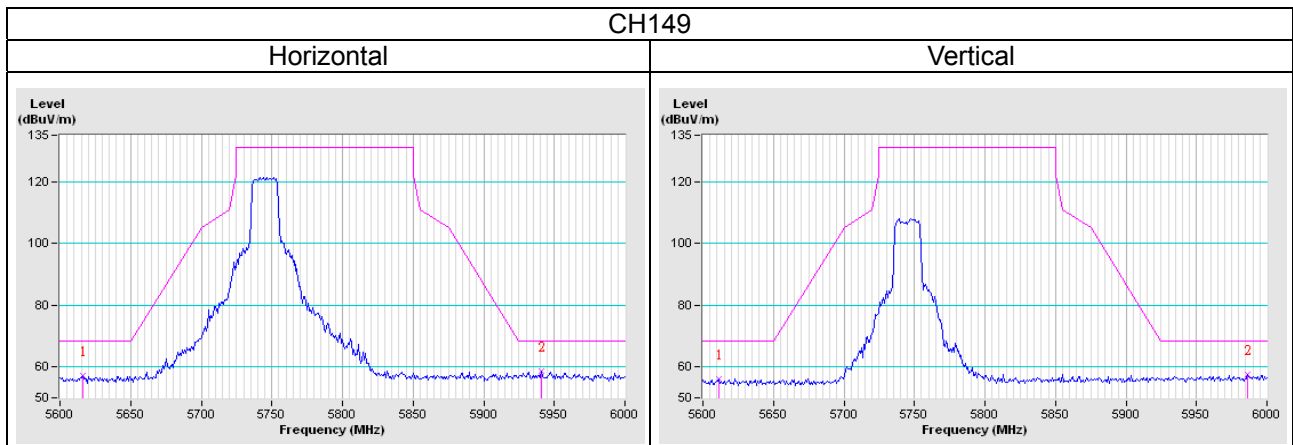

ML-2452-PNA7-01R Ant. + ML-2499-HPA8-01 Ant.

802.11n (HT20)

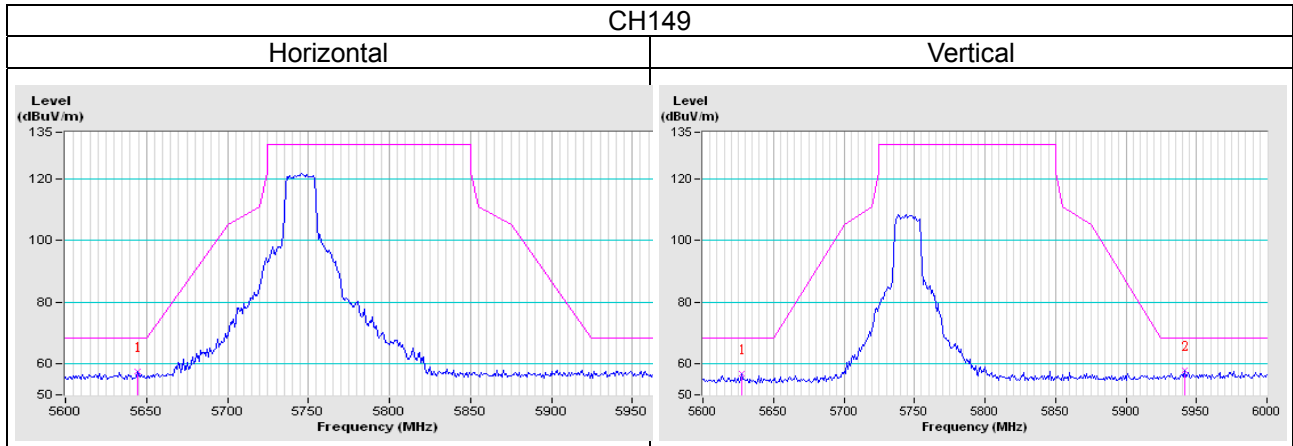

ML-2452-PNA7-01R Ant. + ML-2452-PNA7-01R Ant.

802.11n (HT20)

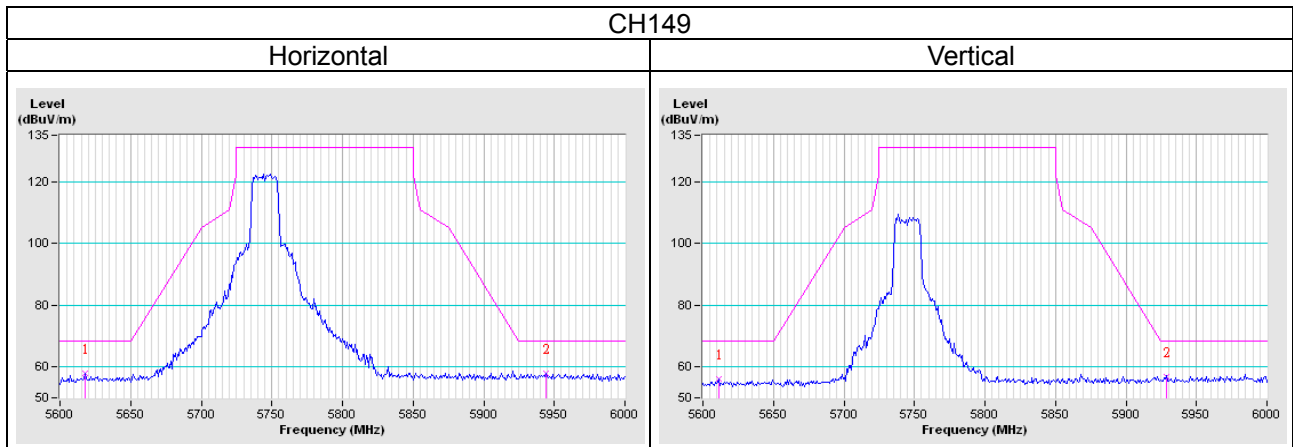

ML-2452-PNA7-01R Ant. + ML-2452-PNA7-01R Ant.

802.11n (HT20)

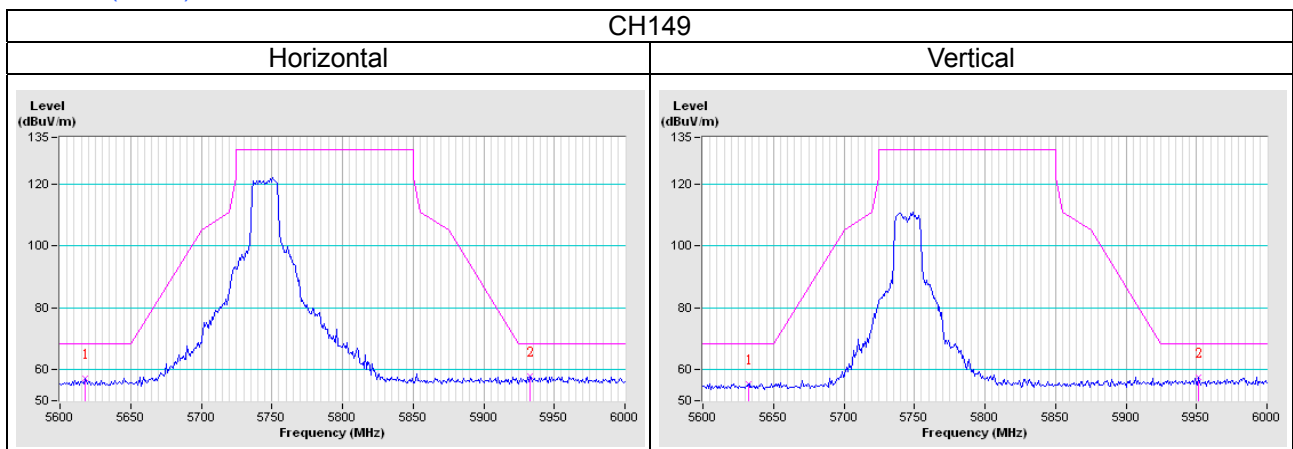

ML-2452-PNL6M4-N36 Ant. + ML-2499-HPA8-01 Ant.

802.11n (HT20)

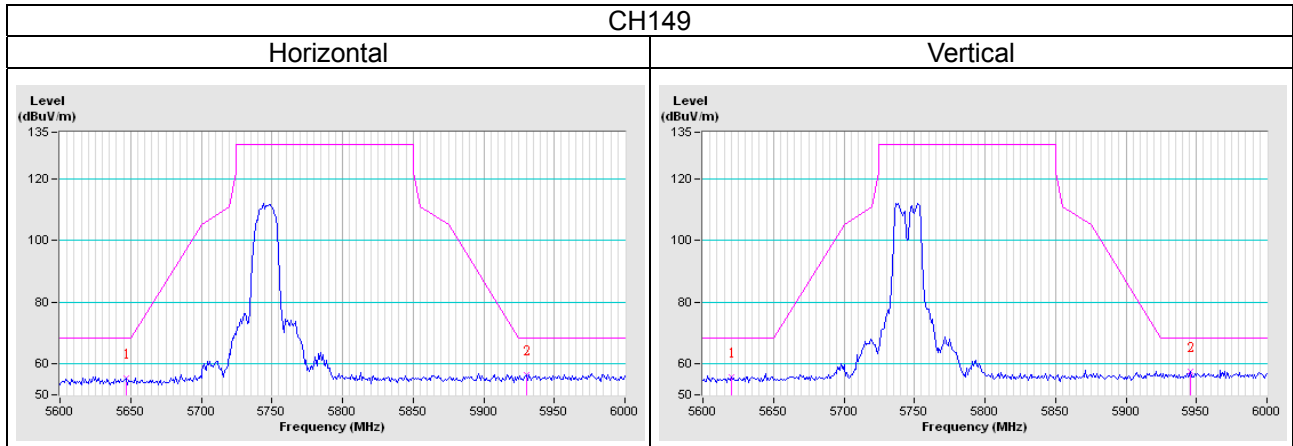

ML-2452-PNL6M4-N36 Ant. + ML-2499-HPA8-01 Ant.

802.11n (HT20)

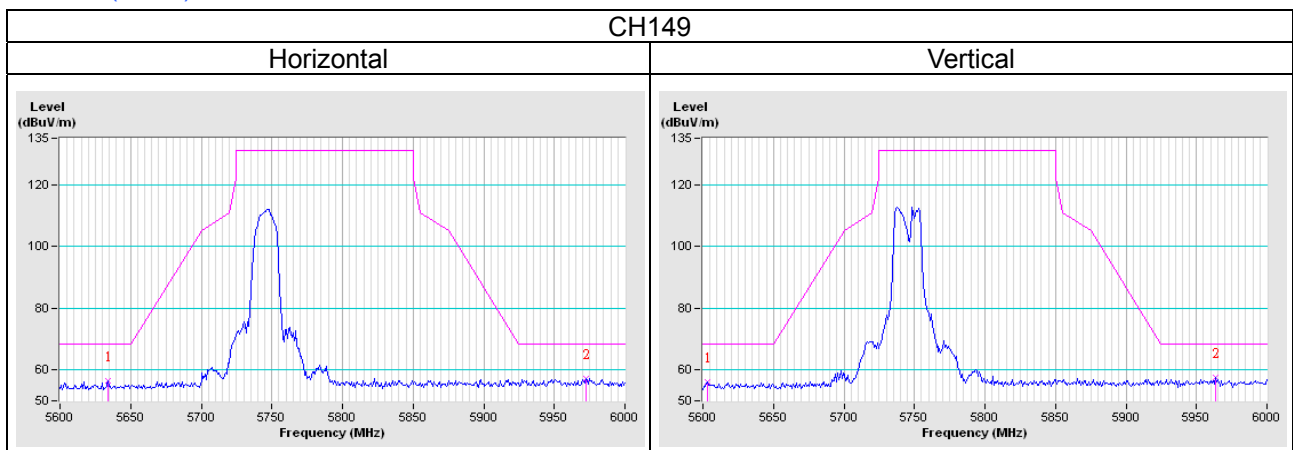

ML-2452-PNL6M4-N36 Ant. + ML-2452-PNA7-01R Ant.

802.11n (HT20)

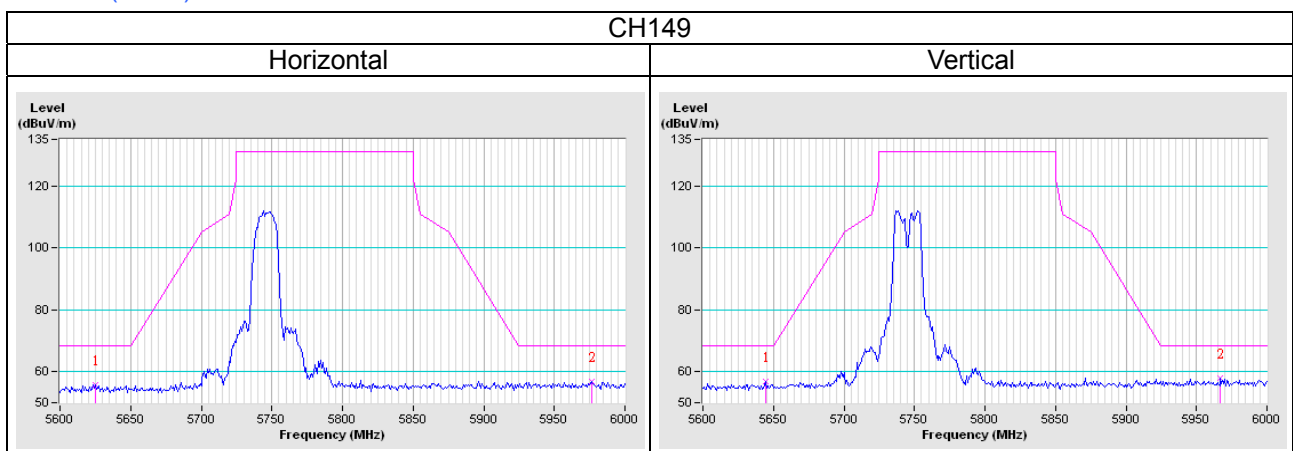

ML-2452-PNL6M4-N36 Ant. + ML-2452-PNA7-01R Ant.

802.11n (HT20)

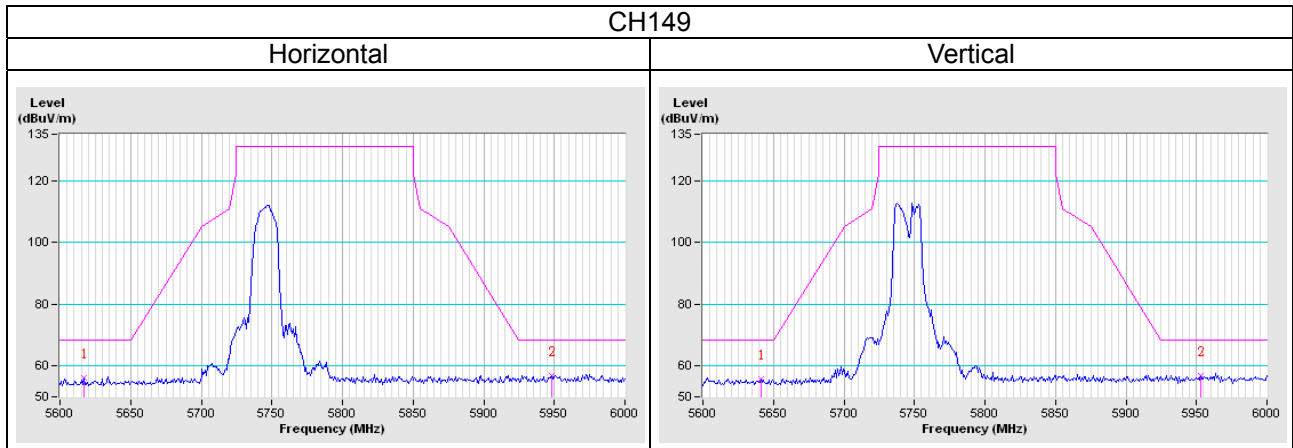

ML-2452-PNL9M3-N36 Ant. + ML-2499-HPA8-01 Ant.

802.11n (HT20)

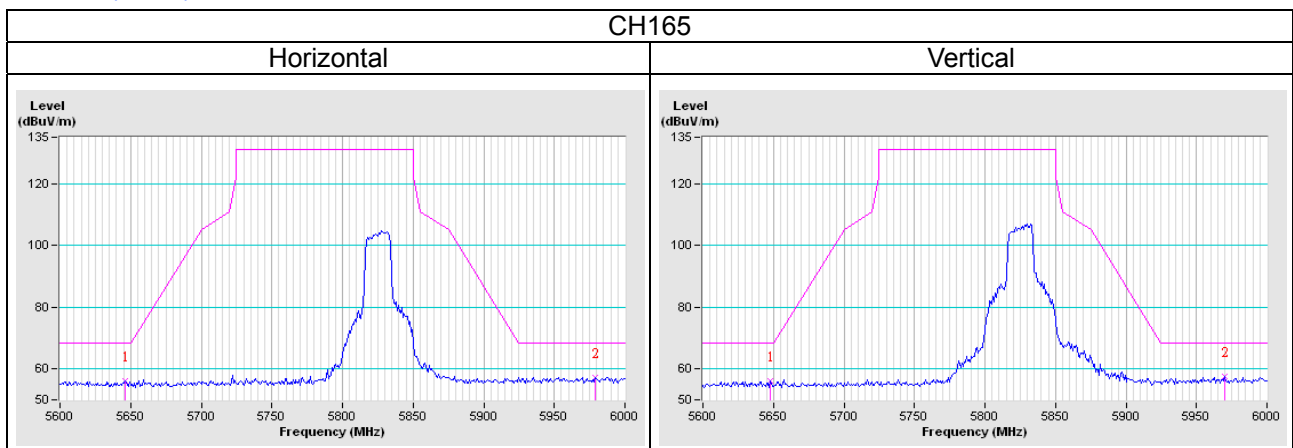

ML-2452-PNL9M3-N36 Ant. + ML-2499-HPA8-01 Ant.

802.11n (HT20)

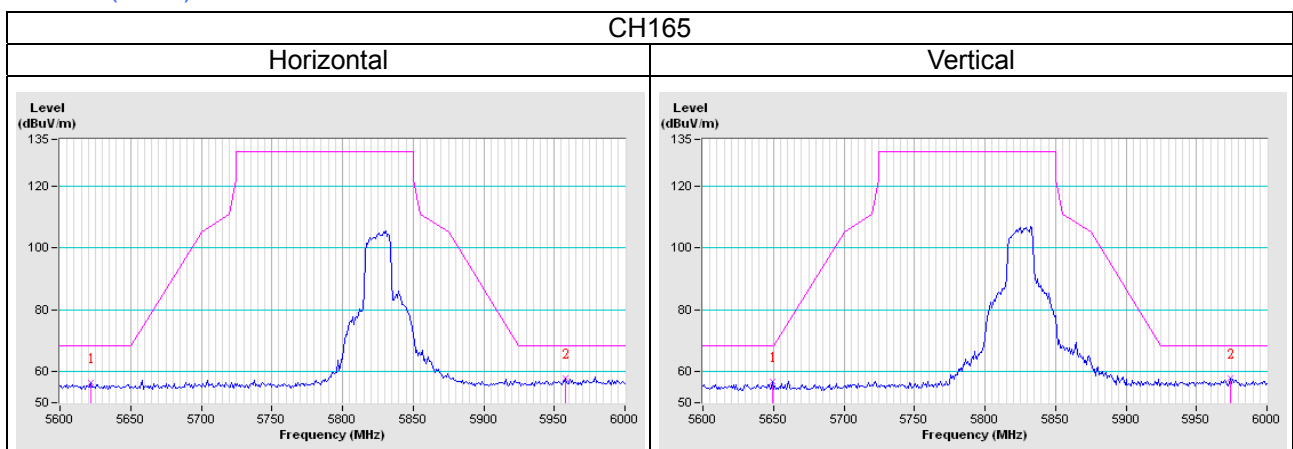

ML-2452-PNL6M4-N36 Ant. + ML-2452-PNA7-01R Ant.

802.11n (HT20)

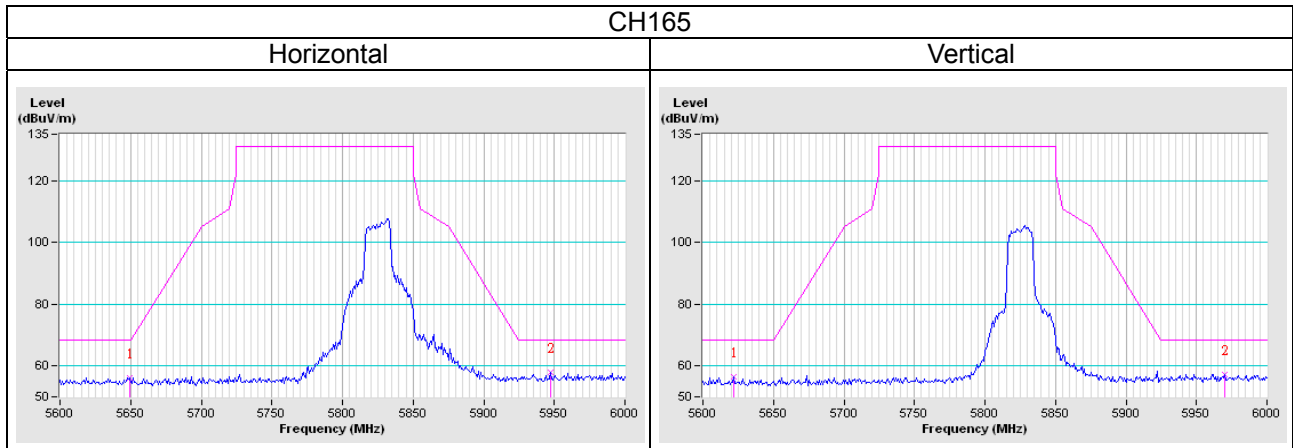

ML-2452-PNL6M4-N36 Ant. + ML-2452-PNA7-01R Ant.

802.11n (HT20)

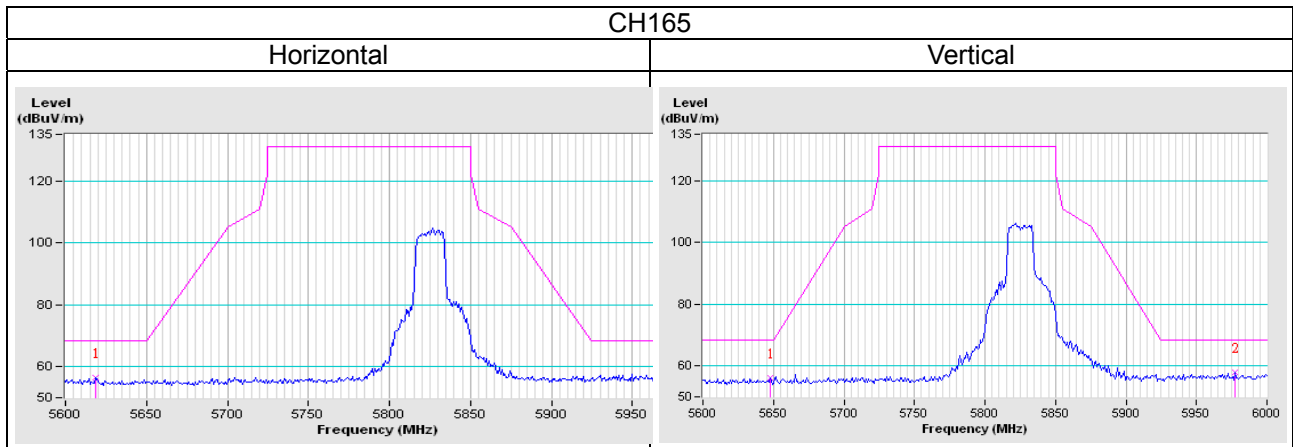

Appendix – Information on the Testing Laboratories

We, Bureau Veritas Consumer Products Services (H.K.) Ltd., Taoyuan Branch, were founded in 1988 to provide our best service in EMC, Radio, Telecom and Safety consultation. Our laboratories are FCC recognized accredited test firms and accredited and approved according to ISO/IEC 17025.

If you have any comments, please feel free to contact us at the following:

Linko EMC/RF Lab

Tel: 886-2-26052180

Fax: 886-2-26051924

Hsin Chu EMC/RF/Telecom Lab

Tel: 886-3-6668565

Fax: 886-3-6668323

Hwa Ya EMC/RF/Safety Lab

Tel: 886-3-3183232

Fax: 886-3-3270892

Email: service.adt@tw.bureauveritas.com

Web Site: www.bureauveritas-adt.com

The address and road map of all our labs can be found in our web site also.

--- END ---