



FCC DFS Test Report

Equipment : 802.11a/b/g/n/ac AP
Brand Name : MOJO
Model No. : C-130
FCC ID : TOR-C130
Standard : 47 CFR FCC Part 15.407
Frequency Range : 5250 MHz – 5350 MHz
5470 MHz – 5725 MHz
Applicant : Mojo Networks, Inc.
339 N. Bernardo Avenue, Suite #200 Mountain View, CA
94043 United States
Manufacturer : Mojo Networks, Inc.
339 N. Bernardo Avenue, Suite #200 Mountain View, CA
94043 United States
Operate Mode : Master and Client without radar detection

The product sample received on Apr. 13, 2016 and completely tested on May 05, 2017. We, SPORTON, would like to declare that the tested sample has been evaluated in accordance with the procedures given in FCC KDB 905462 D02 UNII DFS Compliance Procedures New Rules v02 and shown compliance with the applicable technical standards.

The test results in this report apply exclusively to the tested model / sample. Without written approval of SPORTON INTERNATIONAL INC., the test report shall not be reproduced except in full.

Cliff Chang
SPORTON INTERNATIONAL INC.





Table of Contents

1	GENERAL DESCRIPTION	5
1.1	Information.....	5
1.2	Accessories	15
1.3	Support Equipment.....	15
1.4	Testing Applied Standards	15
1.5	Testing Location Information	16
2	TEST CONFIGURATION OF EUT	17
2.1	Test Channel Frequencies Configuration.....	17
2.2	The Worst Case Measurement Configuration.....	17
3	DYNAMIC FREQUENCY SELECTION (DFS) TEST RESULT	18
3.1	General DFS Information	18
3.2	Radar Test Waveform Calibration	21
3.3	UNII Detection Bandwidth	33
3.4	Channel Availability Check (CAC).....	39
3.5	In-service Monitoring.....	43
3.6	Statistical Performance Check	51
4	TEST EQUIPMENT AND CALIBRATION DATA	172
5	MEASUREMENT UNCERTAINTY	173
	APPENDIX A. TEST PHOTOS	A1 ~ A3



Summary of Test Result

Conformance Test Specifications				
Report Clause	Ref. Std. Clause	Description	Limit	Result
3.3	FCC KDB 905462 7.8.1	DFS: UNII Detection Bandwidth Measurement	100% of the 99% BW	Complied
3.4	FCC KDB 905462 7.8.2.1	DFS: Initial Channel Availability Check Time	CAC ≥ 60 sec	Complied
3.4	FCC KDB 905462 7.8.2.2	DFS: Radar Burst at the Beginning of the Channel Availability Check Time	Detection Threshold: -63 dBm	Complied
3.4	FCC KDB 905462 7.8.2.3	DFS: Radar Burst at the End of the Channel Availability Check Time	Detection Threshold: -63 dBm	Complied
3.5	FCC KDB 905462 7.8.3	DFS: In-Service Monitoring for Channel Move Time (CMT)	CMT ≤ 10sec	Complied
3.5	FCC KDB 905462 7.8.3	DFS: In-Service Monitoring for Channel Closing Transmission Time (CCTT)	CCTT ≤ 60 ms starting at CMT 200ms	Complied
3.5	FCC KDB 905462 7.8.3	DFS: In-Service Monitoring for Non-Occupancy Period (NOP)	NOP ≥ 30 min	Complied
3.6	FCC KDB 905462 7.8.4	DFS: Statistical Performance Check	Table 5 - 7 (KDB 905462)	Complied
3.1.4	FCC KDB 905462 8.1	User Access Restrictions	DFS controls	Complied

Note: Since the product is client without radar detection function, only Channel Move Time, Channel Closing Transmission Time and Non-Occupancy Period are required to perform.



1 General Description

1.1 Information

1.1.1 RF General Information

Specification Items	Description
Product Type	For rado 2- WLAN (4TX, 4RX) For rado 3- WLAN (2TX, 2RX)
Radio Type	Intentional Transceiver
Power Type	From power adapter or PoE
Modulation	IEEE 802.11a: OFDM (BPSK / QPSK / 16QAM / 64QAM) IEEE 802.11n/ac: see the below table
Data Rate (Mbps)	IEEE 802.11a: OFDM (6/9/12/18/24/36/48/54) IEEE 802.11n/ac: see the below table
Channel Bandwidth	20/40/80 MHz operating channel bandwidth
Operating Mode	<input checked="" type="checkbox"/> Master
	<input type="checkbox"/> Client with radar detection
	<input checked="" type="checkbox"/> Client without radar detection
Communication Mode	<input checked="" type="checkbox"/> IP Based (Load Based) <input type="checkbox"/> Frame Based
TPC Function	<input checked="" type="checkbox"/> With TPC <input type="checkbox"/> Without TPC
Weather Band (5600~5650MHz)	<input checked="" type="checkbox"/> With 5600~5650MHz <input type="checkbox"/> Without 5600~5650MHz



Max. Con. Power (DFS band)	<p>For radio 2</p> <p><For Non-Beamforming Mode></p> <p>Band 2:</p> <p>IEEE 802.11a: 18.54 dBm</p> <p>IEEE 802.11ac MCS0/Nss1 (VHT20): 18.40 dBm</p> <p>IEEE 802.11ac MCS0/Nss1 (VHT40): 21.50 dBm</p> <p>IEEE 802.11ac MCS0/Nss1 (VHT80): 19.54 dBm</p> <p>IEEE 802.11ac MCS0/Nss2 (VHT80+80): 21.23 dBm</p> <p>Band 3:</p> <p>IEEE 802.11a: 18.41 dBm</p> <p>IEEE 802.11ac MCS0/Nss1 (VHT20): 18.40 dBm</p> <p>IEEE 802.11ac MCS0/Nss1 (VHT40): 21.45 dBm</p> <p>IEEE 802.11ac MCS0/Nss1 (VHT80): 23.66 dBm</p> <p>IEEE 802.11ac MCS0/Nss2 (VHT80+80): 23.62 dBm</p> <p><For Beamforming Mode></p> <p>Band 2:</p> <p>IEEE 802.11ac MCS0/Nss1 (VHT20): 18.27 dBm</p> <p>IEEE 802.11ac MCS0/Nss1 (VHT40): 18.13 dBm</p> <p>IEEE 802.11ac MCS0/Nss1 (VHT80): 18.17 dBm</p> <p>IEEE 802.11ac MCS0/Nss2 (VHT80+80): 18.01 dBm</p> <p>Band 3:</p> <p>IEEE 802.11ac MCS0/Nss1 (VHT20): 18.11 dBm</p> <p>IEEE 802.11ac MCS0/Nss1 (VHT40): 18.27 dBm</p> <p>IEEE 802.11ac MCS0/Nss1 (VHT80): 18.19 dBm</p> <p>IEEE 802.11ac MCS0/Nss2 (VHT80+80): 21.25 dBm</p> <p>For radio 3</p> <p>Band 2:</p> <p>IEEE 802.11a: 21.15 dBm</p> <p>IEEE 802.11ac MCS0/Nss1 (VHT20): 21.12 dBm</p> <p>IEEE 802.11ac MCS0/Nss1 (VHT40): 23.83 dBm</p> <p>IEEE 802.11ac MCS0/Nss1 (VHT80): 18.02 dBm</p> <p>Band 3:</p> <p>IEEE 802.11a: 21.04 dBm</p> <p>IEEE 802.11ac MCS0/Nss1 (VHT20): 21.02 dBm</p> <p>IEEE 802.11ac MCS0/Nss1 (VHT40): 23.95 dBm</p> <p>IEEE 802.11ac MCS0/Nss1 (VHT80): 21.08 dBm</p>
-----------------------------------	---



Min. Con. Power (DFS band)	<p>For radio 2</p> <p><For Non-Beamforming Mode></p> <p>Band 2:</p> <p>IEEE 802.11a: 12.54 dBm</p> <p>IEEE 802.11ac MCS0/Nss1 (VHT20): 12.40 dBm</p> <p>IEEE 802.11ac MCS0/Nss1 (VHT40): 15.50 dBm</p> <p>IEEE 802.11ac MCS0/Nss1 (VHT80): 13.54 dBm</p> <p>IEEE 802.11ac MCS0/Nss2 (VHT80+80): 15.23 dBm</p> <p>Band 3:</p> <p>IEEE 802.11a: 12.41 dBm</p> <p>IEEE 802.11ac MCS0/Nss1 (VHT20): 12.40 dBm</p> <p>IEEE 802.11ac MCS0/Nss1 (VHT40): 15.45 dBm</p> <p>IEEE 802.11ac MCS0/Nss1 (VHT80): 17.66 dBm</p> <p>IEEE 802.11ac MCS0/Nss2 (VHT80+80): 17.62 dBm</p> <p><For Beamforming Mode></p> <p>Band 2:</p> <p>IEEE 802.11ac MCS0/Nss1 (VHT20): 12.27 dBm</p> <p>IEEE 802.11ac MCS0/Nss1 (VHT40): 12.13 dBm</p> <p>IEEE 802.11ac MCS0/Nss1 (VHT80): 12.17 dBm</p> <p>IEEE 802.11ac MCS0/Nss2 (VHT80+80): 12.01 dBm</p> <p>Band 3:</p> <p>IEEE 802.11ac MCS0/Nss1 (VHT20): 12.11 dBm</p> <p>IEEE 802.11ac MCS0/Nss1 (VHT40): 12.27 dBm</p> <p>IEEE 802.11ac MCS0/Nss1 (VHT80): 12.19 dBm</p> <p>IEEE 802.11ac MCS0/Nss2 (VHT80+80): 15.25 dBm</p> <p>For radio 3</p> <p>Band 2:</p> <p>IEEE 802.11a: 15.15 dBm</p> <p>IEEE 802.11ac MCS0/Nss1 (VHT20): 15.12 dBm</p> <p>IEEE 802.11ac MCS0/Nss1 (VHT40): 17.83 dBm</p> <p>IEEE 802.11ac MCS0/Nss1 (VHT80): 12.02 dBm</p> <p>Band 3:</p> <p>IEEE 802.11a: 15.04 dBm</p> <p>IEEE 802.11ac MCS0/Nss1 (VHT20): 15.02 dBm</p> <p>IEEE 802.11ac MCS0/Nss1 (VHT40): 17.95 dBm</p> <p>IEEE 802.11ac MCS0/Nss1 (VHT80): 15.08 dBm</p>
-----------------------------------	---



Max. EIRP Power (DFS band)	<p>For radio 2</p> <p><For Non-Beamforming Mode></p> <p>Band 2:</p> <p>IEEE 802.11a: 24.25 dBm</p> <p>IEEE 802.11ac MCS0/Nss1 (VHT20): 24.11 dBm</p> <p>IEEE 802.11ac MCS0/Nss1 (VHT40): 27.21 dBm</p> <p>IEEE 802.11ac MCS0/Nss1 (VHT80): 25.25 dBm</p> <p>IEEE 802.11ac MCS0/Nss2 (VHT80+80): 26.94 dBm</p> <p>Band 3:</p> <p>IEEE 802.11a: 24.12 dBm</p> <p>IEEE 802.11ac MCS0/Nss1 (VHT20): 24.11 dBm</p> <p>IEEE 802.11ac MCS0/Nss1 (VHT40): 27.16 dBm</p> <p>IEEE 802.11ac MCS0/Nss1 (VHT80): 29.37 dBm</p> <p>IEEE 802.11ac MCS0/Nss2 (VHT80+80): 29.33 dBm</p> <p><For Beamforming Mode></p> <p>Band 2:</p> <p>IEEE 802.11ac MCS0/Nss1 (VHT20): 29.97 dBm</p> <p>IEEE 802.11ac MCS0/Nss1 (VHT40): 29.83 dBm</p> <p>IEEE 802.11ac MCS0/Nss1 (VHT80): 29.87 dBm</p> <p>IEEE 802.11ac MCS0/Nss2 (VHT80+80): 26.70 dBm</p> <p>Band 3:</p> <p>IEEE 802.11ac MCS0/Nss1 (VHT20): 29.81 dBm</p> <p>IEEE 802.11ac MCS0/Nss1 (VHT40): 29.97 dBm</p> <p>IEEE 802.11ac MCS0/Nss1 (VHT80): 29.89 dBm</p> <p>IEEE 802.11ac MCS0/Nss2 (VHT80+80): 29.94 dBm</p> <p>For radio 3</p> <p>Band 2:</p> <p>IEEE 802.11a: 26.92 dBm</p> <p>IEEE 802.11ac MCS0/Nss1 (VHT20): 26.89 dBm</p> <p>IEEE 802.11ac MCS0/Nss1 (VHT40): 29.60 dBm</p> <p>IEEE 802.11ac MCS0/Nss1 (VHT80): 23.79 dBm</p> <p>Band 3:</p> <p>IEEE 802.11a: 26.81 dBm</p> <p>IEEE 802.11ac MCS0/Nss1 (VHT20): 26.79 dBm</p> <p>IEEE 802.11ac MCS0/Nss1 (VHT40): 29.72 dBm</p> <p>IEEE 802.11ac MCS0/Nss1 (VHT80): 26.85 dBm</p>
-----------------------------------	---



<p>Min. EIRP Power (DFS band)</p>	<p>For radio 2</p> <p><For Non-Beamforming Mode></p> <p>Band 2:</p> <p>IEEE 802.11a: 18.25 dBm</p> <p>IEEE 802.11ac MCS0/Nss1 (VHT20): 18.11 dBm</p> <p>IEEE 802.11ac MCS0/Nss1 (VHT40): 21.21 dBm</p> <p>IEEE 802.11ac MCS0/Nss1 (VHT80): 19.25 dBm</p> <p>IEEE 802.11ac MCS0/Nss2 (VHT80+80): 20.94 dBm</p> <p>Band 3:</p> <p>IEEE 802.11a: 18.12 dBm</p> <p>IEEE 802.11ac MCS0/Nss1 (VHT20): 18.11 dBm</p> <p>IEEE 802.11ac MCS0/Nss1 (VHT40): 21.16 dBm</p> <p>IEEE 802.11ac MCS0/Nss1 (VHT80): 23.37 dBm</p> <p>IEEE 802.11ac MCS0/Nss2 (VHT80+80): 23.33 dBm</p> <p><For Beamforming Mode></p> <p>Band 2:</p> <p>IEEE 802.11ac MCS0/Nss1 (VHT20): 23.97 dBm</p> <p>IEEE 802.11ac MCS0/Nss1 (VHT40): 23.83 dBm</p> <p>IEEE 802.11ac MCS0/Nss1 (VHT80): 23.87 dBm</p> <p>IEEE 802.11ac MCS0/Nss2 (VHT80+80): 20.70 dBm</p> <p>Band 3:</p> <p>IEEE 802.11ac MCS0/Nss1 (VHT20): 23.81 dBm</p> <p>IEEE 802.11ac MCS0/Nss1 (VHT40): 23.97 dBm</p> <p>IEEE 802.11ac MCS0/Nss1 (VHT80): 23.89 dBm</p> <p>IEEE 802.11ac MCS0/Nss2 (VHT80+80): 23.94 dBm</p> <p>For radio 3</p> <p>Band 2:</p> <p>IEEE 802.11a: 20.92 dBm</p> <p>IEEE 802.11ac MCS0/Nss1 (VHT20): 20.89 dBm</p> <p>IEEE 802.11ac MCS0/Nss1 (VHT40): 23.60 dBm</p> <p>IEEE 802.11ac MCS0/Nss1 (VHT80): 17.79 dBm</p> <p>Band 3:</p> <p>IEEE 802.11a: 20.81 dBm</p> <p>IEEE 802.11ac MCS0/Nss1 (VHT20): 20.79 dBm</p> <p>IEEE 802.11ac MCS0/Nss1 (VHT40): 23.72 dBm</p> <p>IEEE 802.11ac MCS0/Nss1 (VHT80): 20.85 dBm</p>
-----------------------------------	---



Power-on cycle	For Master power-on cycle. 80MHz: Requires 140.1 seconds to complete its power-on cycle. For Client without radar detection N/A (No Channel Availability Check Function)
Software / Firmware Version	8.1
Note: EUT employ a TPC mechanism and TPC have the capability to operate at least 6 dB below highest RF output power.	

Note: The product has beamforming function for 802.11n/ac in 2.4GHz and 5GHz for Radio 1 / Radio 2.

Antenna & Band width

Antenna	Two (TX)			Four (TX)		
	20 MHz	40 MHz	80 MHz	20 MHz	40 MHz	80 MHz
Band width Mode						
IEEE 802.11a	V	X	X	V	X	X
IEEE 802.11n	V	V	X	V	V	X
IEEE 802.11ac	V	V	V	V	V	V

IEEE 11n/ac Spec.

Radio	Protocol	Number of Transmit Chains (NTX)	Data Rate / MCS
Radio 2	802.11n (HT20)	4	MCS0-31
Radio 2	802.11n (HT40)	4	MCS0-31
Radio 2	802.11ac (VHT20)	4	MCS 0-9/Nss1-4
Radio 2	802.11ac (VHT40)	4	MCS 0-9/Nss1-4
Radio 2	802.11ac (VHT80)	4	MCS 0-9/Nss1-4
Radio 3	802.11n (HT20)	2	MCS0-15
Radio 3	802.11n (HT40)	2	MCS0-15
Radio 3	802.11ac (VHT20)	2	MCS 0-9/Nss1-2
Radio 3	802.11ac (VHT40)	2	MCS 0-9/Nss1-2
Radio 3	802.11ac (VHT80)	2	MCS 0-9/Nss1-2

Note 1: IEEE Std. 802.11n modulation consists of HT20 and HT40 (HT: High Throughput). Then EUT support HT20 and HT40.
 Note 2: IEEE Std. 802.11ac modulation consists of VHT20, VHT40, VHT80 and VHT160 (VHT: Very High Throughput). Then EUT support VHT20, VHT40 and VHT80.
 Note 3: Modulation modes consist of below configuration:
 HT20/HT40: IEEE 802.11n, VHT20/VHT40/VHT80: IEEE 802.11ac

1.1.2 Antenna Information

Ant.	Brand	Model Name	Antenna Type	Connector	Gain (dBi)	
					2.4GHz	5GHz
1	WNC	95XKAA15.GBV	PIFA Antenna	I-PEX	4.64	-
2	WNC	95XKAA15.GBW	PIFA Antenna	I-PEX	4.56	-
3	WNC	95XKAA15.GBX	PIFA Antenna	I-PEX	4.47	-
4	WNC	95XKAA15.GBY	PIFA Antenna	I-PEX	4.82	-
5	WNC	95XKAA15.GBZ	PIFA Antenna	I-PEX	-	5.71
6	WNC	95XKAA15.GB1	PIFA Antenna	I-PEX	-	5.64
7	WNC	95XKAA15.GB2	PIFA Antenna	I-PEX	-	5.67
8	WNC	95XKAA15.GB3	PIFA Antenna	I-PEX	-	5.68
9	WNC	95XKAA15.GAI	PIFA Antenna	I-PEX	4.20	5.77
10	WNC	95XKAA15.GAH	PIFA Antenna	I-PEX	4.64	5.75

Note 1: The EUT has ten antennas.

Note 2: The EUT has three radios, Radio 1 supports WLAN 2.4GHz, Radio 2 supports WLAN 5GHz and Radio 3 supports WLAN 2.4GHz + 5GHz (scanning radio) function.

For radio 1

For 2.4GHz WLAN function:

For IEEE 802.11b/g/n/ac mode (4TX/4RX)

Chain 1, Chain 2, Chain 3 and Chain 4 can be used as transmitting/receiving antenna.

Chain 1, Chain 2, Chain 3 and Chain 4 could transmit/receive simultaneously.

For radio 2

For 5GHz WLAN function:

For IEEE 802.11a/n/ac mode (4TX/4RX)

Chain 5, Chain 6, Chain 7 and Chain 8 can be used as transmitting/receiving antenna.

Chain 5, Chain 6, Chain 7 and Chain 8 could transmit/receive simultaneously.

For radio 3

For 2.4GHz / 5GHz WLAN function:

For IEEE 802.11a/b/g/n/ac mode (2TX/2RX)

Chain 9 and Chain 10 can be used as transmitting/receiving antenna.

Chain 9 and Chain 10 could transmit/receive simultaneously.

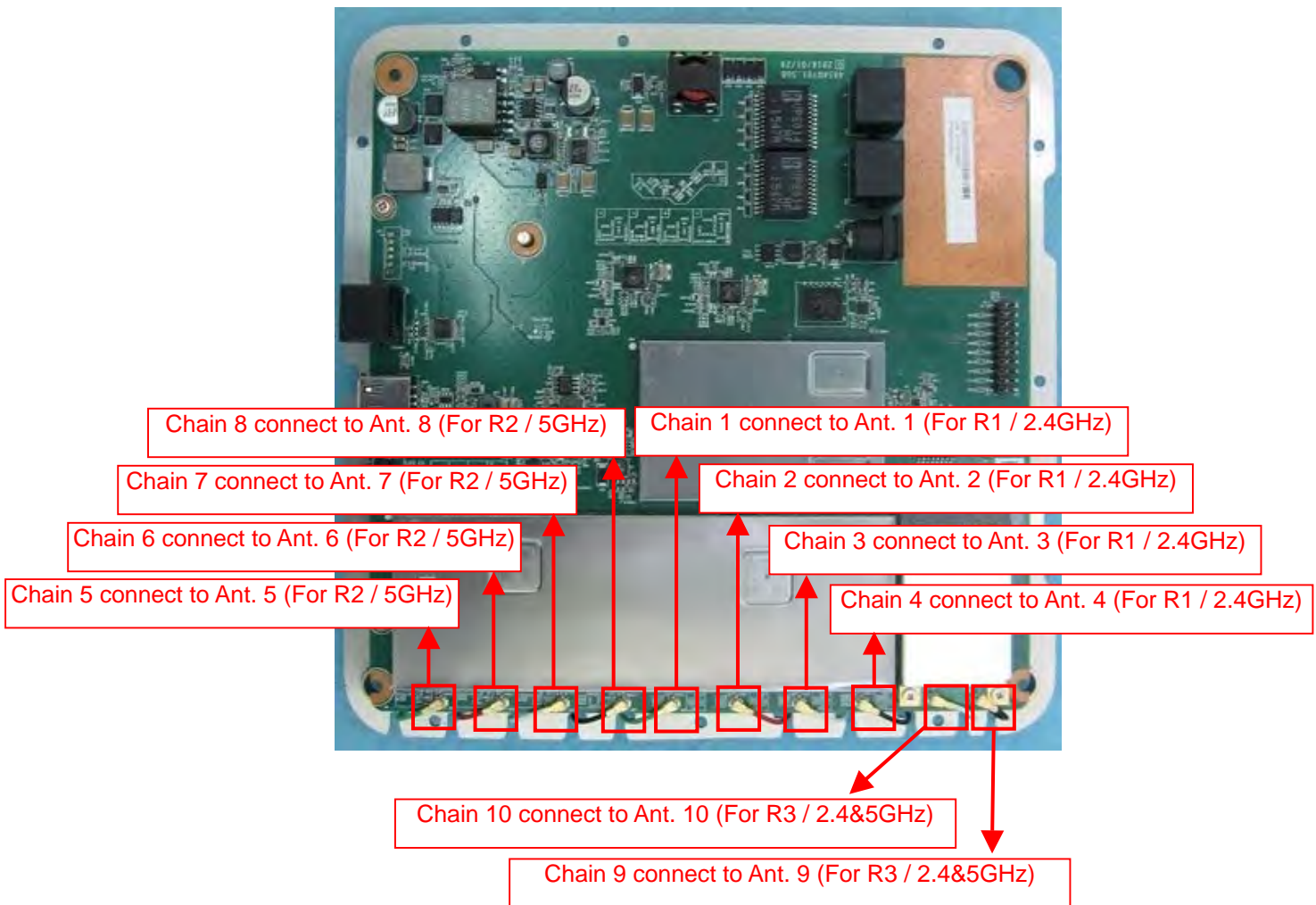



1.1.3 DFS Band Carrier Frequencies

There are three bandwidth systems.

For 20MHz bandwidth systems, use Channel 52, 56, 60, 64, 100, 104, 108, 112, 116, 120, 124, 128, 132, 136, 140, 144.

For 40MHz bandwidth systems, use Channel 54, 62, 102, 110, 118, 126, 134, 142.

For 80MHz bandwidth systems, use Channel 58, 106, 122, 138.

Frequency Band	Channel No.	Frequency	Channel No.	Frequency
5250~5350 MHz Band 2	52	5260 MHz	60	5300 MHz
	54	5270 MHz	62	5310 MHz
	56	5280 MHz	64	5320 MHz
	58	5290 MHz	-	-
5470~5725 MHz Band 3	100	5500 MHz	124	5620 MHz
	102	5510 MHz	126	5630 MHz
	104	5520 MHz	128	5640 MHz
	106	5530 MHz	132	5660 MHz
	108	5540 MHz	134	5670 MHz
	110	5550 MHz	136	5680 MHz
	112	5560 MHz	138	5690 MHz
	116	5580 MHz	140	5700 MHz
	118	5590 MHz	142	5710 MHz
	120	5600 MHz	144	5720 MHz
	122	5610 MHz	-	-

Note: Only radio 2 supports straddle channel.



1.1.4 Table for 80+80 MHz Mode

Type	Channel No.	Frequency
1	42+106	5210+5530 MHz
2	42+122	5210+5610 MHz
3	42+138	5210+5690 MHz
4	58+106	5290+5530 MHz
5	58+122	5290+5610 MHz
6	58+138	5290+5690 MHz
7	58+155	5290+5775 MHz
8	106+138	5530+5690 MHz
9	106+155	5530+5775 MHz
10	122+155	5610+5775 MHz
11	138+155	5690+5775 MHz

Note: Only radio 2 supports 80+80MHz mode.

1.1.5 Table for Class II Change

This product is an extension of original one reported under Sporton project number: 641226-02

Below is the table for the change of the product with respect to the original one.

Description	Performance Checking
1. Add 5GHz B2 and B3 (5250~5350 MHz, 5470~5725 MHz) for this device.	All items test
2. Add eleven sets 80+80 Mode also includes the 5150 ~ 5250 MHz and 5725 ~ 5850 MHz	1. UNII Detection Bandwidth 2. Statistical Performance Check



1.2 Accessories

Accessories				
No.	Equipment Name	Brand Name	Model Name	Rating
1	AC Adapter (Switchable Adapter)	APD	WA-24Q12R	INPUT: 100-240V~,50-60Hz, 0.7A Max OUTPUT: 12V, 2A
Others				
RJ-45 cable, Non-shielded, 1m				
US Plug*1				

1.3 Support Equipment

For Master

Support Equipment				
No.	Equipment	Brand Name	Model Name	FCC ID
1	Notebook	DELL	E4300	DoC
2	Notebook	DELL	E4300	DoC
3	802.11a/b/g/n/ac AP	MOJO	C-120	TOR-C120
4	WLAN AP	NETGEAR	WNDR3300v2	PY309300116

For Client without radar detection

Support Equipment				
No.	Equipment	Brand Name	Model Name	FCC ID
1	Notebook	DELL	E4300	DoC
2	Notebook	DELL	E4300	DoC
3	WLAN AP	NETGEAR	R7500	PY314300288
4	WLAN AP	NETGEAR	WNDR3300v2	PY309300116

1.4 Testing Applied Standards

According to the specifications of the manufacturer, the EUT must comply with the requirements of the following standards:

- ♦ FCC KDB 905462 D02 UNII DFS Compliance Procedures New Rules v02



1.5 Testing Location Information

Testing Location				
<input type="checkbox"/>	HWA YA	ADD : No. 52, Hwa Ya 1st Rd., Kwei-Shan Hsiang, Tao Yuan Hsien, Taiwan, R.O.C. TEL : 886-3-327-3456 FAX : 886-3-327-0973		
<input checked="" type="checkbox"/>	JHUBEI	ADD : No.8, Lane 724, Bo-ai St., Jhubei City, HsinChu County 302, Taiwan, R.O.C. TEL : 886-3-656-9065 FAX : 886-3-656-9085		
Test Condition	Test Site No.	Test Engineer	Test Environment	Test Date
DFS Site	DF01-CB (For Master)	Benson Su	23.9°C / 67%	07-Apr-17 ~ 22-Apr-17
	DF01-CB (For Client without radar detection)	DK Chang	20.6°C / 62%	05-May-17

Test site Designation No. TW0006 with FCC
Test site registered number IC 4086D with Industry Canada.

2 Test Configuration of EUT

2.1 Test Channel Frequencies Configuration

For Master

Test Channel Frequencies Configuration	
IEEE Std.	Test Channel Freq. (MHz)
802.11ac (VHT20)	5500 MHz
802.11ac (VHT40)	5510 MHz
802.11ac (VHT80)	5530 MHz

IEEE Std.	Type	Channel No.	Frequency
802.11ac (VHT80+80)	4	58+106	5290+5530 MHz

For Client without radar detection

Test Channel Frequencies Configuration	
IEEE Std.	Test Channel Freq. (MHz)
802.11ac (VHT80)	5530 MHz

2.2 The Worst Case Measurement Configuration

The Worst Case Mode for Following Conformance Tests	
Tests Item	Dynamic Frequency Selection (DFS)
Test Condition	Radiated measurement The EUT shall be configured to operate at the highest transmitter output power setting. If more than one antenna assembly is intended for this power setting, the gain of the antenna assembly with the lowest gain shall be used. The DFS radar test signals have been aligned to the direction corresponding to the EUT's maximum antenna gain.
Modulation Mode	For Master 802.11ac (VHT20), 802.11ac (VHT40), 802.11ac (VHT80), 802.11ac (VHT80+80) For Client without radar detection 802.11ac (VHT80)



3 Dynamic Frequency Selection (DFS) Test Result

3.1 General DFS Information

3.1.1 DFS Parameters

Parameter	Value
Non-occupancy period	Minimum 30 minutes
Channel Availability Check Time	60 seconds
Channel Move Time	10 seconds (Note 1).
Channel Closing Transmission Time	200 milliseconds + an aggregate of 60 milliseconds over remaining 10 second periods. (Notes 1 and 2).
U-NII Detection Bandwidth	Minimum 100% of the 99% power bandwidth (Note 3).

Note 1: Channel Move Time and the Channel Closing Transmission Time should be performed with Radar Type 0. The measurement timing begins at the end of the Radar Type 0 burst.

Note 2: The Channel Closing Transmission Time is comprised of 200 milliseconds starting at the beginning of the Channel Move Time plus any additional intermittent control signals required to facilitate Channel changes (an aggregate of 60 milliseconds) during the remainder of the 10 second period. The aggregate duration of control signals will not count quiet periods in between transmissions.

Note 3: During the U-NII Detection Bandwidth detection test, radar type 0 is used and for each frequency step the minimum percentage of detection is 90%. Measurements are performed with no data traffic.

Maximum Transmit Power	Value (see note)
EIRP \geq 200 mW	-64 dBm
EIRP < 200 mW and PSD < 10dBm/MHz	-62 dBm
EIRP < 200 mW and PSD \geq 10dBm/MHz	-64 dBm

Note 1: This is the level at the input of the receiver assuming a 0 dBi receive antenna.

Note 2: Throughout these test procedures an additional 1 dB has been added to the amplitude of the test transmission waveforms to account for variations in measurement equipment. This will ensure that the test signal is at or above the detection threshold level to trigger a DFS response.

Note3: EIRP is based on the highest antenna gain. For MIMO devices refer to KDB Publication 662911D01.



3.1.2 Applicability of DFS Requirements Prior to Use of a Channel

Requirement	DFS Operational mode		
	Master	Client without radar detection	Client with radar detection
<i>Non-Occupancy Period</i>	Yes	Not required	Yes
<i>DFS Detection Threshold</i>	Yes	Not required	Yes
<i>Channel Availability Check Time</i>	Yes	Not required	Not required
<i>U-NII Detection Bandwidth</i>	Yes	Not required	Yes

3.1.3 Applicability of DFS Requirements during Normal Operation

Requirement	DFS Operational mode		
	Master	Client without radar detection	Client with radar detection
<i>DFS Detection Threshold</i>	Yes	Not required	Yes
<i>Channel Closing Transmission Time</i>	Yes	Yes	Yes
<i>Channel Move Time</i>	Yes	Yes	Yes
<i>U-NII Detection Bandwidth</i>	Yes	Not required	Yes

Additional requirements for devices with multiple bandwidth modes	Master Device or Client with Radar Detection	Client Without Radar Detection
U-NII Detection Bandwidth and Statistical Performance Check	All BW modes must be tested	Not required
Channel Move Time and Channel Closing Transmission Time	Test using widest BW mode available	Test using the widest BW mode available for the link
All other tests	Any single BW mode	Not required

Note: Frequencies selected for statistical performance check (Section 7.8.4) should include several frequencies within the radar detection bandwidth and frequencies near the edge of the radar detection bandwidth. For 802.11 devices it is suggested to select frequencies in each of the bonded 20 MHz channels and the channel center frequency.



3.1.4 User Access Restrictions

User Access Restrictions	
<input checked="" type="checkbox"/>	DFS controls (hardware or software) related to radar detection are NOT accessible to the user. Manufacturer statement confirming that information regarding the parameters of the detected Radar Waveforms is not available to the end user.

3.1.5 Channel Loading/Data Streaming

<input type="checkbox"/>	The data file (MPEG-4) has been transmitting in a streaming mode.
<input checked="" type="checkbox"/>	Software to ping the client is permitted to simulate data transfer with random ping intervals.
<input checked="" type="checkbox"/>	Minimum channel loading of approximately 17%.
<input type="checkbox"/>	Unicast protocol has been used.

3.2 Radar Test Waveform Calibration

3.2.1 Short Pulse Radar Test Waveforms

Radar Type	Pulse Width (µsec)	PRI (µsec)	Number of Pulses	Minimum Percentage of Successful Detection	Minimum Trials
0	1	1428	18	See Note 1	See Note 1
1A	1	15 unique PRI in KDB 905462 D02 Table 5a	$\text{Roundup}\left\{\left(\frac{1}{360}\right) \times \left(\frac{19 \times 10^6}{PRI}\right)\right\}$	60%	15
1B	1	15 unique PRI within 518-3066, Excluding 1A PRI		60%	15
2	1-5	150-230	23-29	60%	30
3	6-10	200-500	16-18	60%	30
4	11-20	200-500	12-16	60%	30
Aggregate (Radar Types 1-4)				80%	120
Note 1: Short Pulse Radar Type 0 should be used for the detection bandwidth test, channel move time, and channel closing time tests.					

A minimum of 30 unique waveforms are required for each of the short pulse radar types 1 through 4. If more than 30 waveforms are used for short pulse radar types 1 through 4, then each additional waveform must also be unique and not repeated from the previous waveforms. The aggregate is the average of the percentage of successful detections of short pulse radar types 1-4.

3.2.2 Long Pulse Radar Test Waveform

Radar Type	Pulse Width (µsec)	Chirp Width (MHz)	PRI (µsec)	Number of Pulses per Burst	Number of Bursts	Minimum Percentage of Successful Detection	Minimum Trials
5	50-100	5-20	1000-2000	1-3	8-20	80%	30

Each waveform is defined as follows:

- ♦ The transmission period for the Long Pulse Radar test signal is 12 seconds.
- ♦ There are a total of 8 to 20 Bursts in the 12 second period, with the number of Bursts being randomly chosen. This number is Burst Count.
- ♦ Each Burst consists of 1 to 3 pulses, with the number of pulses being randomly chosen. Each Burst within the 12 second sequence may have a different number of pulses.
- ♦ The pulse width is between 50 and 100 microseconds, with the pulse width being randomly chosen. Each pulse within a Burst will have the same pulse width. Pulses in different Bursts may have different pulse widths.
- ♦ Each pulse has a linear FM chirp between 5 and 20 MHz, with the chirp width being randomly chosen. Each pulse within a transmission period will have the same chirp width. The chirp is centered on the pulse. For example, with a radar frequency of 5300 MHz and a 20 MHz chirped signal, the chirp starts at 5290 MHz and ends at 5310 MHz.
- ♦ If more than one pulse is present in a Burst, the time between the pulses will be between 1000 and 2000 microseconds, with the time being randomly chosen. If three pulses are present in a Burst, the time



between the first and second pulses is chosen independently of the time between the second and third pulses.

- The 12 second transmission period is divided into even intervals. The number of intervals is equal to Burst Count. Each interval is of length (12,000,000 / Burst Count) microseconds. Each interval contains one Burst. The start time for the Burst, relative to the beginning of the interval, is between 1 and [(12,000,000 / Burst Count) – (Total Burst Length) + (One Random PRI Interval)] microseconds, with the start time being randomly chosen. The step interval for the start time is 1 microsecond. The start time for each Burst is chosen independently.

3.2.3 Frequency Hopping Radar Test Waveform

Radar Type	Pulse Width (µsec)	PRI (µsec)	Pulses per Hop	Hopping Rate (kHz)	Hopping Sequence Length (ms)	Minimum Percentage of Successful Detection	Minimum Trials
6	1	333	9	0.333	300	70%	30

The FCC Type 6 waveform uses a static waveform with 100 bursts in the instruments ARB. In addition, the RF list mode is operated with a list containing 100 frequencies from a randomly generated list and it had be ensured that at least one of the random frequencies falls into the UNII Detection Bandwidth of the DUT. Each burst from the waveform file initiates a trigger pulse at the beginning that switches the RF list from one item to the next one.

3.2.4 DFS Threshold Level

DFS Threshold Level	
DFS Threshold level: -63 dBm	<input type="checkbox"/> at the antenna connector
	<input checked="" type="checkbox"/> in front of the antenna
The Interference Radar Detection Threshold Level is is $-64\text{ dBm} + 0\text{ [dBi]} + 1\text{ dB} = -63\text{ dBm}$. That had been taken into account the output power range and antenna gain.	

3.2.5 Calibration Setup

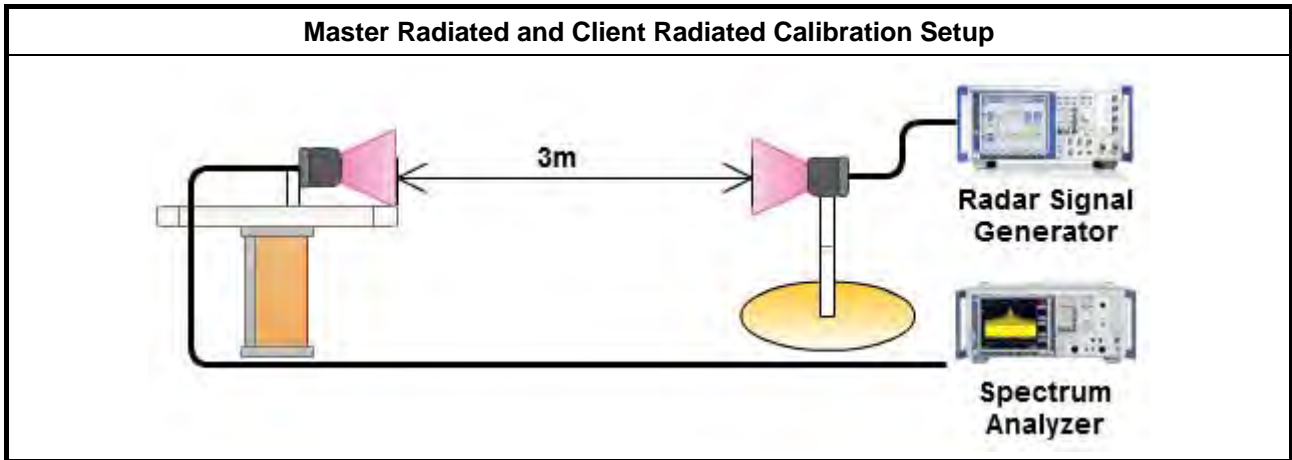



3.2.6 Radar Waveform calibration Plot

For Master

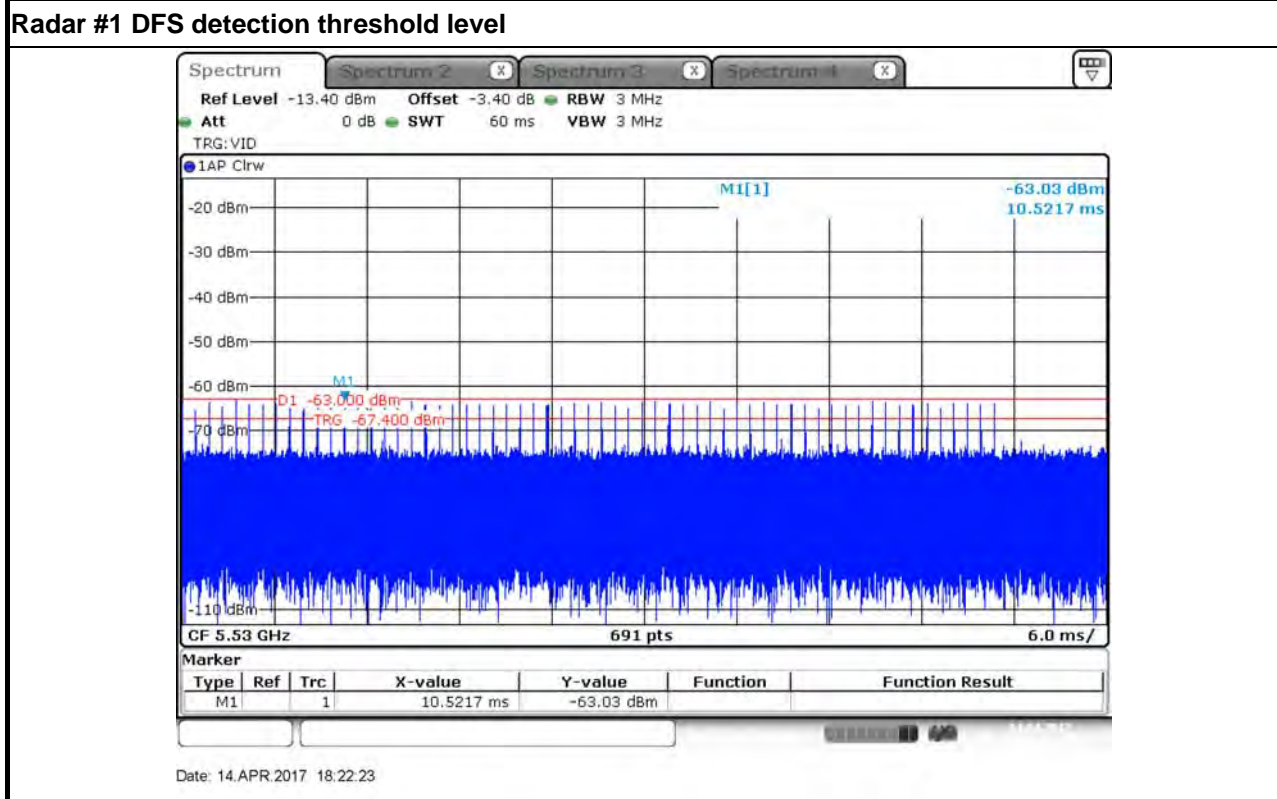
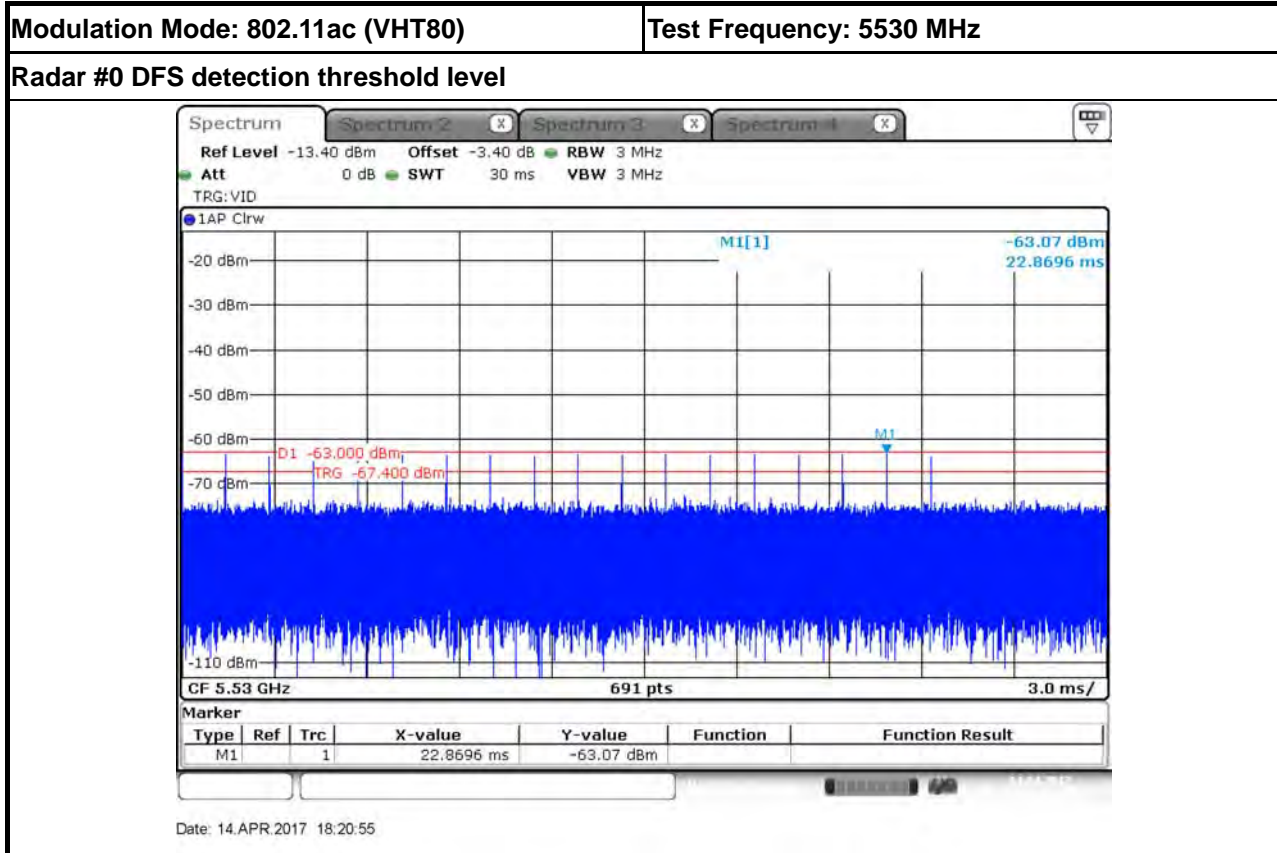



Radar #2 DFS detection threshold level

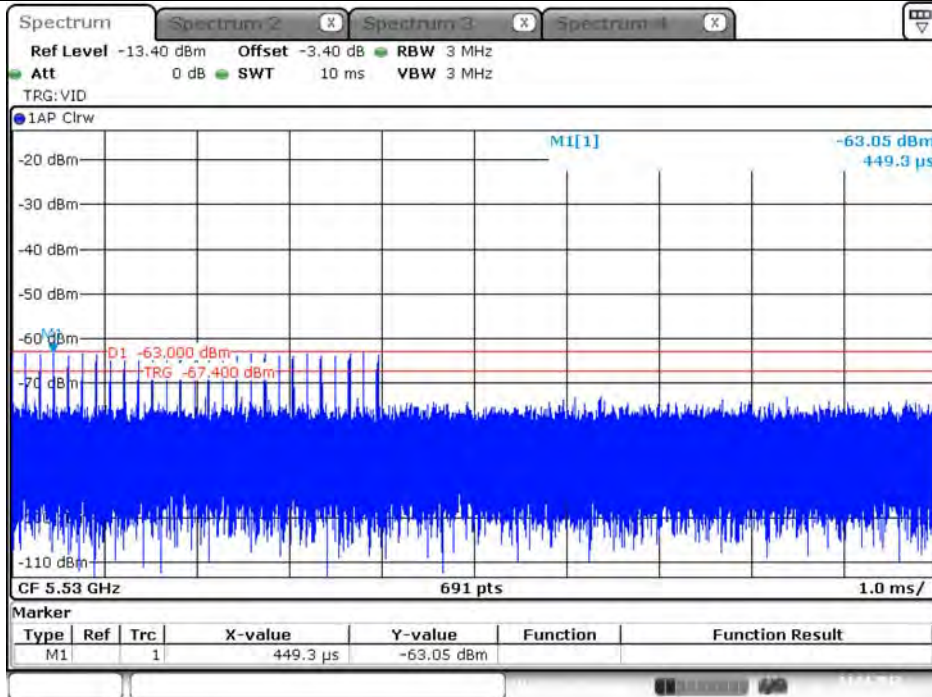

Date: 14.APR.2017 18:22:52

Radar #3 DFS detection threshold level

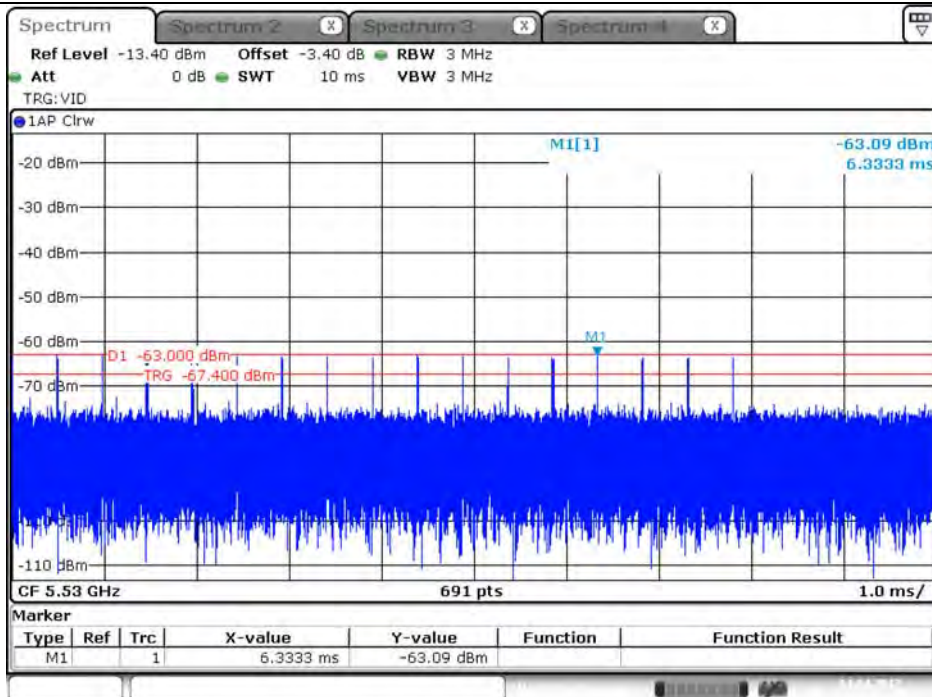

Date: 14.APR.2017 18:23:17



Radar #4 DFS detection threshold level

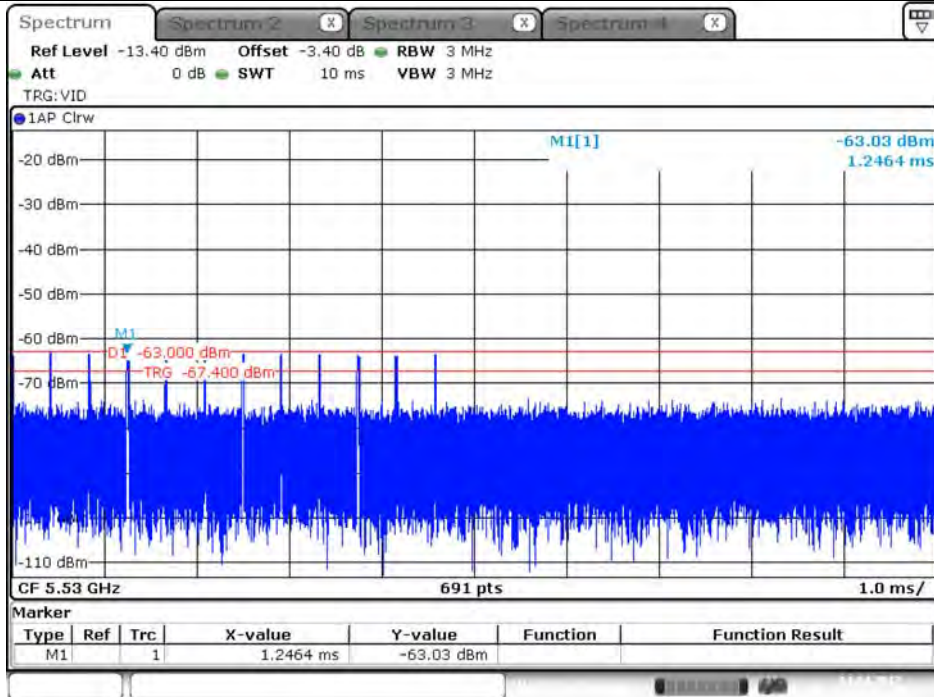

Date: 14.APR.2017 18:23:53

Radar #5 DFS detection threshold level

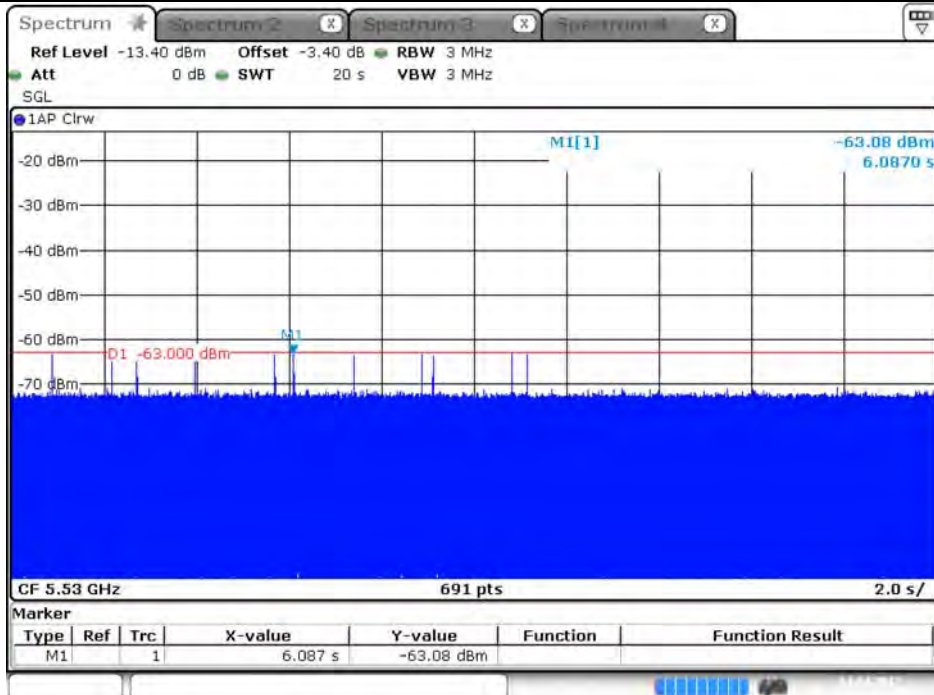

Date: 14.APR.2017 18:30:46



Radar #6 DFS detection threshold level

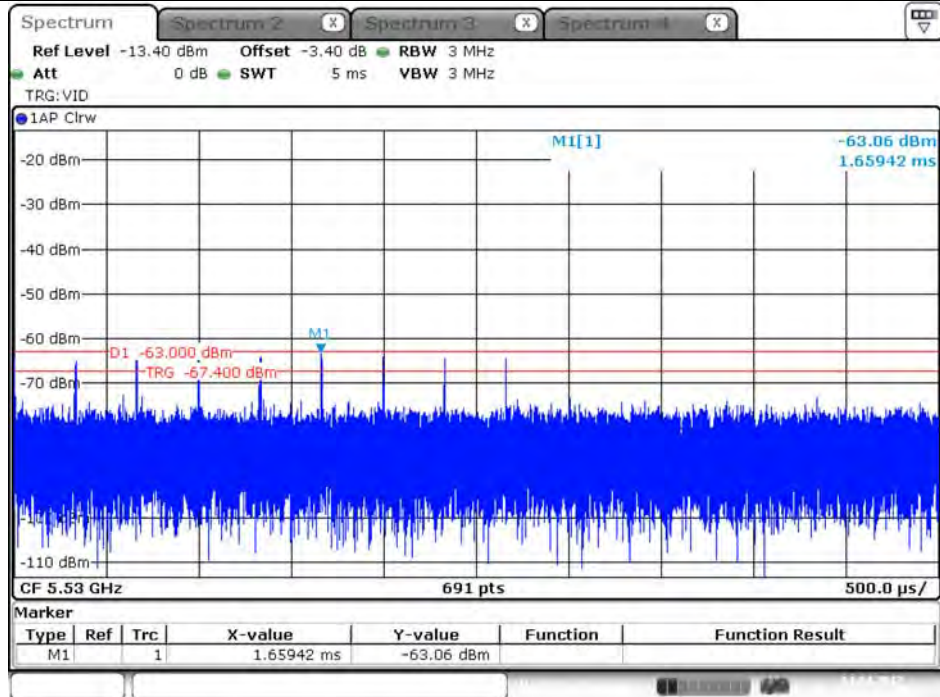

Date: 14.APR 2017 18:33:55

3.2.7 Test Setup

A spectrum analyzer is used as a monitor to verify that the EUT has vacated the Channel within the (Channel Closing Transmission Time and Channel Move Time, and does not transmit on a Channel during the Non-Occupancy Period after the detection and Channel move.

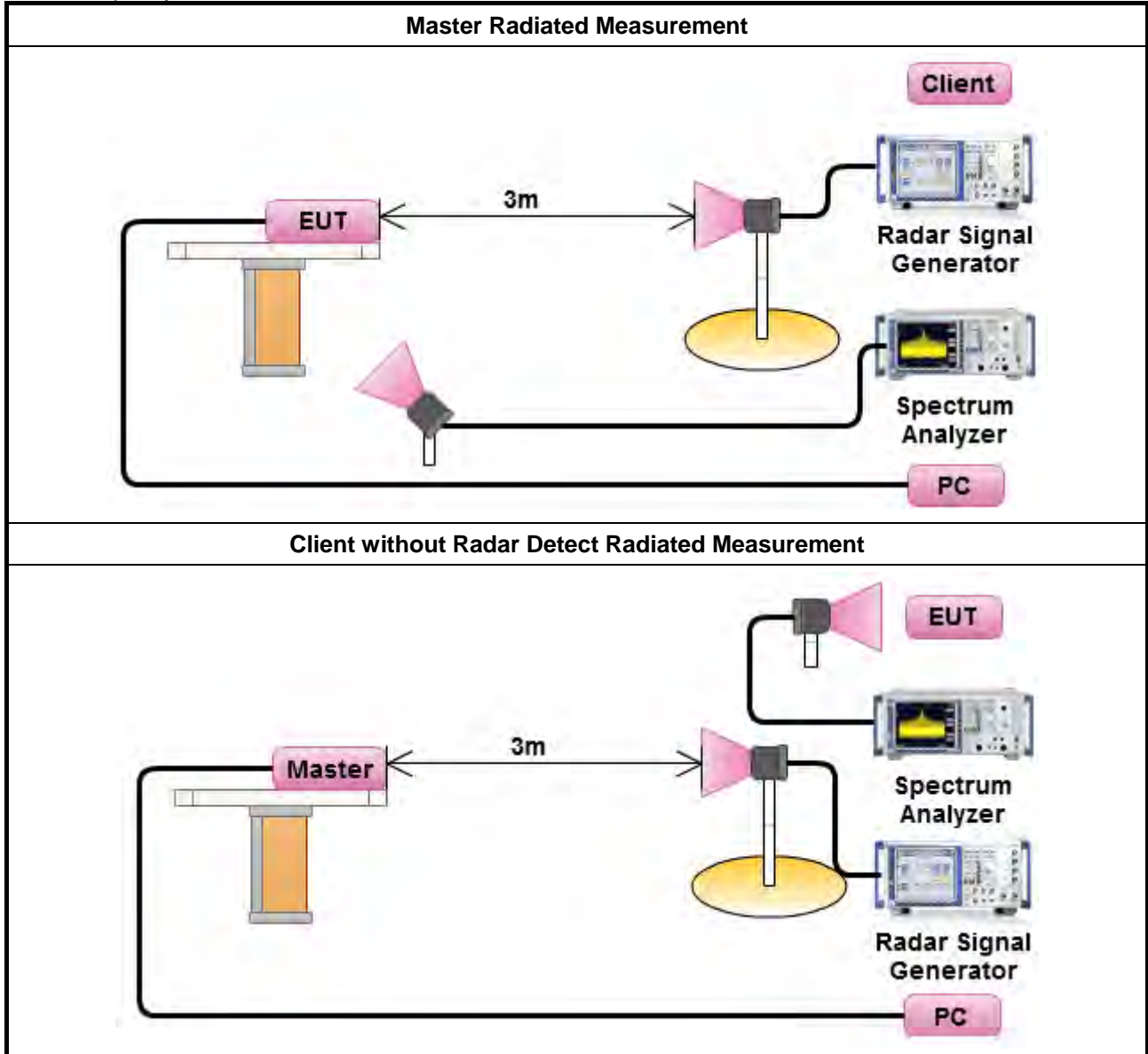



3.2.8 Data traffic Plot

For Master

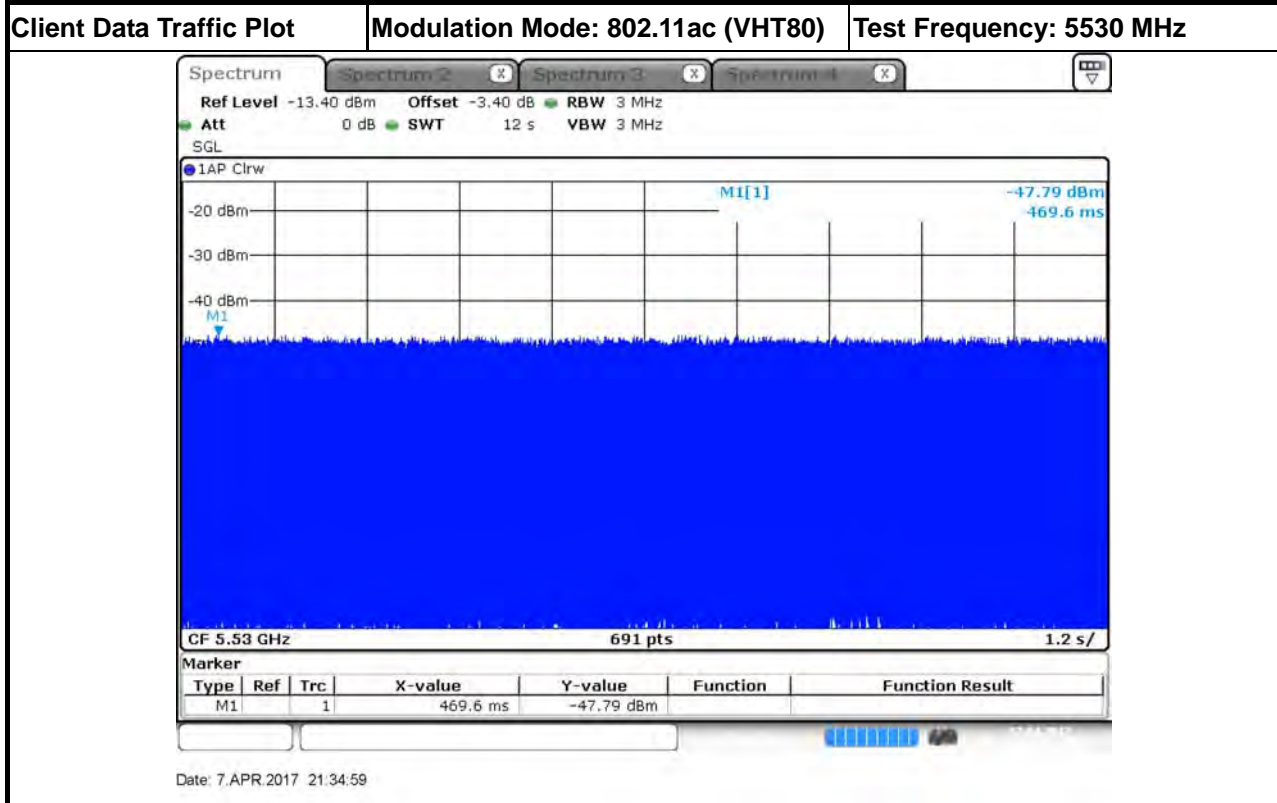
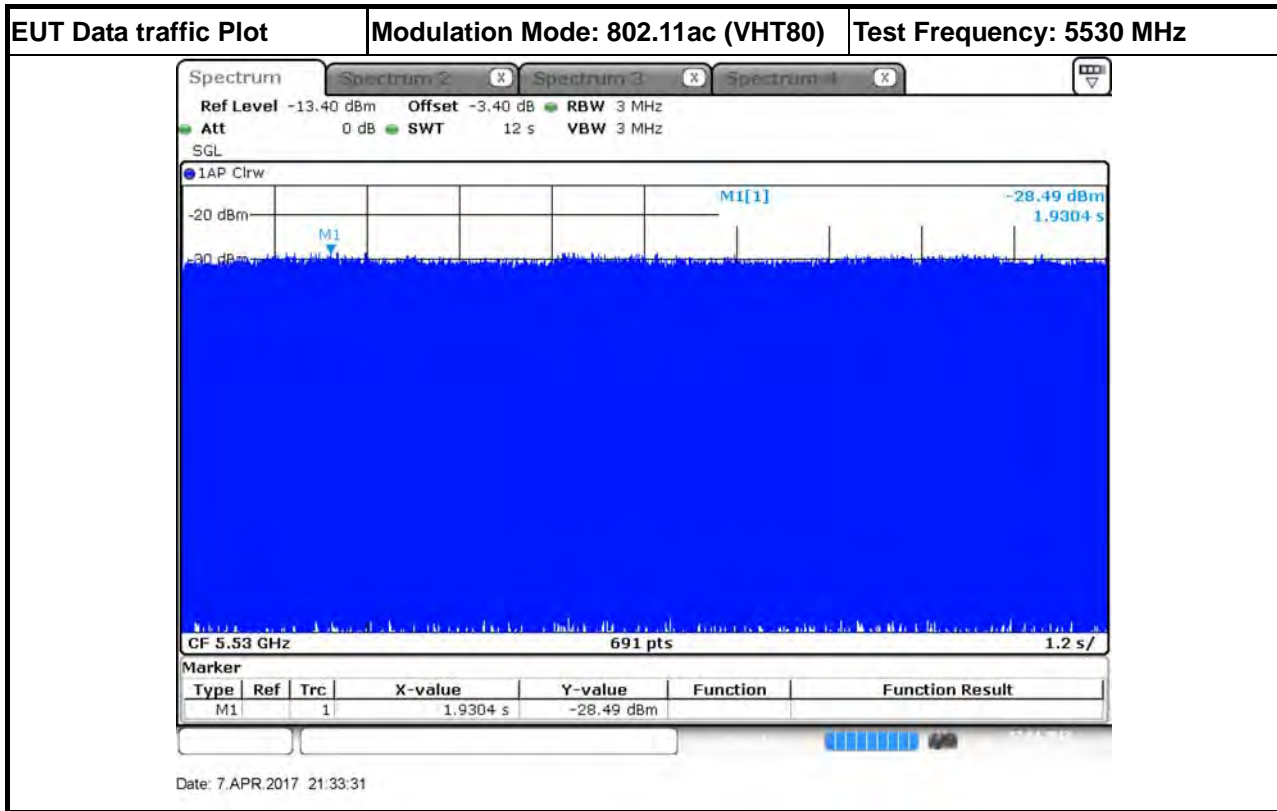

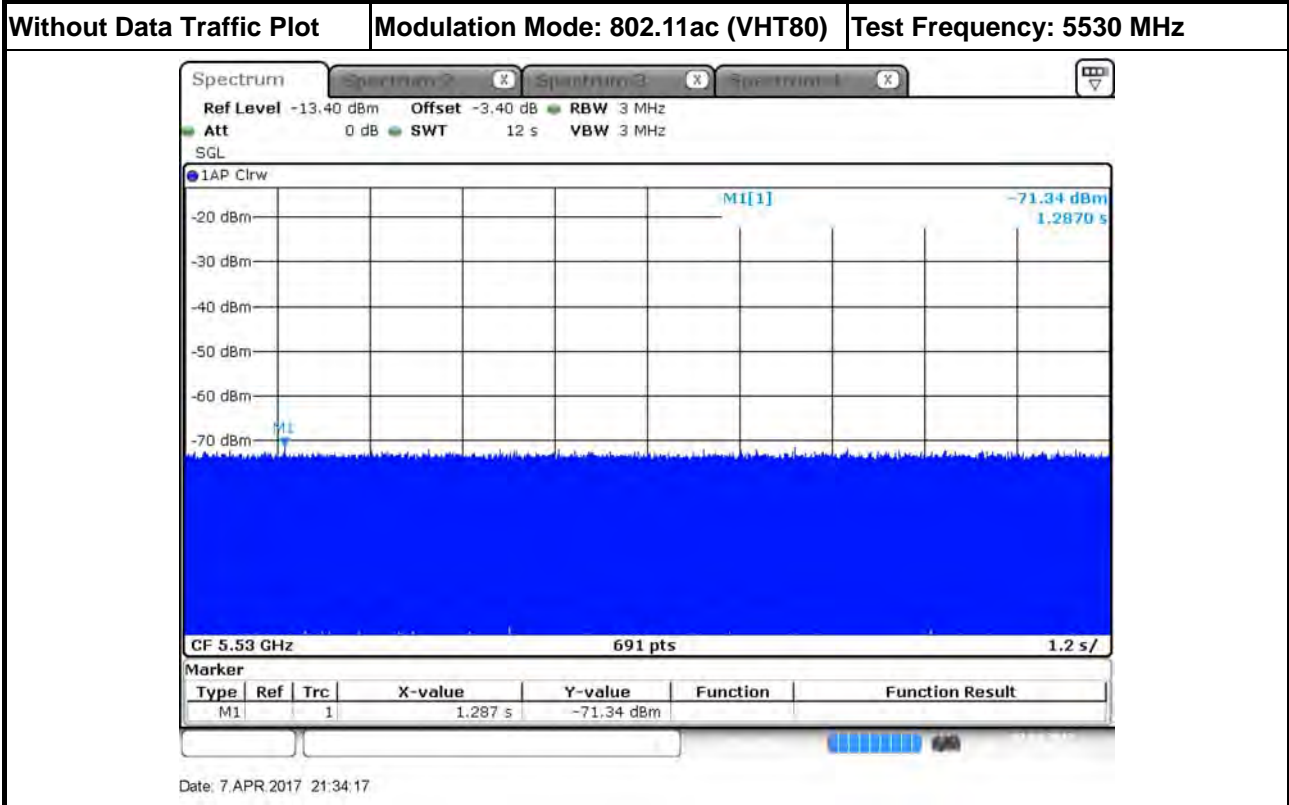



For Client without radar detection

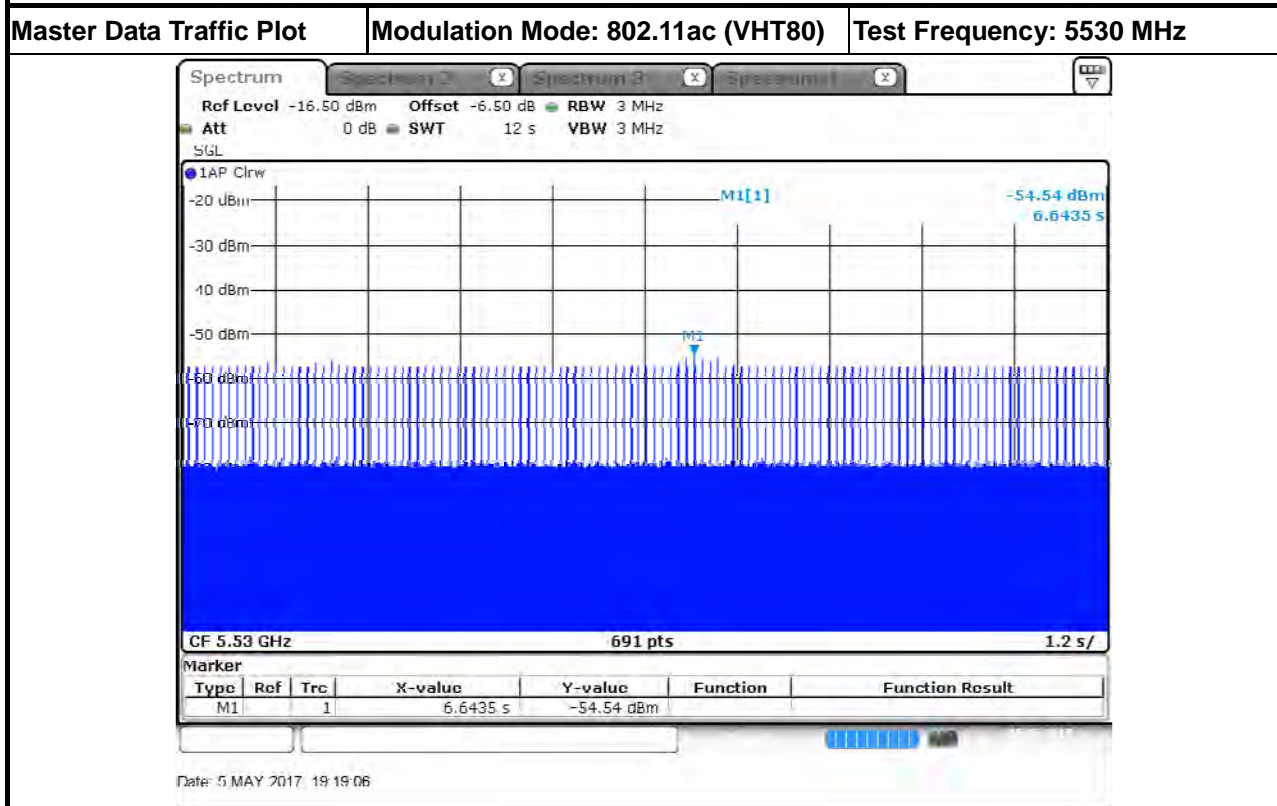
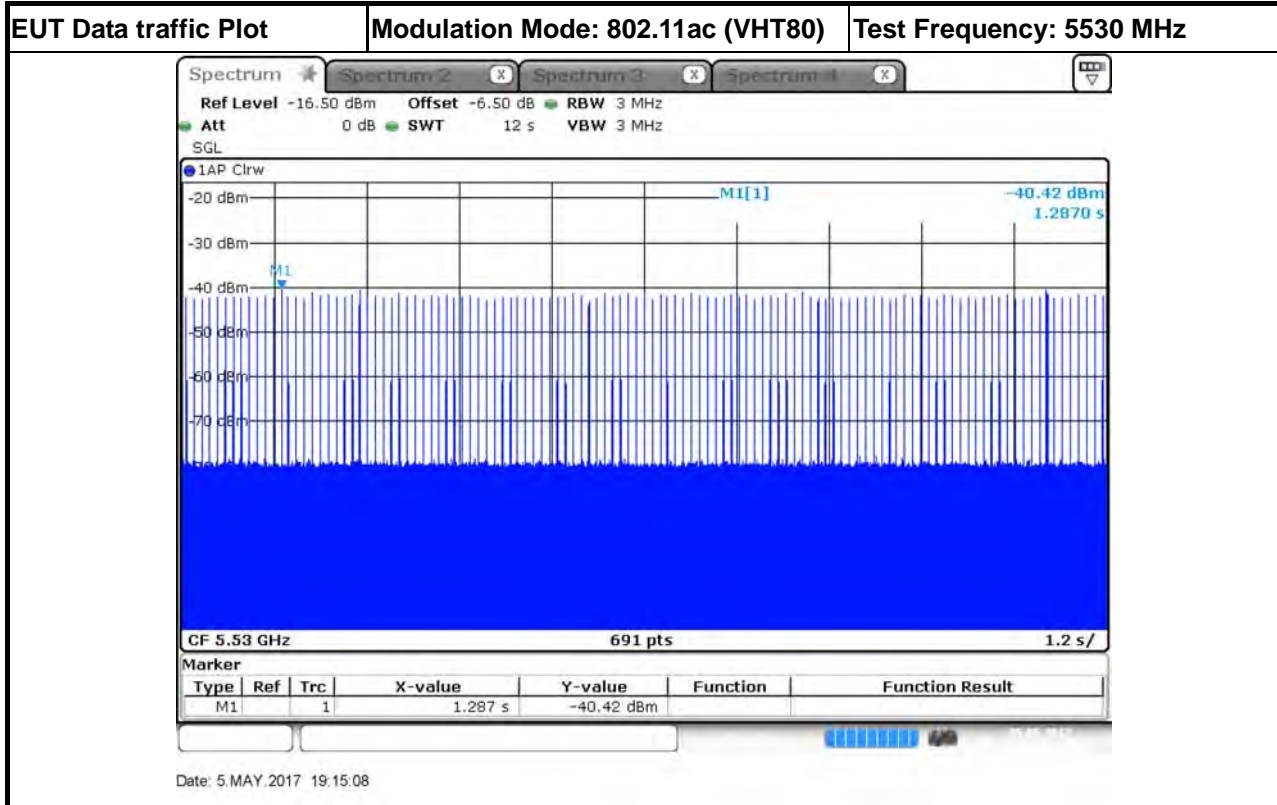

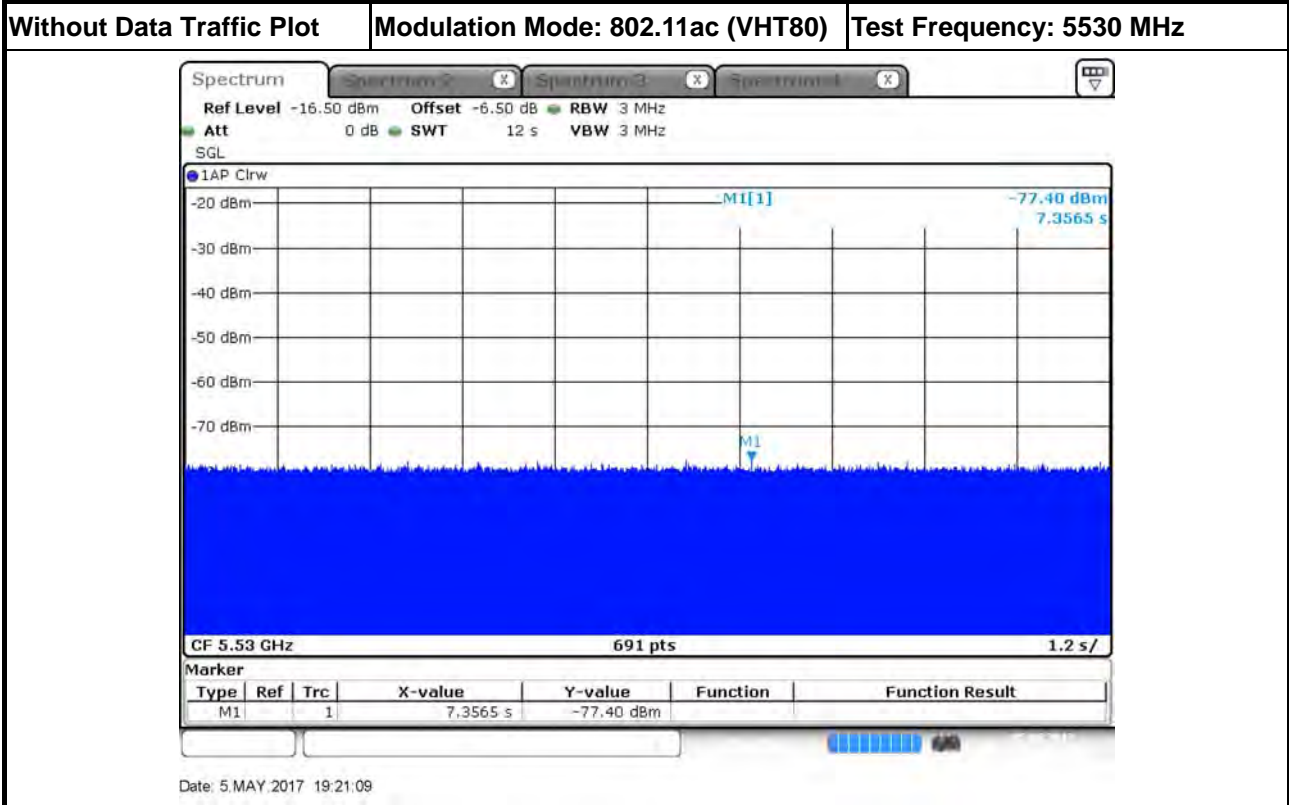

3.3 UNII Detection Bandwidth

3.3.1 UNII Detection Bandwidth Limit

For Master

Channel Bandwidth (MHz)	99% Occupied Bandwidth (MHz)	UNII Detection Bandwidth Min. Limit (MHz)
802.11ac (VHT20/VHT40/VHT80)		
20MHz (5500 MHz)	17.800	18
40MHz (5510 MHz)	39.218	40
80MHz (5530 MHz)	75.253	76
802.11ac (VHT80+80)		
80MHz (5530 MHz)	74.963	75
80MHz (5290 MHz)	75.542	76

UNII Detection Bandwidth is minimum 100% of the 99% power bandwidth. A single radar Burst is generated for a minimum of 10 trials, and the response of the UUT is noted. The UUT must detect the Radar Waveform 90% or more of the time.

3.3.2 Measuring Instruments

Refer a test equipment and calibration data table in this test report.

3.3.3 Test Procedures

Test Method	
<input checked="" type="checkbox"/>	During the U-NII Detection Bandwidth detection test, radar type 0 is used and for each frequency step the minimum percentage of detection is 90 percent. Measurements are performed with no data traffic. The EUT is set up as a standalone device (no associated Client and no traffic). The radar frequency is increased in 1 MHz steps, repeating the above test sequence, until the detection rate falls below 90%. The highest frequency at which detection is greater than or equal to 90% is denoted as F_H . The radar frequency is decreased in 1 MHz steps, repeating the above test sequence, until the detection rate falls below 90%. The lowest frequency at which detection is greater than or equal to 90% is denoted as F_L . UNII Detection Bandwidth = $F_H - F_L$.



3.3.4 Test Result of UNII Detection Bandwidth

For Master
802.11ac (VHT20/VHT40/VHT80)

EUT Frequency=5500 MHz												
Channel Bandwidth (MHz)	20											
Radar Frequency (MHz)	DFS Detection Trials (1=Detection, 0= No Detection)										Detection Rate (%)	
	1	2	3	4	5	6	7	8	9	10		
5490	0	0	0	0	0	0	0	0	0	0	0	0
5491(FL)	1	1	1	1	1	1	1	1	1	0	1	90
5492	1	1	1	1	1	1	1	1	1	1	1	100
5493	1	1	1	1	1	1	1	1	1	1	1	100
5494	1	1	1	1	1	1	1	1	1	1	1	100
5495	1	1	1	1	1	1	1	1	1	1	1	100
5500	1	1	1	1	1	1	1	1	1	1	1	100
5505	1	1	1	1	1	1	1	1	1	1	1	100
5506	1	1	1	1	1	1	1	1	1	1	1	100
5507	1	1	1	1	1	1	1	1	1	1	1	100
5508	1	1	1	1	1	1	1	1	1	1	1	100
5509(FH)	1	1	1	1	1	1	1	1	1	0	1	90
5510	0	0	0	0	0	0	0	0	0	0	0	0
Radar Type 0-Detection Bandwidth (MHz) = (FH-FL) = (5509MHz-5491MHz)=											18	
UNII Detection Bandwidth Min. Limit (MHz) =											18	
Test Result											Complied	



EUT Frequency=5510 MHz											
Channel Bandwidth (MHz)	40										
Radar Frequency (MHz)	DFS Detection Trials (1=Detection, 0= No Detection)										Detection Rate (%)
	1	2	3	4	5	6	7	8	9	10	
5489	0	0	0	0	0	0	0	0	0	0	0
5490(FL)	1	1	1	1	1	1	1	1	1	1	1
5491	1	1	1	1	1	1	1	1	1	1	1
5492	1	1	1	1	1	1	1	1	1	1	1
5493	1	1	1	1	1	1	1	1	1	1	1
5494	1	1	1	1	1	1	1	1	1	1	1
5495	1	1	1	1	1	1	1	1	1	1	1
5500	1	1	1	1	1	1	1	1	1	1	1
5505	1	1	1	1	1	1	1	1	1	1	1
5510	1	1	1	1	1	1	1	1	1	1	1
5515	1	1	1	1	1	1	1	1	1	1	1
5520	1	1	1	1	1	1	1	1	1	1	1
5525	1	1	1	1	1	1	1	1	1	1	1
5526	1	1	1	1	1	1	1	1	1	1	1
5527	1	1	1	1	1	1	1	1	1	1	1
5528	1	1	1	1	1	1	1	1	1	1	1
5529	1	1	1	1	1	1	1	1	1	1	1
5530(FH)	1	1	1	1	1	1	1	1	1	0	90
5531	0	0	0	0	0	0	0	0	0	0	0
Radar Type 0-Detection Bandwidth (MHz) = (FH-FL) = (5530MHz-5490MHz)=											40
UNII Detection Bandwidth Min. Limit (MHz) =											40
Test Result											Complied



EUT Frequency=5530 MHz												
Channel Bandwidth (MHz)	80											
Radar Frequency (MHz)	DFS Detection Trials (1=Detection, 0= No Detection)										Detection Rate (%)	
	1	2	3	4	5	6	7	8	9	10		
5490	0	0	0	0	0	0	0	0	0	0	0	0
5491(FL)	1	1	1	1	1	1	1	0	1	1	1	90
5492	1	1	1	1	1	1	1	1	1	1	1	100
5495	1	1	1	1	1	1	1	1	1	1	1	100
5500	1	1	1	1	1	1	1	1	1	1	1	100
5505	1	1	1	1	1	1	1	1	1	1	1	100
5510	1	1	1	1	1	1	1	1	1	1	1	100
5515	1	1	1	1	1	1	1	1	1	1	1	100
5520	1	1	1	1	1	1	1	1	1	1	1	100
5525	1	1	1	1	1	1	1	1	1	1	1	100
5530	1	1	1	1	1	1	1	1	1	1	1	100
5535	1	1	1	1	1	1	1	1	1	1	1	100
5540	1	1	1	1	1	1	1	1	1	1	1	100
5545	1	1	1	1	1	1	1	1	1	1	1	100
5550	1	1	1	1	1	1	1	1	1	1	1	100
5555	1	1	1	1	1	1	1	1	1	1	1	100
5560	1	1	1	1	1	1	1	1	1	1	1	100
5567	1	1	1	1	1	1	1	1	1	1	1	100
5568	1	1	1	1	1	1	1	1	1	1	1	100
5569(FH)	1	1	1	1	1	0	1	1	1	1	1	90
5570	0	0	0	0	0	0	0	0	0	0	0	0
Radar Type 0-Detection Bandwidth (MHz) = (FH-FL) = (5569MHz-5491MHz)=											78	
UNII Detection Bandwidth Min. Limit (MHz) =											76	
Test Result											Complied	



802.11ac (VHT80+80)

EUT Frequency=5530MHz												
Channel Bandwidth (MHz)	80											
Radar Frequency (MHz)	DFS Detection Trials (1=Detection, 0= No Detection)										Detection Rate (%)	
	1	2	3	4	5	6	7	8	9	10		
5489	0	0	0	0	0	0	0	0	0	0	0	0
5490(FL)	1	1	1	1	1	1	1	0	1	1	1	90
5491	1	1	1	1	1	1	1	1	1	1	1	100
5492	1	1	1	1	1	1	1	1	1	1	1	100
5493	1	1	1	1	1	1	1	1	1	1	1	100
5494	1	1	1	1	1	1	1	1	1	1	1	100
5495	1	1	1	1	1	1	1	1	1	1	1	100
5500	1	1	1	1	1	1	1	1	1	1	1	100
5505	1	1	1	1	1	1	1	1	1	1	1	100
5510	1	1	1	1	1	1	1	1	1	1	1	100
5515	1	1	1	1	1	1	1	1	1	1	1	100
5520	1	1	1	1	1	1	1	1	1	1	1	100
5525	1	1	1	1	1	1	1	1	1	1	1	100
5530	1	1	1	1	1	1	1	1	1	1	1	100
5535	1	1	1	1	1	1	1	1	1	1	1	100
5540	1	1	1	1	1	1	1	1	1	1	1	100
5545	1	1	1	1	1	1	1	1	1	1	1	100
5550	1	1	1	1	1	1	1	1	1	1	1	100
5555	1	1	1	1	1	1	1	1	1	1	1	100
5560	1	1	1	1	1	1	1	1	1	1	1	100
5565	1	1	1	1	1	1	1	1	1	1	1	100
5566	1	1	1	1	1	1	1	1	1	1	1	100
5567	1	1	1	1	1	1	1	1	1	1	1	100
5568	1	1	1	1	1	1	1	1	1	1	1	100
5569	1	1	1	1	1	1	1	1	1	1	1	100
5570(FH)	1	1	1	1	1	1	1	1	0	1	1	90
5571	0	0	0	0	0	0	0	0	0	0	0	0
Radar Type 0-Detection Bandwidth (MHz) = (FH-FL) = (5570MHz-5490MHz)=											80	
UNII Detection Bandwidth Min. Limit (MHz) =											75	
Test Result											Complied	



EUT Frequency=5290MHz											
Channel Bandwidth (MHz)	80										
Radar Frequency (MHz)	DFS Detection Trials (1=Detection, 0= No Detection)										Detection Rate (%)
	1	2	3	4	5	6	7	8	9	10	
5250	0	0	0	0	0	0	0	0	0	0	0
5251(FL)	1	1	1	1	1	1	0	1	1	1	90
5255	1	1	1	1	1	1	1	1	1	1	100
5260	1	1	1	1	1	1	1	1	1	1	100
5265	1	1	1	1	1	1	1	1	1	1	100
5270	1	1	1	1	1	1	1	1	1	1	100
5275	1	1	1	1	1	1	1	1	1	1	100
5280	1	1	1	1	1	1	1	1	1	1	100
5285	1	1	1	1	1	1	1	1	1	1	100
5290	1	1	1	1	1	1	1	1	1	1	100
5295	1	1	1	1	1	1	1	1	1	1	100
5300	1	1	1	1	1	1	1	1	1	1	100
5305	1	1	1	1	1	1	1	1	1	1	100
5310	1	1	1	1	1	1	1	1	1	1	100
5315	1	1	1	1	1	1	1	1	1	1	100
5320	1	1	1	1	1	1	1	1	1	1	100
5325	1	1	1	1	1	1	1	1	1	1	100
5326	1	1	1	1	1	1	1	1	1	1	100
5327	1	1	1	1	1	1	1	1	1	1	100
5328	1	1	1	1	1	1	1	1	1	1	100
5329(FH)	1	1	1	1	1	1	1	1	0	1	90
5330	0	0	0	0	0	0	0	0	0	0	0
Radar Type 0-Detection Bandwidth (MHz) = (FH-FL) = (5329MHz-5251MHz)=											78
UNII Detection Bandwidth Min. Limit (MHz) =											76
Test Result											Complied



3.4 Channel Availability Check (CAC)

3.4.1 Channel Availability Check Limit

Channel Availability Check Limit	
<input checked="" type="checkbox"/>	The EUT shall perform a Channel Availability Check to ensure that there is no radar operating on the channel. After power-up sequence, receive at least 1 minute (60 sec) on the intended operating frequency.

3.4.2 Measuring Instruments

Refer a test equipment and calibration data table in this test report.

3.4.3 Test Procedures

Test Method	
<input checked="" type="checkbox"/>	For Initial Channel Availability Check Time. The EUT does not emit beacon, control, or data signals on the test Channel until the power-up sequence has been completed and the UNII device checks for Radar Waveforms for one minute on the test Channel. This test does not use any Radar Waveforms.
<input checked="" type="checkbox"/>	For Radar Burst at the Beginning of the Channel Availability Check Time. To verify successful radar detection on the selected Channel during a period equal to the Beginning of the Channel Availability Check Time.
<input checked="" type="checkbox"/>	For Radar Burst at the End of the Channel Availability Check Time. To verify successful radar detection on the selected Channel during a period equal to the End of the Channel Availability Check Time.



3.4.4 Test Result of Initial Channel Availability Check Time

For Master

Modulation Mode	Freq.	Radar Test Signal
802.11ac (VHT80)	5530 MHz	N/A

The EUT does not transmit any beacon or data transmissions until at least 1 minute after the completion of the power-on cycle (140.1 sec). The initial CAC time of the EUT is indicated by marker 1 (140.1 sec). Initial beacons/data transmissions are indicated by marker 2 (200.1 sec).

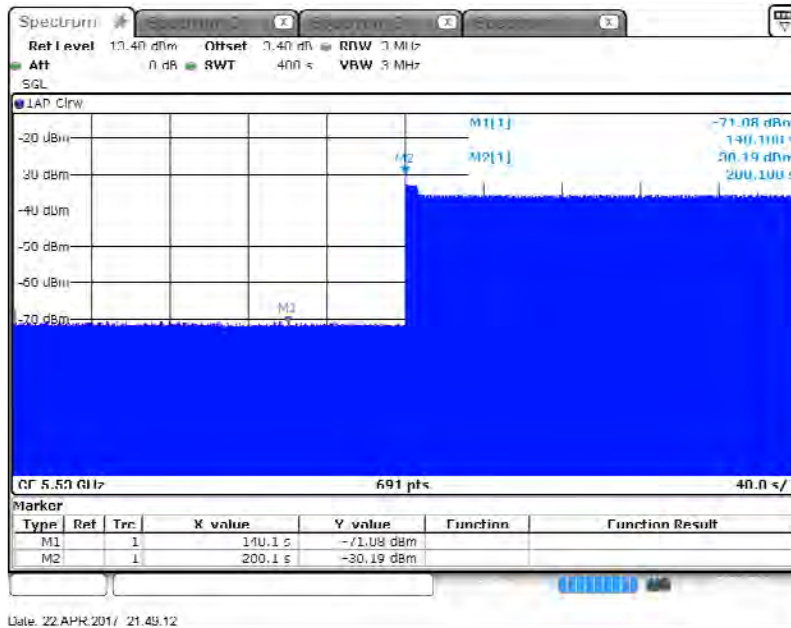

Test Result

Complied



3.4.5 Test Result of Radar Burst at the Beginning of the Channel Availability Check Time

For Master

Modulation Mode	Freq. (MHz)	Radar Type Signal
802.11ac (VHT80)	5530 MHz	0

Visual indication on the EUT of successful detection of the radar Burst will be recorded and reported. Observation of emissions will continue for 257.391 seconds after the radar Burst has been generated. Verify that during the 400 seconds measurement window no EUT transmissions occurred.

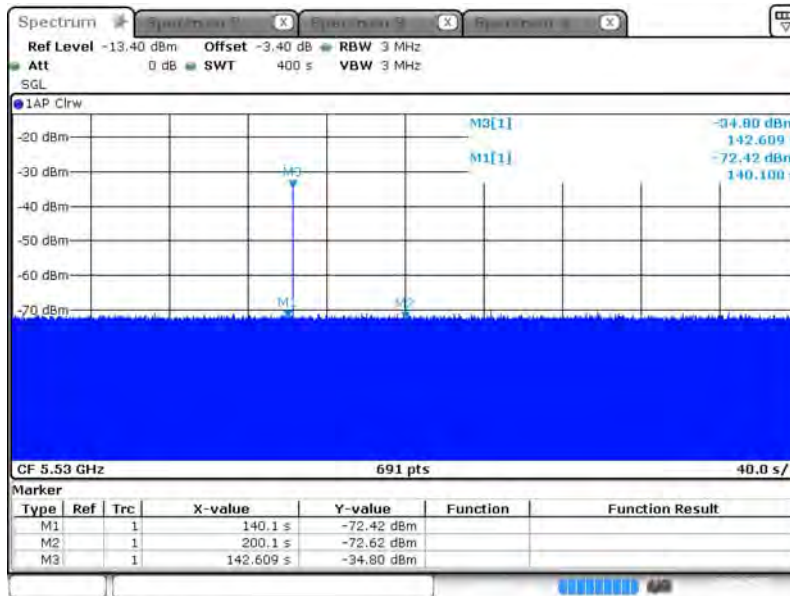

Date: 22 APR 2017 22:40:28

Test Result	Complied
--------------------	-----------------



3.4.6 Test Result of Radar Burst at the End of the Channel Availability Check Time

For Master

Modulation Mode	Freq. (MHz)	Radar Type Signal
802.11ac (VHT80)	5530 MHz	0

Visual indication on the EUT of successful detection of the radar Burst will be recorded and reported. Observation of emissions will continue for 202.899 seconds after the radar Burst has been generated. Verify that during the 400 seconds measurement window no EUT transmissions occurred.

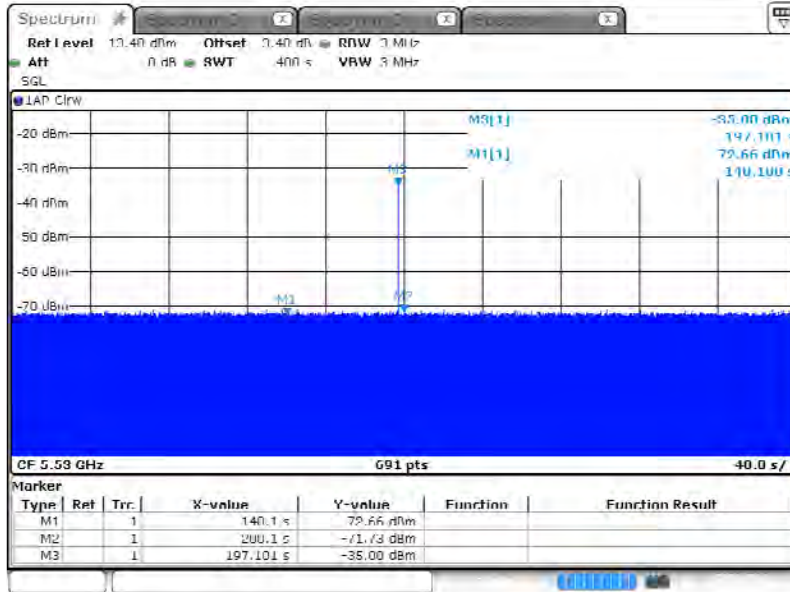

Date: 22 APR 2017 22:45:22

Test Result	Complied
-------------	----------



3.5 In-service Monitoring

3.5.1 In-service Monitoring Limit

In-service Monitoring Limit	
Channel Move Time	10 sec
Channel Closing Transmission Time	200 ms + an aggregate of 60 ms over remaining 10 sec periods.
Non-occupancy period	Minimum 30 minutes

3.5.2 Measuring Instruments

Refer a test equipment and calibration data table in this test report.

3.5.3 Test Procedures

Test Method
<input checked="" type="checkbox"/> Verified during In-Service Monitoring; Channel Closing Transmission Time, Channel Move Time. Client Device will associate with the EUT. Observe the transmissions of the EUT at the end of the radar Burst on the Operating Channel for duration greater than 10 seconds. Measure and record the transmissions from the EUT during the observation time (Channel Move Time). Compare the Channel Move Time and Channel Closing Transmission Time limits.
<input checked="" type="checkbox"/> Verified during In-Service Monitoring; Channel Closing Transmission Time, Channel Move Time. One 12 sec plot needs to be reported for the Short Pulse Radar Types 0. And zoom-in a 60 ms plot verified channel closing time for the aggregate transmission time starting from 200ms after the end of the radar signal to the completion of the channel move.
<input checked="" type="checkbox"/> Verified during In-Service Monitoring; Non-Occupancy Period. Client Device will associate with the EUT. Observe the transmissions of the EUT at the end of the radar Burst on the Operating Channel for duration greater than 10 seconds. Measure and record the transmissions from the EUT during the observation time (Non-Occupancy Period). Compare the Non-Occupancy Period limits.



3.5.4 Test Result of Channel Move Time

For Master
Modulation Mode:

Parameter	Test Result	Limit
	Type 0	
Test Channel (MHz)	5530 MHz	-
Channel Move Time (sec.)	0.413	< 10s

For Client without radar detection
Modulation Mode:

Parameter	Test Result	Limit
	Type 0	
Test Channel (MHz)	5530 MHz	-
Channel Move Time (sec.)	0.417	< 10s

For Master

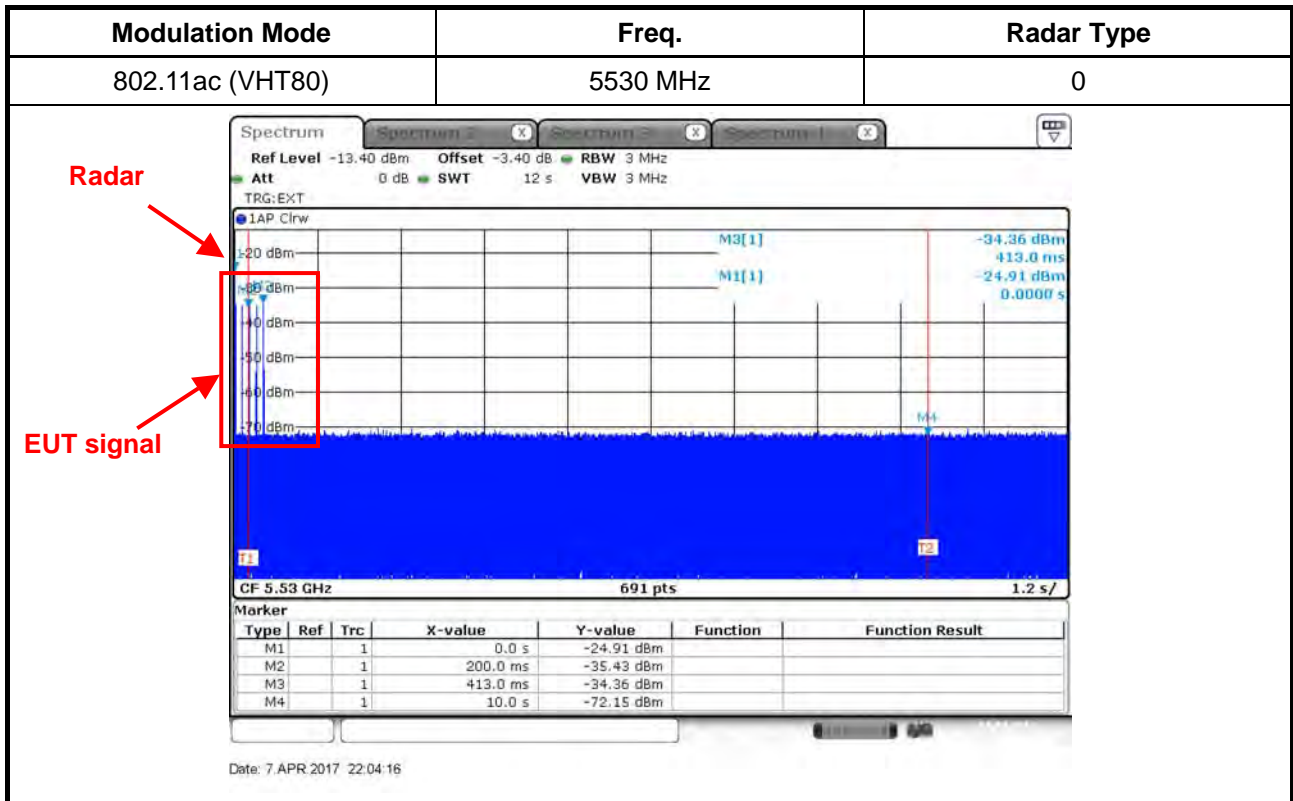

For Client without radar detection

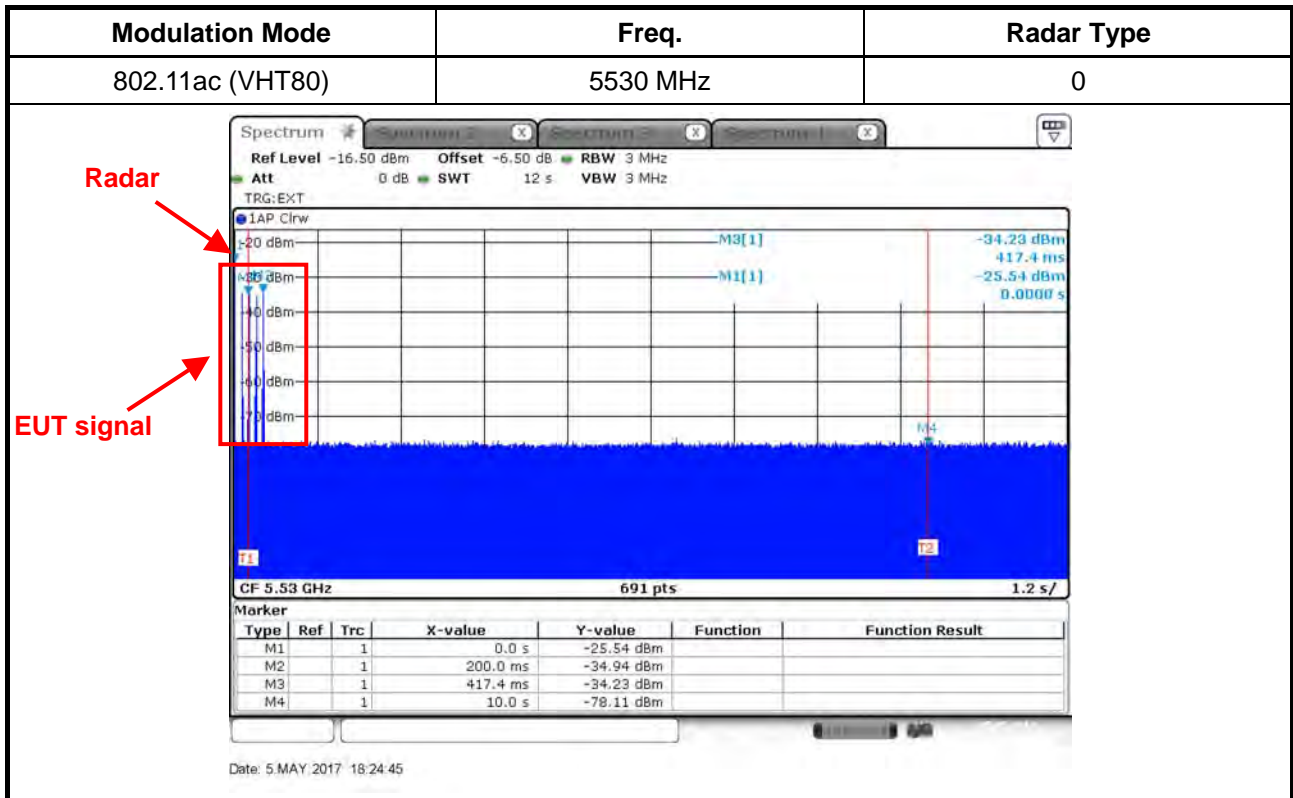



3.5.5 Test Result of Channel Closing Transmission Time

For Master
Modulation Mode:

Parameter	Test Result	Limit
	Type 0	
Test Channel (MHz)	5530 MHz	-
Channel Closing Transmission Time (ms) (Note)	11.594	< 60ms

Note: The Channel Closing Transmission Time is comprised of 200 milliseconds starting at the beginning of the Channel Move Time plus any additional intermittent control signals required to facilitate a Channel move (an aggregate of 60 milliseconds) during the remainder of the 10 seconds period. The aggregate duration of control signals will not count quiet periods in between transmissions.

For Client without radar detection
Modulation Mode:

Parameter	Test Result	Limit
	Type 0	
Test Channel (MHz)	5530 MHz	-
Channel Closing Transmission Time (ms) (Note)	14.492	< 60ms

Note: The Channel Closing Transmission Time is comprised of 200 milliseconds starting at the beginning of the Channel Move Time plus any additional intermittent control signals required to facilitate a Channel move (an aggregate of 60 milliseconds) during the remainder of the 10 seconds period. The aggregate duration of control signals will not count quiet periods in between transmissions.

For Master

Modulation Mode	Freq.	Radar Type
802.11ac (VHT80)	5530 MHz	0

Channel Closing Transmission Time is comprised of 200 ms starting at the beginning of the Channel Move Time plus 60ms additional intermittent control signals

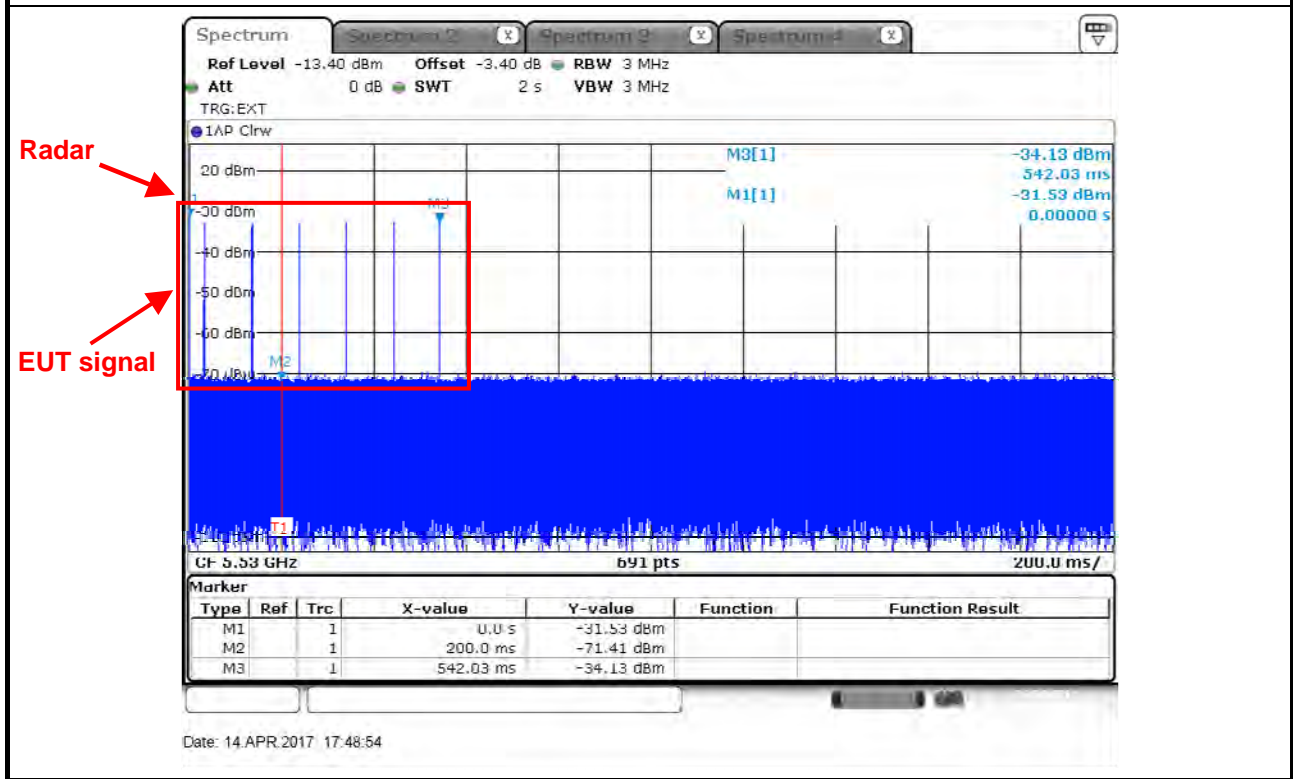

Dwell is the dwell time per spectrum analyzer sampling bin.

S is the sweep time

B is the number of spectrum analyzer sampling bins

C is the intermittent control signals of Channel Closing Transmission Time

N is the number of spectrum analyzer sampling bins (intermittent control signals) showing a U-NII transmission

$$\text{Dwell (2.899 ms)} = \text{S (2000 ms)} / \text{B (690)}$$

$$\text{C (11.594 ms)} = \text{N (4)} \times \text{Dwell (2.899 ms)}$$

For Client without radar detection

Modulation Mode	Freq.	Radar Type
802.11ac (VHT80)	5530 MHz	0

Channel Closing Transmission Time is comprised of 200 ms starting at the beginning of the Channel Move Time plus 60ms additional intermittent control signals

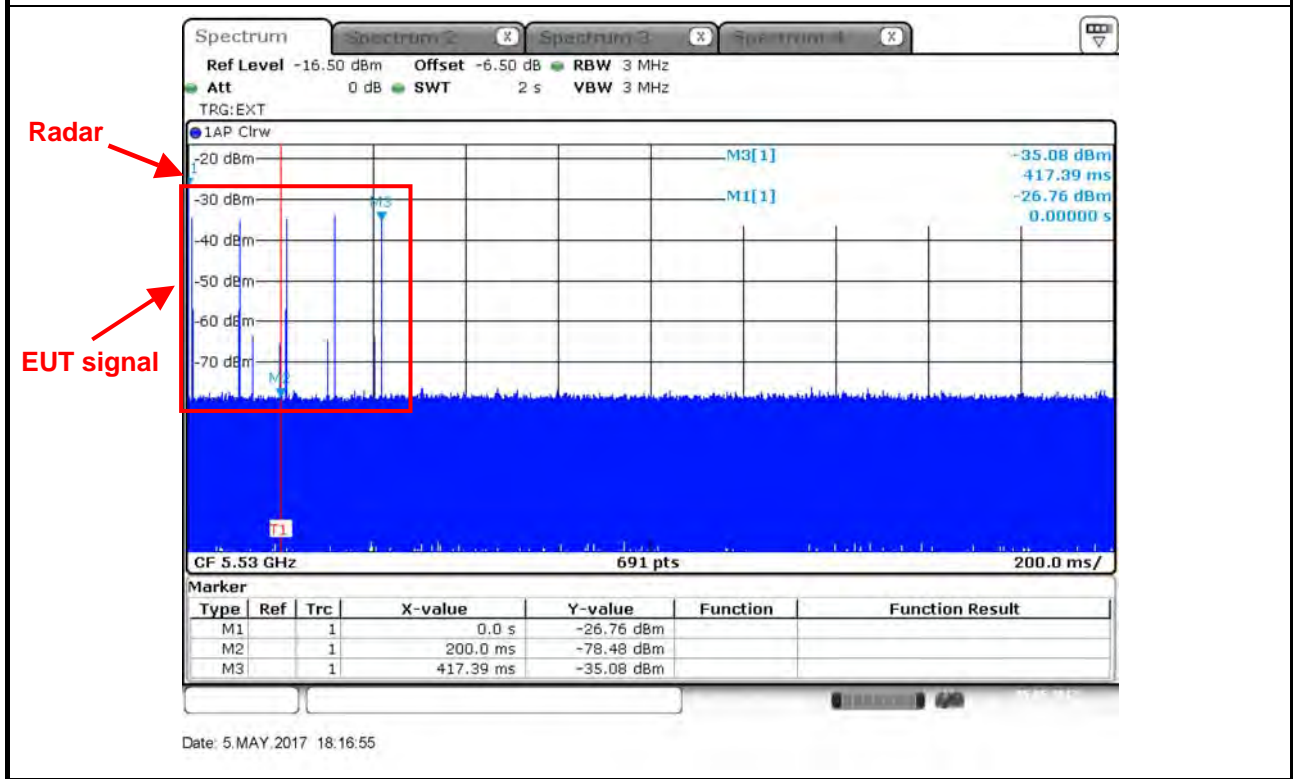

Dwell is the dwell time per spectrum analyzer sampling bin.

S is the sweep time

B is the number of spectrum analyzer sampling bins

C is the intermittent control signals of Channel Closing Transmission Time

N is the number of spectrum analyzer sampling bins (intermittent control signals) showing a U-NII transmission

$$\text{Dwell (2.899 ms)} = \text{S (2000 ms)} / \text{B (690)}$$

$$\text{C (14.492 ms)} = \text{N (5)} \times \text{Dwell (2.899 ms)}$$



3.5.6 Test Result of Non-Occupancy Period

For Master
Modulation Mode:

Parameter	Test Result	Limit
	Type 0	
Test Channel (MHz)	5530 MHz	-
Non-Occupancy Period (min.)	≥ 30	≥ 30 min

Modulation Mode	Freq.
802.11ac (VHT80)	5530 MHz

Non-Occupancy Period

During the 30 minutes observation time, UUT did not make any transmissions on a channel after a radar signal was detected on that channel by either the Channel Availability Check or the In-Service Monitoring.

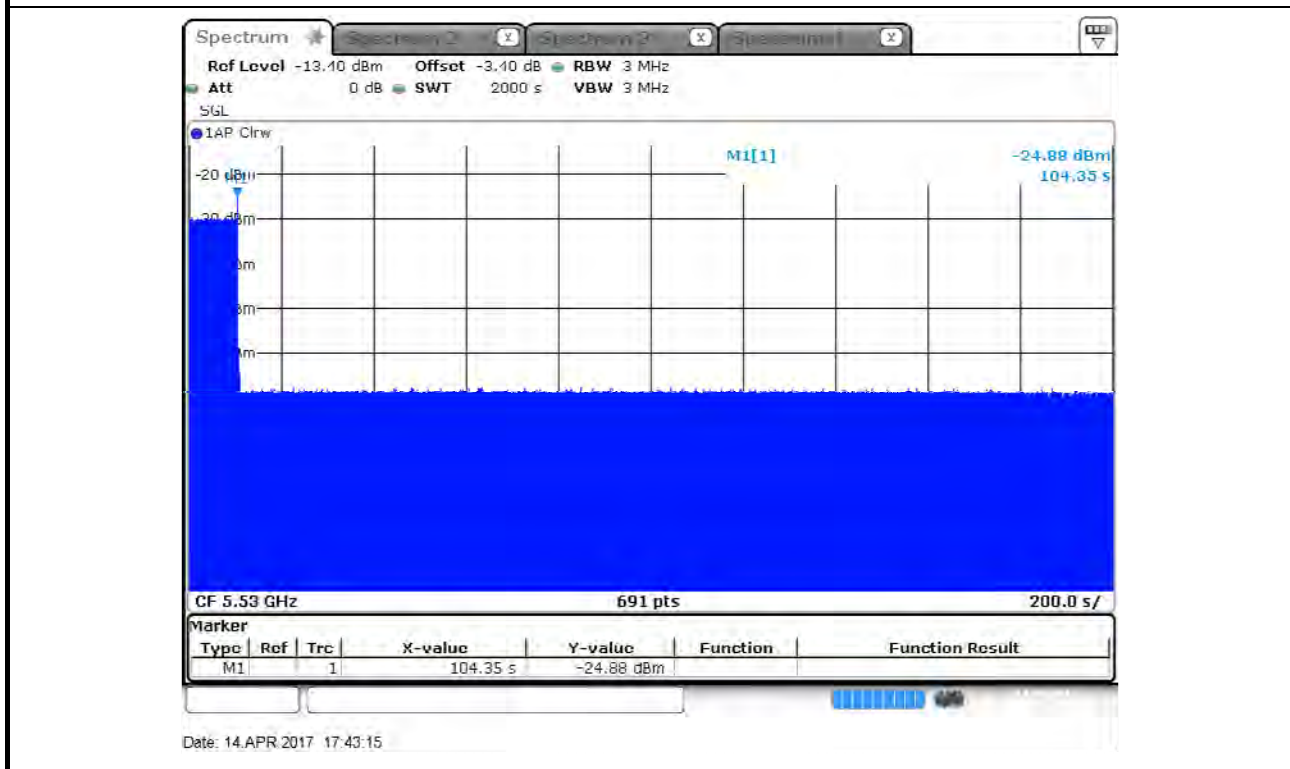



For Client without radar detection

Modulation Mode:

Parameter	Test Result	Limit
	Type 0	
Test Channel (MHz)	5530 MHz	-
Non-Occupancy Period (min.)	≥ 30	≥ 30 min

Modulation Mode	Freq.
802.11ac (VHT80)	5530 MHz

Non-Occupancy Period

During the 30 minutes observation time, UUT did not make any transmissions on a channel after a radar signal was detected on that channel by either the Channel Availability Check or the In-Service Monitoring.

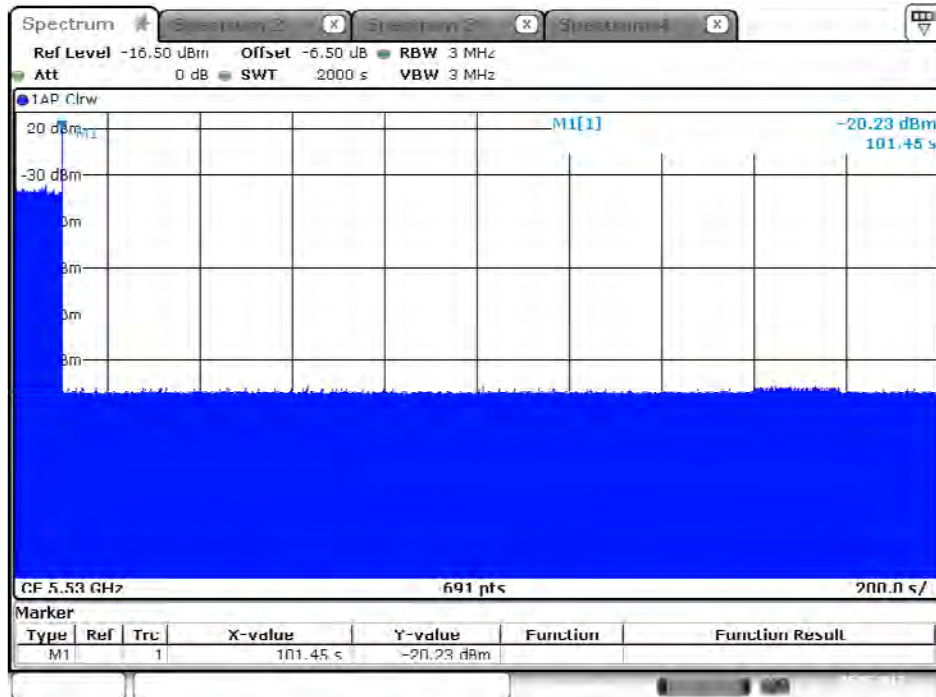

Date: 5 MAY 2017 19:07:48



3.6 Statistical Performance Check

3.6.1 Statistical Performance Check Limit

Radar Type	Minimum Percentage of Successful Detection (Pd)	Minimum Trials
1	60%	30
2	60%	30
3	60%	30
4	60%	30
Aggregate (Radar Types 1-4)	80%	120
5	80%	30
6	70%	30

The percentage of successful detection is calculated by:

$$\frac{\text{TotalWaveformDetections}}{\text{TotalWaveformTrails}} \times 100 = \text{Probability of Detection Radar Waveform}$$
 In addition an aggregate minimum percentage of successful detection across all Short Pulse Radar Types 1-4 is required and is calculated as follows:

$$\frac{Pd1 + Pd2 + Pd3 + Pd4}{4}$$

3.6.2 Measuring Instruments

Refer a test equipment and calibration data table in this test report.

3.6.3 Test Procedures

Test Method
<input checked="" type="checkbox"/> For Statistical Performance Check test. Demonstrating a minimum channel loading of approximately 17% or greater of the test. Observe the transmissions of the UUT at the end of the Burst on the Operating Channel for duration greater than 10 seconds for Short Pulse Radar Types 1-4 and 6 to ensure detection occurs. Then Observe the transmissions of the UUT at the end of the Burst on the Operating Channel for duration greater than 22 seconds for Long Pulse Radar Type 5 to ensure detection occurs. The device can utilize a test mode to demonstrate when detection occurs to prevent the need to reset the device between trial runs.



3.6.4 Test Result of Statistical Performance Check

For Master

Modulation Mode: 802.11ac (VHT20) / 5500MHz

Type 1 Radar Statistical Performance

Trial #	Test Freq. (MHz)	Pulse Repetition Frequency Number	Pulse Repetition Frequency (Pulse Per Second)	PRI (us)	1=Detection 0=No Detection
1	5493	1	1930.5	518	1
2	5491	23	326.2	3066	1
3	5495	19	1139.0	878	1
4	5496	12	1355.0	738	1
5	5497	4	1730.1	578	1
6	5498	8	1519.8	658	1
7	5499	15	1253.1	798	1
8	5500	6	1618.1	618	1
9	5501	14	1285.3	778	1
10	5502	3	1792.1	558	1
11	5503	13	1319.3	758	0
12	5504	9	1474.9	678	1
13	5505	7	1567.4	638	1
14	5506	17	1193.3	838	1
15	5507	10	1432.7	698	1
16	5506	-	1692.0	591	1
17	5505	-	328.1	3048	1
18	5504	-	373.4	2678	1
19	5503	-	574.4	1741	1
20	5509	-	1216.5	822	0
21	5501	-	801.3	1248	1
22	5500	-	488.5	2047	1
23	5499	-	956.0	1046	1
24	5498	-	517.6	1932	1
25	5497	-	1422.5	703	1
26	5496	-	542.0	1845	1
27	5495	-	741.3	1349	1
28	5494	-	881.8	1134	1
29	5493	-	427.4	2340	1
30	5494	-	628.9	1590	1
Detection Percentage (%)					93.333
Limit					60%
Test Result					Complied



Type 2 Radar Statistical Performance

Trial #	Test Freq. (MHz)	Pulse Width (us)	PRI (us)	Pulses / Burst	1=Detection 0=No Detection
1	5493	2.6	221	23	1
2	5491	4.6	198	27	1
3	5495	1.1	184	29	1
4	5496	4.8	203	24	1
5	5497	2.4	162	25	1
6	5498	3.4	204	28	1
7	5499	2.3	170	27	1
8	5500	3.5	184	23	0
9	5501	4.9	150	27	1
10	5502	4.6	211	29	1
11	5503	2.9	158	23	1
12	5504	2.6	226	27	1
13	5505	1.6	204	26	0
14	5506	3.9	181	25	1
15	5507	4.6	202	24	1
16	5506	4.1	194	27	1
17	5505	2.3	193	28	1
18	5504	3.9	173	29	1
19	5503	4.3	188	23	1
20	5509	1.5	215	26	1
21	5501	4.9	227	27	1
22	5500	1.1	199	23	1
23	5499	4.5	155	29	0
24	5498	4.0	190	27	1
25	5497	2.4	151	23	1
26	5496	2.5	180	28	1
27	5495	2.5	228	23	1
28	5494	2.5	203	25	1
29	5493	1.5	188	25	1
30	5494	1.9	217	24	1
Detection Percentage (%)					90.000
Limit					60%
Test Result					Complied



Type 3 Radar Statistical Performance

Trial #	Test Freq. (MHz)	Pulse Width (us)	PRI (us)	Pulses / Burst	1=Detection ; 0=No Detection
1	5493	8.0	205	16	1
2	5491	6.7	382	18	1
3	5495	8.6	418	16	1
4	5496	9.4	351	17	0
5	5497	7.4	383	18	1
6	5498	9.8	232	16	1
7	5499	9.1	377	17	1
8	5500	9.6	457	16	1
9	5501	8.0	471	18	1
10	5502	9.0	304	18	1
11	5503	8.0	316	17	1
12	5504	9.8	325	16	1
13	5505	8.0	409	17	0
14	5506	9.9	200	17	1
15	5507	8.8	458	16	1
16	5506	8.0	232	18	1
17	5505	8.3	250	16	1
18	5504	8.7	270	16	1
19	5503	7.7	350	17	1
20	5509	7.1	230	16	1
21	5501	7.3	416	18	1
22	5500	7.6	498	18	1
23	5499	7.3	286	17	1
24	5498	7.3	287	16	1
25	5497	7.5	462	17	1
26	5496	6.2	300	17	1
27	5495	6.4	323	18	0
28	5494	7.1	420	16	1
29	5493	7.2	395	18	1
30	5494	8.4	377	16	1
Detection Percentage (%)					90.000
Limit					60%
Test Result					Complied



Type 4 Radar Statistical Performance

Trial #	Test Freq. (MHz)	Pulse Width (us)	PRI (us)	Pulses / Burst	1=Detection 0=No Detection
1	5493	18.0	242	15	1
2	5491	19.9	279	12	1
3	5495	12.9	487	14	1
4	5496	15.0	452	13	1
5	5497	16.3	230	12	0
6	5498	19.8	238	13	1
7	5499	18.2	420	16	1
8	5500	16.3	452	15	1
9	5501	14.2	495	12	1
10	5502	17.8	228	16	1
11	5503	19.1	211	16	1
12	5504	18.4	283	15	0
13	5505	11.8	411	12	1
14	5506	14.2	284	13	1
15	5507	13.9	202	12	1
16	5506	17.8	340	14	1
17	5505	15.6	290	16	1
18	5504	14.6	250	16	1
19	5503	14.4	484	15	1
20	5509	18.9	387	13	1
21	5501	11.1	348	15	0
22	5500	13.8	291	16	1
23	5499	14.3	295	12	1
24	5498	12.5	300	12	1
25	5497	12.5	322	14	1
26	5496	12.5	383	13	1
27	5495	15.7	322	16	1
28	5494	19.8	469	13	1
29	5493	18.6	406	15	1
30	5494	15.9	238	14	1
Detection Percentage (%)					90.000
Limit					60%
Test Result					Complied



Total Type 1~4 Radar Statistical Performance

Radar Type #	Detection Percentage (%)
1	93.333
2	90.000
3	90.000
4	90.000
Aggregate (Radar Types 1-4)	90.833
Limit	80%
Test Result	Complied



Type 5 Radar Statistical Performance

Center Freq. (MHz)	Low Edge (MHz)	High Edge (MHz)	VSG Freq. (MHz)	Detection
Trial	Chirp	Offset		
1	5	0	5500	1
2	20	0	5500	1
3	7	0	5500	1
4	8	0	5500	1
5	9	0	5500	1
6	10	0	5500	1
7	11	0	5500	1
8	12	0	5500	1
9	13	0	5500	1
10	14	0	5500	1
11	15	6	5497	1
12	16	6.4	5497	1
13	17	6.8	5498	1
14	20	8	5499	1
15	19	7.6	5499	1
16	18	7.2	5498	1
17	17	6.8	5498	1
18	16	6.4	5497	1
19	15	6	5497	1
20	14	5.6	5497	1
21	13	5.2	5504	1
22	12	4.8	5504	1
23	11	4.4	5505	1
24	10	4	5505	1
25	9	3.6	5505	1
26	8	3.2	5506	1
27	18	7.2	5502	1
28	19	7.6	5501	1
29	20	8	5501	1
30	5	2	5507	1
Total				30
Detection Percentage (%)				100%
Limit				80%
Test Result				Complied



Trial Number							1
Number of Bursts in Trial							8
Chirp Center Frequency							5500
Burst	No. of Pulses	Pulse Width (us)	Chirp Width (MHz)	Pulse 1-to-2 Spacing (us)	Pulse 2-to-3 Spacing (us)	Starting Location Within Interval (ms)	
1	1	62.1	5	-	-	1091	
2	2	56	5	1729	-	133	
3	2	91.3	5	1230	-	1057	
4	3	50.7	5	1762	1616	1442	
5	2	92.6	5	1723	-	544	
6	2	87.3	5	1302	-	1089	
7	2	59.5	5	1291	-	1374	
8	2	52.2	5	1653	-	1237	
Detection Check (1=Detection; 0=No Detection)							1

Trial Number							2
Number of Bursts in Trial							9
Chirp Center Frequency							5500
Burst	No. of Pulses	Pulse Width (us)	Chirp Width (MHz)	Pulse 1-to-2 Spacing (us)	Pulse 2-to-3 Spacing (us)	Starting Location Within Interval (ms)	
1	3	90	20	1007	1326	30	
2	2	73.7	20	1785	-	979	
3	1	78.1	20	-	-	683	
4	2	92.4	20	1281	-	950	
5	1	61.2	20	-	-	612	
6	3	67.2	20	1525	1870	17	
7	1	78.5	20	-	-	429	
8	2	60.3	20	1931	-	936	
9	3	92.9	20	1403	1476	548	
Detection Check (1=Detection; 0=No Detection)							1



Trial Number							3
Number of Bursts in Trial							10
Chirp Center Frequency							5500
Burst	No. of Pulses	Pulse Width (us)	Chirp Width (MHz)	Pulse 1-to-2 Spacing (us)	Pulse 2-to-3 Spacing (us)	Starting Location Within Interval (ms)	
1	3	63.4	7	1574	1607	801	
2	1	98	7	-	-	966	
3	1	58.7	7	-	-	185	
4	1	88	7	-	-	1012	
5	3	79.5	7	1562	1370	943	
6	3	57.1	7	1900	1188	686	
7	2	64.4	7	1090	-	599	
8	1	78.7	7	-	-	1089	
9	1	69.3	7	-	-	188	
10	3	55.3	7	1375	1691	933	
Detection Check (1=Detection; 0=No Detection)							1

Trial Number							4
Number of Bursts in Trial							11
Chirp Center Frequency							5500
Burst	No. of Pulses	Pulse Width (us)	Chirp Width (MHz)	Pulse 1-to-2 Spacing (us)	Pulse 2-to-3 Spacing (us)	Starting Location Within Interval (ms)	
1	2	74.3	8	1642	-	24	
2	1	83.1	8	-	-	985	
3	2	59.5	8	1680	-	988	
4	2	59.8	8	1786	-	800	
5	2	77.6	8	1617	-	339	
6	2	79.9	8	1553	-	1040	
7	1	56	8	-	-	544	
8	3	71.4	8	1406	1927	452	
9	1	97.4	8	-	-	204	
10	2	98.3	8	1037	-	926	
11	1	63.6	8	-	-	1052	
Detection Check (1=Detection; 0=No Detection)							1



Trial Number							5
Number of Bursts in Trial							12
Chirp Center Frequency							5500
Burst	No. of Pulses	Pulse Width (us)	Chirp Width (MHz)	Pulse 1-to-2 Spacing (us)	Pulse 2-to-3 Spacing (us)	Starting Location Within Interval (ms)	
1	1	50	9	-	-	557	
2	2	62.5	9	1731	-	567	
3	2	55.4	9	1070	-	460	
4	1	65.7	9	-	-	4	
5	2	58	9	1512	-	64	
6	2	60.9	9	1230	-	650	
7	3	89.6	9	1598	1738	235	
8	3	84.4	9	1271	1617	873	
9	3	72.3	9	1498	1321	901	
10	1	58.9	9	-	-	663	
11	2	74.8	9	1584	-	919	
12	1	71.8	9	-	-	375	
Detection Check (1=Detection; 0=No Detection)							1

Trial Number							6
Number of Bursts in Trial							13
Chirp Center Frequency							5500
Burst	No. of Pulses	Pulse Width (us)	Chirp Width (MHz)	Pulse 1-to-2 Spacing (us)	Pulse 2-to-3 Spacing (us)	Starting Location Within Interval (ms)	
1	2	88.1	10	1257	-	846	
2	1	58.7	10	-	-	725	
3	2	97.1	10	1037	-	30	
4	3	83.1	10	1029	1106	490	
5	1	62.1	10	-	-	262	
6	2	71.4	10	1058	-	283	
7	2	86.3	10	1867	-	49	
8	3	77.3	10	1418	1876	634	
9	1	78.9	10	-	-	304	
10	3	79.2	10	1055	1572	564	
11	3	52	10	1582	1836	852	
12	3	56.5	10	1195	1542	525	
13	3	100	10	1638	1729	750	
Detection Check (1=Detection; 0=No Detection)							1



Trial Number							7
Number of Bursts in Trial							14
Chirp Center Frequency							5500
Burst	No. of Pulses	Pulse Width (us)	Chirp Width (MHz)	Pulse 1-to-2 Spacing (us)	Pulse 2-to-3 Spacing (us)	Starting Location Within Interval (ms)	
1	2	92.7	11	1208	-	231	
2	2	81.3	11	1144	-	804	
3	2	60.4	11	1555	-	34	
4	2	62.1	11	1320	-	427	
5	1	50	11	-	-	577	
6	3	65.9	11	1020	1365	3	
7	2	73.8	11	1308	-	51	
8	2	74.3	11	1143	-	360	
9	1	62.9	11	-	-	394	
10	2	74.8	11	1404	-	317	
11	2	69.7	11	1309	-	532	
12	2	69.8	11	1688	-	339	
13	2	77.4	11	1857	-	381	
14	1	55.1	11	-	-	426	
Detection Check (1=Detection; 0=No Detection)							1

Trial Number							8
Number of Bursts in Trial							15
Chirp Center Frequency							5500
Burst	No. of Pulses	Pulse Width (us)	Chirp Width (MHz)	Pulse 1-to-2 Spacing (us)	Pulse 2-to-3 Spacing (us)	Starting Location Within Interval (ms)	
1	1	91.7	12	-	-	776	
2	2	90	12	1196	-	187	
3	3	92.3	12	1486	1853	448	
4	2	66.8	12	1545	-	702	
5	1	64	12	-	-	403	
6	3	95.4	12	1123	1473	230	
7	3	66.8	12	1867	1401	604	
8	3	67.7	12	1472	1397	38	
9	1	68.2	12	-	-	735	
10	2	82.2	12	1297	-	610	
11	1	92.1	12	-	-	618	
12	2	57	12	1764	-	705	
13	2	58.5	12	1310	-	22	
14	3	85.5	12	1630	1447	641	
15	2	82.2	12	1371	-	109	
Detection Check (1=Detection; 0=No Detection)							1



Trial Number							9
Number of Bursts in Trial							16
Chirp Center Frequency							5500
Burst	No. of Pulses	Pulse Width (us)	Chirp Width (MHz)	Pulse 1-to-2 Spacing (us)	Pulse 2-to-3 Spacing (us)	Starting Location Within Interval (ms)	
1	2	74.4	13	1707	-	442	
2	2	63.6	13	1725	-	280	
3	2	71.3	13	1704	-	459	
4	3	77.6	13	1063	1405	197	
5	3	65.2	13	1731	1294	101	
6	3	55.1	13	1109	1549	17	
7	2	96.8	13	1034	-	131	
8	3	80.8	13	1533	1051	365	
9	1	60.4	13	-	-	222	
10	2	61.8	13	1312	-	371	
11	2	71.3	13	1657	-	33	
12	2	98.1	13	1024	-	291	
13	1	57.9	13	-	-	188	
14	1	91.8	13	-	-	163	
15	2	56.7	13	1259	-	426	
16	2	89.7	13	1690	-	606	
Detection Check (1=Detection; 0=No Detection)							1

Trial Number							10
Number of Bursts in Trial							17
Chirp Center Frequency							5500
Burst	No. of Pulses	Pulse Width (us)	Chirp Width (MHz)	Pulse 1-to-2 Spacing (us)	Pulse 2-to-3 Spacing (us)	Starting Location Within Interval (ms)	
1	2	74.4	14	1107	-	462	
2	1	87.6	14	-	-	653	
3	2	61.7	14	1741	-	457	
4	2	57.5	14	1566	-	388	
5	2	66.1	14	1855	-	63	
6	3	70.1	14	1044	1012	136	
7	1	66.4	14	-	-	343	
8	1	59.2	14	-	-	349	
9	2	88.3	14	1240	-	362	
10	1	64.7	14	-	-	221	
11	2	73	14	1703	-	144	
12	2	81.7	14	1450	-	671	
13	3	70.1	14	1741	1278	320	
14	1	63.6	14	-	-	196	
15	1	58.7	14	-	-	413	
16	2	65.9	14	1478	-	170	
17	1	72.7	14	-	-	564	
Detection Check (1=Detection; 0=No Detection)							1



Trial Number				11		
Number of Bursts in Trial				18		
Chirp Center Frequency				5497		
Burst	No. of Pulses	Pulse Width (us)	Chirp Width (MHz)	Pulse 1-to-2 Spacing (us)	Pulse 2-to-3 Spacing (us)	Starting Location Within Interval (ms)
1	2	72.1	15	1193	-	130
2	3	76.3	15	1484	1390	114
3	1	86.1	15	-	-	14
4	1	73.2	15	-	-	604
5	1	81.2	15	-	-	548
6	2	99.5	15	1398	-	173
7	1	93.9	15	-	-	262
8	2	75.9	15	1921	-	38
9	3	79.2	15	1100	1429	84
10	3	77	15	1166	1799	610
11	1	91.8	15	-	-	339
12	3	56.8	15	1330	1556	580
13	2	83.1	15	1556	-	295
14	2	63	15	1552	-	156
15	1	65.7	15	-	-	439
16	1	64.5	15	-	-	188
17	1	88.5	15	-	-	419
18	1	60.6	15	-	-	205
Detection Check (1=Detection; 0=No Detection)						1



Trial Number			12			
Number of Bursts in Trial			19			
Chirp Center Frequency			5497			
Burst	No. of Pulses	Pulse Width (us)	Chirp Width (MHz)	Pulse 1-to-2 Spacing (us)	Pulse 2-to-3 Spacing (us)	Starting Location Within Interval (ms)
1	2	90.5	16	1299	-	381
2	2	88.4	16	1418	-	327
3	2	53.7	16	1055	-	536
4	1	80.5	16	-	-	285
5	1	50.4	16	-	-	398
6	2	61.2	16	1749	-	439
7	2	78.8	16	1065	-	129
8	3	75	16	1748	1820	325
9	2	96.7	16	1254	-	440
10	3	76.3	16	1848	1106	397
11	1	73.3	16	-	-	232
12	2	92.4	16	1317	-	91
13	2	92.4	16	1854	-	256
14	3	64.4	16	1240	1634	582
15	2	67.3	16	1473	-	117
16	2	84.1	16	1795	-	202
17	1	80.9	16	-	-	135
18	1	74.6	16	-	-	396
19	2	97.6	16	1805	-	615
Detection Check (1=Detection; 0=No Detection)						1



Trial Number							13
Number of Bursts in Trial							20
Chirp Center Frequency							5498
Burst	No. of Pulses	Pulse Width (us)	Chirp Width (MHz)	Pulse 1-to-2 Spacing (us)	Pulse 2-to-3 Spacing (us)	Starting Location Within Interval (ms)	
1	2	66.1	17	1417	-	388	
2	2	86.7	17	1693	-	348	
3	2	70.5	17	1263	-	215	
4	2	78	17	1446	-	28	
5	2	66	17	1185	-	585	
6	2	80.6	17	1855	-	65	
7	1	95.5	17	-	-	92	
8	1	98.8	17	-	-	68	
9	3	64.3	17	1641	1108	517	
10	1	75.1	17	-	-	121	
11	2	72.6	17	1499	-	448	
12	1	60.3	17	-	-	567	
13	2	54.9	17	1056	-	245	
14	2	98.8	17	1023	-	584	
15	2	60.9	17	1243	-	579	
16	2	62.7	17	1226	-	464	
17	1	80.1	17	-	-	89	
18	2	70.9	17	1711	-	153	
19	1	90.7	17	-	-	282	
20	1	98.9	17	-	-	71	
Detection Check (1=Detection; 0=No Detection)							1

Trial Number							14
Number of Bursts in Trial							8
Chirp Center Frequency							5499
Burst	No. of Pulses	Pulse Width (us)	Chirp Width (MHz)	Pulse 1-to-2 Spacing (us)	Pulse 2-to-3 Spacing (us)	Starting Location Within Interval (ms)	
1	2	67.5	20	1542	-	947	
2	3	83.6	20	1272	1696	124	
3	2	93.2	20	1877	-	701	
4	1	55.6	20	-	-	1123	
5	3	84.2	20	1733	1619	756	
6	3	69.1	20	1612	1071	1	
7	2	66.9	20	1905	-	7	
8	3	86.8	20	1697	1621	1082	
Detection Check (1=Detection; 0=No Detection)							1



Trial Number							15
Number of Bursts in Trial							9
Chirp Center Frequency							5499
Burst	No. of Pulses	Pulse Width (us)	Chirp Width (MHz)	Pulse 1-to-2 Spacing (us)	Pulse 2-to-3 Spacing (us)	Starting Location Within Interval (ms)	
1	2	62.2	19	1571	-	949	
2	2	85	19	1669	-	189	
3	2	64.5	19	1505	-	176	
4	2	50.4	19	1325	-	538	
5	2	66.1	19	1483	-	908	
6	2	71.2	19	1110	-	1017	
7	3	53.7	19	1445	1677	492	
8	3	62.5	19	1596	1341	349	
9	3	62	19	1929	1221	1105	
Detection Check (1=Detection; 0=No Detection)							1

Trial Number							16
Number of Bursts in Trial							10
Chirp Center Frequency							5498
Burst	No. of Pulses	Pulse Width (us)	Chirp Width (MHz)	Pulse 1-to-2 Spacing (us)	Pulse 2-to-3 Spacing (us)	Starting Location Within Interval (ms)	
1	2	80.5	18	1910	-	284	
2	2	64.2	18	1661	-	751	
3	2	90.1	18	1041	-	491	
4	2	69.8	18	1495	-	107	
5	1	73.1	18	-	-	490	
6	3	77.2	18	1418	1145	1155	
7	3	52.6	18	1732	1787	772	
8	2	71.4	18	1562	-	121	
9	2	89.8	18	1491	-	89	
10	2	76.4	18	1355	-	615	
Detection Check (1=Detection; 0=No Detection)							1



Trial Number							17
Number of Bursts in Trial							11
Chirp Center Frequency							5498
Burst	No. of Pulses	Pulse Width (us)	Chirp Width (MHz)	Pulse 1-to-2 Spacing (us)	Pulse 2-to-3 Spacing (us)	Starting Location Within Interval (ms)	
1	2	51.2	17	1236	-	740	
2	1	71.7	17	-	-	941	
3	2	74.7	17	1164	-	370	
4	2	50.9	17	1919	-	371	
5	2	65.2	17	1206	-	1033	
6	2	98	17	1182	-	346	
7	2	58.7	17	1612	-	639	
8	1	63.8	17	-	-	1056	
9	3	86.3	17	1545	1065	205	
10	1	94.4	17	-	-	753	
11	3	88.5	17	1699	1319	58	
Detection Check (1=Detection; 0=No Detection)							1

Trial Number							18
Number of Bursts in Trial							12
Chirp Center Frequency							5497
Burst	No. of Pulses	Pulse Width (us)	Chirp Width (MHz)	Pulse 1-to-2 Spacing (us)	Pulse 2-to-3 Spacing (us)	Starting Location Within Interval (ms)	
1	2	88.7	16	1405	-	448	
2	3	90.2	16	1544	1235	621	
3	1	96.5	16	-	-	512	
4	2	80.5	16	1090	-	321	
5	2	63.7	16	1268	-	798	
6	1	53.4	16	-	-	809	
7	2	52.3	16	1043	-	301	
8	3	54.7	16	1701	1104	796	
9	3	75.6	16	1923	1729	669	
10	2	59.2	16	1244	-	369	
11	1	56.3	16	-	-	51	
12	2	87.8	16	1608	-	733	
Detection Check (1=Detection; 0=No Detection)							1



Trial Number							19
Number of Bursts in Trial							13
Chirp Center Frequency							5497
Burst	No. of Pulses	Pulse Width (us)	Chirp Width (MHz)	Pulse 1-to-2 Spacing (us)	Pulse 2-to-3 Spacing (us)	Starting Location Within Interval (ms)	
1	2	68.2	15	1104	-	229	
2	2	58.4	15	1627	-	488	
3	3	74.7	15	1861	1015	137	
4	2	58.2	15	1593	-	520	
5	1	51.6	15	-	-	799	
6	2	94.7	15	1469	-	43	
7	2	70.7	15	1091	-	126	
8	2	82.9	15	1472	-	607	
9	3	62.7	15	1168	1453	527	
10	2	63.1	15	1529	-	143	
11	1	96.1	15	-	-	176	
12	2	57	15	1457	-	882	
13	3	95.6	15	1707	1501	214	
Detection Check (1=Detection; 0=No Detection)							1

Trial Number							20
Number of Bursts in Trial							14
Chirp Center Frequency							5497
Burst	No. of Pulses	Pulse Width (us)	Chirp Width (MHz)	Pulse 1-to-2 Spacing (us)	Pulse 2-to-3 Spacing (us)	Starting Location Within Interval (ms)	
1	1	95.7	14	-	-	117	
2	1	93.1	14	-	-	720	
3	1	55.8	14	-	-	297	
4	1	76.7	14	-	-	284	
5	2	68	14	1686	-	472	
6	3	94.1	14	1796	1393	264	
7	2	53.9	14	1293	-	525	
8	1	99.3	14	-	-	155	
9	2	73.3	14	1458	-	65	
10	2	93.3	14	1196	-	451	
11	3	55.8	14	1895	1034	243	
12	1	66.4	14	-	-	228	
13	2	65.6	14	1732	-	746	
14	2	76.5	14	1187	-	522	
Detection Check (1=Detection; 0=No Detection)							1



Trial Number							21
Number of Bursts in Trial							15
Chirp Center Frequency							5504
Burst	No. of Pulses	Pulse Width (us)	Chirp Width (MHz)	Pulse 1-to-2 Spacing (us)	Pulse 2-to-3 Spacing (us)	Starting Location Within Interval (ms)	
1	1	85.1	13	-	-	565	
2	2	72.5	13	1648	-	211	
3	1	67.5	13	-	-	348	
4	2	56.1	13	1360	-	156	
5	1	71.1	13	-	-	718	
6	2	93.1	13	1391	-	400	
7	1	56.5	13	-	-	482	
8	1	63.8	13	-	-	703	
9	2	67.4	13	1727	-	780	
10	1	52.3	13	-	-	102	
11	3	62.4	13	1228	1715	304	
12	2	53.3	13	1630	-	57	
13	2	83.1	13	1205	-	768	
14	2	93.7	13	1085	-	461	
15	2	90.7	13	1297	-	746	
Detection Check (1=Detection; 0=No Detection)							1

Trial Number							22
Number of Bursts in Trial							16
Chirp Center Frequency							5504
Burst	No. of Pulses	Pulse Width (us)	Chirp Width (MHz)	Pulse 1-to-2 Spacing (us)	Pulse 2-to-3 Spacing (us)	Starting Location Within Interval (ms)	
1	2	98.8	12	1439	-	95	
2	1	54.5	12	-	-	676	
3	2	80.5	12	1360	-	8	
4	2	55.9	12	1906	-	373	
5	2	72.1	12	1623	-	254	
6	2	84.4	12	1604	-	480	
7	1	78.5	12	-	-	663	
8	1	88	12	-	-	314	
9	2	74.7	12	1157	-	596	
10	2	97.1	12	1673	-	264	
11	1	81.6	12	-	-	740	
12	1	83.6	12	-	-	163	
13	3	87.6	12	1757	1322	628	
14	2	58.5	12	1372	-	132	
15	3	91.8	12	1767	1183	106	
16	2	58.8	12	1432	-	659	
Detection Check (1=Detection; 0=No Detection)							1



Trial Number							23
Number of Bursts in Trial							17
Chirp Center Frequency							5505
Burst	No. of Pulses	Pulse Width (us)	Chirp Width (MHz)	Pulse 1-to-2 Spacing (us)	Pulse 2-to-3 Spacing (us)	Starting Location Within Interval (ms)	
1	1	96	11	-	-	284	
2	2	92.5	11	1241	-	488	
3	2	89.5	11	1347	-	76	
4	2	74.8	11	1607	-	688	
5	2	60.6	11	1523	-	28	
6	2	71.5	11	1659	-	383	
7	2	71.1	11	1454	-	182	
8	1	98.7	11	-	-	20	
9	2	85.1	11	1770	-	576	
10	2	89.2	11	1086	-	410	
11	2	60.7	11	1101	-	458	
12	2	75.2	11	1719	-	348	
13	2	75.7	11	1799	-	481	
14	3	56.7	11	1132	1884	587	
15	2	65	11	1885	-	480	
16	2	64.6	11	1910	-	195	
17	3	69.9	11	1410	1190	396	
Detection Check (1=Detection; 0=No Detection)							1

Trial Number							24
Number of Bursts in Trial							18
Chirp Center Frequency							5505
Burst	No. of Pulses	Pulse Width (us)	Chirp Width (MHz)	Pulse 1-to-2 Spacing (us)	Pulse 2-to-3 Spacing (us)	Starting Location Within Interval (ms)	
1	3	83.8	10	1290	1021	536	
2	2	66.9	10	1112	-	44	
3	3	91	10	1220	1504	611	
4	2	86.1	10	1678	-	456	
5	3	65.5	10	1928	1222	330	
6	1	62.6	10	-	-	297	
7	3	68.7	10	1505	1200	351	
8	3	59.2	10	1452	1114	230	
9	1	73.9	10	-	-	222	
10	1	77.2	10	-	-	57	
11	2	96.4	10	1357	-	399	
12	2	99.9	10	1173	-	299	
13	2	99.9	10	1520	-	464	
14	1	86.7	10	-	-	294	
15	1	92.6	10	-	-	653	
16	1	77.1	10	-	-	550	
17	2	81.1	10	1664	-	566	
18	3	68.4	10	1536	1309	580	
Detection Check (1=Detection; 0=No Detection)							1



Trial Number				25		
Number of Bursts in Trial				19		
Chirp Center Frequency				5505		
Burst	No. of Pulses	Pulse Width (us)	Chirp Width (MHz)	Pulse 1-to-2 Spacing (us)	Pulse 2-to-3 Spacing (us)	Starting Location Within Interval (ms)
1	3	68.2	9	1723	1868	471
2	3	83.7	9	1711	1405	368
3	2	69.7	9	1781	-	425
4	1	59.7	9	-	-	440
5	2	96.7	9	1484	-	123
6	2	95.8	9	1319	-	261
7	3	71.3	9	1095	1354	332
8	3	53.2	9	1527	1427	427
9	2	69.5	9	1771	-	397
10	3	63.9	9	1075	1447	67
11	2	93.4	9	1783	-	174
12	2	77.3	9	1564	-	17
13	2	73.1	9	1294	-	216
14	1	77.4	9	-	-	292
15	3	57.2	9	1722	1886	619
16	2	68.7	9	1629	-	233
17	1	60.8	9	-	-	226
18	3	69.7	9	1128	1224	599
19	1	62.2	9	-	-	433
Detection Check (1=Detection; 0=No Detection)						1



Trial Number							26
Number of Bursts in Trial							20
Chirp Center Frequency							5506
Burst	No. of Pulses	Pulse Width (us)	Chirp Width (MHz)	Pulse 1-to-2 Spacing (us)	Pulse 2-to-3 Spacing (us)	Starting Location Within Interval (ms)	
1	1	80.5	8	-	-	90	
2	3	62.6	8	1406	1343	319	
3	3	85.6	8	1190	1529	384	
4	2	83.9	8	1208	-	567	
5	2	92.4	8	1488	-	234	
6	2	54	8	1529	-	535	
7	3	81.3	8	1501	1812	325	
8	1	98.5	8	-	-	532	
9	1	85.8	8	-	-	272	
10	2	84.7	8	1593	-	182	
11	2	83.3	8	1705	-	134	
12	2	79.8	8	1567	-	286	
13	1	77.9	8	-	-	368	
14	3	98.4	8	1510	1569	290	
15	2	79.9	8	1588	-	231	
16	3	78	8	1140	1353	353	
17	3	55.2	8	1700	1327	53	
18	3	71.9	8	1081	1224	44	
19	1	62	8	-	-	298	
20	3	70.5	8	1888	1442	529	
Detection Check (1=Detection; 0=No Detection)							1

Trial Number							27
Number of Bursts in Trial							8
Chirp Center Frequency							5502
Burst	No. of Pulses	Pulse Width (us)	Chirp Width (MHz)	Pulse 1-to-2 Spacing (us)	Pulse 2-to-3 Spacing (us)	Starting Location Within Interval (ms)	
1	2	69.1	18	1076	-	1436	
2	2	62.1	18	1688	-	22	
3	2	94.8	18	1891	-	897	
4	1	75.8	18	-	-	1186	
5	2	65.4	18	1713	-	589	
6	2	97.7	18	1292	-	614	
7	3	98.1	18	1670	1711	506	
8	2	85.4	18	1672	-	776	
Detection Check (1=Detection; 0=No Detection)							1



Trial Number							28
Number of Bursts in Trial							9
Chirp Center Frequency							5501
Burst	No. of Pulses	Pulse Width (us)	Chirp Width (MHz)	Pulse 1-to-2 Spacing (us)	Pulse 2-to-3 Spacing (us)	Starting Location Within Interval (ms)	
1	3	82	19	1233	1713	679	
2	3	87.7	19	1554	1123	473	
3	2	98.9	19	1518	-	869	
4	1	55	19	-	-	719	
5	1	93.6	19	-	-	902	
6	2	58.7	19	1641	-	1243	
7	2	88.7	19	1387	-	410	
8	1	60.3	19	-	-	1154	
9	1	97.7	19	-	-	512	
Detection Check (1=Detection; 0=No Detection)							1

Trial Number							29
Number of Bursts in Trial							10
Chirp Center Frequency							5501
Burst	No. of Pulses	Pulse Width (us)	Chirp Width (MHz)	Pulse 1-to-2 Spacing (us)	Pulse 2-to-3 Spacing (us)	Starting Location Within Interval (ms)	
1	1	69.6	20	-	-	1131	
2	1	74.5	20	-	-	290	
3	1	60.9	20	-	-	895	
4	1	74.6	20	-	-	202	
5	2	99.3	20	1501	-	139	
6	2	95.3	20	1065	-	854	
7	2	91.9	20	1722	-	219	
8	2	51	20	1285	-	57	
9	2	87.7	20	1747	-	141	
10	1	87.2	20	-	-	596	
Detection Check (1=Detection; 0=No Detection)							1



Trial Number			30			
Number of Bursts in Trial			11			
Chirp Center Frequency			5507			
Burst	No. of Pulses	Pulse Width (us)	Chirp Width (MHz)	Pulse 1-to-2 Spacing (us)	Pulse 2-to-3 Spacing (us)	Starting Location Within Interval (ms)
1	3	59.9	5	1901	1196	935
2	2	77.1	5	1590	-	1038
3	2	62.7	5	1227	-	690
4	1	77.1	5	-	-	547
5	3	99.8	5	1798	1790	551
6	2	61.5	5	1135	-	876
7	2	77.5	5	1583	-	448
8	2	57.3	5	1890	-	736
9	2	53.5	5	1757	-	362
10	1	66.6	5	-	-	836
11	3	80.7	5	1811	1289	410
Detection Check (1=Detection; 0=No Detection)						1



Type 6 Radar Statistical Performance

Trial #	Test Freq. (MHz)	Pulses / Hop	Pulse Width (us)	PRI (us)	1=Detection 0=No Detection
1	5500	9	1	333	1
2	5500	9	1	333	1
3	5500	9	1	333	1
4	5500	9	1	333	1
5	5500	9	1	333	1
6	5500	9	1	333	1
7	5500	9	1	333	1
8	5500	9	1	333	1
9	5500	9	1	333	1
10	5500	9	1	333	0
11	5500	9	1	333	1
12	5500	9	1	333	1
13	5500	9	1	333	1
14	5500	9	1	333	1
15	5500	9	1	333	1
16	5500	9	1	333	1
17	5500	9	1	333	1
18	5500	9	1	333	1
19	5500	9	1	333	1
20	5500	9	1	333	0
21	5500	9	1	333	1
22	5500	9	1	333	1
23	5500	9	1	333	1
24	5500	9	1	333	1
25	5500	9	1	333	1
26	5500	9	1	333	1
27	5500	9	1	333	1
28	5500	9	1	333	1
29	5500	9	1	333	1
30	5500	9	1	333	1
Detection Percentage (%)					93.333
Limit					70%
Test Result					Complied



Modulation Mode: 802.11ac (VHT40) / 5510MHz

Type 1 Radar Statistical Performance

Trial #	Test Freq. (MHz)	Pulse Repetition Frequency Number	Pulse Repetition Frequency (Pulse Per Second)	PRI (us)	1=Detection 0=No Detection
1	5490	1	1930.5	518	1
2	5530	23	326.2	3066	1
3	5491	19	1139.0	878	1
4	5492	12	1355.0	738	1
5	5501	4	1730.1	578	0
6	5508	8	1519.8	658	1
7	5515	15	1253.1	798	1
8	5522	6	1618.1	618	1
9	5514	14	1285.3	778	1
10	5518	3	1792.1	558	1
11	5492	13	1319.3	758	1
12	5500	9	1474.9	678	1
13	5510	7	1567.4	638	0
14	5503	17	1193.3	838	1
15	5507	10	1432.7	698	1
16	5522	-	1692.0	591	1
17	5490	-	328.1	3048	1
18	5495	-	373.4	2678	1
19	5493	-	574.4	1741	1
20	5495	-	1216.5	822	0
21	5512	-	801.3	1248	1
22	5528	-	488.5	2047	1
23	5517	-	956.0	1046	1
24	5520	-	517.6	1932	1
25	5500	-	1422.5	703	1
26	5498	-	542.0	1845	1
27	5499	-	741.3	1349	1
28	5513	-	881.8	1134	1
29	5517	-	427.4	2340	1
30	5498	-	628.9	1590	1
Detection Percentage (%)					90.000
Limit					60%
Test Result					Complied



Type 2 Radar Statistical Performance

Trial #	Test Freq. (MHz)	Pulse Width (us)	PRI (us)	Pulses / Burst	1=Detection 0=No Detection
1	5490	2.6	221	23	1
2	5530	4.6	198	27	1
3	5491	1.1	184	29	1
4	5492	4.8	203	24	1
5	5501	2.4	162	25	0
6	5508	3.4	204	28	1
7	5515	2.3	170	27	1
8	5522	3.5	184	23	1
9	5514	4.9	150	27	1
10	5518	4.6	211	29	1
11	5492	2.9	158	23	1
12	5500	2.6	226	27	0
13	5510	1.6	204	26	1
14	5503	3.9	181	25	1
15	5507	4.6	202	24	1
16	5522	4.1	194	27	1
17	5490	2.3	193	28	1
18	5495	3.9	173	29	1
19	5493	4.3	188	23	1
20	5495	1.5	215	26	1
21	5512	4.9	227	27	1
22	5528	1.1	199	23	1
23	5517	4.5	155	29	1
24	5520	4.0	190	27	1
25	5500	2.4	151	23	1
26	5498	2.5	180	28	1
27	5499	2.5	228	23	1
28	5513	2.5	203	25	1
29	5517	1.5	188	25	1
30	5498	1.9	217	24	1
Detection Percentage (%)					93.333
Limit					60%
Test Result					Complied



Type 3 Radar Statistical Performance

Trial #	Test Freq. (MHz)	Pulse Width (us)	PRI (us)	Pulses / Burst	1=Detection 0=No Detection
1	5490	8.0	205	16	1
2	5530	6.7	382	18	1
3	5491	8.6	418	16	0
4	5492	9.4	351	17	1
5	5501	7.4	383	18	1
6	5508	9.8	232	16	1
7	5515	9.1	377	17	1
8	5522	9.6	457	16	1
9	5514	8.0	471	18	1
10	5518	9.0	304	18	0
11	5492	8.0	316	17	1
12	5500	9.8	325	16	1
13	5510	8.0	409	17	1
14	5503	9.9	200	17	1
15	5507	8.8	458	16	1
16	5522	8.0	232	18	0
17	5490	8.3	250	16	1
18	5495	8.7	270	16	1
19	5493	7.7	350	17	1
20	5495	7.1	230	16	0
21	5512	7.3	416	18	1
22	5528	7.6	498	18	1
23	5517	7.3	286	17	1
24	5520	7.3	287	16	1
25	5500	7.5	462	17	1
26	5498	6.2	300	17	1
27	5499	6.4	323	18	1
28	5513	7.1	420	16	1
29	5517	7.2	395	18	1
30	5498	8.4	377	16	1
Detection Percentage (%)					86.667
Limit					60%
Test Result					Complied



Type 4 Radar Statistical Performance

Trial #	Test Freq. (MHz)	Pulse Width (us)	PRI (us)	Pulses / Burst	1=Detection 0=No Detection
1	5490	18.0	242	15	1
2	5530	19.9	279	12	1
3	5491	12.9	487	14	1
4	5492	15.0	452	13	0
5	5501	16.3	230	12	1
6	5508	19.8	238	13	1
7	5515	18.2	420	16	1
8	5522	16.3	452	15	1
9	5514	14.2	495	12	0
10	5518	17.8	228	16	1
11	5492	19.1	211	16	1
12	5500	18.4	283	15	1
13	5510	11.8	411	12	1
14	5503	14.2	284	13	1
15	5507	13.9	202	12	1
16	5522	17.8	340	14	1
17	5490	15.6	290	16	1
18	5495	14.6	250	16	1
19	5493	14.4	484	15	1
20	5495	18.9	387	13	1
21	5512	11.1	348	15	0
22	5528	13.8	291	16	1
23	5517	14.3	295	12	1
24	5520	12.5	300	12	1
25	5500	12.5	322	14	1
26	5498	12.5	383	13	1
27	5499	15.7	322	16	1
28	5513	19.8	469	13	1
29	5517	18.6	406	15	1
30	5498	15.9	238	14	1
Detection Percentage (%)					90.000
Limit					60%
Test Result					Complied



Total Type 1~4 Radar Statistical Performance

Radar Type #	Detection Percentage (%)
1	90.000
2	93.333
3	86.667
4	90.000
Aggregate (Radar Types 1-4)	90.000
Limit	80%
Test Result	Complied



Type 5 Radar Statistical Performance

Center Freq. (MHz)	Low Edge (MHz)	High Edge (MHz)	VSG Freq. (MHz)	Detection
Trial	Chirp	Offset		
1	5	0	5510	1
2	20	0	5510	1
3	7	0	5510	1
4	8	0	5510	1
5	9	0	5510	1
6	10	0	5510	1
7	11	0	5510	1
8	12	0	5510	1
9	13	0	5510	1
10	14	0	5510	1
11	15	6	5496	1
12	16	6.4	5496	1
13	17	6.8	5497	1
14	20	8	5498	1
15	19	7.6	5498	1
16	18	7.2	5497	1
17	17	6.8	5497	1
18	16	6.4	5496	1
19	15	6	5496	1
20	14	5.6	5496	1
21	13	5.2	5525	1
22	12	4.8	5525	1
23	11	4.4	5526	1
24	10	4	5526	1
25	9	3.6	5526	1
26	8	3.2	5527	1
27	18	7.2	5523	1
28	19	7.6	5522	1
29	20	8	5522	1
30	5	2	5528	1
Total				30
Detection Percentage (%)				100%
Limit				80%
Test Result				Complied



Trial Number							1
Number of Bursts in Trial							8
Chirp Center Frequency							5510
Burst	No. of Pulses	Pulse Width (us)	Chirp Width (MHz)	Pulse 1-to-2 Spacing (us)	Pulse 2-to-3 Spacing (us)	Starting Location Within Interval (ms)	
1	1	62.1	5	-	-	1091	
2	2	56	5	1729	-	133	
3	2	91.3	5	1230	-	1057	
4	3	50.7	5	1762	1616	1442	
5	2	92.6	5	1723	-	544	
6	2	87.3	5	1302	-	1089	
7	2	59.5	5	1291	-	1374	
8	2	52.2	5	1653	-	1237	
Detection Check (1=Detection; 0=No Detection)							1

Trial Number							2
Number of Bursts in Trial							9
Chirp Center Frequency							5510
Burst	No. of Pulses	Pulse Width (us)	Chirp Width (MHz)	Pulse 1-to-2 Spacing (us)	Pulse 2-to-3 Spacing (us)	Starting Location Within Interval (ms)	
1	3	90	20	1007	1326	30	
2	2	73.7	20	1785	-	979	
3	1	78.1	20	-	-	683	
4	2	92.4	20	1281	-	950	
5	1	61.2	20	-	-	612	
6	3	67.2	20	1525	1870	17	
7	1	78.5	20	-	-	429	
8	2	60.3	20	1931	-	936	
9	3	92.9	20	1403	1476	548	
Detection Check (1=Detection; 0=No Detection)							1



Trial Number							3
Number of Bursts in Trial							10
Chirp Center Frequency							5510
Burst	No. of Pulses	Pulse Width (us)	Chirp Width (MHz)	Pulse 1-to-2 Spacing (us)	Pulse 2-to-3 Spacing (us)	Starting Location Within Interval (ms)	
1	3	63.4	7	1574	1607	801	
2	1	98	7	-	-	966	
3	1	58.7	7	-	-	185	
4	1	88	7	-	-	1012	
5	3	79.5	7	1562	1370	943	
6	3	57.1	7	1900	1188	686	
7	2	64.4	7	1090	-	599	
8	1	78.7	7	-	-	1089	
9	1	69.3	7	-	-	188	
10	3	55.3	7	1375	1691	933	
Detection Check (1=Detection; 0=No Detection)							1

Trial Number							4
Number of Bursts in Trial							11
Chirp Center Frequency							5510
Burst	No. of Pulses	Pulse Width (us)	Chirp Width (MHz)	Pulse 1-to-2 Spacing (us)	Pulse 2-to-3 Spacing (us)	Starting Location Within Interval (ms)	
1	2	74.3	8	1642	-	24	
2	1	83.1	8	-	-	985	
3	2	59.5	8	1680	-	988	
4	2	59.8	8	1786	-	800	
5	2	77.6	8	1617	-	339	
6	2	79.9	8	1553	-	1040	
7	1	56	8	-	-	544	
8	3	71.4	8	1406	1927	452	
9	1	97.4	8	-	-	204	
10	2	98.3	8	1037	-	926	
11	1	63.6	8	-	-	1052	
Detection Check (1=Detection; 0=No Detection)							1



Trial Number							5
Number of Bursts in Trial							12
Chirp Center Frequency							5510
Burst	No. of Pulses	Pulse Width (us)	Chirp Width (MHz)	Pulse 1-to-2 Spacing (us)	Pulse 2-to-3 Spacing (us)	Starting Location Within Interval (ms)	
1	1	50	9	-	-	557	
2	2	62.5	9	1731	-	567	
3	2	55.4	9	1070	-	460	
4	1	65.7	9	-	-	4	
5	2	58	9	1512	-	64	
6	2	60.9	9	1230	-	650	
7	3	89.6	9	1598	1738	235	
8	3	84.4	9	1271	1617	873	
9	3	72.3	9	1498	1321	901	
10	1	58.9	9	-	-	663	
11	2	74.8	9	1584	-	919	
12	1	71.8	9	-	-	375	
Detection Check (1=Detection; 0=No Detection)							1

Trial Number							6
Number of Bursts in Trial							13
Chirp Center Frequency							5510
Burst	No. of Pulses	Pulse Width (us)	Chirp Width (MHz)	Pulse 1-to-2 Spacing (us)	Pulse 2-to-3 Spacing (us)	Starting Location Within Interval (ms)	
1	2	88.1	10	1257	-	846	
2	1	58.7	10	-	-	725	
3	2	97.1	10	1037	-	30	
4	3	83.1	10	1029	1106	490	
5	1	62.1	10	-	-	262	
6	2	71.4	10	1058	-	283	
7	2	86.3	10	1867	-	49	
8	3	77.3	10	1418	1876	634	
9	1	78.9	10	-	-	304	
10	3	79.2	10	1055	1572	564	
11	3	52	10	1582	1836	852	
12	3	56.5	10	1195	1542	525	
13	3	100	10	1638	1729	750	
Detection Check (1=Detection; 0=No Detection)							1



Trial Number							7
Number of Bursts in Trial							14
Chirp Center Frequency							5510
Burst	No. of Pulses	Pulse Width (us)	Chirp Width (MHz)	Pulse 1-to-2 Spacing (us)	Pulse 2-to-3 Spacing (us)	Starting Location Within Interval (ms)	
1	2	92.7	11	1208	-	231	
2	2	81.3	11	1144	-	804	
3	2	60.4	11	1555	-	34	
4	2	62.1	11	1320	-	427	
5	1	50	11	-	-	577	
6	3	65.9	11	1020	1365	3	
7	2	73.8	11	1308	-	51	
8	2	74.3	11	1143	-	360	
9	1	62.9	11	-	-	394	
10	2	74.8	11	1404	-	317	
11	2	69.7	11	1309	-	532	
12	2	69.8	11	1688	-	339	
13	2	77.4	11	1857	-	381	
14	1	55.1	11	-	-	426	
Detection Check (1=Detection; 0=No Detection)							1

Trial Number							8
Number of Bursts in Trial							15
Chirp Center Frequency							5510
Burst	No. of Pulses	Pulse Width (us)	Chirp Width (MHz)	Pulse 1-to-2 Spacing (us)	Pulse 2-to-3 Spacing (us)	Starting Location Within Interval (ms)	
1	1	91.7	12	-	-	776	
2	2	90	12	1196	-	187	
3	3	92.3	12	1486	1853	448	
4	2	66.8	12	1545	-	702	
5	1	64	12	-	-	403	
6	3	95.4	12	1123	1473	230	
7	3	66.8	12	1867	1401	604	
8	3	67.7	12	1472	1397	38	
9	1	68.2	12	-	-	735	
10	2	82.2	12	1297	-	610	
11	1	92.1	12	-	-	618	
12	2	57	12	1764	-	705	
13	2	58.5	12	1310	-	22	
14	3	85.5	12	1630	1447	641	
15	2	82.2	12	1371	-	109	
Detection Check (1=Detection; 0=No Detection)							1



Trial Number							9
Number of Bursts in Trial							16
Chirp Center Frequency							5510
Burst	No. of Pulses	Pulse Width (us)	Chirp Width (MHz)	Pulse 1-to-2 Spacing (us)	Pulse 2-to-3 Spacing (us)	Starting Location Within Interval (ms)	
1	2	74.4	13	1707	-	442	
2	2	63.6	13	1725	-	280	
3	2	71.3	13	1704	-	459	
4	3	77.6	13	1063	1405	197	
5	3	65.2	13	1731	1294	101	
6	3	55.1	13	1109	1549	17	
7	2	96.8	13	1034	-	131	
8	3	80.8	13	1533	1051	365	
9	1	60.4	13	-	-	222	
10	2	61.8	13	1312	-	371	
11	2	71.3	13	1657	-	33	
12	2	98.1	13	1024	-	291	
13	1	57.9	13	-	-	188	
14	1	91.8	13	-	-	163	
15	2	56.7	13	1259	-	426	
16	2	89.7	13	1690	-	606	
Detection Check (1=Detection; 0=No Detection)							1

Trial Number							10
Number of Bursts in Trial							17
Chirp Center Frequency							5510
Burst	No. of Pulses	Pulse Width (us)	Chirp Width (MHz)	Pulse 1-to-2 Spacing (us)	Pulse 2-to-3 Spacing (us)	Starting Location Within Interval (ms)	
1	2	74.4	14	1107	-	462	
2	1	87.6	14	-	-	653	
3	2	61.7	14	1741	-	457	
4	2	57.5	14	1566	-	388	
5	2	66.1	14	1855	-	63	
6	3	70.1	14	1044	1012	136	
7	1	66.4	14	-	-	343	
8	1	59.2	14	-	-	349	
9	2	88.3	14	1240	-	362	
10	1	64.7	14	-	-	221	
11	2	73	14	1703	-	144	
12	2	81.7	14	1450	-	671	
13	3	70.1	14	1741	1278	320	
14	1	63.6	14	-	-	196	
15	1	58.7	14	-	-	413	
16	2	65.9	14	1478	-	170	
17	1	72.7	14	-	-	564	
Detection Check (1=Detection; 0=No Detection)							1



Trial Number				11		
Number of Bursts in Trial				18		
Chirp Center Frequency				5496		
Burst	No. of Pulses	Pulse Width (us)	Chirp Width (MHz)	Pulse 1-to-2 Spacing (us)	Pulse 2-to-3 Spacing (us)	Starting Location Within Interval (ms)
1	2	72.1	15	1193	-	130
2	3	76.3	15	1484	1390	114
3	1	86.1	15	-	-	14
4	1	73.2	15	-	-	604
5	1	81.2	15	-	-	548
6	2	99.5	15	1398	-	173
7	1	93.9	15	-	-	262
8	2	75.9	15	1921	-	38
9	3	79.2	15	1100	1429	84
10	3	77	15	1166	1799	610
11	1	91.8	15	-	-	339
12	3	56.8	15	1330	1556	580
13	2	83.1	15	1556	-	295
14	2	63	15	1552	-	156
15	1	65.7	15	-	-	439
16	1	64.5	15	-	-	188
17	1	88.5	15	-	-	419
18	1	60.6	15	-	-	205
Detection Check (1=Detection; 0=No Detection)						1



Trial Number			12			
Number of Bursts in Trial			19			
Chirp Center Frequency			5496			
Burst	No. of Pulses	Pulse Width (us)	Chirp Width (MHz)	Pulse 1-to-2 Spacing (us)	Pulse 2-to-3 Spacing (us)	Starting Location Within Interval (ms)
1	2	90.5	16	1299	-	381
2	2	88.4	16	1418	-	327
3	2	53.7	16	1055	-	536
4	1	80.5	16	-	-	285
5	1	50.4	16	-	-	398
6	2	61.2	16	1749	-	439
7	2	78.8	16	1065	-	129
8	3	75	16	1748	1820	325
9	2	96.7	16	1254	-	440
10	3	76.3	16	1848	1106	397
11	1	73.3	16	-	-	232
12	2	92.4	16	1317	-	91
13	2	92.4	16	1854	-	256
14	3	64.4	16	1240	1634	582
15	2	67.3	16	1473	-	117
16	2	84.1	16	1795	-	202
17	1	80.9	16	-	-	135
18	1	74.6	16	-	-	396
19	2	97.6	16	1805	-	615
Detection Check (1=Detection; 0=No Detection)						1



Trial Number							13
Number of Bursts in Trial							20
Chirp Center Frequency							5497
Burst	No. of Pulses	Pulse Width (us)	Chirp Width (MHz)	Pulse 1-to-2 Spacing (us)	Pulse 2-to-3 Spacing (us)	Starting Location Within Interval (ms)	
1	2	66.1	17	1417	-	388	
2	2	86.7	17	1693	-	348	
3	2	70.5	17	1263	-	215	
4	2	78	17	1446	-	28	
5	2	66	17	1185	-	585	
6	2	80.6	17	1855	-	65	
7	1	95.5	17	-	-	92	
8	1	98.8	17	-	-	68	
9	3	64.3	17	1641	1108	517	
10	1	75.1	17	-	-	121	
11	2	72.6	17	1499	-	448	
12	1	60.3	17	-	-	567	
13	2	54.9	17	1056	-	245	
14	2	98.8	17	1023	-	584	
15	2	60.9	17	1243	-	579	
16	2	62.7	17	1226	-	464	
17	1	80.1	17	-	-	89	
18	2	70.9	17	1711	-	153	
19	1	90.7	17	-	-	282	
20	1	98.9	17	-	-	71	
Detection Check (1=Detection; 0=No Detection)							1

Trial Number							14
Number of Bursts in Trial							8
Chirp Center Frequency							5498
Burst	No. of Pulses	Pulse Width (us)	Chirp Width (MHz)	Pulse 1-to-2 Spacing (us)	Pulse 2-to-3 Spacing (us)	Starting Location Within Interval (ms)	
1	2	67.5	20	1542	-	947	
2	3	83.6	20	1272	1696	124	
3	2	93.2	20	1877	-	701	
4	1	55.6	20	-	-	1123	
5	3	84.2	20	1733	1619	756	
6	3	69.1	20	1612	1071	1	
7	2	66.9	20	1905	-	7	
8	3	86.8	20	1697	1621	1082	
Detection Check (1=Detection; 0=No Detection)							1



Trial Number							15
Number of Bursts in Trial							9
Chirp Center Frequency							5498
Burst	No. of Pulses	Pulse Width (us)	Chirp Width (MHz)	Pulse 1-to-2 Spacing (us)	Pulse 2-to-3 Spacing (us)	Starting Location Within Interval (ms)	
1	2	62.2	19	1571	-	949	
2	2	85	19	1669	-	189	
3	2	64.5	19	1505	-	176	
4	2	50.4	19	1325	-	538	
5	2	66.1	19	1483	-	908	
6	2	71.2	19	1110	-	1017	
7	3	53.7	19	1445	1677	492	
8	3	62.5	19	1596	1341	349	
9	3	62	19	1929	1221	1105	
Detection Check (1=Detection; 0=No Detection)							1

Trial Number							16
Number of Bursts in Trial							10
Chirp Center Frequency							5497
Burst	No. of Pulses	Pulse Width (us)	Chirp Width (MHz)	Pulse 1-to-2 Spacing (us)	Pulse 2-to-3 Spacing (us)	Starting Location Within Interval (ms)	
1	2	80.5	18	1910	-	284	
2	2	64.2	18	1661	-	751	
3	2	90.1	18	1041	-	491	
4	2	69.8	18	1495	-	107	
5	1	73.1	18	-	-	490	
6	3	77.2	18	1418	1145	1155	
7	3	52.6	18	1732	1787	772	
8	2	71.4	18	1562	-	121	
9	2	89.8	18	1491	-	89	
10	2	76.4	18	1355	-	615	
Detection Check (1=Detection; 0=No Detection)							1



Trial Number							17
Number of Bursts in Trial							11
Chirp Center Frequency							5497
Burst	No. of Pulses	Pulse Width (us)	Chirp Width (MHz)	Pulse 1-to-2 Spacing (us)	Pulse 2-to-3 Spacing (us)	Starting Location Within Interval (ms)	
1	2	51.2	17	1236	-	740	
2	1	71.7	17	-	-	941	
3	2	74.7	17	1164	-	370	
4	2	50.9	17	1919	-	371	
5	2	65.2	17	1206	-	1033	
6	2	98	17	1182	-	346	
7	2	58.7	17	1612	-	639	
8	1	63.8	17	-	-	1056	
9	3	86.3	17	1545	1065	205	
10	1	94.4	17	-	-	753	
11	3	88.5	17	1699	1319	58	
Detection Check (1=Detection; 0=No Detection)							1

Trial Number							18
Number of Bursts in Trial							12
Chirp Center Frequency							5496
Burst	No. of Pulses	Pulse Width (us)	Chirp Width (MHz)	Pulse 1-to-2 Spacing (us)	Pulse 2-to-3 Spacing (us)	Starting Location Within Interval (ms)	
1	2	88.7	16	1405	-	448	
2	3	90.2	16	1544	1235	621	
3	1	96.5	16	-	-	512	
4	2	80.5	16	1090	-	321	
5	2	63.7	16	1268	-	798	
6	1	53.4	16	-	-	809	
7	2	52.3	16	1043	-	301	
8	3	54.7	16	1701	1104	796	
9	3	75.6	16	1923	1729	669	
10	2	59.2	16	1244	-	369	
11	1	56.3	16	-	-	51	
12	2	87.8	16	1608	-	733	
Detection Check (1=Detection; 0=No Detection)							1



Trial Number							19
Number of Bursts in Trial							13
Chirp Center Frequency							5496
Burst	No. of Pulses	Pulse Width (us)	Chirp Width (MHz)	Pulse 1-to-2 Spacing (us)	Pulse 2-to-3 Spacing (us)	Starting Location Within Interval (ms)	
1	2	68.2	15	1104	-	229	
2	2	58.4	15	1627	-	488	
3	3	74.7	15	1861	1015	137	
4	2	58.2	15	1593	-	520	
5	1	51.6	15	-	-	799	
6	2	94.7	15	1469	-	43	
7	2	70.7	15	1091	-	126	
8	2	82.9	15	1472	-	607	
9	3	62.7	15	1168	1453	527	
10	2	63.1	15	1529	-	143	
11	1	96.1	15	-	-	176	
12	2	57	15	1457	-	882	
13	3	95.6	15	1707	1501	214	
Detection Check (1=Detection; 0=No Detection)							1

Trial Number							20
Number of Bursts in Trial							14
Chirp Center Frequency							5496
Burst	No. of Pulses	Pulse Width (us)	Chirp Width (MHz)	Pulse 1-to-2 Spacing (us)	Pulse 2-to-3 Spacing (us)	Starting Location Within Interval (ms)	
1	1	95.7	14	-	-	117	
2	1	93.1	14	-	-	720	
3	1	55.8	14	-	-	297	
4	1	76.7	14	-	-	284	
5	2	68	14	1686	-	472	
6	3	94.1	14	1796	1393	264	
7	2	53.9	14	1293	-	525	
8	1	99.3	14	-	-	155	
9	2	73.3	14	1458	-	65	
10	2	93.3	14	1196	-	451	
11	3	55.8	14	1895	1034	243	
12	1	66.4	14	-	-	228	
13	2	65.6	14	1732	-	746	
14	2	76.5	14	1187	-	522	
Detection Check (1=Detection; 0=No Detection)							1



Trial Number							21
Number of Bursts in Trial							15
Chirp Center Frequency							5525
Burst	No. of Pulses	Pulse Width (us)	Chirp Width (MHz)	Pulse 1-to-2 Spacing (us)	Pulse 2-to-3 Spacing (us)	Starting Location Within Interval (ms)	
1	1	85.1	13	-	-	565	
2	2	72.5	13	1648	-	211	
3	1	67.5	13	-	-	348	
4	2	56.1	13	1360	-	156	
5	1	71.1	13	-	-	718	
6	2	93.1	13	1391	-	400	
7	1	56.5	13	-	-	482	
8	1	63.8	13	-	-	703	
9	2	67.4	13	1727	-	780	
10	1	52.3	13	-	-	102	
11	3	62.4	13	1228	1715	304	
12	2	53.3	13	1630	-	57	
13	2	83.1	13	1205	-	768	
14	2	93.7	13	1085	-	461	
15	2	90.7	13	1297	-	746	
Detection Check (1=Detection; 0=No Detection)							1

Trial Number							22
Number of Bursts in Trial							16
Chirp Center Frequency							5525
Burst	No. of Pulses	Pulse Width (us)	Chirp Width (MHz)	Pulse 1-to-2 Spacing (us)	Pulse 2-to-3 Spacing (us)	Starting Location Within Interval (ms)	
1	2	98.8	12	1439	-	95	
2	1	54.5	12	-	-	676	
3	2	80.5	12	1360	-	8	
4	2	55.9	12	1906	-	373	
5	2	72.1	12	1623	-	254	
6	2	84.4	12	1604	-	480	
7	1	78.5	12	-	-	663	
8	1	88	12	-	-	314	
9	2	74.7	12	1157	-	596	
10	2	97.1	12	1673	-	264	
11	1	81.6	12	-	-	740	
12	1	83.6	12	-	-	163	
13	3	87.6	12	1757	1322	628	
14	2	58.5	12	1372	-	132	
15	3	91.8	12	1767	1183	106	
16	2	58.8	12	1432	-	659	
Detection Check (1=Detection; 0=No Detection)							1



Trial Number							23
Number of Bursts in Trial							17
Chirp Center Frequency							5526
Burst	No. of Pulses	Pulse Width (us)	Chirp Width (MHz)	Pulse 1-to-2 Spacing (us)	Pulse 2-to-3 Spacing (us)	Starting Location Within Interval (ms)	
1	1	96	11	-	-	284	
2	2	92.5	11	1241	-	488	
3	2	89.5	11	1347	-	76	
4	2	74.8	11	1607	-	688	
5	2	60.6	11	1523	-	28	
6	2	71.5	11	1659	-	383	
7	2	71.1	11	1454	-	182	
8	1	98.7	11	-	-	20	
9	2	85.1	11	1770	-	576	
10	2	89.2	11	1086	-	410	
11	2	60.7	11	1101	-	458	
12	2	75.2	11	1719	-	348	
13	2	75.7	11	1799	-	481	
14	3	56.7	11	1132	1884	587	
15	2	65	11	1885	-	480	
16	2	64.6	11	1910	-	195	
17	3	69.9	11	1410	1190	396	
Detection Check (1=Detection; 0=No Detection)							1

Trial Number							24
Number of Bursts in Trial							18
Chirp Center Frequency							5526
Burst	No. of Pulses	Pulse Width (us)	Chirp Width (MHz)	Pulse 1-to-2 Spacing (us)	Pulse 2-to-3 Spacing (us)	Starting Location Within Interval (ms)	
1	3	83.8	10	1290	1021	536	
2	2	66.9	10	1112	-	44	
3	3	91	10	1220	1504	611	
4	2	86.1	10	1678	-	456	
5	3	65.5	10	1928	1222	330	
6	1	62.6	10	-	-	297	
7	3	68.7	10	1505	1200	351	
8	3	59.2	10	1452	1114	230	
9	1	73.9	10	-	-	222	
10	1	77.2	10	-	-	57	
11	2	96.4	10	1357	-	399	
12	2	99.9	10	1173	-	299	
13	2	99.9	10	1520	-	464	
14	1	86.7	10	-	-	294	
15	1	92.6	10	-	-	653	
16	1	77.1	10	-	-	550	
17	2	81.1	10	1664	-	566	
18	3	68.4	10	1536	1309	580	
Detection Check (1=Detection; 0=No Detection)							1



Trial Number				25		
Number of Bursts in Trial				19		
Chirp Center Frequency				5526		
Burst	No. of Pulses	Pulse Width (us)	Chirp Width (MHz)	Pulse 1-to-2 Spacing (us)	Pulse 2-to-3 Spacing (us)	Starting Location Within Interval (ms)
1	3	68.2	9	1723	1868	471
2	3	83.7	9	1711	1405	368
3	2	69.7	9	1781	-	425
4	1	59.7	9	-	-	440
5	2	96.7	9	1484	-	123
6	2	95.8	9	1319	-	261
7	3	71.3	9	1095	1354	332
8	3	53.2	9	1527	1427	427
9	2	69.5	9	1771	-	397
10	3	63.9	9	1075	1447	67
11	2	93.4	9	1783	-	174
12	2	77.3	9	1564	-	17
13	2	73.1	9	1294	-	216
14	1	77.4	9	-	-	292
15	3	57.2	9	1722	1886	619
16	2	68.7	9	1629	-	233
17	1	60.8	9	-	-	226
18	3	69.7	9	1128	1224	599
19	1	62.2	9	-	-	433
Detection Check (1=Detection; 0=No Detection)						1



Trial Number							26
Number of Bursts in Trial							20
Chirp Center Frequency							5527
Burst	No. of Pulses	Pulse Width (us)	Chirp Width (MHz)	Pulse 1-to-2 Spacing (us)	Pulse 2-to-3 Spacing (us)	Starting Location Within Interval (ms)	
1	1	80.5	8	-	-	90	
2	3	62.6	8	1406	1343	319	
3	3	85.6	8	1190	1529	384	
4	2	83.9	8	1208	-	567	
5	2	92.4	8	1488	-	234	
6	2	54	8	1529	-	535	
7	3	81.3	8	1501	1812	325	
8	1	98.5	8	-	-	532	
9	1	85.8	8	-	-	272	
10	2	84.7	8	1593	-	182	
11	2	83.3	8	1705	-	134	
12	2	79.8	8	1567	-	286	
13	1	77.9	8	-	-	368	
14	3	98.4	8	1510	1569	290	
15	2	79.9	8	1588	-	231	
16	3	78	8	1140	1353	353	
17	3	55.2	8	1700	1327	53	
18	3	71.9	8	1081	1224	44	
19	1	62	8	-	-	298	
20	3	70.5	8	1888	1442	529	
Detection Check (1=Detection; 0=No Detection)							1

Trial Number							27
Number of Bursts in Trial							8
Chirp Center Frequency							5523
Burst	No. of Pulses	Pulse Width (us)	Chirp Width (MHz)	Pulse 1-to-2 Spacing (us)	Pulse 2-to-3 Spacing (us)	Starting Location Within Interval (ms)	
1	2	69.1	18	1076	-	1436	
2	2	62.1	18	1688	-	22	
3	2	94.8	18	1891	-	897	
4	1	75.8	18	-	-	1186	
5	2	65.4	18	1713	-	589	
6	2	97.7	18	1292	-	614	
7	3	98.1	18	1670	1711	506	
8	2	85.4	18	1672	-	776	
Detection Check (1=Detection; 0=No Detection)							1



Trial Number							28
Number of Bursts in Trial							9
Chirp Center Frequency							5522
Burst	No. of Pulses	Pulse Width (us)	Chirp Width (MHz)	Pulse 1-to-2 Spacing (us)	Pulse 2-to-3 Spacing (us)	Starting Location Within Interval (ms)	
1	3	82	19	1233	1713	679	
2	3	87.7	19	1554	1123	473	
3	2	98.9	19	1518	-	869	
4	1	55	19	-	-	719	
5	1	93.6	19	-	-	902	
6	2	58.7	19	1641	-	1243	
7	2	88.7	19	1387	-	410	
8	1	60.3	19	-	-	1154	
9	1	97.7	19	-	-	512	
Detection Check (1=Detection; 0=No Detection)							1

Trial Number							29
Number of Bursts in Trial							10
Chirp Center Frequency							5522
Burst	No. of Pulses	Pulse Width (us)	Chirp Width (MHz)	Pulse 1-to-2 Spacing (us)	Pulse 2-to-3 Spacing (us)	Starting Location Within Interval (ms)	
1	1	69.6	20	-	-	1131	
2	1	74.5	20	-	-	290	
3	1	60.9	20	-	-	895	
4	1	74.6	20	-	-	202	
5	2	99.3	20	1501	-	139	
6	2	95.3	20	1065	-	854	
7	2	91.9	20	1722	-	219	
8	2	51	20	1285	-	57	
9	2	87.7	20	1747	-	141	
10	1	87.2	20	-	-	596	
Detection Check (1=Detection; 0=No Detection)							1



Trial Number			30			
Number of Bursts in Trial			11			
Chirp Center Frequency			5528			
Burst	No. of Pulses	Pulse Width (us)	Chirp Width (MHz)	Pulse 1-to-2 Spacing (us)	Pulse 2-to-3 Spacing (us)	Starting Location Within Interval (ms)
1	3	59.9	5	1901	1196	935
2	2	77.1	5	1590	-	1038
3	2	62.7	5	1227	-	690
4	1	77.1	5	-	-	547
5	3	99.8	5	1798	1790	551
6	2	61.5	5	1135	-	876
7	2	77.5	5	1583	-	448
8	2	57.3	5	1890	-	736
9	2	53.5	5	1757	-	362
10	1	66.6	5	-	-	836
11	3	80.7	5	1811	1289	410
Detection Check (1=Detection; 0=No Detection)						1



Type 6 Radar Statistical Performance

Trial #	Test Freq. (MHz)	Pulses / Hop	Pulse Width (us)	PRI (us)	1=Detection 0=No Detection
1	5510	9	1	333	1
2	5510	9	1	333	1
3	5510	9	1	333	1
4	5510	9	1	333	1
5	5510	9	1	333	0
6	5510	9	1	333	1
7	5510	9	1	333	1
8	5510	9	1	333	1
9	5510	9	1	333	1
10	5510	9	1	333	1
11	5510	9	1	333	1
12	5510	9	1	333	1
13	5510	9	1	333	1
14	5510	9	1	333	1
15	5510	9	1	333	1
16	5510	9	1	333	1
17	5510	9	1	333	0
18	5510	9	1	333	1
19	5510	9	1	333	1
20	5510	9	1	333	1
21	5510	9	1	333	1
22	5510	9	1	333	1
23	5510	9	1	333	1
24	5510	9	1	333	1
25	5510	9	1	333	1
26	5510	9	1	333	1
27	5510	9	1	333	1
28	5510	9	1	333	1
29	5510	9	1	333	1
30	5510	9	1	333	1
Detection Percentage (%)					93.333
Limit					70%
Test Result					Complied



Modulation Mode: 802.11ac (VHT80) / 5530MHz

Type 1 Radar Statistical Performance

Trial #	Test Freq. (MHz)	Pulse Repetition Frequency Number	Pulse Repetition Frequency (Pulse Per Second)	PRI (us)	1=Detection 0=No Detection
1	5491	1	1930.5	518	1
2	5552	23	326.2	3066	1
3	5492	19	1139.0	878	1
4	5493	12	1355.0	738	1
5	5494	4	1730.1	578	1
6	5495	8	1519.8	658	0
7	5496	15	1253.1	798	0
8	5497	6	1618.1	618	1
9	5498	14	1285.3	778	1
10	5500	3	1792.1	558	1
11	5502	13	1319.3	758	1
12	5504	9	1474.9	678	1
13	5506	7	1567.4	638	1
14	5508	17	1193.3	838	0
15	5510	10	1432.7	698	1
16	5512	-	1692.0	591	1
17	5514	-	328.1	3048	1
18	5516	-	373.4	2678	1
19	5518	-	574.4	1741	1
20	5520	-	1216.5	822	1
21	5522	-	801.3	1248	1
22	5524	-	488.5	2047	1
23	5526	-	956.0	1046	1
24	5528	-	517.6	1932	1
25	5530	-	1422.5	703	1
26	5532	-	542.0	1845	1
27	5534	-	741.3	1349	1
28	5536	-	881.8	1134	1
29	5538	-	427.4	2340	1
30	5540	-	628.9	1590	1
Detection Percentage (%)					90.000
Limit					60%
Test Result					Complied



Type 2 Radar Statistical Performance

Trial #	Test Freq. (MHz)	Pulse Width (us)	PRI (us)	Pulses / Burst	1=Detection 0=No Detection
1	5491	2.6	221	23	1
2	5552	4.6	198	27	1
3	5492	1.1	184	29	1
4	5493	4.8	203	24	1
5	5494	2.4	162	25	1
6	5495	3.4	204	28	1
7	5496	2.3	170	27	1
8	5497	3.5	184	23	1
9	5498	4.9	150	27	1
10	5500	4.6	211	29	1
11	5502	2.9	158	23	0
12	5504	2.6	226	27	1
13	5506	1.6	204	26	1
14	5508	3.9	181	25	1
15	5510	4.6	202	24	1
16	5512	4.1	194	27	1
17	5514	2.3	193	28	1
18	5516	3.9	173	29	1
19	5518	4.3	188	23	0
20	5520	1.5	215	26	1
21	5522	4.9	227	27	1
22	5524	1.1	199	23	1
23	5526	4.5	155	29	1
24	5528	4.0	190	27	1
25	5530	2.4	151	23	1
26	5532	2.5	180	28	1
27	5534	2.5	228	23	1
28	5536	2.5	203	25	1
29	5538	1.5	188	25	1
30	5540	1.9	217	24	1
Detection Percentage (%)					93.333
Limit					60%
Test Result					Complied



Type 3 Radar Statistical Performance

Trial #	Test Freq. (MHz)	Pulse Width (us)	PRI (us)	Pulses / Burst	1=Detection 0=No Detection
1	5491	8.0	205	16	1
2	5552	6.7	382	18	1
3	5492	8.6	418	16	1
4	5493	9.4	351	17	1
5	5494	7.4	383	18	1
6	5495	9.8	232	16	1
7	5496	9.1	377	17	0
8	5497	9.6	457	16	1
9	5498	8.0	471	18	1
10	5500	9.0	304	18	1
11	5502	8.0	316	17	1
12	5504	9.8	325	16	1
13	5506	8.0	409	17	0
14	5508	9.9	200	17	1
15	5510	8.8	458	16	1
16	5512	8.0	232	18	1
17	5514	8.3	250	16	1
18	5516	8.7	270	16	1
19	5518	7.7	350	17	0
20	5520	7.1	230	16	1
21	5522	7.3	416	18	1
22	5524	7.6	498	18	1
23	5526	7.3	286	17	1
24	5528	7.3	287	16	1
25	5530	7.5	462	17	1
26	5532	6.2	300	17	1
27	5534	6.4	323	18	1
28	5536	7.1	420	16	1
29	5538	7.2	395	18	1
30	5540	8.4	377	16	1
Detection Percentage (%)					90.000
Limit					60%
Test Result					Complied



Type 4 Radar Statistical Performance

Trial #	Test Freq. (MHz)	Pulse Width (us)	PRF (us)	Pulses / Burst	1=Detection 0=No Detection
1	5491	18.0	242	15	1
2	5552	19.9	279	12	1
3	5492	12.9	487	14	1
4	5493	15.0	452	13	0
5	5494	16.3	230	12	1
6	5495	19.8	238	13	1
7	5496	18.2	420	16	1
8	5497	16.3	452	15	1
9	5498	14.2	495	12	1
10	5500	17.8	228	16	1
11	5502	19.1	211	16	0
12	5504	18.4	283	15	1
13	5506	11.8	411	12	1
14	5508	14.2	284	13	1
15	5510	13.9	202	12	1
16	5512	17.8	340	14	1
17	5514	15.6	290	16	1
18	5516	14.6	250	16	1
19	5518	14.4	484	15	0
20	5520	18.9	387	13	1
21	5522	11.1	348	15	1
22	5524	13.8	291	16	1
23	5526	14.3	295	12	1
24	5528	12.5	300	12	0
25	5530	12.5	322	14	1
26	5532	12.5	383	13	1
27	5534	15.7	322	16	1
28	5536	19.8	469	13	1
29	5538	18.6	406	15	1
30	5540	15.9	238	14	1
Detection Percentage (%)					86.667
Limit					60%
Test Result					Complied



Total Type 1~4 Radar Statistical Performance

Radar Type #	Detection Percentage (%)
1	90.000
2	93.333
3	90.000
4	86.667
Aggregate (Radar Types 1-4)	90.000
Limit	80%
Test Result	Complied



Type 5 Radar Statistical Performance

Center Freq. (MHz)	Low Edge (MHz)	High Edge (MHz)	VSG Freq. (MHz)	Detection
Trial	Chirp	Offset		
1	5	0	5530	1
2	20	0	5530	1
3	7	0	5530	1
4	8	0	5530	1
5	9	0	5530	1
6	10	0	5530	1
7	11	0	5530	1
8	12	0	5530	1
9	13	0	5530	1
10	14	0	5530	1
11	15	6	5497	1
12	16	6.4	5497	1
13	17	6.8	5498	1
14	20	8	5499	1
15	19	7.6	5499	1
16	18	7.2	5498	1
17	17	6.8	5498	1
18	16	6.4	5497	1
19	15	6	5497	1
20	14	5.6	5497	1
21	13	5.2	5564	1
22	12	4.8	5564	1
23	11	4.4	5565	1
24	10	4	5565	1
25	9	3.6	5565	1
26	8	3.2	5566	1
27	18	7.2	5562	1
28	19	7.6	5561	1
29	20	8	5561	1
30	5	2	5567	1
Total				30
Detection Percentage (%)				100%
Limit				80%
Test Result				Complied



Trial Number							1
Number of Bursts in Trial							8
Chirp Center Frequency							5530
Burst	No. of Pulses	Pulse Width (us)	Chirp Width (MHz)	Pulse 1-to-2 Spacing (us)	Pulse 2-to-3 Spacing (us)	Starting Location Within Interval (ms)	
1	1	62.1	5	-	-	1091	
2	2	56	5	1729	-	133	
3	2	91.3	5	1230	-	1057	
4	3	50.7	5	1762	1616	1442	
5	2	92.6	5	1723	-	544	
6	2	87.3	5	1302	-	1089	
7	2	59.5	5	1291	-	1374	
8	2	52.2	5	1653	-	1237	
Detection Check (1=Detection; 0=No Detection)							1

Trial Number							2
Number of Bursts in Trial							9
Chirp Center Frequency							5530
Burst	No. of Pulses	Pulse Width (us)	Chirp Width (MHz)	Pulse 1-to-2 Spacing (us)	Pulse 2-to-3 Spacing (us)	Starting Location Within Interval (ms)	
1	3	90	20	1007	1326	30	
2	2	73.7	20	1785	-	979	
3	1	78.1	20	-	-	683	
4	2	92.4	20	1281	-	950	
5	1	61.2	20	-	-	612	
6	3	67.2	20	1525	1870	17	
7	1	78.5	20	-	-	429	
8	2	60.3	20	1931	-	936	
9	3	92.9	20	1403	1476	548	
Detection Check (1=Detection; 0=No Detection)							1



Trial Number							3
Number of Bursts in Trial							10
Chirp Center Frequency							5530
Burst	No. of Pulses	Pulse Width (us)	Chirp Width (MHz)	Pulse 1-to-2 Spacing (us)	Pulse 2-to-3 Spacing (us)	Starting Location Within Interval (ms)	
1	3	63.4	7	1574	1607	801	
2	1	98	7	-	-	966	
3	1	58.7	7	-	-	185	
4	1	88	7	-	-	1012	
5	3	79.5	7	1562	1370	943	
6	3	57.1	7	1900	1188	686	
7	2	64.4	7	1090	-	599	
8	1	78.7	7	-	-	1089	
9	1	69.3	7	-	-	188	
10	3	55.3	7	1375	1691	933	
Detection Check (1=Detection; 0=No Detection)							1

Trial Number							4
Number of Bursts in Trial							11
Chirp Center Frequency							5530
Burst	No. of Pulses	Pulse Width (us)	Chirp Width (MHz)	Pulse 1-to-2 Spacing (us)	Pulse 2-to-3 Spacing (us)	Starting Location Within Interval (ms)	
1	2	74.3	8	1642	-	24	
2	1	83.1	8	-	-	985	
3	2	59.5	8	1680	-	988	
4	2	59.8	8	1786	-	800	
5	2	77.6	8	1617	-	339	
6	2	79.9	8	1553	-	1040	
7	1	56	8	-	-	544	
8	3	71.4	8	1406	1927	452	
9	1	97.4	8	-	-	204	
10	2	98.3	8	1037	-	926	
11	1	63.6	8	-	-	1052	
Detection Check (1=Detection; 0=No Detection)							1



Trial Number							5
Number of Bursts in Trial							12
Chirp Center Frequency							5530
Burst	No. of Pulses	Pulse Width (us)	Chirp Width (MHz)	Pulse 1-to-2 Spacing (us)	Pulse 2-to-3 Spacing (us)	Starting Location Within Interval (ms)	
1	1	50	9	-	-	557	
2	2	62.5	9	1731	-	567	
3	2	55.4	9	1070	-	460	
4	1	65.7	9	-	-	4	
5	2	58	9	1512	-	64	
6	2	60.9	9	1230	-	650	
7	3	89.6	9	1598	1738	235	
8	3	84.4	9	1271	1617	873	
9	3	72.3	9	1498	1321	901	
10	1	58.9	9	-	-	663	
11	2	74.8	9	1584	-	919	
12	1	71.8	9	-	-	375	
Detection Check (1=Detection; 0=No Detection)							1

Trial Number							6
Number of Bursts in Trial							13
Chirp Center Frequency							5530
Burst	No. of Pulses	Pulse Width (us)	Chirp Width (MHz)	Pulse 1-to-2 Spacing (us)	Pulse 2-to-3 Spacing (us)	Starting Location Within Interval (ms)	
1	2	88.1	10	1257	-	846	
2	1	58.7	10	-	-	725	
3	2	97.1	10	1037	-	30	
4	3	83.1	10	1029	1106	490	
5	1	62.1	10	-	-	262	
6	2	71.4	10	1058	-	283	
7	2	86.3	10	1867	-	49	
8	3	77.3	10	1418	1876	634	
9	1	78.9	10	-	-	304	
10	3	79.2	10	1055	1572	564	
11	3	52	10	1582	1836	852	
12	3	56.5	10	1195	1542	525	
13	3	100	10	1638	1729	750	
Detection Check (1=Detection; 0=No Detection)							1



Trial Number							7
Number of Bursts in Trial							14
Chirp Center Frequency							5530
Burst	No. of Pulses	Pulse Width (us)	Chirp Width (MHz)	Pulse 1-to-2 Spacing (us)	Pulse 2-to-3 Spacing (us)	Starting Location Within Interval (ms)	
1	2	92.7	11	1208	-	231	
2	2	81.3	11	1144	-	804	
3	2	60.4	11	1555	-	34	
4	2	62.1	11	1320	-	427	
5	1	50	11	-	-	577	
6	3	65.9	11	1020	1365	3	
7	2	73.8	11	1308	-	51	
8	2	74.3	11	1143	-	360	
9	1	62.9	11	-	-	394	
10	2	74.8	11	1404	-	317	
11	2	69.7	11	1309	-	532	
12	2	69.8	11	1688	-	339	
13	2	77.4	11	1857	-	381	
14	1	55.1	11	-	-	426	
Detection Check (1=Detection; 0=No Detection)							1

Trial Number							8
Number of Bursts in Trial							15
Chirp Center Frequency							5530
Burst	No. of Pulses	Pulse Width (us)	Chirp Width (MHz)	Pulse 1-to-2 Spacing (us)	Pulse 2-to-3 Spacing (us)	Starting Location Within Interval (ms)	
1	1	91.7	12	-	-	776	
2	2	90	12	1196	-	187	
3	3	92.3	12	1486	1853	448	
4	2	66.8	12	1545	-	702	
5	1	64	12	-	-	403	
6	3	95.4	12	1123	1473	230	
7	3	66.8	12	1867	1401	604	
8	3	67.7	12	1472	1397	38	
9	1	68.2	12	-	-	735	
10	2	82.2	12	1297	-	610	
11	1	92.1	12	-	-	618	
12	2	57	12	1764	-	705	
13	2	58.5	12	1310	-	22	
14	3	85.5	12	1630	1447	641	
15	2	82.2	12	1371	-	109	
Detection Check (1=Detection; 0=No Detection)							1



Trial Number							9
Number of Bursts in Trial							16
Chirp Center Frequency							5530
Burst	No. of Pulses	Pulse Width (us)	Chirp Width (MHz)	Pulse 1-to-2 Spacing (us)	Pulse 2-to-3 Spacing (us)	Starting Location Within Interval (ms)	
1	2	74.4	13	1707	-	442	
2	2	63.6	13	1725	-	280	
3	2	71.3	13	1704	-	459	
4	3	77.6	13	1063	1405	197	
5	3	65.2	13	1731	1294	101	
6	3	55.1	13	1109	1549	17	
7	2	96.8	13	1034	-	131	
8	3	80.8	13	1533	1051	365	
9	1	60.4	13	-	-	222	
10	2	61.8	13	1312	-	371	
11	2	71.3	13	1657	-	33	
12	2	98.1	13	1024	-	291	
13	1	57.9	13	-	-	188	
14	1	91.8	13	-	-	163	
15	2	56.7	13	1259	-	426	
16	2	89.7	13	1690	-	606	
Detection Check (1=Detection; 0=No Detection)							1

Trial Number							10
Number of Bursts in Trial							17
Chirp Center Frequency							5530
Burst	No. of Pulses	Pulse Width (us)	Chirp Width (MHz)	Pulse 1-to-2 Spacing (us)	Pulse 2-to-3 Spacing (us)	Starting Location Within Interval (ms)	
1	2	74.4	14	1107	-	462	
2	1	87.6	14	-	-	653	
3	2	61.7	14	1741	-	457	
4	2	57.5	14	1566	-	388	
5	2	66.1	14	1855	-	63	
6	3	70.1	14	1044	1012	136	
7	1	66.4	14	-	-	343	
8	1	59.2	14	-	-	349	
9	2	88.3	14	1240	-	362	
10	1	64.7	14	-	-	221	
11	2	73	14	1703	-	144	
12	2	81.7	14	1450	-	671	
13	3	70.1	14	1741	1278	320	
14	1	63.6	14	-	-	196	
15	1	58.7	14	-	-	413	
16	2	65.9	14	1478	-	170	
17	1	72.7	14	-	-	564	
Detection Check (1=Detection; 0=No Detection)							1



Trial Number				11		
Number of Bursts in Trial				18		
Chirp Center Frequency				5497		
Burst	No. of Pulses	Pulse Width (us)	Chirp Width (MHz)	Pulse 1-to-2 Spacing (us)	Pulse 2-to-3 Spacing (us)	Starting Location Within Interval (ms)
1	2	72.1	15	1193	-	130
2	3	76.3	15	1484	1390	114
3	1	86.1	15	-	-	14
4	1	73.2	15	-	-	604
5	1	81.2	15	-	-	548
6	2	99.5	15	1398	-	173
7	1	93.9	15	-	-	262
8	2	75.9	15	1921	-	38
9	3	79.2	15	1100	1429	84
10	3	77	15	1166	1799	610
11	1	91.8	15	-	-	339
12	3	56.8	15	1330	1556	580
13	2	83.1	15	1556	-	295
14	2	63	15	1552	-	156
15	1	65.7	15	-	-	439
16	1	64.5	15	-	-	188
17	1	88.5	15	-	-	419
18	1	60.6	15	-	-	205
Detection Check (1=Detection; 0=No Detection)						1



Trial Number			12			
Number of Bursts in Trial			19			
Chirp Center Frequency			5497			
Burst	No. of Pulses	Pulse Width (us)	Chirp Width (MHz)	Pulse 1-to-2 Spacing (us)	Pulse 2-to-3 Spacing (us)	Starting Location Within Interval (ms)
1	2	90.5	16	1299	-	381
2	2	88.4	16	1418	-	327
3	2	53.7	16	1055	-	536
4	1	80.5	16	-	-	285
5	1	50.4	16	-	-	398
6	2	61.2	16	1749	-	439
7	2	78.8	16	1065	-	129
8	3	75	16	1748	1820	325
9	2	96.7	16	1254	-	440
10	3	76.3	16	1848	1106	397
11	1	73.3	16	-	-	232
12	2	92.4	16	1317	-	91
13	2	92.4	16	1854	-	256
14	3	64.4	16	1240	1634	582
15	2	67.3	16	1473	-	117
16	2	84.1	16	1795	-	202
17	1	80.9	16	-	-	135
18	1	74.6	16	-	-	396
19	2	97.6	16	1805	-	615
Detection Check (1=Detection; 0=No Detection)						1



Trial Number							13
Number of Bursts in Trial							20
Chirp Center Frequency							5498
Burst	No. of Pulses	Pulse Width (us)	Chirp Width (MHz)	Pulse 1-to-2 Spacing (us)	Pulse 2-to-3 Spacing (us)	Starting Location Within Interval (ms)	
1	2	66.1	17	1417	-	388	
2	2	86.7	17	1693	-	348	
3	2	70.5	17	1263	-	215	
4	2	78	17	1446	-	28	
5	2	66	17	1185	-	585	
6	2	80.6	17	1855	-	65	
7	1	95.5	17	-	-	92	
8	1	98.8	17	-	-	68	
9	3	64.3	17	1641	1108	517	
10	1	75.1	17	-	-	121	
11	2	72.6	17	1499	-	448	
12	1	60.3	17	-	-	567	
13	2	54.9	17	1056	-	245	
14	2	98.8	17	1023	-	584	
15	2	60.9	17	1243	-	579	
16	2	62.7	17	1226	-	464	
17	1	80.1	17	-	-	89	
18	2	70.9	17	1711	-	153	
19	1	90.7	17	-	-	282	
20	1	98.9	17	-	-	71	
Detection Check (1=Detection; 0=No Detection)							1

Trial Number							14
Number of Bursts in Trial							8
Chirp Center Frequency							5499
Burst	No. of Pulses	Pulse Width (us)	Chirp Width (MHz)	Pulse 1-to-2 Spacing (us)	Pulse 2-to-3 Spacing (us)	Starting Location Within Interval (ms)	
1	2	67.5	20	1542	-	947	
2	3	83.6	20	1272	1696	124	
3	2	93.2	20	1877	-	701	
4	1	55.6	20	-	-	1123	
5	3	84.2	20	1733	1619	756	
6	3	69.1	20	1612	1071	1	
7	2	66.9	20	1905	-	7	
8	3	86.8	20	1697	1621	1082	
Detection Check (1=Detection; 0=No Detection)							1



Trial Number							15
Number of Bursts in Trial							9
Chirp Center Frequency							5499
Burst	No. of Pulses	Pulse Width (us)	Chirp Width (MHz)	Pulse 1-to-2 Spacing (us)	Pulse 2-to-3 Spacing (us)	Starting Location Within Interval (ms)	
1	2	62.2	19	1571	-	949	
2	2	85	19	1669	-	189	
3	2	64.5	19	1505	-	176	
4	2	50.4	19	1325	-	538	
5	2	66.1	19	1483	-	908	
6	2	71.2	19	1110	-	1017	
7	3	53.7	19	1445	1677	492	
8	3	62.5	19	1596	1341	349	
9	3	62	19	1929	1221	1105	
Detection Check (1=Detection; 0=No Detection)							1

Trial Number							16
Number of Bursts in Trial							10
Chirp Center Frequency							5498
Burst	No. of Pulses	Pulse Width (us)	Chirp Width (MHz)	Pulse 1-to-2 Spacing (us)	Pulse 2-to-3 Spacing (us)	Starting Location Within Interval (ms)	
1	2	80.5	18	1910	-	284	
2	2	64.2	18	1661	-	751	
3	2	90.1	18	1041	-	491	
4	2	69.8	18	1495	-	107	
5	1	73.1	18	-	-	490	
6	3	77.2	18	1418	1145	1155	
7	3	52.6	18	1732	1787	772	
8	2	71.4	18	1562	-	121	
9	2	89.8	18	1491	-	89	
10	2	76.4	18	1355	-	615	
Detection Check (1=Detection; 0=No Detection)							1



Trial Number							17
Number of Bursts in Trial							11
Chirp Center Frequency							5498
Burst	No. of Pulses	Pulse Width (us)	Chirp Width (MHz)	Pulse 1-to-2 Spacing (us)	Pulse 2-to-3 Spacing (us)	Starting Location Within Interval (ms)	
1	2	51.2	17	1236	-	740	
2	1	71.7	17	-	-	941	
3	2	74.7	17	1164	-	370	
4	2	50.9	17	1919	-	371	
5	2	65.2	17	1206	-	1033	
6	2	98	17	1182	-	346	
7	2	58.7	17	1612	-	639	
8	1	63.8	17	-	-	1056	
9	3	86.3	17	1545	1065	205	
10	1	94.4	17	-	-	753	
11	3	88.5	17	1699	1319	58	
Detection Check (1=Detection; 0=No Detection)							1

Trial Number							18
Number of Bursts in Trial							12
Chirp Center Frequency							5497
Burst	No. of Pulses	Pulse Width (us)	Chirp Width (MHz)	Pulse 1-to-2 Spacing (us)	Pulse 2-to-3 Spacing (us)	Starting Location Within Interval (ms)	
1	2	88.7	16	1405	-	448	
2	3	90.2	16	1544	1235	621	
3	1	96.5	16	-	-	512	
4	2	80.5	16	1090	-	321	
5	2	63.7	16	1268	-	798	
6	1	53.4	16	-	-	809	
7	2	52.3	16	1043	-	301	
8	3	54.7	16	1701	1104	796	
9	3	75.6	16	1923	1729	669	
10	2	59.2	16	1244	-	369	
11	1	56.3	16	-	-	51	
12	2	87.8	16	1608	-	733	
Detection Check (1=Detection; 0=No Detection)							1



Trial Number							19
Number of Bursts in Trial							13
Chirp Center Frequency							5497
Burst	No. of Pulses	Pulse Width (us)	Chirp Width (MHz)	Pulse 1-to-2 Spacing (us)	Pulse 2-to-3 Spacing (us)	Starting Location Within Interval (ms)	
1	2	68.2	15	1104	-	229	
2	2	58.4	15	1627	-	488	
3	3	74.7	15	1861	1015	137	
4	2	58.2	15	1593	-	520	
5	1	51.6	15	-	-	799	
6	2	94.7	15	1469	-	43	
7	2	70.7	15	1091	-	126	
8	2	82.9	15	1472	-	607	
9	3	62.7	15	1168	1453	527	
10	2	63.1	15	1529	-	143	
11	1	96.1	15	-	-	176	
12	2	57	15	1457	-	882	
13	3	95.6	15	1707	1501	214	
Detection Check (1=Detection; 0=No Detection)							1

Trial Number							20
Number of Bursts in Trial							14
Chirp Center Frequency							5497
Burst	No. of Pulses	Pulse Width (us)	Chirp Width (MHz)	Pulse 1-to-2 Spacing (us)	Pulse 2-to-3 Spacing (us)	Starting Location Within Interval (ms)	
1	1	95.7	14	-	-	117	
2	1	93.1	14	-	-	720	
3	1	55.8	14	-	-	297	
4	1	76.7	14	-	-	284	
5	2	68	14	1686	-	472	
6	3	94.1	14	1796	1393	264	
7	2	53.9	14	1293	-	525	
8	1	99.3	14	-	-	155	
9	2	73.3	14	1458	-	65	
10	2	93.3	14	1196	-	451	
11	3	55.8	14	1895	1034	243	
12	1	66.4	14	-	-	228	
13	2	65.6	14	1732	-	746	
14	2	76.5	14	1187	-	522	
Detection Check (1=Detection; 0=No Detection)							1



Trial Number							21
Number of Bursts in Trial							15
Chirp Center Frequency							5564
Burst	No. of Pulses	Pulse Width (us)	Chirp Width (MHz)	Pulse 1-to-2 Spacing (us)	Pulse 2-to-3 Spacing (us)	Starting Location Within Interval (ms)	
1	1	85.1	13	-	-	565	
2	2	72.5	13	1648	-	211	
3	1	67.5	13	-	-	348	
4	2	56.1	13	1360	-	156	
5	1	71.1	13	-	-	718	
6	2	93.1	13	1391	-	400	
7	1	56.5	13	-	-	482	
8	1	63.8	13	-	-	703	
9	2	67.4	13	1727	-	780	
10	1	52.3	13	-	-	102	
11	3	62.4	13	1228	1715	304	
12	2	53.3	13	1630	-	57	
13	2	83.1	13	1205	-	768	
14	2	93.7	13	1085	-	461	
15	2	90.7	13	1297	-	746	
Detection Check (1=Detection; 0=No Detection)							1

Trial Number							22
Number of Bursts in Trial							16
Chirp Center Frequency							5564
Burst	No. of Pulses	Pulse Width (us)	Chirp Width (MHz)	Pulse 1-to-2 Spacing (us)	Pulse 2-to-3 Spacing (us)	Starting Location Within Interval (ms)	
1	2	98.8	12	1439	-	95	
2	1	54.5	12	-	-	676	
3	2	80.5	12	1360	-	8	
4	2	55.9	12	1906	-	373	
5	2	72.1	12	1623	-	254	
6	2	84.4	12	1604	-	480	
7	1	78.5	12	-	-	663	
8	1	88	12	-	-	314	
9	2	74.7	12	1157	-	596	
10	2	97.1	12	1673	-	264	
11	1	81.6	12	-	-	740	
12	1	83.6	12	-	-	163	
13	3	87.6	12	1757	1322	628	
14	2	58.5	12	1372	-	132	
15	3	91.8	12	1767	1183	106	
16	2	58.8	12	1432	-	659	
Detection Check (1=Detection; 0=No Detection)							1



Trial Number							23
Number of Bursts in Trial							17
Chirp Center Frequency							5565
Burst	No. of Pulses	Pulse Width (us)	Chirp Width (MHz)	Pulse 1-to-2 Spacing (us)	Pulse 2-to-3 Spacing (us)	Starting Location Within Interval (ms)	
1	1	96	11	-	-	284	
2	2	92.5	11	1241	-	488	
3	2	89.5	11	1347	-	76	
4	2	74.8	11	1607	-	688	
5	2	60.6	11	1523	-	28	
6	2	71.5	11	1659	-	383	
7	2	71.1	11	1454	-	182	
8	1	98.7	11	-	-	20	
9	2	85.1	11	1770	-	576	
10	2	89.2	11	1086	-	410	
11	2	60.7	11	1101	-	458	
12	2	75.2	11	1719	-	348	
13	2	75.7	11	1799	-	481	
14	3	56.7	11	1132	1884	587	
15	2	65	11	1885	-	480	
16	2	64.6	11	1910	-	195	
17	3	69.9	11	1410	1190	396	
Detection Check (1=Detection; 0=No Detection)							1

Trial Number							24
Number of Bursts in Trial							18
Chirp Center Frequency							5565
Burst	No. of Pulses	Pulse Width (us)	Chirp Width (MHz)	Pulse 1-to-2 Spacing (us)	Pulse 2-to-3 Spacing (us)	Starting Location Within Interval (ms)	
1	3	83.8	10	1290	1021	536	
2	2	66.9	10	1112	-	44	
3	3	91	10	1220	1504	611	
4	2	86.1	10	1678	-	456	
5	3	65.5	10	1928	1222	330	
6	1	62.6	10	-	-	297	
7	3	68.7	10	1505	1200	351	
8	3	59.2	10	1452	1114	230	
9	1	73.9	10	-	-	222	
10	1	77.2	10	-	-	57	
11	2	96.4	10	1357	-	399	
12	2	99.9	10	1173	-	299	
13	2	99.9	10	1520	-	464	
14	1	86.7	10	-	-	294	
15	1	92.6	10	-	-	653	
16	1	77.1	10	-	-	550	
17	2	81.1	10	1664	-	566	
18	3	68.4	10	1536	1309	580	
Detection Check (1=Detection; 0=No Detection)							1



Trial Number				25		
Number of Bursts in Trial				19		
Chirp Center Frequency				5565		
Burst	No. of Pulses	Pulse Width (us)	Chirp Width (MHz)	Pulse 1-to-2 Spacing (us)	Pulse 2-to-3 Spacing (us)	Starting Location Within Interval (ms)
1	3	68.2	9	1723	1868	471
2	3	83.7	9	1711	1405	368
3	2	69.7	9	1781	-	425
4	1	59.7	9	-	-	440
5	2	96.7	9	1484	-	123
6	2	95.8	9	1319	-	261
7	3	71.3	9	1095	1354	332
8	3	53.2	9	1527	1427	427
9	2	69.5	9	1771	-	397
10	3	63.9	9	1075	1447	67
11	2	93.4	9	1783	-	174
12	2	77.3	9	1564	-	17
13	2	73.1	9	1294	-	216
14	1	77.4	9	-	-	292
15	3	57.2	9	1722	1886	619
16	2	68.7	9	1629	-	233
17	1	60.8	9	-	-	226
18	3	69.7	9	1128	1224	599
19	1	62.2	9	-	-	433
Detection Check (1=Detection; 0=No Detection)						1



Trial Number							26
Number of Bursts in Trial							20
Chirp Center Frequency							5566
Burst	No. of Pulses	Pulse Width (us)	Chirp Width (MHz)	Pulse 1-to-2 Spacing (us)	Pulse 2-to-3 Spacing (us)	Starting Location Within Interval (ms)	
1	1	80.5	8	-	-	90	
2	3	62.6	8	1406	1343	319	
3	3	85.6	8	1190	1529	384	
4	2	83.9	8	1208	-	567	
5	2	92.4	8	1488	-	234	
6	2	54	8	1529	-	535	
7	3	81.3	8	1501	1812	325	
8	1	98.5	8	-	-	532	
9	1	85.8	8	-	-	272	
10	2	84.7	8	1593	-	182	
11	2	83.3	8	1705	-	134	
12	2	79.8	8	1567	-	286	
13	1	77.9	8	-	-	368	
14	3	98.4	8	1510	1569	290	
15	2	79.9	8	1588	-	231	
16	3	78	8	1140	1353	353	
17	3	55.2	8	1700	1327	53	
18	3	71.9	8	1081	1224	44	
19	1	62	8	-	-	298	
20	3	70.5	8	1888	1442	529	
Detection Check (1=Detection; 0=No Detection)							1

Trial Number							27
Number of Bursts in Trial							8
Chirp Center Frequency							5562
Burst	No. of Pulses	Pulse Width (us)	Chirp Width (MHz)	Pulse 1-to-2 Spacing (us)	Pulse 2-to-3 Spacing (us)	Starting Location Within Interval (ms)	
1	2	69.1	18	1076	-	1436	
2	2	62.1	18	1688	-	22	
3	2	94.8	18	1891	-	897	
4	1	75.8	18	-	-	1186	
5	2	65.4	18	1713	-	589	
6	2	97.7	18	1292	-	614	
7	3	98.1	18	1670	1711	506	
8	2	85.4	18	1672	-	776	
Detection Check (1=Detection; 0=No Detection)							1



Trial Number							28
Number of Bursts in Trial							9
Chirp Center Frequency							5561
Burst	No. of Pulses	Pulse Width (us)	Chirp Width (MHz)	Pulse 1-to-2 Spacing (us)	Pulse 2-to-3 Spacing (us)	Starting Location Within Interval (ms)	
1	3	82	19	1233	1713	679	
2	3	87.7	19	1554	1123	473	
3	2	98.9	19	1518	-	869	
4	1	55	19	-	-	719	
5	1	93.6	19	-	-	902	
6	2	58.7	19	1641	-	1243	
7	2	88.7	19	1387	-	410	
8	1	60.3	19	-	-	1154	
9	1	97.7	19	-	-	512	
Detection Check (1=Detection; 0=No Detection)							1

Trial Number							29
Number of Bursts in Trial							10
Chirp Center Frequency							5561
Burst	No. of Pulses	Pulse Width (us)	Chirp Width (MHz)	Pulse 1-to-2 Spacing (us)	Pulse 2-to-3 Spacing (us)	Starting Location Within Interval (ms)	
1	1	69.6	20	-	-	1131	
2	1	74.5	20	-	-	290	
3	1	60.9	20	-	-	895	
4	1	74.6	20	-	-	202	
5	2	99.3	20	1501	-	139	
6	2	95.3	20	1065	-	854	
7	2	91.9	20	1722	-	219	
8	2	51	20	1285	-	57	
9	2	87.7	20	1747	-	141	
10	1	87.2	20	-	-	596	
Detection Check (1=Detection; 0=No Detection)							1



Trial Number			30			
Number of Bursts in Trial			11			
Chirp Center Frequency			5567			
Burst	No. of Pulses	Pulse Width (us)	Chirp Width (MHz)	Pulse 1-to-2 Spacing (us)	Pulse 2-to-3 Spacing (us)	Starting Location Within Interval (ms)
1	3	59.9	5	1901	1196	935
2	2	77.1	5	1590	-	1038
3	2	62.7	5	1227	-	690
4	1	77.1	5	-	-	547
5	3	99.8	5	1798	1790	551
6	2	61.5	5	1135	-	876
7	2	77.5	5	1583	-	448
8	2	57.3	5	1890	-	736
9	2	53.5	5	1757	-	362
10	1	66.6	5	-	-	836
11	3	80.7	5	1811	1289	410
Detection Check (1=Detection; 0=No Detection)						1



Type 6 Radar Statistical Performance

Trial #	Test Freq. (MHz)	Pulses / Hop	Pulse Width (us)	PRI (us)	1=Detection 0=No Detection
1	5530	9	1	333	1
2	5530	9	1	333	1
3	5530	9	1	333	1
4	5530	9	1	333	1
5	5530	9	1	333	1
6	5530	9	1	333	1
7	5530	9	1	333	1
8	5530	9	1	333	1
9	5530	9	1	333	1
10	5530	9	1	333	1
11	5530	9	1	333	1
12	5530	9	1	333	1
13	5530	9	1	333	0
14	5530	9	1	333	1
15	5530	9	1	333	1
16	5530	9	1	333	1
17	5530	9	1	333	1
18	5530	9	1	333	1
19	5530	9	1	333	1
20	5530	9	1	333	1
21	5530	9	1	333	1
22	5530	9	1	333	1
23	5530	9	1	333	1
24	5530	9	1	333	1
25	5530	9	1	333	1
26	5530	9	1	333	1
27	5530	9	1	333	1
28	5530	9	1	333	1
29	5530	9	1	333	1
30	5530	9	1	333	1
Detection Percentage (%)					96.667
Limit					70%
Test Result					Complied



Modulation Mode: 802.11ac (VHT80+80) / 5530MHz

Type 1 Radar Statistical Performance

Trial #	Test Freq. (MHz)	Pulse Repetition Frequency Number	Pulse Repetition Frequency (Pulse Per Second)	PRI (us)	1=Detection 0=No Detection
1	5530	1	1930.5	518	1
2	5531	23	326.2	3066	1
3	5535	19	1139.0	878	1
4	5538	12	1355.0	738	1
5	5540	4	1730.1	578	1
6	5548	8	1519.8	658	1
7	5550	15	1253.1	798	1
8	5551	6	1618.1	618	1
9	5553	14	1285.3	778	1
10	5556	3	1792.1	558	1
11	5560	13	1319.3	758	1
12	5568	9	1474.9	678	1
13	5570	7	1567.4	638	0
14	5490	17	1193.3	838	1
15	5491	10	1432.7	698	1
16	5498	-	1692.0	591	1
17	5500	-	328.1	3048	1
18	5508	-	373.4	2678	1
19	5510	-	574.4	1741	1
20	5511	-	1216.5	822	1
21	5518	-	801.3	1248	1
22	5520	-	488.5	2047	1
23	5516	-	956.0	1046	1
24	5533	-	517.6	1932	0
25	5544	-	1422.5	703	1
26	5566	-	542.0	1845	1
27	5502	-	741.3	1349	1
28	5516	-	881.8	1134	1
29	5564	-	427.4	2340	1
30	5539	-	628.9	1590	1
Detection Percentage (%)					93.333
Limit					60%
Test Result					Complied



Type 2 Radar Statistical Performance

Trial #	Test Freq. (MHz)	Pulse Width (us)	PRI (us)	Pulses / Burst	1=Detection 0=No Detection
1	5530	2.6	221	23	1
2	5531	4.6	198	27	1
3	5535	1.1	184	29	1
4	5538	4.8	203	24	1
5	5540	2.4	162	25	1
6	5548	3.4	204	28	1
7	5550	2.3	170	27	1
8	5551	3.5	184	23	0
9	5553	4.9	150	27	1
10	5556	4.6	211	29	1
11	5560	2.9	158	23	1
12	5568	2.6	226	27	1
13	5570	1.6	204	26	1
14	5490	3.9	181	25	0
15	5491	4.6	202	24	1
16	5498	4.1	194	27	1
17	5500	2.3	193	28	1
18	5508	3.9	173	29	1
19	5510	4.3	188	23	1
20	5511	1.5	215	26	1
21	5518	4.9	227	27	1
22	5520	1.1	199	23	1
23	5516	4.5	155	29	0
24	5533	4.0	190	27	1
25	5544	2.4	151	23	1
26	5566	2.5	180	28	1
27	5502	2.5	228	23	1
28	5516	2.5	203	25	1
29	5564	1.5	188	25	1
30	5539	1.9	217	24	1
Detection Percentage (%)					90.000
Limit					60%
Test Result					Complied



Type 3 Radar Statistical Performance

Trial #	Test Freq. (MHz)	Pulse Width (us)	PRI (us)	Pulses / Burst	1=Detection 0=No Detection
1	5530	8.0	205	16	1
2	5531	6.7	382	18	0
3	5535	8.6	418	16	1
4	5538	9.4	351	17	1
5	5540	7.4	383	18	1
6	5548	9.8	232	16	1
7	5550	9.1	377	17	1
8	5551	9.6	457	16	1
9	5553	8.0	471	18	0
10	5556	9.0	304	18	1
11	5560	8.0	316	17	1
12	5568	9.8	325	16	1
13	5570	8.0	409	17	1
14	5490	9.9	200	17	1
15	5491	8.8	458	16	1
16	5498	8.0	232	18	1
17	5500	8.3	250	16	1
18	5508	8.7	270	16	1
19	5510	7.7	350	17	1
20	5511	7.1	230	16	1
21	5518	7.3	416	18	0
22	5520	7.6	498	18	1
23	5516	7.3	286	17	1
24	5533	7.3	287	16	1
25	5544	7.5	462	17	1
26	5566	6.2	300	17	1
27	5502	6.4	323	18	1
28	5516	7.1	420	16	1
29	5564	7.2	395	18	1
30	5539	8.4	377	16	1
Detection Percentage (%)					90.000
Limit					60%
Test Result					Complied



Type 4 Radar Statistical Performance

Trial #	Test Freq. (MHz)	Pulse Width (us)	PRI (us)	Pulses / Burst	1=Detection 0=No Detection
1	5530	18.0	242	15	1
2	5531	19.9	279	12	1
3	5535	12.9	487	14	1
4	5538	15.0	452	13	1
5	5540	16.3	230	12	1
6	5548	19.8	238	13	1
7	5550	18.2	420	16	0
8	5551	16.3	452	15	1
9	5553	14.2	495	12	1
10	5556	17.8	228	16	1
11	5560	19.1	211	16	1
12	5568	18.4	283	15	1
13	5570	11.8	411	12	1
14	5490	14.2	284	13	0
15	5491	13.9	202	12	1
16	5498	17.8	340	14	1
17	5500	15.6	290	16	1
18	5508	14.6	250	16	1
19	5510	14.4	484	15	1
20	5511	18.9	387	13	1
21	5518	11.1	348	15	1
22	5520	13.8	291	16	1
23	5516	14.3	295	12	0
24	5533	12.5	300	12	1
25	5544	12.5	322	14	1
26	5566	12.5	383	13	1
27	5502	15.7	322	16	1
28	5516	19.8	469	13	1
29	5564	18.6	406	15	1
30	5539	15.9	238	14	1
Detection Percentage (%)					90.000
Limit					60%
Test Result					Complied



Total Type 1~4 Radar Statistical Performance

Radar Type #	Detection Percentage (%)
1	93.333
2	90.000
3	90.000
4	90.000
Aggregate (Radar Types 1-4)	90.833
Limit	80%
Test Result	Complied



Type 5 Radar Statistical Performance

Center Freq. (MHz)	Low Edge (MHz)	High Edge (MHz)	VSG Freq. (MHz)	Detection
Trial	Chirp	Offset		
1	5	0.0	5530	1
2	20	0.0	5530	1
3	7	0.0	5530	1
4	8	0.0	5530	1
5	9	0.0	5530	1
6	10	0.0	5530	1
7	11	0.0	5530	1
8	12	0.0	5530	1
9	13	0.0	5530	1
10	14	0.0	5530	1
11	15	6.0	5496	1
12	16	6.4	5496	1
13	17	6.8	5497	1
14	20	8.0	5498	1
15	19	7.6	5498	1
16	18	7.2	5497	1
17	17	6.8	5497	1
18	16	6.4	5496	1
19	15	6.0	5496	1
20	14	5.6	5496	1
21	13	5.2	5565	1
22	12	4.8	5565	1
23	11	4.4	5566	1
24	10	4.0	5566	1
25	9	3.6	5566	1
26	8	3.2	5567	1
27	18	7.2	5563	1
28	19	7.6	5562	1
29	20	8.0	5562	1
30	5	2.0	5568	1
Total				30
Detection Percentage (%)				100%
Limit				80%
Test Result				Complied



Trial Number							1
Number of Bursts in Trial							8
Chirp Center Frequency							5530
Burst	No. of Pulses	Pulse Width (us)	Chirp Width (MHz)	Pulse 1-to-2 Spacing (us)	Pulse 2-to-3 Spacing (us)	Starting Location Within Interval (ms)	
1	1	62.1	5	-	-	1091	
2	2	56	5	1729	-	133	
3	2	91.3	5	1230	-	1057	
4	3	50.7	5	1762	1616	1442	
5	2	92.6	5	1723	-	544	
6	2	87.3	5	1302	-	1089	
7	2	59.5	5	1291	-	1374	
8	2	52.2	5	1653	-	1237	
Detection Check (1=Detection; 0=No Detection)							1

Trial Number							2
Number of Bursts in Trial							9
Chirp Center Frequency							5530
Burst	No. of Pulses	Pulse Width (us)	Chirp Width (MHz)	Pulse 1-to-2 Spacing (us)	Pulse 2-to-3 Spacing (us)	Starting Location Within Interval (ms)	
1	3	90	20	1007	1326	30	
2	2	73.7	20	1785	-	979	
3	1	78.1	20	-	-	683	
4	2	92.4	20	1281	-	950	
5	1	61.2	20	-	-	612	
6	3	67.2	20	1525	1870	17	
7	1	78.5	20	-	-	429	
8	2	60.3	20	1931	-	936	
9	3	92.9	20	1403	1476	548	
Detection Check (1=Detection; 0=No Detection)							1



Trial Number							3
Number of Bursts in Trial							10
Chirp Center Frequency							5530
Burst	No. of Pulses	Pulse Width (us)	Chirp Width (MHz)	Pulse 1-to-2 Spacing (us)	Pulse 2-to-3 Spacing (us)	Starting Location Within Interval (ms)	
1	3	63.4	7	1574	1607	801	
2	1	98	7	-	-	966	
3	1	58.7	7	-	-	185	
4	1	88	7	-	-	1012	
5	3	79.5	7	1562	1370	943	
6	3	57.1	7	1900	1188	686	
7	2	64.4	7	1090	-	599	
8	1	78.7	7	-	-	1089	
9	1	69.3	7	-	-	188	
10	3	55.3	7	1375	1691	933	
Detection Check (1=Detection; 0=No Detection)							1

Trial Number							4
Number of Bursts in Trial							11
Chirp Center Frequency							5530
Burst	No. of Pulses	Pulse Width (us)	Chirp Width (MHz)	Pulse 1-to-2 Spacing (us)	Pulse 2-to-3 Spacing (us)	Starting Location Within Interval (ms)	
1	2	74.3	8	1642	-	24	
2	1	83.1	8	-	-	985	
3	2	59.5	8	1680	-	988	
4	2	59.8	8	1786	-	800	
5	2	77.6	8	1617	-	339	
6	2	79.9	8	1553	-	1040	
7	1	56	8	-	-	544	
8	3	71.4	8	1406	1927	452	
9	1	97.4	8	-	-	204	
10	2	98.3	8	1037	-	926	
11	1	63.6	8	-	-	1052	
Detection Check (1=Detection; 0=No Detection)							1



Trial Number							5
Number of Bursts in Trial							12
Chirp Center Frequency							5530
Burst	No. of Pulses	Pulse Width (us)	Chirp Width (MHz)	Pulse 1-to-2 Spacing (us)	Pulse 2-to-3 Spacing (us)	Starting Location Within Interval (ms)	
1	1	50	9	-	-	557	
2	2	62.5	9	1731	-	567	
3	2	55.4	9	1070	-	460	
4	1	65.7	9	-	-	4	
5	2	58	9	1512	-	64	
6	2	60.9	9	1230	-	650	
7	3	89.6	9	1598	1738	235	
8	3	84.4	9	1271	1617	873	
9	3	72.3	9	1498	1321	901	
10	1	58.9	9	-	-	663	
11	2	74.8	9	1584	-	919	
12	1	71.8	9	-	-	375	
Detection Check (1=Detection; 0=No Detection)							1

Trial Number							6
Number of Bursts in Trial							13
Chirp Center Frequency							5530
Burst	No. of Pulses	Pulse Width (us)	Chirp Width (MHz)	Pulse 1-to-2 Spacing (us)	Pulse 2-to-3 Spacing (us)	Starting Location Within Interval (ms)	
1	2	88.1	10	1257	-	846	
2	1	58.7	10	-	-	725	
3	2	97.1	10	1037	-	30	
4	3	83.1	10	1029	1106	490	
5	1	62.1	10	-	-	262	
6	2	71.4	10	1058	-	283	
7	2	86.3	10	1867	-	49	
8	3	77.3	10	1418	1876	634	
9	1	78.9	10	-	-	304	
10	3	79.2	10	1055	1572	564	
11	3	52	10	1582	1836	852	
12	3	56.5	10	1195	1542	525	
13	3	100	10	1638	1729	750	
Detection Check (1=Detection; 0=No Detection)							1



Trial Number							7
Number of Bursts in Trial							14
Chirp Center Frequency							5530
Burst	No. of Pulses	Pulse Width (us)	Chirp Width (MHz)	Pulse 1-to-2 Spacing (us)	Pulse 2-to-3 Spacing (us)	Starting Location Within Interval (ms)	
1	2	92.7	11	1208	-	231	
2	2	81.3	11	1144	-	804	
3	2	60.4	11	1555	-	34	
4	2	62.1	11	1320	-	427	
5	1	50	11	-	-	577	
6	3	65.9	11	1020	1365	3	
7	2	73.8	11	1308	-	51	
8	2	74.3	11	1143	-	360	
9	1	62.9	11	-	-	394	
10	2	74.8	11	1404	-	317	
11	2	69.7	11	1309	-	532	
12	2	69.8	11	1688	-	339	
13	2	77.4	11	1857	-	381	
14	1	55.1	11	-	-	426	
Detection Check (1=Detection; 0=No Detection)							1

Trial Number							8
Number of Bursts in Trial							15
Chirp Center Frequency							5530
Burst	No. of Pulses	Pulse Width (us)	Chirp Width (MHz)	Pulse 1-to-2 Spacing (us)	Pulse 2-to-3 Spacing (us)	Starting Location Within Interval (ms)	
1	1	91.7	12	-	-	776	
2	2	90	12	1196	-	187	
3	3	92.3	12	1486	1853	448	
4	2	66.8	12	1545	-	702	
5	1	64	12	-	-	403	
6	3	95.4	12	1123	1473	230	
7	3	66.8	12	1867	1401	604	
8	3	67.7	12	1472	1397	38	
9	1	68.2	12	-	-	735	
10	2	82.2	12	1297	-	610	
11	1	92.1	12	-	-	618	
12	2	57	12	1764	-	705	
13	2	58.5	12	1310	-	22	
14	3	85.5	12	1630	1447	641	
15	2	82.2	12	1371	-	109	
Detection Check (1=Detection; 0=No Detection)							1



Trial Number							9
Number of Bursts in Trial							16
Chirp Center Frequency							5530
Burst	No. of Pulses	Pulse Width (us)	Chirp Width (MHz)	Pulse 1-to-2 Spacing (us)	Pulse 2-to-3 Spacing (us)	Starting Location Within Interval (ms)	
1	2	74.4	13	1707	-	442	
2	2	63.6	13	1725	-	280	
3	2	71.3	13	1704	-	459	
4	3	77.6	13	1063	1405	197	
5	3	65.2	13	1731	1294	101	
6	3	55.1	13	1109	1549	17	
7	2	96.8	13	1034	-	131	
8	3	80.8	13	1533	1051	365	
9	1	60.4	13	-	-	222	
10	2	61.8	13	1312	-	371	
11	2	71.3	13	1657	-	33	
12	2	98.1	13	1024	-	291	
13	1	57.9	13	-	-	188	
14	1	91.8	13	-	-	163	
15	2	56.7	13	1259	-	426	
16	2	89.7	13	1690	-	606	
Detection Check (1=Detection; 0=No Detection)							1

Trial Number							10
Number of Bursts in Trial							17
Chirp Center Frequency							5530
Burst	No. of Pulses	Pulse Width (us)	Chirp Width (MHz)	Pulse 1-to-2 Spacing (us)	Pulse 2-to-3 Spacing (us)	Starting Location Within Interval (ms)	
1	2	74.4	14	1107	-	462	
2	1	87.6	14	-	-	653	
3	2	61.7	14	1741	-	457	
4	2	57.5	14	1566	-	388	
5	2	66.1	14	1855	-	63	
6	3	70.1	14	1044	1012	136	
7	1	66.4	14	-	-	343	
8	1	59.2	14	-	-	349	
9	2	88.3	14	1240	-	362	
10	1	64.7	14	-	-	221	
11	2	73	14	1703	-	144	
12	2	81.7	14	1450	-	671	
13	3	70.1	14	1741	1278	320	
14	1	63.6	14	-	-	196	
15	1	58.7	14	-	-	413	
16	2	65.9	14	1478	-	170	
17	1	72.7	14	-	-	564	
Detection Check (1=Detection; 0=No Detection)							1



Trial Number				11		
Number of Bursts in Trial				18		
Chirp Center Frequency				5496		
Burst	No. of Pulses	Pulse Width (us)	Chirp Width (MHz)	Pulse 1-to-2 Spacing (us)	Pulse 2-to-3 Spacing (us)	Starting Location Within Interval (ms)
1	2	72.1	15	1193	-	130
2	3	76.3	15	1484	1390	114
3	1	86.1	15	-	-	14
4	1	73.2	15	-	-	604
5	1	81.2	15	-	-	548
6	2	99.5	15	1398	-	173
7	1	93.9	15	-	-	262
8	2	75.9	15	1921	-	38
9	3	79.2	15	1100	1429	84
10	3	77	15	1166	1799	610
11	1	91.8	15	-	-	339
12	3	56.8	15	1330	1556	580
13	2	83.1	15	1556	-	295
14	2	63	15	1552	-	156
15	1	65.7	15	-	-	439
16	1	64.5	15	-	-	188
17	1	88.5	15	-	-	419
18	1	60.6	15	-	-	205
Detection Check (1=Detection; 0=No Detection)						1



Trial Number			12			
Number of Bursts in Trial			19			
Chirp Center Frequency			5496			
Burst	No. of Pulses	Pulse Width (us)	Chirp Width (MHz)	Pulse 1-to-2 Spacing (us)	Pulse 2-to-3 Spacing (us)	Starting Location Within Interval (ms)
1	2	90.5	16	1299	-	381
2	2	88.4	16	1418	-	327
3	2	53.7	16	1055	-	536
4	1	80.5	16	-	-	285
5	1	50.4	16	-	-	398
6	2	61.2	16	1749	-	439
7	2	78.8	16	1065	-	129
8	3	75	16	1748	1820	325
9	2	96.7	16	1254	-	440
10	3	76.3	16	1848	1106	397
11	1	73.3	16	-	-	232
12	2	92.4	16	1317	-	91
13	2	92.4	16	1854	-	256
14	3	64.4	16	1240	1634	582
15	2	67.3	16	1473	-	117
16	2	84.1	16	1795	-	202
17	1	80.9	16	-	-	135
18	1	74.6	16	-	-	396
19	2	97.6	16	1805	-	615
Detection Check (1=Detection; 0=No Detection)						1



Trial Number							13
Number of Bursts in Trial							20
Chirp Center Frequency							5497
Burst	No. of Pulses	Pulse Width (us)	Chirp Width (MHz)	Pulse 1-to-2 Spacing (us)	Pulse 2-to-3 Spacing (us)	Starting Location Within Interval (ms)	
1	2	66.1	17	1417	-	388	
2	2	86.7	17	1693	-	348	
3	2	70.5	17	1263	-	215	
4	2	78	17	1446	-	28	
5	2	66	17	1185	-	585	
6	2	80.6	17	1855	-	65	
7	1	95.5	17	-	-	92	
8	1	98.8	17	-	-	68	
9	3	64.3	17	1641	1108	517	
10	1	75.1	17	-	-	121	
11	2	72.6	17	1499	-	448	
12	1	60.3	17	-	-	567	
13	2	54.9	17	1056	-	245	
14	2	98.8	17	1023	-	584	
15	2	60.9	17	1243	-	579	
16	2	62.7	17	1226	-	464	
17	1	80.1	17	-	-	89	
18	2	70.9	17	1711	-	153	
19	1	90.7	17	-	-	282	
20	1	98.9	17	-	-	71	
Detection Check (1=Detection; 0=No Detection)							1

Trial Number							14
Number of Bursts in Trial							8
Chirp Center Frequency							5498
Burst	No. of Pulses	Pulse Width (us)	Chirp Width (MHz)	Pulse 1-to-2 Spacing (us)	Pulse 2-to-3 Spacing (us)	Starting Location Within Interval (ms)	
1	2	67.5	20	1542	-	947	
2	3	83.6	20	1272	1696	124	
3	2	93.2	20	1877	-	701	
4	1	55.6	20	-	-	1123	
5	3	84.2	20	1733	1619	756	
6	3	69.1	20	1612	1071	1	
7	2	66.9	20	1905	-	7	
8	3	86.8	20	1697	1621	1082	
Detection Check (1=Detection; 0=No Detection)							1



Trial Number							15
Number of Bursts in Trial							9
Chirp Center Frequency							5498
Burst	No. of Pulses	Pulse Width (us)	Chirp Width (MHz)	Pulse 1-to-2 Spacing (us)	Pulse 2-to-3 Spacing (us)	Starting Location Within Interval (ms)	
1	2	62.2	19	1571	-	949	
2	2	85	19	1669	-	189	
3	2	64.5	19	1505	-	176	
4	2	50.4	19	1325	-	538	
5	2	66.1	19	1483	-	908	
6	2	71.2	19	1110	-	1017	
7	3	53.7	19	1445	1677	492	
8	3	62.5	19	1596	1341	349	
9	3	62	19	1929	1221	1105	
Detection Check (1=Detection; 0=No Detection)							1

Trial Number							16
Number of Bursts in Trial							10
Chirp Center Frequency							5497
Burst	No. of Pulses	Pulse Width (us)	Chirp Width (MHz)	Pulse 1-to-2 Spacing (us)	Pulse 2-to-3 Spacing (us)	Starting Location Within Interval (ms)	
1	2	80.5	18	1910	-	284	
2	2	64.2	18	1661	-	751	
3	2	90.1	18	1041	-	491	
4	2	69.8	18	1495	-	107	
5	1	73.1	18	-	-	490	
6	3	77.2	18	1418	1145	1155	
7	3	52.6	18	1732	1787	772	
8	2	71.4	18	1562	-	121	
9	2	89.8	18	1491	-	89	
10	2	76.4	18	1355	-	615	
Detection Check (1=Detection; 0=No Detection)							1



Trial Number							17
Number of Bursts in Trial							11
Chirp Center Frequency							5497
Burst	No. of Pulses	Pulse Width (us)	Chirp Width (MHz)	Pulse 1-to-2 Spacing (us)	Pulse 2-to-3 Spacing (us)	Starting Location Within Interval (ms)	
1	2	51.2	17	1236	-	740	
2	1	71.7	17	-	-	941	
3	2	74.7	17	1164	-	370	
4	2	50.9	17	1919	-	371	
5	2	65.2	17	1206	-	1033	
6	2	98	17	1182	-	346	
7	2	58.7	17	1612	-	639	
8	1	63.8	17	-	-	1056	
9	3	86.3	17	1545	1065	205	
10	1	94.4	17	-	-	753	
11	3	88.5	17	1699	1319	58	
Detection Check (1=Detection; 0=No Detection)							1

Trial Number							18
Number of Bursts in Trial							12
Chirp Center Frequency							5496
Burst	No. of Pulses	Pulse Width (us)	Chirp Width (MHz)	Pulse 1-to-2 Spacing (us)	Pulse 2-to-3 Spacing (us)	Starting Location Within Interval (ms)	
1	2	88.7	16	1405	-	448	
2	3	90.2	16	1544	1235	621	
3	1	96.5	16	-	-	512	
4	2	80.5	16	1090	-	321	
5	2	63.7	16	1268	-	798	
6	1	53.4	16	-	-	809	
7	2	52.3	16	1043	-	301	
8	3	54.7	16	1701	1104	796	
9	3	75.6	16	1923	1729	669	
10	2	59.2	16	1244	-	369	
11	1	56.3	16	-	-	51	
12	2	87.8	16	1608	-	733	
Detection Check (1=Detection; 0=No Detection)							1



Trial Number							19
Number of Bursts in Trial							13
Chirp Center Frequency							5496
Burst	No. of Pulses	Pulse Width (us)	Chirp Width (MHz)	Pulse 1-to-2 Spacing (us)	Pulse 2-to-3 Spacing (us)	Starting Location Within Interval (ms)	
1	2	68.2	15	1104	-	229	
2	2	58.4	15	1627	-	488	
3	3	74.7	15	1861	1015	137	
4	2	58.2	15	1593	-	520	
5	1	51.6	15	-	-	799	
6	2	94.7	15	1469	-	43	
7	2	70.7	15	1091	-	126	
8	2	82.9	15	1472	-	607	
9	3	62.7	15	1168	1453	527	
10	2	63.1	15	1529	-	143	
11	1	96.1	15	-	-	176	
12	2	57	15	1457	-	882	
13	3	95.6	15	1707	1501	214	
Detection Check (1=Detection; 0=No Detection)							1

Trial Number							20
Number of Bursts in Trial							14
Chirp Center Frequency							5496
Burst	No. of Pulses	Pulse Width (us)	Chirp Width (MHz)	Pulse 1-to-2 Spacing (us)	Pulse 2-to-3 Spacing (us)	Starting Location Within Interval (ms)	
1	1	95.7	14	-	-	117	
2	1	93.1	14	-	-	720	
3	1	55.8	14	-	-	297	
4	1	76.7	14	-	-	284	
5	2	68	14	1686	-	472	
6	3	94.1	14	1796	1393	264	
7	2	53.9	14	1293	-	525	
8	1	99.3	14	-	-	155	
9	2	73.3	14	1458	-	65	
10	2	93.3	14	1196	-	451	
11	3	55.8	14	1895	1034	243	
12	1	66.4	14	-	-	228	
13	2	65.6	14	1732	-	746	
14	2	76.5	14	1187	-	522	
Detection Check (1=Detection; 0=No Detection)							1



Trial Number							21
Number of Bursts in Trial							15
Chirp Center Frequency							5565
Burst	No. of Pulses	Pulse Width (us)	Chirp Width (MHz)	Pulse 1-to-2 Spacing (us)	Pulse 2-to-3 Spacing (us)	Starting Location Within Interval (ms)	
1	1	85.1	13	-	-	565	
2	2	72.5	13	1648	-	211	
3	1	67.5	13	-	-	348	
4	2	56.1	13	1360	-	156	
5	1	71.1	13	-	-	718	
6	2	93.1	13	1391	-	400	
7	1	56.5	13	-	-	482	
8	1	63.8	13	-	-	703	
9	2	67.4	13	1727	-	780	
10	1	52.3	13	-	-	102	
11	3	62.4	13	1228	1715	304	
12	2	53.3	13	1630	-	57	
13	2	83.1	13	1205	-	768	
14	2	93.7	13	1085	-	461	
15	2	90.7	13	1297	-	746	
Detection Check (1=Detection; 0=No Detection)							1

Trial Number							22
Number of Bursts in Trial							16
Chirp Center Frequency							5565
Burst	No. of Pulses	Pulse Width (us)	Chirp Width (MHz)	Pulse 1-to-2 Spacing (us)	Pulse 2-to-3 Spacing (us)	Starting Location Within Interval (ms)	
1	2	98.8	12	1439	-	95	
2	1	54.5	12	-	-	676	
3	2	80.5	12	1360	-	8	
4	2	55.9	12	1906	-	373	
5	2	72.1	12	1623	-	254	
6	2	84.4	12	1604	-	480	
7	1	78.5	12	-	-	663	
8	1	88	12	-	-	314	
9	2	74.7	12	1157	-	596	
10	2	97.1	12	1673	-	264	
11	1	81.6	12	-	-	740	
12	1	83.6	12	-	-	163	
13	3	87.6	12	1757	1322	628	
14	2	58.5	12	1372	-	132	
15	3	91.8	12	1767	1183	106	
16	2	58.8	12	1432	-	659	
Detection Check (1=Detection; 0=No Detection)							1



Trial Number							23
Number of Bursts in Trial							17
Chirp Center Frequency							5566
Burst	No. of Pulses	Pulse Width (us)	Chirp Width (MHz)	Pulse 1-to-2 Spacing (us)	Pulse 2-to-3 Spacing (us)	Starting Location Within Interval (ms)	
1	1	96	11	-	-	284	
2	2	92.5	11	1241	-	488	
3	2	89.5	11	1347	-	76	
4	2	74.8	11	1607	-	688	
5	2	60.6	11	1523	-	28	
6	2	71.5	11	1659	-	383	
7	2	71.1	11	1454	-	182	
8	1	98.7	11	-	-	20	
9	2	85.1	11	1770	-	576	
10	2	89.2	11	1086	-	410	
11	2	60.7	11	1101	-	458	
12	2	75.2	11	1719	-	348	
13	2	75.7	11	1799	-	481	
14	3	56.7	11	1132	1884	587	
15	2	65	11	1885	-	480	
16	2	64.6	11	1910	-	195	
17	3	69.9	11	1410	1190	396	
Detection Check (1=Detection; 0=No Detection)							1

Trial Number							24
Number of Bursts in Trial							18
Chirp Center Frequency							5566
Burst	No. of Pulses	Pulse Width (us)	Chirp Width (MHz)	Pulse 1-to-2 Spacing (us)	Pulse 2-to-3 Spacing (us)	Starting Location Within Interval (ms)	
1	3	83.8	10	1290	1021	536	
2	2	66.9	10	1112	-	44	
3	3	91	10	1220	1504	611	
4	2	86.1	10	1678	-	456	
5	3	65.5	10	1928	1222	330	
6	1	62.6	10	-	-	297	
7	3	68.7	10	1505	1200	351	
8	3	59.2	10	1452	1114	230	
9	1	73.9	10	-	-	222	
10	1	77.2	10	-	-	57	
11	2	96.4	10	1357	-	399	
12	2	99.9	10	1173	-	299	
13	2	99.9	10	1520	-	464	
14	1	86.7	10	-	-	294	
15	1	92.6	10	-	-	653	
16	1	77.1	10	-	-	550	
17	2	81.1	10	1664	-	566	
18	3	68.4	10	1536	1309	580	
Detection Check (1=Detection; 0=No Detection)							1



Trial Number				25		
Number of Bursts in Trial				19		
Chirp Center Frequency				5566		
Burst	No. of Pulses	Pulse Width (us)	Chirp Width (MHz)	Pulse 1-to-2 Spacing (us)	Pulse 2-to-3 Spacing (us)	Starting Location Within Interval (ms)
1	3	68.2	9	1723	1868	471
2	3	83.7	9	1711	1405	368
3	2	69.7	9	1781	-	425
4	1	59.7	9	-	-	440
5	2	96.7	9	1484	-	123
6	2	95.8	9	1319	-	261
7	3	71.3	9	1095	1354	332
8	3	53.2	9	1527	1427	427
9	2	69.5	9	1771	-	397
10	3	63.9	9	1075	1447	67
11	2	93.4	9	1783	-	174
12	2	77.3	9	1564	-	17
13	2	73.1	9	1294	-	216
14	1	77.4	9	-	-	292
15	3	57.2	9	1722	1886	619
16	2	68.7	9	1629	-	233
17	1	60.8	9	-	-	226
18	3	69.7	9	1128	1224	599
19	1	62.2	9	-	-	433
Detection Check (1=Detection; 0=No Detection)						1



Trial Number							26
Number of Bursts in Trial							20
Chirp Center Frequency							5567
Burst	No. of Pulses	Pulse Width (us)	Chirp Width (MHz)	Pulse 1-to-2 Spacing (us)	Pulse 2-to-3 Spacing (us)	Starting Location Within Interval (ms)	
1	1	80.5	8	-	-	90	
2	3	62.6	8	1406	1343	319	
3	3	85.6	8	1190	1529	384	
4	2	83.9	8	1208	-	567	
5	2	92.4	8	1488	-	234	
6	2	54	8	1529	-	535	
7	3	81.3	8	1501	1812	325	
8	1	98.5	8	-	-	532	
9	1	85.8	8	-	-	272	
10	2	84.7	8	1593	-	182	
11	2	83.3	8	1705	-	134	
12	2	79.8	8	1567	-	286	
13	1	77.9	8	-	-	368	
14	3	98.4	8	1510	1569	290	
15	2	79.9	8	1588	-	231	
16	3	78	8	1140	1353	353	
17	3	55.2	8	1700	1327	53	
18	3	71.9	8	1081	1224	44	
19	1	62	8	-	-	298	
20	3	70.5	8	1888	1442	529	
Detection Check (1=Detection; 0=No Detection)							1

Trial Number							27
Number of Bursts in Trial							8
Chirp Center Frequency							5563
Burst	No. of Pulses	Pulse Width (us)	Chirp Width (MHz)	Pulse 1-to-2 Spacing (us)	Pulse 2-to-3 Spacing (us)	Starting Location Within Interval (ms)	
1	2	69.1	18	1076	-	1436	
2	2	62.1	18	1688	-	22	
3	2	94.8	18	1891	-	897	
4	1	75.8	18	-	-	1186	
5	2	65.4	18	1713	-	589	
6	2	97.7	18	1292	-	614	
7	3	98.1	18	1670	1711	506	
8	2	85.4	18	1672	-	776	
Detection Check (1=Detection; 0=No Detection)							1



Trial Number			28			
Number of Bursts in Trial			9			
Chirp Center Frequency			5562			
Burst	No. of Pulses	Pulse Width (us)	Chirp Width (MHz)	Pulse 1-to-2 Spacing (us)	Pulse 2-to-3 Spacing (us)	Starting Location Within Interval (ms)
1	3	82	19	1233	1713	679
2	3	87.7	19	1554	1123	473
3	2	98.9	19	1518	-	869
4	1	55	19	-	-	719
5	1	93.6	19	-	-	902
6	2	58.7	19	1641	-	1243
7	2	88.7	19	1387	-	410
8	1	60.3	19	-	-	1154
9	1	97.7	19	-	-	512
Detection Check (1=Detection; 0=No Detection)						1

Trial Number			29			
Number of Bursts in Trial			10			
Chirp Center Frequency			5562			
Burst	No. of Pulses	Pulse Width (us)	Chirp Width (MHz)	Pulse 1-to-2 Spacing (us)	Pulse 2-to-3 Spacing (us)	Starting Location Within Interval (ms)
1	1	69.6	20	-	-	1131
2	1	74.5	20	-	-	290
3	1	60.9	20	-	-	895
4	1	74.6	20	-	-	202
5	2	99.3	20	1501	-	139
6	2	95.3	20	1065	-	854
7	2	91.9	20	1722	-	219
8	2	51	20	1285	-	57
9	2	87.7	20	1747	-	141
10	1	87.2	20	-	-	596
Detection Check (1=Detection; 0=No Detection)						1



Trial Number			30			
Number of Bursts in Trial			11			
Chirp Center Frequency			5568			
Burst	No. of Pulses	Pulse Width (us)	Chirp Width (MHz)	Pulse 1-to-2 Spacing (us)	Pulse 2-to-3 Spacing (us)	Starting Location Within Interval (ms)
1	3	59.9	5	1901	1196	935
2	2	77.1	5	1590	-	1038
3	2	62.7	5	1227	-	690
4	1	77.1	5	-	-	547
5	3	99.8	5	1798	1790	551
6	2	61.5	5	1135	-	876
7	2	77.5	5	1583	-	448
8	2	57.3	5	1890	-	736
9	2	53.5	5	1757	-	362
10	1	66.6	5	-	-	836
11	3	80.7	5	1811	1289	410
Detection Check (1=Detection; 0=No Detection)						1



Type 6 Radar Statistical Performance

Trial #	Test Freq. (MHz)	Pulses / Hop	Pulse Width (us)	PRI (us)	1=Detection 0=No Detection
1	5530	9	1	333	1
2	5530	9	1	333	1
3	5530	9	1	333	1
4	5530	9	1	333	1
5	5530	9	1	333	1
6	5530	9	1	333	1
7	5530	9	1	333	1
8	5530	9	1	333	1
9	5530	9	1	333	1
10	5530	9	1	333	1
11	5530	9	1	333	0
12	5530	9	1	333	1
13	5530	9	1	333	1
14	5530	9	1	333	1
15	5530	9	1	333	1
16	5530	9	1	333	1
17	5530	9	1	333	1
18	5530	9	1	333	1
19	5530	9	1	333	1
20	5530	9	1	333	1
21	5530	9	1	333	1
22	5530	9	1	333	1
23	5530	9	1	333	1
24	5530	9	1	333	1
25	5530	9	1	333	1
26	5530	9	1	333	1
27	5530	9	1	333	1
28	5530	9	1	333	1
29	5530	9	1	333	1
30	5530	9	1	333	1
Detection Percentage (%)					96.667
Limit					70%
Test Result					Complied



Modulation Mode: 802.11ac (VHT80+80) / 5290MHz

Type 1 Radar Statistical Performance

Trial #	Test Freq. (MHz)	Pulse Repetition Frequency Number	Pulse Repetition Frequency (Pulse Per Second)	PRI (us)	1=Detection 0=No Detection
1	5290	1	0.0	518	1
2	5291	23	0.0	3066	1
3	5294	19	0.0	878	1
4	5298	12	0.0	738	0
5	5250	4	0.0	578	1
6	5266	8	0.0	658	1
7	5280	15	0.0	798	1
8	5281	6	0.0	618	1
9	5310	14	0.0	778	1
10	5322	3	0.0	558	1
11	5267	13	0.0	758	1
12	5329	9	0.0	678	0
13	5311	7	0.0	638	1
14	5315	17	0.0	838	1
15	5277	10	0.0	698	1
16	5268	-	0.0	591	1
17	5291	-	0.0	3048	1
18	5301	-	0.0	2678	1
19	5308	-	0.0	1741	1
20	5310	-	0.0	822	0
21	5315	-	0.0	1248	1
22	5319	-	0.0	2047	1
23	5328	-	0.0	1046	1
24	5255	-	0.0	1932	1
25	5259	-	0.0	703	1
26	5260	-	0.0	1845	1
27	5268	-	0.0	1349	1
28	5277	-	0.0	1134	1
29	5289	-	0.0	2340	1
30	5287	-	0.0	1590	1
Detection Percentage (%)					90.000
Limit					60%
Test Result					Complied



Type 2 Radar Statistical Performance

Trial #	Test Freq. (MHz)	Pulse Width (us)	PRI (us)	Pulses / Burst	1=Detection 0=No Detection
1	5290	2.6	221	23	1
2	5291	4.6	198	27	1
3	5294	1.1	184	29	0
4	5298	4.8	203	24	1
5	5250	2.4	162	25	1
6	5266	3.4	204	28	1
7	5280	2.3	170	27	1
8	5281	3.5	184	23	1
9	5310	4.9	150	27	1
10	5322	4.6	211	29	1
11	5267	2.9	158	23	1
12	5329	2.6	226	27	1
13	5311	1.6	204	26	0
14	5315	3.9	181	25	1
15	5277	4.6	202	24	1
16	5268	4.1	194	27	1
17	5291	2.3	193	28	1
18	5301	3.9	173	29	1
19	5308	4.3	188	23	1
20	5310	1.5	215	26	1
21	5315	4.9	227	27	1
22	5319	1.1	199	23	1
23	5328	4.5	155	29	1
24	5255	4.0	190	27	1
25	5259	2.4	151	23	1
26	5260	2.5	180	28	1
27	5268	2.5	228	23	1
28	5277	2.5	203	25	1
29	5289	1.5	188	25	1
30	5287	1.9	217	24	1
Detection Percentage (%)					93.333
Limit					60%
Test Result					Complied



Type 3 Radar Statistical Performance

Trial #	Test Freq. (MHz)	Pulse Width (us)	PRI (us)	Pulses / Burst	1=Detection 0=No Detection
1	5290	8.0	205	16	1
2	5291	6.7	382	18	1
3	5294	8.6	418	16	1
4	5298	9.4	351	17	1
5	5250	7.4	383	18	1
6	5266	9.8	232	16	0
7	5280	9.1	377	17	1
8	5281	9.6	457	16	1
9	5310	8.0	471	18	1
10	5322	9.0	304	18	1
11	5267	8.0	316	17	1
12	5329	9.8	325	16	1
13	5311	8.0	409	17	1
14	5315	9.9	200	17	1
15	5277	8.8	458	16	1
16	5268	8.0	232	18	1
17	5291	8.3	250	16	1
18	5301	8.7	270	16	1
19	5308	7.7	350	17	1
20	5310	7.1	230	16	1
21	5315	7.3	416	18	0
22	5319	7.6	498	18	1
23	5328	7.3	286	17	1
24	5255	7.3	287	16	1
25	5259	7.5	462	17	1
26	5260	6.2	300	17	1
27	5268	6.4	323	18	1
28	5277	7.1	420	16	1
29	5289	7.2	395	18	1
30	5287	8.4	377	16	1
Detection Percentage (%)					93.333
Limit					60%
Test Result					Complied



Type 4 Radar Statistical Performance

Trial #	Test Freq. (MHz)	Pulse Width (us)	PRF (us)	Pulses / Burst	1=Detection 0=No Detection
1	5290	18.0	242	15	1
2	5291	19.9	279	12	1
3	5294	12.9	487	14	1
4	5298	15.0	452	13	0
5	5250	16.3	230	12	1
6	5266	19.8	238	13	1
7	5280	18.2	420	16	1
8	5281	16.3	452	15	1
9	5310	14.2	495	12	1
10	5322	17.8	228	16	1
11	5267	19.1	211	16	0
12	5329	18.4	283	15	1
13	5311	11.8	411	12	1
14	5315	14.2	284	13	1
15	5277	13.9	202	12	1
16	5268	17.8	340	14	1
17	5291	15.6	290	16	1
18	5301	14.6	250	16	1
19	5308	14.4	484	15	1
20	5310	18.9	387	13	0
21	5315	11.1	348	15	1
22	5319	13.8	291	16	1
23	5328	14.3	295	12	1
24	5255	12.5	300	12	1
25	5259	12.5	322	14	1
26	5260	12.5	383	13	1
27	5268	15.7	322	16	1
28	5277	19.8	469	13	1
29	5289	18.6	406	15	1
30	5287	15.9	238	14	1
Detection Percentage (%)					90.000
Limit					60%
Test Result					Complied



Total Type 1~4 Radar Statistical Performance

Radar Type #	Detection Percentage (%)
1	90.000
2	93.333
3	93.333
4	90.000
Aggregate (Radar Types 1-4)	91.667
Limit	80%
Test Result	Complied



Type 5 Radar Statistical Performance

Center Freq. (MHz)	Low Edge (MHz)	High Edge (MHz)	VSG Freq. (MHz)	Detection
Trial	Chirp	Offset		
1	5	0	5290	1
2	20	0	5290	1
3	7	0	5290	1
4	8	0	5290	1
5	9	0	5290	1
6	10	0	5290	1
7	11	0	5290	1
8	12	0	5290	1
9	13	0	5290	1
10	14	0	5290	1
11	15	6	5257	1
12	16	6.4	5257	1
13	17	6.8	5258	1
14	20	8	5259	1
15	19	7.6	5259	1
16	18	7.2	5258	1
17	17	6.8	5258	1
18	16	6.4	5257	1
19	15	6	5257	1
20	14	5.6	5257	1
21	13	5.2	5324	1
22	12	4.8	5324	1
23	11	4.4	5325	1
24	10	4	5325	1
25	9	3.6	5325	1
26	8	3.2	5326	1
27	18	7.2	5322	1
28	19	7.6	5321	1
29	20	8	5321	1
30	5	2	5327	1
Total				30
Detection Percentage (%)				100%
Limit				80%
Test Result				Complied



Trial Number							1
Number of Bursts in Trial							8
Chirp Center Frequency							5290
Burst	No. of Pulses	Pulse Width (us)	Chirp Width (MHz)	Pulse 1-to-2 Spacing (us)	Pulse 2-to-3 Spacing (us)	Starting Location Within Interval (ms)	
1	1	62.1	5	-	-	1091	
2	2	56	5	1729	-	133	
3	2	91.3	5	1230	-	1057	
4	3	50.7	5	1762	1616	1442	
5	2	92.6	5	1723	-	544	
6	2	87.3	5	1302	-	1089	
7	2	59.5	5	1291	-	1374	
8	2	52.2	5	1653	-	1237	
Detection Check (1=Detection; 0=No Detection)							1

Trial Number							2
Number of Bursts in Trial							9
Chirp Center Frequency							5290
Burst	No. of Pulses	Pulse Width (us)	Chirp Width (MHz)	Pulse 1-to-2 Spacing (us)	Pulse 2-to-3 Spacing (us)	Starting Location Within Interval (ms)	
1	3	90	20	1007	1326	30	
2	2	73.7	20	1785	-	979	
3	1	78.1	20	-	-	683	
4	2	92.4	20	1281	-	950	
5	1	61.2	20	-	-	612	
6	3	67.2	20	1525	1870	17	
7	1	78.5	20	-	-	429	
8	2	60.3	20	1931	-	936	
9	3	92.9	20	1403	1476	548	
Detection Check (1=Detection; 0=No Detection)							1



Trial Number							3
Number of Bursts in Trial							10
Chirp Center Frequency							5290
Burst	No. of Pulses	Pulse Width (us)	Chirp Width (MHz)	Pulse 1-to-2 Spacing (us)	Pulse 2-to-3 Spacing (us)	Starting Location Within Interval (ms)	
1	3	63.4	7	1574	1607	801	
2	1	98	7	-	-	966	
3	1	58.7	7	-	-	185	
4	1	88	7	-	-	1012	
5	3	79.5	7	1562	1370	943	
6	3	57.1	7	1900	1188	686	
7	2	64.4	7	1090	-	599	
8	1	78.7	7	-	-	1089	
9	1	69.3	7	-	-	188	
10	3	55.3	7	1375	1691	933	
Detection Check (1=Detection; 0=No Detection)							1

Trial Number							4
Number of Bursts in Trial							11
Chirp Center Frequency							5290
Burst	No. of Pulses	Pulse Width (us)	Chirp Width (MHz)	Pulse 1-to-2 Spacing (us)	Pulse 2-to-3 Spacing (us)	Starting Location Within Interval (ms)	
1	2	74.3	8	1642	-	24	
2	1	83.1	8	-	-	985	
3	2	59.5	8	1680	-	988	
4	2	59.8	8	1786	-	800	
5	2	77.6	8	1617	-	339	
6	2	79.9	8	1553	-	1040	
7	1	56	8	-	-	544	
8	3	71.4	8	1406	1927	452	
9	1	97.4	8	-	-	204	
10	2	98.3	8	1037	-	926	
11	1	63.6	8	-	-	1052	
Detection Check (1=Detection; 0=No Detection)							1



Trial Number							5
Number of Bursts in Trial							12
Chirp Center Frequency							5290
Burst	No. of Pulses	Pulse Width (us)	Chirp Width (MHz)	Pulse 1-to-2 Spacing (us)	Pulse 2-to-3 Spacing (us)	Starting Location Within Interval (ms)	
1	1	50	9	-	-	557	
2	2	62.5	9	1731	-	567	
3	2	55.4	9	1070	-	460	
4	1	65.7	9	-	-	4	
5	2	58	9	1512	-	64	
6	2	60.9	9	1230	-	650	
7	3	89.6	9	1598	1738	235	
8	3	84.4	9	1271	1617	873	
9	3	72.3	9	1498	1321	901	
10	1	58.9	9	-	-	663	
11	2	74.8	9	1584	-	919	
12	1	71.8	9	-	-	375	
Detection Check (1=Detection; 0=No Detection)							1

Trial Number							6
Number of Bursts in Trial							13
Chirp Center Frequency							5290
Burst	No. of Pulses	Pulse Width (us)	Chirp Width (MHz)	Pulse 1-to-2 Spacing (us)	Pulse 2-to-3 Spacing (us)	Starting Location Within Interval (ms)	
1	2	88.1	10	1257	-	846	
2	1	58.7	10	-	-	725	
3	2	97.1	10	1037	-	30	
4	3	83.1	10	1029	1106	490	
5	1	62.1	10	-	-	262	
6	2	71.4	10	1058	-	283	
7	2	86.3	10	1867	-	49	
8	3	77.3	10	1418	1876	634	
9	1	78.9	10	-	-	304	
10	3	79.2	10	1055	1572	564	
11	3	52	10	1582	1836	852	
12	3	56.5	10	1195	1542	525	
13	3	100	10	1638	1729	750	
Detection Check (1=Detection; 0=No Detection)							1



Trial Number							7
Number of Bursts in Trial							14
Chirp Center Frequency							5290
Burst	No. of Pulses	Pulse Width (us)	Chirp Width (MHz)	Pulse 1-to-2 Spacing (us)	Pulse 2-to-3 Spacing (us)	Starting Location Within Interval (ms)	
1	2	92.7	11	1208	-	231	
2	2	81.3	11	1144	-	804	
3	2	60.4	11	1555	-	34	
4	2	62.1	11	1320	-	427	
5	1	50	11	-	-	577	
6	3	65.9	11	1020	1365	3	
7	2	73.8	11	1308	-	51	
8	2	74.3	11	1143	-	360	
9	1	62.9	11	-	-	394	
10	2	74.8	11	1404	-	317	
11	2	69.7	11	1309	-	532	
12	2	69.8	11	1688	-	339	
13	2	77.4	11	1857	-	381	
14	1	55.1	11	-	-	426	
Detection Check (1=Detection; 0=No Detection)							1

Trial Number							8
Number of Bursts in Trial							15
Chirp Center Frequency							5290
Burst	No. of Pulses	Pulse Width (us)	Chirp Width (MHz)	Pulse 1-to-2 Spacing (us)	Pulse 2-to-3 Spacing (us)	Starting Location Within Interval (ms)	
1	1	91.7	12	-	-	776	
2	2	90	12	1196	-	187	
3	3	92.3	12	1486	1853	448	
4	2	66.8	12	1545	-	702	
5	1	64	12	-	-	403	
6	3	95.4	12	1123	1473	230	
7	3	66.8	12	1867	1401	604	
8	3	67.7	12	1472	1397	38	
9	1	68.2	12	-	-	735	
10	2	82.2	12	1297	-	610	
11	1	92.1	12	-	-	618	
12	2	57	12	1764	-	705	
13	2	58.5	12	1310	-	22	
14	3	85.5	12	1630	1447	641	
15	2	82.2	12	1371	-	109	
Detection Check (1=Detection; 0=No Detection)							1



Trial Number							9
Number of Bursts in Trial							16
Chirp Center Frequency							5290
Burst	No. of Pulses	Pulse Width (us)	Chirp Width (MHz)	Pulse 1-to-2 Spacing (us)	Pulse 2-to-3 Spacing (us)	Starting Location Within Interval (ms)	
1	2	74.4	13	1707	-	442	
2	2	63.6	13	1725	-	280	
3	2	71.3	13	1704	-	459	
4	3	77.6	13	1063	1405	197	
5	3	65.2	13	1731	1294	101	
6	3	55.1	13	1109	1549	17	
7	2	96.8	13	1034	-	131	
8	3	80.8	13	1533	1051	365	
9	1	60.4	13	-	-	222	
10	2	61.8	13	1312	-	371	
11	2	71.3	13	1657	-	33	
12	2	98.1	13	1024	-	291	
13	1	57.9	13	-	-	188	
14	1	91.8	13	-	-	163	
15	2	56.7	13	1259	-	426	
16	2	89.7	13	1690	-	606	
Detection Check (1=Detection; 0=No Detection)							1

Trial Number							10
Number of Bursts in Trial							17
Chirp Center Frequency							5290
Burst	No. of Pulses	Pulse Width (us)	Chirp Width (MHz)	Pulse 1-to-2 Spacing (us)	Pulse 2-to-3 Spacing (us)	Starting Location Within Interval (ms)	
1	2	74.4	14	1107	-	462	
2	1	87.6	14	-	-	653	
3	2	61.7	14	1741	-	457	
4	2	57.5	14	1566	-	388	
5	2	66.1	14	1855	-	63	
6	3	70.1	14	1044	1012	136	
7	1	66.4	14	-	-	343	
8	1	59.2	14	-	-	349	
9	2	88.3	14	1240	-	362	
10	1	64.7	14	-	-	221	
11	2	73	14	1703	-	144	
12	2	81.7	14	1450	-	671	
13	3	70.1	14	1741	1278	320	
14	1	63.6	14	-	-	196	
15	1	58.7	14	-	-	413	
16	2	65.9	14	1478	-	170	
17	1	72.7	14	-	-	564	
Detection Check (1=Detection; 0=No Detection)							1



Trial Number				11		
Number of Bursts in Trial				18		
Chirp Center Frequency				5257		
Burst	No. of Pulses	Pulse Width (us)	Chirp Width (MHz)	Pulse 1-to-2 Spacing (us)	Pulse 2-to-3 Spacing (us)	Starting Location Within Interval (ms)
1	2	72.1	15	1193	-	130
2	3	76.3	15	1484	1390	114
3	1	86.1	15	-	-	14
4	1	73.2	15	-	-	604
5	1	81.2	15	-	-	548
6	2	99.5	15	1398	-	173
7	1	93.9	15	-	-	262
8	2	75.9	15	1921	-	38
9	3	79.2	15	1100	1429	84
10	3	77	15	1166	1799	610
11	1	91.8	15	-	-	339
12	3	56.8	15	1330	1556	580
13	2	83.1	15	1556	-	295
14	2	63	15	1552	-	156
15	1	65.7	15	-	-	439
16	1	64.5	15	-	-	188
17	1	88.5	15	-	-	419
18	1	60.6	15	-	-	205
Detection Check (1=Detection; 0=No Detection)						1



Trial Number			12			
Number of Bursts in Trial			19			
Chirp Center Frequency			5257			
Burst	No. of Pulses	Pulse Width (us)	Chirp Width (MHz)	Pulse 1-to-2 Spacing (us)	Pulse 2-to-3 Spacing (us)	Starting Location Within Interval (ms)
1	2	90.5	16	1299	-	381
2	2	88.4	16	1418	-	327
3	2	53.7	16	1055	-	536
4	1	80.5	16	-	-	285
5	1	50.4	16	-	-	398
6	2	61.2	16	1749	-	439
7	2	78.8	16	1065	-	129
8	3	75	16	1748	1820	325
9	2	96.7	16	1254	-	440
10	3	76.3	16	1848	1106	397
11	1	73.3	16	-	-	232
12	2	92.4	16	1317	-	91
13	2	92.4	16	1854	-	256
14	3	64.4	16	1240	1634	582
15	2	67.3	16	1473	-	117
16	2	84.1	16	1795	-	202
17	1	80.9	16	-	-	135
18	1	74.6	16	-	-	396
19	2	97.6	16	1805	-	615
Detection Check (1=Detection; 0=No Detection)						1



Trial Number							13
Number of Bursts in Trial							20
Chirp Center Frequency							5258
Burst	No. of Pulses	Pulse Width (us)	Chirp Width (MHz)	Pulse 1-to-2 Spacing (us)	Pulse 2-to-3 Spacing (us)	Starting Location Within Interval (ms)	
1	2	66.1	17	1417	-	388	
2	2	86.7	17	1693	-	348	
3	2	70.5	17	1263	-	215	
4	2	78	17	1446	-	28	
5	2	66	17	1185	-	585	
6	2	80.6	17	1855	-	65	
7	1	95.5	17	-	-	92	
8	1	98.8	17	-	-	68	
9	3	64.3	17	1641	1108	517	
10	1	75.1	17	-	-	121	
11	2	72.6	17	1499	-	448	
12	1	60.3	17	-	-	567	
13	2	54.9	17	1056	-	245	
14	2	98.8	17	1023	-	584	
15	2	60.9	17	1243	-	579	
16	2	62.7	17	1226	-	464	
17	1	80.1	17	-	-	89	
18	2	70.9	17	1711	-	153	
19	1	90.7	17	-	-	282	
20	1	98.9	17	-	-	71	
Detection Check (1=Detection; 0=No Detection)							1

Trial Number							14
Number of Bursts in Trial							8
Chirp Center Frequency							5259
Burst	No. of Pulses	Pulse Width (us)	Chirp Width (MHz)	Pulse 1-to-2 Spacing (us)	Pulse 2-to-3 Spacing (us)	Starting Location Within Interval (ms)	
1	2	67.5	20	1542	-	947	
2	3	83.6	20	1272	1696	124	
3	2	93.2	20	1877	-	701	
4	1	55.6	20	-	-	1123	
5	3	84.2	20	1733	1619	756	
6	3	69.1	20	1612	1071	1	
7	2	66.9	20	1905	-	7	
8	3	86.8	20	1697	1621	1082	
Detection Check (1=Detection; 0=No Detection)							1



Trial Number							15
Number of Bursts in Trial							9
Chirp Center Frequency							5259
Burst	No. of Pulses	Pulse Width (us)	Chirp Width (MHz)	Pulse 1-to-2 Spacing (us)	Pulse 2-to-3 Spacing (us)	Starting Location Within Interval (ms)	
1	2	62.2	19	1571	-	949	
2	2	85	19	1669	-	189	
3	2	64.5	19	1505	-	176	
4	2	50.4	19	1325	-	538	
5	2	66.1	19	1483	-	908	
6	2	71.2	19	1110	-	1017	
7	3	53.7	19	1445	1677	492	
8	3	62.5	19	1596	1341	349	
9	3	62	19	1929	1221	1105	
Detection Check (1=Detection; 0=No Detection)							1

Trial Number							16
Number of Bursts in Trial							10
Chirp Center Frequency							5258
Burst	No. of Pulses	Pulse Width (us)	Chirp Width (MHz)	Pulse 1-to-2 Spacing (us)	Pulse 2-to-3 Spacing (us)	Starting Location Within Interval (ms)	
1	2	80.5	18	1910	-	284	
2	2	64.2	18	1661	-	751	
3	2	90.1	18	1041	-	491	
4	2	69.8	18	1495	-	107	
5	1	73.1	18	-	-	490	
6	3	77.2	18	1418	1145	1155	
7	3	52.6	18	1732	1787	772	
8	2	71.4	18	1562	-	121	
9	2	89.8	18	1491	-	89	
10	2	76.4	18	1355	-	615	
Detection Check (1=Detection; 0=No Detection)							1



Trial Number							17
Number of Bursts in Trial							11
Chirp Center Frequency							5258
Burst	No. of Pulses	Pulse Width (us)	Chirp Width (MHz)	Pulse 1-to-2 Spacing (us)	Pulse 2-to-3 Spacing (us)	Starting Location Within Interval (ms)	
1	2	51.2	17	1236	-	740	
2	1	71.7	17	-	-	941	
3	2	74.7	17	1164	-	370	
4	2	50.9	17	1919	-	371	
5	2	65.2	17	1206	-	1033	
6	2	98	17	1182	-	346	
7	2	58.7	17	1612	-	639	
8	1	63.8	17	-	-	1056	
9	3	86.3	17	1545	1065	205	
10	1	94.4	17	-	-	753	
11	3	88.5	17	1699	1319	58	
Detection Check (1=Detection; 0=No Detection)							1

Trial Number							18
Number of Bursts in Trial							12
Chirp Center Frequency							5257
Burst	No. of Pulses	Pulse Width (us)	Chirp Width (MHz)	Pulse 1-to-2 Spacing (us)	Pulse 2-to-3 Spacing (us)	Starting Location Within Interval (ms)	
1	2	88.7	16	1405	-	448	
2	3	90.2	16	1544	1235	621	
3	1	96.5	16	-	-	512	
4	2	80.5	16	1090	-	321	
5	2	63.7	16	1268	-	798	
6	1	53.4	16	-	-	809	
7	2	52.3	16	1043	-	301	
8	3	54.7	16	1701	1104	796	
9	3	75.6	16	1923	1729	669	
10	2	59.2	16	1244	-	369	
11	1	56.3	16	-	-	51	
12	2	87.8	16	1608	-	733	
Detection Check (1=Detection; 0=No Detection)							1



Trial Number							19
Number of Bursts in Trial							13
Chirp Center Frequency							5257
Burst	No. of Pulses	Pulse Width (us)	Chirp Width (MHz)	Pulse 1-to-2 Spacing (us)	Pulse 2-to-3 Spacing (us)	Starting Location Within Interval (ms)	
1	2	68.2	15	1104	-	229	
2	2	58.4	15	1627	-	488	
3	3	74.7	15	1861	1015	137	
4	2	58.2	15	1593	-	520	
5	1	51.6	15	-	-	799	
6	2	94.7	15	1469	-	43	
7	2	70.7	15	1091	-	126	
8	2	82.9	15	1472	-	607	
9	3	62.7	15	1168	1453	527	
10	2	63.1	15	1529	-	143	
11	1	96.1	15	-	-	176	
12	2	57	15	1457	-	882	
13	3	95.6	15	1707	1501	214	
Detection Check (1=Detection; 0=No Detection)							1

Trial Number							20
Number of Bursts in Trial							14
Chirp Center Frequency							5257
Burst	No. of Pulses	Pulse Width (us)	Chirp Width (MHz)	Pulse 1-to-2 Spacing (us)	Pulse 2-to-3 Spacing (us)	Starting Location Within Interval (ms)	
1	1	95.7	14	-	-	117	
2	1	93.1	14	-	-	720	
3	1	55.8	14	-	-	297	
4	1	76.7	14	-	-	284	
5	2	68	14	1686	-	472	
6	3	94.1	14	1796	1393	264	
7	2	53.9	14	1293	-	525	
8	1	99.3	14	-	-	155	
9	2	73.3	14	1458	-	65	
10	2	93.3	14	1196	-	451	
11	3	55.8	14	1895	1034	243	
12	1	66.4	14	-	-	228	
13	2	65.6	14	1732	-	746	
14	2	76.5	14	1187	-	522	
Detection Check (1=Detection; 0=No Detection)							1



Trial Number							21
Number of Bursts in Trial							15
Chirp Center Frequency							5324
Burst	No. of Pulses	Pulse Width (us)	Chirp Width (MHz)	Pulse 1-to-2 Spacing (us)	Pulse 2-to-3 Spacing (us)	Starting Location Within Interval (ms)	
1	1	85.1	13	-	-	565	
2	2	72.5	13	1648	-	211	
3	1	67.5	13	-	-	348	
4	2	56.1	13	1360	-	156	
5	1	71.1	13	-	-	718	
6	2	93.1	13	1391	-	400	
7	1	56.5	13	-	-	482	
8	1	63.8	13	-	-	703	
9	2	67.4	13	1727	-	780	
10	1	52.3	13	-	-	102	
11	3	62.4	13	1228	1715	304	
12	2	53.3	13	1630	-	57	
13	2	83.1	13	1205	-	768	
14	2	93.7	13	1085	-	461	
15	2	90.7	13	1297	-	746	
Detection Check (1=Detection; 0=No Detection)							1

Trial Number							22
Number of Bursts in Trial							16
Chirp Center Frequency							5324
Burst	No. of Pulses	Pulse Width (us)	Chirp Width (MHz)	Pulse 1-to-2 Spacing (us)	Pulse 2-to-3 Spacing (us)	Starting Location Within Interval (ms)	
1	2	98.8	12	1439	-	95	
2	1	54.5	12	-	-	676	
3	2	80.5	12	1360	-	8	
4	2	55.9	12	1906	-	373	
5	2	72.1	12	1623	-	254	
6	2	84.4	12	1604	-	480	
7	1	78.5	12	-	-	663	
8	1	88	12	-	-	314	
9	2	74.7	12	1157	-	596	
10	2	97.1	12	1673	-	264	
11	1	81.6	12	-	-	740	
12	1	83.6	12	-	-	163	
13	3	87.6	12	1757	1322	628	
14	2	58.5	12	1372	-	132	
15	3	91.8	12	1767	1183	106	
16	2	58.8	12	1432	-	659	
Detection Check (1=Detection; 0=No Detection)							1



Trial Number							23
Number of Bursts in Trial							17
Chirp Center Frequency							5325
Burst	No. of Pulses	Pulse Width (us)	Chirp Width (MHz)	Pulse 1-to-2 Spacing (us)	Pulse 2-to-3 Spacing (us)	Starting Location Within Interval (ms)	
1	1	96	11	-	-	284	
2	2	92.5	11	1241	-	488	
3	2	89.5	11	1347	-	76	
4	2	74.8	11	1607	-	688	
5	2	60.6	11	1523	-	28	
6	2	71.5	11	1659	-	383	
7	2	71.1	11	1454	-	182	
8	1	98.7	11	-	-	20	
9	2	85.1	11	1770	-	576	
10	2	89.2	11	1086	-	410	
11	2	60.7	11	1101	-	458	
12	2	75.2	11	1719	-	348	
13	2	75.7	11	1799	-	481	
14	3	56.7	11	1132	1884	587	
15	2	65	11	1885	-	480	
16	2	64.6	11	1910	-	195	
17	3	69.9	11	1410	1190	396	
Detection Check (1=Detection; 0=No Detection)							1

Trial Number							24
Number of Bursts in Trial							18
Chirp Center Frequency							5325
Burst	No. of Pulses	Pulse Width (us)	Chirp Width (MHz)	Pulse 1-to-2 Spacing (us)	Pulse 2-to-3 Spacing (us)	Starting Location Within Interval (ms)	
1	3	83.8	10	1290	1021	536	
2	2	66.9	10	1112	-	44	
3	3	91	10	1220	1504	611	
4	2	86.1	10	1678	-	456	
5	3	65.5	10	1928	1222	330	
6	1	62.6	10	-	-	297	
7	3	68.7	10	1505	1200	351	
8	3	59.2	10	1452	1114	230	
9	1	73.9	10	-	-	222	
10	1	77.2	10	-	-	57	
11	2	96.4	10	1357	-	399	
12	2	99.9	10	1173	-	299	
13	2	99.9	10	1520	-	464	
14	1	86.7	10	-	-	294	
15	1	92.6	10	-	-	653	
16	1	77.1	10	-	-	550	
17	2	81.1	10	1664	-	566	
18	3	68.4	10	1536	1309	580	
Detection Check (1=Detection; 0=No Detection)							1



Trial Number				25		
Number of Bursts in Trial				19		
Chirp Center Frequency				5325		
Burst	No. of Pulses	Pulse Width (us)	Chirp Width (MHz)	Pulse 1-to-2 Spacing (us)	Pulse 2-to-3 Spacing (us)	Starting Location Within Interval (ms)
1	3	68.2	9	1723	1868	471
2	3	83.7	9	1711	1405	368
3	2	69.7	9	1781	-	425
4	1	59.7	9	-	-	440
5	2	96.7	9	1484	-	123
6	2	95.8	9	1319	-	261
7	3	71.3	9	1095	1354	332
8	3	53.2	9	1527	1427	427
9	2	69.5	9	1771	-	397
10	3	63.9	9	1075	1447	67
11	2	93.4	9	1783	-	174
12	2	77.3	9	1564	-	17
13	2	73.1	9	1294	-	216
14	1	77.4	9	-	-	292
15	3	57.2	9	1722	1886	619
16	2	68.7	9	1629	-	233
17	1	60.8	9	-	-	226
18	3	69.7	9	1128	1224	599
19	1	62.2	9	-	-	433
Detection Check (1=Detection; 0=No Detection)						1



Trial Number							26
Number of Bursts in Trial							20
Chirp Center Frequency							5326
Burst	No. of Pulses	Pulse Width (us)	Chirp Width (MHz)	Pulse 1-to-2 Spacing (us)	Pulse 2-to-3 Spacing (us)	Starting Location Within Interval (ms)	
1	1	80.5	8	-	-	90	
2	3	62.6	8	1406	1343	319	
3	3	85.6	8	1190	1529	384	
4	2	83.9	8	1208	-	567	
5	2	92.4	8	1488	-	234	
6	2	54	8	1529	-	535	
7	3	81.3	8	1501	1812	325	
8	1	98.5	8	-	-	532	
9	1	85.8	8	-	-	272	
10	2	84.7	8	1593	-	182	
11	2	83.3	8	1705	-	134	
12	2	79.8	8	1567	-	286	
13	1	77.9	8	-	-	368	
14	3	98.4	8	1510	1569	290	
15	2	79.9	8	1588	-	231	
16	3	78	8	1140	1353	353	
17	3	55.2	8	1700	1327	53	
18	3	71.9	8	1081	1224	44	
19	1	62	8	-	-	298	
20	3	70.5	8	1888	1442	529	
Detection Check (1=Detection; 0=No Detection)							1

Trial Number							27
Number of Bursts in Trial							8
Chirp Center Frequency							5322
Burst	No. of Pulses	Pulse Width (us)	Chirp Width (MHz)	Pulse 1-to-2 Spacing (us)	Pulse 2-to-3 Spacing (us)	Starting Location Within Interval (ms)	
1	2	69.1	18	1076	-	1436	
2	2	62.1	18	1688	-	22	
3	2	94.8	18	1891	-	897	
4	1	75.8	18	-	-	1186	
5	2	65.4	18	1713	-	589	
6	2	97.7	18	1292	-	614	
7	3	98.1	18	1670	1711	506	
8	2	85.4	18	1672	-	776	
Detection Check (1=Detection; 0=No Detection)							1



Trial Number							28
Number of Bursts in Trial							9
Chirp Center Frequency							5321
Burst	No. of Pulses	Pulse Width (us)	Chirp Width (MHz)	Pulse 1-to-2 Spacing (us)	Pulse 2-to-3 Spacing (us)	Starting Location Within Interval (ms)	
1	3	82	19	1233	1713	679	
2	3	87.7	19	1554	1123	473	
3	2	98.9	19	1518	-	869	
4	1	55	19	-	-	719	
5	1	93.6	19	-	-	902	
6	2	58.7	19	1641	-	1243	
7	2	88.7	19	1387	-	410	
8	1	60.3	19	-	-	1154	
9	1	97.7	19	-	-	512	
Detection Check (1=Detection; 0=No Detection)							1

Trial Number							29
Number of Bursts in Trial							10
Chirp Center Frequency							5321
Burst	No. of Pulses	Pulse Width (us)	Chirp Width (MHz)	Pulse 1-to-2 Spacing (us)	Pulse 2-to-3 Spacing (us)	Starting Location Within Interval (ms)	
1	1	69.6	20	-	-	1131	
2	1	74.5	20	-	-	290	
3	1	60.9	20	-	-	895	
4	1	74.6	20	-	-	202	
5	2	99.3	20	1501	-	139	
6	2	95.3	20	1065	-	854	
7	2	91.9	20	1722	-	219	
8	2	51	20	1285	-	57	
9	2	87.7	20	1747	-	141	
10	1	87.2	20	-	-	596	
Detection Check (1=Detection; 0=No Detection)							1



Trial Number			30			
Number of Bursts in Trial			11			
Chirp Center Frequency			5327			
Burst	No. of Pulses	Pulse Width (us)	Chirp Width (MHz)	Pulse 1-to-2 Spacing (us)	Pulse 2-to-3 Spacing (us)	Starting Location Within Interval (ms)
1	3	59.9	5	1901	1196	935
2	2	77.1	5	1590	-	1038
3	2	62.7	5	1227	-	690
4	1	77.1	5	-	-	547
5	3	99.8	5	1798	1790	551
6	2	61.5	5	1135	-	876
7	2	77.5	5	1583	-	448
8	2	57.3	5	1890	-	736
9	2	53.5	5	1757	-	362
10	1	66.6	5	-	-	836
11	3	80.7	5	1811	1289	410
Detection Check (1=Detection; 0=No Detection)						1



Type 6 Radar Statistical Performance

Trial #	Test Freq. (MHz)	Pulses / Hop	Pulse Width (us)	PRI (us)	1=Detection 0=No Detection
1	5290	9	1	333	1
2	5290	9	1	333	1
3	5290	9	1	333	1
4	5290	9	1	333	1
5	5290	9	1	333	1
6	5290	9	1	333	1
7	5290	9	1	333	1
8	5290	9	1	333	1
9	5290	9	1	333	0
10	5290	9	1	333	1
11	5290	9	1	333	1
12	5290	9	1	333	1
13	5290	9	1	333	1
14	5290	9	1	333	1
15	5290	9	1	333	1
16	5290	9	1	333	1
17	5290	9	1	333	1
18	5290	9	1	333	1
19	5290	9	1	333	1
20	5290	9	1	333	1
21	5290	9	1	333	1
22	5290	9	1	333	0
23	5290	9	1	333	1
24	5290	9	1	333	1
25	5290	9	1	333	1
26	5290	9	1	333	1
27	5290	9	1	333	1
28	5290	9	1	333	1
29	5290	9	1	333	1
30	5290	9	1	333	1
Detection Percentage (%)					93.333
Limit					70%
Test Result					Complied



4 Test Equipment and Calibration Data

Instrument	Manufacturer	Model No.	Serial No.	Characteristics	Calibration Date	Remark
Spectrum Analyzer	R&S	FSV40	101026	9kHz~40GHz	Sep. 14, 2016	Radiated (DF01-CB)
Vector Signal generator	R&S	SMU200A	102782	25MHz-6GHz	Dec. 16, 2016	Radiated (DF01-CB)
Horn Antenna	COM-POWER	AH-118	071187	1GHz – 18GHz	Jul. 28, 2016	Radiated (DF01-CB)
Horn Antenna	COM-POWER	AH-118	071042	1GHz – 18GHz	Dec. 05, 2016	Radiated (DF01-CB)
RF Power Divider	ANAREN	2 Way	DFS-01-DV-02	1GHz ~ 6GHz	Oct. 24, 2016	Radiated (DF01-CB)
RF Power Divider	MTJ	2 Way	DFS-01-DV-03	1GHz ~ 6GHz	Oct. 24, 2016	Radiated (DF01-CB)
RF Power Divider	ANAREN	4 Way	DFS-01-DV-01	1GHz ~ 6GHz	Oct. 24, 2016	Radiated (DF01-CB)
RF Cable-high	Woken	RG402	High Cable-57	1 GHz –18 GHz	Oct. 24, 2016	Radiated (DF01-CB)
RF Cable-high	Woken	RG402	High Cable-58	1 GHz –18 GHz	Oct. 24, 2016	Radiated (DF01-CB)

Note: Calibration Interval of instruments listed above is one year.



5 Measurement Uncertainty

Test Items	Uncertainty	Remark
Radiated Emission	2.9 dB	Confidence levels of 95%