



# SPORTON International Inc.

No. 52, Hwa Ya 1st Rd., Hwa Ya Technology Park, Kwei-Shan Hsiang, Tao Yuan Hsien, Taiwan, R.O.C.  
Ph: 886-3-327-3456 / FAX: 886-3-327-0973 / www.sporton.com.tw

## FCC RADIO TEST REPORT

Applicant's company	Mojo Networks, Inc.
Applicant Address	339 N. Bernardo Avenue, Suite #200 Mountain View, CA 94043 United States
FCC ID	TOR-C120
Manufacturer's company	Mojo Networks, Inc.
Manufacturer Address	339 N. Bernardo Avenue, Suite #200 Mountain View, CA 94043 United States

Product Name	802.11a/b/g/n/ac AP
Brand Name	MOJO
Model No.	C-120
Test Rule Part(s)	47 CFR FCC Part 15 Subpart E § 15.407
Test Freq. Range	5150 ~ 5250MHz / 5725 ~ 5850 MHz
Received Date	Apr. 13, 2016
Final Test Date	May 19, 2016
Submission Type	Original Equipment

### Statement

**Test result included is for the IEEE 802.11n and IEEE 802.11a/ac of the product.**

The test result in this report refers exclusively to the presented test model / sample.

Without written approval of SPORTON International Inc., the test report shall not be reproduced except in full.

The measurements and test results shown in this test report were made in accordance with the procedures and found in compliance with the limit given in **ANSI C63.10-2013, 47 CFR FCC Part 15 Subpart E, KDB789033 D02 v01r02, KDB662911 D01 v02r01, KDB644545 D03 v01, ET Docket No. 13-49; FCC 16-24.**

The test equipment used to perform the test is calibrated and traceable to NML/ROC.



## Table of Contents

<b>1. VERIFICATION OF COMPLIANCE</b> .....	<b>1</b>
<b>2. SUMMARY OF THE TEST RESULT</b> .....	<b>2</b>
<b>3. GENERAL INFORMATION</b> .....	<b>3</b>
3.1. Product Details.....	3
3.2. Accessories.....	5
3.3. Table for Filed Antenna.....	6
3.4. Table for Carrier Frequencies .....	7
3.5. Table for 80+80 MHz Mode.....	7
3.6. Table for Test Modes .....	8
3.7. Table for Testing Locations.....	11
3.8. Table for Supporting Units .....	12
3.9. Table for Parameters of Test Software Setting .....	13
3.10. EUT Operation during Test .....	14
3.11. Duty Cycle.....	14
3.12. Test Configurations .....	15
<b>4. TEST RESULT</b> .....	<b>19</b>
4.1. AC Power Line Conducted Emissions Measurement.....	19
4.2. 26dB Bandwidth and 99% Occupied Bandwidth Measurement.....	23
4.3. 6dB Spectrum Bandwidth Measurement .....	43
4.4. Maximum Conducted Output Power Measurement.....	52
4.5. Power Spectral Density Measurement .....	56
4.6. Radiated Emissions Measurement .....	72
4.7. Band Edge Emissions Measurement .....	111
4.8. Frequency Stability Measurement .....	127
4.9. Antenna Requirements .....	134
<b>5. LIST OF MEASURING EQUIPMENTS</b> .....	<b>135</b>
<b>6. MEASUREMENT UNCERTAINTY</b> .....	<b>137</b>
<b>APPENDIX A. TEST PHOTOS</b> .....	<b>A1 ~ A4</b>
<b>APPENDIX B. RADIATED EMISSION CO-LOCATION REPORT</b> .....	<b>B1 ~ B3</b>



## History of This Test Report

REPORT NO.	VERSION	DESCRIPTION	ISSUED DATE
FR641226AB	Rev. 01	Initial issue of report	May 27, 2016



## 1. VERIFICATION OF COMPLIANCE

Product Name : 802.11a/b/g/n/ac AP  
Brand Name : MOJO  
Model No. : C-120  
Applicant : Mojo Networks, Inc.  
Test Rule Part(s) : 47 CFR FCC Part 15 Subpart E § 15.407

Sporton International as requested by the applicant to evaluate the EMC performance of the product sample received on Apr. 13, 2016 would like to declare that the tested sample has been evaluated and found to be in compliance with the tested rule parts. The data recorded as well as the test configuration specified is true and accurate for showing the sample's EMC nature.

A handwritten signature in blue ink that reads 'Cliff Chang' is written over a horizontal line.

Cliff Chang

SPORTON INTERNATIONAL INC.

## 2. SUMMARY OF THE TEST RESULT

Applied Standard: 47 CFR FCC Part 15 Subpart E			
Part	Rule Section	Description of Test	Result
4.1	15.207	AC Power Line Conducted Emissions	Complies
4.2	15.407(a)	26dB Spectrum Bandwidth and 99% Occupied Bandwidth	Complies
4.3	15.407(e)	6dB Spectrum Bandwidth	Complies
4.4	15.407(a)	Maximum Conducted Output Power	Complies
4.5	15.407(a)	Power Spectral Density	Complies
4.6	15.407(b)	Radiated Emissions	Complies
4.7	15.407(b)	Band Edge Emissions	Complies
4.8	15.407(g)	Frequency Stability	Complies
4.9	15.203	Antenna Requirements	Complies

### 3. GENERAL INFORMATION

#### 3.1. Product Details

Items	Description
Product Type	WLAN (4TX, 4RX)
Radio Type	Intentional Transceiver
Power Type	From power adapter or PoE
Modulation	IEEE 802.11a: OFDM IEEE 802.11n/ac: see the below table
Data Modulation	IEEE 802.11a/n: OFDM (BPSK / QPSK / 16QAM / 64QAM) IEEE 802.11ac: OFDM (BPSK / QPSK / 16QAM / 64QAM / 256QAM)
Data Rate (Mbps)	IEEE 802.11a: OFDM (6/9/12/18/24/36/48/54) IEEE 802.11n/ac: see the below table
Frequency Range	5150 ~ 5250MHz / 5725 ~ 5850 MHz
Channel Number	9 for 20MHz bandwidth ; 4 for 40MHz bandwidth 2 for 80MHz bandwidth
Channel Band Width (99%)	<p><b>&lt;For Non-Beamforming Mode&gt;</b></p> <p>Band 1:</p> <p>IEEE 802.11a: 16.67 MHz</p> <p>IEEE 802.11ac MCS0/Nss1 (VHT20): 17.63 MHz</p> <p>IEEE 802.11ac MCS0/Nss1 (VHT40): 34.15 MHz</p> <p>IEEE 802.11ac MCS0/Nss1 (VHT80): 73.52 MHz</p> <p>IEEE 802.11ac MCS0/Nss2 (VHT80+80): 75.25 MHz</p> <p>Band 4:</p> <p>IEEE 802.11a: 16.93 MHz</p> <p>IEEE 802.11ac MCS0/Nss1 (VHT20): 17.80 MHz</p> <p>IEEE 802.11ac MCS0/Nss1 (VHT40): 34.73 MHz</p> <p>IEEE 802.11ac MCS0/Nss1 (VHT80): 73.23 MHz</p> <p>IEEE 802.11ac MCS0/Nss2 (VHT80+80): 75.83 MHz</p> <p><b>&lt;For Beamforming Mode&gt;</b></p> <p>Band 1:</p> <p>IEEE 802.11ac MCS0/Nss1 (VHT20): 17.71 MHz</p> <p>IEEE 802.11ac MCS0/Nss1 (VHT40): 37.34 MHz</p> <p>IEEE 802.11ac MCS0/Nss1 (VHT80): 76.12 MHz</p> <p>IEEE 802.11ac MCS0/Nss2 (VHT80+80): 75.83 MHz</p> <p>Band 4:</p> <p>IEEE 802.11ac MCS0/Nss1 (VHT20): 17.80 MHz</p> <p>IEEE 802.11ac MCS0/Nss1 (VHT40): 37.48 MHz</p>

	IEEE 802.11ac MCS0/Nss1 (VHT80): 76.12 MHz IEEE 802.11ac MCS0/Nss2 (VHT80+80): 76.12 MHz
Maximum Conducted Output Power	<p><b>&lt;For Non-Beamforming Mode&gt;</b></p> <p>Band 1:</p> IEEE 802.11a: 24.61 dBm IEEE 802.11ac MCS0/Nss1 (VHT20): 24.34 dBm IEEE 802.11ac MCS0/Nss1 (VHT40): 27.66 dBm IEEE 802.11ac MCS0/Nss1 (VHT80): 21.32 dBm IEEE 802.11ac MCS0/Nss2 (VHT80+80): 22.36 dBm
	<p>Band 4:</p> IEEE 802.11a: 29.36 dBm IEEE 802.11ac MCS0/Nss1 (VHT20): 29.17 dBm IEEE 802.11ac MCS0/Nss1 (VHT40): 29.29 dBm IEEE 802.11ac MCS0/Nss1 (VHT80): 21.84 dBm IEEE 802.11ac MCS0/Nss2 (VHT80+80): 22.27 dBm
	<p><b>&lt;For Beamforming Mode&gt;</b></p> <p>Band 1:</p> IEEE 802.11ac MCS0/Nss1 (VHT20): 24.18 dBm IEEE 802.11ac MCS0/Nss1 (VHT40): 24.28 dBm IEEE 802.11ac MCS0/Nss1 (VHT80): 22.98 dBm IEEE 802.11ac MCS0/Nss2 (VHT80+80): 19.35 dBm
	<p>Band 4:</p> IEEE 802.11ac MCS0/Nss1 (VHT20): 24.30 dBm IEEE 802.11ac MCS0/Nss1 (VHT40): 24.29 dBm IEEE 802.11ac MCS0/Nss1 (VHT80): 24.18 dBm IEEE 802.11ac MCS0/Nss2 (VHT80+80): 19.63 dBm
Carrier Frequencies	Please refer to section 3.4
Antenna	Please refer to section 3.3

Items	Description	
Communication Mode	<input checked="" type="checkbox"/> IP Based (Load Based)	<input type="checkbox"/> Frame Based
Beamforming Function	<input checked="" type="checkbox"/> With beamforming	<input type="checkbox"/> Without beamforming

Note: The product has beamforming function for 802.11n/ac in 2.4GHz and 5GHz.

**Antenna and Band width**

Antenna	Four (TX)		
	20 MHz	40 MHz	80 MHz
Band width Mode			
IEEE 802.11a	V	X	X
IEEE 802.11n	V	V	X
IEEE 802.11ac	V	V	V

**IEEE 11n/ac Spec.**

Protocol	Number of Transmit Chains (NTX)	Data Rate / MCS
802.11n (HT20)	4	MCS 0-31
802.11n (HT40)	4	MCS 0-31
802.11ac (VHT20)	4	MCS 0-9/Nss1-4
802.11ac (VHT40)	4	MCS 0-9/Nss1-4
802.11ac (VHT80)	4	MCS 0-9/Nss1-4

Note 1: IEEE Std. 802.11n modulation consists of HT20 and HT40 (HT: High Throughput).  
Then EUT supports HT20 and HT40.

Note 2: IEEE Std. 802.11ac modulation consists of VHT20, VHT40, VHT80 and VHT160 (VHT: Very High Throughput). Then EUT supports VHT20, VHT40 and VHT80.

Note 3: Modulation modes consist of below configuration:  
HT20/HT40: IEEE 802.11n, VHT20/VHT40/VHT80: IEEE 802.11ac

**3.2. Accessories**

Power	Brand	Model	Rating
Adapter (Switchable Adapter)	APD	WA-24Q12R	Input: 100-240V~, 50-60Hz, 0.7A Max Output: 12V, 2A
Others			
US Plug*1 RJ-45 cable, Non-shielded, 1m			



### 3.3. Table for Filed Antenna

Ant.	Brand	P/N	Antenna Type	Connector	Gain (dBi)	
					2.4GHz	5GHz
1	WNC	95XKAA15.GAB	PIFA Antenna	I-PEX	4.66	-
2	WNC	95XKAA15.GAC	PIFA Antenna	I-PEX	4.62	-
3	WNC	95XKAA15.GAD	PIFA Antenna	I-PEX	4.68	-
4	WNC	95XKAA15.GA1	PIFA Antenna	I-PEX	4.85	-
5	WNC	95XKAA15.GAE	PIFA Antenna	I-PEX	-	5.68
6	WNC	95XKAA15.GAF	PIFA Antenna	I-PEX	-	5.77
7	WNC	95XKAA15.GAG	PIFA Antenna	I-PEX	-	5.63
8	WNC	95XKAA15.GA2	PIFA Antenna	I-PEX	-	5.51

Note: The EUT has eight antennas.

**For 2.4GHz WLAN function:**

**For IEEE 802.11b/g/n/ac mode (4TX/4RX)**

Chain 1, Chain 2, Chain 3 and Chain 4 can be used as transmitting/receiving antenna.

Chain 1, Chain 2, Chain 3 and Chain 4 could transmit/receive simultaneously.

**For 5GHz WLAN function:**

**For IEEE 802.11a/n/ac mode (4TX/4RX)**

Chain 5, Chain 6, Chain 7 and Chain 8 can be used as transmitting/receiving antenna.

Chain 5, Chain 6, Chain 7 and Chain 8 could transmit/receive simultaneously.

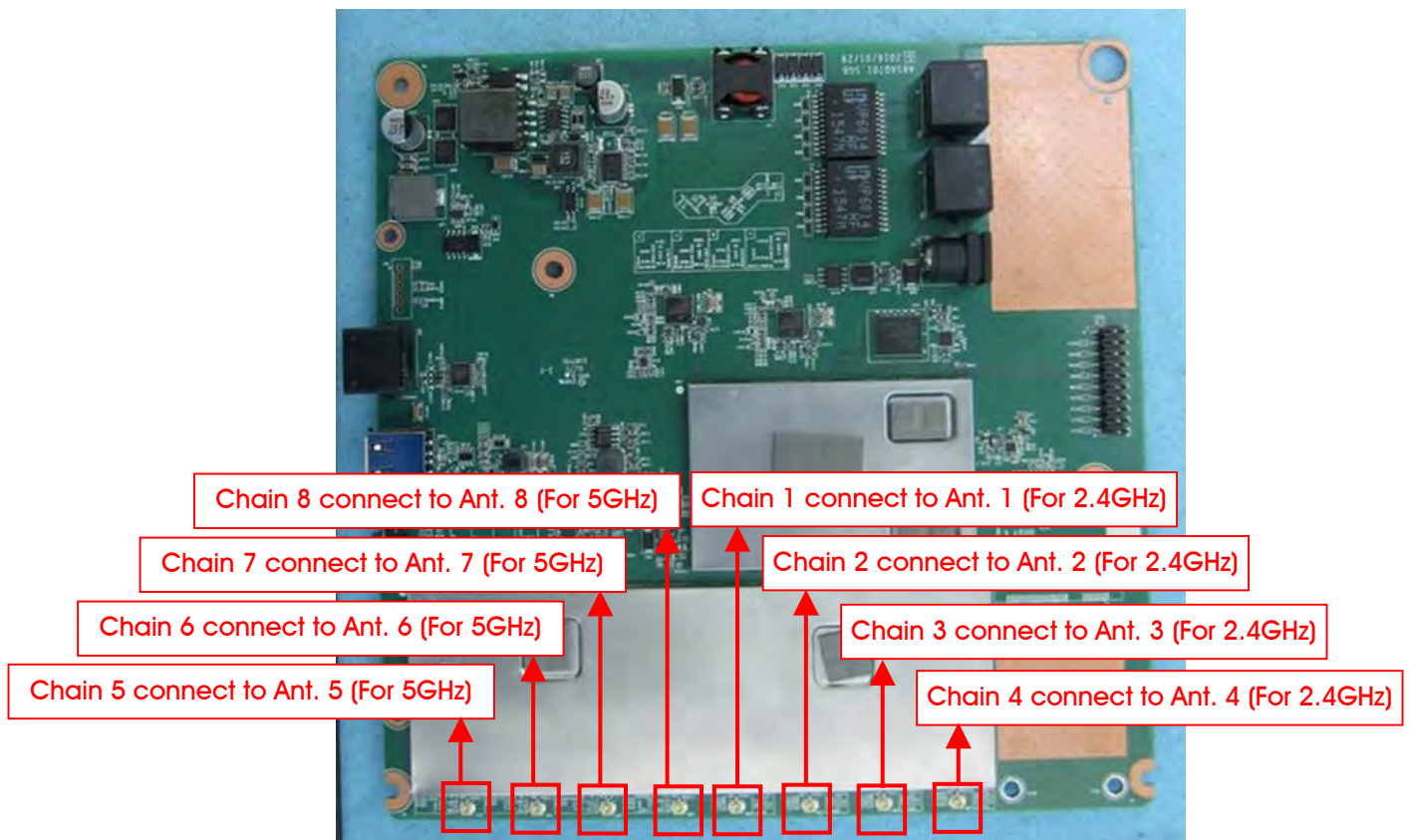

### 3.4. Table for Carrier Frequencies

There are three bandwidth systems.

For 20MHz bandwidth systems, use Channel 36, 40, 44, 48, 149, 153, 157, 161, 165.

For 40MHz bandwidth systems, use Channel 38, 46, 151, 159.

For 80MHz bandwidth systems, use Channel 42, 155.

Frequency Band	Channel No.	Frequency	Channel No.	Frequency
5150~5250 MHz Band 1	36	5180 MHz	44	5220 MHz
	38	5190 MHz	46	5230 MHz
	40	5200 MHz	48	5240 MHz
	42	5210 MHz	-	-
5725~5850 MHz Band 4	149	5745 MHz	157	5785 MHz
	151	5755 MHz	159	5795 MHz
	153	5765 MHz	161	5805 MHz
	155	5775 MHz	165	5825 MHz

### 3.5. Table for 80+80 MHz Mode

Type	Channel No.	Frequency
1	42+155	5210+5775 MHz

### 3.6. Table for Test Modes

Preliminary tests were performed in different data rate to find the worst radiated emission. The data rate shown in the table below is the worst-case rate with respect to the specific test item. Investigation has been done on all the possible configurations for searching the worst cases. The following table is a list of the test modes shown in this test report.

Test Items	Mode		Data Rate	Channel	Chain
AC Power Conducted Emission	Normal Link		-	-	-
Max. Conducted Output Power	<b>&lt;For Non-Beamforming Mode&gt;</b>				
	11a/BPSK	Band 1&4	6Mbps	36/40/48/149/157/165	5+6+7+8
	11ac VHT20	Band 1&4	MCS0/Nss1	36/40/48/149/157/165	5+6+7+8
	11ac VHT40	Band 1&4	MCS0/Nss1	38/46/151/159	5+6+7+8
	11ac VHT80	Band 1&4	MCS0/Nss1	42/155	5+6+7+8
	<b>&lt;For Beamforming Mode&gt;</b>				
	11ac VHT20	Band 1&4	MCS0/Nss1	36/40/48/149/157/165	5+6+7+8
	11ac VHT40	Band 1&4	MCS0/Nss1	38/46/151/159	5+6+7+8
	11ac VHT80	Band 1&4	MCS0/Nss1	42/155	5+6+7+8
	Power Spectral Density	<b>&lt;For Non-Beamforming Mode&gt;</b>			
11a/BPSK		Band 1&4	6Mbps	36/40/48/149/157/165	5+6+7+8
11ac VHT20		Band 1&4	MCS0/Nss1	36/40/48/149/157/165	5+6+7+8
11ac VHT40		Band 1&4	MCS0/Nss1	38/46/151/159	5+6+7+8
11ac VHT80		Band 1&4	MCS0/Nss1	42/155	5+6+7+8
<b>&lt;For Beamforming Mode&gt;</b>					
11ac VHT20		Band 1&4	MCS0/Nss1	36/40/48/149/157/165	5+6+7+8
11ac VHT40		Band 1&4	MCS0/Nss1	38/46/151/159	5+6+7+8
11ac VHT80		Band 1&4	MCS0/Nss1	42/155	5+6+7+8

26dB Spectrum Bandwidth & 99% Occupied Bandwidth Measurement	<b>&lt;For Non-Beamforming Mode&gt;</b>				
	11a/BPSK	Band 1&4	6Mbps	36/40/48/149/157/165	5+6+7+8
	11ac VHT20	Band 1&4	MCS0/Nss1	36/40/48/149/157/165	5+6+7+8
	11ac VHT40	Band 1&4	MCS0/Nss1	38/46/151/159	5+6+7+8
	11ac VHT80	Band 1&4	MCS0/Nss1	42/155	5+6+7+8
	<b>&lt;For Beamforming Mode&gt;</b>				
	11ac VHT20	Band 1&4	MCS0/Nss1	36/40/48/149/157/165	5+6+7+8
	11ac VHT40	Band 1&4	MCS0/Nss1	38/46/151/159	5+6+7+8
	11ac VHT80	Band 1&4	MCS0/Nss1	42/155	5+6+7+8
	6dB Spectrum Bandwidth Measurement	<b>&lt;For Non-Beamforming Mode&gt;</b>			
11a/BPSK		Band 4	6Mbps	149/157/165	5+6+7+8
11ac VHT20		Band 4	MCS0/Nss1	149/157/165	5+6+7+8
11ac VHT40		Band 4	MCS0/Nss1	151/159	5+6+7+8
11ac VHT80		Band 4	MCS0/Nss1	155	5+6+7+8
<b>&lt;For Beamforming Mode&gt;</b>					
11ac VHT20		Band 4	MCS0/Nss1	36/40/48/149/157/165	5+6+7+8
11ac VHT40		Band 4	MCS0/Nss1	38/46/151/159	5+6+7+8
11ac VHT80		Band 4	MCS0/Nss1	42/155	5+6+7+8
Radiated Emission Below 1GHz		Normal Link		-	-
Radiated Emission Above 1GHz	<b>&lt;For Non-Beamforming Mode&gt;</b>				
	11a/BPSK	Band 1&4	6Mbps	36/40/48/149/157/165	5+6+7+8
	11ac VHT20	Band 1&4	MCS0/Nss1	36/40/48/149/157/165/	5+6+7+8
	11ac VHT40	Band 1&4	MCS0/Nss1	38/46/151/159	5+6+7+8
	11ac VHT80	Band 1&4	MCS0/Nss1	42/155	5+6+7+8
	<b>&lt;For Beamforming Mode&gt;</b>				
	11ac VHT20	Band 1&4	MCS0/Nss1	36/40/48/149/157/165	5+6+7+8
	11ac VHT40	Band 1&4	MCS0/Nss1	38/46/151/159	5+6+7+8
	11ac VHT80	Band 1&4	MCS0/Nss1	42/155	5+6+7+8

Band Edge Emission	<b>&lt;For Non-Beamforming Mode&gt;</b>				
	11a/BPSK	Band 1&4	6Mbps	36/40/48/149/157/165	5+6+7+8
	11ac VHT20	Band 1&4	MCS0/Nss1	36/40/48/149/157/165	5+6+7+8
	11ac VHT40	Band 1&4	MCS0/Nss1	38/46/151/159	5+6+7+8
	11ac VHT80	Band 1&4	MCS0/Nss1	42/155	5+6+7+8
	<b>&lt;For Beamforming Mode&gt;</b>				
	11ac VHT20	Band 1&4	MCS0/Nss1	36/40/48/149/157/165	5+6+7+8
	11ac VHT40	Band 1&4	MCS0/Nss1	38/46/151/159	5+6+7+8
Frequency Stability	20 MHz	Band 1&4	-	40/157	5
	40 MHz	Band 1&4	-	38/151	5
	80 MHz	Band 1&4	-	42/155	5

**802.11ac MCS0/Nss2 VHT80+80**

Test Items	Mode		Data Rate	Type	Channel	Chain
Max. Conducted Output Power Power Spectral Density 26dB Spectrum Bandwidth & 99% Occupied Bandwidth Measurement Radiated Emission Above 1GHz Band Edge Emission	11ac VHT80+80	Band 1&4	MCS0/Nss2	1	42	6+7
					155	5+8
6dB Spectrum Bandwidth Measurement	11ac VHT80+80	Band 4	MCS0/Nss2	1	42	-
					155	5+8

Note 1: VHT20/VHT40 covers HT20/HT40, due to same modulation. The power setting for 802.11n HT20 and HT40 are the same or lower than 802.11ac VHT20 and VHT40.

Note 2: There are two modes of EUT, one is beamforming mode, and the other is non-beamforming mode for 802.11n/ac. All test results were recorded in the report.

Note 3: The PoE information as below, The PoE is for measurement only and it would not be marketed.

Support Unit	Brand	Model	FCC ID
PoE	PHIHONG	POE31U-1AT(SC)	DoC

The following test modes were performed for all tests:

**For Conducted Emission test:**

Mode 1. Normal Link with Adapter

**For Radiated Emission test (Below 1GHz):**

Mode 1. Normal Link with Adapter in Y-axis

Mode 2. Normal Link with Adapter in Z-axis

Mode 2 has been evaluated to be the worst case among Mode 1~2, thus measurement for Mode 3 will follow this same test mode.

Mode 3. Normal Link with PoE in Z-axis

Mode 2 is the worst case, so it was selected to record in this test report.

**For Radiated Emission test (Above 1GHz):**

The EUT was performed at Y axis and Z axis position for Radiated emission above 1GHz test, and the worst case was found at Z axis. So the measurement will follow this same test configuration.

Mode 1. CTX - Z axis

**For Co-location MPE and Radiated Emission Co-location Test:**

Mode 1. 2.4G+5G in Y-axis

Mode 2. 2.4G+5G in Z-axis

Mode 2 is the worst case, so it was selected to record in this test report.

The EUT could be applied with 2.4GHz WLAN function and 5GHz WLAN function; therefore Co-location Maximum Permissible Exposure (Please refer to FA641226) and Radiated Emission Co-location (please refer to Appendix B) tests are added for simultaneously transmit between 2.4GHz WLAN function and 5GHz WLAN function.

### 3.7. Table for Testing Locations

Test Site Location					
Address:	No.8, Lane 724, Bo-ai St., Jhubei City, Hsinchu County 302, Taiwan, R.O.C.				
TEL:	886-3-656-9065				
FAX:	886-3-656-9085				
Test Site No.	Site Category	Location	FCC Designation No.	IC File No.	VCCI Reg. No
03CH01-CB	SAC	Hsin Chu	TW0006	IC 4086D	-
CO01-CB	Conduction	Hsin Chu	TW0006	IC 4086D	-
TH01-CB	OVEN Room	Hsin Chu	-	-	-

Open Area Test Site (OATS); Semi Anechoic Chamber (SAC).

### 3.8. Table for Supporting Units

For Test Site No: CO01-CB

Support Unit	Brand	Model	FCC ID
NB*4	DELL	E6430	DoC
Flash disk3.0	Transcend	JetFlash-700	DoC

For Test Site No: 03CH01-CB (Below 1GHz)

Support Unit	Brand	Model	FCC ID
NB*4	DELL	E4300	DoC
Flash disk	Silicon Power	I-Series	DoC

For Test Site No: 03CH01-CB (Above 1GHz)

<For Non-Beamforming Mode>

Support Unit	Brand	Model	FCC ID
NB	DELL	E4300	DoC

<For Beamforming Mode>

Support Unit	Brand	Model	FCC ID
NB*2	DELL	E4300	DoC
RX Device	MOJO	C-120	TOR-C120

For Test Site No: TH01-CB

Support Unit	Brand	Model	FCC ID
NB	DELL	E4300	DoC

### 3.9. Table for Parameters of Test Software Setting

During testing, Channel and Power Controlling Software provided by the customer was used to control the operating channel as well as the output power level. The RF output power selection is for the setting of RF output power expected by the customer and is going to be fixed on the firmware of the final end product.

<For Non-Beamforming Mode>

Test Software Version	QCARCT Ver3.0.144.0					
Mode	Test Frequency (MHz)					
	NCB: 20MHz					
	5180 MHz	5200 MHz	5240 MHz	5745 MHz	5785 MHz	5825 MHz
802.11a	17	17	17	21	21	21
802.11ac MCS0/Nss1 VHT20	17	17	17	21	21	21
Mode	NCB: 40MHz					
	5190 MHz	5230 MHz		5755 MHz	5795 MHz	
802.11ac MCS0/Nss1 VHT40	17	20		21	21	
Mode	NCB: 80MHz					
	5210 MHz			5775 MHz		
802.11ac MCS0/Nss1 VHT80	14			17		
Mode	NCB: 80MHz+80MHz					
	Type 1					
	5210+5775 MHz					
802.11ac MCS0/Nss2 VHT80+80	17.5					

<For Beamforming Mode>

Test Software Version	QCARCT Ver3.0.144.0					
Mode	Test Frequency (MHz)					
	NCB: 20MHz					
	5180 MHz	5200 MHz	5240 MHz	5745 MHz	5785 MHz	5825 MHz
802.11ac MCS0/Nss1 VHT20	23	23	23.5	22	22.5	23
Mode	NCB: 40MHz					
	5190 MHz	5230 MHz		5755 MHz	5795 MHz	
802.11ac MCS0/Nss1 VHT40	23.5	23.5		22.5	22.5	
Mode	NCB: 80MHz					
	5210 MHz			5775 MHz		
802.11ac MCS0/Nss1 VHT80	22.5			22.5		
Mode	NCB: 80MHz+80MHz					
	Type 1					
	5210+5775 MHz					
802.11ac MCS0/Nss2 VHT80+80	21					



### 3.10. EUT Operation during Test

#### <For Non-Beamforming Mode>

The EUT was programmed to be in continuously transmitting mode.

#### <For Beamforming Mode>

For Conducted Mode:

The EUT was programmed to be in continuously transmitting mode.

For Radiated Mode:

During the test, the following programs under WIN 7 were executed.

The program was executed as follows:

1. During the test, the EUT operation to normal function.
2. Executed command fixed test channel under Telnet.
3. Executed "Lantest.exe " to link with the remote workstation to receive and transmit packet by RX Device and transmit duty cycle no less 98%

### 3.11. Duty Cycle

#### <For Non-Beamforming Mode>

Mode	On Time (ms)	On+Off Time (ms)	Duty Cycle (%)	Duty Factor (dB)	1/T Min. VBW (kHz)
802.11a	2.060	2.120	97.17%	0.12	0.49
802.11ac MCS0/Nss1 VHT20	5.040	5.080	99.21%	0.03	0.01
802.11ac MCS0/Nss1 VHT40	2.420	2.480	97.58%	0.11	0.41
802.11ac MCS0/Nss1 VHT80	1.140	1.220	93.44%	0.29	0.88
802.11ac MCS0/Nss2 VHT80+80	2.203	2.297	95.90%	0.18	0.45

#### <For Beamforming Mode>

Mode	On Time (ms)	On+Off Time (ms)	Duty Cycle (%)	Duty Factor (dB)	1/T Min. VBW (kHz)
802.11ac MCS0/Nss1 VHT20	1.720	1.890	91.01%	0.41	0.58
802.11ac MCS0/Nss1 VHT40	1.646	1.789	92.01%	0.36	0.61
802.11ac MCS0/Nss1 VHT80	1.537	1.705	90.15%	0.45	0.65
802.11ac MCS0/Nss2 VHT80+80	1.744	1.944	89.71%	0.47	0.57

### 3.12. Test Configurations

#### 3.12.1. AC Power Line Conduction Emissions Test Configuration

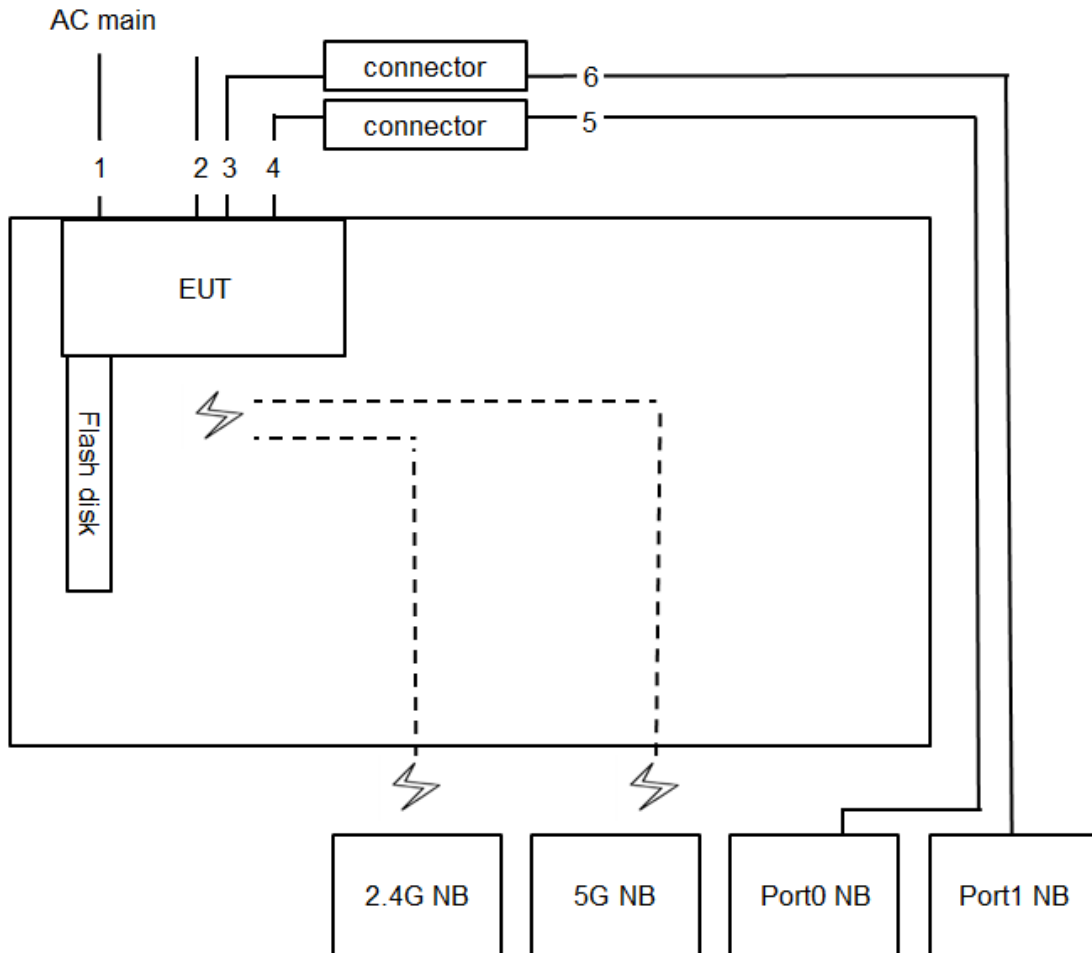

Item	Connection	Shielded	Length
1	Power cable	No	1.5m
2	Console cable	Yes	1.5m
3	RJ-45 cable	No	1m
4	RJ-45 cable	No	1m
5	RJ-45 cable	No	10m
6	RJ-45 cable	No	10m

### 3.12.2. Radiation Emissions Test Configuration

Test Configuration: 30MHz ~1GHz

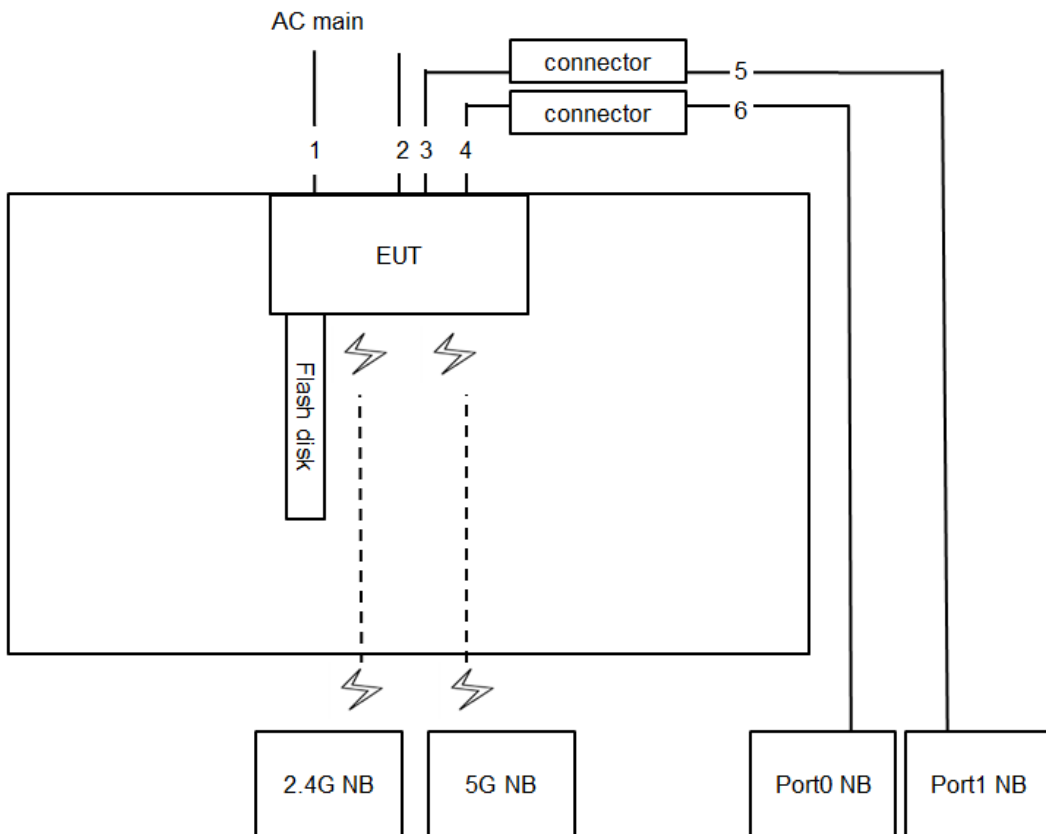

Item	Connection	Shielded	Length
1	Power cable	No	1.5m
2	Console cable	Yes	1.5m
3	RJ-45 cable	No	1m
4	RJ-45 cable	No	1m
5	RJ-45 cable	No	10m
6	RJ-45 cable	No	10m

Test Configuration: above 1GHz  
 <For Non-Beamforming Mode>

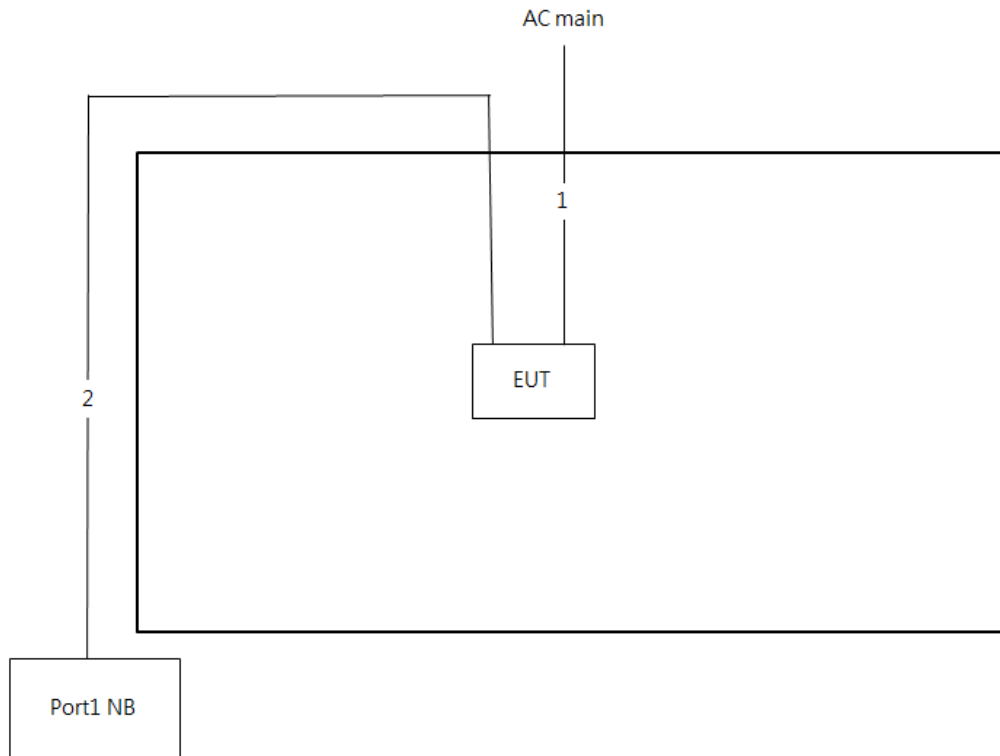

Item	Connection	Shielded	Length
1	Power cable	No	1.5m
2	RJ-45 cable	No	10m

<For Beamforming Mode>

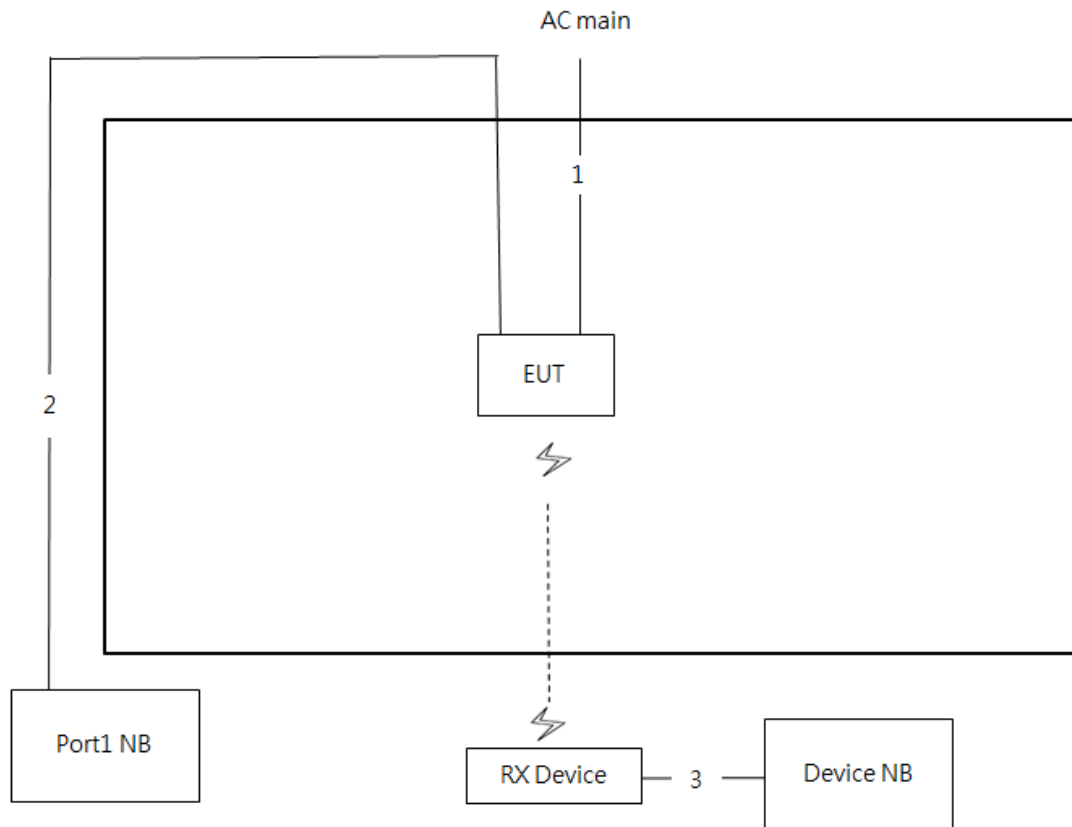

Item	Connection	Shielded	Length
1	Power cable	No	1.5m
2	RJ-45 cable	No	10m
3	RJ-45 cable	No	1.5m

## 4. TEST RESULT

### 4.1. AC Power Line Conducted Emissions Measurement

#### 4.1.1. Limit

For this product that is designed to connect to the AC power line, the radio frequency voltage that is conducted back onto the AC power line on any frequency or frequencies within the band 150 kHz to 30 MHz shall not exceed below limits table.

Frequency (MHz)	QP Limit (dBuV)	AV Limit (dBuV)
0.15~0.5	66~56	56~46
0.5~5	56	46
5~30	60	50

#### 4.1.2. Measuring Instruments and Setting

Please refer to section 5 of equipments list in this report. The following table is the setting of the receiver.

Receiver Parameters	Setting
Attenuation	10 dB
Start Frequency	0.15 MHz
Stop Frequency	30 MHz
IF Bandwidth	9 kHz

#### 4.1.3. Test Procedures

1. Configure the EUT according to ANSI C63.10. The EUT or host of EUT has to be placed 0.4 meter far from the conducting wall of the shielding room and at least 80 centimeters from any other grounded conducting surface.
2. Connect EUT or host of EUT to the power mains through a line impedance stabilization network (LISN).
3. All the support units are connected to the other LISNs. The LISN should provide 50uH/50ohms coupling impedance.
4. The frequency range from 150 kHz to 30 MHz was searched.
5. Set the test-receiver system to Peak Detect Function and Specified Bandwidth with Maximum Hold Mode.
6. The measurement has to be done between each power line and ground at the power terminal.

#### 4.1.4. Test Setup Layout

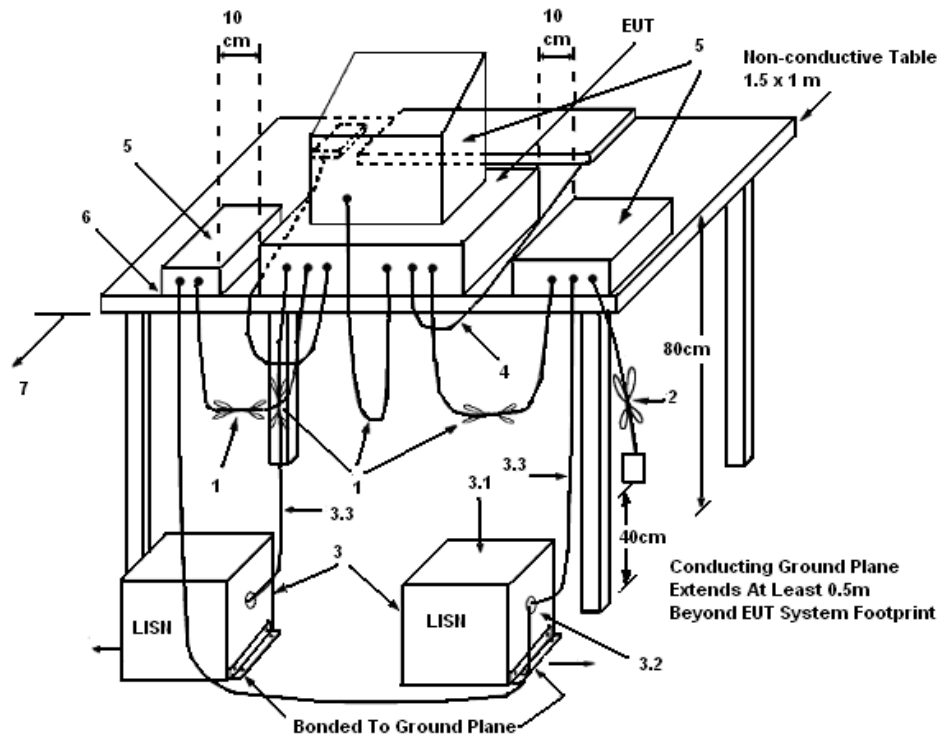

#### LEGEND:

- (1) Interconnecting cables that hang closer than 40 cm to the ground plane shall be folded back and forth in the center forming a bundle 30 to 40 cm long.
- (2) I/O cables that are not connected to a peripheral shall be bundled in the center. The end of the cable may be terminated, if required, using the correct terminating impedance. The overall length shall not exceed 1 m.
- (3) EUT connected to one LISN. Unused LISN measuring port connectors shall be terminated in 50  $\Omega$ . LISN can be placed on top of, or immediately beneath, reference ground plane.
  - (3.1) All other equipment powered from additional LISN(s).
  - (3.2) Multiple outlet strip can be used for multiple power cords of non-EUT equipment.
  - (3.3) LISN at least 80 cm from nearest part of EUT chassis.
- (4) Cables of hand-operated devices, such as keyboards, mice, etc., shall be placed as for normal use.
- (5) Non-EUT components of EUT system being tested.
- (6) Rear of EUT, including peripherals, shall all be aligned and flush with rear of tabletop.
- (7) Rear of tabletop shall be 40 cm removed from a vertical conducting plane that is bonded to the ground plane.

#### 4.1.5. Test Deviation

There is no deviation with the original standard.

#### 4.1.6. EUT Operation during Test

The EUT was placed on the test table and programmed in normal function.

4.1.7. Results of AC Power Line Conducted Emissions Measurement

Temperature	23°C	Humidity	63%
Test Engineer	Hank Yang	Phase	Line
Configuration	Normal Link		

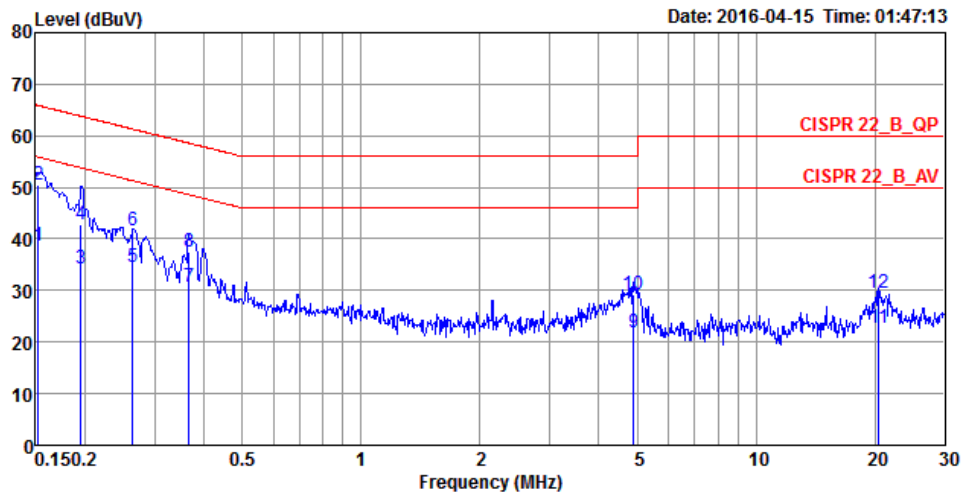

	Freq	Level	Over Limit	Limit Line	Read Level	LISN Factor	Cable Loss	Pol/Phase	Remark
	MHz	dBuV	dB	dBuV	dBuV	dB	dB		
1	0.1524	38.63	-17.24	55.87	28.68	9.93	0.02	LINE	Average
2	0.1524	50.44	-15.43	65.87	40.49	9.93	0.02	LINE	QP
3	0.1955	34.21	-19.59	53.80	24.26	9.93	0.02	LINE	Average
4	0.1955	42.91	-20.89	63.80	32.96	9.93	0.02	LINE	QP
5	0.2644	34.39	-16.90	51.29	24.43	9.93	0.03	LINE	Average
6	0.2644	41.50	-19.79	61.29	31.54	9.93	0.03	LINE	QP
7	0.3673	30.62	-17.94	48.56	20.65	9.93	0.04	LINE	Average
8	0.3673	37.52	-21.04	58.56	27.55	9.93	0.04	LINE	QP
9	4.8997	21.81	-24.19	46.00	11.66	10.06	0.09	LINE	Average
10	4.8997	29.14	-26.86	56.00	18.99	10.06	0.09	LINE	QP
11	20.4855	22.79	-27.21	50.00	12.08	10.45	0.26	LINE	Average
12	20.4855	29.48	-30.52	60.00	18.77	10.45	0.26	LINE	QP



Temperature	23°C	Humidity	63%
Test Engineer	Hank Yang	Phase	Neutral
Configuration	Normal Link		

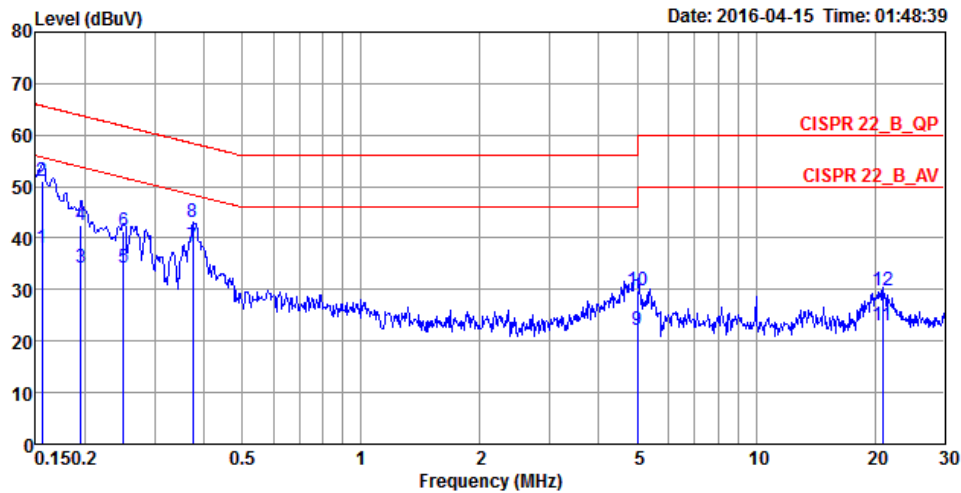

	Freq	Level	Over Limit	Limit Line	Read Level	LISN Factor	Cable Loss	Pol/Phase	Remark
	MHz	dBuV	dB	dBuV	dBuV	dB	dB		
1	0.1557	38.05	-17.64	55.69	28.25	9.78	0.02	NEUTRAL	Average
2	0.1557	51.05	-14.64	65.69	41.25	9.78	0.02	NEUTRAL	QP
3	0.1955	34.38	-19.42	53.80	24.57	9.79	0.02	NEUTRAL	Average
4	0.1955	42.61	-21.19	63.80	32.80	9.79	0.02	NEUTRAL	QP
5	0.2508	34.21	-17.52	51.73	24.39	9.79	0.03	NEUTRAL	Average
6	0.2508	41.39	-20.34	61.73	31.57	9.79	0.03	NEUTRAL	QP
7	0.3751	38.39	-10.00	48.39	28.56	9.79	0.04	NEUTRAL	Average
8	0.3751	43.09	-15.30	58.39	33.26	9.79	0.04	NEUTRAL	QP
9	5.0046	22.03	-27.97	50.00	12.04	9.90	0.09	NEUTRAL	Average
10	5.0046	29.81	-30.19	60.00	19.82	9.90	0.09	NEUTRAL	QP
11	20.9243	23.17	-26.83	50.00	12.71	10.20	0.26	NEUTRAL	Average
12	20.9243	29.79	-30.21	60.00	19.33	10.20	0.26	NEUTRAL	QP

Note:

Level = Read Level + LISN Factor + Cable Loss.

## 4.2. 26dB Bandwidth and 99% Occupied Bandwidth Measurement

### 4.2.1. Limit

No restriction limits.

### 4.2.2. Measuring Instruments and Setting

Please refer to section 5 of equipments list in this report. The following table is the setting of the spectrum analyzer.

26dB Bandwidth	
Spectrum Parameters	Setting
Attenuation	Auto
Span Frequency	> 26dB Bandwidth
RBW	Approximately 1% of the emission bandwidth
VBW	VBW > RBW
Detector	Peak
Trace	Max Hold
Sweep Time	Auto
99% Occupied Bandwidth	
Spectrum Parameters	Setting
Span	1.5 times to 5.0 times the OBW
RBW	1 % to 5 % of the OBW
VBW	$\geq 3 \times \text{RBW}$
Detector	Peak
Trace	Max Hold

### 4.2.3. Test Procedures

For Radiated 26dB Bandwidth and 99% Occupied Bandwidth Measurement:

1. The transmitter was radiated to the spectrum analyzer in peak hold mode.
2. Measure the maximum width of the emission that is 26 dB down from the peak of the emission. Compare this with the RBW setting of the analyzer. Readjust RBW and repeat measurement as needed until the RBW/EBW ratio is approximately 1%.

### 4.2.4. Test Setup Layout

For Radiated 26dB Bandwidth and 99% Occupied Bandwidth Measurement:

This test setup layout is the same as that shown in section 4.6.4.

### 4.2.5. Test Deviation

There is no deviation with the original standard.

### 4.2.6. EUT Operation during Test

The EUT was programmed to be in continuously transmitting mode.

**4.2.7. Test Result of 26dB Bandwidth and 99% Occupied Bandwidth**

<b>Temperature</b>	24°C	<b>Humidity</b>	60%
<b>Test Engineer</b>	Clemens Fang		

<For Non-Beamforming Mode>

Mode	Frequency	26dB Bandwidth (MHz)	99% Occupied Bandwidth (MHz)
802.11a	5180 MHz	18.70	16.58
	5200 MHz	18.78	16.58
	5240 MHz	18.96	16.67
	5745 MHz	22.78	16.85
	5785 MHz	26.78	16.93
	5825 MHz	23.30	16.85
802.11ac MCS0/Nss1 VHT20	5180 MHz	19.83	17.45
	5200 MHz	19.83	17.63
	5240 MHz	19.83	17.54
	5745 MHz	20.00	17.71
	5785 MHz	23.91	17.80
	5825 MHz	19.57	17.80
802.11ac MCS0/Nss1 VHT40	5190 MHz	38.55	34.15
	5230 MHz	38.41	34.01
	5755 MHz	54.06	34.73
	5795 MHz	54.64	34.59
802.11ac MCS0/Nss1 VHT80	5210 MHz	78.55	73.52
	5775 MHz	78.26	73.23

**802.11ac MCS0/Nss2 VHT80+80**

Type	Frequency	26dB BW (MHz)	99% OBW (MHz)	26dB Total BW (MHz)
1	5210 MHz	79.42	75.25	158.84
	5775 MHz	79.42	75.83	

**<For Beamforming Mode>**

Mode	Frequency	26dB Bandwidth (MHz)	99% Occupied Bandwidth (MHz)
802.11ac MCS0/Nss1 VHT20	5180 MHz	21.74	17.71
	5200 MHz	22.09	17.71
	5240 MHz	22.00	17.71
	5745 MHz	22.26	17.71
	5785 MHz	22.44	17.80
	5825 MHz	22.00	17.71
802.11ac MCS0/Nss1 VHT40	5190 MHz	60.15	37.34
	5230 MHz	50.44	37.34
	5755 MHz	60.58	37.34
	5795 MHz	67.83	37.48
802.11ac MCS0/Nss1 VHT80	5210 MHz	84.93	76.12
	5775 MHz	85.22	76.12

**802.11ac MCS0/Nss2 VHT80+80**

Type	Frequency	26dB BW (MHz)	99% OBW (MHz)	26dB Total BW (MHz)
1	5210 MHz	80.00	75.83	160.29
	5775 MHz	80.29	76.12	

<For Non-Beamforming Mode>

26dB Bandwidth and 99% Occupied Bandwidth Plot on Configuration IEEE 802.11a / Chain 5 + Chain 6+ Chain 7 + Chain 8 / 5180 MHz

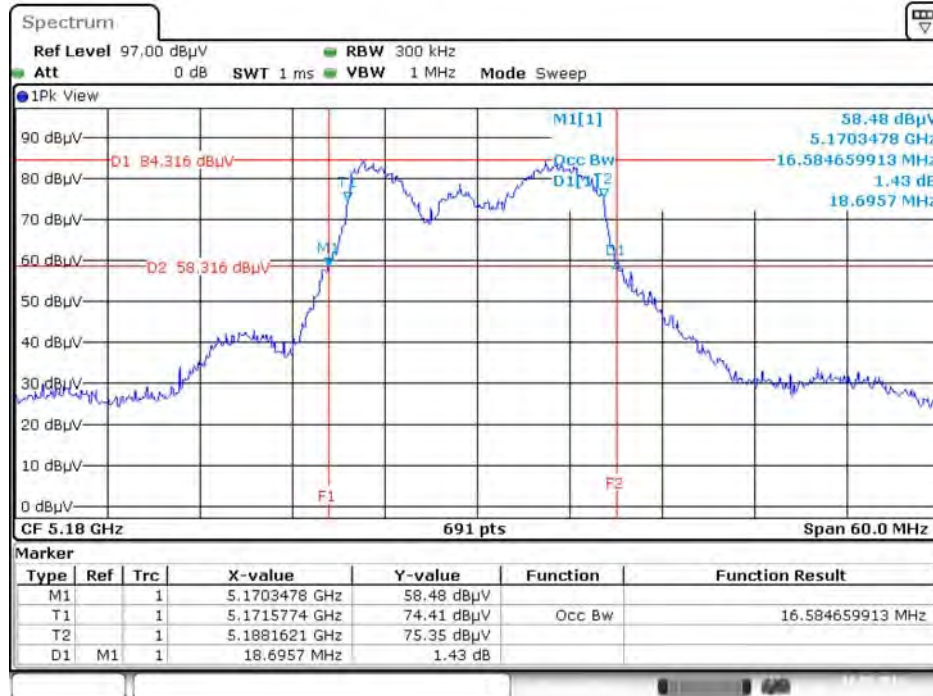

Date: 18.MAY.2016 17:04:20

26dB Bandwidth and 99% Occupied Bandwidth Plot on Configuration IEEE 802.11a / ChainChain 5 + Chain 6+ Chain 7 + Chain 8 / 5200 MHz

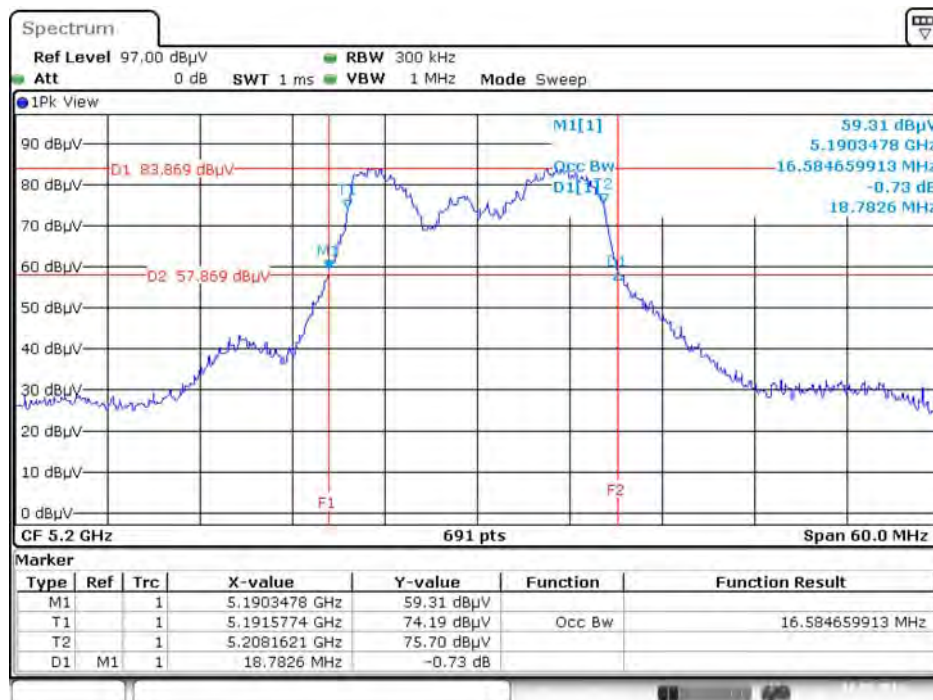

Date: 18.MAY.2016 17:04:52

**26dB Bandwidth and 99% Occupied Bandwidth Plot on Configuration IEEE 802.11a / Chain 5 + Chain 6+ Chain 7 + Chain 8 / 5240 MHz**

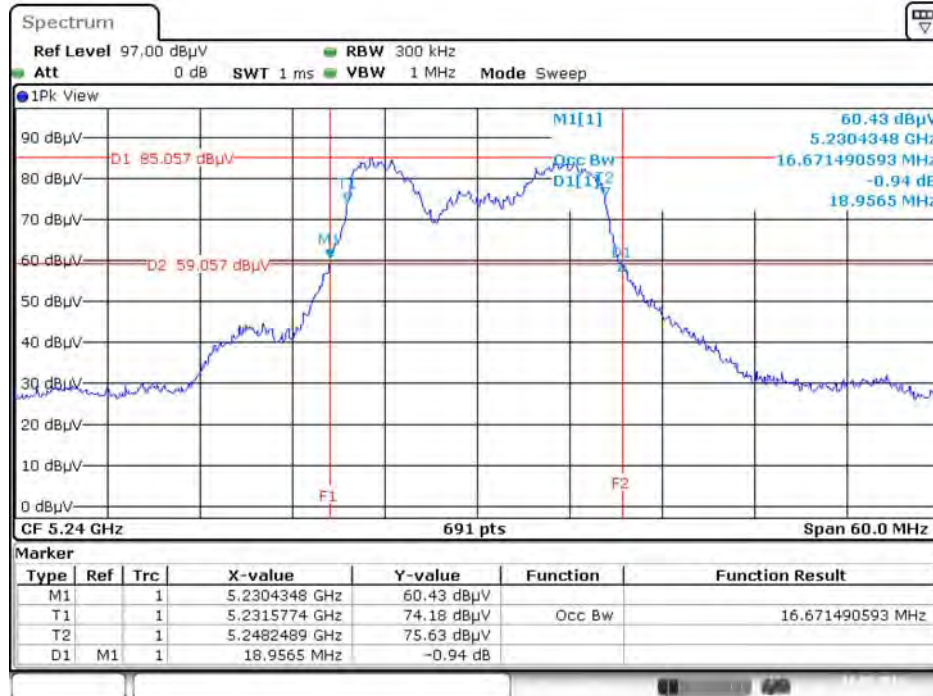

Date: 18.MAY.2016 17:05:19

**26dB Bandwidth and 99% Occupied Bandwidth Plot on Configuration IEEE 802.11a / Chain 5 + Chain 6+ Chain 7 + Chain 8 / 5745 MHz**

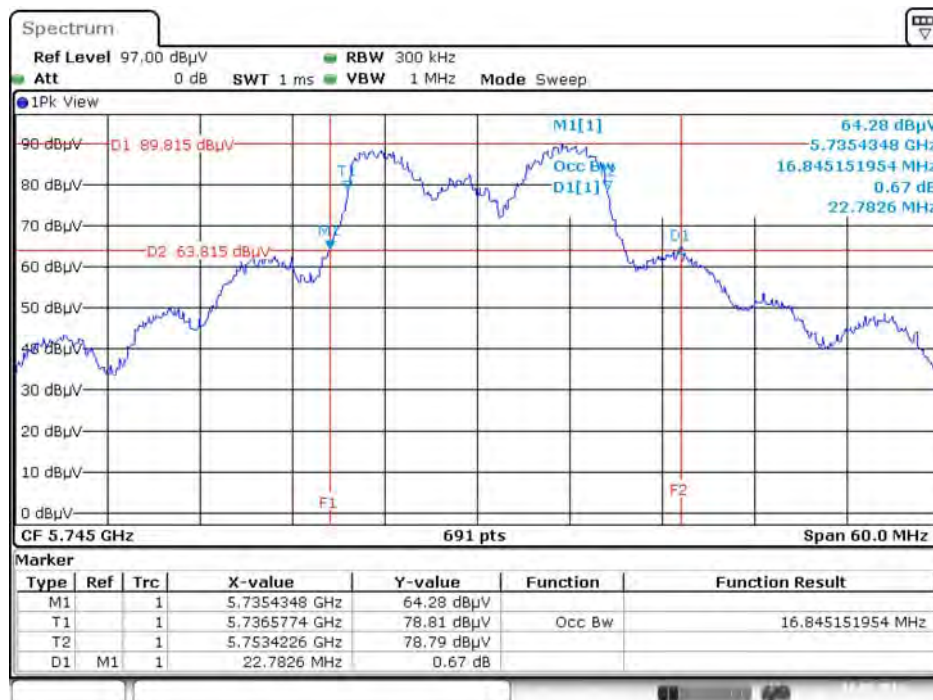

Date: 18.MAY.2016 17:05:56

**26dB Bandwidth and 99% Occupied Bandwidth Plot on Configuration IEEE 802.11a / Chain 5 + Chain 6+ Chain 7 + Chain 8 / 5785 MHz**

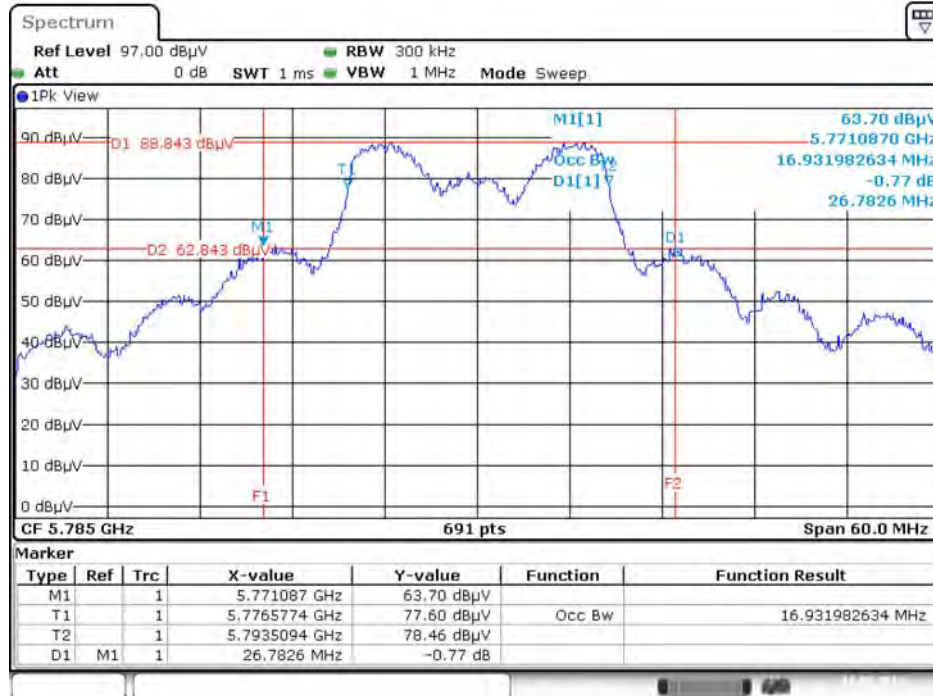

Date: 18.MAY.2016 17:07:09

**26dB Bandwidth and 99% Occupied Bandwidth Plot on Configuration IEEE 802.11a / Chain 5 + Chain 6+ Chain 7 + Chain 8 / 5825 MHz**

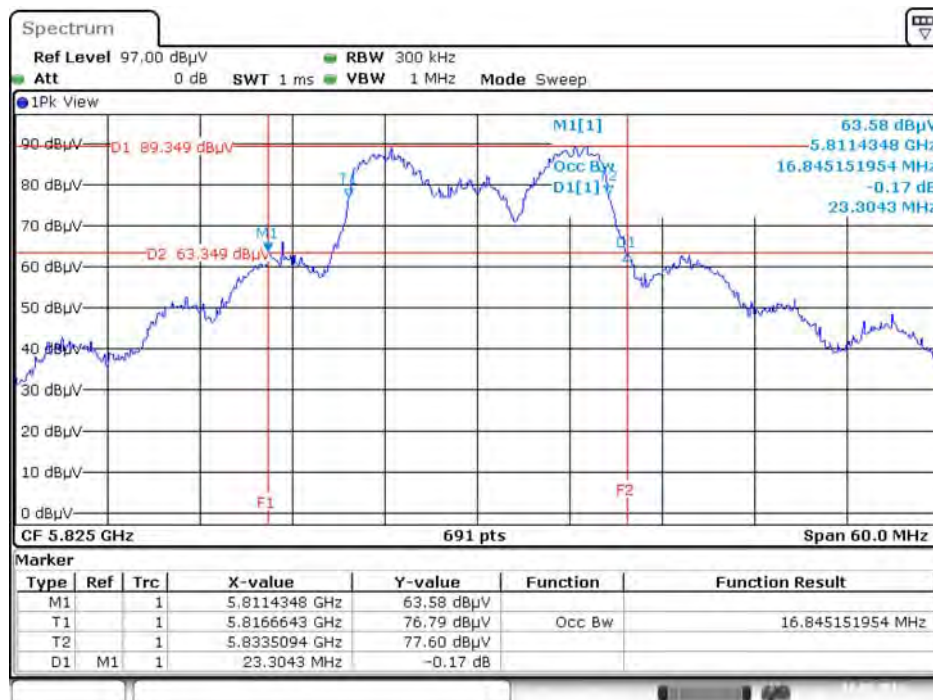

Date: 18.MAY.2016 17:07:33

**26dB Bandwidth and 99% Occupied Bandwidth Plot on Configuration IEEE 802.11ac MCS0/Nss1 VHT20 / Chain 5 + Chain 6+ Chain 7 + Chain 8 / 5180 MHz**

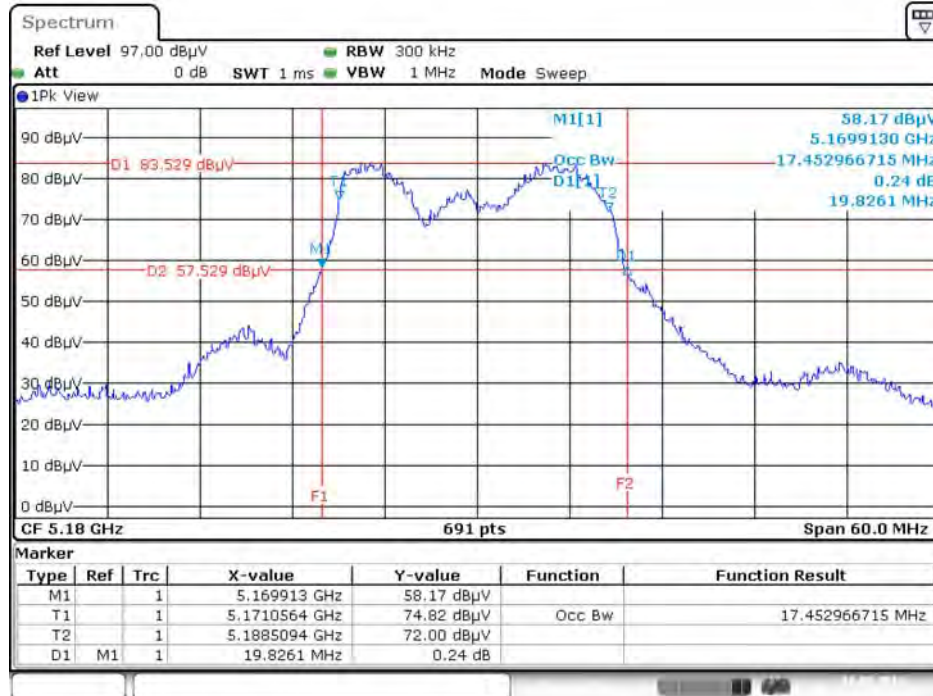

Date: 18.MAY.2016 17:09:51

**26dB Bandwidth and 99% Occupied Bandwidth Plot on Configuration IEEE 802.11ac MCS0/Nss1 VHT20 / Chain 5 + Chain 6+ Chain 7 + Chain 8 / 5200 MHz**

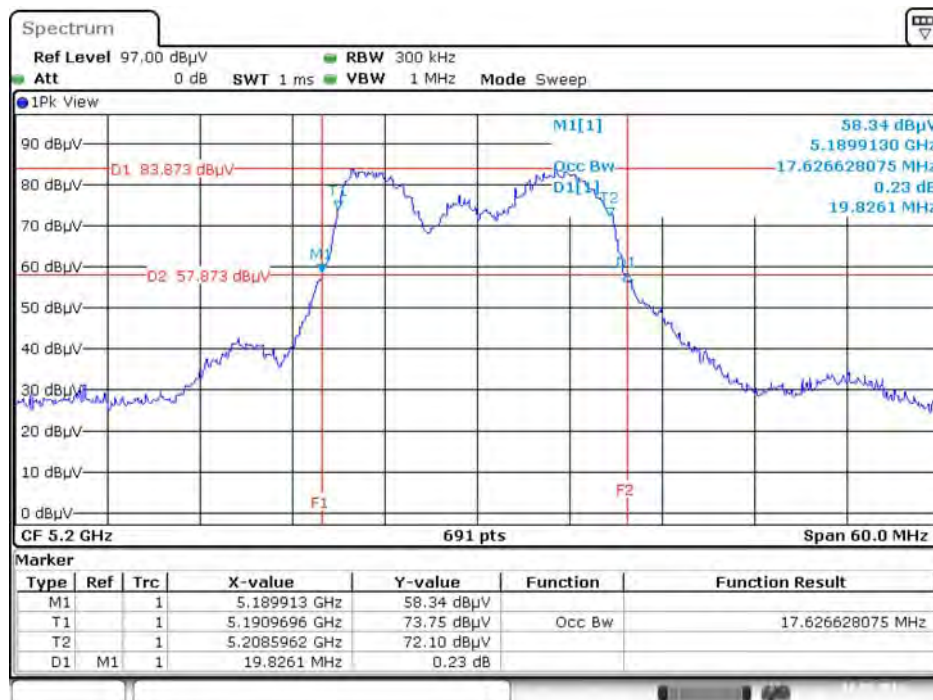

Date: 18.MAY.2016 17:11:17



26dB Bandwidth and 99% Occupied Bandwidth Plot on Configuration IEEE 802.11ac MCS0/Nss1 VHT20 / Chain 5 + Chain 6+ Chain 7 + Chain 8 / 5240 MHz

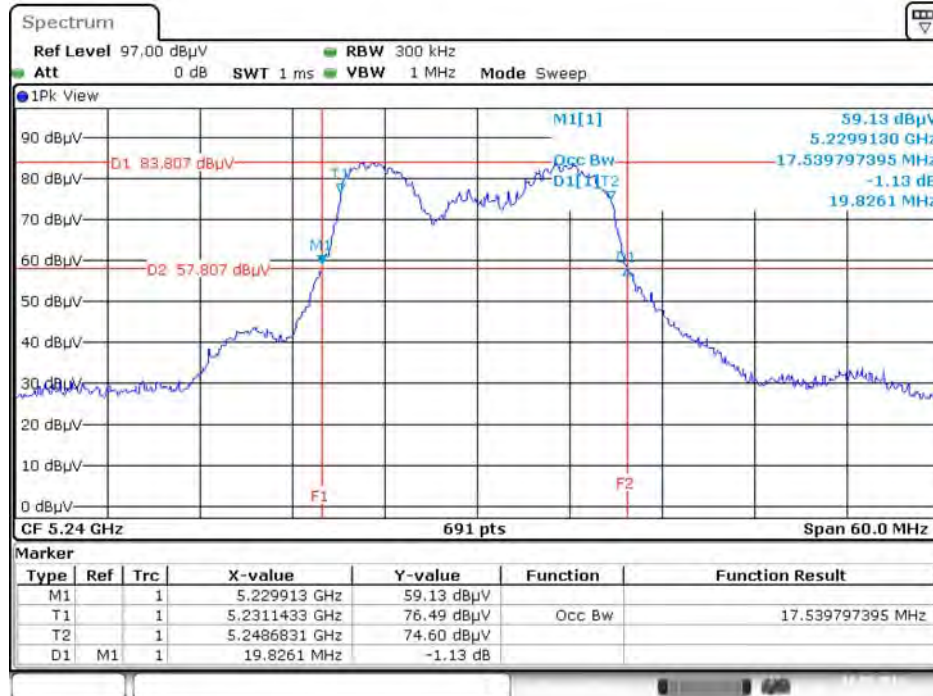

Date: 18.MAY.2016 17:13:15

26dB Bandwidth and 99% Occupied Bandwidth Plot on Configuration IEEE 802.11ac MCS0/Nss1 VHT20 / Chain 5 + Chain 6+ Chain 7 + Chain 8 / 5745 MHz

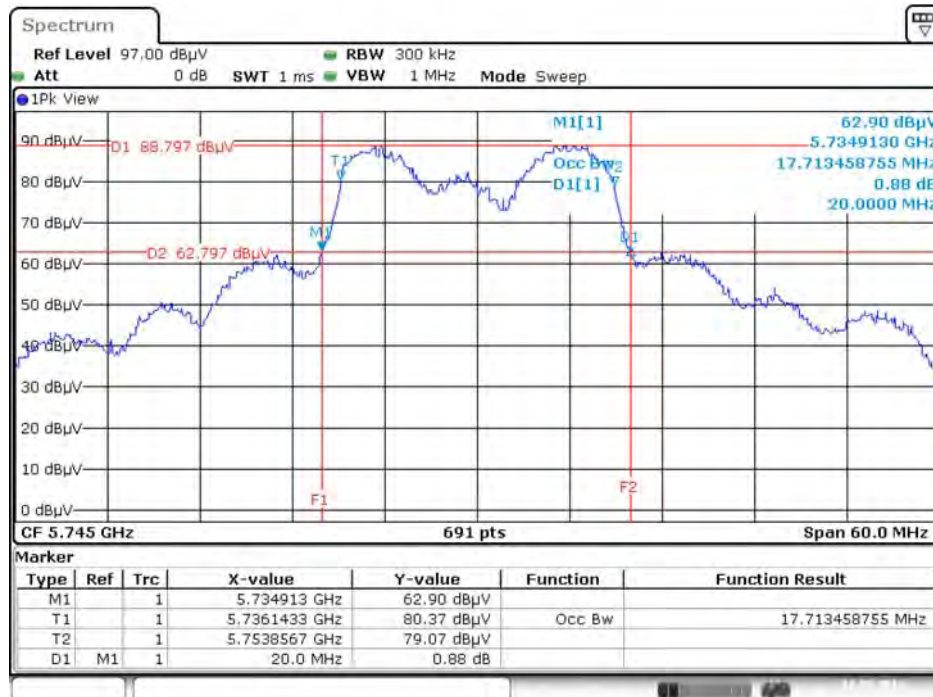

Date: 18.MAY.2016 17:14:36

26dB Bandwidth and 99% Occupied Bandwidth Plot on Configuration IEEE 802.11ac MCS0/Nss1 VHT20 / Chain 5 + Chain 6+ Chain 7 + Chain 8 / 5785 MHz

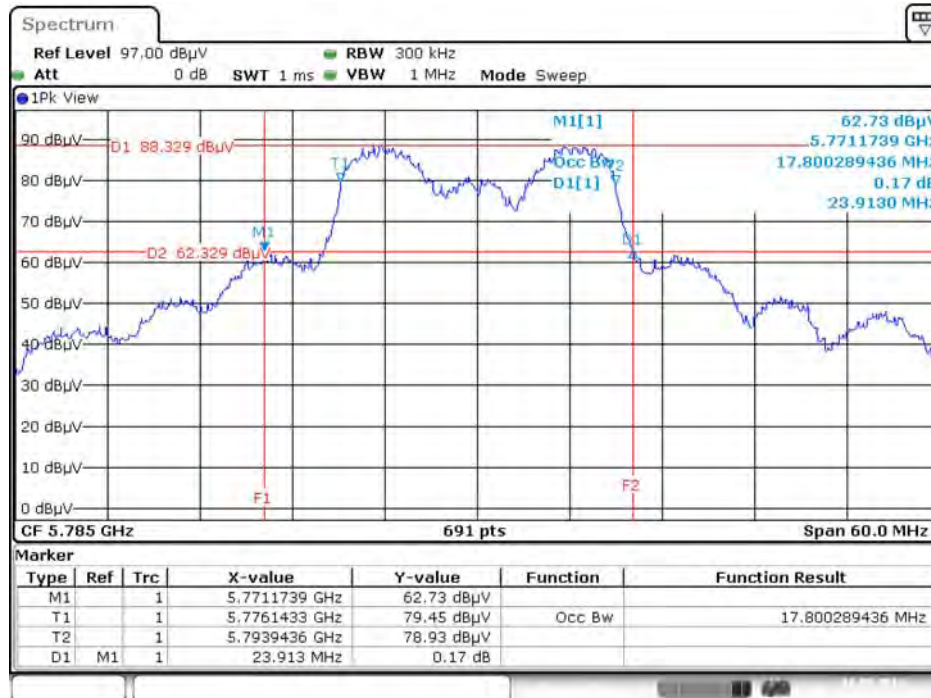

Date: 18.MAY.2016 17:15:51

26dB Bandwidth and 99% Occupied Bandwidth Plot on Configuration IEEE 802.11ac MCS0/Nss1 VHT20 / Chain 5 + Chain 6+ Chain 7 + Chain 8 / 5825 MHz

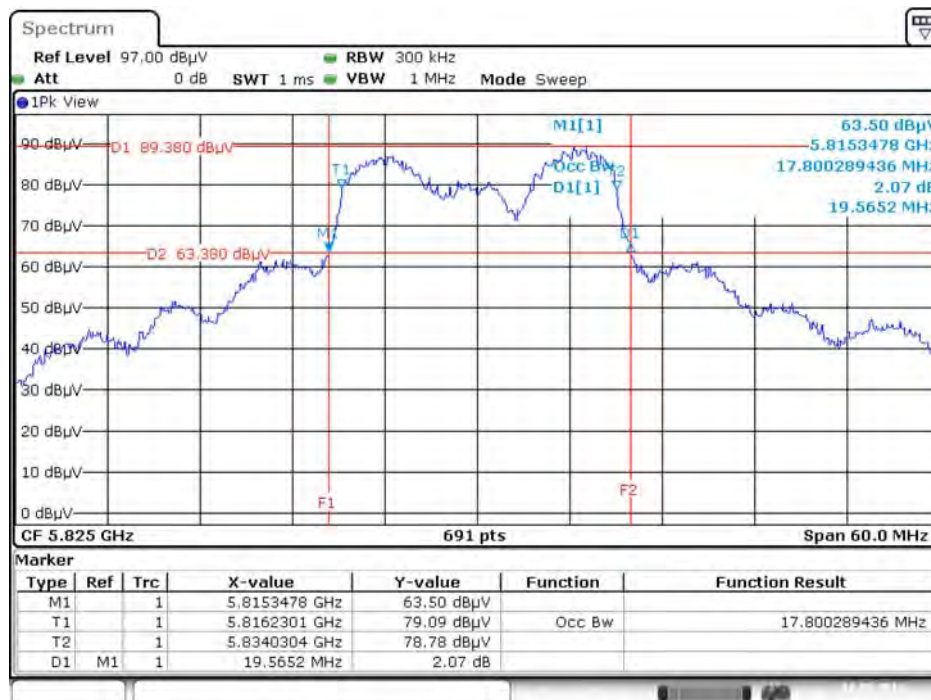

Date: 18.MAY.2016 17:18:15

26dB Bandwidth and 99% Occupied Bandwidth Plot on Configuration IEEE 802.11ac MCS0/Nss1 VHT40 / Chain 5 + Chain 6+ Chain 7 + Chain 8 / 5190 MHz

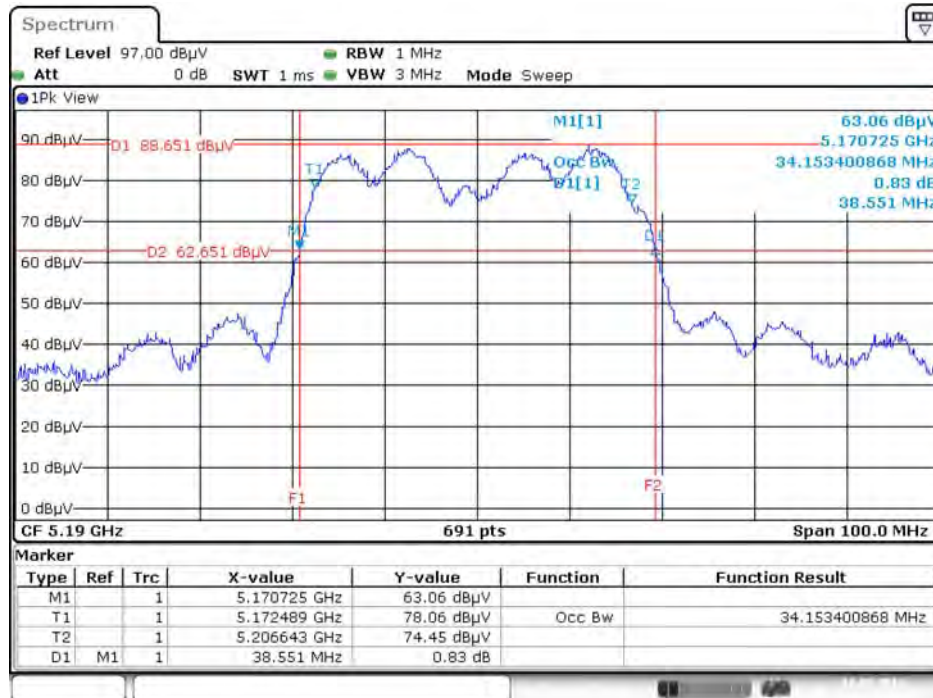

Date: 18.MAY.2016 17:22:55

26dB Bandwidth and 99% Occupied Bandwidth Plot on Configuration IEEE 802.11ac MCS0/Nss1 VHT40 / Chain 5 + Chain 6+ Chain 7 + Chain 8 / 5230 MHz

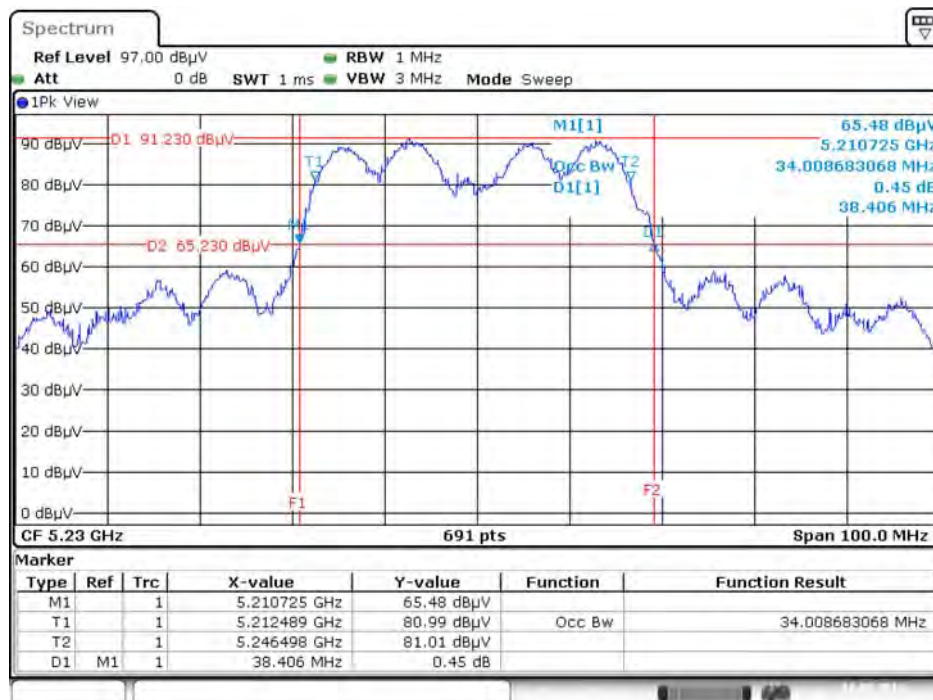

Date: 18.MAY.2016 17:25:14

26dB Bandwidth and 99% Occupied Bandwidth Plot on Configuration IEEE 802.11ac MCS0/Nss1 VHT40 / Chain 5 + Chain 6+ Chain 7 + Chain 8 / 5755 MHz

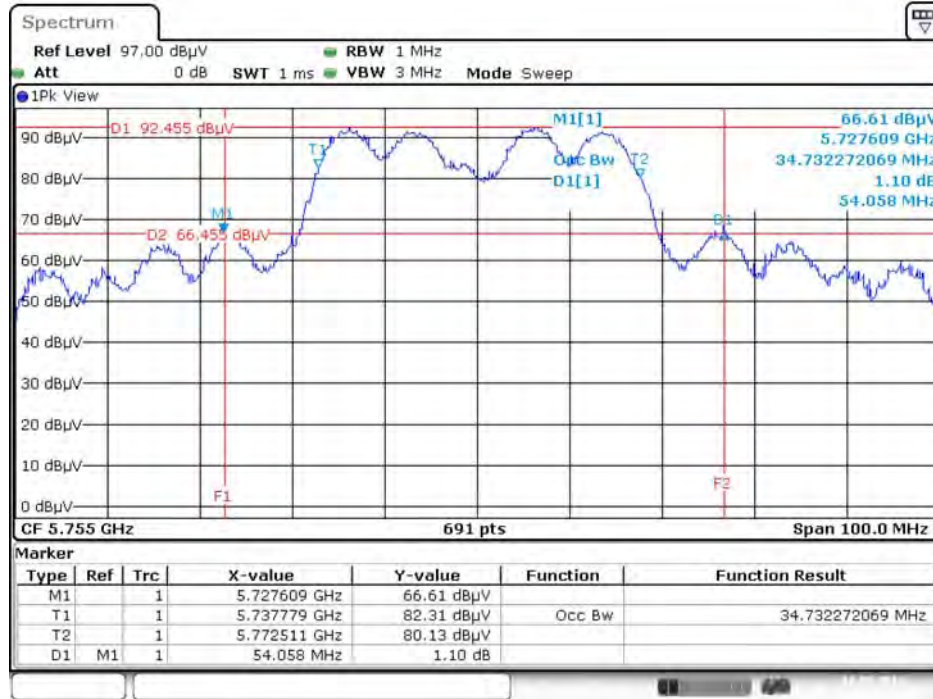

Date: 18.MAY.2016 17:26:45

26dB Bandwidth and 99% Occupied Bandwidth Plot on Configuration IEEE 802.11ac MCS0/Nss1 VHT40 / Chain 5 + Chain 6+ Chain 7 + Chain 8 / 5795 MHz

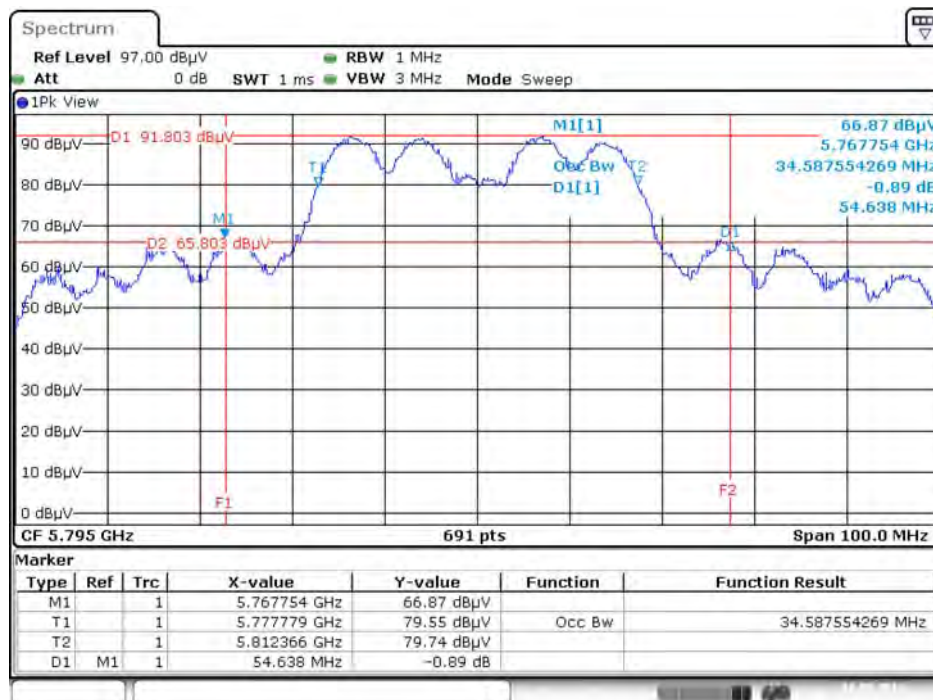

Date: 18.MAY.2016 17:28:23

**26dB Bandwidth and 99% Occupied Bandwidth Plot on Configuration IEEE 802.11ac MCS0/Nss1 VHT80 / Chain 5 + Chain 6+ Chain 7 + Chain 8 / 5210 MHz**

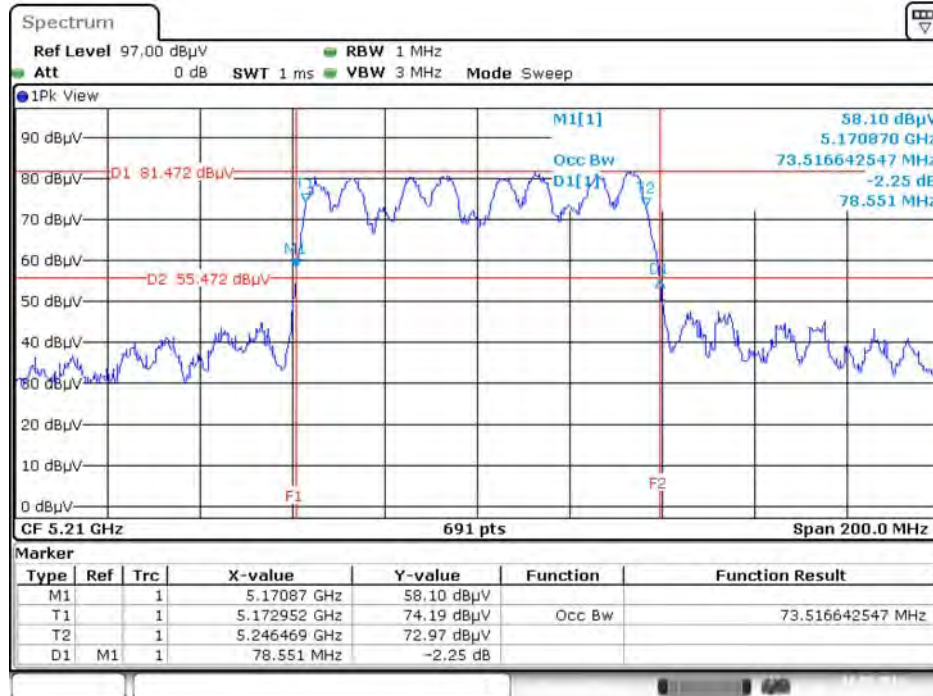

Date: 18.MAY.2016 17:34:25

**26dB Bandwidth and 99% Occupied Bandwidth Plot on Configuration IEEE 802.11ac MCS0/Nss1 VHT80 / Chain 5 + Chain 6+ Chain 7 + Chain 8 / 5775 MHz**

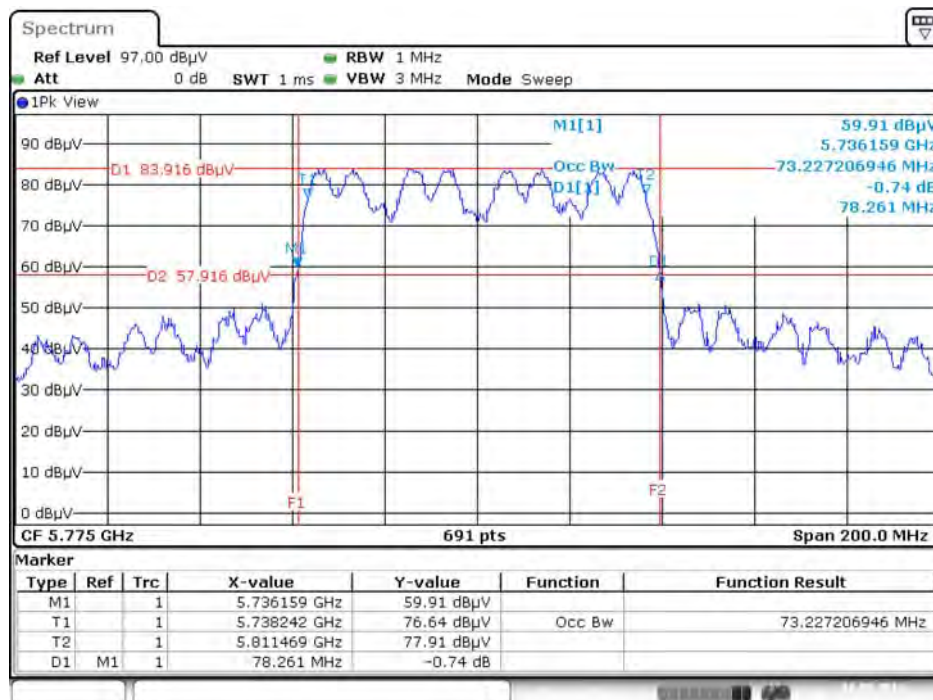

Date: 18.MAY.2016 17:33:36

802.11ac MCS0/Nss2 VHT80+80

Type 1

26dB Bandwidth and 99% Occupied Bandwidth Plot on Chain 6 + Chain 7 / 5210 MHz

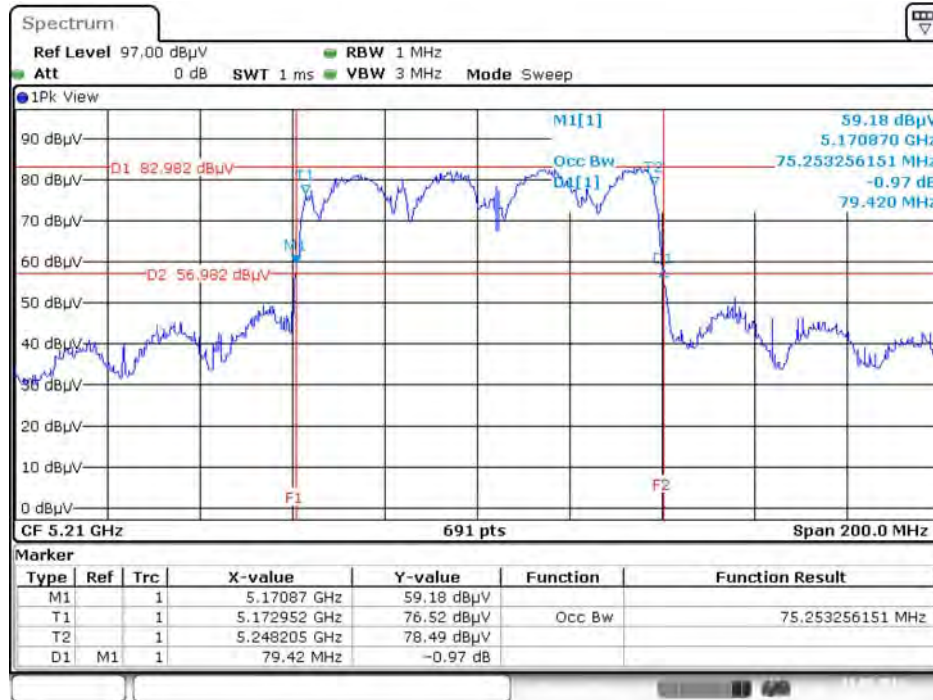

Date: 19.MAY.2016 10:28:35

26dB Bandwidth and 99% Occupied Bandwidth Plot on Chain 5 + Chain 8 / 5775 MHz

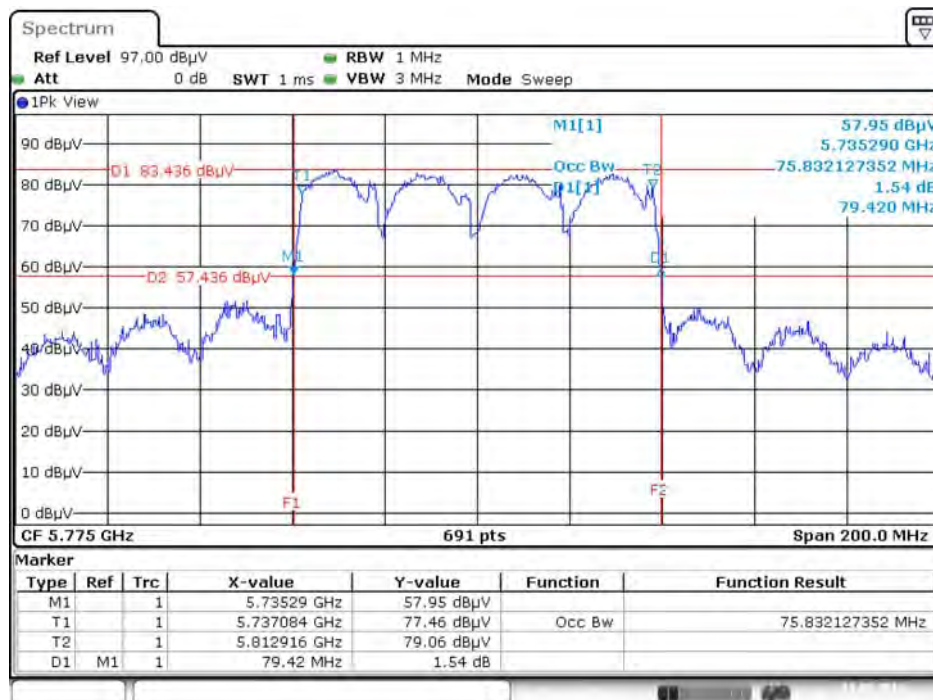

Date: 19.MAY.2016 10:30:39

<For Beamforming Mode>

26dB Bandwidth and 99% Occupied Bandwidth Plot on Configuration IEEE 802.11ac MCS0/Nss1 VHT20 / Chain 5 + Chain 6+ Chain 7 + Chain 8 / 5180 MHz

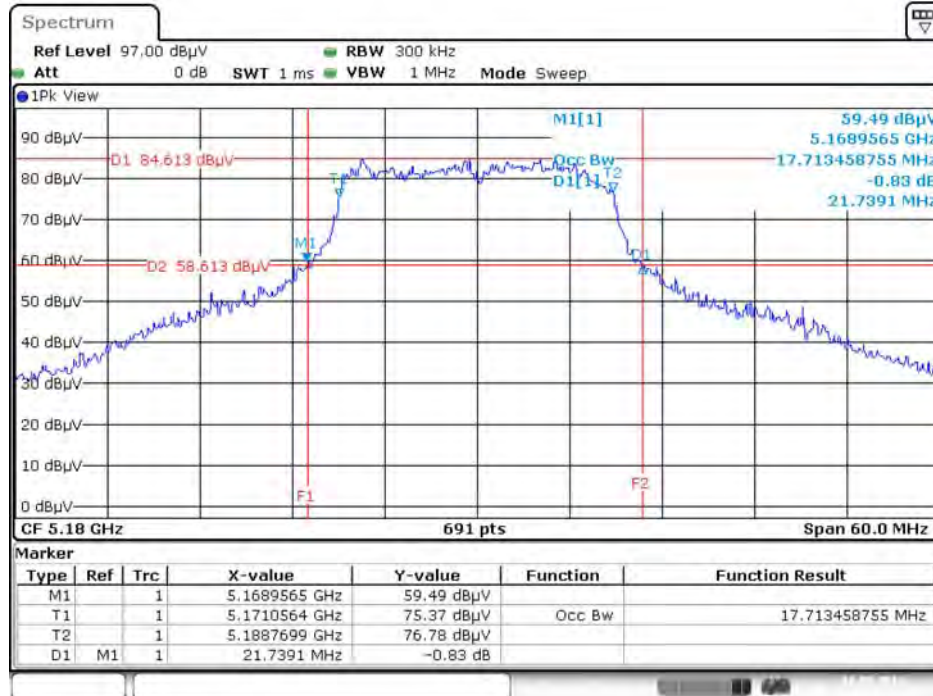

Date: 18.MAY.2016 17:10:39

26dB Bandwidth and 99% Occupied Bandwidth Plot on Configuration IEEE 802.11ac MCS0/Nss1 VHT20 / Chain 5 + Chain 6+ Chain 7 + Chain 8 / 5200 MHz

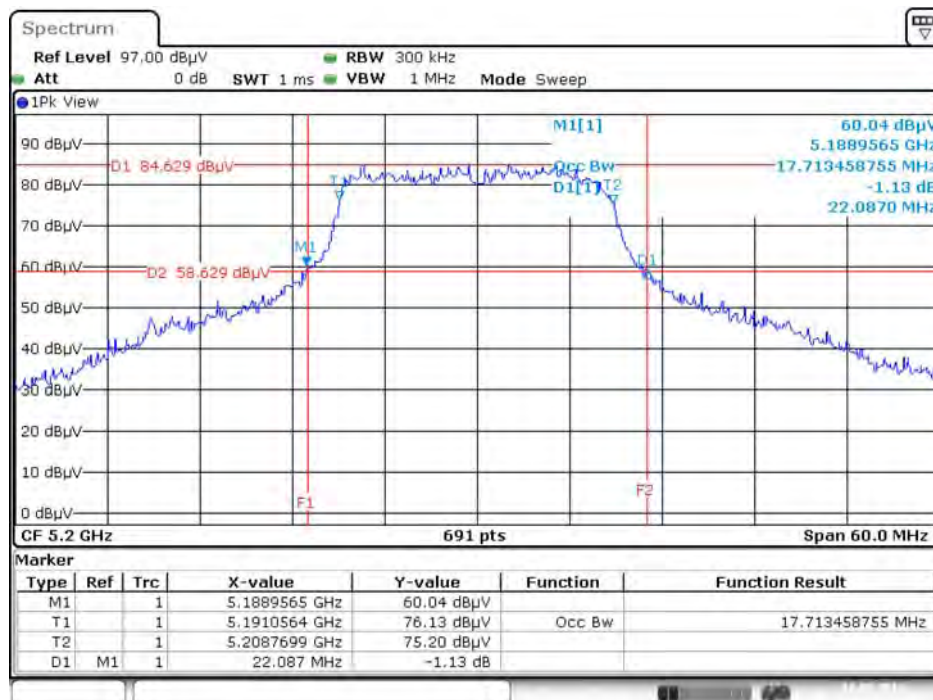

Date: 18.MAY.2016 17:12:45

26dB Bandwidth and 99% Occupied Bandwidth Plot on Configuration IEEE 802.11ac MCS0/Nss1 VHT20 / Chain 5 + Chain 6+ Chain 7 + Chain 8 / 5240 MHz

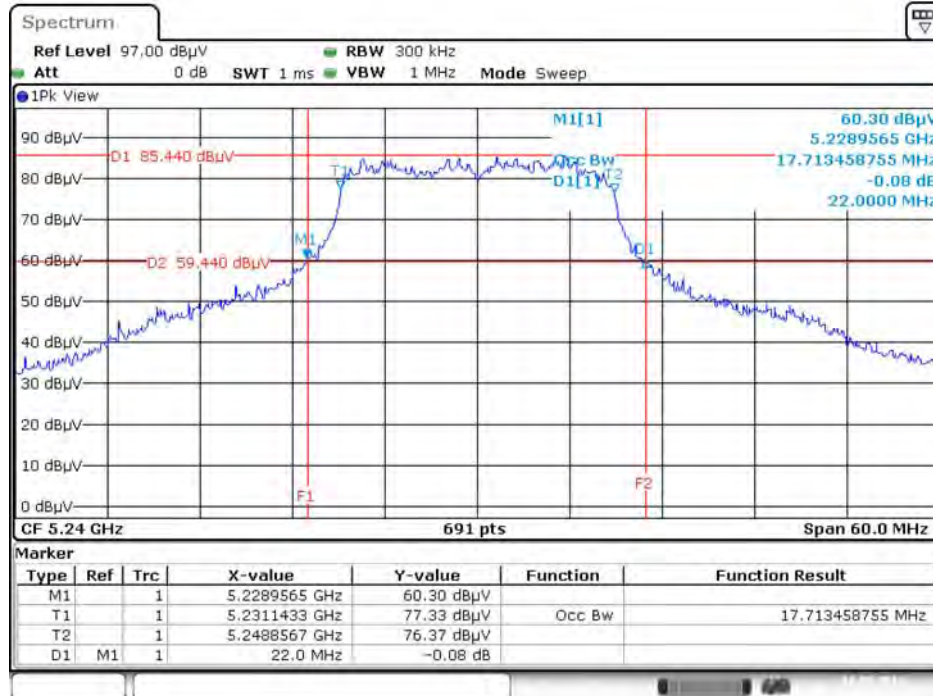

Date: 18.MAY.2016 17:13:57

26dB Bandwidth and 99% Occupied Bandwidth Plot on Configuration IEEE 802.11ac MCS0/Nss1 VHT20 / Chain 5 + Chain 6+ Chain 7 + Chain 8 / 5745 MHz

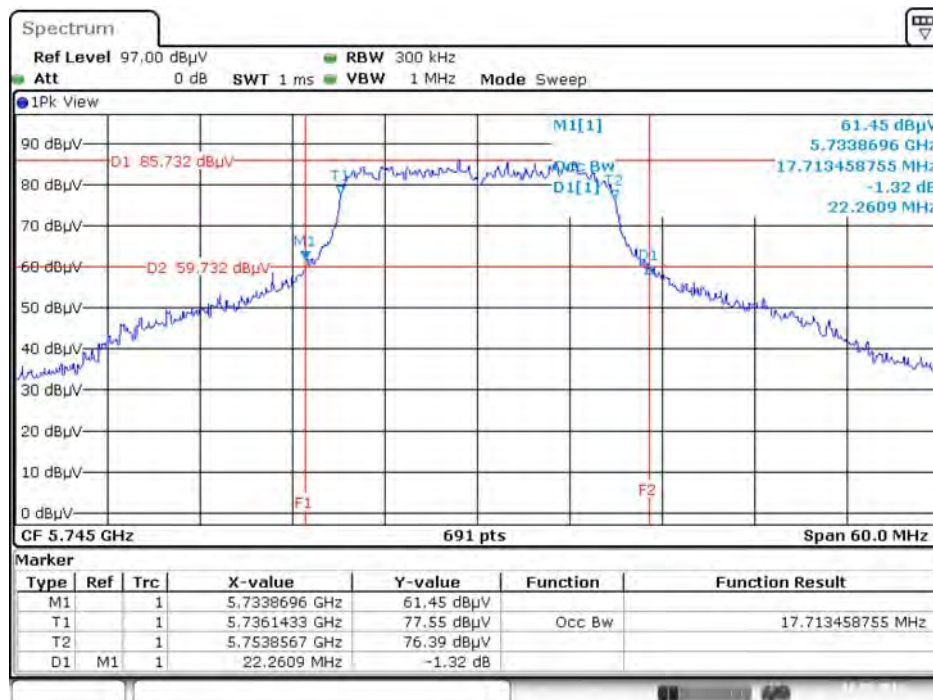

Date: 18.MAY.2016 17:17:13



26dB Bandwidth and 99% Occupied Bandwidth Plot on Configuration IEEE 802.11ac MCS0/Nss1 VHT20 / Chain 5 + Chain 6+ Chain 7 + Chain 8 / 5785 MHz

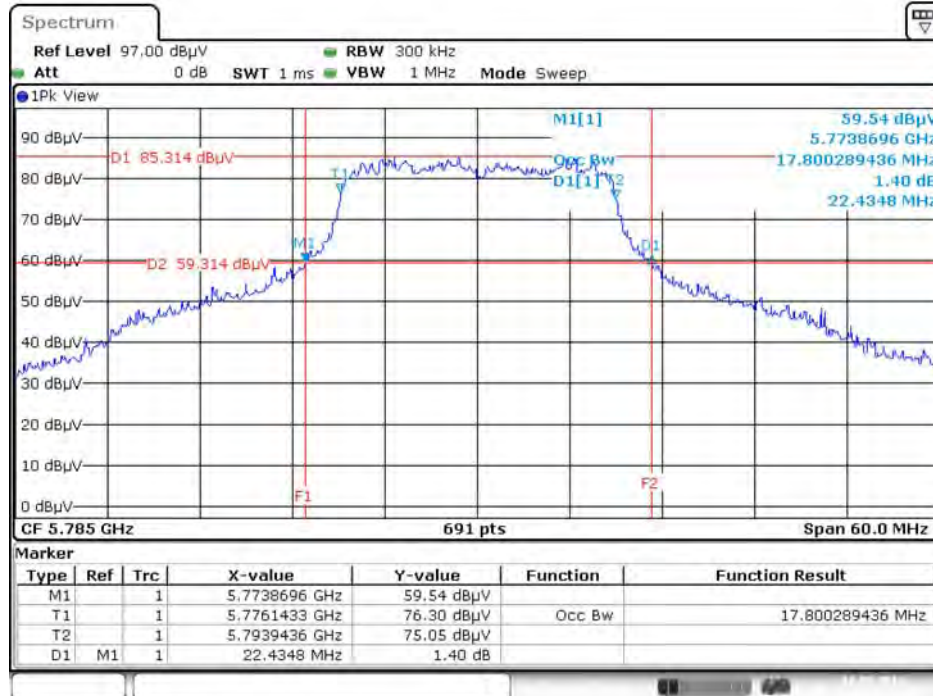

Date: 18.MAY.2016 17:16:32

26dB Bandwidth and 99% Occupied Bandwidth Plot on Configuration IEEE 802.11ac MCS0/Nss1 VHT20 / Chain 5 + Chain 6+ Chain 7 + Chain 8 / 5825 MHz

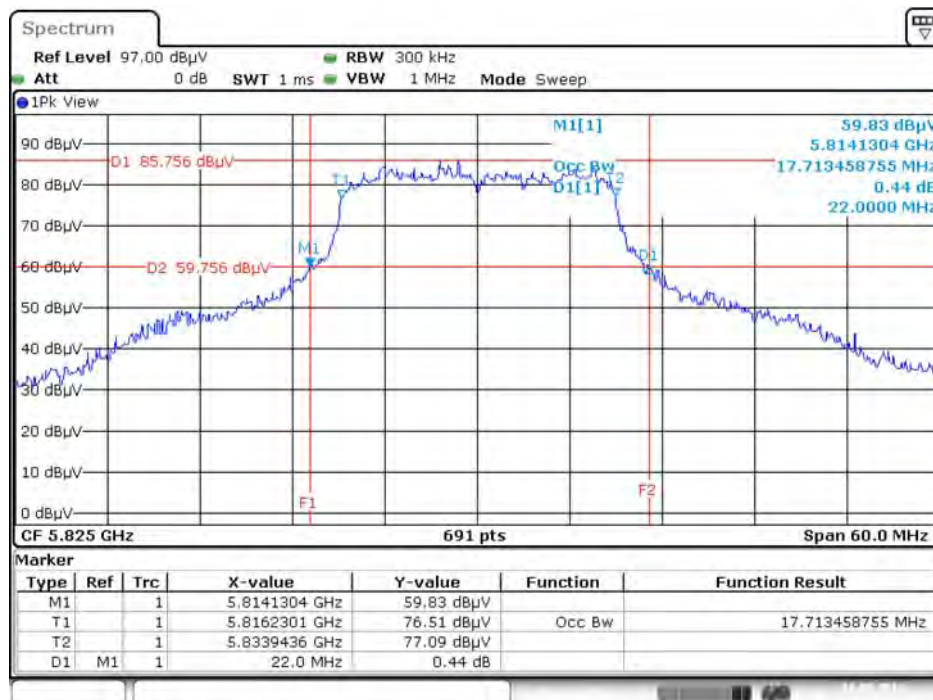

Date: 18.MAY.2016 17:20:03

26dB Bandwidth and 99% Occupied Bandwidth Plot on Configuration IEEE 802.11ac MCS0/Nss1 VHT40 / Chain 5 + Chain 6+ Chain 7 + Chain 8 / 5190 MHz

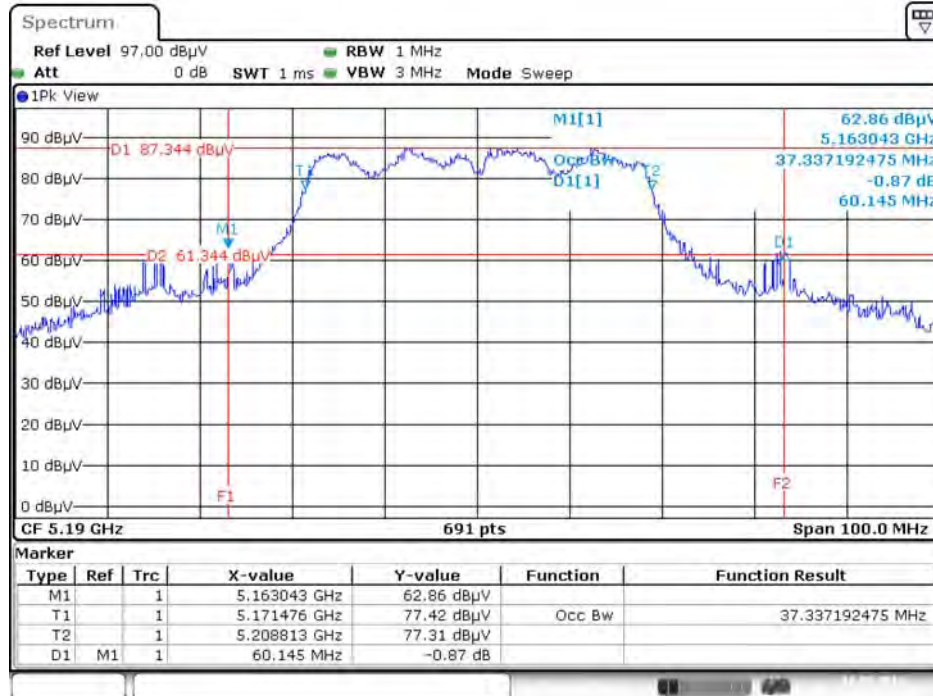

Date: 18.MAY.2016 17:24:19

26dB Bandwidth and 99% Occupied Bandwidth Plot on Configuration IEEE 802.11ac MCS0/Nss1 VHT40 / Chain 5 + Chain 6+ Chain 7 + Chain 8 / 5230 MHz

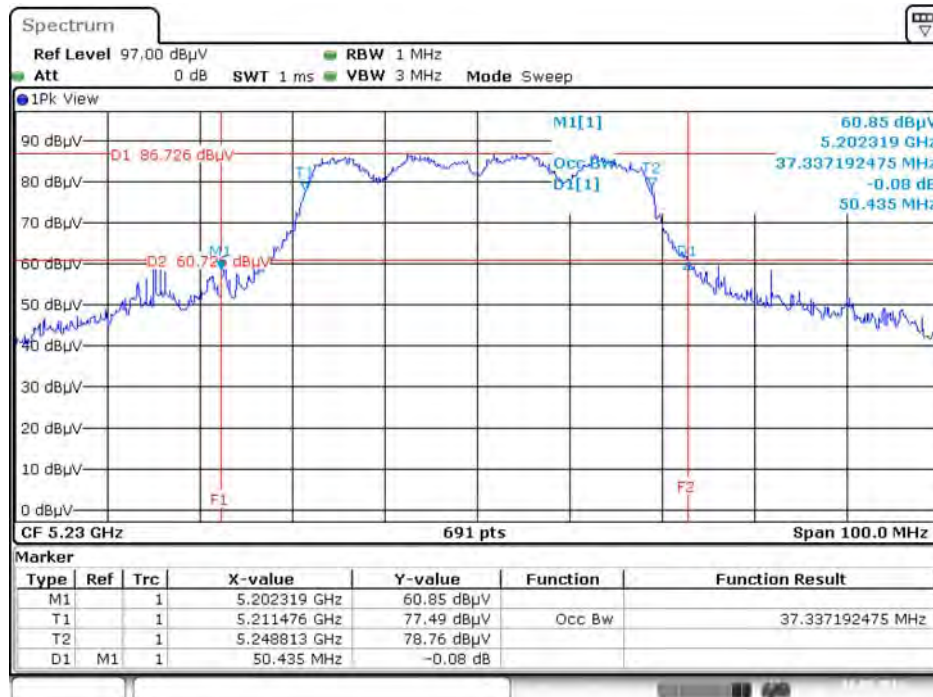

Date: 18.MAY.2016 17:25:47

26dB Bandwidth and 99% Occupied Bandwidth Plot on Configuration IEEE 802.11ac MCS0/Nss1 VHT40 / Chain 5 + Chain 6+ Chain 7 + Chain 8 / 5755 MHz

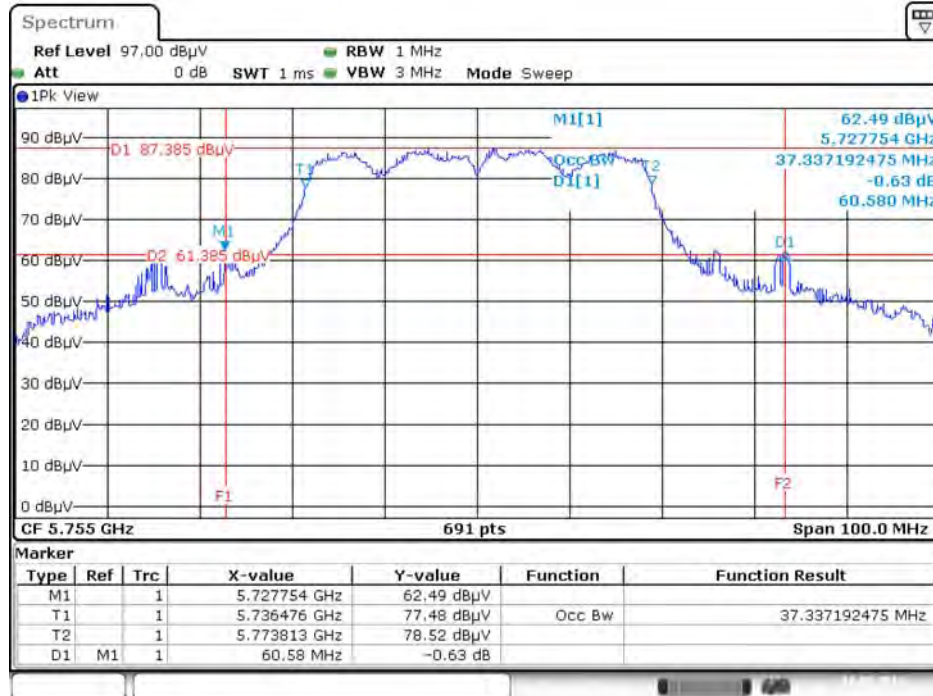

Date: 18.MAY.2016 17:27:30

26dB Bandwidth and 99% Occupied Bandwidth Plot on Configuration IEEE 802.11ac MCS0/Nss1 VHT40 / Chain 5 + Chain 6+ Chain 7 + Chain 8 / 5795 MHz

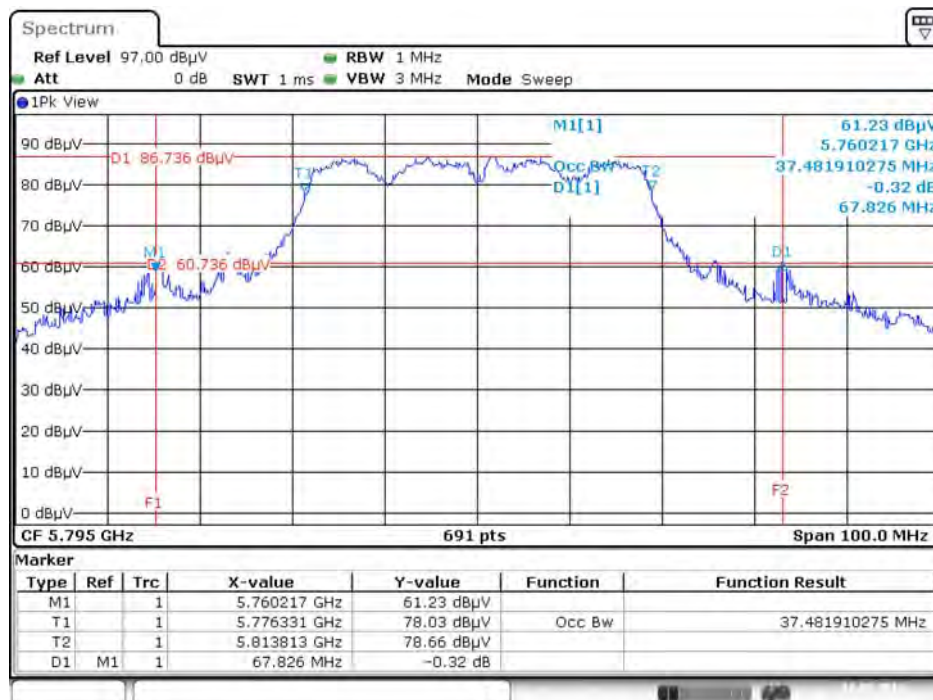

Date: 18.MAY.2016 17:29:55

26dB Bandwidth and 99% Occupied Bandwidth Plot on Configuration IEEE 802.11ac MCS0/Nss1 VHT80 / Chain 5 + Chain 6+ Chain 7 + Chain 8 / 5210 MHz

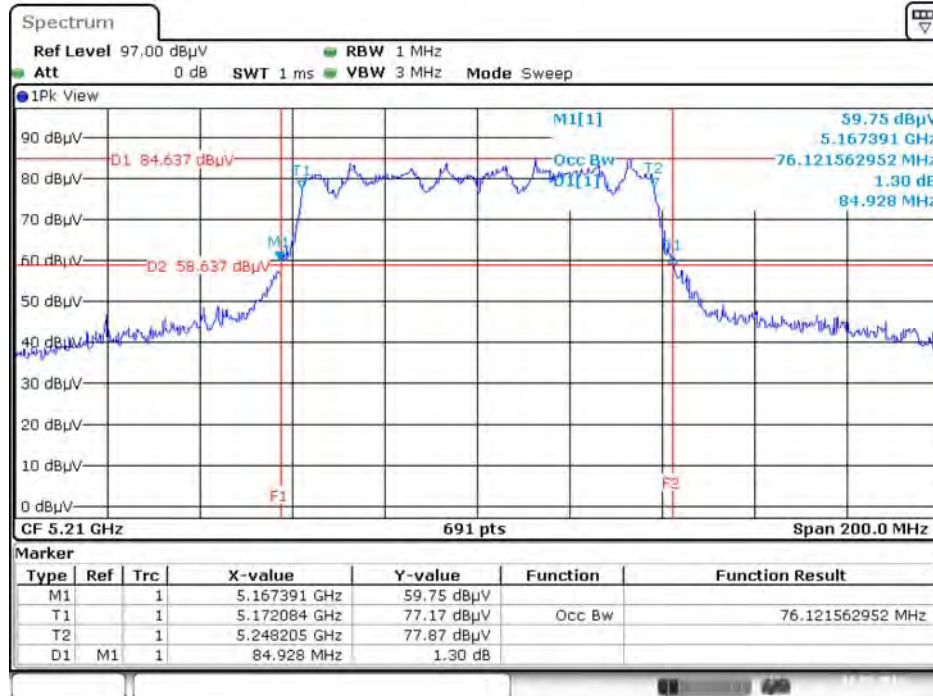

Date: 18.MAY.2016 17:32:01

26dB Bandwidth and 99% Occupied Bandwidth Plot on Configuration IEEE 802.11ac MCS0/Nss1 VHT80 / Chain 5 + Chain 6+ Chain 7 + Chain 8 / 5775 MHz

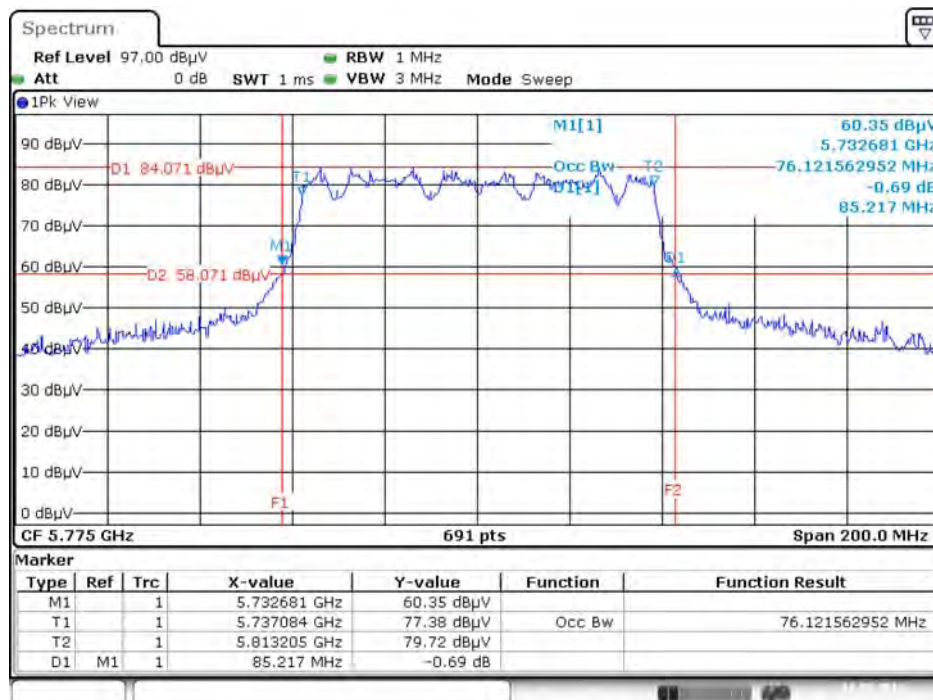

Date: 18.MAY.2016 17:33:11

802.11ac MCS0/Nss2 VHT80+80

Type 1

26dB Bandwidth and 99% Occupied Bandwidth Plot on Chain 6 + Chain 7 / 5210 MHz

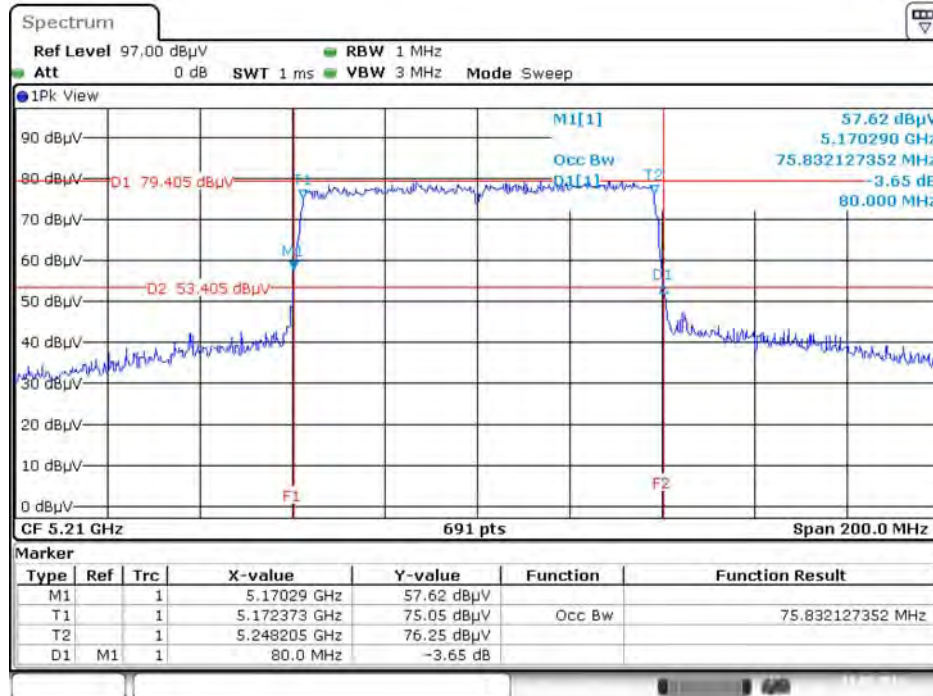

Date: 19.MAY.2016 10:50:45

26dB Bandwidth and 99% Occupied Bandwidth Plot on Chain 5 + Chain 8 / 5775 MHz

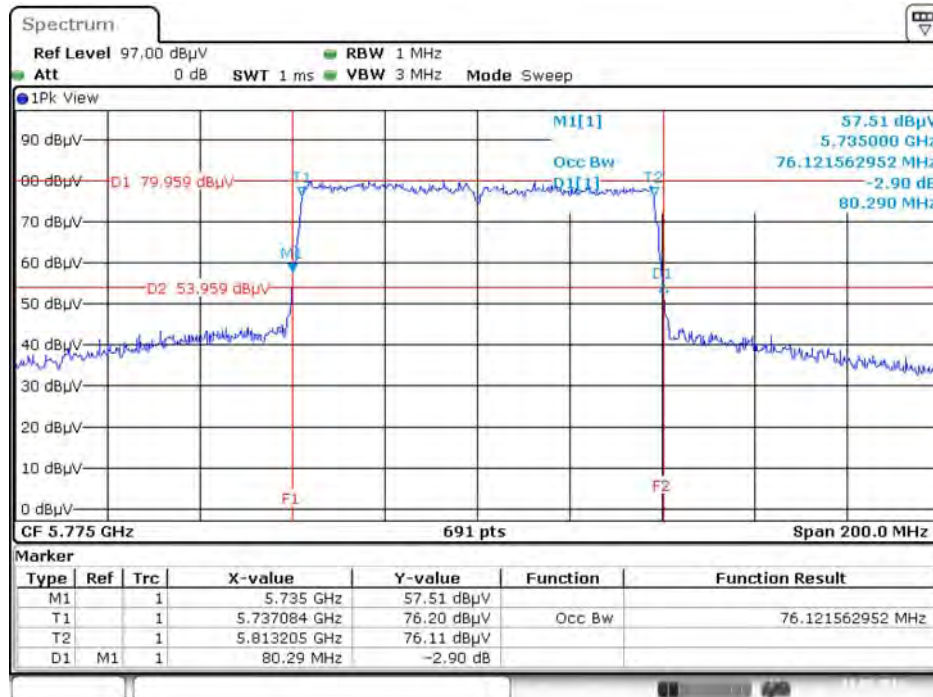

Date: 19.MAY.2016 10:51:45

### 4.3. 6dB Spectrum Bandwidth Measurement

#### 4.3.1. Limit

For digital modulation systems, the minimum 6dB bandwidth shall be at least 500 kHz.

#### 4.3.2. Measuring Instruments and Setting

Please refer to section 5 of equipments list in this report. The following table is the setting of spectrum analyzer.

6dB Spectrum Bandwidth	
Spectrum Parameters	Setting
Attenuation	Auto
Span Frequency	> 6dB Bandwidth
RBW	100kHz
VBW	$\geq 3 \times \text{RBW}$
Detector	Peak
Trace	Max Hold
Sweep Time	Auto

#### 4.3.3. Test Procedures

For Radiated 6dB Bandwidth Measurement:

1. The transmitter was radiated to the spectrum analyzer in peak hold mode.
2. Test was performed in accordance with KDB789033 D02 v01r02 for Compliance Testing of Unlicensed National Information Infrastructure (U-NII) Devices - section (C) Emission Bandwidth.
3. Multiple antenna system was performed in accordance with KDB662911 D01 v02r01 Emissions Testing of Transmitters with Multiple Outputs in the Same Band.
4. Measured the spectrum width with power higher than 6dB below carrier.

#### 4.3.4. Test Setup Layout

For Radiated 6dB Bandwidth Measurement:

This test setup layout is the same as that shown in section 4.6.4.

#### 4.3.5. Test Deviation

There is no deviation with the original standard.

#### 4.3.6. EUT Operation during Test

The EUT was programmed to be in continuously transmitting mode.

#### 4.3.7. Test Result of 6dB Spectrum Bandwidth

<b>Temperature</b>	24°C	<b>Humidity</b>	60%
<b>Test Engineer</b>	Clemens Fang		

<For Non-Beamforming Mode>

Mode	Frequency	6dB Bandwidth (MHz)	Min. Limit (kHz)	Test Result
802.11a	5745 MHz	16.35	500	Complies
	5785 MHz	16.17	500	Complies
	5825 MHz	15.71	500	Complies
802.11ac MCS0/Nss1 VHT20	5745 MHz	16.93	500	Complies
	5785 MHz	17.00	500	Complies
	5825 MHz	15.01	500	Complies
802.11ac MCS0/Nss1 VHT40	5755 MHz	31.30	500	Complies
	5795 MHz	30.96	500	Complies
802.11ac MCS0/Nss1 VHT80	5775 MHz	70.73	500	Complies

#### 802.11ac MCS0/Nss2 VHT80+80

Type	Frequency	6dB BW (MHz)	Min. Limit (kHz)	Test Result
1	5210 MHz	-		
	5775 MHz	75.36	500	Complies

**<For Beamforming Mode>**

Mode	Frequency	6dB Bandwidth (MHz)	Min. Limit (kHz)	Test Result
802.11ac MCS0/Nss1 VHT20	5745 MHz	17.74	500	Complies
	5785 MHz	17.74	500	Complies
	5825 MHz	16.35	500	Complies
802.11ac MCS0/Nss1 VHT40	5755 MHz	36.29	500	Complies
	5795 MHz	36.41	500	Complies
802.11ac MCS0/Nss1 VHT80	5775 MHz	76.52	500	Complies

**802.11ac MCS0/Nss2 VHT80+80**

Type	Frequency	6dB BW (MHz)	Min. Limit (kHz)	Test Result
1	5210 MHz	-		
	5775 MHz	75.94	500	Complies

Note: All the test values were listed in the report.

For plots, only the channel with worse result was shown.



<For Non-Beamforming Mode>

6 dB Bandwidth Plot on Configuration IEEE 802.11a / Chain 5 + Chain 6 + Chain 7 + Chain 8 / 5825 MHz

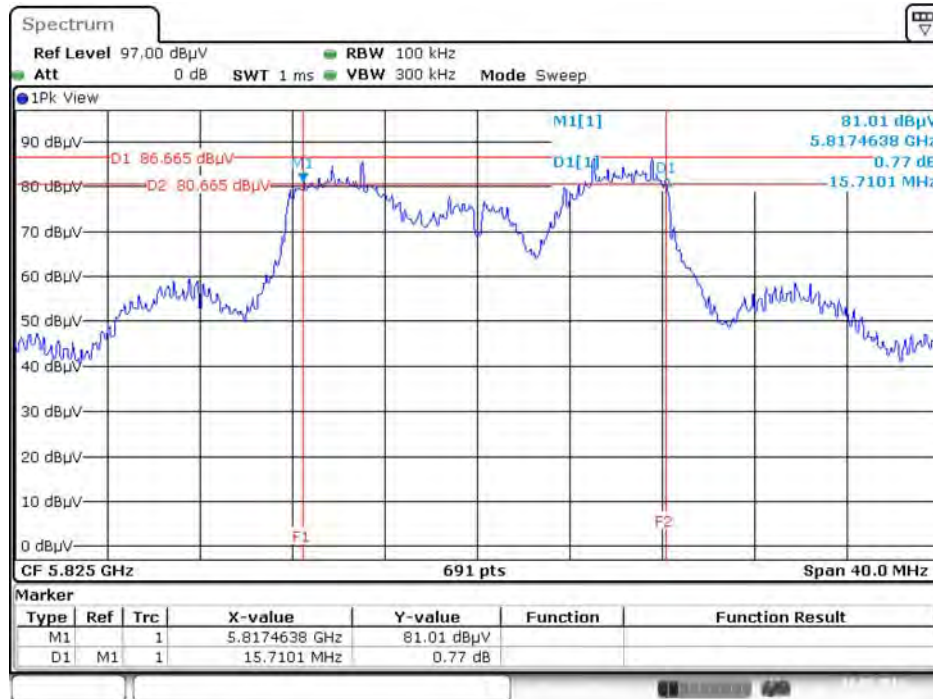

Date: 18.MAY.2016 18:07:00

6 dB Bandwidth Plot on Configuration IEEE 802.11ac MCS0/Nss1 VHT20 / Chain 5 + Chain 6 + Chain 7 + Chain 8 / 5825 MHz

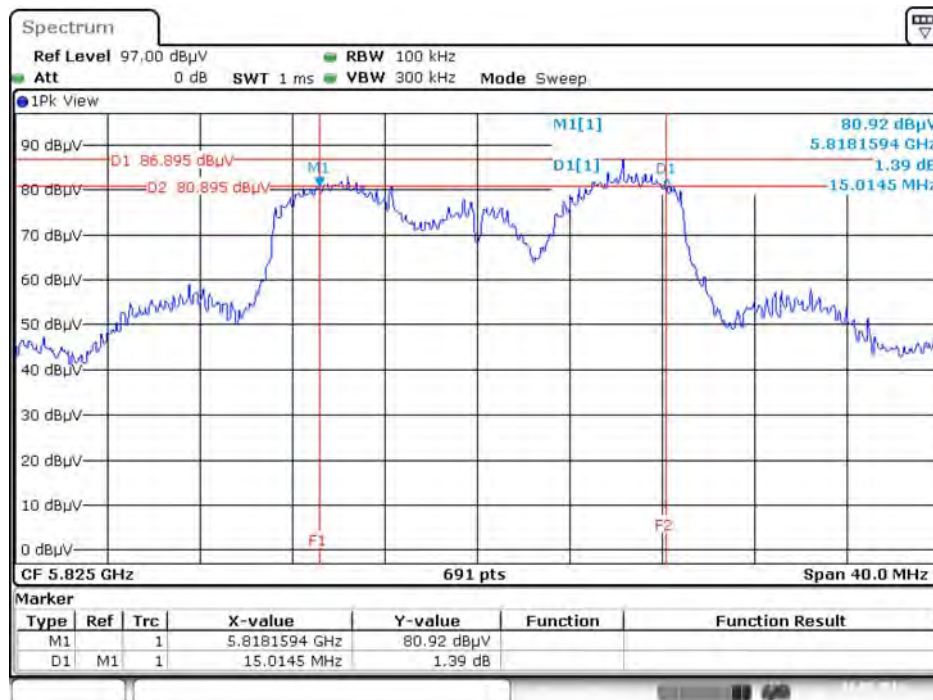

Date: 18.MAY.2016 19:17:32

6 dB Bandwidth Plot on Configuration IEEE 802.11ac MCS0/Nss1 VHT40 / Chain 5 + Chain 6 + Chain 7 + Chain 8 / 5795MHz

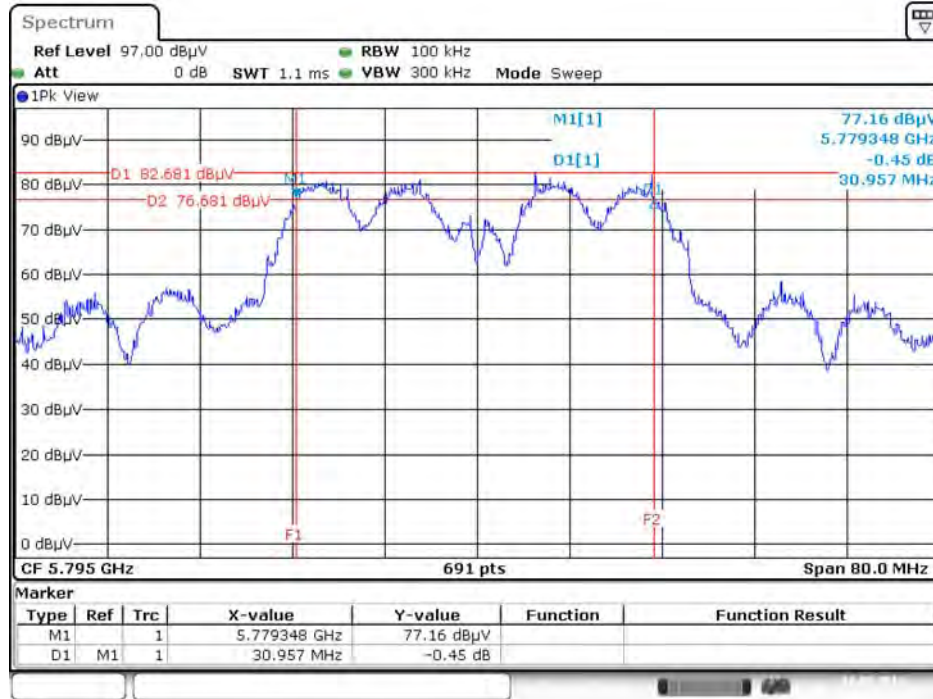

Date: 18.MAY.2016 19:19:59

6 dB Bandwidth Plot on Configuration IEEE 802.11ac MCS0/Nss1 VHT80 / Chain 5 + Chain 6 + Chain 7 + Chain 8 / 5775 MHz

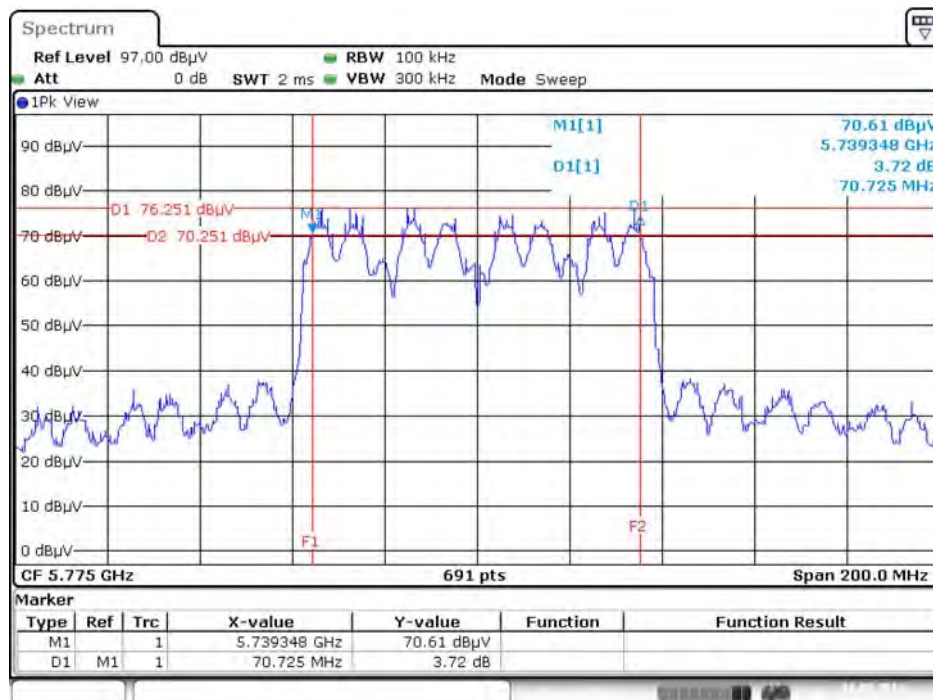

Date: 18.MAY.2016 19:22:05

802.11ac MCS0/Nss2 VHT80+80

Type 1

6 dB Bandwidth Plot on Chain 5 + Chain 8 / 5775 MHz

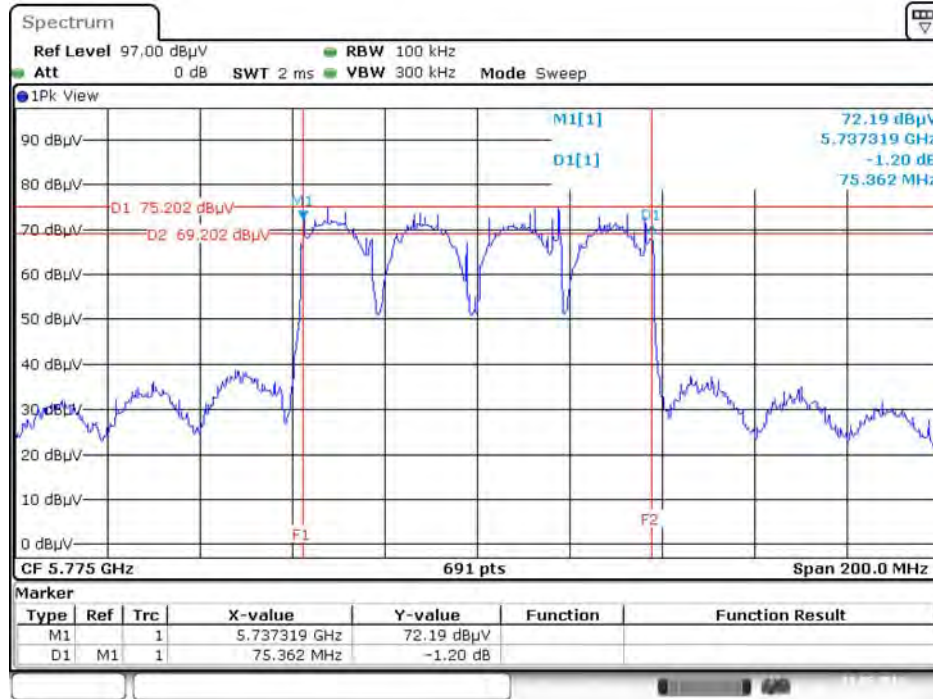

Date: 19.MAY.2016 10:31:51

<For Beamforming Mode>

6 dB Bandwidth Plot on Configuration IEEE 802.11ac MCS0/Nss1 VHT20 / Chain 5 + Chain 6 + Chain 7 + Chain 8 / 5825 MHz

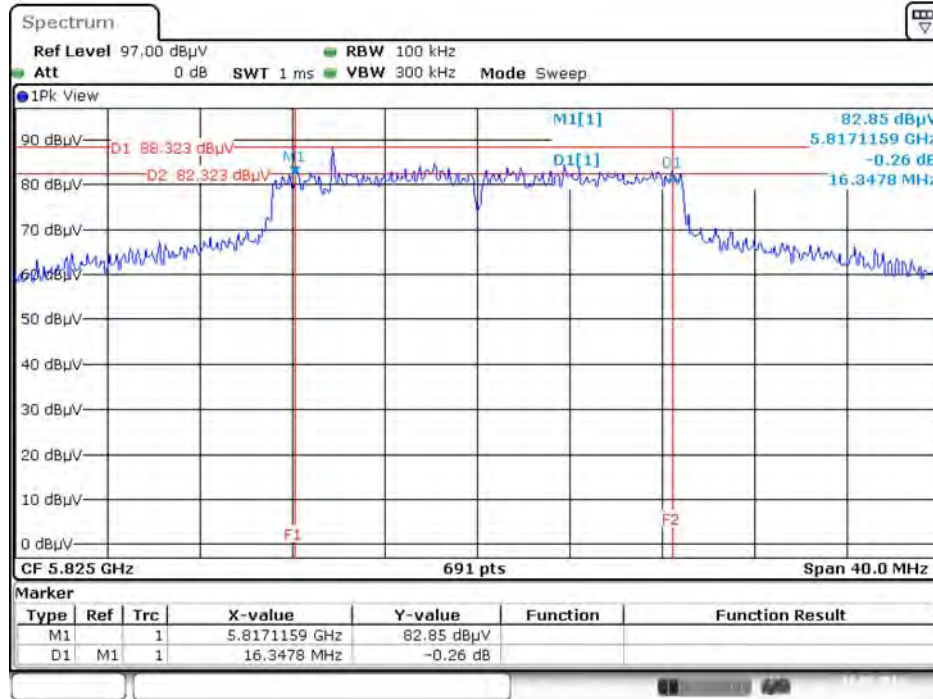

6 dB Bandwidth Plot on Configuration IEEE 802.11ac MCS0/Nss1 VHT40 / Chain 5 + Chain 6 + Chain 7 + Chain 8 / 5755MHz

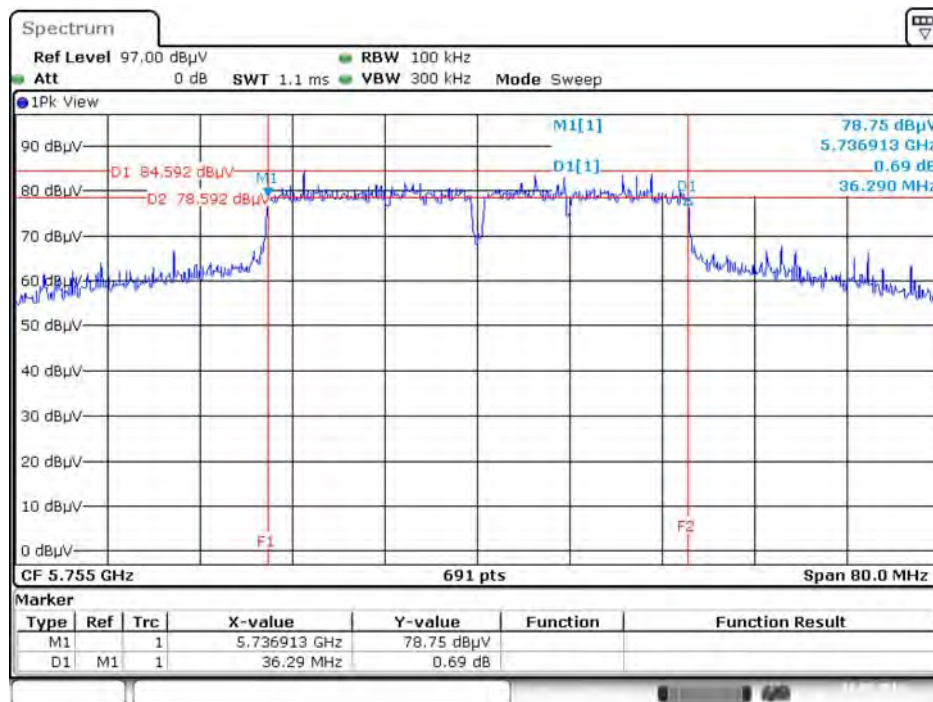

6 dB Bandwidth Plot on Configuration IEEE 802.11ac MCS0/Nss1 VHT80 / Chain 5 + Chain 6 + Chain 7 + Chain 8 / 5775 MHz

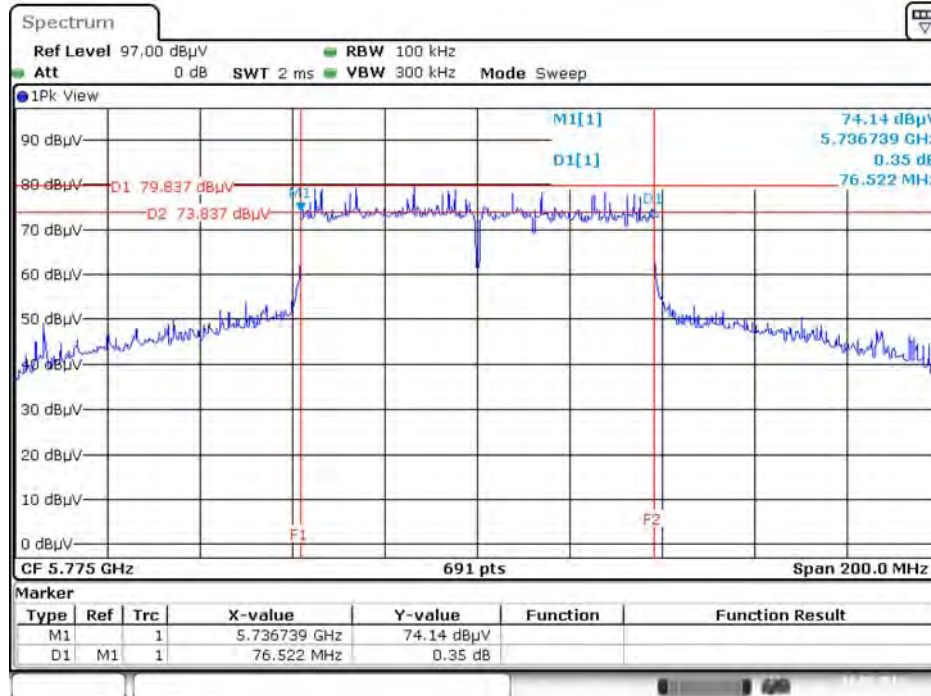

Date: 18.MAY.2016 19:22:39

802.11ac MCS0/Nss2 VHT80+80

Type 1

6 dB Bandwidth Plot on Chain 5 + Chain 8 / 5775 MHz

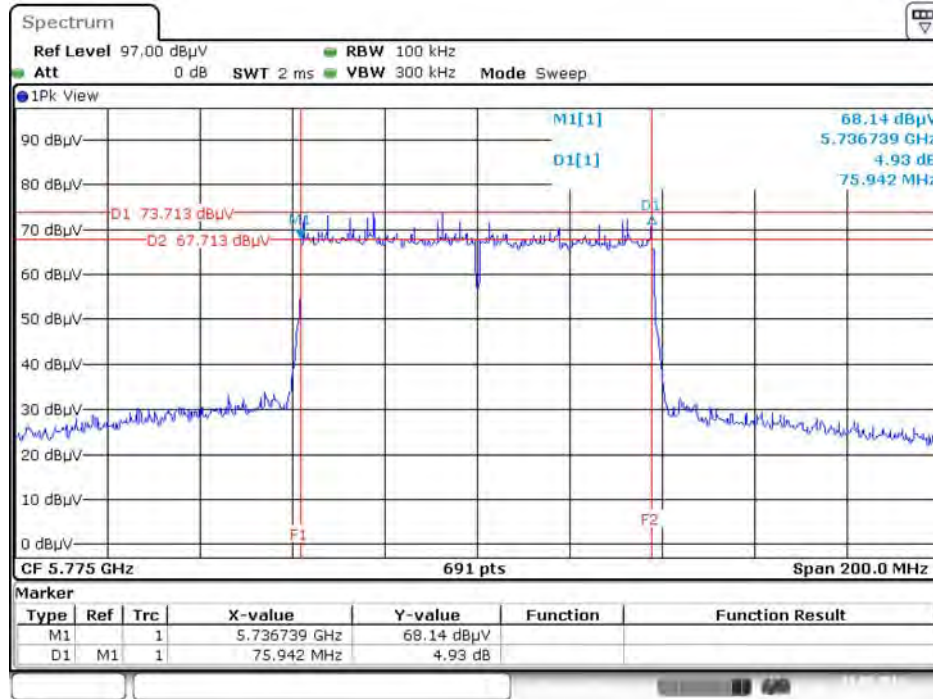

Date: 19.MAY.2016 10:52:34

## 4.4. Maximum Conducted Output Power Measurement

### 4.4.1. Limit

Frequency Band	Limit
<input type="checkbox"/> 5.15~5.25 GHz	
Operating Mode	
<input type="checkbox"/> Outdoor access point	<p>The maximum conducted output power over the frequency band of operation shall not exceed 1 W (30dBm) provided the maximum antenna gain does not exceed 6 dBi. If transmitting antennas of directional gain greater than 6 dBi are used, both the maximum conducted output power and the maximum power spectral density shall be reduced by the amount in dB that the directional gain of the antenna exceeds 6 dBi. The maximum e.i.r.p. at any elevation angle above 30 degrees as measured from the horizon must not exceed 125 mW (21 dBm).</p>
<input checked="" type="checkbox"/> Indoor access point	<p>The maximum conducted output power over the frequency band of operation shall not exceed 1 W (30dBm) provided the maximum antenna gain does not exceed 6 dBi. If transmitting antennas of directional gain greater than 6 dBi are used, both the maximum conducted output power and the maximum power spectral density shall be reduced by the amount in dB that the directional gain of the antenna exceeds 6 dBi.</p>
<input type="checkbox"/> Fixed point-to-point access points	<p>The maximum conducted output power over the frequency band of operation shall not exceed 1 W (30dBm). Fixed point-to-point U-NII devices may employ antennas with directional gain up to 23 dBi without any corresponding reduction in the maximum conducted output power or maximum power spectral density. For fixed point-to-point transmitters that employ a directional antenna gain greater than 23 dBi, a 1 dB reduction in maximum conducted output power and maximum power spectral density is required for each 1 dB of antenna gain in excess of 23 dBi.</p>
<input type="checkbox"/> Client devices	<p>The maximum conducted output power over the frequency band of operation shall not exceed 250 mW (24dBm) provided the maximum antenna gain does not exceed 6 dBi. If transmitting antennas of directional gain greater than 6 dBi are used, both the maximum conducted output power and the maximum power spectral density shall be reduced by the amount in dB that the directional gain of the antenna exceeds 6 dBi.</p>

☒	5.725~5.85 GHz	The maximum conducted output power over the frequency band of operation shall not exceed 1 W (30dBm). If transmitting antennas of directional gain greater than 6 dBi are used, both the maximum conducted output power and the maximum power spectral density shall be reduced by the amount in dB that the directional gain of the antenna exceeds 6 dBi. However, fixed point-to-point U-NII devices operating in this band may employ transmitting antennas with directional gain greater than 6 dBi without any corresponding reduction in transmitter conducted power.
---	----------------	--

#### 4.4.2. Measuring Instruments and Setting

Please refer to section 5 of equipments list in this report. The following table is the setting of the power meter.

Power Meter Parameter	Setting
Detector	AVERAGE

#### 4.4.3. Test Procedures

1. The transmitter output (antenna port) was connected to the power meter.
2. Test was performed in accordance with KDB789033 D02 v01r02 for Compliance Testing of Unlicensed National Information Infrastructure (U-NII) Devices - section (E) Maximum conducted output power =>3. Measurement using a Power Meter (PM) =>b) Method PM-G (Measurement using a gated RF average power meter).
3. Multiple antenna systems was performed in accordance with KDB662911 D01 v02r01 Emissions Testing of Transmitters with Multiple Outputs in the Same Band.
4. When measuring maximum conducted output power with multiple antenna systems,add every result of the values by mathematic formula.

#### 4.4.4. Test Setup Layout

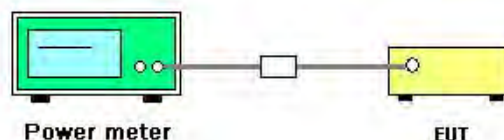

#### 4.4.5. Test Deviation

There is no deviation with the original standard.

#### 4.4.6. EUT Operation during Test

The EUT was programmed to be in continuously transmitting mode.



#### 4.4.7. Test Result of Maximum Conducted Output Power

Temperature	24°C	Humidity	60%
Test Engineer	Clemens Fang	Test Date	May 18, 2016~May 19, 2016

<For Non-Beamforming Mode>

Mode	Frequency	Conducted Power (dBm)					Max. Limit (dBm)	Result
		Chain 5	Chain 6	Chain 7	Chain 8	Total		
802.11a	5180 MHz	18.02	19.04	18.24	18.41	24.47	30.00	Complies
	5200 MHz	18.22	19.04	18.16	18.41	24.49	30.00	Complies
	5240 MHz	18.52	19.24	18.19	18.31	24.61	30.00	Complies
	5745 MHz	23.03	24.07	22.94	23.23	29.36	30.00	Complies
	5785 MHz	22.91	24.02	22.98	23.10	29.30	30.00	Complies
	5825 MHz	22.89	23.93	22.95	23.13	29.27	30.00	Complies
802.11ac MCS0/Nss1 VHT20	5180 MHz	17.86	18.99	17.91	18.21	24.29	30.00	Complies
	5200 MHz	17.91	18.87	18.10	18.35	24.34	30.00	Complies
	5240 MHz	18.12	18.82	17.88	18.34	24.32	30.00	Complies
	5745 MHz	22.86	23.87	22.76	23.02	29.17	30.00	Complies
	5785 MHz	22.67	23.99	22.66	22.75	29.08	30.00	Complies
	5825 MHz	22.74	23.53	22.84	22.96	29.05	30.00	Complies
802.11ac MCS0/Nss1 VHT40	5190 MHz	17.96	18.70	17.80	18.22	24.20	30.00	Complies
	5230 MHz	21.45	22.36	21.21	21.45	27.66	30.00	Complies
	5755 MHz	23.02	23.94	22.91	23.11	29.29	30.00	Complies
	5795 MHz	22.50	23.92	22.60	22.80	29.01	30.00	Complies
802.11ac MCS0/Nss1 VHT80	5210 MHz	15.01	15.84	14.93	15.36	21.32	30.00	Complies
	5775 MHz	15.40	16.45	15.66	15.68	21.84	30.00	Complies

#### 802.11ac MCS0/Nss2 VHT80+80

Type	Frequency	Conducted Power (dBm)					Max. Limit (dBm)	Result
		Chain 6	Chain 7	Chain 5	Chain 8	Total		
1	5210 MHz	18.86	19.79	-	-	22.36	30.00	Complies
	5775 MHz	-	-	19.28	19.24	22.27	30.00	Complies

**<For Beamforming Mode>**

Mode	Frequency	Conducted Power (dBm)					Max. Limit (dBm)	Result
		Chain 5	Chain 6	Chain 7	Chain 8	Total		
802.11ac MCS0/Nss1 VHT20	5180 MHz	18.46	18.34	18.12	17.67	24.18	24.33	Complies
	5200 MHz	18.19	18.41	17.97	17.66	24.09	24.33	Complies
	5240 MHz	18.09	18.12	18.39	17.88	24.14	24.33	Complies
	5745 MHz	18.91	18.06	17.62	18.02	24.20	24.33	Complies
	5785 MHz	18.78	18.44	17.29	17.82	24.14	24.33	Complies
	5825 MHz	18.91	18.43	17.50	18.17	24.30	24.33	Complies
802.11ac MCS0/Nss1 VHT40	5190 MHz	18.67	18.44	18.05	17.82	24.28	24.33	Complies
	5230 MHz	18.90	18.32	18.03	17.70	24.28	24.33	Complies
	5755 MHz	19.46	18.48	17.47	17.31	24.29	24.33	Complies
	5795 MHz	19.28	18.34	17.41	16.83	24.09	24.33	Complies
802.11ac MCS0/Nss1 VHT80	5210 MHz	17.05	17.16	16.50	17.10	22.98	24.33	Complies
	5775 MHz	18.48	18.82	17.76	17.44	24.18	24.33	Complies

Note:  $Directional\ Gain = 10 \log \left[ \frac{\sum_{j=1}^{N_{SS}} \left\{ \sum_{K=1}^{N_{ANT}} g_{j,k} \right\}^2}{N_{ANT}} \right] = 11.67\text{dBi} > 6\text{dBi}$ , so Limit =  $30 - (11.67 - 6) = 24.33\text{dBm}$ .

**802.11ac MCS0/Nss2 VHT80+80**

Type	Frequency	Conducted Power (dBm)					Max. Limit (dBm)	Result
		Chain 6	Chain 7	Chain 5	Chain 8	Total		
1	5210 MHz	15.86	16.77	-	-	19.35	27.34	Complies
	5775 MHz	-	-	16.69	16.54	19.63	27.34	Complies

Note:  $Directional\ Gain = 10 \log \left[ \frac{\sum_{j=1}^{N_{SS}} \left\{ \sum_{K=1}^{N_{ANT}} g_{j,k} \right\}^2}{N_{ANT}} \right] = 8.66\text{dBi} > 6\text{dBi}$ , so Limit =  $30 - (8.66 - 6) = 27.34\text{dBm}$ .

## 4.5. Power Spectral Density Measurement

### 4.5.1. Limit

The following table is power spectral density limits and decrease power density limit rule refer to section 4.4.1.

Frequency Band		Limit
<input type="checkbox"/>	5.15~5.25 GHz	
	Operating Mode	
<input type="checkbox"/>	Outdoor access point	17 dBm/MHz
<input checked="" type="checkbox"/>	Indoor access point	17 dBm/MHz
<input type="checkbox"/>	Fixed point-to-point access points	17 dBm/MHz
<input type="checkbox"/>	Mobile and portable client devices	11 dBm/MHz
<input checked="" type="checkbox"/>	5.725~5.85 GHz	30 dBm/500kHz

### 4.5.2. Measuring Instruments and Setting

Please refer to section 5 of equipments list in this report. The following table is the setting of the spectrum analyzer.

Spectrum Parameter	Setting
Attenuation	Auto
Span Frequency	Encompass the entire emissions bandwidth (EBW) of the signal
RBW	1000 kHz
VBW	3000 kHz
Detector	RMS
Trace	AVERAGE
Sweep Time	Auto
Trace Average	100 times
Note: If measurement bandwidth of Maximum PSD is specified in 500 kHz, add $10\log(500\text{kHz}/\text{RBW})$ to the measured result, whereas RBW (< 500 kHz) is the reduced resolution bandwidth of the spectrum analyzer set during measurement.	

#### 4.5.3. Test Procedures

1. The transmitter output (antenna port) was connected RF switch to the spectrum analyzer.
2. Test was performed in accordance with KDB789033 D02 v01r02 for Compliance Testing of Unlicensed National Information Infrastructure (U-NII) Devices - section (F) Maximum Power Spectral Density (PSD).
3. Multiple antenna systems was performed in accordance KDB662911 D01 v02r01 in-Band Power Spectral Density (PSD) Measurements and sum the spectra across the outputs.
4. For 5.725~5.85 GHz, the measured result of PSD level must add  $10\log(500\text{kHz}/\text{RBW})$  and the final result should  $\leq 30$  dBm.

#### 4.5.4. Test Setup Layout

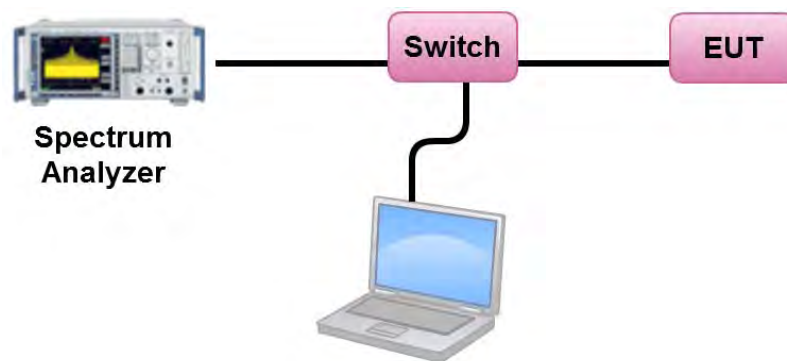

#### 4.5.5. Test Deviation

There is no deviation with the original standard.

#### 4.5.6. EUT Operation during Test

The EUT was programmed to be in continuously transmitting mode.

#### 4.5.7. Test Result of Power Spectral Density

Temperature	24°C	Humidity	60%
Test Engineer	Clemens Fang		

<For Non-Beamforming Mode>

Configuration IEEE 802.11a / Chain 5 + Chain 6 + Chain 7 + Chain 8

Channel	Frequency	Power Density (dBm/MHz)	Max. Limit (dBm/MHz)	Result
36	5180 MHz	11.11	11.33	Complies
40	5200 MHz	11.18	11.33	Complies
48	5240 MHz	11.28	11.33	Complies

Note:  $Directional\ Gain = 10\log\left[\frac{\sum_{j=1}^{N_{SS}}\left\{\sum_{K=1}^{N_{ANT}}g_{j,k}\right\}^2}{N_{ANT}}\right] = 11.67\text{dBi} > 6\text{dBi}$ , so Limit =  $17 - (11.67 - 6) = 11.33\text{dBm/MHz}$ .

Channel	Frequency	Power Density (dBm/MHz)	10log(500kHz/RBW) Factor (dB)	Power Density (dBm/500kHz)	Power Density Limit (dBm/500kHz)	Result
149	5745 MHz	16.03	-3.01	13.02	24.33	Complies
157	5785 MHz	15.96	-3.01	12.95	24.33	Complies
165	5825 MHz	15.94	-3.01	12.93	24.33	Complies

Note:  $Directional\ Gain = 10\log\left[\frac{\sum_{j=1}^{N_{SS}}\left\{\sum_{K=1}^{N_{ANT}}g_{j,k}\right\}^2}{N_{ANT}}\right] = 11.67\text{dBi} > 6\text{dBi}$ , so Limit =  $30 - (11.67 - 6) = 24.33\text{dBm/500kHz}$ .

Configuration IEEE 802.11ac MCS0/Nss1 VHT20 / Chain 5 + Chain 6 + Chain 7 + Chain 8

Channel	Frequency	Power Density (dBm/MHz)	Max. Limit (dBm/MHz)	Result
36	5180 MHz	10.98	11.33	Complies
40	5200 MHz	11.02	11.33	Complies
48	5240 MHz	11.01	11.33	Complies

Note:  $Directional\ Gain = 10\log\left[\frac{\sum_{j=1}^{N_{SS}}\left\{\sum_{K=1}^{N_{ANT}}g_{j,k}\right\}^2}{N_{ANT}}\right] = 11.67\text{dBi} > 6\text{dBi}$ , so Limit =  $17 - (11.67 - 6) = 11.33\text{dBm/MHz}$ .

Channel	Frequency	Power Density (dBm/MHz)	10log(500kHz/RBW) Factor (dB)	Power Density (dBm/500kHz)	Power Density Limit (dBm/500kHz)	Result
149	5745 MHz	15.89	-3.01	12.88	24.33	Complies
157	5785 MHz	15.74	-3.01	12.73	24.33	Complies
165	5825 MHz	15.73	-3.01	12.72	24.33	Complies

Note:  $Directional\ Gain = 10\log\left[\frac{\sum_{j=1}^{N_{SS}}\left\{\sum_{K=1}^{N_{ANT}}g_{j,k}\right\}^2}{N_{ANT}}\right] = 11.67\text{dBi} > 6\text{dBi}$ , so Limit =  $30 - (11.67 - 6) = 24.33\text{dBm}/500\text{kHz}$ .

#### Configuration IEEE 802.11ac MCS0/Nss1 VHT40 / Chain 5 + Chain 6 + Chain 7 + Chain 8

Channel	Frequency	Power Density (dBm/MHz)	Max. Limit (dBm/MHz)	Result
38	5190 MHz	7.94	11.33	Complies
46	5230 MHz	11.29	11.33	Complies

Note:  $Directional\ Gain = 10\log\left[\frac{\sum_{j=1}^{N_{SS}}\left\{\sum_{K=1}^{N_{ANT}}g_{j,k}\right\}^2}{N_{ANT}}\right] = 11.67\text{dBi} > 6\text{dBi}$ , so Limit =  $17 - (11.67 - 6) = 11.33\text{dBm}/\text{MHz}$ .

Channel	Frequency	Power Density (dBm/MHz)	10log(500kHz/RBW) Factor (dB)	Power Density (dBm/500kHz)	Power Density Limit (dBm/500kHz)	Result
151	5755 MHz	13.01	-3.01	10.00	24.33	Complies
159	5795 MHz	12.75	-3.01	9.74	24.33	Complies

Note:  $Directional\ Gain = 10\log\left[\frac{\sum_{j=1}^{N_{SS}}\left\{\sum_{K=1}^{N_{ANT}}g_{j,k}\right\}^2}{N_{ANT}}\right] = 11.67\text{dBi} > 6\text{dBi}$ , so Limit =  $30 - (11.67 - 6) = 24.33\text{dBm}/500\text{kHz}$ .

#### Configuration IEEE 802.11ac MCS0/Nss1 VHT80 / Chain 5 + Chain 6 + Chain 7 + Chain 8

Channel	Frequency	Power Density (dBm/MHz)	Max. Limit (dBm/MHz)	Result
42	5210 MHz	2.16	11.33	Complies

Note:  $Directional\ Gain = 10\log\left[\frac{\sum_{j=1}^{N_{SS}}\left\{\sum_{K=1}^{N_{ANT}}g_{j,k}\right\}^2}{N_{ANT}}\right] = 11.67\text{dBi} > 6\text{dBi}$ , so Limit =  $17 - (11.67 - 6) = 11.33\text{dBm}/\text{MHz}$ .

Channel	Frequency	Power Density (dBm/MHz)	10log(500kHz/RBW) Factor (dB)	Power Density (dBm/500kHz)	Power Density Limit (dBm/500kHz)	Result
155	5775 MHz	2.65	-3.01	-0.36	24.33	Complies

Note:  $Directional\ Gain = 10 \log \left[ \frac{\sum_{j=1}^{N_{SS}} \left\{ \sum_{K=1}^{N_{ANT}} g_{j,k} \right\}^2}{N_{ANT}} \right] = 11.67\text{dBi} > 6\text{dBi}$ , so Limit =  $30 - (11.67 - 6) = 24.33\text{dBm}/500\text{kHz}$ .

### 802.11ac MCS0/Nss2 VHT80+80

Type	Frequency	Power Density (dBm/MHz)	10log(500kHz/RBW) Factor (dB)	Power Density (dBm/500kHz)	Power Density Limit (dBm/500kHz)	Max. Limit (dBm/MHz)	Result
1	5210 MHz	3.28	-			14.34	Complies
	5775 MHz	2.81	-3.01	-0.20	27.34	-	Complies

Note:

For Band 1:

$$Directional\ Gain = 10 \log \left[ \frac{\sum_{j=1}^{N_{SS}} \left\{ \sum_{K=1}^{N_{ANT}} g_{j,k} \right\}^2}{N_{ANT}} \right] = 8.66\text{dBi} > 6\text{dBi}$$
, so Limit =  $17 - (8.66 - 6) = 14.34\text{dBm}/\text{MHz}$ .

For Band 4:

$$Directional\ Gain = 10 \log \left[ \frac{\sum_{j=1}^{N_{SS}} \left\{ \sum_{K=1}^{N_{ANT}} g_{j,k} \right\}^2}{N_{ANT}} \right] = 8.66\text{dBi} > 6\text{dBi}$$
, so Limit =  $30 - (8.66 - 6) = 27.34\text{dBm}/500\text{kHz}$ .

<For Beamforming Mode>

Configuration IEEE 802.11ac MCS0/Nss1 VHT20 / Chain 5 + Chain 6 + Chain 7 + Chain 8

Channel	Frequency	Power Density (dBm/MHz)	Max. Limit (dBm/MHz)	Result
36	5180 MHz	10.94	11.33	Complies
40	5200 MHz	10.79	11.33	Complies
48	5240 MHz	10.83	11.33	Complies

Note:  $Directional\ Gain = 10\log\left[\frac{\sum_{j=1}^{N_{SS}}\left\{\sum_{K=1}^{N_{ANT}}g_{j,k}\right\}^2}{N_{ANT}}\right] = 11.67\text{dBi} > 6\text{dBi}$ , so Limit =  $17 - (11.67 - 6) = 11.33\text{dBm/MHz}$ .

Channel	Frequency	Power Density (dBm/MHz)	10log(500kHz/RBW) Factor (dB)	Power Density (dBm/500kHz)	Power Density Limit (dBm/500kHz)	Result
149	5745 MHz	10.92	-3.01	7.91	24.33	Complies
157	5785 MHz	10.83	-3.01	7.82	24.33	Complies
165	5825 MHz	11.12	-3.01	8.11	24.33	Complies

Note:  $Directional\ Gain = 10\log\left[\frac{\sum_{j=1}^{N_{SS}}\left\{\sum_{K=1}^{N_{ANT}}g_{j,k}\right\}^2}{N_{ANT}}\right] = 11.67\text{dBi} > 6\text{dBi}$ , so Limit =  $30 - (11.67 - 6) = 24.33\text{dBm/500kHz}$ .

Configuration IEEE 802.11ac MCS0/Nss1 VHT40 / Chain 5 + Chain 6 + Chain 7 + Chain 8

Channel	Frequency	Power Density (dBm/MHz)	Max. Limit (dBm/MHz)	Result
38	5190 MHz	7.92	11.33	Complies
46	5230 MHz	8.03	11.33	Complies

Note:  $Directional\ Gain = 10\log\left[\frac{\sum_{j=1}^{N_{SS}}\left\{\sum_{K=1}^{N_{ANT}}g_{j,k}\right\}^2}{N_{ANT}}\right] = 11.67\text{dBi} > 6\text{dBi}$ , so Limit =  $17 - (11.67 - 6) = 11.33\text{dBm/MHz}$ .

Channel	Frequency	Power Density (dBm/MHz)	10log(500kHz/RBW) Factor (dB)	Power Density (dBm/500kHz)	Power Density Limit (dBm/500kHz)	Result
151	5755 MHz	8.07	-3.01	5.06	24.33	Complies
159	5795 MHz	7.70	-3.01	4.69	24.33	Complies

Note:  $Directional\ Gain = 10\log\left[\frac{\sum_{j=1}^{N_{SS}}\left\{\sum_{K=1}^{N_{ANT}}g_{j,k}\right\}^2}{N_{ANT}}\right] = 11.67\text{dBi} > 6\text{dBi}$ , so Limit =  $30 - (11.67 - 6) = 24.33\text{dBm/500kHz}$ .



**Configuration IEEE 802.11ac MCS0/Nss1 VHT80 / Chain 5 + Chain 6 + Chain 7 + Chain 8**

Channel	Frequency	Power Density (dBm/MHz)	Max. Limit (dBm/MHz)	Result
42	5210 MHz	3.65	11.33	Complies

Note:  $Directional\ Gain = 10\log\left[\frac{\sum_{j=1}^{N_{SS}}\left\{\sum_{K=1}^{N_{ANT}}g_{j,k}\right\}^2}{N_{ANT}}\right] = 11.67\text{dBi} > 6\text{dBi}$ , so Limit =  $17 - (11.67 - 6) = 11.33\text{dBm/MHz}$ .

Channel	Frequency	Power Density (dBm/MHz)	10log(500kHz/RBW) Factor (dB)	Power Density (dBm/500kHz)	Power Density Limit (dBm/500kHz)	Result
155	5775 MHz	4.86	-3.01	1.85	24.33	Complies

Note:  $Directional\ Gain = 10\log\left[\frac{\sum_{j=1}^{N_{SS}}\left\{\sum_{K=1}^{N_{ANT}}g_{j,k}\right\}^2}{N_{ANT}}\right] = 11.67\text{dBi} > 6\text{dBi}$ , so Limit =  $30 - (11.67 - 6) = 24.33\text{dBm/500kHz}$ .

**802.11ac MCS0/Nss2 VHT80+80**

Type	Frequency	Power Density (dBm/MHz)	10log(500kHz/RBW) Factor (dB)	Power Density (dBm/500kHz)	Power Density Limit (dBm/500kHz)	Max. Limit (dBm/MHz)	Result
1	5210 MHz	0.25	-	-	-	14.34	Complies
	5775 MHz	0.56	-3.01	-2.45	27.34	-	Complies

Note:

For Band 1:

$$Directional\ Gain = 10\log\left[\frac{\sum_{j=1}^{N_{SS}}\left\{\sum_{K=1}^{N_{ANT}}g_{j,k}\right\}^2}{N_{ANT}}\right] = 8.66\text{dBi} > 6\text{dBi}$$
, so Limit =  $17 - (8.66 - 6) = 14.34\text{dBm/MHz}$ .

For Band 4:

$$Directional\ Gain = 10\log\left[\frac{\sum_{j=1}^{N_{SS}}\left\{\sum_{K=1}^{N_{ANT}}g_{j,k}\right\}^2}{N_{ANT}}\right] = 8.66\text{dBi} > 6\text{dBi}$$
, so Limit =  $30 - (8.66 - 6) = 27.34\text{dBm/500kHz}$ .

Note: All the test values were listed in the report.

For plots, only the channel with worse result was shown.

<For Non-Beamforming Mode>

Power Density Plot on Configuration IEEE 802.11a / Chain 5 + Chain 6 + Chain 7 + Chain 8 / 5240 MHz

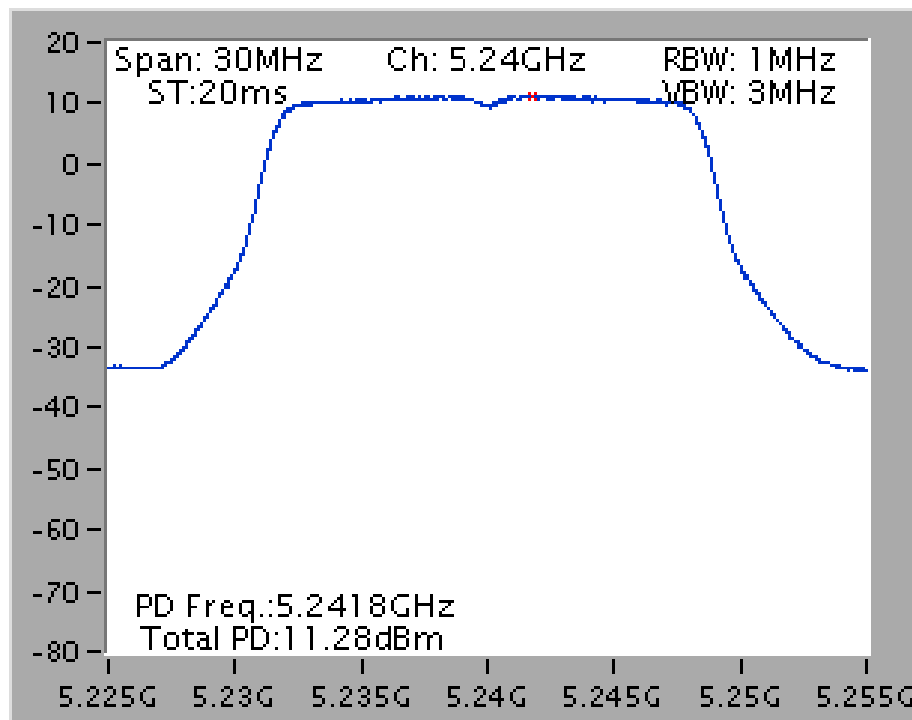

Power Density Plot on Configuration IEEE 802.11a / Chain 5 + Chain 6 + Chain 7 + Chain 8 / 5745 MHz

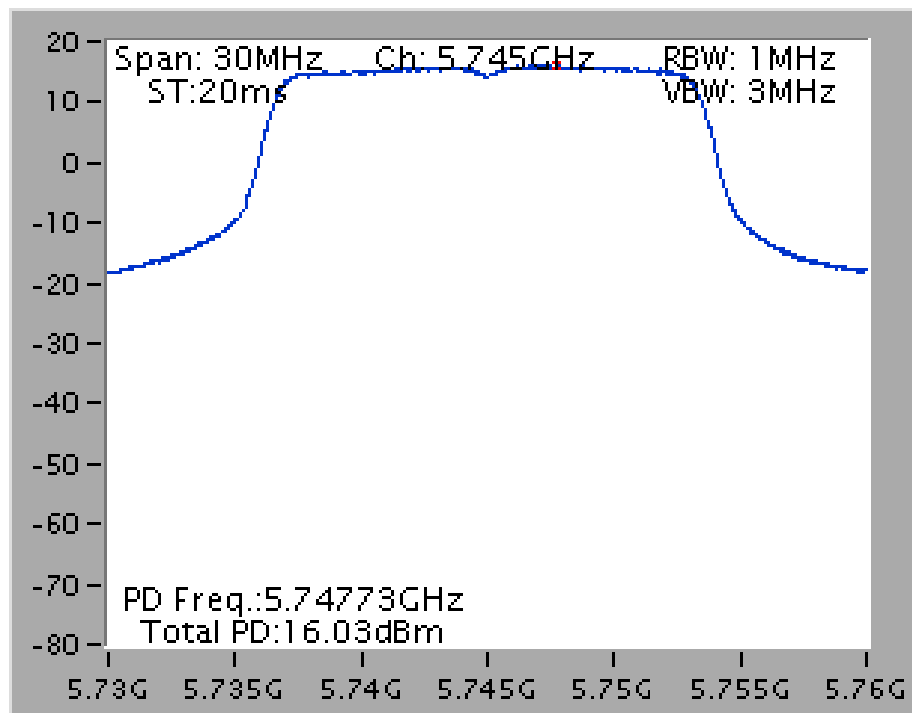

**Power Density Plot on Configuration IEEE 802.11ac MCS0/Nss1 VHT20 / Chain 5 + Chain 6 + Chain 7 + Chain 8 / 5200 MHz**

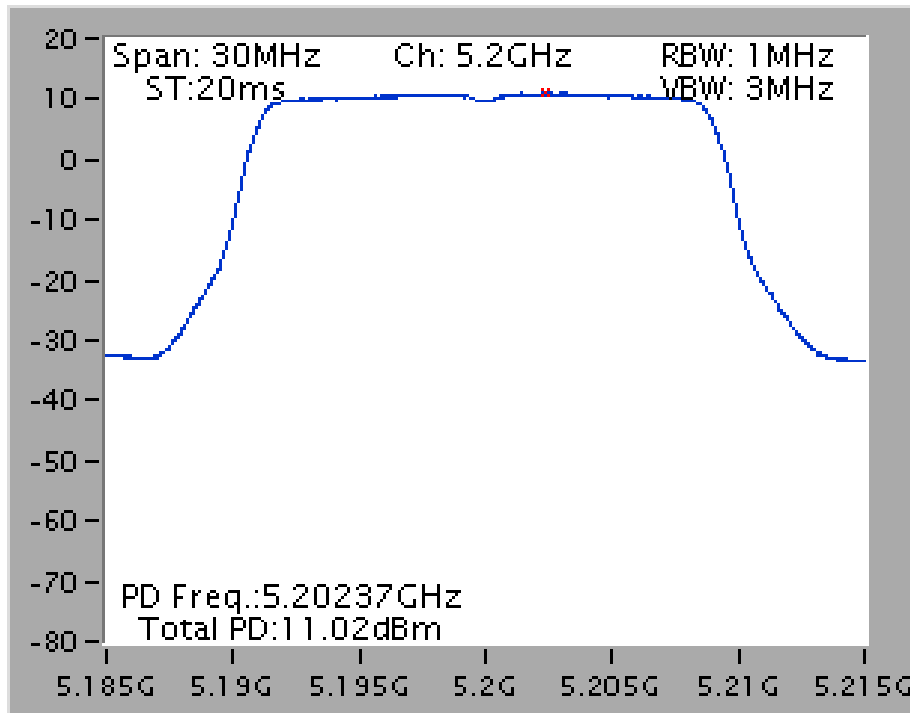

**Power Density Plot on Configuration IEEE 802.11ac MCS0/Nss1 VHT20 / Chain 1 + Chain 2 + Chain 3 / 5745 MHz**

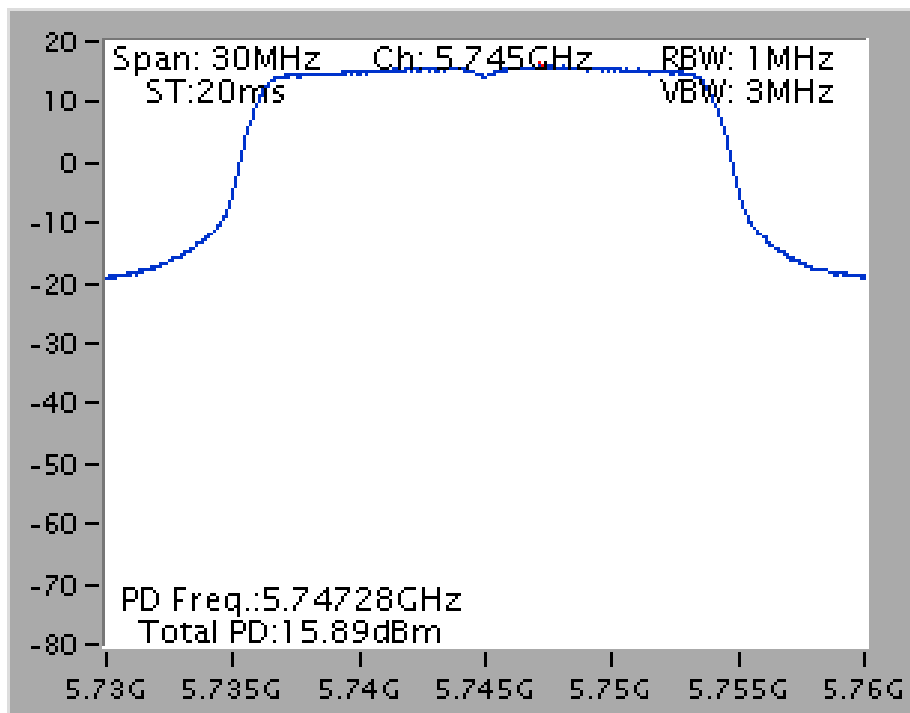

Power Density Plot on Configuration IEEE 802.11ac MCS0/Nss1 VHT40 / Chain 1 + Chain 2 + Chain 3 /  
5230 MHz

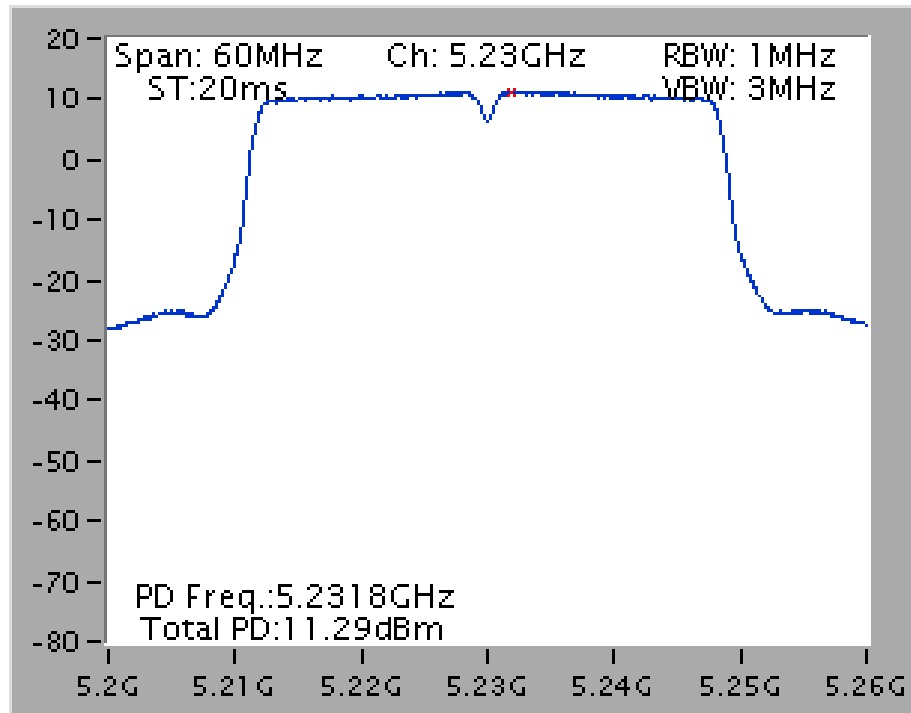

Power Density Plot on Configuration IEEE 802.11ac MCS0/Nss1 VHT40 / Chain 1 + Chain 2 + Chain 3 /  
5755 MHz

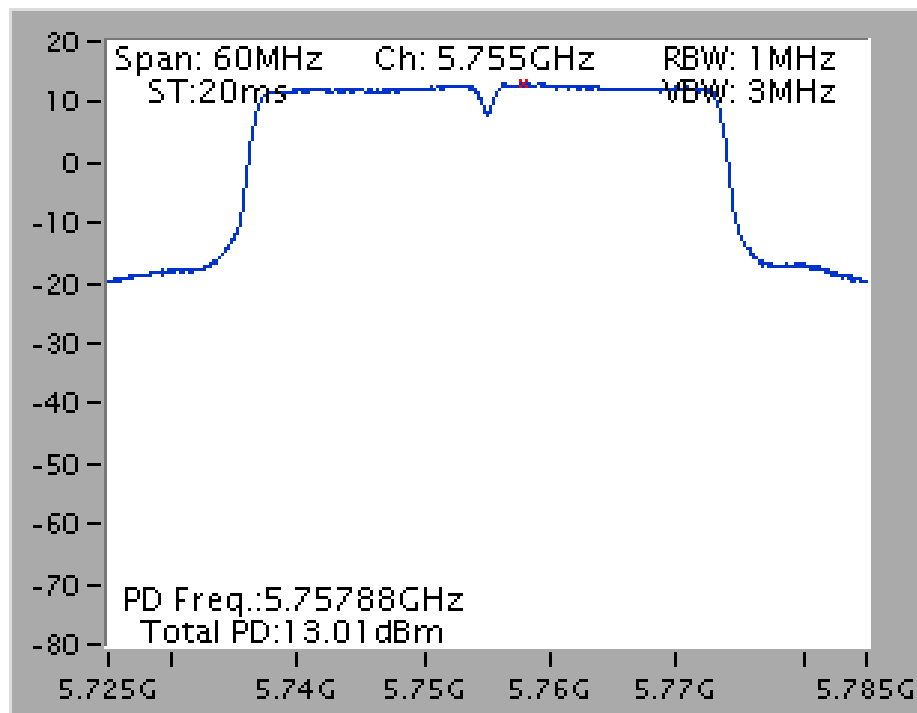

Power Density Plot on Configuration IEEE 802.11ac MCS0/Nss1 VHT80 / Chain 1 + Chain 2 + Chain 3 /  
5210 MHz

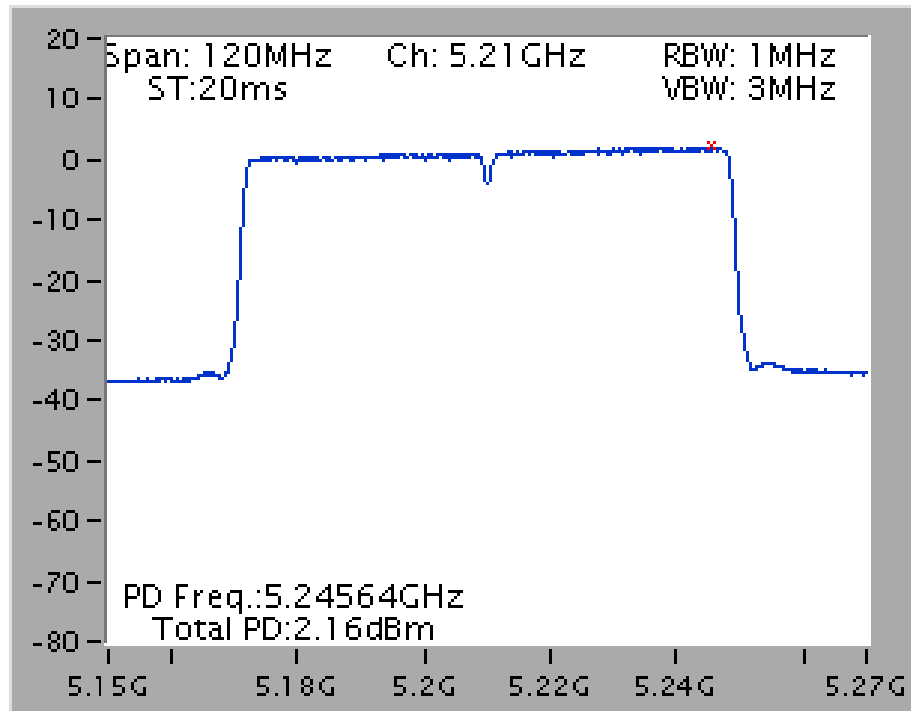

Power Density Plot on Configuration IEEE 802.11ac MCS0/Nss1 VHT80 / Chain 1 + Chain 2 + Chain 3 /  
5775 MHz

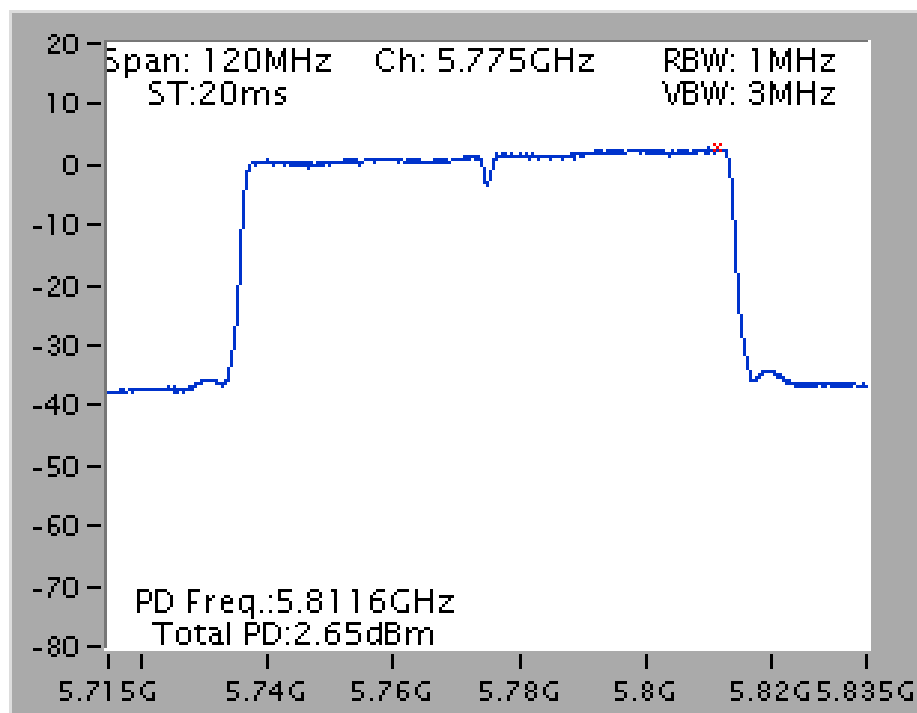

## 802.11ac MCS0/Nss2 VHT80+80

Type 1

## Power Density Plot on Chain 6 + Chain 7 / 5210 MHz

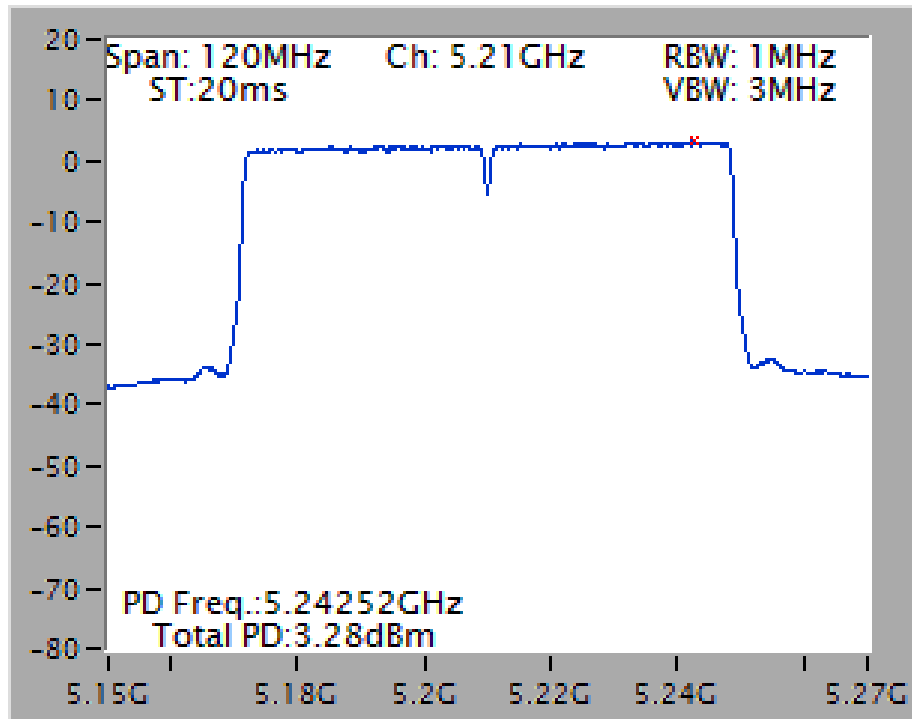

## Power Density Plot on Chain 5 + Chain 8 / 5775 MHz

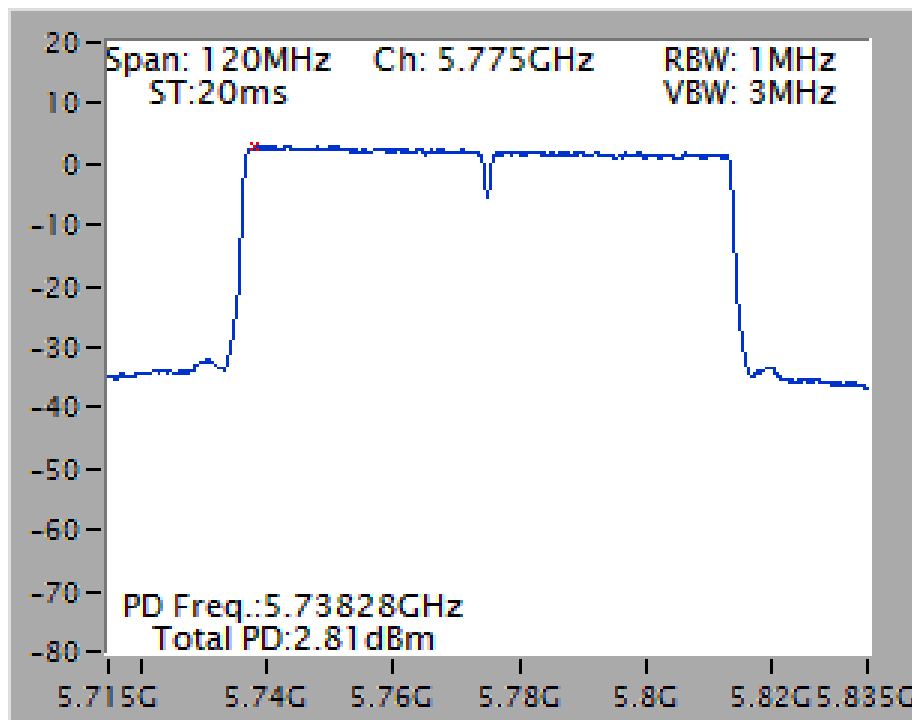

<For Beamforming Mode>

Power Density Plot on Configuration IEEE 802.11ac MCS0/Nss1 VHT20 / Chain 5 + Chain 6 + Chain 7 + Chain 8 / 5180 MHz

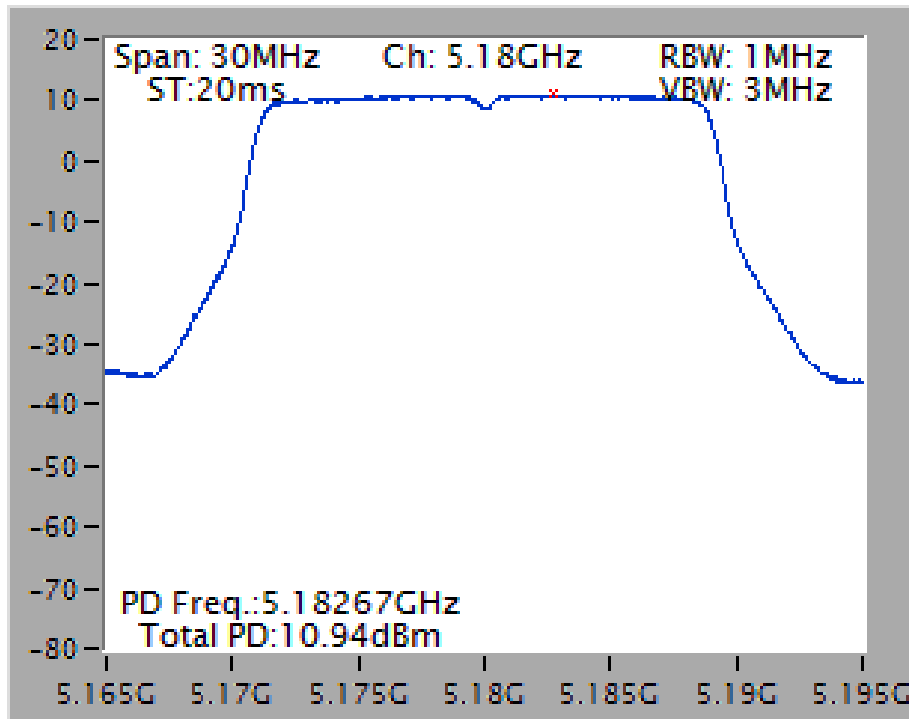

Power Density Plot on Configuration IEEE 802.11ac MCS0/Nss1 VHT20 / Chain 1 + Chain 2 + Chain 3 / 5825 MHz

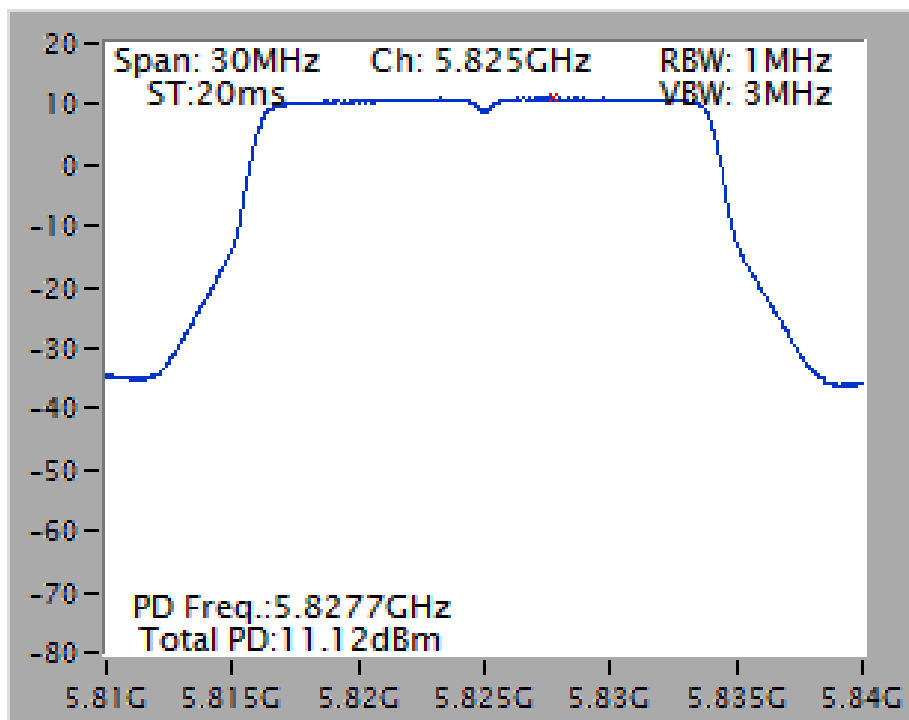

Power Density Plot on Configuration IEEE 802.11ac MCS0/Nss1 VHT40 / Chain 1 + Chain 2 + Chain 3 /  
5230 MHz

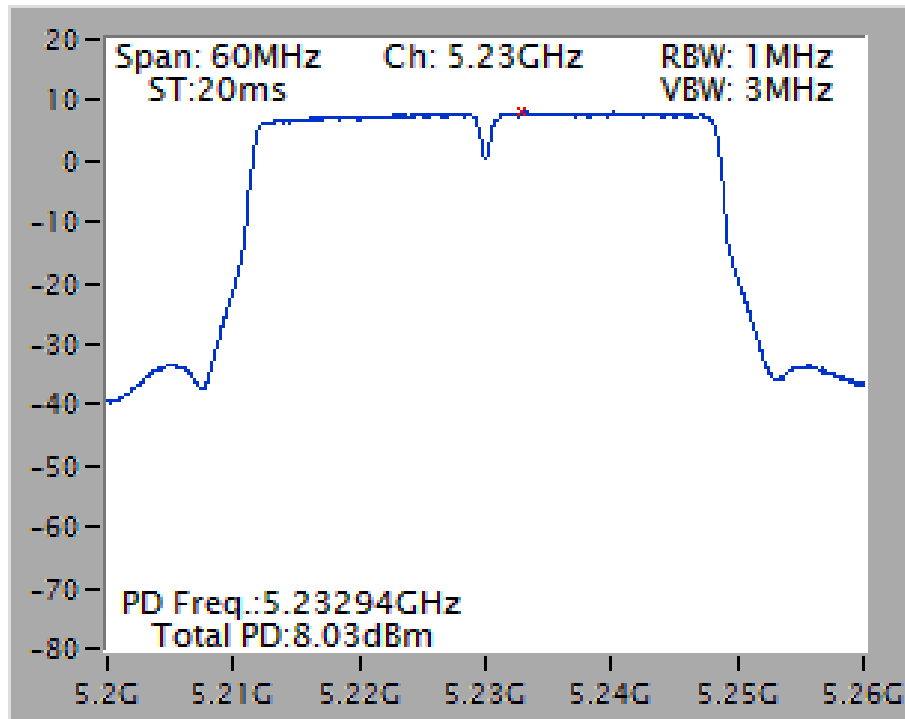

Power Density Plot on Configuration IEEE 802.11ac MCS0/Nss1 VHT40 / Chain 1 + Chain 2 + Chain 3 /  
5755 MHz

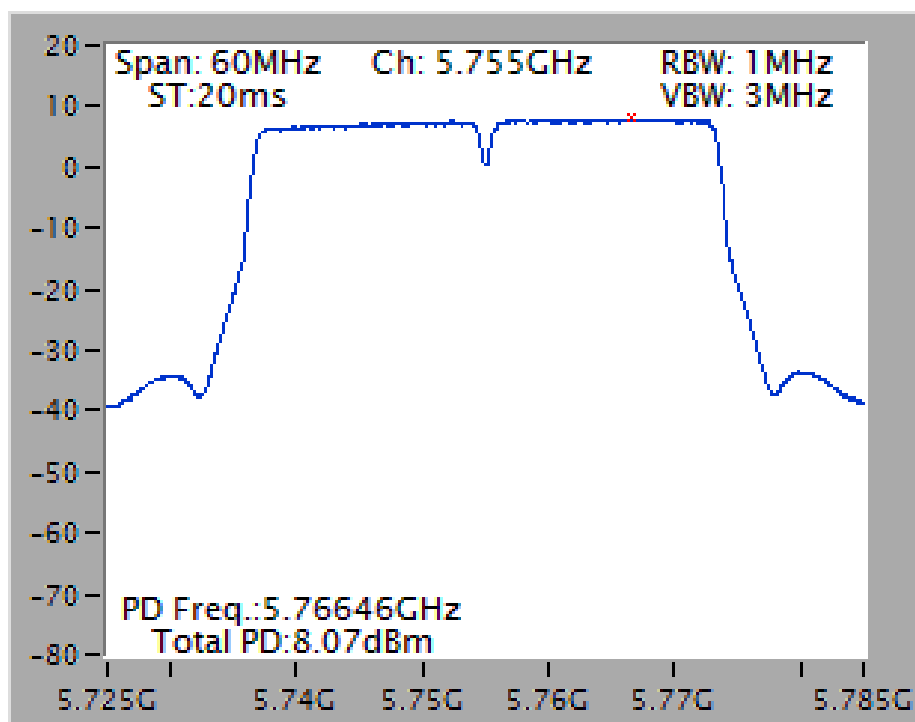



Power Density Plot on Configuration IEEE 802.11ac MCS0/Nss1 VHT80 / Chain 1 + Chain 2 + Chain 3 /  
5210 MHz

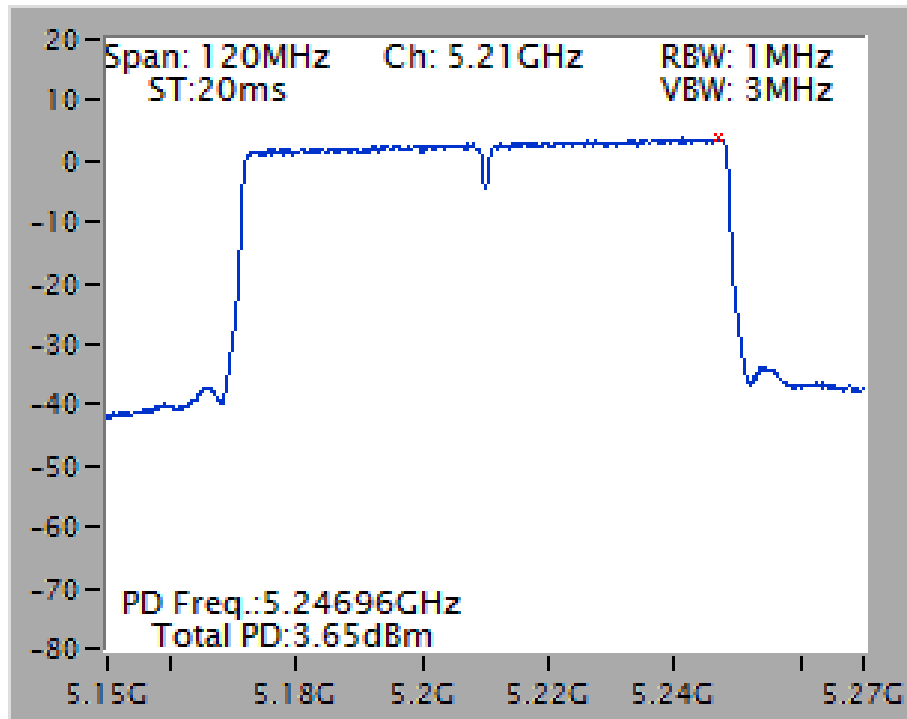

Power Density Plot on Configuration IEEE 802.11ac MCS0/Nss1 VHT80 / Chain 1 + Chain 2 + Chain 3 /  
5775 MHz

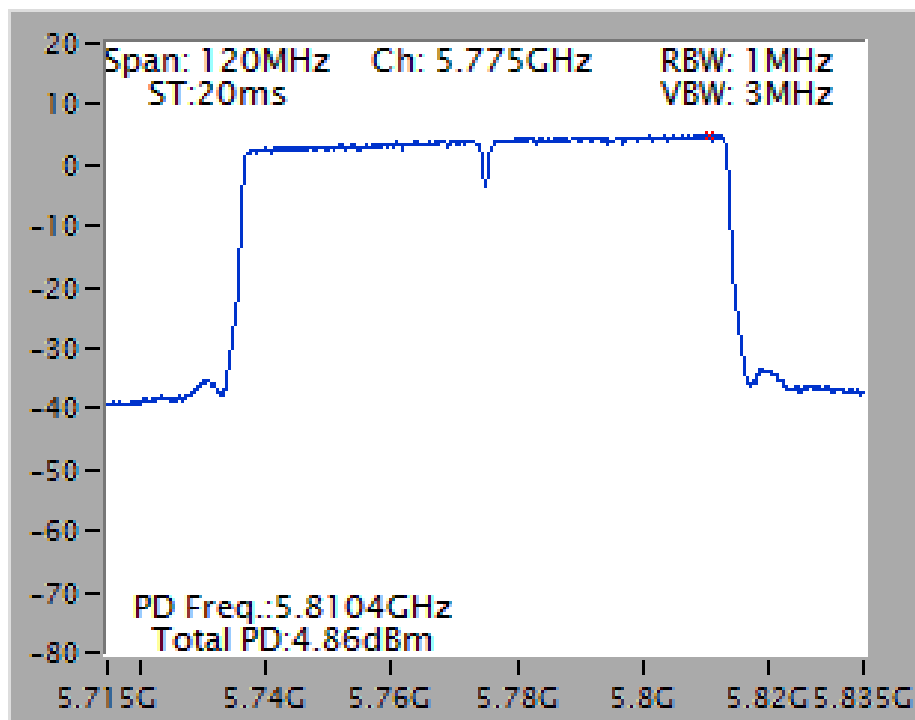

802.11ac MCS0/Nss2 VHT80+80

Type 1

Power Density Plot on Chain 6 + Chain 7 / 5210 MHz

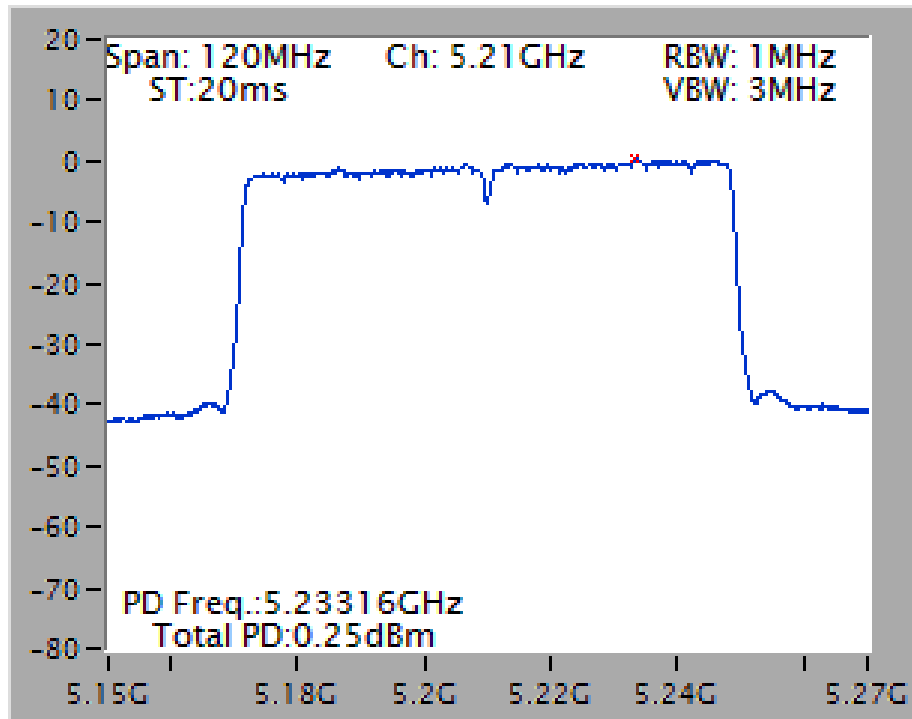

Power Density Plot on Chain 5 + Chain 8 / 5775 MHz

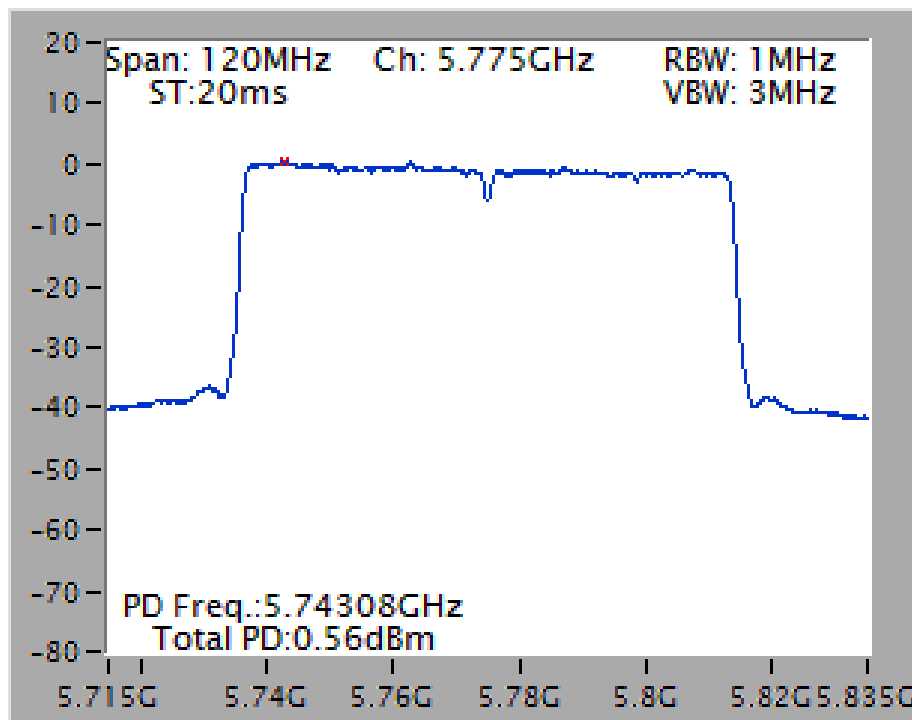

## 4.6. Radiated Emissions Measurement

### 4.6.1. Limit

For transmitters operating in the 5.15-5.25 GHz band: all emissions outside of the 5.15-5.25 GHz band shall not exceed an e.i.r.p. of  $-27$  dBm/MHz.

For transmitters operating in the 5.725-5.85 GHz band: all emissions shall be limited to a level of  $-27$  dBm/MHz at 75 MHz or more above or below the band edge increasing linearly to 10 dBm/MHz at 25 MHz above or below the band edge, and from 25 MHz above or below the band edge increasing linearly to a level of 15.6 dBm/MHz at 5 MHz above or below the band edge, and from 5 MHz above or below the band edge increasing linearly to a level of 27 dBm/MHz at the band edge.

In addition, In case the emission fall within the restricted band specified on 15.205(a), then the 15.209(a) limit in the table below has to be followed.

Frequencies (MHz)	Field Strength (micovolts/meter)	Measurement Distance (meters)
0.009~0.490	2400/F(kHz)	300
0.490~1.705	24000/F(kHz)	30
1.705~30.0	30	30
30~88	100	3
88~216	150	3
216~960	200	3
Above 960	500	3

### 4.6.2. Measuring Instruments and Setting

Please refer to section 5 of equipments list in this report. The following table is the setting of spectrum analyzer and receiver.

Spectrum Parameter	Setting
Attenuation	Auto
Start Frequency	1000 MHz
Stop Frequency	40 GHz
RBW / VBW (Emission in restricted band)	1 MHz / 3MHz for Peak, 1 MHz / 1/T for Average
RBW / VBW (Emission in non-restricted band)	1 MHz / 3MHz for peak

Receiver Parameter	Setting
Attenuation	Auto
Start ~ Stop Frequency	9kHz~150kHz / RBW 200Hz for QP
Start ~ Stop Frequency	150kHz~30MHz / RBW 9kHz for QP
Start ~ Stop Frequency	30MHz~1000MHz / RBW 120kHz for QP

#### 4.6.3. Test Procedures

1. Configure the EUT according to ANSI C63.10. The EUT was placed on the top of the turntable 1.5 meter above ground. The phase center of the receiving antenna mounted on the top of a height-variable antenna tower was placed 1m & 3m far away from the turntable.
2. Power on the EUT and all the supporting units. The turntable was rotated by 360 degrees to determine the position of the highest radiation.
3. The height of the broadband receiving antenna was varied between one meter and four meters above ground to find the maximum emissions field strength of both horizontal and vertical polarization.
4. For each suspected emissions, the antenna tower was scan (from 1 M to 4 M) and then the turntable was rotated (from 0 degree to 360 degrees) to find the maximum reading.
5. Set the test-receiver system to Peak or CISPR quasi-peak Detect Function with specified bandwidth under Maximum Hold Mode.
6. For emissions above 1GHz, use 1MHz VBW and 3MHz RBW for peak reading. Then 1MHz RBW and 1/T VBW for average reading in spectrum analyzer.
7. If the emissions level of the EUT in peak mode was 3 dB lower than the average limit specified, then testing will be stopped and peak values of EUT will be reported, otherwise, the emissions which do not have 3 dB margin will be repeated one by one using the quasi-peak method for below 1GHz.
8. For testing above 1GHz, the emissions level of the EUT in peak mode was lower than average limit (that means the emissions level in peak mode also complies with the limit in average mode), then testing will be stopped and peak values of EUT will be reported, otherwise, the emissions will be measured in average mode again and reported.
9. In case the emission is lower than 30MHz, loop antenna has to be used for measurement and the recorded data should be QP measured by receiver. High – Low scan is not required in this case.

#### 4.6.4. Test Setup Layout

For Radiated Emissions: 9kHz ~30MHz

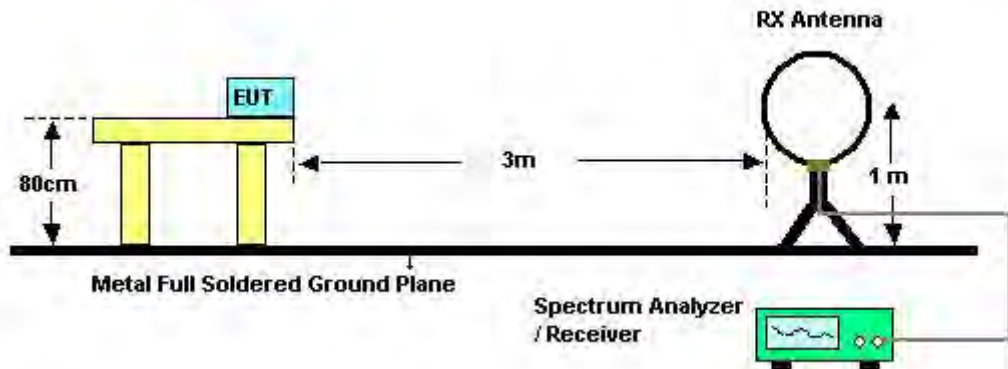

For Radiated Emissions: 30MHz~1GHz

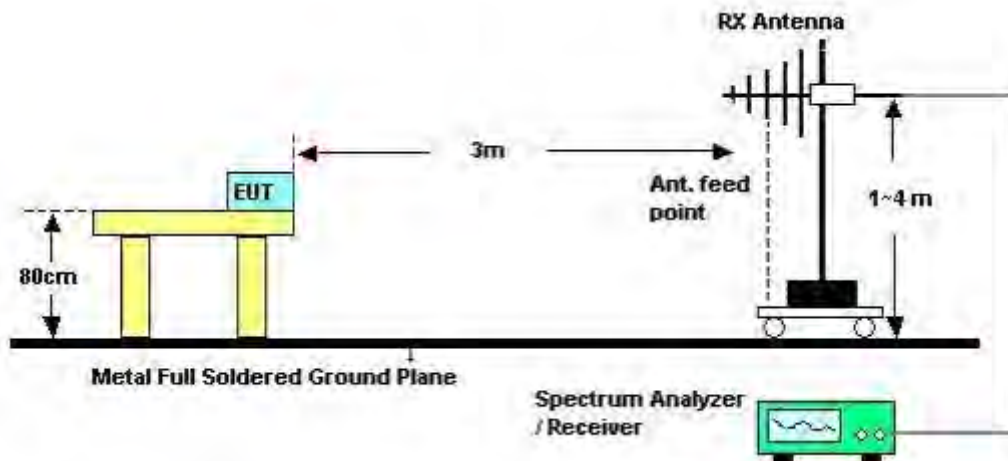

For Radiated Emissions: Above 1GHz

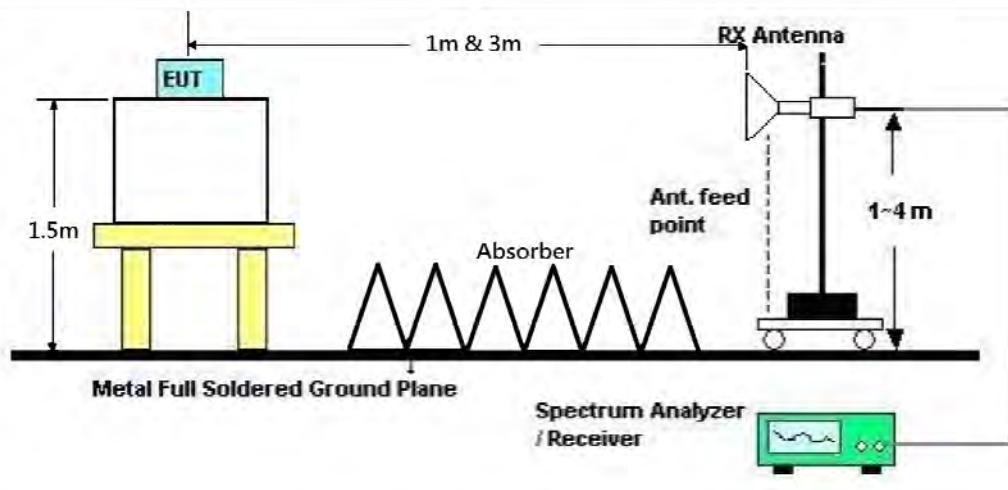

#### 4.6.5. Test Deviation

There is no deviation with the original standard.

#### 4.6.6. EUT Operation during Test

##### <For Non-Beamforming Mode>

The EUT was programmed to be in continuously transmitting mode.

##### <For Beamforming Mode>

The EUT was programmed to be in beamforming transmitting mode.

#### 4.6.7. Results of Radiated Emissions (9kHz~30MHz)

<b>Temperature</b>	23°C	<b>Humidity</b>	55%
<b>Test Engineer</b>	DK Chang	<b>Configurations</b>	Normal Link
<b>Test Date</b>	Apr. 18, 2016	<b>Test Mode</b>	Mode 2

<b>Freq. (MHz)</b>	<b>Level (dBuV)</b>	<b>Over Limit (dB)</b>	<b>Limit Line (dBuV)</b>	<b>Remark</b>
-	-	-	-	See Note

Note:

The amplitude of spurious emissions that are attenuated by more than 20dB below the permissible value has no need to be reported.

Distance extrapolation factor =  $40 \log(\text{specific distance} / \text{test distance})$  (dB);

Limit line = specific limits (dBuV) + distance extrapolation factor.

4.6.8. Results of Radiated Emissions (30MHz~1GHz)

Temperature	23°C	Humidity	55%
Test Engineer	DK Chang	Configurations	Normal Link
Test Mode	Mode 2		

Horizontal

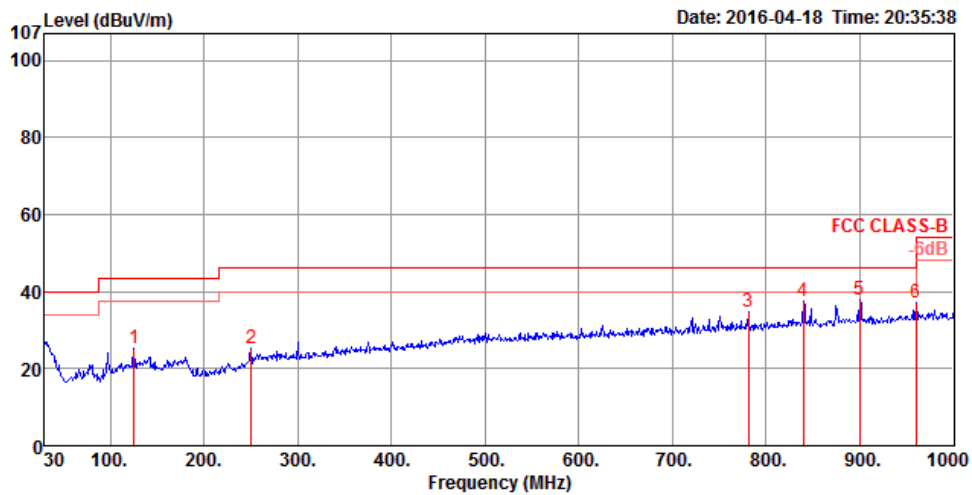

	Freq	Level	Limit	Over	Read	CableAntenna	Preamp	A/Pos	T/Pos	Remark	Pol/Phase
	MHz	dBuV/m	dBuV/m	dB	dBuV	dB	dB/m	dB	cm	deg	
1	125.06	25.17	43.50	-18.33	38.48	1.10	18.15	32.56	150	227 Peak	HORIZONTAL
2	250.19	25.32	46.00	-20.68	37.69	1.56	18.60	32.53	125	219 Peak	HORIZONTAL
3	780.78	34.55	46.00	-11.45	37.84	2.73	26.41	32.43	125	118 Peak	HORIZONTAL
4	839.95	37.53	46.00	-8.47	39.90	2.82	26.99	32.18	150	59 Peak	HORIZONTAL
5	900.09	38.00	46.00	-8.00	39.42	2.94	27.50	31.86	200	125 Peak	HORIZONTAL
6	960.00	36.96	46.00	-9.04	37.36	3.06	27.86	31.32	200	136 Peak	HORIZONTAL



**Vertical**

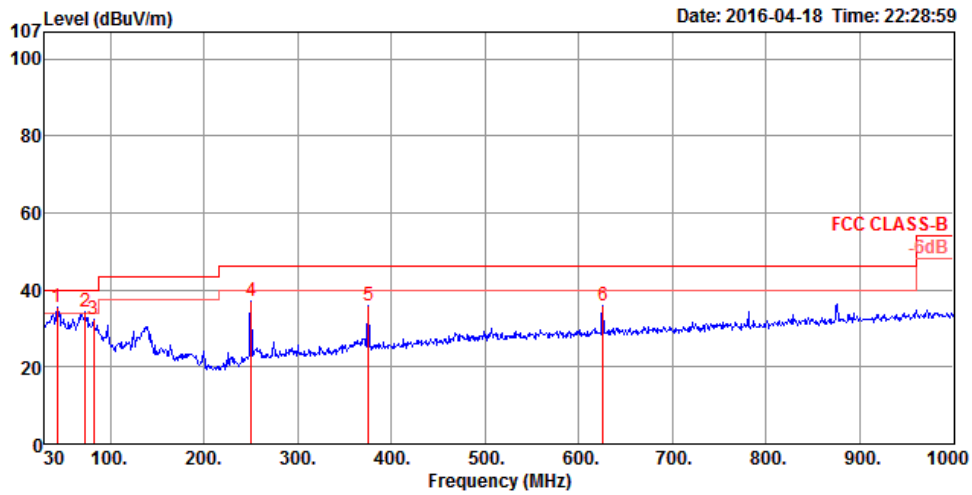

	Freq	Level	Limit	Over	Read	CableAntenna	Preamp	A/Pos	T/Pos	Remark	Pol/Phase
	MHz	dBuV/m	dBuV/m	dB	dBuV	dB	dB/m	dB	cm	deg	
1	43.58	35.55	40.00	-4.45	50.06	0.67	17.45	32.63	100	359 Peak	VERTICAL
2	73.65	34.37	40.00	-5.63	53.52	0.86	12.59	32.60	125	184 Peak	VERTICAL
3	82.38	32.39	40.00	-7.61	50.56	0.91	13.51	32.59	125	124 Peak	VERTICAL
4	250.19	37.31	46.00	-8.69	49.68	1.56	18.60	32.53	125	273 Peak	VERTICAL
5	375.32	35.77	46.00	-10.23	44.78	1.90	21.63	32.54	150	309 Peak	VERTICAL
6	625.58	35.86	46.00	-10.14	41.03	2.44	25.06	32.67	125	323 Peak	VERTICAL

**Note:**

The amplitude of spurious emissions that are attenuated by more than 20dB below the permissible value has no need to be reported.

Emission level (dBuV/m) = 20 log Emission level (uV/m).

Corrected Reading: Antenna Factor + Cable Loss + Read Level - Preamp Factor = Level.

#### 4.6.9. Results for Radiated Emissions (1GHz~40GHz)

<For Non-Beamforming Mode>

<b>Temperature</b>	23°C	<b>Humidity</b>	55%
<b>Test Engineer</b>	Brian Sun/Andy Tsai/DK Chang/Gary Chu/Ron Huang	<b>Configurations</b>	IEEE 802.11a CH 36 / Chain 5 + Chain 6 + Chain 7 + Chain 8
<b>Test Date</b>	Apr. 26, 2016		

##### Horizontal

	Freq	Level	Limit Line	Over Limit	Read Level	Cable Loss	Antenna Factor	Preamp Factor	A/Pos	T/Pos	Remark	Pol/Phase
	MHz	dBuV/m	dBuV/m	dB	dBuV	dB	dB/m	dB	cm	deg		
1	15536.14	60.17	74.00	-13.83	43.49	12.28	38.13	33.73	200	214	Peak	HORIZONTAL
2	15537.96	47.29	54.00	-6.71	30.61	12.28	38.13	33.73	200	214	Average	HORIZONTAL

##### Vertical

	Freq	Level	Limit Line	Over Limit	Read Level	Cable Loss	Antenna Factor	Preamp Factor	A/Pos	T/Pos	Remark	Pol/Phase
	MHz	dBuV/m	dBuV/m	dB	dBuV	dB	dB/m	dB	cm	deg		
1	15536.80	60.09	74.00	-13.91	43.41	12.28	38.13	33.73	200	256	Peak	VERTICAL
2	15542.56	47.25	54.00	-6.75	30.57	12.28	38.13	33.73	200	256	Average	VERTICAL

<b>Temperature</b>	23°C	<b>Humidity</b>	55%
<b>Test Engineer</b>	Brian Sun/Andy Tsai/DK Chang/Gary Chu/Ron Huang	<b>Configurations</b>	IEEE 802.11a CH 40 / Chain 5 + Chain 6 + Chain 7 + Chain 8
<b>Test Date</b>	Apr. 26, 2016		

### Horizontal

	Freq	Level	Limit Line	Over Limit	Read Level	Cable Loss	Antenna Factor	Preamp Factor	A/Pos	T/Pos	Remark	Pol/Phase
	MHz	dBuV/m	dBuV/m	dB	dBuV	dB	dB/m	dB	cm	deg		
1	15604.08	46.85	54.00	-7.15	30.33	12.31	37.98	33.77	200	143	Average	HORIZONTAL
2	15604.90	59.50	74.00	-14.50	42.98	12.31	37.98	33.77	200	143	Peak	HORIZONTAL

### Vertical

	Freq	Level	Limit Line	Over Limit	Read Level	Cable Loss	Antenna Factor	Preamp Factor	A/Pos	T/Pos	Remark	Pol/Phase
	MHz	dBuV/m	dBuV/m	dB	dBuV	dB	dB/m	dB	cm	deg		
1	15600.54	60.06	74.00	-13.94	43.54	12.31	37.98	33.77	200	296	Peak	VERTICAL
2	15602.48	47.00	54.00	-7.00	30.48	12.31	37.98	33.77	200	296	Average	VERTICAL

<b>Temperature</b>	23°C	<b>Humidity</b>	55%
<b>Test Engineer</b>	Brian Sun/Andy Tsai/DK Chang/Gary Chu/Ron Huang	<b>Configurations</b>	IEEE 802.11a CH 48 / Chain 5 + Chain 6 + Chain 7 + Chain 8
<b>Test Date</b>	Apr. 26, 2016		

### Horizontal

	Freq	Level	Limit Line	Over Limit	Read Level	Cable Loss	Antenna Factor	Preamp Factor	A/Pos	T/Pos	Remark	Pol/Phase
	MHz	dBuV/m	dBuV/m	dB	dBuV	dB	dB/m	dB	cm	deg		
1	15716.16	61.05	74.00	-12.95	44.78	12.35	37.84	33.92	200	116	Peak	HORIZONTAL
2	15717.76	46.76	54.00	-7.24	30.49	12.35	37.84	33.92	200	116	Average	HORIZONTAL

### Vertical

	Freq	Level	Limit Line	Over Limit	Read Level	Cable Loss	Antenna Factor	Preamp Factor	A/Pos	T/Pos	Remark	Pol/Phase
	MHz	dBuV/m	dBuV/m	dB	dBuV	dB	dB/m	dB	cm	deg		
1	15716.82	46.82	54.00	-7.18	30.55	12.35	37.84	33.92	200	281	Average	VERTICAL
2	15724.80	60.06	74.00	-13.94	43.79	12.35	37.84	33.92	200	281	Peak	VERTICAL

<b>Temperature</b>	23°C	<b>Humidity</b>	55%
<b>Test Engineer</b>	Brian Sun/Andy Tsai/DK Chang/Gary Chu/Ron Huang	<b>Configurations</b>	IEEE 802.11a CH 149 / Chain 5 + Chain 6 + Chain 7 + Chain 8
<b>Test Date</b>	Apr. 26, 2016		

#### Horizontal

	Freq	Level	Limit Line	Over Limit	Read Level	Cable Loss	Antenna Factor	Preamp Factor	A/Pos	T/Pos	Remark	Pol/Phase
	MHz	dBuV/m	dBuV/m	dB	dBuV	dB	dB/m	dB	cm	deg		
1	11489.42	44.74	54.00	-9.26	28.25	10.66	39.20	33.37	200	78	Average	HORIZONTAL
2	11494.10	58.23	74.00	-15.77	41.74	10.66	39.20	33.37	200	78	Peak	HORIZONTAL

#### Vertical

	Freq	Level	Limit Line	Over Limit	Read Level	Cable Loss	Antenna Factor	Preamp Factor	A/Pos	T/Pos	Remark	Pol/Phase
	MHz	dBuV/m	dBuV/m	dB	dBuV	dB	dB/m	dB	cm	deg		
1	11487.22	44.68	54.00	-9.32	28.19	10.66	39.20	33.37	200	279	Average	VERTICAL
2	11489.64	57.53	74.00	-16.47	41.04	10.66	39.20	33.37	200	279	Peak	VERTICAL

<b>Temperature</b>	23°C	<b>Humidity</b>	55%
<b>Test Engineer</b>	Brian Sun/Andy Tsai/DK Chang/Gary Chu/Ron Huang	<b>Configurations</b>	IEEE 802.11a CH 157 / Chain 5 + Chain 6 + Chain 7 + Chain 8
<b>Test Date</b>	Apr. 26, 2016		

### Horizontal

	Freq	Level	Limit Line	Over Limit	Read Level	Cable Loss	Antenna Factor	Preamp Factor	A/Pos	T/Pos	Remark	Pol/Phase
	MHz	dBuV/m	dBuV/m	dB	dBuV	dB	dB/m	dB	cm	deg		
1	11565.58	44.47	54.00	-9.53	27.98	10.68	39.20	33.39	200	258	Average	HORIZONTAL
2	11569.70	57.29	74.00	-16.71	40.80	10.68	39.20	33.39	200	258	Peak	HORIZONTAL

### Vertical

	Freq	Level	Limit Line	Over Limit	Read Level	Cable Loss	Antenna Factor	Preamp Factor	A/Pos	T/Pos	Remark	Pol/Phase
	MHz	dBuV/m	dBuV/m	dB	dBuV	dB	dB/m	dB	cm	deg		
1	11567.52	57.51	74.00	-16.49	41.02	10.68	39.20	33.39	200	62	Peak	VERTICAL
2	11571.06	44.84	54.00	-9.16	28.35	10.68	39.20	33.39	200	62	Average	VERTICAL

<b>Temperature</b>	23°C	<b>Humidity</b>	55%
<b>Test Engineer</b>	Brian Sun/Andy Tsai/DK Chang/Gary Chu/Ron Huang	<b>Configurations</b>	IEEE 802.11a CH 165 / Chain 5 + Chain 6 + Chain 7 + Chain 8
<b>Test Date</b>	Apr. 26, 2016		

#### Horizontal

	Freq	Level	Limit Line	Over Limit	Read Level	Cable Loss	Antenna Factor	Preamp Factor	A/Pos	T/Pos	Remark	Pol/Phase
	MHz	dBuV/m	dBuV/m	dB	dBuV	dB	dB/m	dB	cm	deg		
1	11645.68	44.34	54.00	-9.66	27.86	10.69	39.20	33.41	200	64	Average	HORIZONTAL
2	11649.42	57.22	74.00	-16.78	40.74	10.69	39.20	33.41	200	64	Peak	HORIZONTAL

#### Vertical

	Freq	Level	Limit Line	Over Limit	Read Level	Cable Loss	Antenna Factor	Preamp Factor	A/Pos	T/Pos	Remark	Pol/Phase
	MHz	dBuV/m	dBuV/m	dB	dBuV	dB	dB/m	dB	cm	deg		
1	11646.12	44.56	54.00	-9.44	28.08	10.69	39.20	33.41	200	252	Average	VERTICAL
2	11648.90	58.09	74.00	-15.91	41.61	10.69	39.20	33.41	200	252	Peak	VERTICAL

<b>Temperature</b>	23°C	<b>Humidity</b>	55%
<b>Test Engineer</b>	Brian Sun/Andy Tsai/DK Chang/Gary Chu/Ron Huang	<b>Configurations</b>	IEEE 802.11ac MCS0/Nss1 VHT20 CH 36 / Chain 5 + Chain 6 + Chain 7 + Chain 8
<b>Test Date</b>	Apr. 26, 2016		

#### Horizontal

	Freq	Level	Limit Line	Over Limit	Read Level	CableAntenna Loss	Antenna Factor	Preamp Factor	A/Pos	T/Pos	Remark	Pol/Phase
	MHz	dBuV/m	dBuV/m	dB	dBuV	dB	dB/m	dB	cm	deg		
1	15538.46	47.09	54.00	-6.91	30.41	12.28	38.13	33.73	200	126	Average	HORIZONTAL
2	15543.78	60.21	74.00	-13.79	43.53	12.28	38.13	33.73	200	126	Peak	HORIZONTAL

#### Vertical

	Freq	Level	Limit Line	Over Limit	Read Level	CableAntenna Loss	Antenna Factor	Preamp Factor	A/Pos	T/Pos	Remark	Pol/Phase
	MHz	dBuV/m	dBuV/m	dB	dBuV	dB	dB/m	dB	cm	deg		
1	15536.38	47.07	54.00	-6.93	30.39	12.28	38.13	33.73	200	251	Average	VERTICAL
2	15538.94	59.86	74.00	-14.14	43.18	12.28	38.13	33.73	200	251	Peak	VERTICAL



<b>Temperature</b>	23°C	<b>Humidity</b>	55%
<b>Test Engineer</b>	Brian Sun/Andy Tsai/DK Chang/Gary Chu/Ron Huang	<b>Configurations</b>	IEEE 802.11ac MCS0/Nss1 VHT20 CH 40 / Chain 5 + Chain 6 + Chain 7 + Chain 8
<b>Test Date</b>	Apr. 26, 2016		

### Horizontal

	Freq	Level	Limit Line	Over Limit	Read Level	Cable Loss	Antenna Factor	Preamp Factor	A/Pos	T/Pos	Remark	Pol/Phase
	MHz	dBuV/m	dBuV/m	dB	dBuV	dB	dB/m	dB	cm	deg		
1	15603.50	60.08	74.00	-13.92	43.56	12.31	37.98	33.77	200	175	Peak	HORIZONTAL
2	15604.16	47.02	54.00	-6.98	30.50	12.31	37.98	33.77	200	175	Average	HORIZONTAL

### Vertical

	Freq	Level	Limit Line	Over Limit	Read Level	Cable Loss	Antenna Factor	Preamp Factor	A/Pos	T/Pos	Remark	Pol/Phase
	MHz	dBuV/m	dBuV/m	dB	dBuV	dB	dB/m	dB	cm	deg		
1	15596.60	59.54	74.00	-14.46	42.96	12.30	38.05	33.77	200	296	Peak	VERTICAL
2	15601.96	46.99	54.00	-7.01	30.47	12.31	37.98	33.77	200	296	Average	VERTICAL

<b>Temperature</b>	23°C	<b>Humidity</b>	55%
<b>Test Engineer</b>	Brian Sun/Andy Tsai/DK Chang/Gary Chu/Ron Huang	<b>Configurations</b>	IEEE 802.11ac MCS0/Nss1 VHT20 CH 48 / Chain 5 + Chain 6 + Chain 7 + Chain 8
<b>Test Date</b>	Apr. 26, 2016		

### Horizontal

	Freq	Level	Limit Line	Over Limit	Read Level	Cable Loss	Antenna Factor	Preamp Factor	A/Pos	T/Pos	Remark	Pol/Phase
	MHz	dBuV/m	dBuV/m	dB	dBuV	dB	dB/m	dB	cm	deg		
1	15722.12	59.74	74.00	-14.26	43.47	12.35	37.84	33.92	200	226	Peak	HORIZONTAL
2	15722.96	46.71	54.00	-7.29	30.44	12.35	37.84	33.92	200	226	Average	HORIZONTAL

### Vertical

	Freq	Level	Limit Line	Over Limit	Read Level	Cable Loss	Antenna Factor	Preamp Factor	A/Pos	T/Pos	Remark	Pol/Phase
	MHz	dBuV/m	dBuV/m	dB	dBuV	dB	dB/m	dB	cm	deg		
1	15717.38	46.89	54.00	-7.11	30.62	12.35	37.84	33.92	200	108	Average	VERTICAL
2	15723.08	59.72	74.00	-14.28	43.45	12.35	37.84	33.92	200	108	Peak	VERTICAL

<b>Temperature</b>	23°C	<b>Humidity</b>	55%
<b>Test Engineer</b>	Brian Sun/Andy Tsai/DK Chang/Gary Chu/Ron Huang	<b>Configurations</b>	IEEE 802.11ac MCS0/Nss1 VHT20 CH 149 / Chain 5 + Chain 6 + Chain 7 + Chain 8
<b>Test Date</b>	Apr. 26, 2016		

#### Horizontal

	Freq	Level	Limit Line	Over Limit	Read Level	CableAntenna Loss	Antenna Factor	Preamp Factor	A/Pos	T/Pos	Remark	Pol/Phase
	MHz	dBuV/m	dBuV/m	dB	dBuV	dB	dB/m	dB	cm	deg		
1	11490.76	44.68	54.00	-9.32	28.19	10.66	39.20	33.37	200	75	Average	HORIZONTAL
2	11494.30	57.71	74.00	-16.29	41.22	10.66	39.20	33.37	200	75	Peak	HORIZONTAL

#### Vertical

	Freq	Level	Limit Line	Over Limit	Read Level	CableAntenna Loss	Antenna Factor	Preamp Factor	A/Pos	T/Pos	Remark	Pol/Phase
	MHz	dBuV/m	dBuV/m	dB	dBuV	dB	dB/m	dB	cm	deg		
1	11489.56	44.77	54.00	-9.23	28.28	10.66	39.20	33.37	200	222	Average	VERTICAL
2	11493.68	57.55	74.00	-16.45	41.06	10.66	39.20	33.37	200	222	Peak	VERTICAL

<b>Temperature</b>	23°C	<b>Humidity</b>	55%
<b>Test Engineer</b>	Brian Sun/Andy Tsai/DK Chang/Gary Chu/Ron Huang	<b>Configurations</b>	IEEE 802.11ac MCS0/Nss1 VHT20 CH 157 / Chain 5 + Chain 6 + Chain 7 + Chain 8
<b>Test Date</b>	Apr. 26, 2016		

### Horizontal

	Freq	Level	Limit Line	Over Limit	Read Level	Cable Loss	Antenna Factor	Preamp Factor	A/Pos	T/Pos	Remark	Pol/Phase
	MHz	dBuV/m	dBuV/m	dB	dBuV	dB	dB/m	dB	cm	deg		
1	11570.12	44.69	54.00	-9.31	28.20	10.68	39.20	33.39	200	77	Average	HORIZONTAL
2	11574.76	57.19	74.00	-16.81	40.70	10.68	39.20	33.39	200	77	Peak	HORIZONTAL

### Vertical

	Freq	Level	Limit Line	Over Limit	Read Level	Cable Loss	Antenna Factor	Preamp Factor	A/Pos	T/Pos	Remark	Pol/Phase
	MHz	dBuV/m	dBuV/m	dB	dBuV	dB	dB/m	dB	cm	deg		
1	11565.82	56.96	74.00	-17.04	40.47	10.68	39.20	33.39	200	285	Peak	VERTICAL
2	11573.90	44.59	54.00	-9.41	28.10	10.68	39.20	33.39	200	285	Average	VERTICAL

<b>Temperature</b>	23°C	<b>Humidity</b>	55%
<b>Test Engineer</b>	Brian Sun/Andy Tsai/DK Chang/Gary Chu/Ron Huang	<b>Configurations</b>	IEEE 802.11ac MCS0/Nss1 VHT20 CH 165 / Chain 5 + Chain 6 + Chain 7 + Chain 8
<b>Test Date</b>	Apr. 26, 2016		

### Horizontal

	Freq	Level	Limit Line	Over Limit	Read Level	CableAntenna Loss Factor	Preamp Factor	A/Pos	T/Pos	Remark	Pol/Phase
	MHz	dBuV/m	dBuV/m	dB	dBuV	dB	dB/m	dB	cm	deg	
1	11645.32	57.14	74.00	-16.86	40.66	10.69	39.20	33.41	200	94 Peak	HORIZONTAL
2	11648.62	44.43	54.00	-9.57	27.95	10.69	39.20	33.41	200	94 Average	HORIZONTAL

### Vertical

	Freq	Level	Limit Line	Over Limit	Read Level	CableAntenna Loss Factor	Preamp Factor	A/Pos	T/Pos	Remark	Pol/Phase
	MHz	dBuV/m	dBuV/m	dB	dBuV	dB	dB/m	dB	cm	deg	
1	11646.90	44.28	54.00	-9.72	27.80	10.69	39.20	33.41	200	168 Average	VERTICAL
2	11654.30	57.56	74.00	-16.44	41.08	10.69	39.20	33.41	200	168 Peak	VERTICAL

<b>Temperature</b>	23°C	<b>Humidity</b>	55%
<b>Test Engineer</b>	Brian Sun/Andy Tsai/DK Chang/Gary Chu/Ron Huang	<b>Configurations</b>	IEEE 802.11ac MCS0/Nss1 VHT40 CH 38 / Chain 5 + Chain 6 + Chain 7 + Chain 8
<b>Test Date</b>	Apr. 26, 2016		

### Horizontal

	Freq	Level	Limit Line	Over Limit	Read Level	Cable Loss	Antenna Factor	Preamp Factor	A/Pos	T/Pos	Remark	Pol/Phase
	MHz	dBuV/m	dBuV/m	dB	dBuV	dB	dB/m	dB	cm	deg		
1	15568.16	60.34	74.00	-13.66	43.76	12.30	38.05	33.77	200	221	Peak	HORIZONTAL
2	15574.08	46.80	54.00	-7.20	30.22	12.30	38.05	33.77	200	221	Average	HORIZONTAL

### Vertical

	Freq	Level	Limit Line	Over Limit	Read Level	Cable Loss	Antenna Factor	Preamp Factor	A/Pos	T/Pos	Remark	Pol/Phase
	MHz	dBuV/m	dBuV/m	dB	dBuV	dB	dB/m	dB	cm	deg		
1	15569.72	46.92	54.00	-7.08	30.34	12.30	38.05	33.77	200	113	Average	VERTICAL
2	15573.84	60.31	74.00	-13.69	43.73	12.30	38.05	33.77	200	113	Peak	VERTICAL

<b>Temperature</b>	23°C	<b>Humidity</b>	55%
<b>Test Engineer</b>	Brian Sun/Andy Tsai/DK Chang/Gary Chu/Ron Huang	<b>Configurations</b>	IEEE 802.11ac MCS0/Nss1 VHT40 CH 46 / Chain 5 + Chain 6 + Chain 7 + Chain 8
<b>Test Date</b>	Apr. 26, 2016		

### Horizontal

	Freq	Level	Limit Line	Over Limit	Read Level	Cable Loss	Antenna Factor	Preamp Factor	A/Pos	T/Pos	Remark	Pol/Phase
	MHz	dBuV/m	dBuV/m	dB	dBuV	dB	dB/m	dB	cm	deg		
1	15687.52	46.85	54.00	-7.15	30.48	12.33	37.91	33.87	200	262	Average	HORIZONTAL
2	15695.00	59.98	74.00	-14.02	43.66	12.35	37.84	33.87	200	262	Peak	HORIZONTAL

### Vertical

	Freq	Level	Limit Line	Over Limit	Read Level	Cable Loss	Antenna Factor	Preamp Factor	A/Pos	T/Pos	Remark	Pol/Phase
	MHz	dBuV/m	dBuV/m	dB	dBuV	dB	dB/m	dB	cm	deg		
1	15686.78	60.13	74.00	-13.87	43.76	12.33	37.91	33.87	200	77	Peak	VERTICAL
2	15694.60	46.86	54.00	-7.14	30.54	12.35	37.84	33.87	200	77	Average	VERTICAL

<b>Temperature</b>	23°C	<b>Humidity</b>	55%
<b>Test Engineer</b>	Brian Sun/Andy Tsai/DK Chang/Gary Chu/Ron Huang	<b>Configurations</b>	IEEE 802.11ac MCS0/Nss1 VHT40 CH 151 / Chain 5 + Chain 6 + Chain 7 + Chain 8
<b>Test Date</b>	Apr. 26, 2016		

### Horizontal

	Freq	Level	Limit Line	Over Limit	Read Level	Cable Loss	Antenna Factor	Preamp Factor	A/Pos	T/Pos	Remark	Pol/Phase
	MHz	dBuV/m	dBuV/m	dB	dBuV	dB	dB/m	dB	cm	deg		
1	11505.40	57.62	74.00	-16.38	41.13	10.66	39.20	33.37	200	61	Peak	HORIZONTAL
2	11507.50	44.47	54.00	-9.53	27.98	10.66	39.20	33.37	200	61	Average	HORIZONTAL

### Vertical

	Freq	Level	Limit Line	Over Limit	Read Level	Cable Loss	Antenna Factor	Preamp Factor	A/Pos	T/Pos	Remark	Pol/Phase
	MHz	dBuV/m	dBuV/m	dB	dBuV	dB	dB/m	dB	cm	deg		
1	11506.48	44.56	54.00	-9.44	28.07	10.66	39.20	33.37	200	255	Average	VERTICAL
2	11506.72	57.68	74.00	-16.32	41.19	10.66	39.20	33.37	200	255	Peak	VERTICAL



<b>Temperature</b>	23°C	<b>Humidity</b>	55%
<b>Test Engineer</b>	Brian Sun/Andy Tsai/DK Chang/Gary Chu/Ron Huang	<b>Configurations</b>	IEEE 802.11ac MCS0/Nss1 VHT40 CH 159 / Chain 5 + Chain 6 + Chain 7 + Chain 8
<b>Test Date</b>	Apr. 26, 2016		

### Horizontal

	Freq	Level	Limit Line	Over Limit	Read Level	Cable Loss	Antenna Factor	Preamp Factor	A/Pos	T/Pos	Remark	Pol/Phase
	MHz	dBuV/m	dBuV/m	dB	dBuV	dB	dB/m	dB	cm	deg		
1	11592.24	57.43	74.00	-16.57	40.95	10.68	39.20	33.40	200	85	Peak	HORIZONTAL
2	11594.44	44.52	54.00	-9.48	28.04	10.68	39.20	33.40	200	85	Average	HORIZONTAL

### Vertical

	Freq	Level	Limit Line	Over Limit	Read Level	Cable Loss	Antenna Factor	Preamp Factor	A/Pos	T/Pos	Remark	Pol/Phase
	MHz	dBuV/m	dBuV/m	dB	dBuV	dB	dB/m	dB	cm	deg		
1	11586.84	44.44	54.00	-9.56	27.96	10.68	39.20	33.40	200	274	Average	VERTICAL
2	11589.04	57.77	74.00	-16.23	41.29	10.68	39.20	33.40	200	274	Peak	VERTICAL

<b>Temperature</b>	23°C	<b>Humidity</b>	55%
<b>Test Engineer</b>	Brian Sun/Andy Tsai/DK Chang/Gary Chu/Ron Huang	<b>Configurations</b>	IEEE 802.11ac MCS0/Nss1 VHT80 CH 42 / Chain 5 + Chain 6 + Chain 7 + Chain 8
<b>Test Date</b>	Apr. 26, 2016		

### Horizontal

	Freq	Level	Limit Line	Over Limit	Read Level	Cable Loss	Antenna Factor	Preamp Factor	A/Pos	T/Pos	Remark	Pol/Phase
	MHz	dBuV/m	dBuV/m	dB	dBuV	dB	dB/m	dB	cm	deg		
1	15633.00	60.77	74.00	-13.23	44.30	12.31	37.98	33.82	200	224	Peak	HORIZONTAL
2	15633.86	46.77	54.00	-7.23	30.30	12.31	37.98	33.82	200	224	Average	HORIZONTAL

### Vertical

	Freq	Level	Limit Line	Over Limit	Read Level	Cable Loss	Antenna Factor	Preamp Factor	A/Pos	T/Pos	Remark	Pol/Phase
	MHz	dBuV/m	dBuV/m	dB	dBuV	dB	dB/m	dB	cm	deg		
1	15630.02	59.74	74.00	-14.26	43.27	12.31	37.98	33.82	200	91	Peak	VERTICAL
2	15631.50	46.94	54.00	-7.06	30.47	12.31	37.98	33.82	200	91	Average	VERTICAL

<b>Temperature</b>	23°C	<b>Humidity</b>	55%
<b>Test Engineer</b>	Brian Sun/Andy Tsai/DK Chang/Gary Chu/Ron Huang	<b>Configurations</b>	IEEE 802.11ac MCS0/Nss1 VHT80 CH 155 / Chain 5 + Chain 6 + Chain 7 + Chain 8
<b>Test Date</b>	Apr. 26, 2016		

### Horizontal

	Freq	Level	Limit Line	Over Limit	Read Level	Cable Loss	Antenna Factor	Preamp Factor	A/Pos	T/Pos	Remark	Pol/Phase
	MHz	dBuV/m	dBuV/m	dB	dBuV	dB	dB/m	dB	cm	deg		
1	11549.16	57.05	74.00	-16.95	40.57	10.67	39.20	33.39	200	-6	Peak	HORIZONTAL
2	11552.60	44.33	54.00	-9.67	27.84	10.68	39.20	33.39	200	-6	Average	HORIZONTAL

### Vertical

	Freq	Level	Limit Line	Over Limit	Read Level	Cable Loss	Antenna Factor	Preamp Factor	A/Pos	T/Pos	Remark	Pol/Phase
	MHz	dBuV/m	dBuV/m	dB	dBuV	dB	dB/m	dB	cm	deg		
1	11549.66	44.37	54.00	-9.63	27.89	10.67	39.20	33.39	200	-6	Average	VERTICAL
2	11554.36	57.13	74.00	-16.87	40.64	10.68	39.20	33.39	200	-6	Peak	VERTICAL

**802.11ac MCS0/Nss2 VHT80+80**

<b>Temperature</b>	23°C	<b>Humidity</b>	55%
<b>Test Engineer</b>	Brian Sun/Andy Tsai/DK Chang/Gary Chu/Ron Huang	<b>Configurations</b>	IEEE 802.11ac MCS0/Nss2 VHT80+80 Type 1 / CH 42+155 / Chain 5 + Chain 6 + Chain 7 + Chain 8
<b>Test Date</b>	May 03, 2016		

**Horizontal**

	Freq	Level	Limit	Over	Read	CableAntenna	Preamp	A/Pos	T/Pos	Remark	Pol/Phase	
	MHz	dBuV/m	dBuV/m	dB	dBuV	dB	dB/m	dB	cm	deg		
1	11550.00	45.83	54.00	-8.17	29.51	11.62	39.93	35.23	230	284	Average	HORIZONTAL
2	11550.00	59.49	74.00	-14.51	43.17	11.62	39.93	35.23	230	284	Peak	HORIZONTAL
3	15630.00	46.47	54.00	-7.53	30.38	13.31	38.14	35.36	196	236	Average	HORIZONTAL
4	15630.00	59.88	74.00	-14.12	43.79	13.31	38.14	35.36	196	236	Peak	HORIZONTAL

**Vertical**

	Freq	Level	Limit	Over	Read	CableAntenna	Preamp	A/Pos	T/Pos	Remark	Pol/Phase	
	MHz	dBuV/m	dBuV/m	dB	dBuV	dB	dB/m	dB	cm	deg		
1	11550.00	45.86	54.00	-8.14	29.54	11.62	39.93	35.23	222	221	Average	VERTICAL
2	11550.00	59.46	74.00	-14.54	43.14	11.62	39.93	35.23	222	221	Peak	VERTICAL
3	15630.00	46.58	54.00	-7.42	30.49	13.31	38.14	35.36	267	162	Average	VERTICAL
4	15630.00	60.36	74.00	-13.64	44.27	13.31	38.14	35.36	267	162	Peak	VERTICAL

**<For Beamforming Mode>**

<b>Temperature</b>	23°C	<b>Humidity</b>	55%
<b>Test Engineer</b>	Brian Sun/Andy Tsai/DK Chang/Gary Chu/Ron Huang	<b>Configurations</b>	IEEE 802.11ac MCS0/Nss1 VHT20 CH 36 / Chain 5 + Chain 6 + Chain 7 + Chain 8
<b>Test Date</b>	May 10, 2016		

**Horizontal**

	Freq	Level	Limit Line	Over Limit	Read Level	CableAntenna Loss	Antenna Factor	Preamp Factor	A/Pos	T/Pos	Remark	Pol/Phase
	MHz	dBuV/m	dBuV/m	dB	dBuV	dB	dB/m	dB	cm	deg		
1	15538.06	59.45	74.00	-14.55	42.76	13.38	38.45	35.14	100	319	Peak	HORIZONTAL
2	15540.90	45.94	54.00	-8.06	29.25	13.38	38.45	35.14	100	319	Average	HORIZONTAL

**Vertical**

	Freq	Level	Limit Line	Over Limit	Read Level	CableAntenna Loss	Antenna Factor	Preamp Factor	A/Pos	T/Pos	Remark	Pol/Phase
	MHz	dBuV/m	dBuV/m	dB	dBuV	dB	dB/m	dB	cm	deg		
1	15538.32	45.99	54.00	-8.01	29.30	13.38	38.45	35.14	100	324	Average	VERTICAL
2	15541.28	59.33	74.00	-14.67	42.64	13.38	38.45	35.14	100	324	Peak	VERTICAL

<b>Temperature</b>	23°C	<b>Humidity</b>	55%
<b>Test Engineer</b>	Brian Sun/Andy Tsai/DK Chang/Gary Chu/Ron Huang	<b>Configurations</b>	IEEE 802.11ac MCS0/Nss1 VHT20 CH 40 / Chain 5 + Chain 6 + Chain 7 + Chain 8
<b>Test Date</b>	May 10, 2016		

### Horizontal

	Freq	Level	Limit Line	Over Limit	Read Level	CableAntenna Loss	Antenna Factor	Preamp Factor	A/Pos	T/Pos	Remark	Pol/Phase
	MHz	dBuV/m	dBuV/m	dB	dBuV	dB	dB/m	dB	cm	deg		
1	15602.64	59.80	74.00	-14.20	43.27	13.38	38.34	35.19	100	331	Peak	HORIZONTAL
2	15604.20	46.30	54.00	-7.70	29.77	13.38	38.34	35.19	100	331	Average	HORIZONTAL

### Vertical

	Freq	Level	Limit Line	Over Limit	Read Level	CableAntenna Loss	Antenna Factor	Preamp Factor	A/Pos	T/Pos	Remark	Pol/Phase
	MHz	dBuV/m	dBuV/m	dB	dBuV	dB	dB/m	dB	cm	deg		
1	15597.28	60.09	74.00	-13.91	43.48	13.38	38.39	35.16	100	325	Peak	VERTICAL
2	15600.70	46.47	54.00	-7.53	29.94	13.38	38.34	35.19	100	325	Average	VERTICAL

<b>Temperature</b>	23°C	<b>Humidity</b>	55%
<b>Test Engineer</b>	Brian Sun/Andy Tsai/DK Chang/Gary Chu/Ron Huang	<b>Configurations</b>	IEEE 802.11ac MCS0/Nss1 VHT20 CH 48 / Chain 5 + Chain 6 + Chain 7 + Chain 8
<b>Test Date</b>	May 10, 2016		

### Horizontal

	Freq	Level	Limit Line	Over Limit	Read Level	CableAntenna Loss	Antenna Factor	Preamp Factor	A/Pos	T/Pos	Remark	Pol/Phase
	MHz	dBuV/m	dBuV/m	dB	dBuV	dB	dB/m	dB	cm	deg		
1	15719.66	47.20	54.00	-6.80	30.82	13.39	38.23	35.24	100	310	Average	HORIZONTAL
2	15721.68	60.08	74.00	-13.92	43.70	13.39	38.23	35.24	100	310	Peak	HORIZONTAL

### Vertical

	Freq	Level	Limit Line	Over Limit	Read Level	CableAntenna Loss	Antenna Factor	Preamp Factor	A/Pos	T/Pos	Remark	Pol/Phase
	MHz	dBuV/m	dBuV/m	dB	dBuV	dB	dB/m	dB	cm	deg		
1	15719.80	47.25	54.00	-6.75	30.87	13.39	38.23	35.24	100	317	Average	VERTICAL
2	15722.86	60.91	74.00	-13.09	44.53	13.39	38.23	35.24	100	317	Peak	VERTICAL

<b>Temperature</b>	23°C	<b>Humidity</b>	55%
<b>Test Engineer</b>	Brian Sun/Andy Tsai/DK Chang/Gary Chu/Ron Huang	<b>Configurations</b>	IEEE 802.11ac MCS0/Nss1 VHT20 CH 149 / Chain 5 + Chain 6 + Chain 7 + Chain 8
<b>Test Date</b>	May 10, 2016		

### Horizontal

	Freq	Level	Limit Line	Over Limit	Read Level	CableAntenna Loss	Antenna Factor	Preamp Factor	A/Pos	T/Pos	Remark	Pol/Phase
	MHz	dBuV/m	dBuV/m	dB	dBuV	dB	dB/m	dB	cm	deg		
1	11486.06	43.82	54.00	-10.18	28.12	10.75	39.70	34.75	100	297	Average	HORIZONTAL
2	11486.96	57.16	74.00	-16.84	41.46	10.75	39.70	34.75	100	297	Peak	HORIZONTAL

### Vertical

	Freq	Level	Limit Line	Over Limit	Read Level	CableAntenna Loss	Antenna Factor	Preamp Factor	A/Pos	T/Pos	Remark	Pol/Phase
	MHz	dBuV/m	dBuV/m	dB	dBuV	dB	dB/m	dB	cm	deg		
1	11485.26	44.12	54.00	-9.88	28.42	10.75	39.70	34.75	100	301	Average	VERTICAL
2	11491.02	56.78	74.00	-17.22	41.08	10.75	39.70	34.75	100	301	Peak	VERTICAL



<b>Temperature</b>	23°C	<b>Humidity</b>	55%
<b>Test Engineer</b>	Brian Sun/Andy Tsai/DK Chang/Gary Chu/Ron Huang	<b>Configurations</b>	IEEE 802.11ac MCS0/Nss1 VHT20 CH 157 / Chain 5 + Chain 6 + Chain 7 + Chain 8
<b>Test Date</b>	May 10, 2016		

### Horizontal

	Freq	Level	Limit Line	Over Limit	Read Level	CableAntenna Loss	Preamp Factor	A/Pos	T/Pos	Remark	Pol/Phase
	MHz	dBuV/m	dBuV/m	dB	dBuV	dB	dB/m	dB	cm	deg	
1	11567.96	57.16	74.00	-16.84	41.51	10.76	39.65	34.76	100	279 Peak	HORIZONTAL
2	11568.98	43.84	54.00	-10.16	28.19	10.76	39.65	34.76	100	279 Average	HORIZONTAL

### Vertical

	Freq	Level	Limit Line	Over Limit	Read Level	CableAntenna Loss	Preamp Factor	A/Pos	T/Pos	Remark	Pol/Phase
	MHz	dBuV/m	dBuV/m	dB	dBuV	dB	dB/m	dB	cm	deg	
1	11567.96	44.11	54.00	-9.89	28.46	10.76	39.65	34.76	100	289 Average	VERTICAL
2	11568.10	57.07	74.00	-16.93	41.42	10.76	39.65	34.76	100	289 Peak	VERTICAL

<b>Temperature</b>	23°C	<b>Humidity</b>	55%
<b>Test Engineer</b>	Brian Sun/Andy Tsai/DK Chang/Gary Chu/Ron Huang	<b>Configurations</b>	IEEE 802.11ac MCS0/Nss1 VHT20 CH 165 / Chain 5 + Chain 6 + Chain 7 + Chain 8
<b>Test Date</b>	May 10, 2016		

### Horizontal

	Freq	Level	Limit Line	Over Limit	Read Level	CableAntenna Loss	Antenna Factor	Preamp Factor	A/Pos	T/Pos	Remark	Pol/Phase
	MHz	dBuV/m	dBuV/m	dB	dBuV	dB	dB/m	dB	cm	deg		
1	11651.32	57.43	74.00	-16.57	41.87	10.77	39.57	34.78	100	289	Peak	HORIZONTAL
2	11653.32	43.82	54.00	-10.18	28.26	10.77	39.57	34.78	100	289	Average	HORIZONTAL

### Vertical

	Freq	Level	Limit Line	Over Limit	Read Level	CableAntenna Loss	Antenna Factor	Preamp Factor	A/Pos	T/Pos	Remark	Pol/Phase
	MHz	dBuV/m	dBuV/m	dB	dBuV	dB	dB/m	dB	cm	deg		
1	11647.90	56.74	74.00	-17.26	41.15	10.77	39.59	34.77	100	274	Peak	VERTICAL
2	11654.06	43.87	54.00	-10.13	28.31	10.77	39.57	34.78	100	274	Average	VERTICAL



<b>Temperature</b>	23°C	<b>Humidity</b>	55%
<b>Test Engineer</b>	Brian Sun/Andy Tsai/DK Chang/Gary Chu/Ron Huang	<b>Configurations</b>	IEEE 802.11ac MCS0/Nss1 VHT40 CH 38 / Chain 5 + Chain 6 + Chain 7 + Chain 8
<b>Test Date</b>	May 10, 2016		

**Horizontal**

	Freq	Level	Limit Line	Over Limit	Read Level	CableAntenna Loss	Preamp Factor	A/Pos	T/Pos	Remark	Pol/Phase
	MHz	dBuV/m	dBuV/m	dB	dBuV	dB	dB/m	dB	cm	deg	
1	15565.24	45.93	54.00	-8.07	29.32	13.38	38.39	35.16	100	281 Average	HORIZONTAL
2	15571.96	59.35	74.00	-14.65	42.74	13.38	38.39	35.16	100	281 Peak	HORIZONTAL

**Vertical**

	Freq	Level	Limit Line	Over Limit	Read Level	CableAntenna Loss	Preamp Factor	A/Pos	T/Pos	Remark	Pol/Phase
	MHz	dBuV/m	dBuV/m	dB	dBuV	dB	dB/m	dB	cm	deg	
1	15572.52	45.84	54.00	-8.16	29.23	13.38	38.39	35.16	100	286 Average	VERTICAL
2	15572.56	59.16	74.00	-14.84	42.55	13.38	38.39	35.16	100	286 Peak	VERTICAL

<b>Temperature</b>	23°C	<b>Humidity</b>	55%
<b>Test Engineer</b>	Brian Sun/Andy Tsai/DK Chang/Gary Chu/Ron Huang	<b>Configurations</b>	IEEE 802.11ac MCS0/Nss1 VHT40 CH 46 / Chain 5 + Chain 6 + Chain 7 + Chain 8
<b>Test Date</b>	May 10, 2016		

### Horizontal

	Freq	Level	Limit Line	Over Limit	Read Level	CableAntenna Loss	Antenna Factor	Preamp Factor	A/Pos	T/Pos	Remark	Pol/Phase
	MHz	dBuV/m	dBuV/m	dB	dBuV	dB	dB/m	dB	cm	deg		
1	15688.40	60.06	74.00	-13.94	43.60	13.39	38.28	35.21	100	274	Peak	HORIZONTAL
2	15694.18	47.08	54.00	-6.92	30.70	13.39	38.23	35.24	100	274	Average	HORIZONTAL

### Vertical

	Freq	Level	Limit Line	Over Limit	Read Level	CableAntenna Loss	Antenna Factor	Preamp Factor	A/Pos	T/Pos	Remark	Pol/Phase
	MHz	dBuV/m	dBuV/m	dB	dBuV	dB	dB/m	dB	cm	deg		
1	15689.76	60.70	74.00	-13.30	44.24	13.39	38.28	35.21	100	278	Peak	VERTICAL
2	15691.72	47.16	54.00	-6.84	30.78	13.39	38.23	35.24	100	278	Average	VERTICAL

<b>Temperature</b>	23°C	<b>Humidity</b>	55%
<b>Test Engineer</b>	Brian Sun/Andy Tsai/DK Chang/Gary Chu/Ron Huang	<b>Configurations</b>	IEEE 802.11ac MCS0/Nss1 VHT40 CH 151 / Chain 5 + Chain 6 + Chain 7 + Chain 8
<b>Test Date</b>	May 10, 2016		

### Horizontal

	Freq	Level	Limit Line	Over Limit	Read Level	CableAntenna Loss	Preamp Factor	A/Pos	T/Pos	Remark	Pol/Phase
	MHz	dBuV/m	dBuV/m	dB	dBuV	dB	dB/m	dB	cm	deg	
1	11506.56	43.77	54.00	-10.23	28.07	10.75	39.70	34.75	100	264 Average	HORIZONTAL
2	11510.76	56.90	74.00	-17.10	41.20	10.75	39.70	34.75	100	264 Peak	HORIZONTAL

### Vertical

	Freq	Level	Limit Line	Over Limit	Read Level	CableAntenna Loss	Preamp Factor	A/Pos	T/Pos	Remark	Pol/Phase
	MHz	dBuV/m	dBuV/m	dB	dBuV	dB	dB/m	dB	cm	deg	
1	11505.92	44.05	54.00	-9.95	28.35	10.75	39.70	34.75	100	269 Average	VERTICAL
2	11509.72	57.38	74.00	-16.62	41.68	10.75	39.70	34.75	100	269 Peak	VERTICAL

<b>Temperature</b>	23°C	<b>Humidity</b>	55%
<b>Test Engineer</b>	Brian Sun/Andy Tsai/DK Chang/Gary Chu/Ron Huang	<b>Configurations</b>	IEEE 802.11ac MCS0/Nss1 VHT40 CH 159 / Chain 5 + Chain 6 + Chain 7 + Chain 8
<b>Test Date</b>	May 10, 2016		

### Horizontal

	Freq	Level	Limit Line	Over Limit	Read Level	CableAntenna Loss	Antenna Factor	Preamp Factor	A/Pos	T/Pos	Remark	Pol/Phase
	MHz	dBuV/m	dBuV/m	dB	dBuV	dB	dB/m	dB	cm	deg		
1	11590.94	43.93	54.00	-10.07	28.32	10.76	39.62	34.77	100	256	Average	HORIZONTAL
2	11591.50	57.38	74.00	-16.62	41.77	10.76	39.62	34.77	100	256	Peak	HORIZONTAL

### Vertical

	Freq	Level	Limit Line	Over Limit	Read Level	CableAntenna Loss	Antenna Factor	Preamp Factor	A/Pos	T/Pos	Remark	Pol/Phase
	MHz	dBuV/m	dBuV/m	dB	dBuV	dB	dB/m	dB	cm	deg		
1	11590.34	43.91	54.00	-10.09	28.30	10.76	39.62	34.77	100	261	Average	VERTICAL
2	11591.54	56.59	74.00	-17.41	40.98	10.76	39.62	34.77	100	261	Peak	VERTICAL

<b>Temperature</b>	23°C	<b>Humidity</b>	55%
<b>Test Engineer</b>	Brian Sun/Andy Tsai/DK Chang/Gary Chu/Ron Huang	<b>Configurations</b>	IEEE 802.11ac MCS0/Nss1 VHT80 CH 42 / Chain 5 + Chain 6 + Chain 7 + Chain 8
<b>Test Date</b>	May 10, 2016		

### Horizontal

	Freq	Level	Limit Line	Over Limit	Read Level	CableAntenna Loss	Antenna Factor	Preamp Factor	A/Pos	T/Pos	Remark	Pol/Phase
	MHz	dBuV/m	dBuV/m	dB	dBuV	dB	dB/m	dB	cm	deg		
1	15632.26	59.96	74.00	-14.04	43.43	13.38	38.34	35.19	105	119	Peak	HORIZONTAL
2	15634.98	46.74	54.00	-7.26	30.21	13.38	38.34	35.19	105	119	Average	HORIZONTAL

### Vertical

	Freq	Level	Limit Line	Over Limit	Read Level	CableAntenna Loss	Antenna Factor	Preamp Factor	A/Pos	T/Pos	Remark	Pol/Phase
	MHz	dBuV/m	dBuV/m	dB	dBuV	dB	dB/m	dB	cm	deg		
1	15626.66	46.86	54.00	-7.14	30.33	13.38	38.34	35.19	103	117	Average	VERTICAL
2	15632.62	59.92	74.00	-14.08	43.39	13.38	38.34	35.19	103	117	Peak	VERTICAL

<b>Temperature</b>	23°C	<b>Humidity</b>	55%
<b>Test Engineer</b>	Brian Sun/Andy Tsai/DK Chang/Gary Chu/Ron Huang	<b>Configurations</b>	IEEE 802.11ac MCS0/Nss1 VHT80 CH 155 / Chain 5 + Chain 6 + Chain 7 + Chain 8
<b>Test Date</b>	May 10, 2016		

### Horizontal

	Freq	Level	Limit Line	Over Limit	Read Level	CableAntenna Loss	Antenna Factor	Preamp Factor	A/Pos	T/Pos	Remark	Pol/Phase
	MHz	dBuV/m	dBuV/m	dB	dBuV	dB	dB/m	dB	cm	deg		
1	11545.14	43.46	54.00	-10.54	27.80	10.75	39.67	34.76	102	110	Average	HORIZONTAL
2	11548.46	56.72	74.00	-17.28	41.06	10.75	39.67	34.76	102	110	Peak	HORIZONTAL

### Vertical

	Freq	Level	Limit Line	Over Limit	Read Level	CableAntenna Loss	Antenna Factor	Preamp Factor	A/Pos	T/Pos	Remark	Pol/Phase
	MHz	dBuV/m	dBuV/m	dB	dBuV	dB	dB/m	dB	cm	deg		
1	11547.04	56.34	74.00	-17.66	40.68	10.75	39.67	34.76	100	342	Peak	VERTICAL
2	11559.16	43.76	54.00	-10.24	28.11	10.76	39.65	34.76	100	342	Average	VERTICAL



**802.11ac MCS0/Nss2 VHT80+80**

<b>Temperature</b>	23°C	<b>Humidity</b>	55%
<b>Test Engineer</b>	Brian Sun/Andy Tsai/DK Chang/Gary Chu/Ron Huang	<b>Configurations</b>	IEEE 802.11ac MCS0/Nss2 VHT80+80 Type 1 / CH 42+155 / Chain 5 + Chain 6 + Chain 7 + Chain 8
<b>Test Date</b>	May 14, 2016		

**Horizontal**

	Freq	Level	Limit	Over	Read	CableAntenna	Preamp	A/Pos	T/Pos	Remark	Pol/Phase
	MHz	dBuV/m	dBuV/m	dB	dBuV	dB	dB/m	dB	cm	deg	
1	15629.06	61.73	74.00	-12.27	45.34	13.87	38.15	35.63	103	152 Peak	HORIZONTAL
2	15630.34	49.45	54.00	-4.55	33.06	13.87	38.15	35.63	103	152 Average	HORIZONTAL

**Vertical**

	Freq	Level	Limit	Over	Read	CableAntenna	Preamp	A/Pos	T/Pos	Remark	Pol/Phase
	MHz	dBuV/m	dBuV/m	dB	dBuV	dB	dB/m	dB	cm	deg	
1	15630.88	49.67	54.00	-4.33	33.28	13.87	38.15	35.63	100	168 Average	VERTICAL
2	15631.44	61.03	74.00	-12.97	44.64	13.87	38.15	35.63	100	168 Peak	VERTICAL

**Note:**

The amplitude of spurious emissions that are attenuated by more than 20dB below the permissible value has no need to be reported.

Emission level (dBuV/m) = 20 log Emission level (uV/m).

Corrected Reading: Antenna Factor + Cable Loss + Read Level - Preamp Factor = Level.

## 4.7. Band Edge Emissions Measurement

### 4.7.1. Limit

For transmitters operating in the 5.15-5.25 GHz band: all emissions outside of the 5.15-5.25 GHz band shall not exceed an e.i.r.p. of  $-27$  dBm/MHz.

For transmitters operating in the 5.725-5.85 GHz band: all emissions shall be limited to a level of  $-27$  dBm/MHz at 75 MHz or more above or below the band edge increasing linearly to 10 dBm/MHz at 25 MHz above or below the band edge, and from 25 MHz above or below the band edge increasing linearly to a level of 15.6 dBm/MHz at 5 MHz above or below the band edge, and from 5 MHz above or below the band edge increasing linearly to a level of 27 dBm/MHz at the band edge.

In addition, In case the emission fall within the restricted band specified on 15.205(a), then the 15.209(a) limit in the table below has to be followed.

Frequencies (MHz)	Field Strength (microlvolts/meter)	Measurement Distance (meters)
0.009~0.490	2400/F(kHz)	300
0.490~1.705	24000/F(kHz)	30
1.705~30.0	30	30
30~88	100	3
88~216	150	3
216~960	200	3
Above 960	500	3

### 4.7.2. Measuring Instruments and Setting

Please refer to section 5 of equipments list in this report. The following table is the setting of the spectrum analyzer.

Spectrum Parameter	Setting
Attenuation	Auto
Span Frequency	100 MHz
RBW / VBW (Emission in restricted band)	1 MHz / 3MHz for Peak, 1 MHz / 1/T for Average
RBW / VBW (Emission in non-restricted band)	1 MHz / 3MHz for Peak

### 4.7.3. Test Procedures

The test procedure is the same as section 4.6.3.

### 4.7.4. Test Setup Layout

This test setup layout is the same as that shown in section 4.6.4.

#### 4.7.5. Test Deviation

There is no deviation with the original standard.

#### 4.7.6. EUT Operation during Test

##### <For Non-Beamforming Mode>

The EUT was programmed to be in continuously transmitting mode.

##### <For Beamforming Mode>

The EUT was programmed to be in beamforming transmitting mode.

#### 4.7.7. Test Result of Band Edge and Fundamental Emissions

<For Non-Beamforming Mode>

<b>Temperature</b>	23°C	<b>Humidity</b>	55%
<b>Test Engineer</b>	Brian Sun/Andy Tsai/DK Chang/Gary Chu/Ron Huang	<b>Configurations</b>	IEEE 802.11a CH 36, 40, 48 / Chain 5 + Chain 6 + Chain 7 + Chain 8
<b>Test Date</b>	Apr. 25, 2016		

##### Channel 36

	Freq	Level	Limit	Over	Read	CableAntenna	Preamp	A/Pos	T/Pos	Remark	Pol/Phase
	MHz	dBuV/m	dBuV/m	dB	dBuV	dB	dB/m	dB	cm	deg	
1	5142.20	53.73	54.00	-0.27	45.08	7.96	33.74	33.05	300	319 Average	VERTICAL
2	5148.20	66.84	74.00	-7.16	58.19	7.96	33.74	33.05	300	319 Peak	VERTICAL
3	5181.80	115.05			106.33	7.98	33.79	33.05	300	319 Average	VERTICAL
4	5183.00	125.67			116.95	7.98	33.79	33.05	300	319 Peak	VERTICAL

Item 3, 4 are the fundamental frequency at 5180 MHz.

##### Channel 40

	Freq	Level	Limit	Over	Read	CableAntenna	Preamp	A/Pos	T/Pos	Remark	Pol/Phase
	MHz	dBuV/m	dBuV/m	dB	dBuV	dB	dB/m	dB	cm	deg	
1	5149.60	68.89	74.00	-5.11	60.24	7.96	33.74	33.05	300	319 Peak	VERTICAL
2	5150.00	50.20	54.00	-3.80	41.55	7.96	33.74	33.05	300	319 Average	VERTICAL
3	5201.20	127.30			118.54	7.99	33.82	33.05	300	319 Peak	VERTICAL
4	5202.40	116.44			107.65	8.00	33.84	33.05	300	319 Average	VERTICAL

Item 3, 4 are the fundamental frequency at 5200 MHz.

##### Channel 48

	Freq	Level	Limit	Over	Read	CableAntenna	Preamp	A/Pos	T/Pos	Remark	Pol/Phase
	MHz	dBuV/m	dBuV/m	dB	dBuV	dB	dB/m	dB	cm	deg	
1	5149.40	66.05	74.00	-7.95	57.40	7.96	33.74	33.05	300	319 Peak	VERTICAL
2	5150.00	48.56	54.00	-5.44	39.91	7.96	33.74	33.05	300	319 Average	VERTICAL
3	5241.80	116.25			107.39	8.03	33.89	33.06	300	319 Average	VERTICAL
4	5241.80	126.83			117.97	8.03	33.89	33.06	300	319 Peak	VERTICAL
5	5350.00	48.81	54.00	-5.19	39.67	8.14	34.06	33.06	300	319 Average	VERTICAL
6	5363.00	64.30	74.00	-9.70	55.13	8.15	34.08	33.06	300	319 Peak	VERTICAL

Item 3, 4 are the fundamental frequency at 5240 MHz.

<b>Temperature</b>	23°C	<b>Humidity</b>	55%
<b>Test Engineer</b>	Brian Sun/Andy Tsai/DK Chang/Gary Chu/Ron Huang	<b>Configurations</b>	IEEE 802.11a CH 149, 157, 165 / Chain 5 + Chain 6 + Chain 7 + Chain 8
<b>Test Date</b>	Apr. 25, 2016		

#### Channel 149

	Freq	Level	Limit Line	Over Limit	Read Level	Cable Loss	Antenna Factor	Preamp Factor	A/Pos	T/Pos	Remark	Pol/Phase
	MHz	dBuV/m	dBuV/m	dB	dBuV	dB	dB/m	dB	cm	deg		
1	5648.00	67.95	68.20	-0.25	58.35	8.32	34.39	33.11	281	43	Peak	VERTICAL
2	5740.00	114.90			105.22	8.37	34.45	33.14	281	43	Average	VERTICAL
3	5740.00	125.46			115.78	8.37	34.45	33.14	281	43	Peak	VERTICAL
4	5932.00	61.83	68.20	-6.37	52.02	8.45	34.56	33.20	281	43	Peak	VERTICAL

Item 2, 3 are the fundamental frequency at 5745 MHz.

#### Channel 157

	Freq	Level	Limit Line	Over Limit	Read Level	Cable Loss	Antenna Factor	Preamp Factor	A/Pos	T/Pos	Remark	Pol/Phase
	MHz	dBuV/m	dBuV/m	dB	dBuV	dB	dB/m	dB	cm	deg		
1	5650.00	64.34	68.20	-3.86	54.74	8.32	34.39	33.11	236	102	Peak	VERTICAL
2	5789.00	113.92			104.19	8.40	34.48	33.15	236	102	Average	VERTICAL
3	5790.00	124.58			114.85	8.40	34.48	33.15	236	102	Peak	VERTICAL
4	5936.00	64.06	68.20	-4.14	54.25	8.45	34.56	33.20	236	102	Peak	VERTICAL

Item 2, 3 are the fundamental frequency at 5785 MHz.

#### Channel 165

	Freq	Level	Limit Line	Over Limit	Read Level	Cable Loss	Antenna Factor	Preamp Factor	A/Pos	T/Pos	Remark	Pol/Phase
	MHz	dBuV/m	dBuV/m	dB	dBuV	dB	dB/m	dB	cm	deg		
1	5614.00	62.88	68.20	-5.32	53.31	8.30	34.37	33.10	250	76	Peak	VERTICAL
2	5819.00	114.00			104.26	8.41	34.49	33.16	250	76	Average	VERTICAL
3	5820.00	125.56			115.82	8.41	34.49	33.16	250	76	Peak	VERTICAL
4	5942.00	64.82	68.20	-3.38	55.00	8.45	34.57	33.20	250	76	Peak	VERTICAL

Item 2, 3 are the fundamental frequency at 5825 MHz.

<b>Temperature</b>	23°C	<b>Humidity</b>	55%
<b>Test Engineer</b>	Brian Sun/Andy Tsai/DK Chang/Gary Chu/Ron Huang	<b>Configurations</b>	IEEE 802.11ac MCS0/Nss1 VHT20 CH 36, 40, 48 / Chain 5 + Chain 6 + Chain 7 + Chain 8
<b>Test Date</b>	Apr. 25, 2016		

### Channel 36

	Freq	Level	Limit Line	Over Limit	Read Level	Cable Loss	Antenna Factor	Preamp Factor	A/Pos	T/Pos	Remark	Pol/Phase
	MHz	dBuV/m	dBuV/m	dB	dBuV	dB	dB/m	dB	cm	deg		
1	5138.00	68.53	74.00	-5.47	59.92	7.94	33.72	33.05	300	319	Peak	VERTICAL
2	5141.60	53.73	54.00	-0.27	45.12	7.94	33.72	33.05	300	319	Average	VERTICAL
3	5181.80	114.44			105.72	7.98	33.79	33.05	300	319	Average	VERTICAL
4	5181.80	125.27			116.55	7.98	33.79	33.05	300	319	Peak	VERTICAL

Item 3, 4 are the fundamental frequency at 5180 MHz.

### Channel 40

	Freq	Level	Limit Line	Over Limit	Read Level	Cable Loss	Antenna Factor	Preamp Factor	A/Pos	T/Pos	Remark	Pol/Phase
	MHz	dBuV/m	dBuV/m	dB	dBuV	dB	dB/m	dB	cm	deg		
1	5141.20	50.23	54.00	-3.77	41.62	7.94	33.72	33.05	300	319	Average	VERTICAL
2	5149.00	66.91	74.00	-7.09	58.26	7.96	33.74	33.05	300	319	Peak	VERTICAL
3	5201.80	116.28			107.49	8.00	33.84	33.05	300	319	Average	VERTICAL
4	5202.40	126.78			117.99	8.00	33.84	33.05	300	319	Peak	VERTICAL

Item 3, 4 are the fundamental frequency at 5200 MHz.

### Channel 48

	Freq	Level	Limit Line	Over Limit	Read Level	Cable Loss	Antenna Factor	Preamp Factor	A/Pos	T/Pos	Remark	Pol/Phase
	MHz	dBuV/m	dBuV/m	dB	dBuV	dB	dB/m	dB	cm	deg		
1	5138.00	63.67	74.00	-10.33	55.06	7.94	33.72	33.05	300	318	Peak	VERTICAL
2	5150.00	48.37	54.00	-5.63	39.72	7.96	33.74	33.05	300	318	Average	VERTICAL
3	5241.80	115.44			106.58	8.03	33.89	33.06	300	318	Average	VERTICAL
4	5243.00	126.65			117.79	8.03	33.89	33.06	300	318	Peak	VERTICAL
5	5350.00	48.41	54.00	-5.59	39.27	8.14	34.06	33.06	300	318	Average	VERTICAL
6	5351.60	62.57	74.00	-11.43	53.43	8.14	34.06	33.06	300	318	Peak	VERTICAL

Item 3, 4 are the fundamental frequency at 5240 MHz.

<b>Temperature</b>	23°C	<b>Humidity</b>	55%
<b>Test Engineer</b>	Brian Sun/Andy Tsai/DK Chang/Gary Chu/Ron Huang	<b>Configurations</b>	IEEE 802.11ac MCS0/Nss1 VHT20 CH 149, 157, 165 / Chain 5 + Chain 6 + Chain 7 + Chain 8
<b>Test Date</b>	Apr. 25, 2016		

#### Channel 149

	Freq	Level	Limit Line	Over Limit	Read Level	Cable Loss	Antenna Factor	Preamp Factor	A/Pos	T/Pos	Remark	Pol/Phase
	MHz	dBuV/m	dBuV/m	dB	dBuV	dB	dB/m	dB	cm	deg		
1	5624.00	68.10	68.20	-0.10	58.51	8.31	34.38	33.10	264	44	Peak	VERTICAL
2	5740.00	115.99			106.31	8.37	34.45	33.14	264	44	Average	VERTICAL
3	5741.00	127.44			117.76	8.37	34.45	33.14	264	44	Peak	VERTICAL
4	5933.00	61.96	68.20	-6.24	52.15	8.45	34.56	33.20	264	44	Peak	VERTICAL

Item 2, 3 are the fundamental frequency at 5745 MHz.

#### Channel 157

	Freq	Level	Limit Line	Over Limit	Read Level	Cable Loss	Antenna Factor	Preamp Factor	A/Pos	T/Pos	Remark	Pol/Phase
	MHz	dBuV/m	dBuV/m	dB	dBuV	dB	dB/m	dB	cm	deg		
1	5641.00	65.52	68.20	-2.68	55.92	8.32	34.39	33.11	234	103	Peak	VERTICAL
2	5789.00	114.70			104.97	8.40	34.48	33.15	234	103	Average	VERTICAL
3	5790.00	125.34			115.61	8.40	34.48	33.15	234	103	Peak	VERTICAL
4	5956.00	63.23	68.20	-4.97	53.41	8.45	34.57	33.20	234	103	Peak	VERTICAL

Item 2, 3 are the fundamental frequency at 5785 MHz.

#### Channel 165

	Freq	Level	Limit Line	Over Limit	Read Level	Cable Loss	Antenna Factor	Preamp Factor	A/Pos	T/Pos	Remark	Pol/Phase
	MHz	dBuV/m	dBuV/m	dB	dBuV	dB	dB/m	dB	cm	deg		
1	5645.00	62.20	68.20	-6.00	52.60	8.32	34.39	33.11	270	44	Peak	VERTICAL
2	5820.00	114.99			105.25	8.41	34.49	33.16	270	44	Average	VERTICAL
3	5821.00	126.12			116.39	8.41	34.49	33.17	270	44	Peak	VERTICAL
4	5926.00	65.78	68.20	-2.42	55.97	8.45	34.56	33.20	270	44	Peak	VERTICAL

Item 2, 3 are the fundamental frequency at 5825 MHz.

<b>Temperature</b>	23°C	<b>Humidity</b>	55%
<b>Test Engineer</b>	Brian Sun/Andy Tsai/DK Chang/Gary Chu/Ron Huang	<b>Configurations</b>	IEEE 802.11ac MCS0/Nss1 VHT40 CH 38, 46 / Chain 5 + Chain 6 + Chain 7 + Chain 8
<b>Test Date</b>	Apr. 25, 2016		

### Channel 38

	Freq	Level	Limit	Over	Read	Cable	Antenna	Preamp	A/Pos	T/Pos	Remark	Pol/Phase
	MHz	dBuV/m	dBuV/m	dB	dBuV	dB	dB/m	dB	cm	deg		
1	5150.00	53.97	54.00	-0.03	45.32	7.96	33.74	33.05	287	317	Average	VERTICAL
2	5150.00	67.41	74.00	-6.59	58.76	7.96	33.74	33.05	287	317	Peak	VERTICAL
3	5191.00	108.53			99.77	7.99	33.82	33.05	287	317	Average	VERTICAL
4	5192.00	118.97			110.21	7.99	33.82	33.05	287	317	Peak	VERTICAL

Item 3, 4 are the fundamental frequency at 5190 MHz.

### Channel 46

	Freq	Level	Limit	Over	Read	Cable	Antenna	Preamp	A/Pos	T/Pos	Remark	Pol/Phase
	MHz	dBuV/m	dBuV/m	dB	dBuV	dB	dB/m	dB	cm	deg		
1	5149.00	66.84	74.00	-7.16	58.19	7.96	33.74	33.05	297	317	Peak	VERTICAL
2	5150.00	53.68	54.00	-0.32	45.03	7.96	33.74	33.05	297	317	Average	VERTICAL
3	5232.00	113.65			104.78	8.03	33.89	33.05	297	317	Average	VERTICAL
4	5232.00	124.15			115.28	8.03	33.89	33.05	297	317	Peak	VERTICAL

Item 3, 4 are the fundamental frequency at 5230 MHz.



<b>Temperature</b>	23°C	<b>Humidity</b>	55%
<b>Test Engineer</b>	Brian Sun/Andy Tsai/DK Chang/Gary Chu/Ron Huang	<b>Configurations</b>	IEEE 802.11ac MCS0/Nss1 VHT40 CH 151, 159 / Chain 5 + Chain 6 + Chain 7 + Chain 8
<b>Test Date</b>	Apr. 25, 2016		

### Channel 151

	Freq	Level	Limit	Over	Read	CableAntenna	Preamp	A/Pos	T/Pos	Remark	Pol/Phase
	MHz	dBuV/m	dBuV/m	dB	dBuV	dB	dB/m	dB	cm	deg	
1	5650.00	64.71	68.20	-3.49	55.11	8.32	34.39	33.11	287	76 Peak	VERTICAL
2	5748.00	112.87			103.19	8.37	34.45	33.14	287	76 Average	VERTICAL
3	5748.00	123.25			113.57	8.37	34.45	33.14	287	76 Peak	VERTICAL
4	5970.00	61.98	68.20	-6.22	52.15	8.46	34.58	33.21	287	76 Peak	VERTICAL

Item 2, 3 are the fundamental frequency at 5755 MHz.

### Channel 159

	Freq	Level	Limit	Over	Read	CableAntenna	Preamp	A/Pos	T/Pos	Remark	Pol/Phase
	MHz	dBuV/m	dBuV/m	dB	dBuV	dB	dB/m	dB	cm	deg	
1	5640.00	62.52	68.20	-5.68	52.94	8.31	34.38	33.11	255	77 Peak	VERTICAL
2	5788.00	122.82			113.11	8.39	34.47	33.15	255	77 Peak	VERTICAL
3	5789.00	112.41			102.68	8.40	34.48	33.15	255	77 Average	VERTICAL
4	5931.00	62.59	68.20	-5.61	52.78	8.45	34.56	33.20	255	77 Peak	VERTICAL

Item 2, 3 are the fundamental frequency at 5795 MHz.

<b>Temperature</b>	23°C	<b>Humidity</b>	55%
<b>Test Engineer</b>	Brian Sun/Andy Tsai/DK Chang/Gary Chu/Ron Huang	<b>Configurations</b>	IEEE 802.11ac MCS0/Nss1 VHT80 CH 42, 155 / Chain 5 + Chain 6 + Chain 7 + Chain 8
<b>Test Date</b>	Apr. 25, 2016~Apr. 26, 2016		

#### Channel 42

	Freq	Level	Limit	Over	Read	CableAntenna	Preamp	A/Pos	T/Pos	Remark	Pol/Phase
	MHz	dBuV/m	dBuV/m	dB	dBuV	dB	dB/m	dB	cm	deg	
1	5150.00	53.83	54.00	-0.17	45.18	7.96	33.74	33.05	296	317 Average	VERTICAL
2	5150.00	72.37	74.00	-1.63	63.72	7.96	33.74	33.05	296	317 Peak	VERTICAL
3	5212.00	113.58			104.79	8.00	33.84	33.05	296	317 Peak	VERTICAL
4	5232.00	103.64			94.77	8.03	33.89	33.05	296	317 Average	VERTICAL

Item 3, 4 are the fundamental frequency at 5210 MHz.

#### Channel 155

	Freq	Level	Limit	Over	Read	CableAntenna	Preamp	A/Pos	T/Pos	Remark	Pol/Phase
	MHz	dBuV/m	dBuV/m	dB	dBuV	dB	dB/m	dB	cm	deg	
1	5648.00	67.62	68.20	-0.58	58.02	8.32	34.39	33.11	248	42 Peak	VERTICAL
2	5771.00	115.63			105.94	8.38	34.46	33.15	248	42 Peak	VERTICAL
3	5790.00	105.53			95.80	8.40	34.48	33.15	248	42 Average	VERTICAL
4	5926.00	62.30	68.20	-5.90	52.49	8.45	34.56	33.20	248	42 Peak	VERTICAL

Item 2, 3 are the fundamental frequency at 5775 MHz.

**802.11ac MCS0/Nss2 VHT80+80**

<b>Temperature</b>	23°C	<b>Humidity</b>	55%
<b>Test Engineer</b>	Brian Sun/Andy Tsai/DK Chang/Gary Chu/Ron Huang	<b>Configurations</b>	IEEE 802.11ac MCS0/Nss2 VHT80+80 Type 1 / CH 42+155 / Chain 5 + Chain 6 + Chain 7 + Chain 8
<b>Test Date</b>	May 02, 2016		

**Channel 42**

	Freq	Level	Limit	Over	Read	CableAntenna	Preamp	A/Pos	T/Pos	Remark	Pol/Phase
	MHz	dBuV/m	dBuV/m	dB	dBuV	dB	dB/m	dB	cm	deg	
1	5134.68	68.69	74.00	-5.31	60.08	7.94	33.72	33.05	249	235 Peak	VERTICAL
2	5147.50	53.70	54.00	-0.30	45.05	7.96	33.74	33.05	249	235 Average	VERTICAL
3	5220.42	109.32			100.49	8.02	33.86	33.05	249	235 Peak	VERTICAL
4	5223.62	96.70			87.87	8.02	33.86	33.05	249	235 Average	VERTICAL
5	5350.00	48.97	54.00	-5.03	39.83	8.14	34.06	33.06	249	235 Average	VERTICAL
6	5360.64	63.06	74.00	-10.94	53.89	8.15	34.08	33.06	249	235 Peak	VERTICAL

Item 3, 4 are the fundamental frequency at 5210 MHz.

**Channel 155**

	Freq	Level	Limit	Over	Read	CableAntenna	Preamp	A/Pos	T/Pos	Remark	Pol/Phase
	MHz	dBuV/m	dBuV/m	dB	dBuV	dB	dB/m	dB	cm	deg	
1	5646.84	68.03	68.20	-0.17	58.43	8.32	34.39	33.11	249	155 Peak	VERTICAL
2	5752.68	112.69			103.01	8.37	34.45	33.14	249	155 Peak	VERTICAL
3	5762.89	101.42			91.72	8.38	34.46	33.14	249	155 Average	VERTICAL
4	5925.48	65.05	68.20	-3.15	55.24	8.45	34.56	33.20	249	155 Peak	VERTICAL

Item 2, 3 are the fundamental frequency at 5775 MHz.

## &lt;For Beamforming Mode&gt;

<b>Temperature</b>	23°C	<b>Humidity</b>	55%
<b>Test Engineer</b>	Brian Sun/Andy Tsai/DK Chang/Gary Chu/Ron Huang	<b>Configurations</b>	IEEE 802.11ac MCS0/Nss1 VHT20 CH 36, 40, 48 / Chain 5 + Chain 6 + Chain 7 + Chain 8
<b>Test Date</b>	May 09, 2016		

## Channel 36

	Freq	Level	Limit	Over	Read	CableAntenna	Preamp	A/Pos	T/Pos	Remark	Pol/Phase	
	MHz	dBuV/m	dBuV/m	dB	dBuV	dB	dB/m	dB	cm	deg		
1	5135.60	69.71	74.00	-4.29	62.30	7.48	34.84	34.91	243	130	Peak	VERTICAL
2	5150.00	53.82	54.00	-0.18	46.40	7.48	34.85	34.91	243	130	Average	VERTICAL
3	5176.00	110.42			102.97	7.48	34.88	34.91	243	130	Average	VERTICAL
4	5182.40	122.89			115.44	7.48	34.88	34.91	243	130	Peak	VERTICAL

Item 3, 4 are the fundamental frequency at 5180 MHz.

## Channel 40

	Freq	Level	Limit	Over	Read	CableAntenna	Preamp	A/Pos	T/Pos	Remark	Pol/Phase	
	MHz	dBuV/m	dBuV/m	dB	dBuV	dB	dB/m	dB	cm	deg		
1	5147.60	70.36	74.00	-3.64	62.94	7.48	34.85	34.91	249	134	Peak	VERTICAL
2	5150.00	49.39	54.00	-4.61	41.97	7.48	34.85	34.91	249	134	Average	VERTICAL
3	5194.80	124.66			117.19	7.48	34.90	34.91	249	134	Peak	VERTICAL
4	5206.00	112.47			104.98	7.49	34.91	34.91	249	134	Average	VERTICAL

Item 3, 4 are the fundamental frequency at 5200 MHz.

## Channel 48

	Freq	Level	Limit	Over	Read	CableAntenna	Preamp	A/Pos	T/Pos	Remark	Pol/Phase	
	MHz	dBuV/m	dBuV/m	dB	dBuV	dB	dB/m	dB	cm	deg		
1	5120.00	48.34	54.00	-5.66	40.94	7.48	34.82	34.90	240	132	Average	VERTICAL
2	5147.60	67.76	74.00	-6.24	60.34	7.48	34.85	34.91	240	132	Peak	VERTICAL
3	5238.20	114.96			107.43	7.50	34.94	34.91	240	132	Average	VERTICAL
4	5238.20	125.96			118.43	7.50	34.94	34.91	240	132	Peak	VERTICAL
5	5350.40	65.64	74.00	-8.36	57.94	7.56	35.05	34.91	240	132	Peak	VERTICAL
6	5385.20	48.57	54.00	-5.43	40.82	7.58	35.09	34.92	240	132	Average	VERTICAL

Item 3, 4 are the fundamental frequency at 5240 MHz.

<b>Temperature</b>	23°C	<b>Humidity</b>	55%
<b>Test Engineer</b>	Brian Sun/Andy Tsai/DK Chang/Gary Chu/Ron Huang	<b>Configurations</b>	IEEE 802.11ac MCS0/Nss1 VHT20 CH 149, 157, 165 / Chain 5 + Chain 6 + Chain 7 + Chain 8
<b>Test Date</b>	May 09, 2016		

#### Channel 149

	Freq	Level	Limit Line	Over Limit	Read Level	CableAntenna Loss	Preamp Factor	A/Pos	T/Pos	Remark	Pol/Phase	
	MHz	dBuV/m	dBuV/m	dB	dBuV	dB	dB/m	dB	cm	deg		
1	5634.96	66.06	68.20	-2.14	57.86	7.90	35.23	34.93	246	40	Peak	VERTICAL
2	5748.36	126.06			117.98	7.77	35.25	34.94	246	40	Peak	VERTICAL
3	5750.52	114.30			106.22	7.77	35.25	34.94	246	40	Average	VERTICAL
4	5930.88	62.74	68.20	-5.46	54.47	7.94	35.29	34.96	246	40	Peak	VERTICAL

Item 2, 3 are the fundamental frequency at 5745 MHz.

#### Channel 157

	Freq	Level	Limit Line	Over Limit	Read Level	CableAntenna Loss	Preamp Factor	A/Pos	T/Pos	Remark	Pol/Phase	
	MHz	dBuV/m	dBuV/m	dB	dBuV	dB	dB/m	dB	cm	deg		
1	5649.00	63.58	68.20	-4.62	55.40	7.88	35.23	34.93	226	44	Peak	VERTICAL
2	5782.92	114.18			106.14	7.73	35.26	34.95	226	44	Average	VERTICAL
3	5787.24	126.07			118.03	7.73	35.26	34.95	226	44	Peak	VERTICAL
4	5938.44	65.09	68.20	-3.11	56.82	7.94	35.29	34.96	226	44	Peak	VERTICAL

Item 2, 3 are the fundamental frequency at 5785 MHz.

#### Channel 165

	Freq	Level	Limit Line	Over Limit	Read Level	CableAntenna Loss	Preamp Factor	A/Pos	T/Pos	Remark	Pol/Phase	
	MHz	dBuV/m	dBuV/m	dB	dBuV	dB	dB/m	dB	cm	deg		
1	5474.04	61.26	68.20	-6.94	53.29	7.72	35.17	34.92	234	43	Peak	VERTICAL
2	5819.64	113.85			105.80	7.74	35.26	34.95	234	43	Average	VERTICAL
3	5823.96	124.95			116.86	7.77	35.27	34.95	234	43	Peak	VERTICAL
4	5931.96	66.94	68.20	-1.26	58.67	7.94	35.29	34.96	234	43	Peak	VERTICAL

Item 2, 3 are the fundamental frequency at 5825 MHz.

<b>Temperature</b>	23°C	<b>Humidity</b>	55%
<b>Test Engineer</b>	Brian Sun/Andy Tsai/DK Chang/Gary Chu/Ron Huang	<b>Configurations</b>	IEEE 802.11ac MCS0/Nss1 VHT40 CH 38, 46 / Chain 5 + Chain 6 + Chain 7 + Chain 8
<b>Test Date</b>	May 10, 2016		

#### Channel 38

	Freq	Level	Limit	Over	Read	CableAntenna	Preamp	A/Pos	T/Pos	Remark	Pol/Phase	
	MHz	dBuV/m	dBuV/m	dB	dBuV	Loss	Factor	dB	cm	deg		
1	5150.00	53.82	54.00	-0.18	46.40	7.48	34.85	34.91	234	318	Average	VERTICAL
2	5150.00	65.27	74.00	-8.73	57.85	7.48	34.85	34.91	234	318	Peak	VERTICAL
3	5181.60	120.26			112.81	7.48	34.88	34.91	234	318	Peak	VERTICAL
4	5185.60	106.72			99.27	7.48	34.88	34.91	234	318	Average	VERTICAL

Item 3, 4 are the fundamental frequency at 5190 MHz.

#### Channel 46

	Freq	Level	Limit	Over	Read	CableAntenna	Preamp	A/Pos	T/Pos	Remark	Pol/Phase	
	MHz	dBuV/m	dBuV/m	dB	dBuV	Loss	Factor	dB	cm	deg		
1	5143.60	70.35	74.00	-3.65	62.93	7.48	34.85	34.91	242	133	Peak	VERTICAL
2	5149.60	50.31	54.00	-3.69	42.89	7.48	34.85	34.91	242	133	Average	VERTICAL
3	5232.40	122.56			115.03	7.50	34.94	34.91	242	133	Peak	VERTICAL
4	5239.00	110.59			103.06	7.50	34.94	34.91	242	133	Average	VERTICAL

Item 3, 4 are the fundamental frequency at 5230 MHz.

<b>Temperature</b>	23°C	<b>Humidity</b>	55%
<b>Test Engineer</b>	Brian Sun/Andy Tsai/DK Chang/Gary Chu/Ron Huang	<b>Configurations</b>	IEEE 802.11ac MCS0/Nss1 VHT40 CH 151, 159 / Chain 5 + Chain 6 + Chain 7 + Chain 8
<b>Test Date</b>	May 10, 2016		

#### Channel 151

	Freq	Level	Limit	Over	Read	CableAntenna	Preamp	A/Pos	T/Pos	Remark	Pol/Phase
	MHz	dBuV/m	dBuV/m	dB	dBuV	dB	dB/m	dB	cm	deg	
1	5632.80	67.18	68.20	-1.02	58.98	7.90	35.23	34.93	232	45 Peak	VERTICAL
2	5746.20	119.81			111.73	7.77	35.25	34.94	232	45 Peak	VERTICAL
3	5750.52	108.49			100.41	7.77	35.25	34.94	232	45 Average	VERTICAL
4	5927.64	60.87	68.20	-7.33	52.60	7.94	35.29	34.96	232	45 Peak	VERTICAL

Item 2, 3 are the fundamental frequency at 5755 MHz.

#### Channel 159

	Freq	Level	Limit	Over	Read	CableAntenna	Preamp	A/Pos	T/Pos	Remark	Pol/Phase
	MHz	dBuV/m	dBuV/m	dB	dBuV	dB	dB/m	dB	cm	deg	
1	5650.08	63.78	68.26	-4.48	55.60	7.88	35.23	34.93	228	143 Peak	VERTICAL
2	5802.36	109.21			101.19	7.71	35.26	34.95	228	143 Average	VERTICAL
3	5808.84	119.69			111.64	7.74	35.26	34.95	228	143 Peak	VERTICAL
4	5925.48	67.14	68.20	-1.06	58.87	7.94	35.29	34.96	228	143 Peak	VERTICAL

Item 2, 3 are the fundamental frequency at 5795 MHz.

<b>Temperature</b>	23°C	<b>Humidity</b>	55%
<b>Test Engineer</b>	Brian Sun/Andy Tsai/DK Chang/Gary Chu/Ron Huang	<b>Configurations</b>	IEEE 802.11ac MCS0/Nss1 VHT80 CH 42, 155 / Chain 5 + Chain 6 + Chain 7 + Chain 8
<b>Test Date</b>	May 10, 2016		

### Channel 42

	Freq	Level	Limit	Over	Read	CableAntenna	Preamp	A/Pos	T/Pos	Remark	Pol/Phase	
	MHz	dBuV/m	dBuV/m	dB	dBuV	dB	dB/m	dB	cm	deg		
1	5134.00	70.10	74.00	-3.90	62.69	7.48	34.84	34.91	236	136	Peak	VERTICAL
2	5149.00	53.03	54.00	-0.97	45.61	7.48	34.85	34.91	236	136	Average	VERTICAL
3	5241.00	101.98			94.45	7.50	34.94	34.91	236	136	Average	VERTICAL
4	5245.00	112.43			104.90	7.50	34.94	34.91	236	136	Peak	VERTICAL
5	5350.00	48.85	54.00	-5.15	41.15	7.56	35.05	34.91	236	136	Average	VERTICAL
6	5353.00	60.77	74.00	-13.23	53.07	7.56	35.05	34.91	236	136	Peak	VERTICAL

Item 3, 4 are the fundamental frequency at 5210 MHz.

### Channel 155

	Freq	Level	Limit	Over	Read	CableAntenna	Preamp	A/Pos	T/Pos	Remark	Pol/Phase	
	MHz	dBuV/m	dBuV/m	dB	dBuV	dB	dB/m	dB	cm	deg		
1	5620.92	68.07	68.20	-0.13	59.86	7.92	35.22	34.93	229	43	Peak	VERTICAL
2	5740.80	120.40			112.32	7.77	35.25	34.94	229	43	Peak	VERTICAL
3	5808.84	105.50			97.45	7.74	35.26	34.95	229	43	Average	VERTICAL
4	5924.40	66.50	68.64	-2.14	58.23	7.94	35.29	34.96	229	43	Peak	VERTICAL

Item 2, 3 are the fundamental frequency at 5775 MHz.



**802.11ac MCS0/Nss2 VHT80+80**

<b>Temperature</b>	23°C	<b>Humidity</b>	55%
<b>Test Engineer</b>	Brian Sun/Andy Tsai/DK Chang/Gary Chu/Ron Huang	<b>Configurations</b>	IEEE 802.11ac MCS0/Nss2 VHT80+80 Type 1 / CH 42+155 / Chain 5 + Chain 6 + Chain 7 + Chain 8
<b>Test Date</b>	May 14, 2016		

**Channel 42**

	Freq	Level	Limit	Over	Read	CableAntenna	Preamp	A/Pos	T/Pos	Remark	Pol/Phase	
	MHz	dBuV/m	dBuV/m	dB	dBuV	dB	dB/m	dB	cm	deg		
1	5144.00	66.81	74.00	-7.19	61.73	7.26	31.45	33.63	252	218	Peak	VERTICAL
2	5149.00	53.38	54.00	-0.62	48.30	7.26	31.45	33.63	252	218	Average	VERTICAL
3	5243.00	99.70			94.37	7.40	31.54	33.61	252	218	Average	VERTICAL
4	5243.00	109.70			104.37	7.40	31.54	33.61	252	218	Peak	VERTICAL
5	5350.00	49.63	54.00	-4.37	44.03	7.55	31.65	33.60	252	218	Average	VERTICAL
6	5355.00	60.14	74.00	-13.86	54.51	7.57	31.66	33.60	252	218	Peak	VERTICAL

Item 3, 4 are the fundamental frequency at 5210 MHz.

**Channel 155**

	Freq	Level	Limit	Over	Read	CableAntenna	Preamp	A/Pos	T/Pos	Remark	Pol/Phase	
	MHz	dBuV/m	dBuV/m	dB	dBuV	dB	dB/m	dB	cm	deg		
1	5623.08	67.99	68.20	-0.21	61.80	7.84	31.94	33.59	229	37	Peak	VERTICAL
2	5749.44	110.62			104.76	7.36	32.10	33.60	229	37	Peak	VERTICAL
3	5762.30	101.17			95.35	7.30	32.12	33.60	229	37	Average	VERTICAL
4	5941.68	61.18	68.20	-7.02	55.11	7.35	32.34	33.62	229	37	Peak	VERTICAL

Item 2, 3 are the fundamental frequency at 5775 MHz.

Note:

Emission level (dBuV/m) = 20 log Emission level (uV/m)

Corrected Reading: Antenna Factor + Cable Loss + Read Level - Preamp Factor = Level

## 4.8. Frequency Stability Measurement

### 4.8.1. Limit

In-band emission is maintained within the band of operation under all conditions of normal operation as specified in the user's manual.

The transmitter center frequency tolerance shall be  $\pm 20$  ppm maximum for the 5 GHz band (IEEE 802.11n specification).

### 4.8.2. Measuring Instruments and Setting

Please refer to section 5 of equipments list in this report. The following table is the setting of the spectrum analyzer.

Spectrum Parameter	Setting
Attenuation	Auto
Span Frequency	Entire absence of modulation emissions bandwidth
RBW	10 kHz
VBW	10 kHz
Sweep Time	Auto

### 4.8.3. Test Procedures

1. The transmitter output (antenna port) was connected to the spectrum analyzer.
2. EUT have transmitted absence of modulation signal and fixed channelize.
3. Set the spectrum analyzer span to view the entire absence of modulation emissions bandwidth.
4. Set RBW = 10 kHz, VBW = 10 kHz with peak detector and maxhold settings.
5.  $f_c$  is declaring of channel frequency. Then the frequency error formula is  $(f_c - f) / f_c \times 10^6$  ppm and the limit is less than  $\pm 20$  ppm (IEEE 802.11n specification).
6. Allow sufficient time (approximately 30 min) for the temperature of the chamber to stabilize, turn the EUT on and measure the operating frequency after 2, 5, and 10 minutes.
7. The test extreme voltage is to change the primary supply voltage from 85 to 115 percent of the nominal value
8. Extreme temperature is  $-30^\circ\text{C} \sim 50^\circ\text{C}$ .

### 4.8.4. Test Setup Layout

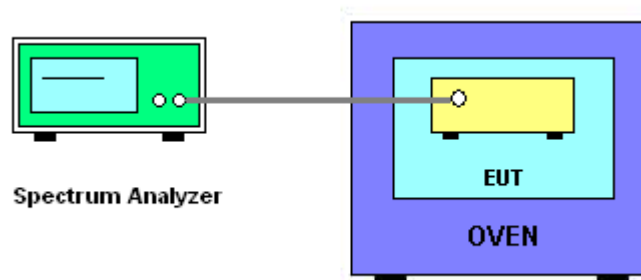

#### 4.8.5. Test Deviation

There is no deviation with the original standard.

#### 4.8.6. EUT Operation during Test

The EUT was programmed to be in continuously un-modulation transmitting mode.

#### 4.8.7. Test Result of Frequency Stability

<b>Temperature</b>	24°C	<b>Humidity</b>	60%
<b>Test Engineer</b>	Clemens Fang	<b>Test Date</b>	May 18, 2016~May 19, 2016

Mode: 20 MHz / Chain 5

##### Voltage vs. Frequency Stability

Voltage (V)	Measurement Frequency (MHz)			
	5200 MHz			
	0 Minute	2 Minute	5 Minute	10 Minute
126.50	5200.0060	5200.0049	5200.0034	5200.0014
110.00	5200.0048	5200.0035	5200.0019	5200.0000
93.50	5200.0034	5200.0025	5200.0011	5199.9993
Max. Deviation (MHz)	0.0060	0.0049	0.0034	0.0014
Max. Deviation (ppm)	1.15	0.94	0.65	0.27
Result	Complies			

##### Temperature vs. Frequency Stability

Temperature (°C)	Measurement Frequency (MHz)			
	5200 MHz			
	0 Minute	2 Minute	5 Minute	10 Minute
-30	5200.0120	5200.0104	5200.0089	5200.0065
-20	5200.0102	5200.0089	5200.0072	5200.0051
-10	5200.0087	5200.0075	5200.0059	5200.0040
0	5200.0073	5200.0059	5200.0040	5200.0018
10	5200.0060	5200.0047	5200.0032	5200.0014
20	5200.0048	5200.0035	5200.0019	5200.0000
30	5200.0034	5200.0023	5200.0009	5199.9993
40	5200.0019	5200.0006	5199.9990	5199.9971
50	5200.0002	5199.9990	5199.9975	5199.9952
Max. Deviation (MHz)	0.0120	0.0104	0.0089	0.0065
Max. Deviation (ppm)	2.30	2.00	1.71	1.25
Result	Complies			

**Voltage vs. Frequency Stability**

Voltage	Measurement Frequency (MHz)			
(V)	5785 MHz			
	0 Minute	2 Minute	5 Minute	10 Minute
126.50	5785.0085	5785.0074	5785.0059	5785.0039
110.00	5785.0073	5785.0060	5785.0044	5785.0025
93.50	5785.0059	5785.0050	5785.0036	5785.0018
Max. Deviation (MHz)	0.0085	0.0074	0.0059	0.0039
Max. Deviation (ppm)	1.46	1.27	1.01	0.67
Result	Complies			

**Temperature vs. Frequency Stability**

Temperature	Measurement Frequency (MHz)			
(°C)	5785 MHz			
	0 Minute	2 Minute	5 Minute	10 Minute
-30	5785.0145	5785.0129	5785.0114	5785.0090
-20	5785.0127	5785.0114	5785.0097	5785.0076
-10	5785.0112	5785.0100	5785.0084	5785.0065
0	5785.0098	5785.0084	5785.0065	5785.0043
10	5785.0085	5785.0072	5785.0057	5785.0039
20	5785.0073	5785.0060	5785.0044	5785.0025
30	5785.0059	5785.0048	5785.0034	5785.0018
40	5785.0044	5785.0031	5785.0015	5784.9996
50	5785.0027	5785.0015	5785.0000	5784.9977
Max. Deviation (MHz)	0.0145	0.0129	0.0114	0.0090
Max. Deviation (ppm)	2.50	2.22	1.96	1.55
Result	Complies			

Mode: 40 MHz / Chain 5

Voltage vs. Frequency Stability

Voltage	Measurement Frequency (MHz)			
(V)	5190 MHz			
	0 Minute	2 Minute	5 Minute	10 Minute
126.50	5190.0055	5190.0044	5190.0029	5190.0009
110.00	5190.0043	5190.0030	5190.0014	5189.9995
93.50	5190.0029	5190.0020	5190.0006	5189.9988
Max. Deviation (MHz)	0.0055	0.0044	0.0029	0.0012
Max. Deviation (ppm)	1.07	0.86	0.57	0.22
Result	Complies			

Temperature vs. Frequency Stability

Temperature	Measurement Frequency (MHz)			
(°C)	5190 MHz			
	0 Minute	2 Minute	5 Minute	10 Minute
-30	5190.0115	5190.0099	5190.0084	5190.0060
-20	5190.0097	5190.0084	5190.0067	5190.0046
-10	5190.0082	5190.0070	5190.0054	5190.0035
0	5190.0068	5190.0054	5190.0035	5190.0013
10	5190.0055	5190.0042	5190.0027	5190.0009
20	5190.0043	5190.0030	5190.0014	5189.9995
30	5190.0029	5190.0018	5190.0004	5189.9988
40	5190.0014	5190.0001	5189.9985	5189.9966
50	5189.9997	5189.9985	5189.9970	5189.9947
Max. Deviation (MHz)	0.0115	0.0099	0.0084	0.0060
Max. Deviation (ppm)	2.22	1.92	1.63	1.16
Result	Complies			

**Voltage vs. Frequency Stability**

Voltage	Measurement Frequency (MHz)			
(V)	5755 MHz			
	0 Minute	2 Minute	5 Minute	10 Minute
126.50	5755.0074	5755.0063	5755.0048	5755.0028
110.00	5755.0062	5755.0049	5755.0033	5755.0014
93.50	5755.0048	5755.0039	5755.0025	5755.0007
Max. Deviation (MHz)	0.0074	0.0063	0.0048	0.0028
Max. Deviation (ppm)	1.29	1.10	0.84	0.49
Result	Complies			

**Temperature vs. Frequency Stability**

Temperature	Measurement Frequency (MHz)			
(°C)	5755 MHz			
	0 Minute	2 Minute	5 Minute	10 Minute
-30	5755.0134	5755.0118	5755.0103	5755.0079
-20	5755.0116	5755.0103	5755.0086	5755.0065
-10	5755.0101	5755.0089	5755.0073	5755.0054
0	5755.0087	5755.0073	5755.0054	5755.0032
10	5755.0074	5755.0061	5755.0046	5755.0028
20	5755.0062	5755.0049	5755.0033	5755.0014
30	5755.0048	5755.0037	5755.0023	5755.0007
40	5755.0033	5755.0020	5755.0004	5754.9985
50	5755.0016	5755.0004	5754.9989	5754.9966
Max. Deviation (MHz)	0.0134	0.0118	0.0103	0.0079
Max. Deviation (ppm)	2.34	2.06	1.80	1.38
Result	Complies			

Mode: 80 MHz / Chain 5

## Voltage vs. Frequency Stability

Voltage	Measurement Frequency (MHz)			
(V)	5210 MHz			
	0 Minute	2 Minute	5 Minute	10 Minute
126.50	5210.0065	5210.0054	5210.0039	5210.0019
110.00	5210.0053	5210.0040	5210.0024	5210.0005
93.50	5210.0039	5210.0030	5210.0016	5209.9998
Max. Deviation (MHz)	0.0065	0.0054	0.0039	0.0019
Max. Deviation (ppm)	1.25	1.03	0.75	0.36
Result	Complies			

## Temperature vs. Frequency Stability

Temperature	Measurement Frequency (MHz)			
(°C)	5210 MHz			
	0 Minute	2 Minute	5 Minute	10 Minute
-30	5210.0125	5210.0109	5210.0094	5210.0070
-20	5210.0107	5210.0094	5210.0077	5210.0056
-10	5210.0092	5210.0080	5210.0064	5210.0045
0	5210.0078	5210.0064	5210.0045	5210.0023
10	5210.0065	5210.0052	5210.0037	5210.0019
20	5210.0053	5210.0040	5210.0024	5210.0005
30	5210.0039	5210.0028	5210.0014	5209.9998
40	5210.0024	5210.0011	5209.9995	5209.9976
50	5210.0007	5209.9995	5209.9980	5209.9957
Max. Deviation (MHz)	0.0125	0.0109	0.0094	0.0070
Max. Deviation (ppm)	2.40	2.09	1.80	1.34
Result	Complies			

**Voltage vs. Frequency Stability**

Voltage	Measurement Frequency (MHz)			
(V)	5775 MHz			
	0 Minute	2 Minute	5 Minute	10 Minute
126.50	5775.0064	5775.0053	5775.0038	5775.0018
110.00	5775.0052	5775.0039	5775.0023	5775.0004
93.50	5775.0038	5775.0029	5775.0015	5774.9997
Max. Deviation (MHz)	0.0064	0.0053	0.0038	0.0018
Max. Deviation (ppm)	1.11	0.92	0.66	0.31
Result	Complies			

**Temperature vs. Frequency Stability**

Temperature	Measurement Frequency (MHz)			
(°C)	5775 MHz			
	0 Minute	2 Minute	5 Minute	10 Minute
-30	5775.0124	5775.0108	5775.0093	5775.0069
-20	5775.0106	5775.0093	5775.0076	5775.0055
-10	5775.0091	5775.0079	5775.0063	5775.0044
0	5775.0077	5775.0063	5775.0044	5775.0022
10	5775.0064	5775.0051	5775.0036	5775.0018
20	5775.0052	5775.0039	5775.0023	5775.0004
30	5775.0038	5775.0027	5775.0013	5774.9997
40	5775.0023	5775.0010	5774.9994	5774.9975
50	5775.0006	5774.9994	5774.9979	5774.9956
Max. Deviation (MHz)	0.0124	0.0108	0.0093	0.0069
Max. Deviation (ppm)	2.15	1.87	1.61	1.20
Result	Complies			



## 4.9. Antenna Requirements

### 4.9.1. Limit

Except for special regulations, the Low-power Radio-frequency Devices must not be equipped with any jacket for installing an antenna with extension cable. An intentional radiator shall be designed to ensure that no antenna other than that furnished by the responsible party shall be used with the device. The use of a permanently attached antenna or of an antenna that uses a unique coupling to the intentional radiator shall be considered sufficient to comply with the provisions of this Section. The manufacturer may design the unit so that the user can replace a broken antenna, but the use of a standard antenna jack or electrical connector is prohibited. Further, this requirement does not apply to intentional radiators that must be professionally installed.

### 4.9.2. Antenna Connector Construction

Please refer to section 3.3 in this test report; antenna connector complied with the requirements.

## 5. LIST OF MEASURING EQUIPMENTS

Instrument	Manufacturer	Model No.	Serial No.	Characteristics	Calibration Date	Remark
EMI Receiver	Agilent	N9038A	My52260123	9kHz ~ 8.45GHz	Jan. 27, 2016	Conduction (CO01-CB)
LISN	F.C.C.	FCC-LISN-50-16-2	04083	150kHz ~ 100MHz	Dec. 08, 2015	Conduction (CO01-CB)
LISN	Schwarzbeck	NSLK 8127	8127647	9kHz ~ 30MHz	Dec. 23, 2015	Conduction (CO01-CB)
COND Cable	Woken	Cable	01	150kHz ~ 30MHz	May 25, 2015	Conduction (CO01-CB)
Software	Audix	E3	6.120210n	-	N.C.R.	Conduction (CO01-CB)
Loop Antenna	Teseq	HLA 6120	24155	9kHz - 30 MHz	Mar. 16, 2016*	Radiation (O3CH01-CB)
BILOG ANTENNA	Schaffner	CBL6112D	37880	20MHz ~ 2GHz	Sep. 03, 2015	Radiation (O3CH01-CB)
Horn Antenna	EMCO	3115	00075790	750MHz ~ 18GHz	Oct. 22, 2015	Radiation (O3CH01-CB)
Horn Antenna	Schwarzbeck	BBHA 9170	BBHA9170252	15GHz ~ 40GHz	Jul. 21, 2015	Radiation (O3CH01-CB)
Pre-Amplifier	Agilent	8447D	2944A10991	0.1MHz ~ 1.3GHz	Mar. 15, 2016	Radiation (O3CH01-CB)
Pre-Amplifier	Agilent	8449B	3008A02310	1GHz ~ 26.5GHz	Jan. 18, 2016	Radiation (O3CH01-CB)
Pre-Amplifier	WM	TF-130N-R1	923365	26GHz ~ 40GHz	Nov. 13, 2015	Radiation (O3CH01-CB)
Spectrum Analyzer	R&S	FSP40	100056	9kHz ~ 40GHz	Oct. 27, 2015	Radiation (O3CH01-CB)
RF Cable-low	Woken	Low Cable-1	N/A	30 MHz ~ 1 GHz	Nov. 02, 2015	Radiation (O3CH01-CB)
RF Cable-high	Woken	High Cable-16	N/A	1 GHz ~ 18 GHz	Nov. 02, 2015	Radiation (O3CH01-CB)
RF Cable-high	Woken	High Cable-17	N/A	1 GHz ~ 18 GHz	Nov. 02, 2015	Radiation (O3CH01-CB)
RF Cable-high	Woken	High Cable-40G-1	N/A	18GHz ~ 40 GHz	Nov. 02, 2015	Radiation (O3CH01-CB)
RF Cable-high	Woken	High Cable-40G-2	N/A	18GHz ~ 40 GHz	Nov. 02, 2015	Radiation (O3CH01-CB)
Test Software	Audix	E3	6.2009-10-7	N/A	N/A	Radiation (O3CH01-CB)
Spectrum analyzer	R&S	FSV40	100979	9kHz~40GHz	Dec. 09, 2015	Conducted (TH01-CB)
Temp. and Humidity Chamber	Ten Billion	TTH-D3SP	TBN-931011	-30~100 degree	Jun. 02, 2015	Conducted (TH01-CB)
RF Cable-high	Woken	RG402	High Cable-6	1 GHz ~ 26.5 GHz	Nov. 02, 2015	Conducted (TH01-CB)

Instrument	Manufacturer	Model No.	Serial No.	Characteristics	Calibration Date	Remark
RF Cable-high	Woken	RG402	High Cable-7	1 GHz – 26.5 GHz	Nov. 02, 2015	Conducted (TH01-CB)
RF Cable-high	Woken	RG402	High Cable-8	1 GHz – 26.5 GHz	Nov. 02, 2015	Conducted (TH01-CB)
RF Cable-high	Woken	RG402	High Cable-9	1 GHz – 26.5 GHz	Nov. 02, 2015	Conducted (TH01-CB)
RF Cable-high	Woken	RG402	High Cable-10	1 GHz – 26.5 GHz	Nov. 02, 2015	Conducted (TH01-CB)
Power Sensor	Agilent	U2021XA	MY53410001	50MHz~18GHz	Nov. 02, 2015	Conducted (TH01-CB)

Note: Calibration Interval of instruments listed above is one year.

“\*” Calibration Interval of instruments listed above is two years.

N.C.R. means Non-Calibration required.

## 6. MEASUREMENT UNCERTAINTY

Test Items	Uncertainty	Remark
Conducted Emission (150kHz ~ 30MHz)	3.2 dB	Confidence levels of 95%
Radiated Emission (30MHz ~ 1,000MHz)	3.6 dB	Confidence levels of 95%
Radiated Emission (1GHz ~ 18GHz)	3.7 dB	Confidence levels of 95%
Radiated Emission (18GHz ~ 40GHz)	3.5 dB	Confidence levels of 95%
Conducted Emission	1.7 dB	Confidence levels of 95%