



# FCC TEST REPORT

for

**AirPlay speaker dock for IPod/iPhone/iPad**

**MODEL:JBL ONBEAT AIR**

**Brand: JBL**

**Test Report Number:**

**SZ110228B02-RP**

**Issued Date: April 27, 2011**

Issued for

**Harman Consumer, Inc.**

**8500 Balboa Blvd ., Northridge, CA 91329,UNITED STATES**

Issued by:

Compliance Certification Services Inc.

Linkuo Lab.

No. 81-1, Lane 210, Bade 2nd Rd., Lujhu Township,

Taoyuan County 33841, Taiwan( R.O.C.)

TEL: 886-3-324-0332

FAX: 886-3-324-5235

E-Mail: [service@ccsrf.com](mailto:service@ccsrf.com)



**Note:** This report shall not be reproduced except in full, without the written approval of Compliance Certification Services Inc. This document may be altered or revised by Compliance Certification Services Inc. personnel only, and shall be noted in the revision section of the document. The client should not use it to claim product endorsement by TAF, A2LA, NVLAP, NIST or any government agencies. The test results in the report only apply to the tested sample.



Revision History

Rev.	Issue No.	Revisions	Effect Page	Revised By
00	SZ110228B02-RP	Initial Issue	ALL	Ethan Huang



**TABLE OF CONTENTS**

**1 TEST CERTIFICATION ..... 4**

**2 TEST RESULT SUMMARY ..... 5**

**3 EUT DESCRIPTION..... 6**

**4 TEST METHODOLOGY..... 7**

    4.1. DESCRIPTION OF TEST MODES ..... 7

**5 SETUP OF EQUIPMENT UNDER TEST ..... 8**

    5.1. DESCRIPTION OF SUPPORT UNITS..... 8

    5.2. CONFIGURATION OF SYSTEM UNDER TEST ..... 8

**6 FACILITIES AND ACCREDITATIONS ..... 9**

    6.1. FACILITIES..... 9

    6.2. ACCREDITATIONS ..... 9

    6.3. MEASUREMENT UNCERTAINTY..... 9

**7 FCC PART 15.247 REQUIREMENTS ..... 10**

    7.1. POWER LINE CONDUCTED EMISSIONS MEASUREMENT ..... 10

    7.2. SPURIOUS EMISSIONS MEASUREMENT..... 14

    7.3. 6dB BANDWIDTH MEASUREMENT ..... 30

    7.4. PEAK OUTPUT POWER ..... 35

    7.5. BAND EDGES MEASUREMENT:..... 40

    7.6. PEAK POWER SPECTRAL DENSITY MEASUREMENT..... 52



# 1 TEST CERTIFICATION

<b>Product</b>	AirPlay speaker dock for IPod/iPhone/iPad
<b>Model</b>	JBL ONBEAT AIR
<b>Brand</b>	JBL
<b>Tested</b>	February 28 ~April 25, 2011
<b>Applicant</b>	Harman Consumer, Inc. 8500 Balboa Blvd ., Northridge, CA 91329, UNITED STATES
<b>Manufacturer</b>	Harman Consumer, Inc. 8500 Balboa Blvd ., Northridge, CA 91329, UNITED STATES

APPLICABLE STANDARDS			
Standard	Test Type	Standard	Test Type
15.207(a)	Power Line Conducted Emissions	15.247(d) 15.209(a)	<ul style="list-style-type: none"> <li>● Spurious Emissions</li> <li>● Conducted Measurement</li> <li>● Radiated Emissions</li> </ul>
15.247(a)(2)	6dB Bandwidth Measurement	15.247(b)(3) 15.247(b)(4)	Peak Power Measurement
15.247(d)	Band Edges Measurement	15.247(e)	Peak Power Spectral Density

### We hereby certify that:

The above equipment was tested by Compliance Certification Services Inc. The test data, data evaluation, test procedures, and equipment configurations shown in this report were made in accordance with the procedures given in **ANSI C63.4: 2003** and the energy emitted by the sample EUT tested as described in this report is in compliance with the requirements of FCC Rules Part 15.207, 15.209, 15.247.

The test results of this report relate only to the tested sample EUT identified in this report.

**Approved by:**

\_\_\_\_\_  
**Ethan Huang**  
 Section Manager  
 Compliance Certification Service Inc.

**Reviewed by:**

\_\_\_\_\_  
**Stan Lin**  
 Supervisor  
 Compliance Certification Service Inc.



## 2 TEST RESULT SUMMARY

APPLICABLE STANDARDS			
Standard	Test Type	Result	Remark
15.247(a)(2)	6dB Bandwidth Measurement	Pass	Meet the requirement of limit.
15.247(b)(3) 15.247(b)(4)	Peak Power Measurement	Pass	Meet the requirement of limit.
15.247(d)	Band Edges Measurement	Pass	Meet the requirement of limit.
15.247(e)	Peak Power Spectral Density	Pass	Meet the requirement of limit.
15.247(d) 15.209(a)	● Spurious Emissions ● Conducted Measurement ● Radiated Emissions	Pass	Meet the requirement of limit.
15.207(a)	Power line Conducted Emissions	Pass	Meet the requirement of limit.

Note: 1. The statements of test result on the above are decided by the request of test standard only; the measurement uncertainties are not factored into this compliance determination.  
2. The information of measurement uncertainty is available upon the customer's request.



### 3 EUT DESCRIPTION

<b>Product</b>	AirPlay speaker dock for IPod/iPhone/iPad
<b>Trade Name</b>	JBL
<b>Model Number</b>	JBL ONBEAT AIR
<b>Model Discrepancy</b>	N/A
<b>Serial Number</b>	SZ110228B02-RP
<b>Received Date</b>	February 28, 2011
<b>Power Supply</b>	DC13V supplied by the adapter
<b>Adapter Manufacturer / Model No.</b>	(1) Adapter 1: YJSO48A-1302500D I/P: 100-240Vac, 50/60Hz, 1.20A max O/P: 13Vdc, 2.5A AC Input Cable: Unshielded,1.95m DC Output Cable: Unshielded,1.85m (2) Adapter 2: SSA-60W-12 130250 I/P: 100-240Vac, 50/60Hz, 1.50A max O/P: 13Vdc, 2.5A AC Input Cable: Unshielded,1.95m DC Output Cable: Unshielded,1.85m
<b>Frequency Range</b>	IEEE 802.11b/g: 2412 ~ 2462 MHz
<b>Transmit Power</b>	IEEE 802.11b mode: 15.86dBm IEEE 802.11g mode: 18.65 dBm
<b>Modulation Technique</b>	IEEE 802.11b mode: DSSS(CCK,QPSK, BPSK) IEEE 802.11g mode: OFDM (BPSK/QPSK/16QAM/64QAM)
<b>Transmit Data Rate</b>	802.11b: 11Mbps(CCK) with fall back rates of 5.5/2/1Mbps 802.11g: 54Mbps with fall back rates of 48/36/24/18/12/9 /6Mbps
<b>Number of Channels</b>	IEEE 802.11b mode: 11 Channels IEEE 802.11g mode: 11 Channels
<b>Antenna Specification</b>	PIFA Antenna with 4.19dBi gain (Max)

**Note:** 1. The sample selected for test was engineering sample that approximated to production product and was provided by manufacturer.

2. This submittal(s) (test report) is intended for FCC ID: **TN5MAGAPGG** filing to comply with Section 15.207, 15.209 and 15.247 of the FCC Part 15, Subpart C Rules.



## 4 TEST METHODOLOGY

### 4.1. DESCRIPTION OF TEST MODES

The EUT has been tested under operating condition.

Software used to control the EUT for staying in continuous transmitting and receiving mode is programmed.

Test Item	Test mode	Worse mode
Conducted Emission	<b>Mode 1: Normal Link</b>	<input checked="" type="checkbox"/>
Radiated Emission	<b>Mode 1: Normal Link</b>	<input checked="" type="checkbox"/>

After verification, all tests were carried out with the worst case test modes as shown below except radiated spurious emission below 1GHz, which worst case was in normal link mode only, and power line conducted emission below 30MHz, which worst case was in normal link mode.

IEEE802.11b mode: Channel Low (2412MHz), Channel Mid (2437MHz) and Channel High (2462MHz) with 1Mbps data rate were chosen for full testing.

IEEE802.11g mode: Channel Low (2412MHz), Channel Mid (2437MHz) and Channel High (2462MHz) with 6Mbps data rate were chosen for full testing.



## 5 SETUP OF EQUIPMENT UNDER TEST

### 5.1. DESCRIPTION OF SUPPORT UNITS

The EUT has been tested as an independent unit together with other necessary accessories or support units. The following support units or accessories were used to form a representative test configuration during the tests.

No.	Equipment	Model No.	Serial No.	FCC ID	Trade Name	Data Cable	Power Cord
1	Notebook	2672	992F2VG	FCC DoC	IBM	Shielded 1.80m	N /A

**Note:**

- 1) All the equipment/cables were placed in the worst-case configuration to maximize the emission during the test.
- 2) Grounding was established in accordance with the manufacturer's requirements and conditions for the intended use.

### 5.2. CONFIGURATION OF SYSTEM UNDER TEST

See test photographs attached in Appendix II for the actual connections between EUT and support equipment.





## 6 FACILITIES AND ACCREDITATIONS

### 6.1. FACILITIES

All measurement facilities used to collect the measurement data are located at **No. 81-1, Lane 210, Bade 2nd Rd., Lujhu Township, Taoyuan County 33841, Taiwan (R.O.C.)**

The sites are constructed in conformance with the requirements of ANSI C63.4, ANSI C63.7 and CISPR Publication 22. All receiving equipment conforms to CISPR Publication 16-1, "Radio Interference Measuring Apparatus and Measurement Methods."

### 6.2. ACCREDITATIONS

Our laboratories are accredited and approved by the following accreditation body according to ISO/IEC 17025.

Taiwan	TAF
USA	A2LA

The measuring facility of laboratories has been authorized or registered by the following approval agencies.

USA	FCC
Japan	VCCI
Canada	INDUSTRY CANADA
Taiwan	BSMI
Norway	Nemko

Copies of granted accreditation certificates are available for downloading from our web site, <http://www.ccsrf.com>

### 6.3. MEASUREMENT UNCERTAINTY

Where relevant, the following measurement uncertainty levels have been estimated for tests performed on the EUT as specified in CISPR 16-4-2:

Measurement	Frequency	Uncertainty
Conducted emissions	9kHz~30MHz	+/- 3.18dB
Radiated emissions	30MHz ~ 200MHz	+/- 3.79dB
	200MHz ~1000MHz	+/- 3.62dB
	Above 1000MHz	+/- 5.04dB
Band Edges	+/-0.182 dB	

This uncertainty represents an expanded uncertainty expressed at approximately the 95% confidence level using a coverage factor of k=2.

The measured result is above (below) the specification limit by a margin less than the measurement uncertainty; it is therefore not possible to state compliance based on the 95% level of confidence. However, the result indicates that compliance (non-compliance) is more probable than non-compliance) with the specification limit.



## 7 FCC PART 15.247 REQUIREMENTS

### 7.1. POWER LINE CONDUCTED EMISSIONS MEASUREMENT

#### 7.1.1. LIMITS OF CONDUCTED EMISSIONS MEASUREMENT

According to §15.207(a), except as shown in paragraphs (b) and (c) of this section, for an intentional radiator that is designed to be connected to the public utility (AC) power line, the radio frequency voltage that is conducted back onto the AC power line on any frequency or frequencies within the band 150 kHz to 30 MHz shall not exceed the limits in the following table, as measured using a 50 μH/50 ohms line impedance stabilization network (LISN). Compliance with the provisions of this paragraph shall be based on the measurement of the radio frequency voltage between each power line and ground at the power terminal. The lower limit applies at the boundary between the frequency ranges.

Frequency Range (MHz)	Limits (dBμV)	
	Quasi-peak	Average
0.15 to 0.50	66 to 56*	56 to 46*
0.50 to 5	56	46
5 to 30	60	50

**NOTE:**

- (1) The lower limit shall apply at the transition frequencies.
- (2) The limit decreases in line with the logarithm of the frequency in the range of 0.15 to 0.50 MHz.
- (3) All emanations from a class A/B digital device or system, including any network of conductors and apparatus connected thereto, shall not exceed the level of field strengths specified above.

#### 7.1.2. TEST INSTRUMENTS

Conducted Emission Test Site					
Name of Equipment	Manufacturer	Model Number	Serial Number	Last Calibration	Due Calibration
ESCI EMI TEST RECEIVE.ESCI	ROHDE&SCHWARZ	ESCI	100783	03/21/2011	03/21/2012
Attenuator	SCHAFFNER	CFL9206	1711	07/14/2010	07/14/2011
LISN	SCHAFFNER	NNB42	2001/001	05/26/2010	05/26/2011
LISN	EMCO	3825/2	8901-1459	03/21/2011	03/21/2012
Current Probe	STODDART AIRCRAFT	91550-1	345-73	03/21/2011	03/21/2012
Temp. / Humidity Meter	VICTOR	VC230	N/A	03/30/2011	03/30/2012

- NOTE:** 1. The calibration interval of the above test instruments is 12 months and the calibrations are traceable to NML/ROC and NIST/USA.  
 2. N.C.R = No Calibration Request.



**7.1.3. TEST PROCEDURES** (please refer to measurement standard)

- The EUT and Support equipment, if needed, was placed on a non-conducted table, which is 0.8m above the ground plane and 0.4m away from the conducted wall.
- The test equipment EUT installed received AC main power, through a Line Impedance Stabilization Network (LISN), which supplied power source and was grounded to the ground plane. All support equipment power received from a second LISN. The two LISNs provide 50 ohm/ 50uH of coupling impedance for the measuring instrument.
- The EUT test program was started. Emissions were measured on each current carrying line of the EUT using an EMI Test Receiver connected to the LISN powering the EUT.
- The frequency range from 150 kHz to 30 MHz was searched. The test data of the worst-case condition(s) was recorded. Emission levels under limit 20dB were not recorded.



7.1.4. TEST SETUP

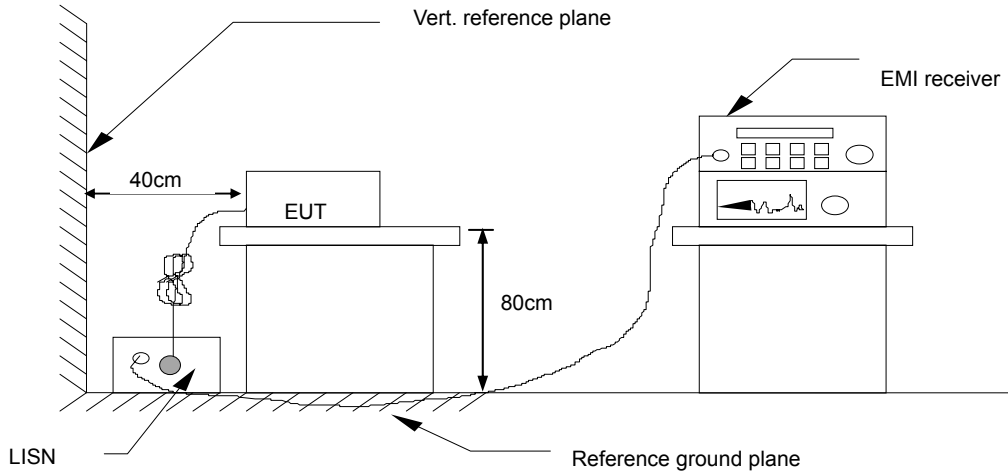

- For the actual test configuration, please refer to the related item - Photographs of the Test Configuration.

7.1.5. Data Sample:

Freq. (MHz)	Q.P. Level (dBuV)	AVG Level (dBuV)	Cor. Factor (dB)	Q.P. Result (dBuV)	AVG Result (dBuV)	Q.P. Limit (dBuV)	AVG Limit (dBuV)	Q.P. Margin (dB)	AVG Margin (dB)	Line (L1/L2)
xx.xx	37.86	32.92	11.52	49.38	44.44	60.41	50.41	-11.03	-5.97	L1

- Freq. = Emission frequency in MHz
- Level = Uncorrected Analyzer/Receiver reading
- Factor = Insertion loss of LISN + Cable Loss
- Result = Level+ Factor
- Limit = Limit stated in standard
- Margin = Reading in reference to limit
- P = Peak Reading
- Q.P = Quasi-peak Reading
- AVG = Average Reading
- L1 = Hot side
- L2 = Neutral side

**Calculation Formula**

Margin (dB) = Result (dBuV) – Limit (dBuV)



7.1.6. TEST RESULTS

<b>Model No.</b>	JBL ONBEAT AIR	<b>Test Mode</b>	Normal Link
<b>Environmental Conditions</b>	20deg.C,45% RH	<b>RBW,VBW</b>	9 kHz
<b>Tested by</b>	Sunday Hu		

(The chart below shows the highest readings taken from the final data.)

Frequency Range Investigated (150 kHz to 30 MHz)										
Freq. (MHz)	Q.P. Level (dBuV)	AVG Level (dBuV)	Cor. Factor (dB)	Q.P. Result (dBuV)	AVG Result (dBuV)	Q.P. Limit (dBuV)	AVG Limit (dBuV)	Q.P. Margin (dB)	AVG Margin (dB)	Line (L1/L2)
0.274	33.56	21.98	11.52	45.08	33.50	60.99	50.99	-15.91	-17.49	L1
0.438	33.07	21.28	11.51	44.58	32.79	57.10	47.10	-12.52	-14.31	L1
0.554	35.52	21.39	11.51	47.03	32.90	56.00	46.00	-8.97	-13.10	L1
1.114	38.24	30.03	11.52	49.76	41.55	56.00	46.00	-6.24	-4.45	L1
4.410	28.20	24.31	11.65	39.85	35.96	56.00	46.00	-16.15	-10.04	L1
17.346	31.02	23.41	12.38	43.40	35.79	60.00	50.00	-16.60	-14.21	L1
0.266	34.23	21.33	11.53	45.76	32.86	61.24	51.24	-15.48	-18.38	L2
0.454	33.18	24.17	11.54	44.72	35.71	56.80	46.80	-12.08	-11.09	L2
0.554	35.28	25.36	11.54	46.82	36.90	56.00	46.00	-9.18	-9.10	L2
1.118	33.96	26.51	11.52	45.48	38.03	56.00	46.00	-10.52	-7.97	L2
4.410	31.67	27.95	11.65	43.32	39.60	56.00	46.00	-12.68	-6.40	L2
17.722	29.17	21.37	12.31	41.48	33.68	60.00	50.00	-18.52	-16.32	L2

- NOTE:**
1. The measuring frequencies range between 0.15 MHz and 30 MHz.
  2. The emissions measured in the frequency range between 0.15 MHz and 30MHz were made with an instrument using Quasi-peak detector and Average detector.
  3. “---” denotes the emission level was or more than 2dB below the Average limit, and no re-check was made.
  4. The IF bandwidth of SPA between 0.15MHz and 30MHz was 10KHz. The IF bandwidth of test Receiver between 0.15MHz and 30MHz was 9kHz.
  5. L1 = Line One (Live Line) / L2 = Line Two (Neutral Line).



## 7.2. SPURIOUS EMISSIONS MEASUREMENT

### 7.2.1. LIMITS OF CONDUCTED EMISSIONS MEASUREMENT

According to §15.247(d), in any 100 kHz bandwidth outside the frequency bands in which the spread spectrum intentional radiator is operating, the radio frequency power that is produced by the intentional radiator shall be at least 20 dB below that in the 100 kHz bandwidth within the band that contains the highest level of the desired power, based on either an RF conducted or a radiated measurement, provided the transmitter demonstrates compliance with the peak conducted power limits. In addition, radiated emissions which fall in the restricted bands, as defined in §15.205(a), must also comply with the radiated emission limits specified in 15.209(a) (see Section 15.205(c)).

### 7.2.2. TEST INSTRUMENTS

Name of Equipment	Manufacturer	Model	Serial Number	Last Calibration	Due Calibration
Spectrum Analyzer	Agilent	E4446A	US44300399	03/21/2011	03/21/2012

### 7.2.3. TEST PROCEDURE (please refer to measurement standard)

Conducted RF measurements of the transmitter output were made to confirm that the EUT antenna port conducted emissions meet the specified limit and to identify any spurious signals that require further investigation or measurements on the radiated emissions site. The transmitter output is connected to the spectrum analyzer. The resolution bandwidth is set to 100 kHz. The video bandwidth is set to 100 kHz.

Measurements are made over the 30MHz to 26GHz range with the transmitter set to the lowest, middle, and highest channels.



7.2.4. TEST RESULTS

Test Plot

(IEEE 802.11b mode)

CH Low (30MHz ~26.5GHz)

Agilent 22:38:46 Mar 30, 2011

R T

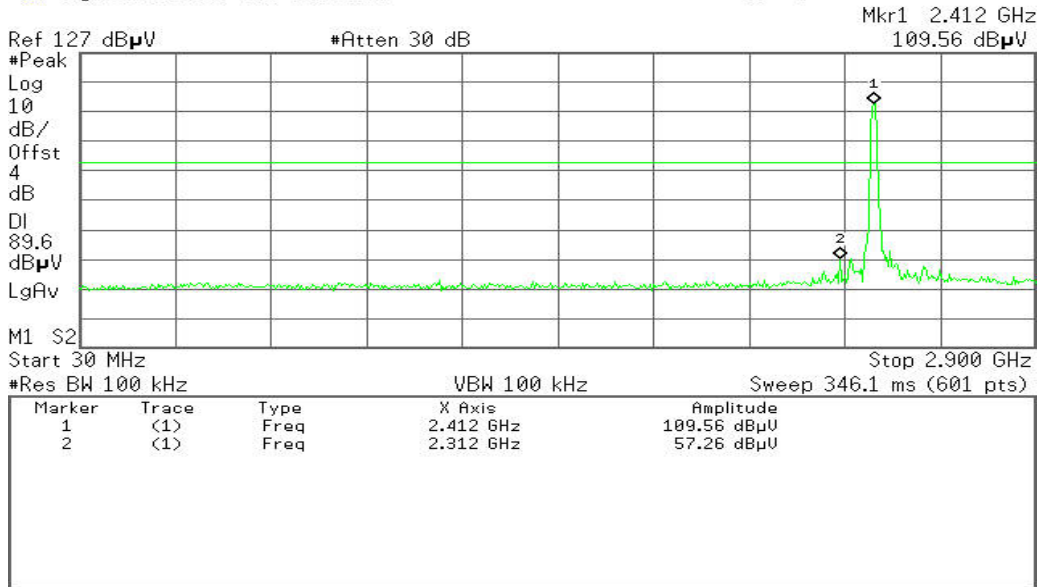

CH Mid(30MHz ~26.5GHz)

Agilent 22:35:53 Mar 30, 2011

R T

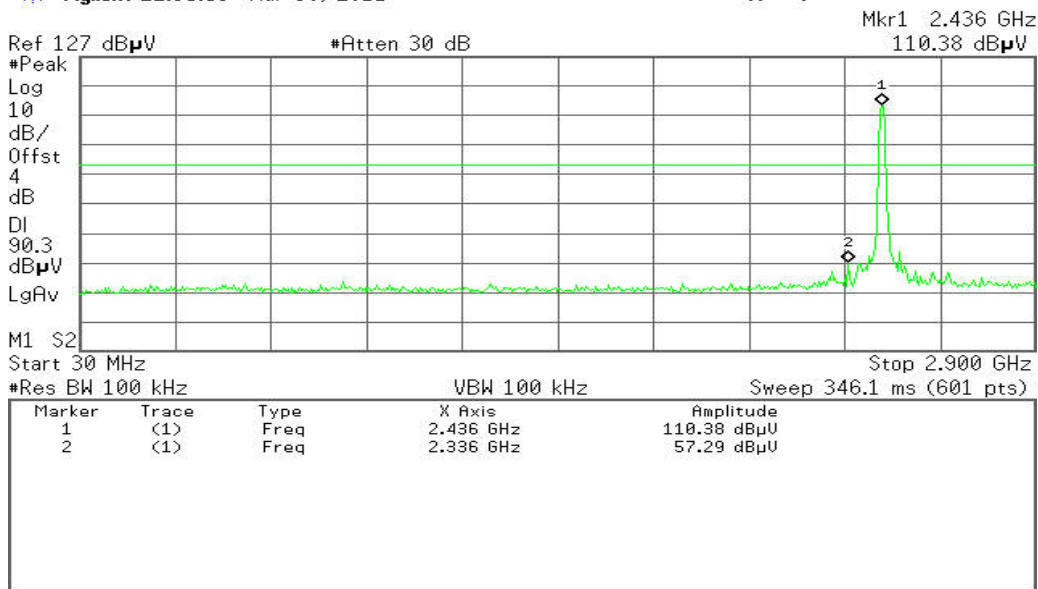



CH High (30MHz~26.5GHz)

Agilent 22:31:40 Mar 30, 2011

R T

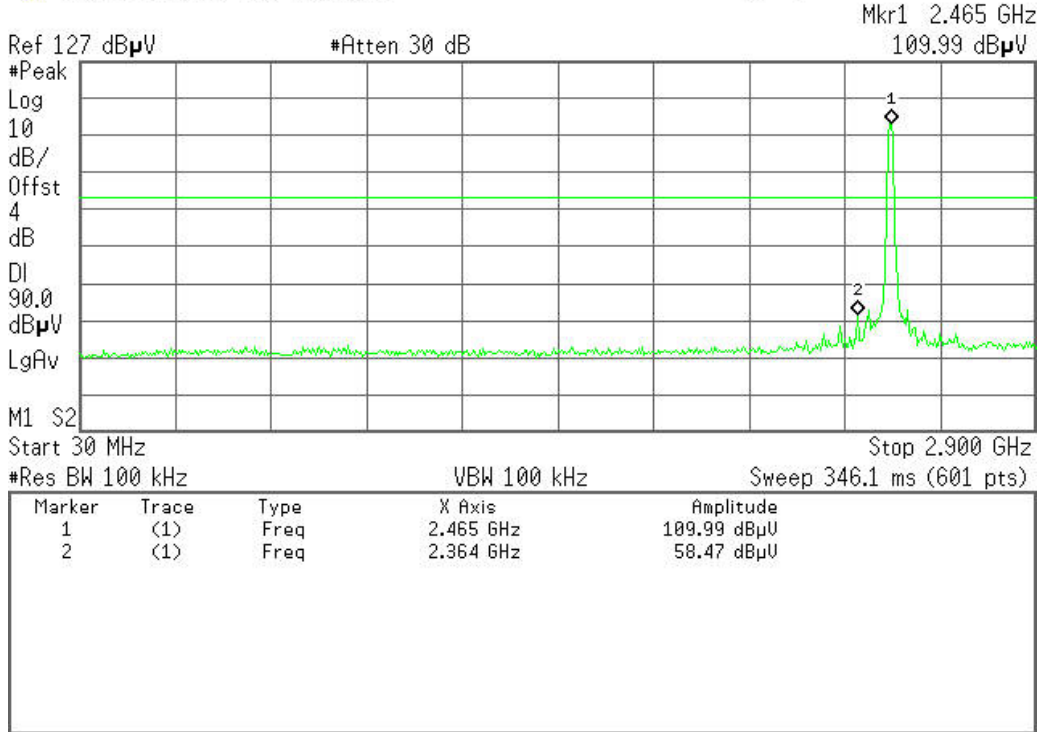





(IEEE 802.11g mode)

CH Low (30MHz ~26.5GHz)

Agilent 22:39:29 Mar 30, 2011

R T

Mkr1 25.20 GHz  
60.42 dBμV

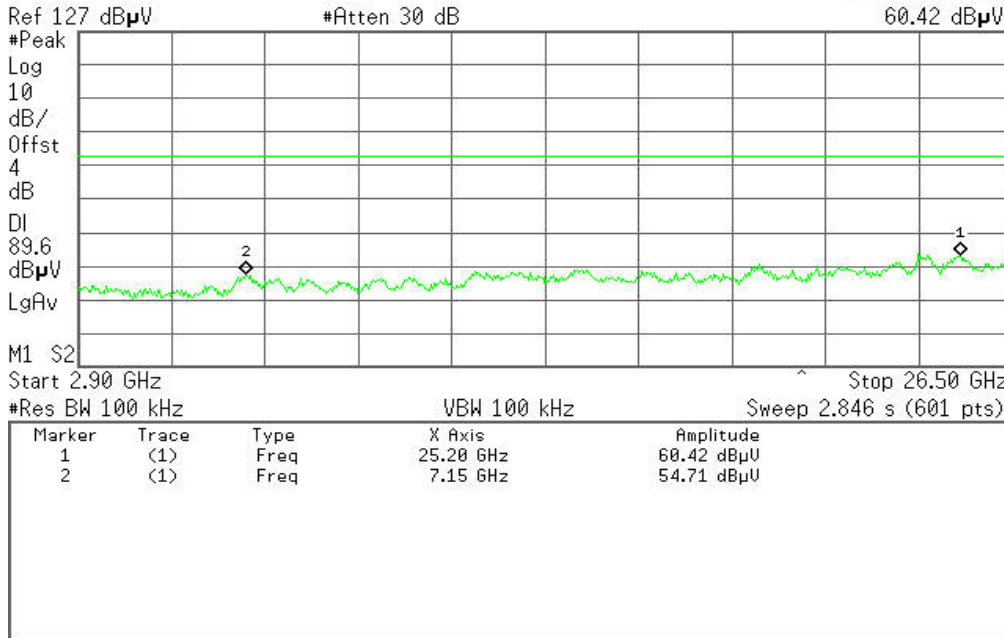

CH Mid(30MHz ~26.5GHz)

Agilent 22:37:51 Mar 30, 2011

R T

Mkr2 25.12 GHz  
61.66 dBμV

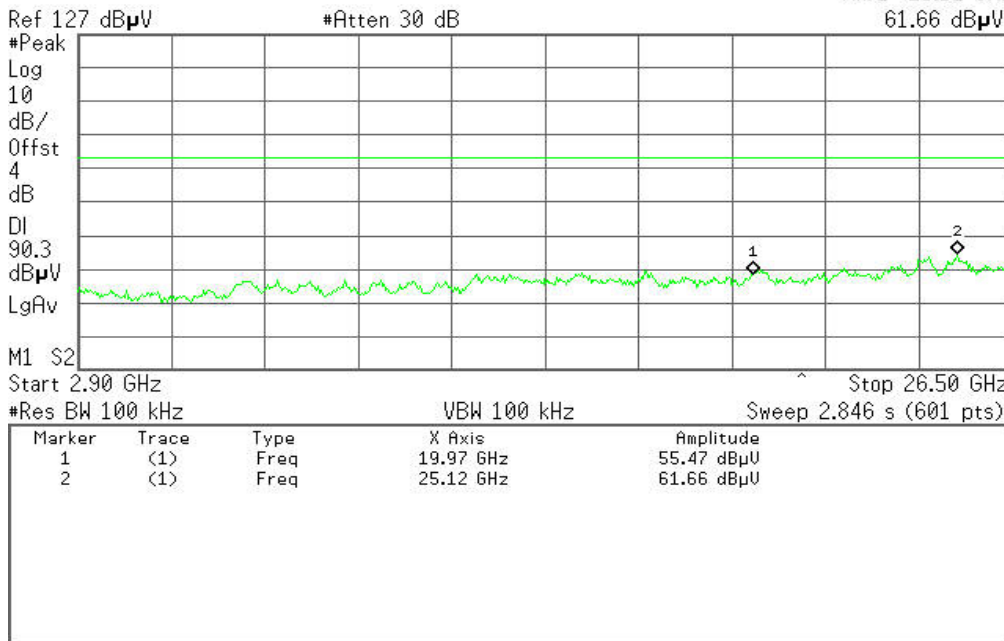



### CH High (30MHz ~26.5GHz)

Agilent 22:34:31 Mar 30, 2011

R T

Mkr2 25.16 GHz

Ref 127 dB $\mu$ V

#Atten 30 dB

60.51 dB $\mu$ V

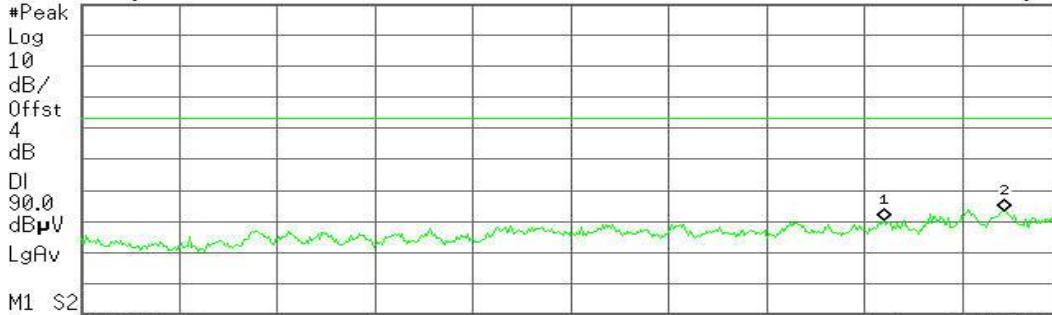

#Res BW 100 kHz VBW 100 kHz Sweep 2.846 s (601 pts)

Marker	Trace	Type	X Axis	Amplitude
1	(1)	Freq	22.25 GHz	57.13 dB $\mu$ V
2	(1)	Freq	25.16 GHz	60.51 dB $\mu$ V



7.2.4.1. LIMITS OF RADIATED EMISSIONS MEASUREMENT

1. According to §15.209(a), except as provided elsewhere in this Subpart, the emissions from an intentional radiator shall not exceed the field strength levels specified in the following table:

Frequency (MHz)	Field Strength (µV/m)	Measurement Distance (m)
30-88	100*	3
88-216	150*	3
216-960	200*	3
Above 960	500	3

Remark: Except as provided in paragraph (g), fundamental emissions from intentional radiators operating under this Section shall not be located in the frequency bands 54-72 MHz, 76-88 MHz, 174-216 MHz or 470-806 MHz. However, operation within these frequency bands is permitted under other sections of this Part, e.g., Sections 15.231 and 15.241.

2. In the emission table above, the tighter limit applies at the band edges.

Frequency (MHz)	Field Strength (µV/m at 3-meter)	Field Strength (dBµV/m at 3-meter)
30-88	100	40
88-216	150	43.5
216-960	200	46
Above 960	500	54

NOTE: (1) The lower limit shall apply at the transition frequencies.

(2) Emission level (dBuV/m) = 20 log Emission level (uV/m).



7.2.4.2. TEST INSTRUMENTS

Radiated Emission Test Site 966 (2)					
Name of Equipment	Manufacturer	Model Number	Serial Number	Last Calibration	Due Calibration
PSA Series Spectrum Analyzer	Agilent	E4446A	US44300399	03/21/2011	03/21/2012
Amplifier	MITEQ	AM-1604-3000	1411843	03/21/2011	03/21/2012
Turn Table	EMCO	2081-1.21	N/A	N.C.R	N.C.R
Controller	CT	N/A	N/A	N.C.R	N.C.R
High Noise Amplifier	Agilent	8449B	3008A01838	06/18/2010	06/18/2011
Site NSA	C&C	N/A	N/A	N.C.R	N.C.R
Bilog Antenna	SCHAFFNER	CBL6143	5082	06/18/2010	06/18/2011
Horn Antenna	SCHWARZBECK	BBHA9120D	D286	03/19/2010	03/19/2011
Signal Generator	Anritsu	MG3694A	#050125	03/21/2011	03/21/2012
Horn Antenna	TRC	HA0301	N/A	03/19/2010	03/19/2011
Loop Antenna	A.R.A	PLA-1030/B	1029	03/19/2010	03/19/2011
Power Sensor	Anritsu	MA2491A	030619	06/18/2010	06/18/2011
Power Meter	Anritsu	ML2487A	6K00001491	06/18/2010	06/18/2011
Temp. / Humidity Meter	VICTOR	VC230	N/A	03/30/2011	03/30/2012

- NOTE:** 1. The calibration interval of the above test instruments is 12 months and the calibrations are traceable to NML/ROC and NIST/USA.  
 2. The FCC Site Registration number is 101879.  
 3. N.C.R = No Calibration Required.

7.2.4.3. TEST PROCEDURE (please refer to measurement standard)

- The EUT is placed on a turntable, which is 0.8m above ground plane.
- The turntable shall be rotated for 360 degrees to determine the position of maximum emission level.
- EUT is set 3m away from the receiving antenna, which is varied from 1m to 4m to find out the highest emissions.
- Maximum procedure was performed on the six highest emissions to ensure EUT compliance.
- And also, each emission was to be maximized by changing the polarization of receiving antenna both horizontal and vertical.
- Set the spectrum analyzer in the following setting as:
  - Below 1GHz:
    - RBW=100kHz / VBW=300kHz / Sweep=AUTO
  - Above 1GHz:
    - (a) PEAK: RBW=VBW=1MHz / Sweep=AUTO
    - (b) AVERAGE: RBW=1MHz / VBW=10Hz / Sweep=AUTO
- Repeat above procedures until the measurements for all frequencies are complete.



### 7.2.4.4. TEST SETUP

#### Below 30MHz

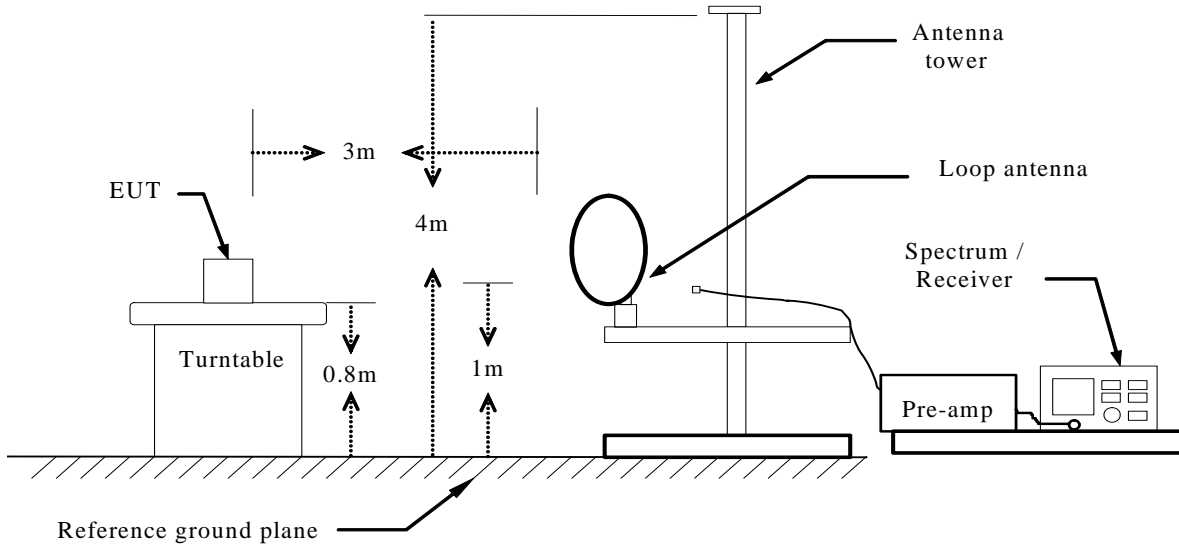

#### Below 1 GHz

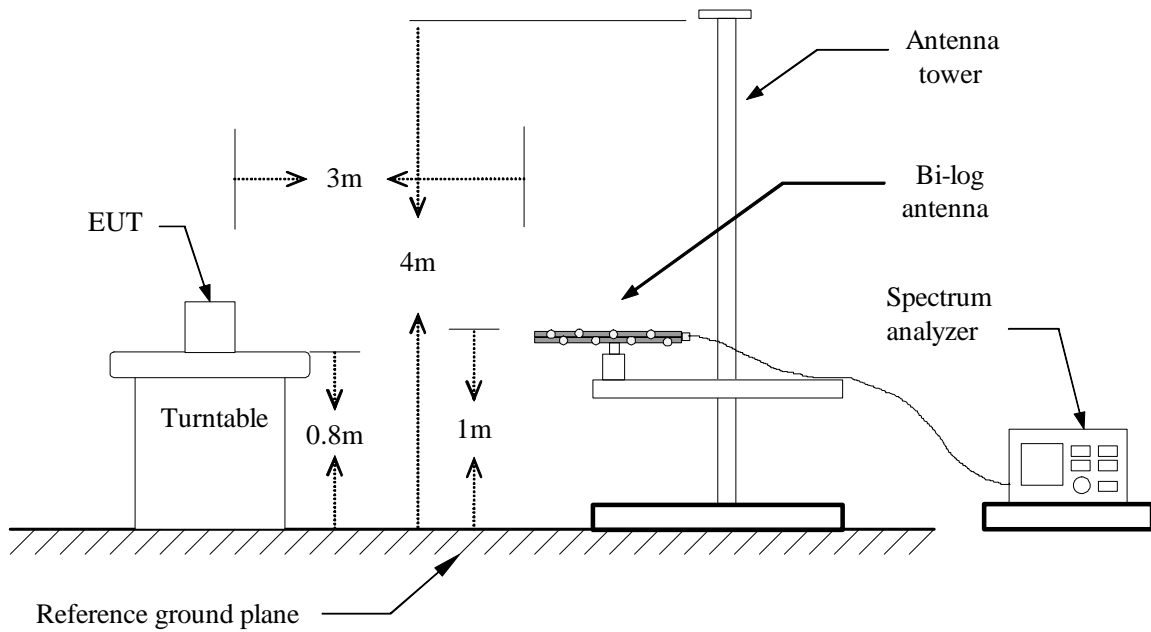



Above 1 GHz

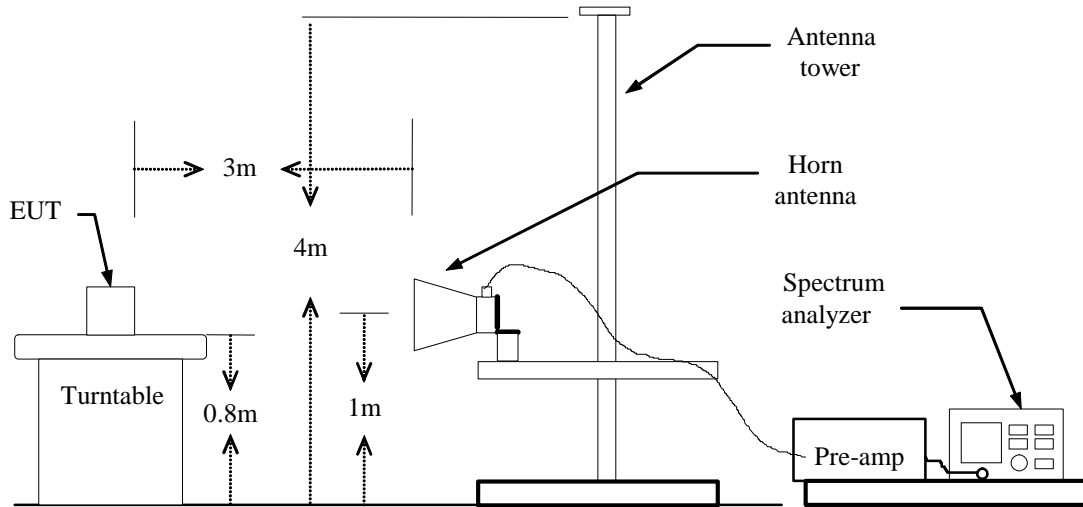

For the actual test configuration, please refer to the related item – Photographs of the Test Configuration.

7.2.4.5. Data Sample:

**Below 1 GHz**

Frequency (MHz)	Ant.Pol. (H/V)	Reading (Remark) (dBuV)	Correction Factor (dB/m)	Result (Remark) (dBuV/m)	Limit (Peak) (dBuV/m)	Margin (dB)	Remark
xxx	V	12.12	10.21	22.33	40.00	-17.67	Peak

**Above 1 GHz**

Frequency (MHz)	Ant.Pol. (H/V)	Reading (Peak) (dBuV)	Reading (Average) (dBuV)	Correction Factor (dB/m)	Result (Peak) (dBuV/m)	Result (Average) (dBuV/m)	Limit (Peak) (dBuV/m)	Limit (Average) (dBuV/m)	Margin (dB)	Remark
xxx	V	65.45	63.00	-11.12	54.33	51.88	74.00	54.00	-2.12	AVG

- Frequency (MHz) = Emission frequency in MHz
- Ant.Pol. (H/V) = Antenna polarization
- Reading (dBuV) = Uncorrected Analyzer / Receiver reading
- Correction Factor (dB/m) = Antenna factor + Cable loss – Amplifier gain
- Result (dBuV/m) = Reading (dBuV) + Correction Factor (dB/m)
- Limit (dBuV/m) = Limit stated in standard
- Margin (dB) = Remark Result (dBuV/m) – Limit (dBuV/m)
- Peak = Peak Reading
- QP = Quasi-peak Reading
- AVG = Average Reading



7.2.4.6. TEST RESULTS

Below 1 GHz

Operation Mode: Normal Link

Test Date: April 24, 2011

Temperature: 24°C

Tested by: Sunday Hu

Humidity: 52% RH

Polarity: Ver. / Hor.

Freq. (MHz)	Ant. Pol. H/V	Detector Mode (PK/QP)	Reading (dBuV)	Factor (dB)	Actual FS (dBuV/m)	Limit 3m (dBuV/m)	Safe Margin (dB)
47.783	V	Peak	53.84	-19.56	34.28	40.00	-5.72
89.816	V	Peak	56.35	-24.94	31.41	43.50	-12.09
222.383	V	Peak	50.71	-20.15	30.56	46.00	-15.44
246.633	V	Peak	52.14	-20.45	31.69	46.00	-14.31
266.033	V	Peak	55.06	-19.63	35.43	46.00	-10.57
610.383	V	Peak	44.00	-12.26	31.74	46.00	-14.26
47.783	H	Peak	56.31	-19.56	36.75	40.00	-3.25
148.016	H	Peak	57.22	-21.12	36.10	43.50	-7.40
170.650	H	Peak	58.71	-22.36	36.35	43.50	-7.15
266.033	H	Peak	54.77	-19.63	35.14	46.00	-10.86
654.033	H	Peak	40.86	-12.02	28.84	46.00	-17.16
835.100	H	Peak	36.52	-9.67	26.85	46.00	-19.15

\*\*Remark: No emission found between lowest internal used/generated frequency to 30MHz.

Notes:

- Measuring frequencies from 9kHz to the 1GHz.
- Radiated emissions measured in frequency range from 30MHz to 1GHz were made with an instrument using Peak/Quasi-peak detector mode.
- Data of measurement within this frequency range shown " --- " in the table above means the reading of emissions are attenuated more than 20dB below the permissible limits or the field strength is too small to be measured.
- The IF bandwidth of SPA between 30MHz to 1GHz was 100kHz.
- |                    |  |
|--------------------|--|
| Freq(MHz)          | = Emission frequency in MHz                    |
| Reading (dBuV/m)   | = Receiver reading                             |
| Corr. Factor (dB)  | = Antenna factor + Cable loss – Amplifier gain |
| Actual FS (dBuV/m) | = Reading (dBuV) + Corr. Factor (dB/m)         |
| Limit (dBuV/m)     | = Limit stated in standard                     |
| Safe Margin(dB)    | = Measured (dBuV/m) – Limits (dBuV/m)          |
| Ant. H/V           | = Current carrying line of reading             |
| Detector           | = Mark Peak Reading or Quasi-peak Reading      |



Above 1 GHz

Operation Mode: TX / IEEE 802.11b / CH Low
Temperature: 24°C
Humidity: 52% RH

Test Date: April 19, 2011
Tested by: Sunday Hu
Polarity: Ver. / Hor.

Table with 11 columns: Freq. (MHz), Ant. Pol H/V, Peak Reading (dBuV), AV Reading (dBuV), Ant. / CL CF (dB), Actual Fs (Peak, AV), Peak Limit (dBuV/m), AV Limit (dBuV/m), Margin (dB), Remark. Rows include frequencies like 1466.666, 1921.666, 3800.000, 4371.666, 1245.000, 1501.666, 3193.333, 4406.666.

REMARKS:

- 1. Measuring frequencies from 1 GHz to the 10th harmonic of highest fundamental frequency.
2. Radiated emissions measured in frequency above 1000MHz were made with an instrument using peak/average detector mode.
3. Average test would be performed if the peak result were greater than the average limit or as required by the applicant.
4. Data of measurement within this frequency range shown " --- " in the table above means the reading of emissions are attenuated more than 20dB below the permissible limits or the field strength is too small to be measured.
5. Measurements above show only up to 6 maximum emissions noted, or would be lesser, with " N/A " remark, if no specific emissions from the EUT are recorded (ie: margin>20dB from the applicable limit) and considered that's already beyond the background noise floor.
6. Margin (dB) = Remark result (dBuV/m) – Average limit (dBuV/m).





Operation Mode: TX / IEEE 802.11b / CH Mid
Temperature: 24°C
Humidity: 52% RH

Test Date: April 19, 2011
Tested by: Sunday Hu
Polarity: Ver. / Hor.

Table with 11 columns: Freq. (MHz), Ant. Pol H/V, Peak Reading (dBuV), AV Reading (dBuV), Ant. / CL CF (dB), Actual Fs (Peak and AV), Peak Limit (dBuV/m), AV Limit (dBuV/m), Margin (dB), Remark. It contains two identical data blocks for frequencies 1245.000, 1466.666, 1910.000, and 4476.666 MHz, plus an N/A row.

REMARKS:

- 1. Measuring frequencies from 1 GHz to the 10th harmonic of highest fundamental frequency.
2. Radiated emissions measured in frequency above 1000MHz were made with an instrument using peak/average detector mode.
3. Average test would be performed if the peak result were greater than the average limit or as required by the applicant.
4. Data of measurement within this frequency range shown " --- " in the table above means the reading of emissions are attenuated more than 20dB below the permissible limits or the field strength is too small to be measured.
5. Measurements above show only up to 6 maximum emissions noted, or would be lesser, with " N/A " remark, if no specific emissions from the EUT are recorded (ie: margin>20dB from the applicable limit) and considered that's already beyond the background noise floor.
6. Margin (dB) = Remark result (dBuV/m) – Average limit (dBuV/m).



Operation Mode: TX / IEEE 802.11b / CH High
Temperature: 24°C
Humidity: 52% RH

Test Date: April 20, 2011
Tested by: Sunday Hu
Polarity: Ver. / Hor.

Table with 11 columns: Freq. (MHz), Ant. Pol H/V, Peak Reading (dBuV), AV Reading (dBuV), Ant. / CL CF (dB), Actual Fs (Peak, AV), Peak Limit (dBuV/m), AV Limit (dBuV/m), Margin (dB), Remark. Rows include frequencies like 1233.333, 1571.666, 1910.000, 3916.666, 1326.666, 3193.333, 3881.666, 4943.333.

REMARKS:

- 1. Measuring frequencies from 1 GHz to the 10th harmonic of highest fundamental frequency.
2. Radiated emissions measured in frequency above 1000MHz were made with an instrument using peak/average detector mode.
3. Average test would be performed if the peak result were greater than the average limit or as required by the applicant.
4. Data of measurement within this frequency range shown " --- " in the table above means the reading of emissions are attenuated more than 20dB below the permissible limits or the field strength is too small to be measured.
5. Measurements above show only up to 6 maximum emissions noted, or would be lesser, with " N/A " remark, if no specific emissions from the EUT are recorded (ie: margin>20dB from the applicable limit) and considered that's already beyond the background noise floor.
6. Margin (dB) = Remark result (dBuV/m) – Average limit (dBuV/m).



Operation Mode: TX / IEEE 802.11g / CH Low
Temperature: 24°C
Humidity: 52% RH

Test Date: April 19, 2011
Tested by: Sunday Hu
Polarity: Ver. / Hor.

Table with 11 columns: Freq. (MHz), Ant. Pol H/V, Peak Reading (dBuV), AV Reading (dBuV), Ant. / CL CF (dB), Actual Fs (Peak, AV), Peak Limit (dBuV/m), AV Limit (dBuV/m), Margin (dB), Remark. Rows include frequencies like 1245.000, 1840.000, 1910.000, 4010.000, 1571.666, 2155.000, 3765.000, 4943.333.

REMARKS:

- 1. Measuring frequencies from 1 GHz to the 10th harmonic of highest fundamental frequency.
2. Radiated emissions measured in frequency above 1000MHz were made with an instrument using peak/average detector mode.
3. Average test would be performed if the peak result were greater than the average limit or as required by the applicant.
4. Data of measurement within this frequency range shown " --- " in the table above means the reading of emissions are attenuated more than 20dB below the permissible limits or the field strength is too small to be measured.
5. Measurements above show only up to 6 maximum emissions noted, or would be lesser, with " N/A " remark, if no specific emissions from the EUT are recorded (ie: margin>20dB from the applicable limit) and considered that's already beyond the background noise floor.
6. Margin (dB) = Remark result (dBuV/m) – Average limit (dBuV/m).



Operation Mode: TX / IEEE 802.11g / CH Mid
Temperature: 24°C
Humidity: 52 % RH

Test Date: April 20, 2011
Tested by: Sunday Hu
Polarity: Ver. / Hor.

Table with 11 columns: Freq. (MHz), Ant. Pol H/V, Peak Reading (dBuV), AV Reading (dBuV), Ant. / CL CF (dB), Actual Fs (Peak, AV), Peak Limit (dBuV/m), AV Limit (dBuV/m), Margin (dB), Remark. Rows include frequencies like 1198.333, 1466.666, 1921.666, 3193.333, 1326.666, 1735.000, 3811.666, 4920.000.

REMARKS:

- 1. Measuring frequencies from 1 GHz to the 10th harmonic of highest fundamental frequency.
2. Radiated emissions measured in frequency above 1000MHz were made with an instrument using peak/average detector mode.
3. Average test would be performed if the peak result were greater than the average limit or as required by the applicant.
4. Data of measurement within this frequency range shown " --- " in the table above means the reading of emissions are attenuated more than 20dB below the permissible limits or the field strength is too small to be measured.
5. Measurements above show only up to 6 maximum emissions noted, or would be lesser, with " N/A " remark, if no specific emissions from the EUT are recorded (ie: margin>20dB from the applicable limit) and considered that's already beyond the background noise floor.
6. Margin (dB) = Remark result (dBuV/m) – Average limit (dBuV/m).



**Operation Mode:** TX / IEEE 802.11g / CH High      **Test Date:** April 19, 2011  
**Temperature:** 24°C      **Tested by:** Sunday Hu  
**Humidity:** 52 % RH      **Polarity:** Ver. / Hor.

Freq. (MHz)	Ant. Pol H/V	Peak Reading (dBuV)	AV Reading (dBuV)	Ant. / CL CF (dB)	Actual Fs		Peak Limit (dBuV/m)	AV Limit (dBuV/m)	Margin (dB)	Remark
					Peak (dBuV/m)	AV (dBuV/m)				
1245.000	V	53.38	---	-11.18	42.20	---	74.00	54.00	-11.80	Peak
1910.000	V	52.07	---	-9.65	42.42	---	74.00	54.00	-11.58	Peak
3228.333	V	47.16	---	-5.43	41.73	---	74.00	54.00	-12.27	Peak
4406.666	V	46.55	---	-2.24	44.31	---	74.00	54.00	-9.69	Peak
N/A										
1326.666	H	50.52	---	-10.72	39.80	---	74.00	54.00	-14.20	Peak
3695.000	H	46.89	---	-3.84	43.05	---	74.00	54.00	-10.95	Peak
4908.333	H	45.11	---	-0.30	44.81	---	74.00	54.00	-9.19	Peak
5690.000	H	44.81	---	1.99	46.80	---	74.00	54.00	-7.20	Peak
N/A										

**REMARKS:**

1. Measuring frequencies from 1 GHz to the 10th harmonic of highest fundamental frequency.
2. Radiated emissions measured in frequency above 1000MHz were made with an instrument using peak/average detector mode.
3. Average test would be performed if the peak result were greater than the average limit or as required by the applicant.
4. Data of measurement within this frequency range shown " --- " in the table above means the reading of emissions are attenuated more than 20dB below the permissible limits or the field strength is too small to be measured.
5. Measurements above show only up to 6 maximum emissions noted, or would be lesser, with " N/A " remark, if no specific emissions from the EUT are recorded (ie: margin>20dB from the applicable limit) and considered that's already beyond the background noise floor.
6. Margin (dB) = Remark result (dBuV/m) – Average limit (dBuV/m).



### 7.3. 6dB BANDWIDTH MEASUREMENT

#### 7.3.1. LIMITS

According to §15.247(a)(2), systems using digital modulation techniques may operate in the 902 - 928 MHz, 2400 - 2483.5 MHz, and 5725 - 5850 MHz bands. The minimum 6 dB bandwidth shall be at least 500 kHz.

#### 7.3.2. TEST INSTRUMENTS

Name of Equipment	Manufacturer	Model	Serial Number	Last Calibration	Calibration Due
Spectrum Analyzer	Agilent	E4446A	US44300399	03/21/2011	03/21/2012

#### 7.3.3. TEST PROCEDURES (please refer to measurement standard)

1. Place the EUT on the table and set it in the transmitting mode.
2. Remove the antenna from the EUT and then connect a low loss RF cable from the antenna port to the spectrum analyzer.
3. Set the spectrum analyzer as RBW = 100kHz, VBW = 300kHz, Span = 25MHz, Sweep = auto.
4. Mark the peak frequency and -6dB (upper and lower) frequency.
5. Repeat until all the rest channels are investigated.

#### 7.3.4. TEST SETUP

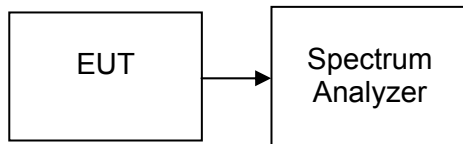



7.3.5. TEST RESULTS

No non-compliance noted

**Test Data**

Test mode: IEEE 802.11b

Channel	Frequency (MHz)	Bandwidth (kHz)	Limit (kHz)	Test Result
Low	2412	12575	>500	PASS
Mid	2437	12584		PASS
High	2462	12575		PASS

**Test Data**

Test mode: IEEE 802.11g

Channel	Frequency (MHz)	Bandwidth (kHz)	Limit (kHz)	Test Result
Low	2412	16366	>500	PASS
Mid	2437	16383		PASS
High	2462	16361		PASS



Test Plot

(IEEE 802.11b mode)

6dB Bandwidth (CH Low)

Agilent 21:41:55 Mar 30, 2011

R T

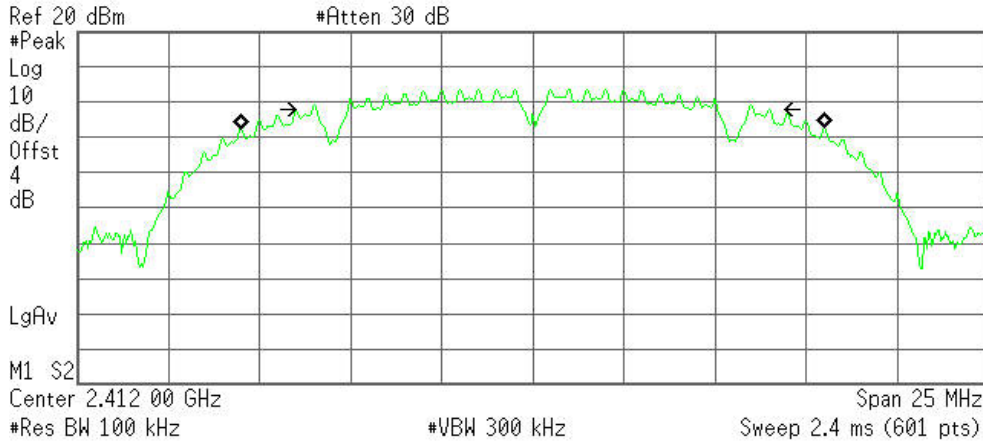

Occupied Bandwidth  
16.0144 MHz

Occ BW % Pwr 99.00 %  
x dB -6.00 dB

Transmit Freq Error 984.423 Hz  
x dB Bandwidth 12.575 MHz

6dB Bandwidth (CH Mid)

Agilent 21:43:48 Mar 30, 2011

R T

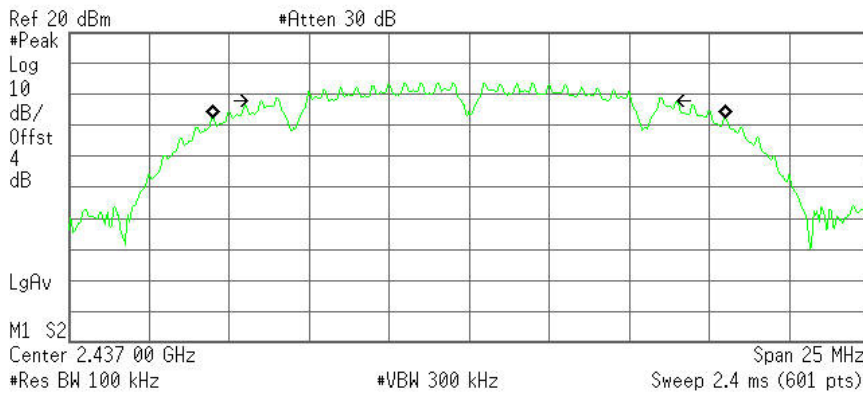

Occupied Bandwidth  
16.0200 MHz

Occ BW % Pwr 99.00 %  
x dB -6.00 dB

Transmit Freq Error -3.444 kHz  
x dB Bandwidth 12.584 MHz





### 6dB Bandwidth (CH High)

Agilent 21:44:29 Mar 30, 2011

R T

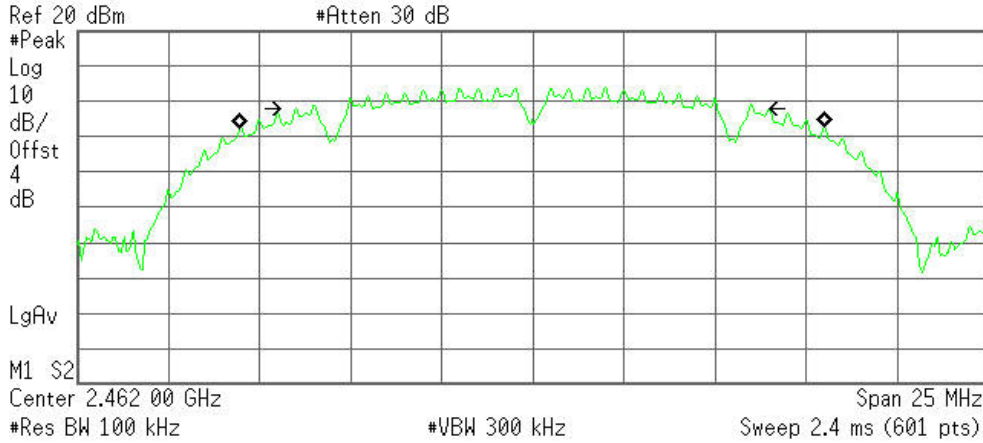

Occupied Bandwidth  
16.0244 MHz

Occ BW % Pwr 99.00 %  
x dB -6.00 dB

Transmit Freq Error -11.758 kHz  
x dB Bandwidth 12.575 MHz

### (IEEE 802.11g mode)

### 6dB Bandwidth (CH Low)

Agilent 21:42:30 Mar 30, 2011

R T

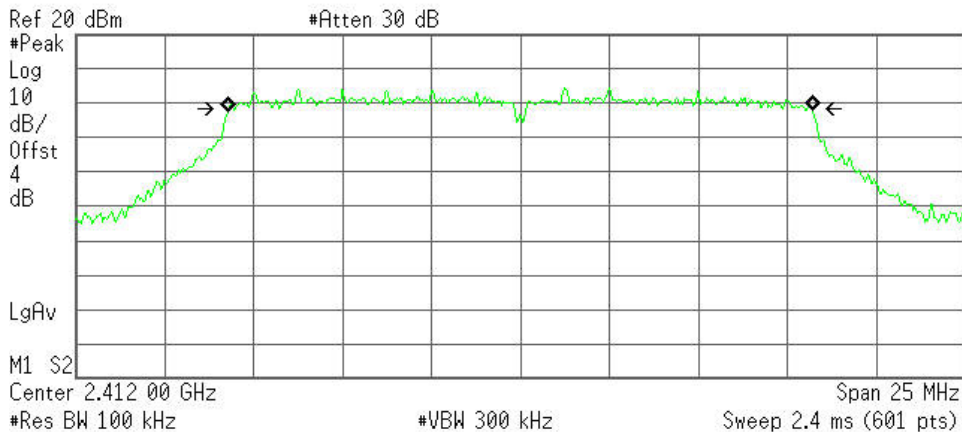

Occupied Bandwidth  
16.3982 MHz

Occ BW % Pwr 99.00 %  
x dB -6.00 dB

Transmit Freq Error -7.722 kHz  
x dB Bandwidth 16.366 MHz



### 6dB Bandwidth (CH Mid)

Agilent 21:43:07 Mar 30, 2011

R T

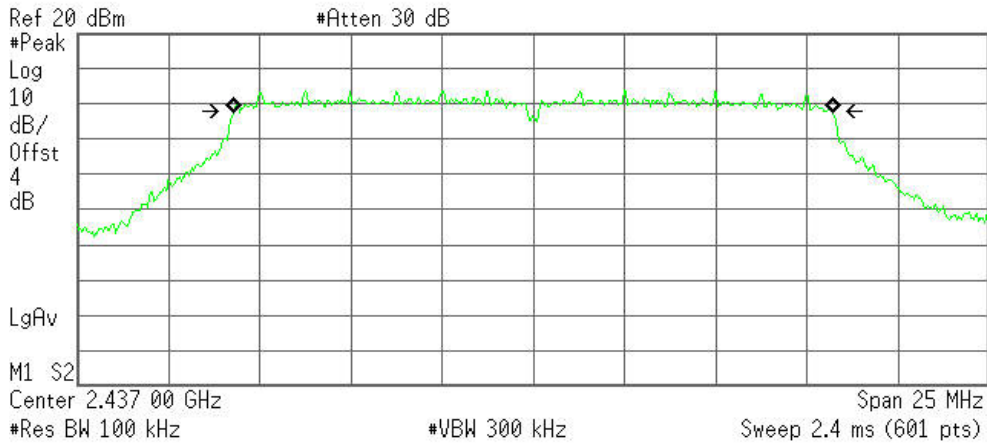

Occupied Bandwidth  
16.4096 MHz

Occ BW % Pwr 99.00 %  
x dB -6.00 dB

Transmit Freq Error -5.591 kHz  
x dB Bandwidth 16.383 MHz

### 6dB Bandwidth (CH High)

Agilent 21:45:00 Mar 30, 2011

R T

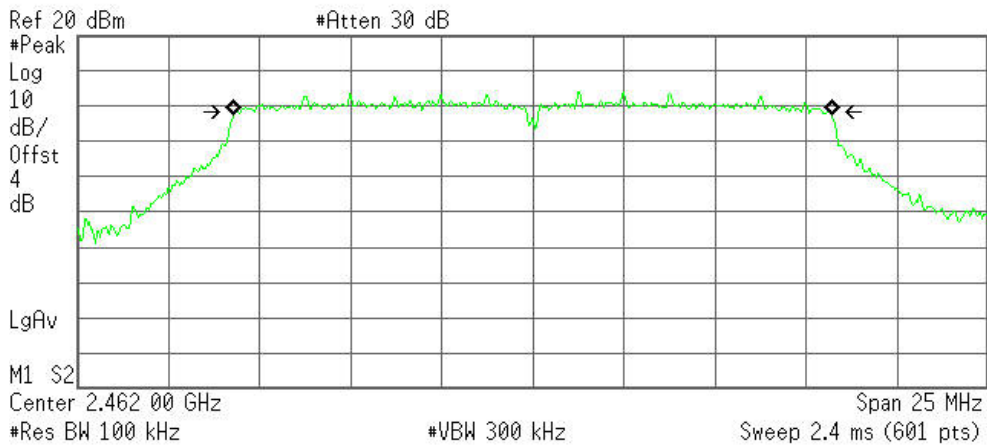

Occupied Bandwidth  
16.4066 MHz

Occ BW % Pwr 99.00 %  
x dB -6.00 dB

Transmit Freq Error -3.136 kHz  
x dB Bandwidth 16.361 MHz



### 7.4. PEAK OUTPUT POWER

#### 7.4.1. LIMITS

The maximum peak output power of the intentional radiator shall not exceed the following:

1. According to §15.247(b)(3), for systems using digital modulation in the bands of 902-928 MHz, 2400-2483.5 MHz, and 5725-5850 MHz: 1 Watt.
2. According to §15.247(b)(4), the conducted output power limit specified in paragraph (b) of this section is based on the use of antennas with directional gains that do not exceed 6 dBi. Except as shown in paragraph (c) of this section, if transmitting antennas of directional gain greater than 6 dBi are used, the conducted output power from the intentional radiator shall be reduced below the stated values in paragraphs (b)(1), (b)(2), and (b)(3) of this section, as appropriate, by the amount in dB that the directional gain of the antenna exceeds 6 dBi.

#### 7.4.2. TEST INSTRUMENTS

Name of Equipment	Manufacturer	Model	Serial Number	Last Calibration	Calibration Due
Spectrum Analyzer	Agilent	E4446A	US44300399	03/21/2011	03/21/2012

#### 7.4.3. TEST PROCEDURES (please refer to measurement standard)

1. Set span to encompass the entire emission bandwidth (EBW) of the signal.
2. Set RBW = 1 MHz.
3. Set VBW ≥ 3 MHz.
4. Use sample detector mode if bin width (i.e., span/number of points in spectrum display) < 0.5 RBW. Otherwise use peak detector mode.
5. Use a video trigger with the trigger level set to enable triggering only on full power pulses. Transmitter must operate at full control power for entire sweep of every sweep. If the device transmits continuously, with no off intervals or reduced power intervals, the trigger may be set to “free run”.
6. Trace average 100 traces in power averaging mode.
7. Compute power by integrating the spectrum across the 26 dB EBW of the signal. The integration can be performed using the spectrum analyzer’s band power measurement function with band limits set equal to the EBW band edges or by summing power levels in each 1 MHz band in linear power terms. The 1 MHz band power levels to be summed can be obtained by averaging, in linear power terms, power levels in each frequency bin across the 1 MHz.

#### 7.4.4. TEST SETUP

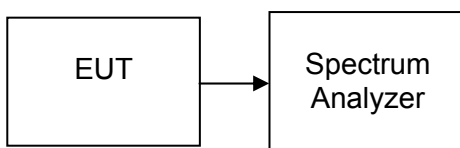



7.4.5. TEST RESULTS

No non-compliance noted

**Test Data**

Test mode: IEEE 802.11b

Channel	Frequency (MHz)	Output Power (dBm)	Output Power (W)	Limit (W)	Result
Low	2412	15.49	0.03540	1	PASS
Mid	2437	15.58	0.03614		PASS
High	2462	15.86	0.03855		PASS

Test mode: IEEE 802.11g

Channel	Frequency (MHz)	Output Power (dBm)	Output Power (W)	Limit (W)	Result
Low	2412	18.49	0.07063	1	PASS
Mid	2437	18.65	0.07328		PASS
High	2462	18.07	0.06412		PASS



**Test Plot**

(IEEE 802.11b mode)

**Peak power (CH Low)**

Agilent 17:21:16 Mar 28, 2011

R T

Mkr1 2.412 00 GHz  
5.64 dBm

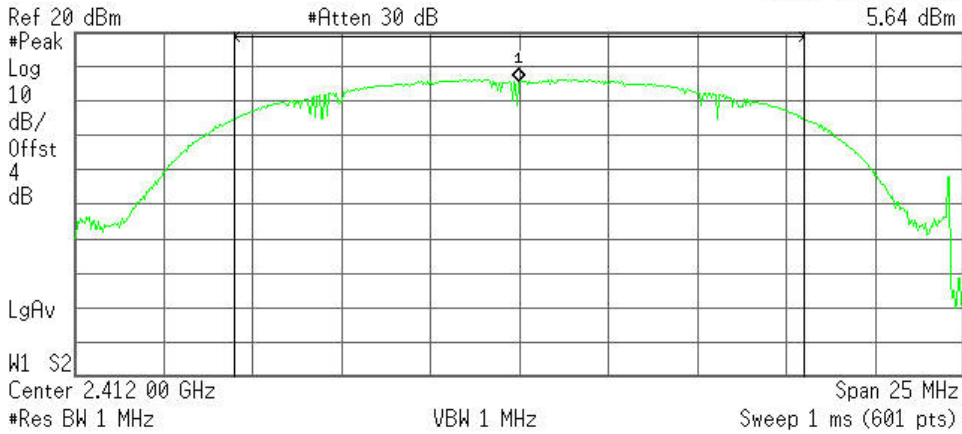

**Channel Power**

15.49 dBm /16.0000 MHz

**Power Spectral Density**

-56.55 dBm/Hz

**Peak power (CH Mid)**

Agilent 17:23:11 Mar 28, 2011

R T

Mkr1 2.437 00 GHz  
5.95 dBm

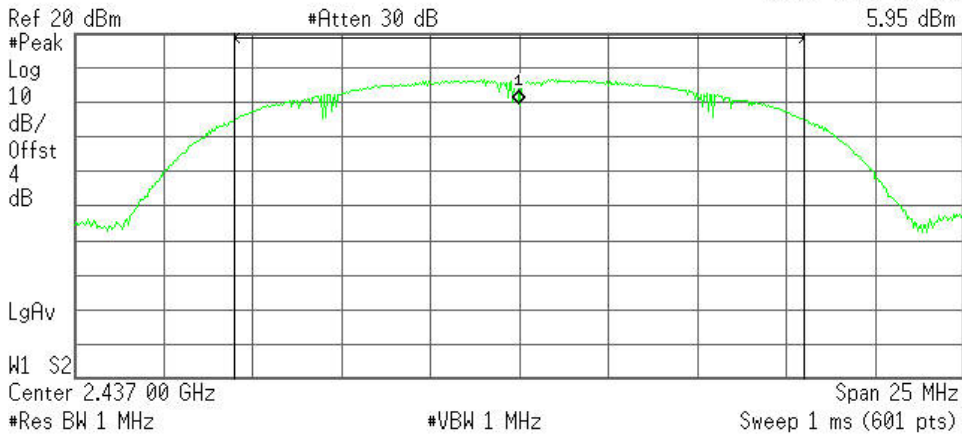

**Channel Power**

15.58 dBm /16.0000 MHz

**Power Spectral Density**

-56.46 dBm/Hz



### Peak power (CH High)

Agilent 17:26:39 Mar 28, 2011

R T

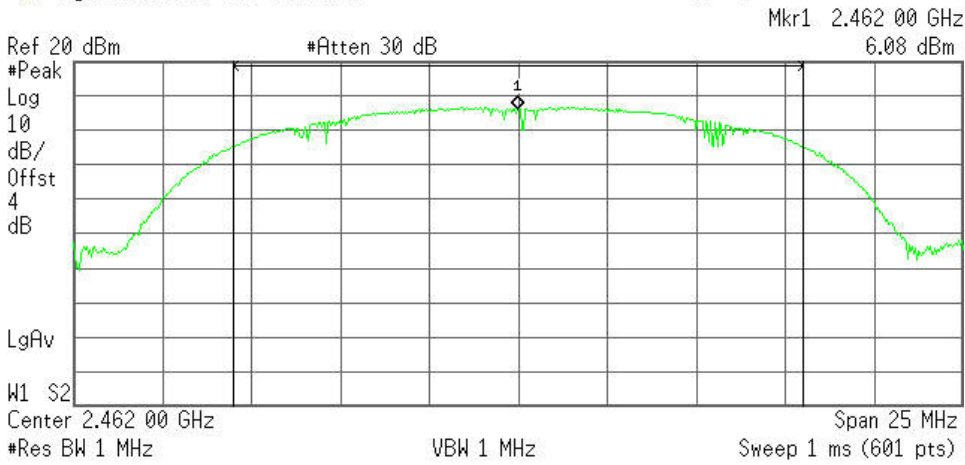

Channel Power

15.86 dBm /16.0000 MHz

Power Spectral Density

-56.18 dBm/Hz

### (IEEE 802.11g mode)

### Peak power (CH Low)

Agilent 17:56:13 Mar 28, 2011

R T

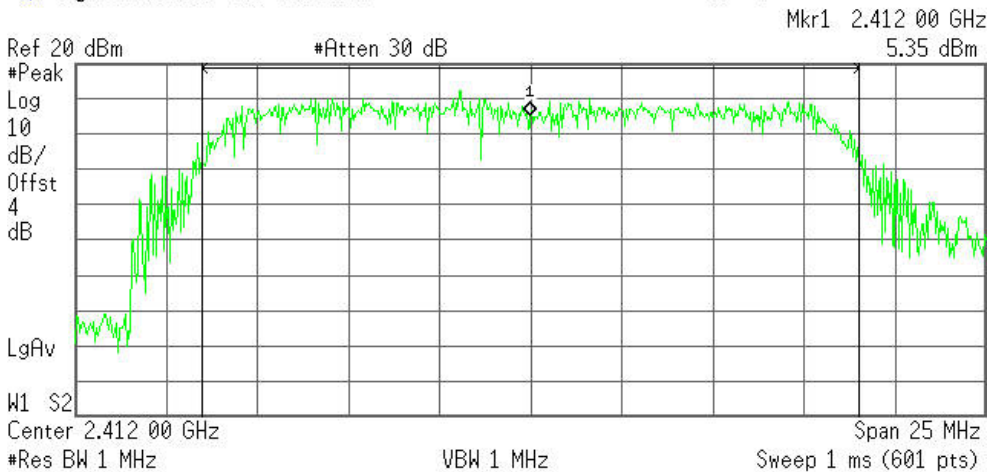

Channel Power

18.49 dBm /18.0000 MHz

Power Spectral Density

-54.06 dBm/Hz



**Peak power (CH Mid)**

Agilent 22:41:51 Mar 30, 2011

R T

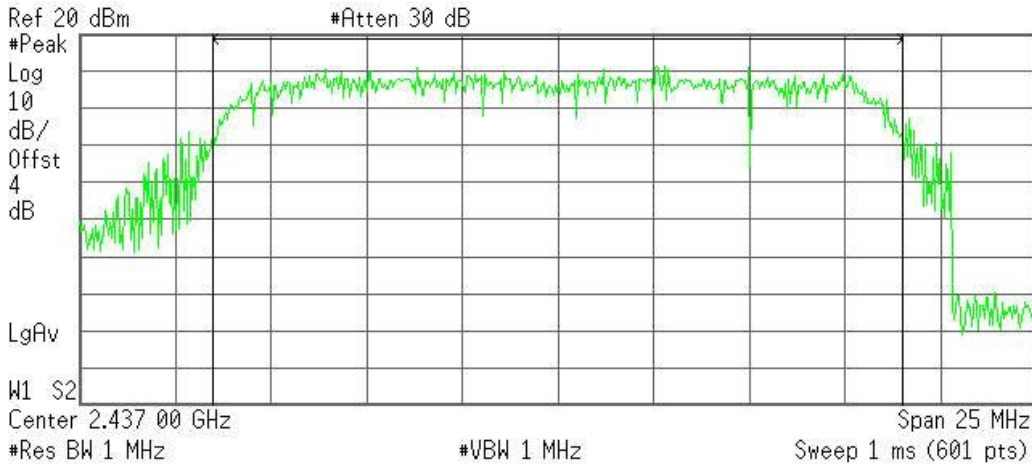

**Channel Power**

18.65 dBm /18.0000 MHz

**Power Spectral Density**

-59.22 dBm/Hz

**Peak power (CH High)**

Agilent 17:33:55 Mar 28, 2011

R T

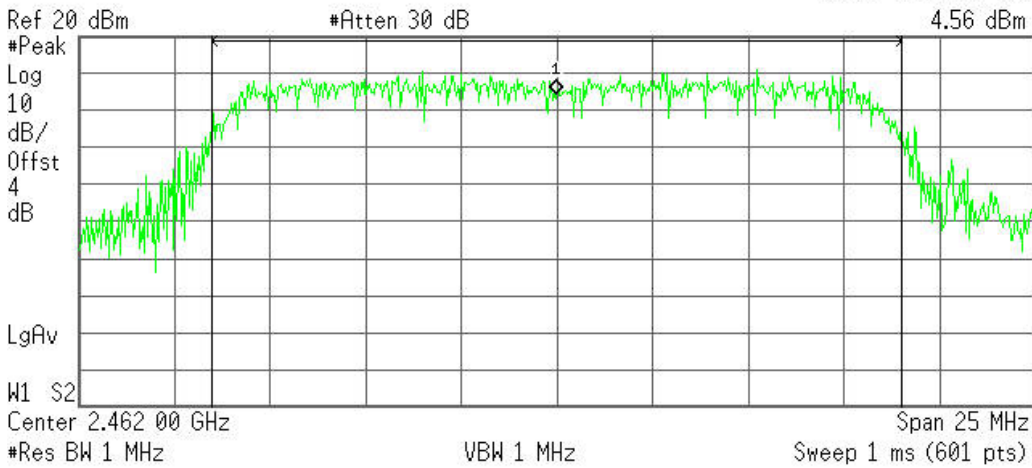

**Channel Power**

18.07 dBm /18.0000 MHz

**Power Spectral Density**

-54.48 dBm/Hz





### 7.5. BAND EDGES MEASUREMENT

#### 7.5.1. LIMITS

According to §15.247(d), in any 100 kHz bandwidth outside the frequency bands in which the spread spectrum intentional radiator is operating, the radio frequency power that is produced by the intentional radiator shall be at least 20 dB below that in the 100 kHz bandwidth within the band that contains the highest level of the desired power, based on either an RF conducted or a radiated measurement, provided the transmitter demonstrates compliance with the peak conducted power limits. In addition, radiated emissions which fall in the restricted bands, as defined in §15.205(a), must also comply with the radiated emission limits specified in 15.209(a) (see Section 15.205(c)).

#### 7.5.2. TEST INSTRUMENTS

Radiated Emission Test Site 966 (2)					
Name of Equipment	Manufacturer	Model Number	Serial Number	Last Calibration	Due Calibration
PSA Series Spectrum Analyzer	Agilent	E4446A	US44300399	03/21/2011	03/21/2012
Amplifier	MITEQ	AM-1604-3000	1411843	03/21/2011	03/21/2012
Turn Table	EMCO	2081-1.21	N/A	N.C.R	N.C.R
Controller	CT	N/A	N/A	N.C.R	N.C.R
High Noise Amplifier	Agilent	8449B	3008A01838	06/18/2010	06/18/2011
Site NSA	C&C	N/A	N/A	N.C.R	N.C.R
Bilog Antenna	SCHAFFNER	CBL6143	5082	06/18/2010	06/18/2011
Horn Antenna	SCHWARZBECK	BBHA9120D	D286	03/19/2010	03/19/2011
Signal Generator	Anritsu	MG3694A	#050125	03/21/2011	03/21/2012
Horn Antenna	TRC	HA0301	N/A	03/19/2010	03/19/2011
Loop Antenna	A.R.A	PLA-1030/B	1029	03/19/2010	03/19/2011
Power Sensor	Anritsu	MA2491A	030619	06/18/2010	06/18/2011
Power Meter	Anritsu	ML2487A	6K00001491	06/18/2010	06/18/2011
Temp. / Humidity Meter	VICTOR	VC230	N/A	03/30/2011	03/30/2012

- NOTE:** 1. The calibration interval of the above test instruments is 12 months and the calibrations are traceable to NML/ROC and NIST/USA.  
 2. The FCC Site Registration number is 101879.  
 3. N.C.R = No Calibration Required.





**7.5.3. TEST PROCEDURES** (please refer to measurement standard)

1. The EUT is placed on a turntable, which is 0.8m above the ground plane.
2. The turntable shall be rotated for 360 degrees to determine the position of maximum emission level.
3. EUT is set 3m away from the receiving antenna, which is varied from 1m to 4m to find out the highest emission.
4. Set the spectrum analyzer in the following setting in order to capture the lower and upper band-edges of the emission:
  - (a) PEAK: RBW=VBW=1MHz / Sweep=AUTO
  - (b) AVERAGE: RBW=1MHz / VBW=10Hz / Sweep=AUTO
5. Repeat the procedures until all the PEAK and AVERAGE versus POLARIZATION are

**7.5.4. TEST SETUP**

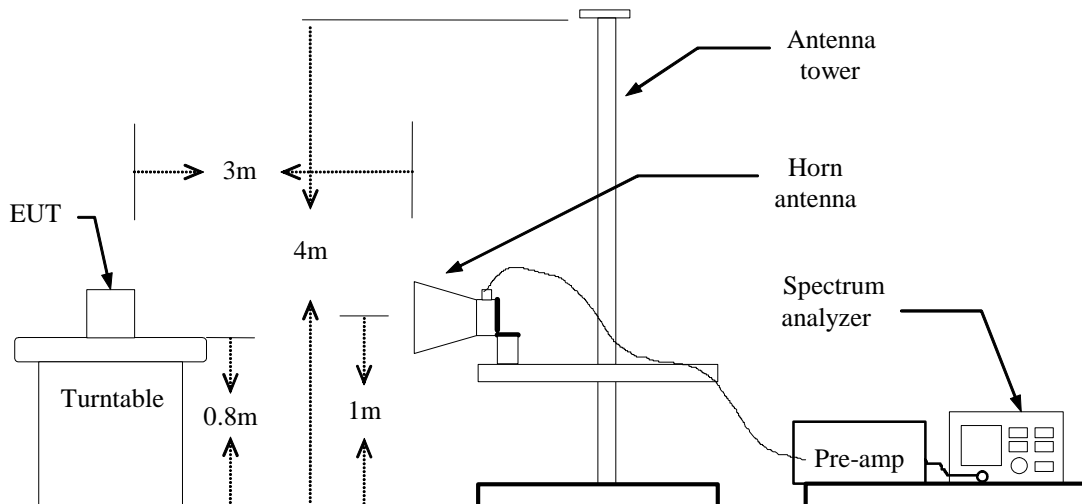



7.5.5. TEST RESULTS

IEEE 802.11b mode / CH Low

Freq. (MHz)	Ant. Pol H/V	Peak Reading (dBuV)	AV Reading (dBuV)	Ant. / CL CF (dB)	Actual Fs		Peak Limit (dBuV/m)	AV Limit (dBuV/m)	Peak Margin (dB)	AV Margin (dB)
					Peak (dBuV/m)	AV (dBuV/m)				
2390.00	V	60.13	30.97	-9.75	50.38	21.22	74	54	-23.62	-32.78
N/A										
2390.00	H	57.24	29.29	-9.75	47.49	19.54	74	54	-26.51	-34.46
N/A										

IEEE 802.11b mode / CH High

Freq. (MHz)	Ant. Pol H/V	Peak Reading (dBuV)	AV Reading (dBuV)	Ant. / CL CF (dB)	Actual Fs		Peak Limit (dBuV/m)	AV Limit (dBuV/m)	Peak Margin (dB)	AV Margin (dB)
					Peak (dBuV/m)	AV (dBuV/m)				
2483.50	V	58.58	32.48	-9.78	58.58	22.70	74	54	-15.42	-31.30
N/A										
2483.50	H	57.46	31.46	-9.78	47.68	21.68	74	54	-26.32	-32.32
N/A										



**IEEE 802.11g mode / CH Low**

Freq. (MHz)	Ant. Pol H/V	Peak Reading (dBuV)	AV Reading (dBuV)	Ant. / CL CF (dB)	Actual Fs		Peak Limit (dBuV/m)	AV Limit (dBuV/m)	Peak Margin (dB)	AV Margin (dB)
					Peak (dBuV/m)	AV (dBuV/m)				
2390.00	V	63.83	43.58	-9.75	54.08	33.83	74	54	-19.92	-20.17
N/A										
2390.00	H	59.94	39.68	-9.75	50.19	29.93	74	54	-23.81	-24.07
N/A										

**IEEE 802.11g mode / CH High**

Freq. (MHz)	Ant. Pol H/V	Peak Reading (dBuV)	AV Reading (dBuV)	Ant. / CL CF (dB)	Actual Fs		Peak Limit (dBuV/m)	AV Limit (dBuV/m)	Peak Margin (dB)	AV Margin (dB)
					Peak (dBuV/m)	AV (dBuV/m)				
2483.50	V	64.55	45.47	-9.78	54.77	35.69	74	54	-19.23	-18.31
N/A										
2483.50	H	59.80	42.37	-9.78	50.02	32.59	74	54	-23.98	-21.41
N/A										



Test Plot (IEEE 802.11b mode)

Band Edges (CH Low)

Detector mode: Peak

Polarity: Vertical

Agilent 11:49:42 Apr 1, 2011

R T

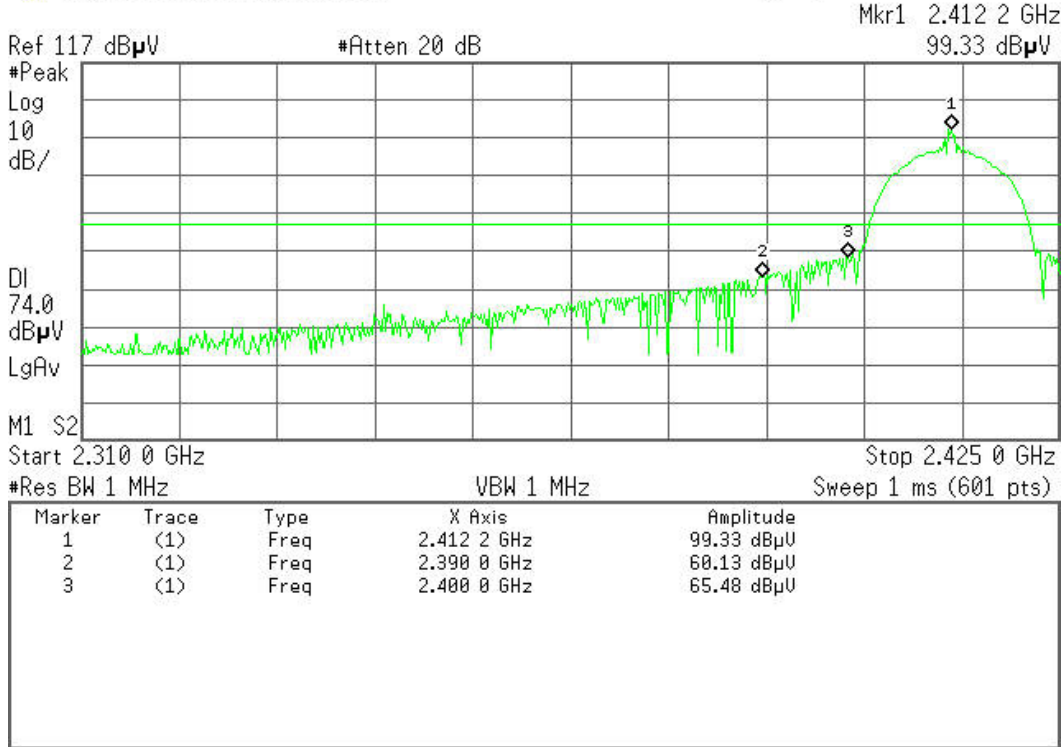

Detector mode: Average

Polarity: Vertical

Agilent 11:51:28 Apr 1, 2011

R T

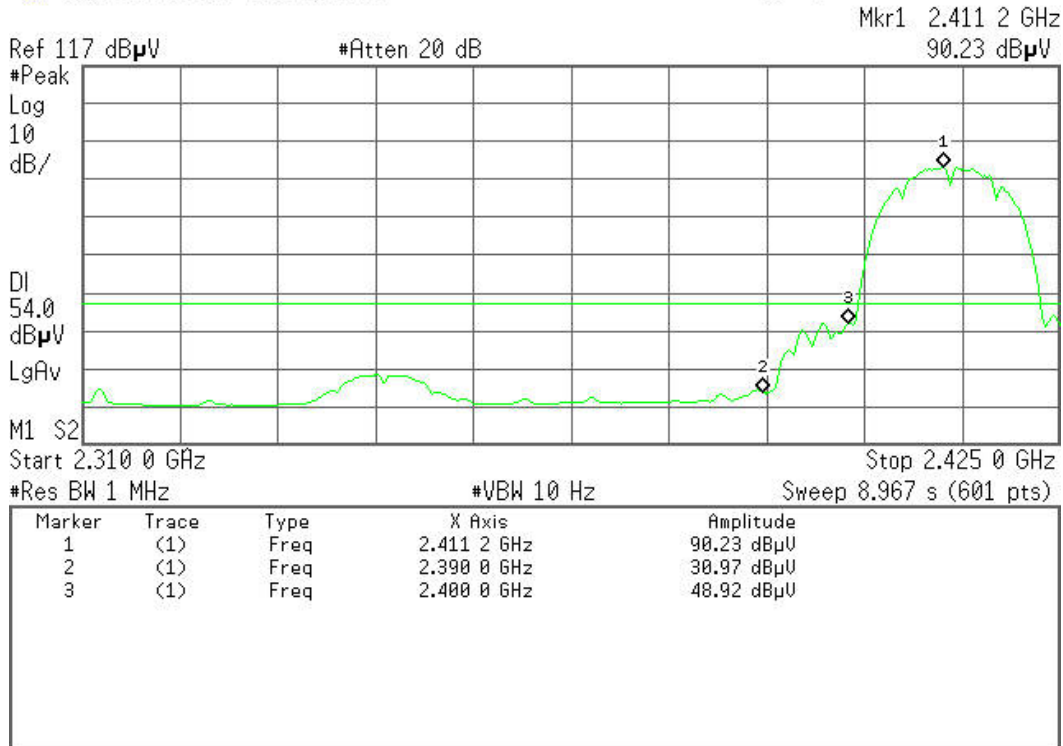



Detector mode: Peak

Polarity: Horizontal

Agilent 11:43:52 Apr 1, 2011

R T

Mkr1 2.411 8 GHz  
96.94 dBµV

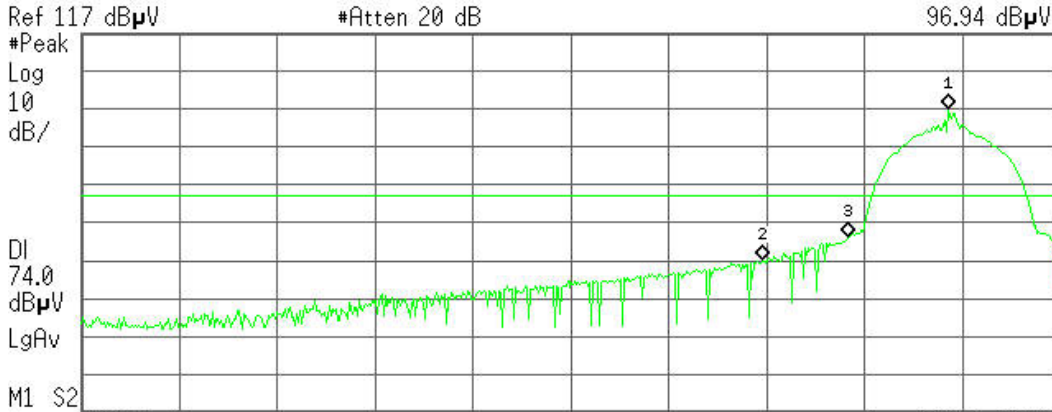

Start 2.310 0 GHz Stop 2.425 0 GHz  
#Res BW 1 MHz VBW 1 MHz Sweep 1 ms (601 pts)

Marker	Trace	Type	X Axis	Amplitude
1	(1)	Freq	2.411 8 GHz	96.94 dBµV
2	(1)	Freq	2.390 0 GHz	57.24 dBµV
3	(1)	Freq	2.400 0 GHz	63.19 dBµV

Detector mode: Average

Polarity: Horizontal

Agilent 11:45:15 Apr 1, 2011

R T

Mkr1 2.414 6 GHz  
87.58 dBµV

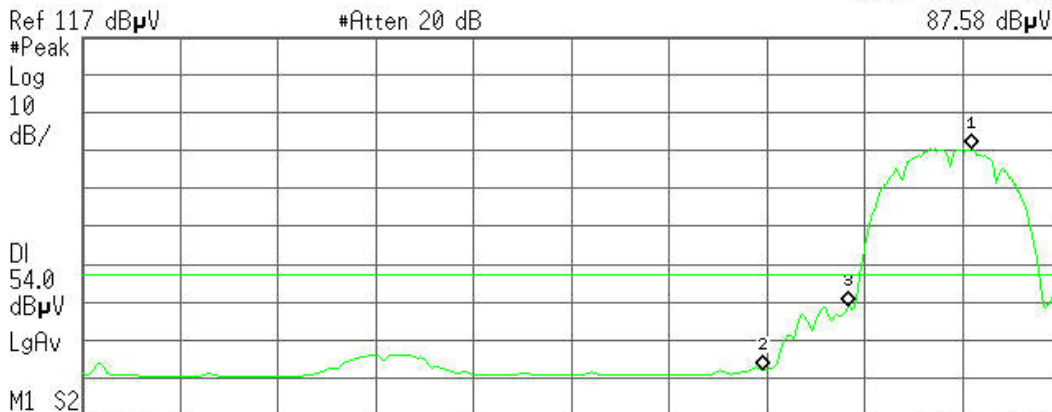

Start 2.310 0 GHz Stop 2.425 0 GHz  
#Res BW 1 MHz #VBW 10 Hz Sweep 8.967 s (601 pts)

Marker	Trace	Type	X Axis	Amplitude
1	(1)	Freq	2.414 6 GHz	87.58 dBµV
2	(1)	Freq	2.390 0 GHz	29.29 dBµV
3	(1)	Freq	2.400 0 GHz	45.79 dBµV



Band Edges (CH High)

Detector mode: Peak

Polarity: Vertical

Agilent 11:57:58 Apr 1, 2011

R T

Mkr1 2.461 78 GHz  
99.13 dBμV

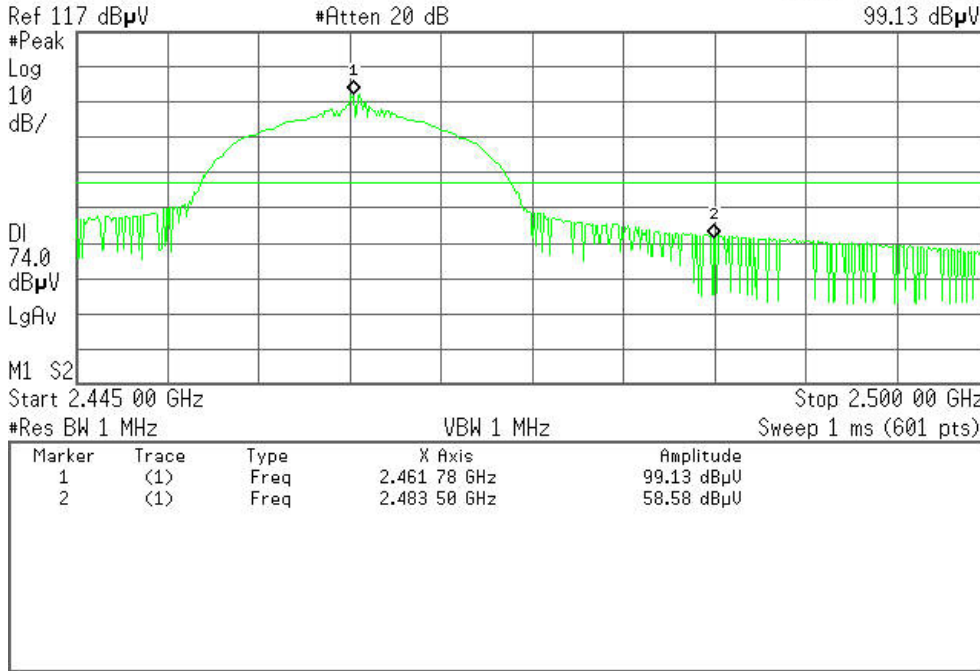

Detector mode: Average

Polarity: Vertical

Agilent 11:58:37 Apr 1, 2011

R T

Mkr1 2.462 69 GHz  
89.69 dBμV

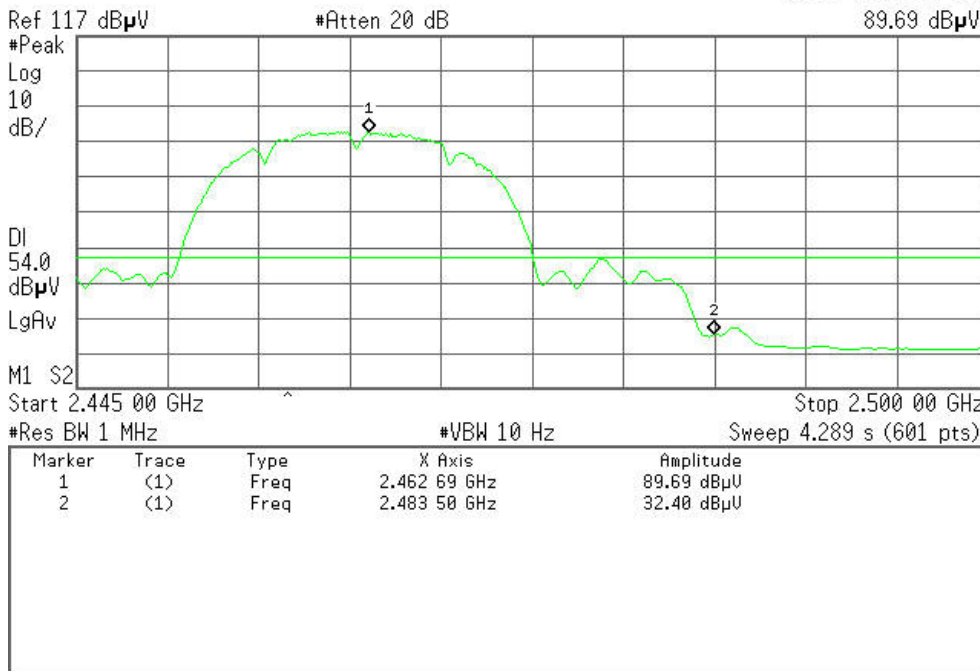



Detector mode: Peak

Polarity: Horizontal

Agilent 12:01:44 Apr 1, 2011

R T

Mkr1 2.462 05 GHz  
96.38 dBµV

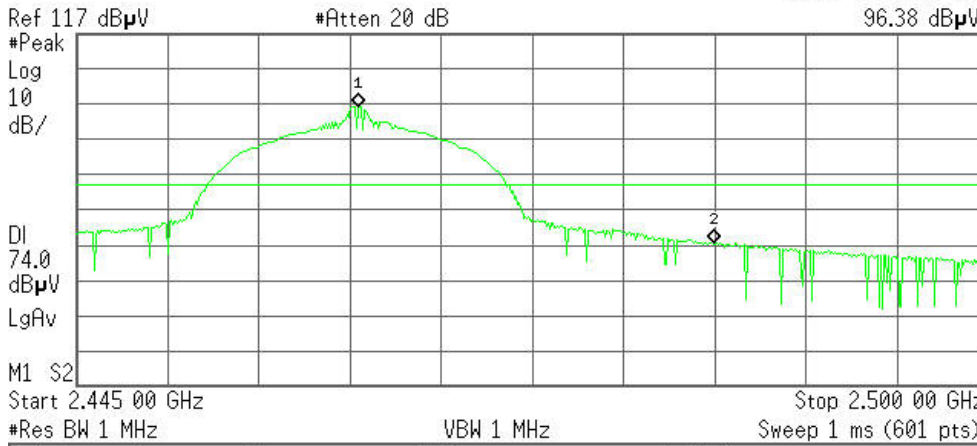

Marker	Trace	Type	X Axis	Amplitude
1	(1)	Freq	2.462 05 GHz	96.38 dBµV
2	(1)	Freq	2.483 50 GHz	57.46 dBµV

Detector mode: Average

Polarity: Horizontal

Agilent 12:03:42 Apr 1, 2011

R T

Mkr1 2.464 25 GHz  
87.07 dBµV

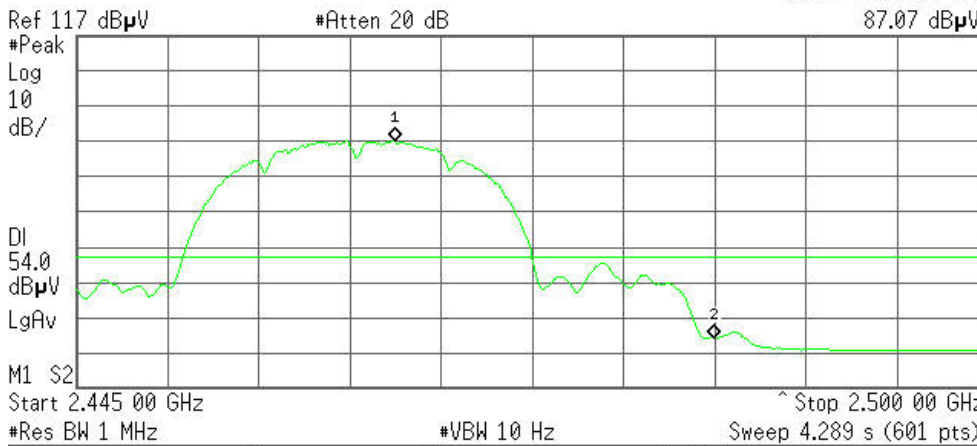

Marker	Trace	Type	X Axis	Amplitude
1	(1)	Freq	2.464 25 GHz	87.07 dBµV
2	(1)	Freq	2.483 50 GHz	31.46 dBµV



(IEEE 802.11g mode)

Band Edges (CH Low)

Detector mode: Peak

Polarity: Vertical

Agilent 10:54:16 Apr 1, 2011

R T

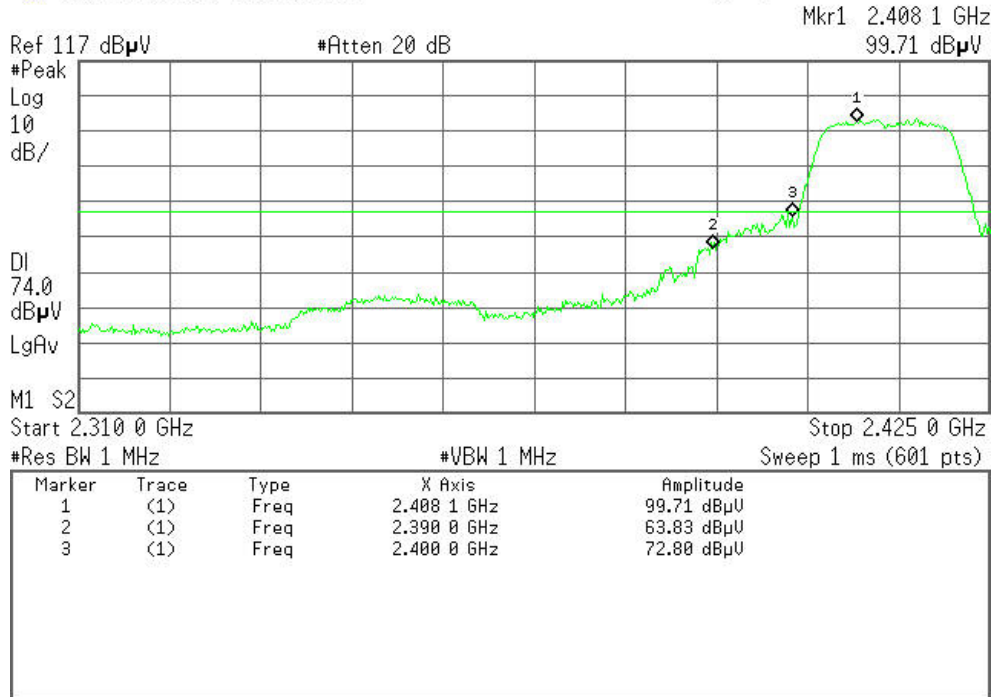

Detector mode: Average

Polarity: Vertical

Agilent 10:55:34 Apr 1, 2011

R T

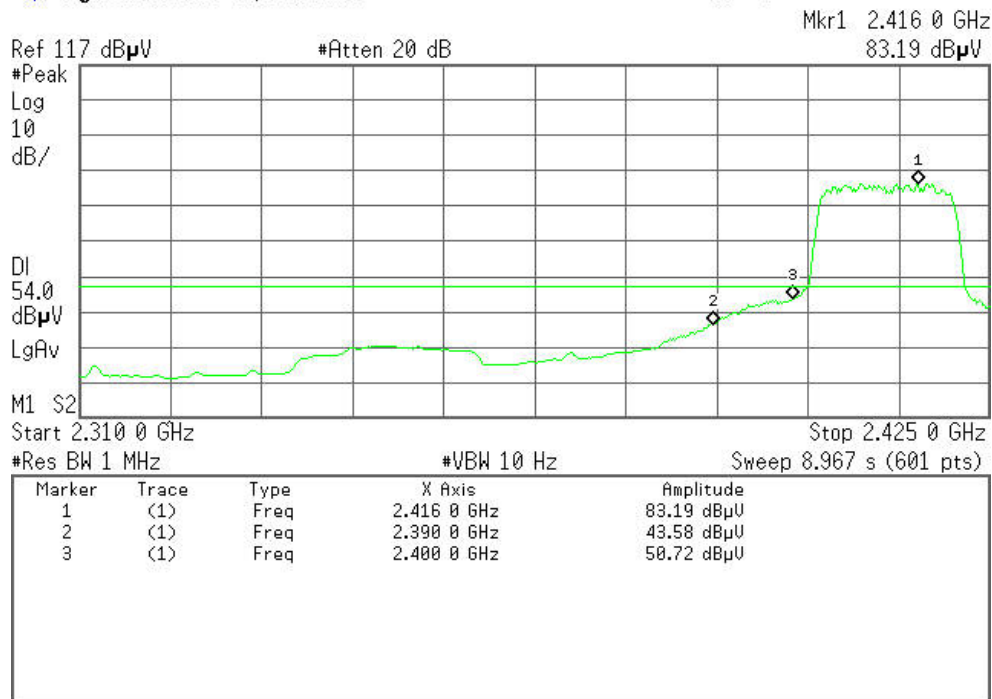





Detector mode: Peak

Polarity: Horizontal

Agilent 11:33:56 Apr 1, 2011

R T

Mkr1 2.416 0 GHz  
96.66 dBµV

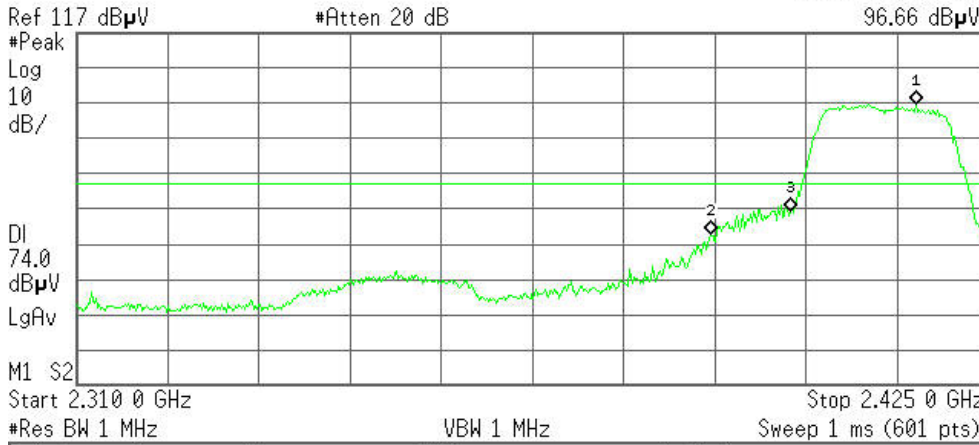

Marker	Trace	Type	X Axis	Amplitude
1	(1)	Freq	2.416 0 GHz	96.66 dBµV
2	(1)	Freq	2.390 0 GHz	59.94 dBµV
3	(1)	Freq	2.400 0 GHz	66.38 dBµV

Detector mode: Average

Polarity: Horizontal

Agilent 11:35:03 Apr 1, 2011

R T

Mkr1 2.404 7 GHz  
79.02 dBµV

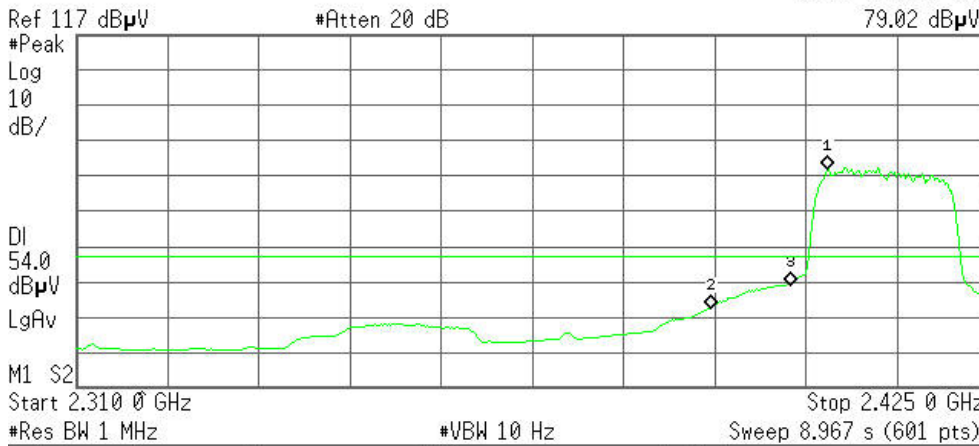

Marker	Trace	Type	X Axis	Amplitude
1	(1)	Freq	2.404 7 GHz	79.02 dBµV
2	(1)	Freq	2.390 0 GHz	39.68 dBµV
3	(1)	Freq	2.400 0 GHz	45.94 dBµV



Band Edges (CH High)

Detector mode: Peak

Polarity: Vertical

Agilent 12:12:32 Apr 1, 2011

R T

Mkr1 2.465 72 GHz

99.47 dBµV

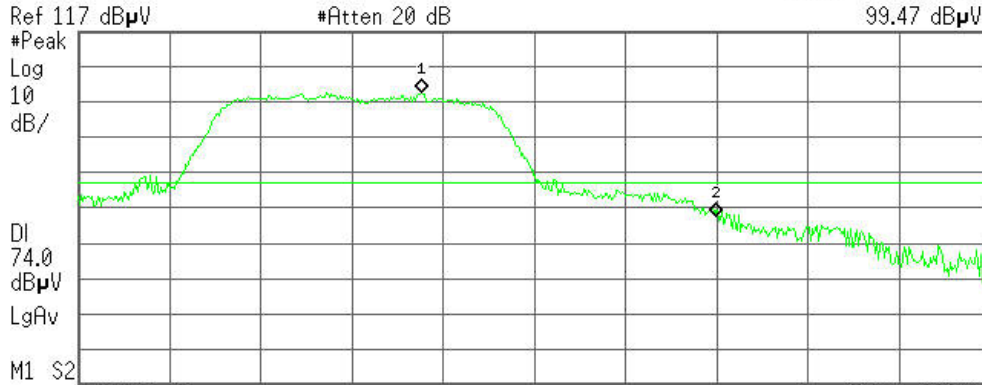

Ref 117 dBµV #Atten 20 dB

Start 2.445 00 GHz Stop 2.500 00 GHz

#Res BW 1 MHz VBW 1 MHz Sweep 1 ms (601 pts)

Marker	Trace	Type	X Axis	Amplitude
1	(1)	Freq	2.465 72 GHz	99.47 dBµU
2	(1)	Freq	2.483 50 GHz	64.55 dBµU

Detector mode: Average

Polarity: Vertical

Agilent 12:13:32 Apr 1, 2011

R T

Mkr1 2.456 64 GHz

82.98 dBµV



Ref 117 dBµV #Atten 20 dB

Start 2.445 00 GHz Stop 2.500 00 GHz

#Res BW 1 MHz #VBW 10 Hz Sweep 4.289 s (601 pts)

Marker	Trace	Type	X Axis	Amplitude
1	(1)	Freq	2.456 64 GHz	82.98 dBµU
2	(1)	Freq	2.483 50 GHz	45.47 dBµU



Detector mode: Peak

Polarity: Horizontal

Agilent 12:08:31 Apr 1, 2011

R T

Mkr1 2.465 53 GHz  
96.55 dBµV

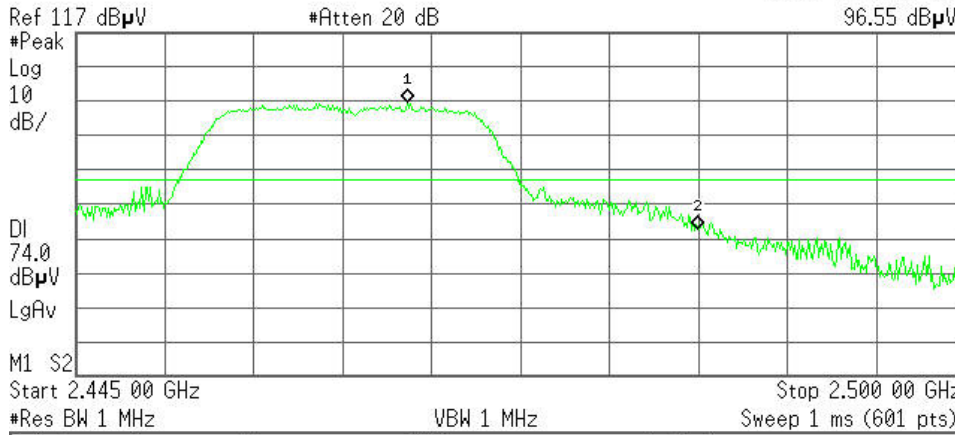

Marker	Trace	Type	X Axis	Amplitude
1	(1)	Freq	2.465 53 GHz	96.55 dBµV
2	(1)	Freq	2.483 50 GHz	59.80 dBµV

Detector mode: Average

Polarity: Horizontal

Agilent 12:09:20 Apr 1, 2011

R T

Mkr1 2.460 86 GHz  
80.29 dBµV

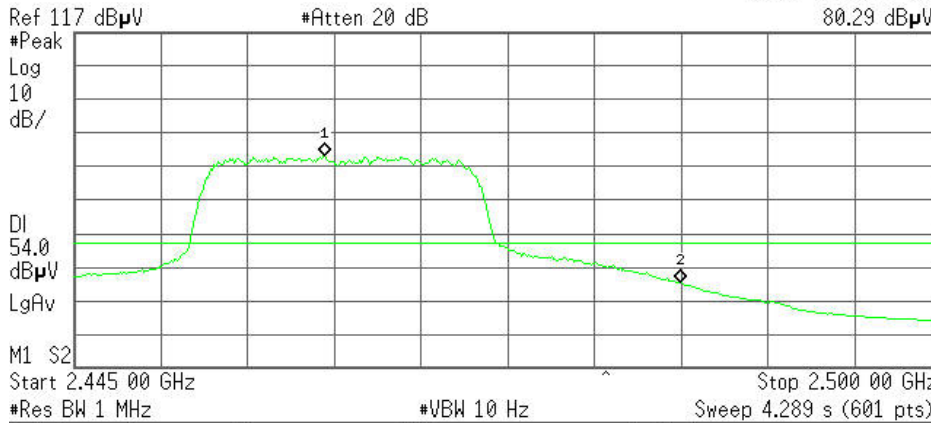

Marker	Trace	Type	X Axis	Amplitude
1	(1)	Freq	2.460 86 GHz	80.29 dBµV
2	(1)	Freq	2.483 50 GHz	42.37 dBµV



## 7.6. PEAK POWER SPECTRAL DENSITY MEASUREMENT

### 7.6.1. LIMITS

According to §15.247(e), for digitally modulated systems, the power spectral density conducted from the intentional radiator to the antenna shall not be greater than 8 dBm in any 3 kHz band during any time interval of continuous transmission.

According to §15.247(f), the digital modulation operation of the hybrid system, with the frequency hopping turned off, shall comply with the power density requirements of paragraph (d) of this section.

### 7.6.2. TEST INSTRUMENTS

Name of Equipment	Manufacturer	Model	Serial Number	Last Calibration	Calibration Due
Spectrum Analyzer	Agilent	E4446A	US44300399	03/21/2011	03/21/2012

### 7.6.3. TEST PROCEDURES (please refer to measurement standard)

1. Place the EUT on the table and set it in transmitting mode. Remove the antenna from the EUT and then connect a low loss RF cable from the antenna port to the spectrum analyzer.
2. Set the spectrum analyzer as RBW = 3kHz, VBW = 10kHz, Span = 500kHz, Sweep=100s
3. Record the max. reading.
4. Repeat the above procedure until the measurements for all frequencies are completed.

### 7.6.4. TEST SETUP

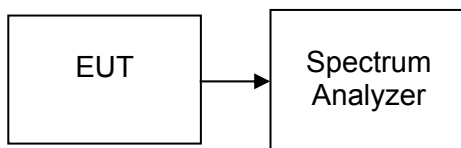



**7.6.5. TEST RESULTS**

*No non-compliance noted*

**Test Data**

**Test mode: IEEE 802.11b**

Channel	Frequency (MHz)	PPSD (dBm)	Limit (dBm)	Test Result
Low	2412	-15.04	8.00	PASS
Mid	2437	-14.48		PASS
High	2462	-15.99		PASS

**Test mode: IEEE 802.11g**

Channel	Frequency (MHz)	PPSD (dBm)	Limit (dBm)	Test Result
Low	2412	-10.51	8.00	PASS
Mid	2437	-10.90		PASS
High	2462	-11.68		PASS



Test Plot (IEEE 802.11b mode)

PPSD (CH Low)

Agilent 22:07:31 Mar 30, 2011

R T

Mkr1 2.411 995 0 GHz  
-15.04 dBm

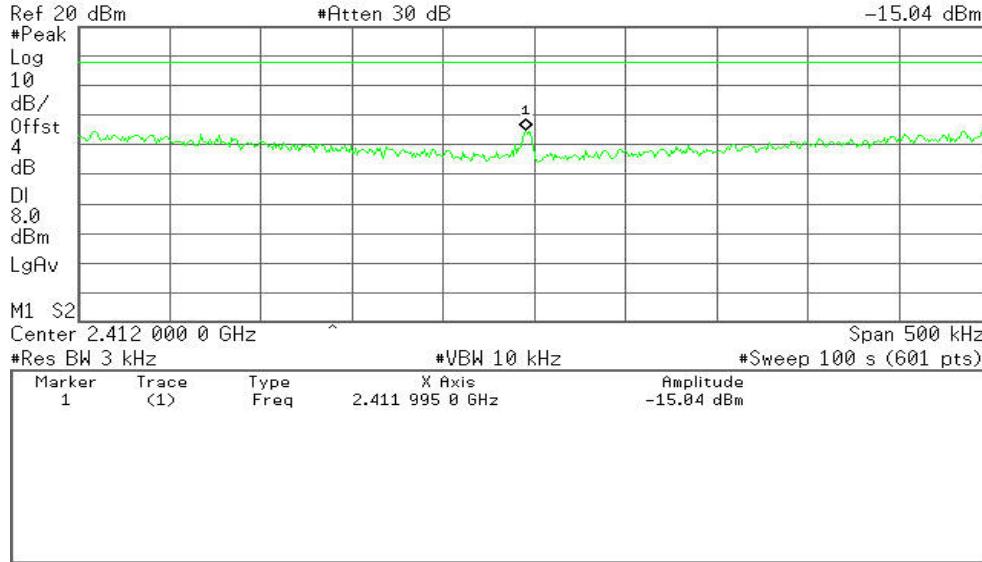

PPSD (CH Mid)

Agilent 22:04:44 Mar 30, 2011

R T

Mkr1 2.436 995 8 GHz  
-14.48 dBm

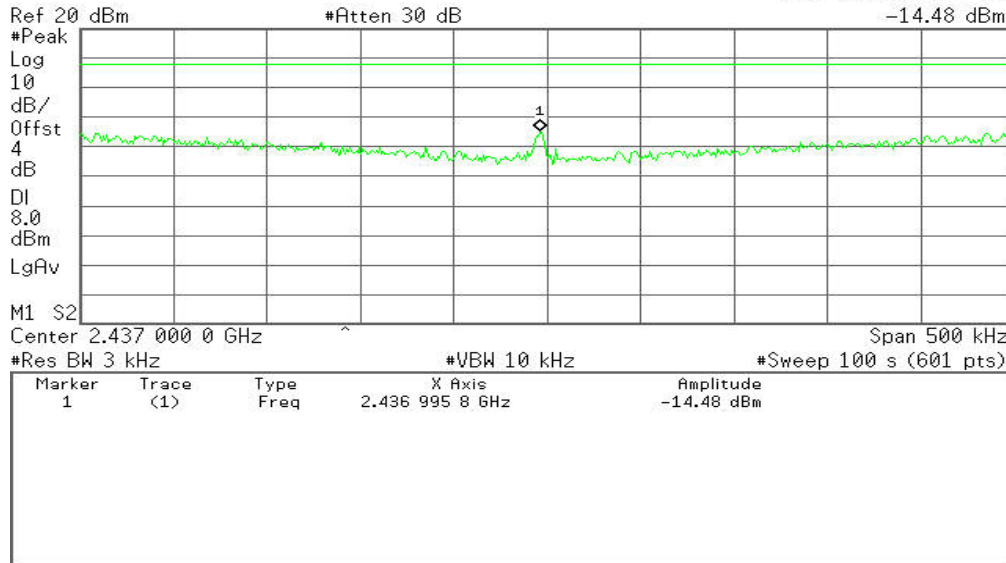



PPSD (CH High)

Agilent 21:52:24 Mar 30, 2011

R T

Mkr1 2.461 995 0 GHz  
-15.99 dBm

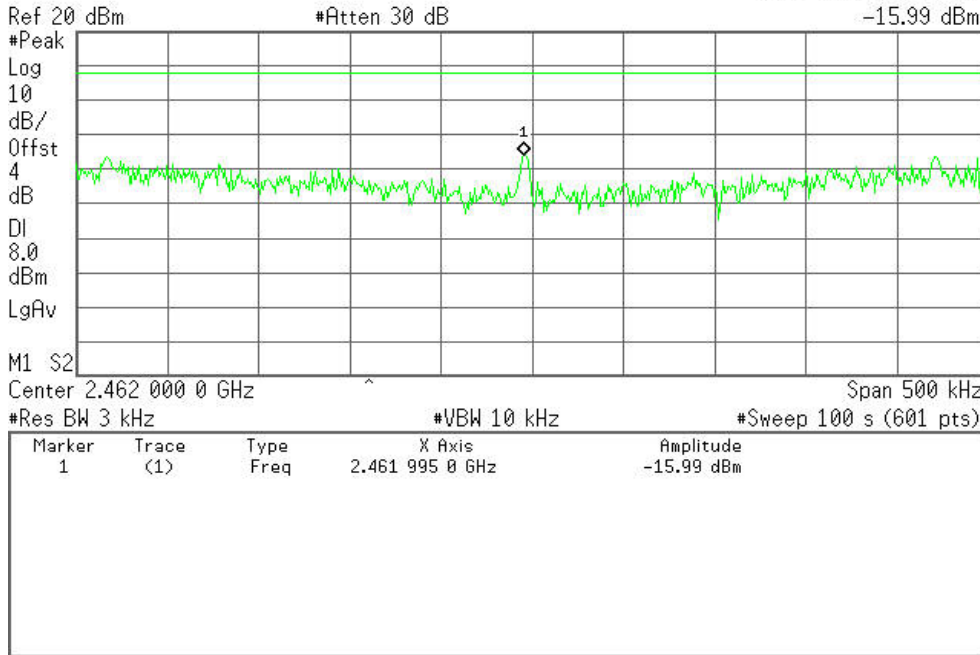

(IEEE 802.11g mode)

PPSD (CH Low)

Agilent 22:10:19 Mar 30, 2011

R T

Mkr1 2.411 995 8 GHz  
-10.51 dBm

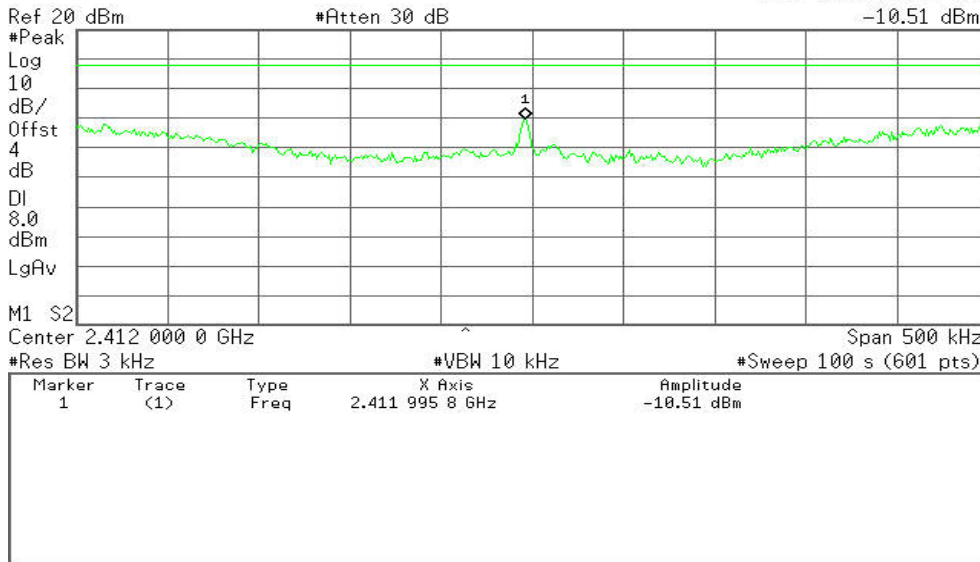



PPSD (CH Mid)

Agilent 22:02:11 Mar 30, 2011

R T

Mkr1 2.436 995 0 GHz  
-10.90 dBm



#Res BW 3 kHz #VBW 10 kHz #Sweep 100 s (601 pts)

Marker	Trace	Type	X Axis	Amplitude
1	(1)	Freq	2.436 995 0 GHz	-10.90 dBm

PPSD (CH High)

Agilent 21:59:40 Mar 30, 2011

R T

Mkr1 2.461 995 8 GHz  
-11.68 dBm



#Res BW 3 kHz #VBW 10 kHz #Sweep 100 s (601 pts)

Marker	Trace	Type	X Axis	Amplitude
1	(1)	Freq	2.461 995 8 GHz	-11.68 dBm