

## Bluetooth® Low Energy Module

### Features

- Fully qualified Bluetooth® version 4.1 module
- Onboard Bluetooth Low Energy 4.1 stack
- ASCII command interface API over UART
- Multiple IOs for control and status
- Secure AES128 encryption
- GAP, GATT, SM, L2CAP and integrated public profiles
- Create custom services using command API
- Microchip Low Energy Data Protocol (MLDP) for streaming data applications
- Software configurable role as peripheral or central, client or server
- Compact form factor 11.5 x 19.5 mm
- Low-power consumption
- UART interface, GPIO, ADC
- 64 KB internal serial flash
- Castellated SMT pads for easy and reliable PCB mounting
- Environmentally friendly, RoHS compliant
- Certifications: FCC, IC, CE, QDID
- Device Firmware Upgrade (DFU)

### Description

Microchip's RN4020 Bluetooth Low Energy Module provides a highly integrated solution for delivering low power Bluetooth 4.1 solutions. The advanced command interface offers rapid time to market.

The RN-4020 module complies with Bluetooth specification version 4.1. It integrates RF, a baseband controller, command API processor, making it a complete Bluetooth Low Energy Solution.

The RN4020 can be used with either low cost microcontroller for intelligent Bluetooth Low Energy applications. For simple sensor applications, the RN4020 internal scripting capabilities enable basic functions to be implemented without the need for external host MCU or software development tools.



RN4020 Bluetooth 4.1 Low Energy Module (RN4020-V/RM)

### Applications

- Health/Medical Devices
  - Glucose Meters
  - Heart rate
  - Scale
- Sports Activity and Fitness
  - Pedometer
  - Cycling computer
  - Heart rate
- Retail
  - POS
  - Asset tagging and tracking
  - Proximity Advertising
- Beacon applications
- Internet of Things Sensor tag
- Remote Control
  - Keyboard Mice
  - AV consoles, game controllers
- Wearable smart devices and accessories
- Industrial Control
  - Private (custom) services
  - Low bandwidth cable replacement
- Smart Energy/Smart Home

## Table of Contents

1.0	Device Overview .....	3
2.0	General Specifications .....	5
3.0	Microcontroller to RN4020 Interface .....	6
4.0	Physical Dimensions .....	7
5.0	Typical Application Schematic .....	8
6.0	ASCII Command API .....	9
7.0	Supported Services .....	10
8.0	Regulatory Approval .....	13
9.0	Ordering Information .....	19
Appendix A: Revision History .....		21
The Microchip Web Site .....		23
Customer Change Notification Service .....		23
Customer Support .....		23
Product Identification System .....		25

### TO OUR VALUED CUSTOMERS

It is our intention to provide our valued customers with the best documentation possible to ensure successful use of your Microchip products. To this end, we will continue to improve our publications to better suit your needs. Our publications will be refined and enhanced as new volumes and updates are introduced.

If you have any questions or comments regarding this publication, please contact the Marketing Communications Department via E-mail at [docerrors@microchip.com](mailto:docerrors@microchip.com). We welcome your feedback.

#### Most Current Data Sheet

To obtain the most up-to-date version of this data sheet, please register at our Worldwide Web site at:

<http://www.microchip.com>

You can determine the version of a data sheet by examining its literature number found on the bottom outside corner of any page. The last character of the literature number is the version number, (e.g., DS30000000A is version A of document DS30000000).

#### Errata

An errata sheet, describing minor operational differences from the data sheet and recommended workarounds, may exist for current devices. As device/documentation issues become known to us, we will publish an errata sheet. The errata will specify the revision of silicon and revision of document to which it applies.

To determine if an errata sheet exists for a particular device, please check with one of the following:

- Microchip's Worldwide Web site; <http://www.microchip.com>
- Your local Microchip sales office (see last page)

When contacting a sales office, please specify which device, revision of silicon and data sheet (include literature number) you are using.

#### Customer Notification System

Register on our web site at [www.microchip.com](http://www.microchip.com) to receive the most current information on all of our products.

## 1.0 DEVICE OVERVIEW

**FIGURE 1-1: RN4020 TOP VIEW**

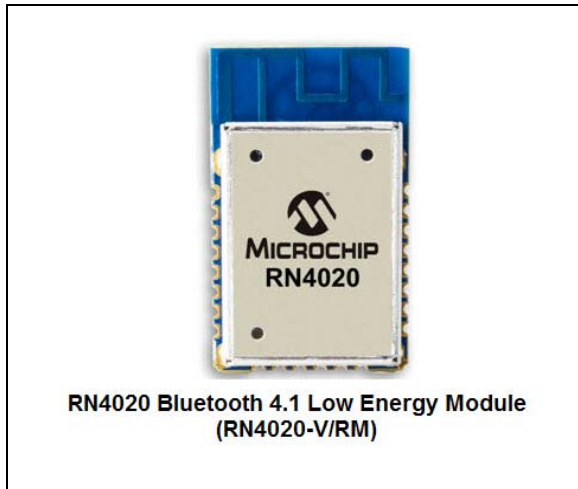
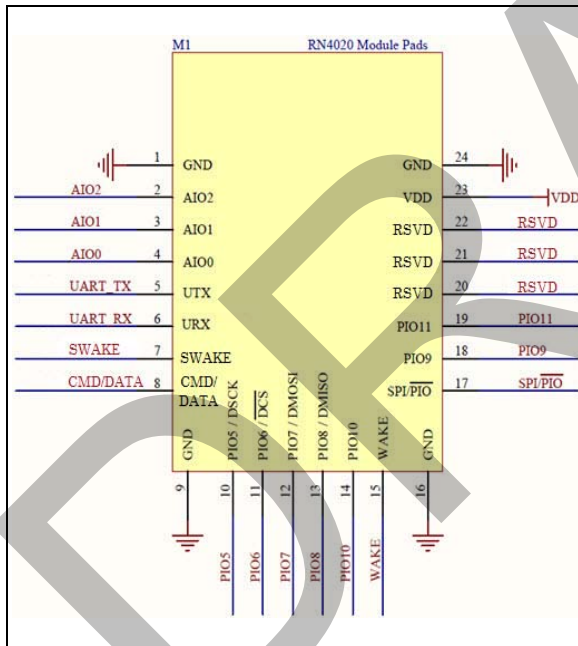

Figure 1-2 shows the module's pinout and Table 1-1 describes the pins.

**FIGURE 1-2: RN4020 PIN DIAGRAM**



# RN4020

**TABLE 1-1: PIN DESCRIPTION**

Pin	Symbol	Description	Function
1	GND	Ground	Ground
2	AIO2	Bi-directional with programmable analog IO	1.65V input, 1.35V out, and 30mA max out
3	AIO1	Bi-directional with programmable analog IO	1.65V input, 1.35V out, and 30mA max out
4	AIO0	Bi-directional with programmable analog IO	1.65V input, 1.35V out, and 30mA max out
5	UART TX	UART TX	Output from RN4020
6	UART RX	UART RX	Input to RN4020
7	WAKE-SW	Deep Sleep Wake; active high to wake module from deep sleep	Input; weak pull down
8	CMD/DATA	Command or Data – In Command , UART traffic is sent to command interpreter, other maybe routed to Microchip Serial Data service.	Input; Active High to enter Command
9	GND	Ground	Ground
10	SPI-CLK GPIO[1]	SPI-CLK for diagnostics and factory calibration if pin 17 asserted. Default state is output: Active Low indicates module is connected to remote device. High level indicates disconnected state. Configurable as GPIO[1] via software command.	<ul style="list-style-type: none"> <li>• SPI-CLK</li> <li>• Connected Status (Green LED)</li> <li>• GPIO[1]</li> </ul>
11	SPI-CS# GPIO[2]	SPI-CS# for diagnostics and factory calibration if pin 17 asserted. Default state is output. Active High indicates module has a pending event. Low level indicates no events. Event only triggered in DATA , pin 8 is high. Configurable as GPIO[2] via software command.	<ul style="list-style-type: none"> <li>• SPI-CS#</li> <li>• Event Pending (Red LED)</li> <li>• GPIO[2]</li> </ul>
12	SPI-MOSI GPIO[3]	SPI-MOSI for diagnostics and factory calibration if pin 17 asserted. Default state is output. Active High indicates module is awake and active. Low level indicates a sleep state. Configurable as GPIO[3] via software command.	<ul style="list-style-type: none"> <li>• SPI-CLK</li> <li>• Wake Status (Blue LED)</li> <li>• GPIO[3]</li> </ul>
13	SPI-MISO GPIO[4]	SPI-MISO for diagnostics and factory calibration if pin 17 asserted. Configurable as GPIO[4] via software command.	<ul style="list-style-type: none"> <li>• SPI-CLK</li> <li>• GPIO[4]</li> </ul>
14	CTS GPIO[6]	Reserved for CTS if hardware flow control is on UART. Configurable as GPIO[6] if hardware flow control is disabled.	<ul style="list-style-type: none"> <li>• CTS (input)</li> <li>• GPIO[6]</li> </ul>
15	WAKE-HW	Hardware wake from Hibernate or Dormant state	Active High; internal pull down
16	GND	Ground	Ground
17	SPI/PIO	SPI/PIO for pins 10-13, Active High	Input with internal pull down; selects SPI on 10-13
18	RTS GPIO[5]	Reserved for RTS if hardware flow control on UART. Configurable as GPIO[5] if hardware flow control disable	<ul style="list-style-type: none"> <li>• RTS (output)</li> <li>• GPIO[5]</li> </ul>
19	ADVCONN GPIO[7]	Active Low; In Peripheral the input put module in advertising state (discoverable and open for connection). In Central , initiates connect to stored address.	Initiate Advertising state or connect to stored address
20	RSVD	Do not connect. Factory diagnostics	NC

**TABLE 1-1: PIN DESCRIPTION (CONTINUED)**

Pin	Symbol	Description	Function
21	RSVD	Do not connect. Factory diagnostics	NC
22	RSVD	Do not connect. Factory diagnostics	NC
23	VDD	Supply voltage: 2.0 to 4.2V	Supply Voltage, 2.0 to 4.2
24	GND	Ground	Ground

## 2.0 GENERAL SPECIFICATIONS

Table 2-1 provides the general specifications for the module. Table 2-2, Table 2-3, and Table 2-4 provide the module's weight, dimensions, electrical characteristics, and current consumption.

**TABLE 2-1: GENERAL SPECIFICATIONS**

Specification	Description
Standard	Bluetooth 4.1
Frequency Band	2.4 ~ 2.48 GHz
Modulation Method	GMSK
Maximum Data Rate	1 Mbps
Antenna	PCB and chip (0dBi)
Interface	UART, PIO, AIO, SPI
Operation Range	100 meters
Sensitivity	-93 dBm at 0.1% BER
RF TX Power	+8.5 dBm (max)
Temperature (operating)	-30°C to +85°C
Temperature (storage)	-40°C to +85°C
ESD	JESD22-A224 class 0 product
Humidity	10% ~ 90% non-condensing

**TABLE 2-4: CURRENT CONSUMPTION**

Mode	Typical Current at 3V
Dormant	<700nA
Hibernate	<2.0uA
Deep Sleep	<5.0uA
Idle	<1.5mA
Tx/Rx active	16 mA at 0 dBm

**TABLE 2-2: WEIGHT AND DIMENSIONS**

Specification	Description
Dimensions	RN4020: 19.5 x 11.5 x 2.5 mm
Weight	1.2 g

**TABLE 2-3: ELECTRICAL CHARACTERISTICS**

Specification	Description
Supply Voltage	3Vport: 2.0 - 4.2 V DC
Working current	Depends on profiles, 12 mA typical
Standby current (disconnected)	<0.5 mA)

# RN4020

## 3.0 MICROCONTROLLER TO RN4020 INTERFACE

FIGURE 3-1: INTERFACE DESCRIPTION

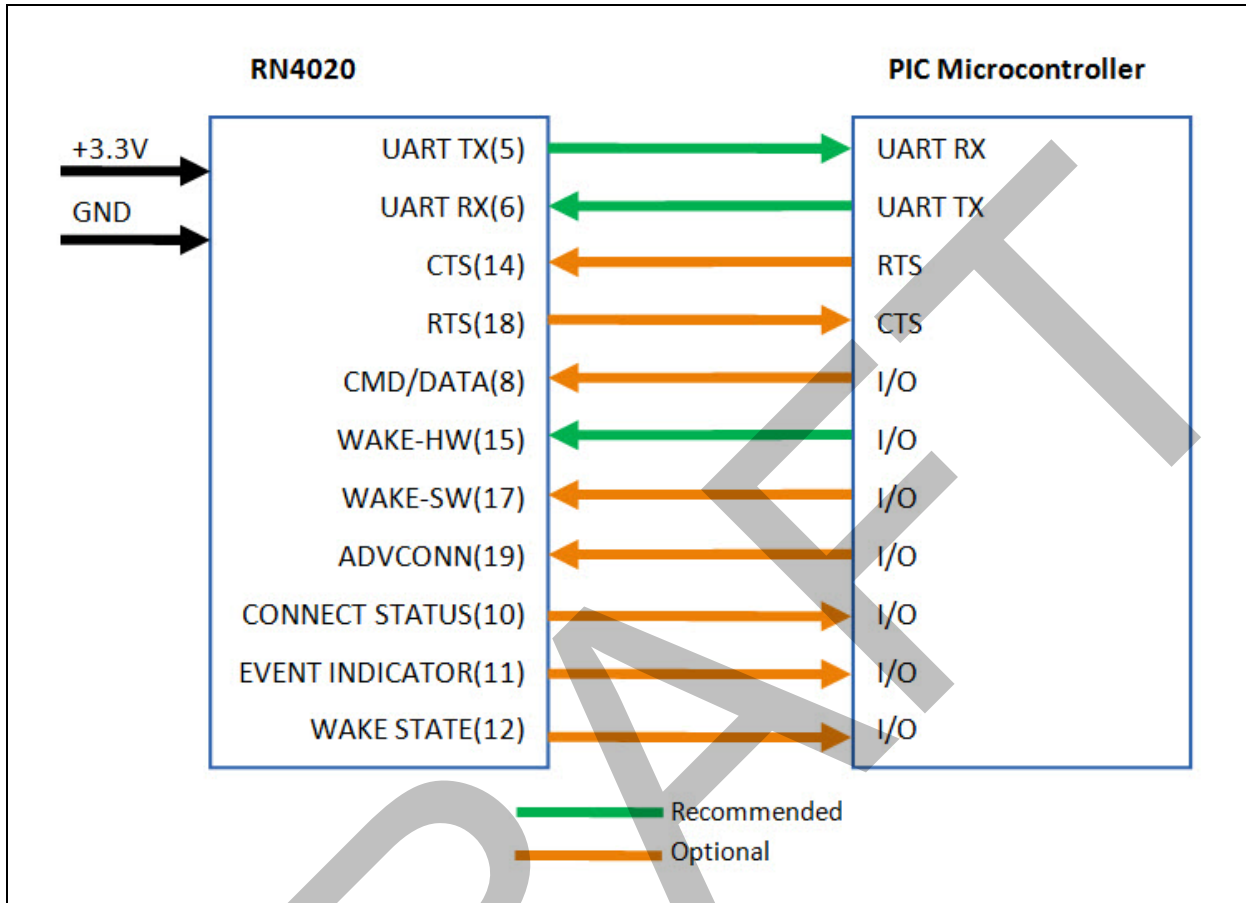

Figure 3-1 illustrates the interface between PIC microcontroller and RN4020 module. The minimum interface consists of UART and WAKE HW line. This enables the microcontroller to communicate with RN4020 module using ASCII command API. The command API is described in Sec XX.

### 3.1 CTS/RTS Hardware Flow Control

For customer applications using the Microchip Low Energy Data Protocol (MLEDP), Pin 8 (CMD/DATA) is required. CTS/RTS hardware control is also highly recommended for this service to avoid buffer overruns.

### 3.2 Microchip Low Energy Data Protocol (MLDP)

The Microchip Low Energy Data Protocol is a private BTLE service that provides a 20kbps serial data transport over Bluetooth Low Energy on the RN4020. Pin 8 (CMD/DATA) is required. CTS/RTS hardware control is also highly recommended for this service to avoid data loss.

Refer to “RN4020 Command Reference”, for more information on how to configure the MLDP service mandatory for DFU over UART.

## 4.0 PHYSICAL DIMENSIONS

Figure 4-1 shows the physical dimensions for RN4020 module. Figure 4-2 shows the recommended PCB layout.

**FIGURE 4-1: PHYSICAL DIMENSIONS FOR RN4020**

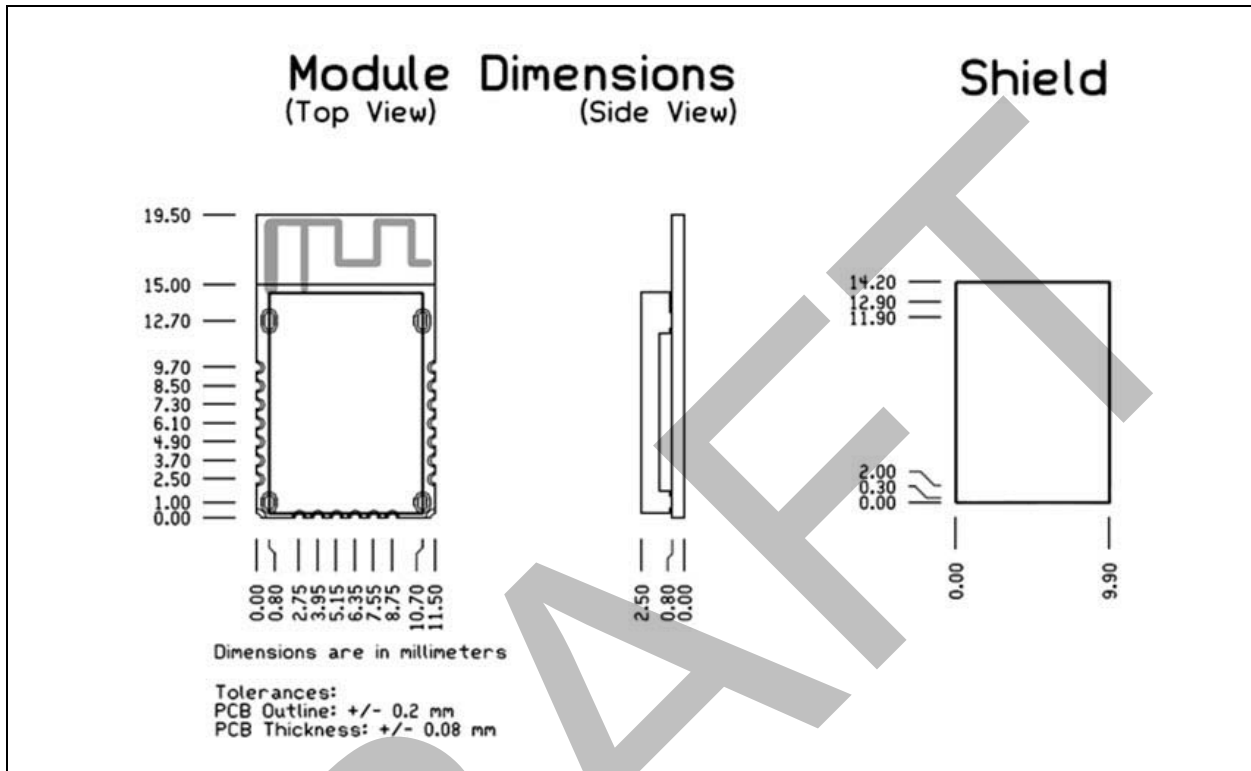

**FIGURE 4-2: RECOMMENDED PCB FOOTPRINT**

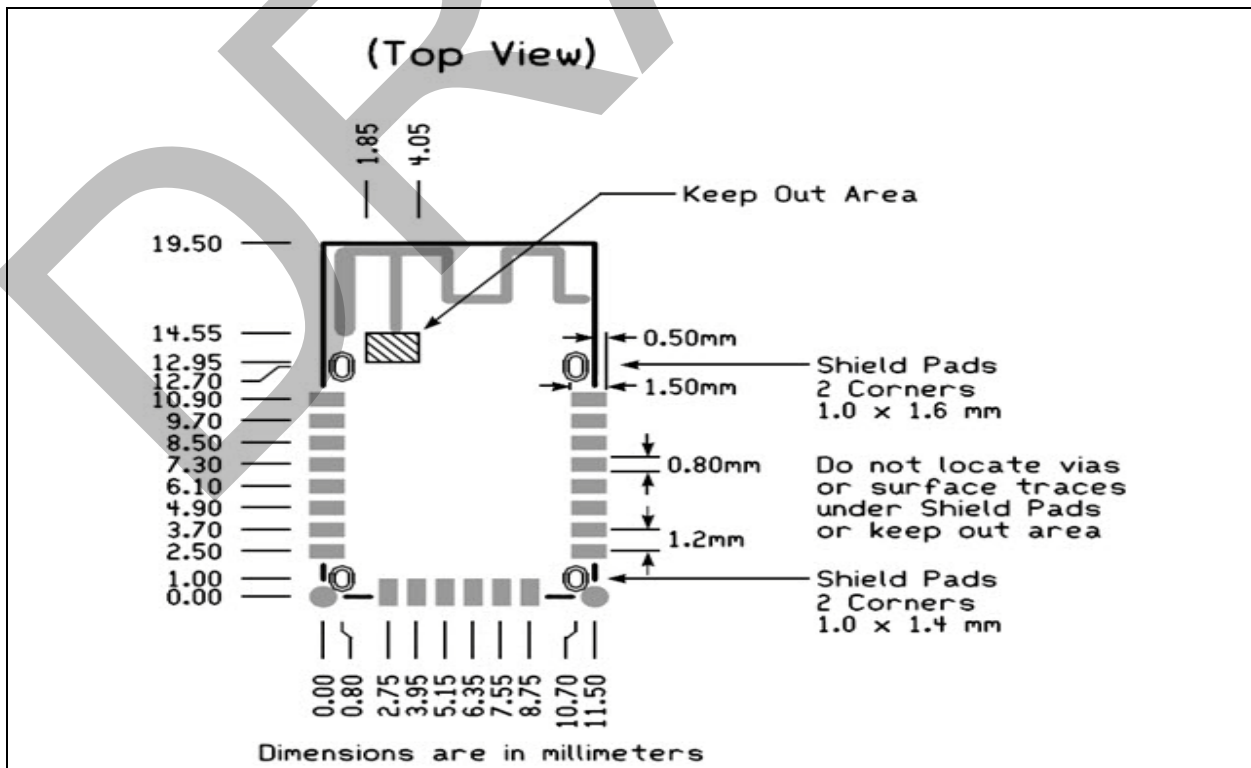

# RN4020

## 5.0 TYPICAL APPLICATION SCHEMATIC

Figure 5-1 shows schematic for the RN4020 PICtail™/PICtail Plus Daughter Board development tool, PN-XXXXXXXXXX.

FIGURE 5-1: RN4020 TYPICAL APPLICATION SCHEMATIC

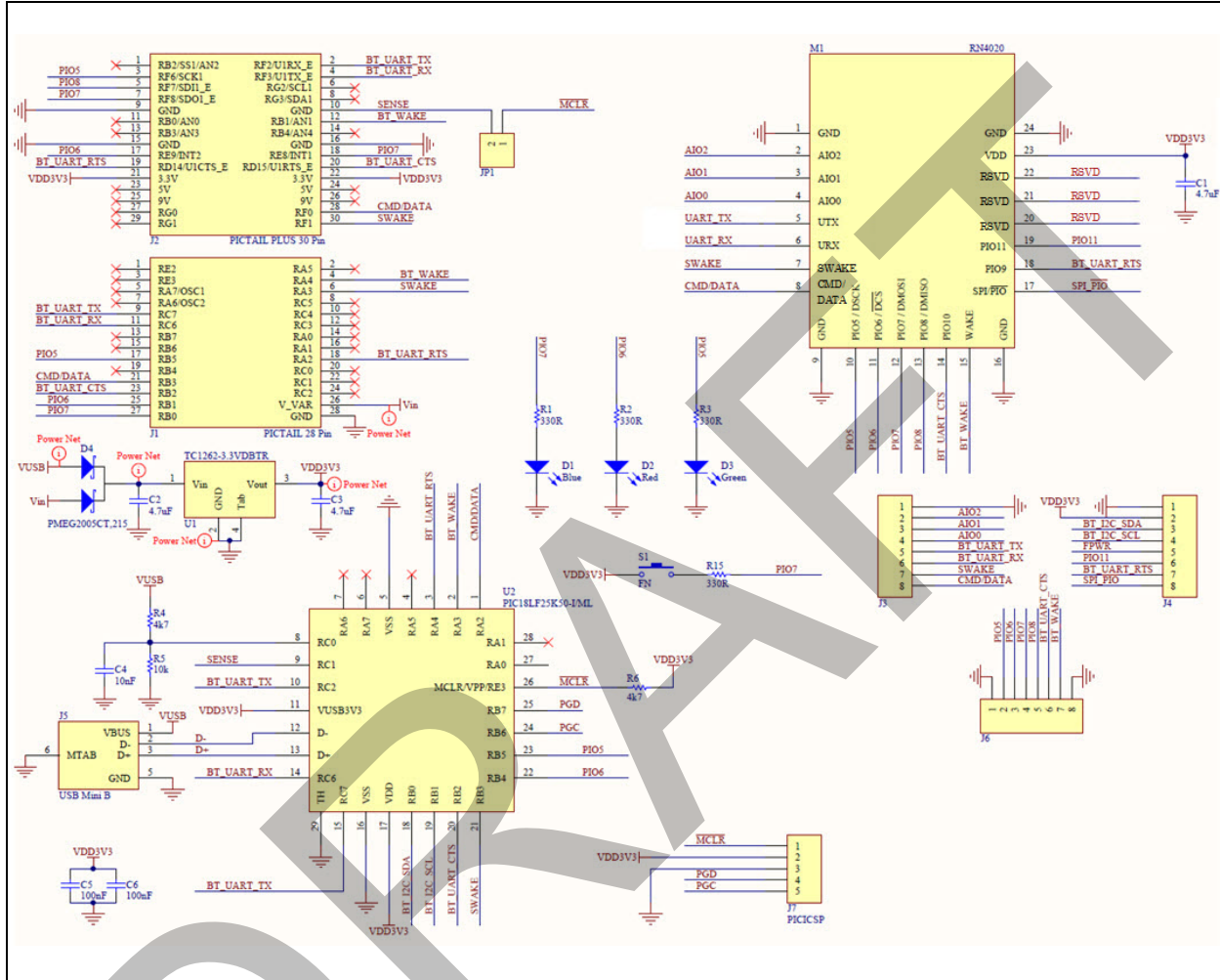



## 6.0 ASCII COMMAND API

The RN4020 command API is documented in RN4020 Command Reference: doc-xxx-xxxxxx:

Commands are categorized into the following functions:

- Built-in public services
  - Enable/Disable service as Server or Client
  - Red value
  - Set value
- Max Tx Power
  - Set Power in DB
- Role
  - Peripheral or Central
- Advertising
  - Start/Stop
- Bonding
  - Bond/Unbond to Master
- Private Service
  - Set Private Service UUID
  - Set Characteristic UUID for Private Service
- Microchip Low Energy Data Protocol
  - Enable/Disable
  - Peripheral side configuration
  - Central side configuration
- Device Information Profile settings
- Connection
  - Status
  - Disconnect
  - Kill active connection
  - Establish connection (Central role only)
  - Start/Stop inquiry scan for other devices (Central role only)
- IO
  - Configure GPIO mask
  - Set/Get GPIO states
  - Ready raw ADC values
- System
  - Reboot
  - Enter deep sleep
  - Factory default
  - Test functions for type approval
  - Display configuration

# RN4020

## 7.0 SUPPORTED SERVICES

The RN4020 firmware support the following built-in profiles listed in Table 7-1 below. The services are enabled via Command API and serviced in the same manner. Each service manages “Characteristics” which as data values are declared and defined by Bluetooth. The values for each characteristic are cached in modules memory and can be read by another Bluetooth device, such Smartphone acting in Central role. The values of every Characteristic are updated via Command API over UART.

**TABLE 7-1: SUPPORTED PUBLIC SERVICES ON RN4020**

Service Name	Bluetooth SIG UUID
Device Information	0x180A
Battery	0x180F
Heart Rate	0x180D
Health Thermometer	0x1809
Glucose	0x1808
Blood Pressure	0x1810
Running Speed Cadence	0x1814
Cycling Speed Cadence	0x1816
Current Time	0x1805
Next DST Change	0x1807
Reference Time Update	0x1806
Link Loss	0x1803
Immediate Alert	0x1802
TX Power	0x1804
Alert Notification	0x1811
Phone Alert Status	0x180E
Scan Parameters	0x1813

### 7.1 Public and Private Services

The RN4020 provided the ability to create customer services. If the services are supported on both end points of a Bluetooth Low Energy connection, such as Central and Peripheral devices, data can be exchanged. For example, two RN4020 modules can define a custom (private) service with its own unique characteristics. Data can be exchanged easily via Command API.

Private services are not registered with the Bluetooth SIG, and therefore not interoperable with other Bluetooth Low Energy devices, unless the device implements the private service. An example of a built-in private service is Microchip Streaming Data service.

Refer to “RN4020 Command Reference”, docxxxx-xxxxxx, and Application Note AN-xxxxxx for an example on how to create a custom service using the RN4020.

## 7.2 PCB Antenna

The PCB antenna is fabricated on the top copper layer and covered in solder mask. The layers below the antenna do not have copper trace. It is recommended that the module is mounted on the edge of the host PCB. It is permitted for PCB material to be below the antenna structure of the module as long as no copper traces or planes are on the host PCB in that area.

**TABLE 7-2: ANTENNA CHARACTERISTICS**

Specification	Description
Type	PCB
Frequency Range	2.402 to 2.485 MHz
Peak Gain	-0.23 dBi

**FIGURE 7-1: EFFICIENCY**

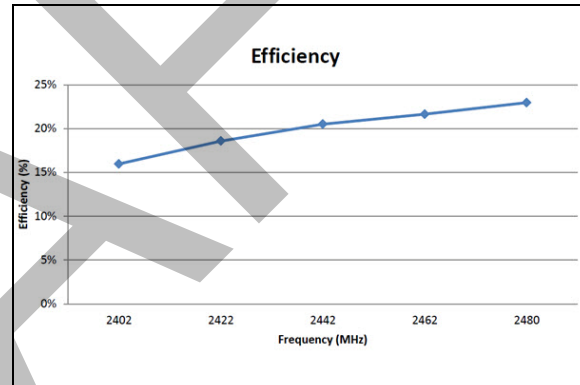

**FIGURE 7-2: ANTENNA PLOT**

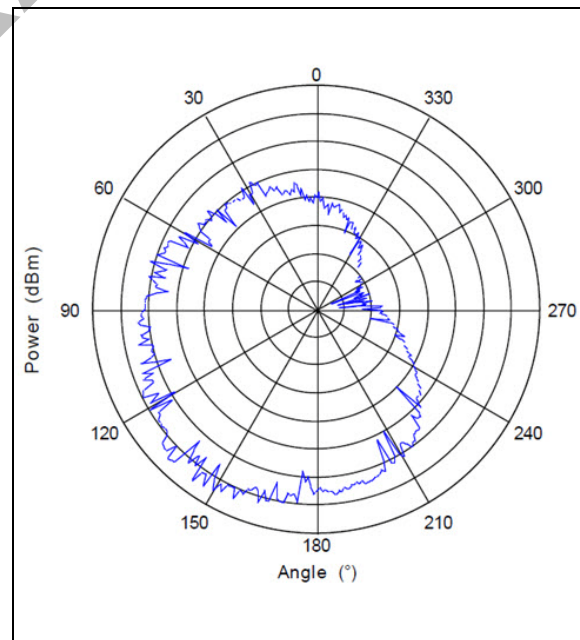

**FIGURE 7-3: 3D RADIATION PATTERN AND ANTENNA ORIENTATION**

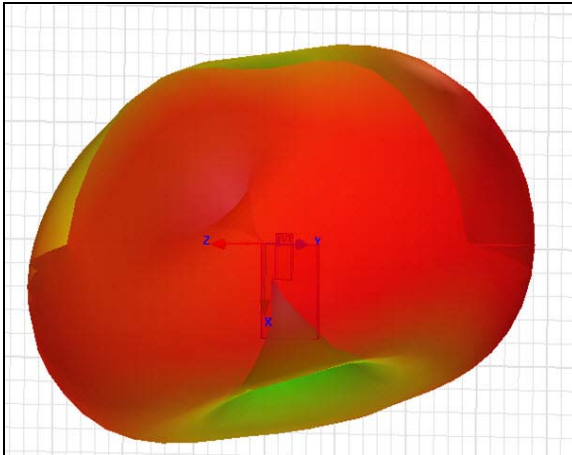

The lead-free solder reflow temperature and times are:

- *Temperature* — 230°C, 60 seconds maximum, peak 245° C maximum
- *Preheat temperature* — 165° ± 15°C, 90 to 120 seconds
- *Time* — Single pass, one time

The solder reflow temperature must not exceed 220°C. To reflow solder the module onto a PCB, Roving Networks recommends a RoHS-compliant solder paste equivalent to NIHON ALMIT paste or OMNIX OM-310 solder paste from Alpha metals. See [Table 7-3](#)

**Note:** Use no-clean flux and *do not* water wash.

**TABLE 7-3: PASTE SOLDER RECOMMENDATIONS**

Manufacturer	Alpha Metals <a href="http://www.alphametals.com">http://www.alphametals.com</a>	NIHON ALMIT Co. LTD <a href="http://almit.co.jp">http://almit.co.jp</a>
Part Number	OMNIX OM-310	LFM-70W INP
Metal Composition	SAC305 (96.5% Sn, 3% Ag, 0.5% Cu)	88% Sn, 3.5% Ag, 0.5% Bi, 8% In
Liquidus Temperature	~220°C	~215°C

**FIGURE 7-4: SOLDER REFLOW TEMPERATURE PROFILE**

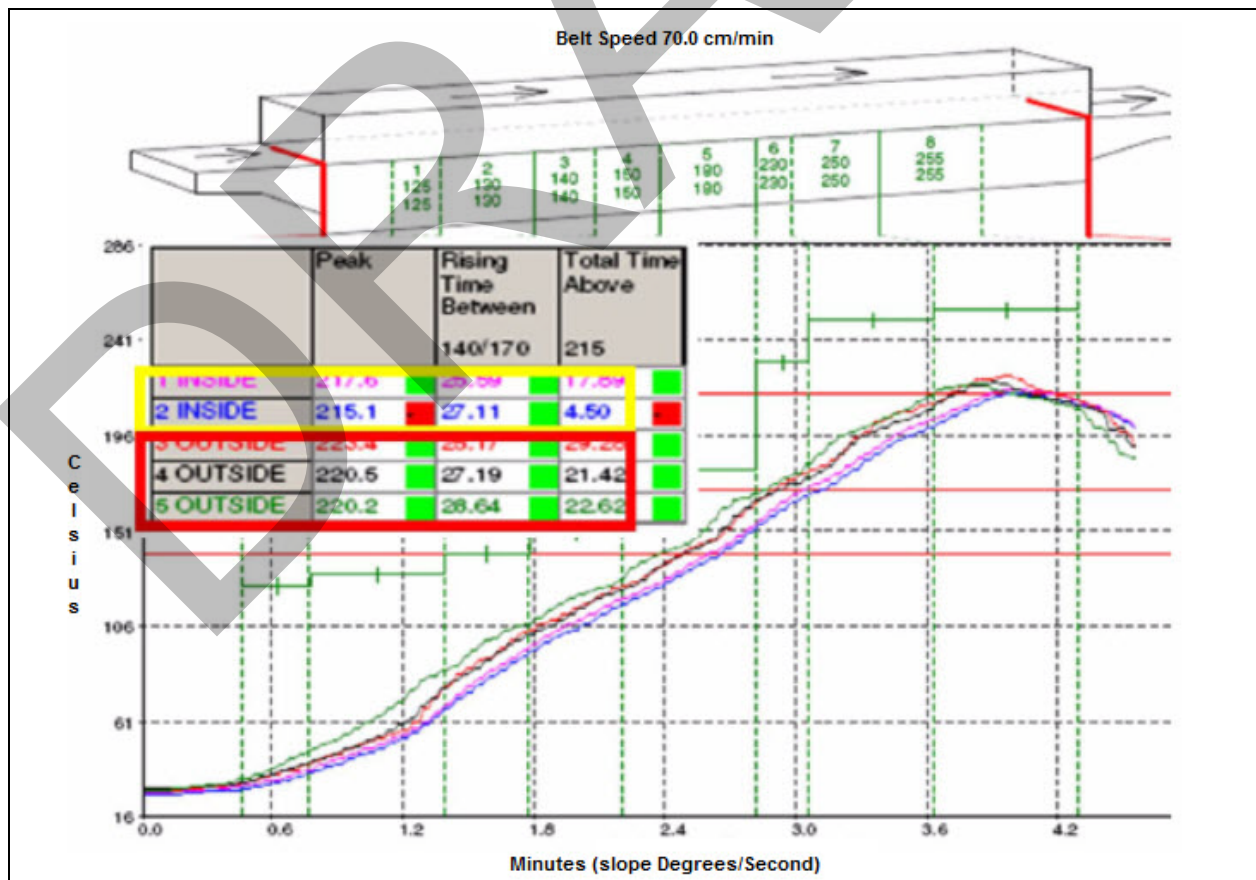

# RN4020

FIGURE 7-5: SOLDER REFLOW CURVE

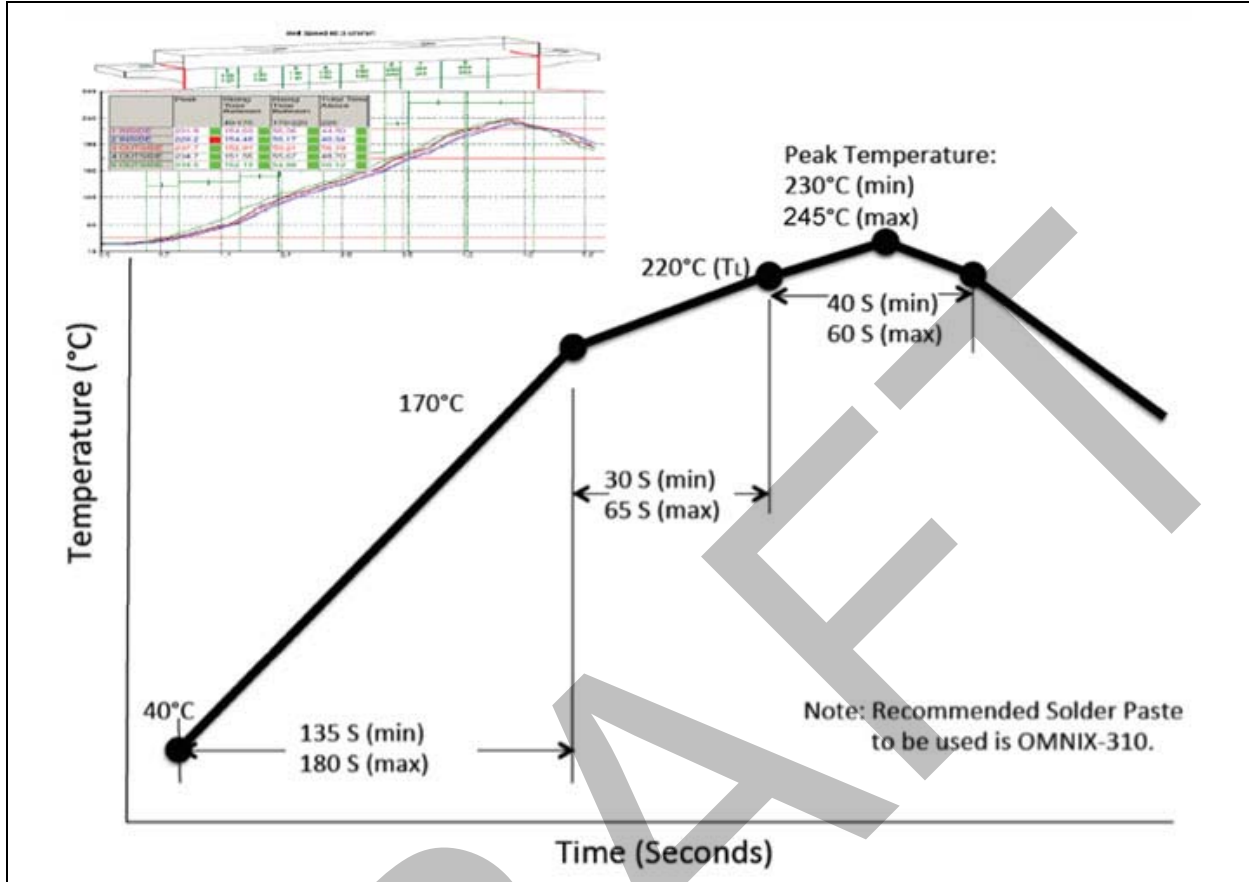

## 8.0 REGULATORY APPROVAL

This section outlines the regulatory information for the RN4020 module for the following countries:

- United States
- Canada
- Europe
- Australia
- New Zealand

### 8.1 United States

The RN4020 module has received Federal Communications Commission (FCC) CFR47 Telecommunications, Part 15 Sub part C “Intentional Radiators” modular approval in accordance with Part 15.212 Modular Transmitter approval. Modular approval allows the end user to integrate the RN4020 module into a finished product without obtaining subsequent and separate FCC approvals for intentional radiation, provided no changes or modifications are made to the module circuitry. Changes or modifications could void the user’s authority to operate the equipment. The end user must comply with all of the instructions provided by the Grantee, which indicate installation and/or operating conditions necessary for compliance.

The finished product is required to comply with all applicable FCC equipment authorizations regulations, requirements and equipment functions not associated with the transmitter module portion. For example, compliance must be demonstrated to regulations for other transmitter components within the host product; to requirements for unintentional radiators (Part 15 Subpart B “Unintentional Radiators”), such as digital devices, computer peripherals, radio receivers, etc.; and to additional authorization requirements for the non-transmitter functions on the transmitter module (i.e., Verification, or Declaration of Conformity) (e.g., transmitter modules may also contain digital logic functions) as appropriate.

### 8.1.1 LABELING AND USER INFORMATION REQUIREMENTS

The RN4020 module has been labeled with its own FCC ID number, and if the FCC ID is not visible when the module is installed inside another device, then the outside of the finished product into which the module is installed must also display a label referring to the enclosed module. This exterior label can use wording as follows:

**RN4020:**

Contains Transmitter Module FCC ID: T9JRN4020  
or

Contains FCC ID: T9JRN4020

This device complies with Part 15 of the FCC Rules. Operation is subject to the following two conditions: (1) this device may not cause harmful interference, and (2) this device must accept any interference received, including interference that may cause undesired operation

A user’s manual for the product should include the following statement:

This equipment has been tested and found to comply with the limits for a Class B digital device, pursuant to part 15 of the FCC Rules. These limits are designed to provide reasonable protection against harmful interference in a residential installation. This equipment generates, uses and can radiate radio frequency energy, and if not installed and used in accordance with the instructions, may cause harmful interference to radio communications. However, there is no guarantee that interference will not occur in a particular installation. If this equipment does cause harmful interference to radio or television reception, which can be determined by turning the equipment off and on, the user is encouraged to try to correct the interference by one or more of the following measures:

- Reorient or relocate the receiving antenna.
- Increase the separation between the equipment and receiver.
- Connect the equipment into an outlet on a circuit different from that to which the receiver is connected.
- Consult the dealer or an experienced radio/TV technician for help.

Additional information on labeling and user information requirements for Part 15 devices can be found in KDB Publication 784748 available at the FCC Office of Engineering and Technology (OET) Laboratory Division Knowledge Database (KDB) <http://apps.fcc.gov/oetcf/kdb/index.cfm>.



Transmitter Antenna (from Section 7.1.2 RSS-Gen, Issue 3, December 2010): User manuals for transmitters shall display the following notice in a conspicuous location:

Under Industry Canada regulations, this radio transmitter may only operate using an antenna of a type and maximum (or lesser) gain approved for the transmitter by Industry Canada. To reduce potential radio interference to other users, the antenna type and its gain should be so chosen that the equivalent isotropically radiated power (e.i.r.p.) is not more than that necessary for successful communication.

Conformément à la réglementation d'Industrie Canada, le présent émetteur radio peut fonctionner avec une antenne d'un type et d'un gain maximal (ou inférieur) approuvé pour l'émetteur par Industrie Canada. Dans le but de réduire les risques de brouillage radioélectrique à l'intention des autres utilisateurs, il faut choisir le type d'antenne et son gain de sorte que la puissance isotrope rayonnée équivalente (p.i.r.e.) ne dépasse pas l'intensité nécessaire à l'établissement d'une communication satisfaisante.

The above notice may be affixed to the device instead of displayed in the user manual.

## 8.2.2 APPROVED EXTERNAL ANTENNA TYPES

Transmitter Antenna (from Section 7.1.2 RSS-Gen, Issue 3, December 2010):

The RN4020 module can only be sold or operated with antennas with which it was approved. Transmitter may be approved with multiple antenna types. An antenna type comprises antennas having similar in-band and out-of-band radiation patterns. Testing shall be performed using the highest gain antenna of each combination of transmitter and antenna type for which approval is being sought, with the transmitter output power set at the maximum level. Any antenna of the same type having equal or lesser gain as an antenna that had been successfully tested with the transmitter, will also be considered approved with the transmitter, and may be used and marketed with the transmitter.

When a measurement at the antenna connector is used to determine RF output power, the effective gain of the device's antenna shall be stated, based on measurement or on data from the antenna manufacturer. For transmitters of output power greater than 10 milliwatts, the total antenna gain shall be added to the measured RF output power to demonstrate compliance to the specified radiated power limits.

## 8.2.3 HELPFUL WEB SITES

Industry Canada: <http://www.ic.gc.ca/>

## 8.3 Europe

The RN4020 module is an R&TTE Directive assessed radio module that is CE marked and has been manufactured and tested with the intention of being integrated into a final product.

The RN4020 module has been tested to R&TTE Directive 1999/5/EC Essential Requirements for Health and Safety (Article (3.1(a)), Electromagnetic Compatibility (EMC) (Article 3.1(b)), and Radio (Article 3.2) and are summarized in Table 3-1: European Compliance Testing. A Notified Body Opinion has also been issued. All test reports are available on the RN4020 product web page at <http://www.microchip.com>.

The R&TTE Compliance Association provides guidance on modular devices in document **Technical Guidance Note 01** available at [http://www.rtteca.com/html/download\\_area.htm](http://www.rtteca.com/html/download_area.htm).

**Note:** To maintain conformance to the testing listed in Table 8-1, the module shall be installed in accordance with the installation instructions in this data sheet and shall not be modified.

When integrating a radio module into a completed product the integrator becomes the manufacturer of the final product and is therefore responsible for demonstrating compliance of the final product with the essential requirements of the R&TTE Directive.

## 8.3.1 LABELING AND USER INFORMATION REQUIREMENTS

The label on the final product which contains the RN4020 module must follow CE marking requirements. The "R&TTE Compliance Association Technical Guidance Note 01" provides guidance on final product CE marking.

## 8.3.2 ANTENNA REQUIREMENTS

From R&TTE Compliance Association document **Technical Guidance Note 01**:

Provided the integrator installing an assessed radio module with an integral or specific antenna and installed in conformance with the radio module manufacturer's installation instructions requires no further evaluation under Article 3.2 of the R&TTE Directive and does not require further involvement of an R&TTE Directive Notified Body for the final product. [Section 2.2.4]

## 8.3.3 HELPFUL WEB SITES

A document that can be used as a starting point in understanding the use of Short Range Devices (SRD) in Europe is the European Radio Communications Committee (ERC) Recommendation 70-03 E, which can be downloaded from the European Radio Communications Office (ERO) at: <http://www.ero.dk/>.

Additional helpful web sites are:

- Radio and Telecommunications Terminal Equipment (R&TTE):  
[http://ec.europa.eu/enterprise/rtte/index\\_en.htm](http://ec.europa.eu/enterprise/rtte/index_en.htm)
- European Conference of Postal and Telecommunications Administrations (CEPT):  
<http://www.cept.org/>
- European Telecommunications Standards Institute (ETSI):  
<http://www.etsi.org>
- European Radio Communications Office (ERO):  
<http://www.ero.dk/>
- The Radio and Telecommunications Terminal Equipment Compliance Association (R&TTE CA):  
<http://www.rteca.com/>



**TABLE 8-1: RN4020 EUROPEAN COMPLIANCE TESTING**

Certification	Standards	Article	Laboratory	Report Number	Date
	<b>CE0681</b>				

## 8.4 Australia

The Australia radio regulations do not provide a modular approval policy similar to the United States (FCC) and Canada (IC). However, RN4020 module RF transmitter test reports can be used in part to demonstrate compliance in accordance with ACMA Radio communications “Short Range Devices” Standard 2004 (The Short Range Devices standard calls up the AS/NZS 4268:2008 industry standard). The RN4020 module test reports can be used as part of the product certification and compliance folder. For more information on the RF transmitter test reports, contact Microchip Technology Australia sales office.

To meet overall Australian final product compliance, the developer must construct a compliance folder containing all relevant compliance test reports e.g. RF, EMC, electrical safety and DoC (Declaration of Conformity) etc. It is the responsibility of the integrator to know what is required in the compliance folder for ACMA compliance. All test reports are available on the RN4020 product web page at <http://www.microchip.com>. For more information on Australia compliance, refer to the Australian Communications and Media Authority web site <http://www.acma.gov.au/>.

### 8.4.2 HELPFUL WEB SITES

The Australian Communications and Media Authority: [www.acma.gov.au/](http://www.acma.gov.au/).

## 8.5 New Zealand

The New Zealand radio regulations do not provide a modular approval policy similar to the United States (FCC) and Canada (IC). However, RN4020 module RF transmitter test reports can be used in part to demonstrate compliance against the New Zealand “General User Radio License for Short Range Devices”. New Zealand Radio communications (Radio Standards) Notice 2010 calls up the AS / NZS 4268:2008 industry standard. The RN4020 module test reports can be used as part of the product certification and compliance folder. All test reports are available on the RN4020 product web page at <http://www.microchip.com>. For more information on the RF transmitter test reports, contact Microchip Technology sales office.

Information on the New Zealand short range devices license can be found in the following web links:

<http://www.rsm.govt.nz/cms/licensees/types-oflicence/general-user-licences/short-range-devices>

and

<http://www.rsm.govt.nz/cms/policy-and-planning/spectrum-policy-overview/legislation/gazette-notices/product-compliance/radiocommunications-radiostandards-notice-2010>.

To meet overall New Zealand final product compliance, the developer must construct a compliance folder containing all relevant compliance test reports e.g. RF, EMC, electrical safety and DoC (Declaration of Conformity) etc. It is the responsibility of the developer to know what is required in the compliance folder for New Zealand Radio communications. For more information on New Zealand compliance, refer to the web site <http://www.rsm.govt.nz/>.

I

DRAFT

## 9.0 ORDERING INFORMATION

Table 9-1 provides ordering information for the RN4020 module.

**TABLE 9-1: ORDERING INFORMATION**

Part Number	Description
RN4020RM	Standard firmware (GATT, GAP, L2CAP) peripheral and Central mode

**Note:** For custom applications, contact Microchip representative.

Go to <http://www.microchip.com> for current pricing and a list of distributors carrying Microchip products.

NOTES:

DRAFT

## APPENDIX A: REVISION HISTORY

### Revision A (May 2014)

This is the initial released version of the document in the Microchip format.

DRAFT

NOTES:

DRAFT

## THE MICROCHIP WEB SITE

Microchip provides online support via our WWW site at [www.microchip.com](http://www.microchip.com). This web site is used as a means to make files and information easily available to customers. Accessible by using your favorite Internet browser, the web site contains the following information:

- **Product Support** – Data sheets and errata, application notes and sample programs, design resources, user's guides and hardware support documents, latest software releases and archived software
- **General Technical Support** – Frequently Asked Questions (FAQ), technical support requests, online discussion groups, Microchip consultant program member listing
- **Business of Microchip** – Product selector and ordering guides, latest Microchip press releases, listing of seminars and events, listings of Microchip sales offices, distributors and factory representatives

## CUSTOMER CHANGE NOTIFICATION SERVICE

Microchip's customer notification service helps keep customers current on Microchip products. Subscribers will receive e-mail notification whenever there are changes, updates, revisions or errata related to a specified product family or development tool of interest.

To register, access the Microchip web site at [www.microchip.com](http://www.microchip.com). Under "Support", click on "Customer Change Notification" and follow the registration instructions.

## CUSTOMER SUPPORT

Users of Microchip products can receive assistance through several channels:

- Distributor or Representative
- Local Sales Office
- Field Application Engineer (FAE)
- Technical Support

Customers should contact their distributor, representative or Field Application Engineer (FAE) for support. Local sales offices are also available to help customers. A listing of sales offices and locations is included in the back of this document.

**Technical support is available through the web site at: <http://microchip.com/support>**

NOTES:

DRAFT



## PRODUCT IDENTIFICATION SYSTEM

To order or obtain information, e.g., on pricing or delivery, refer to the factory or the listed sales office.

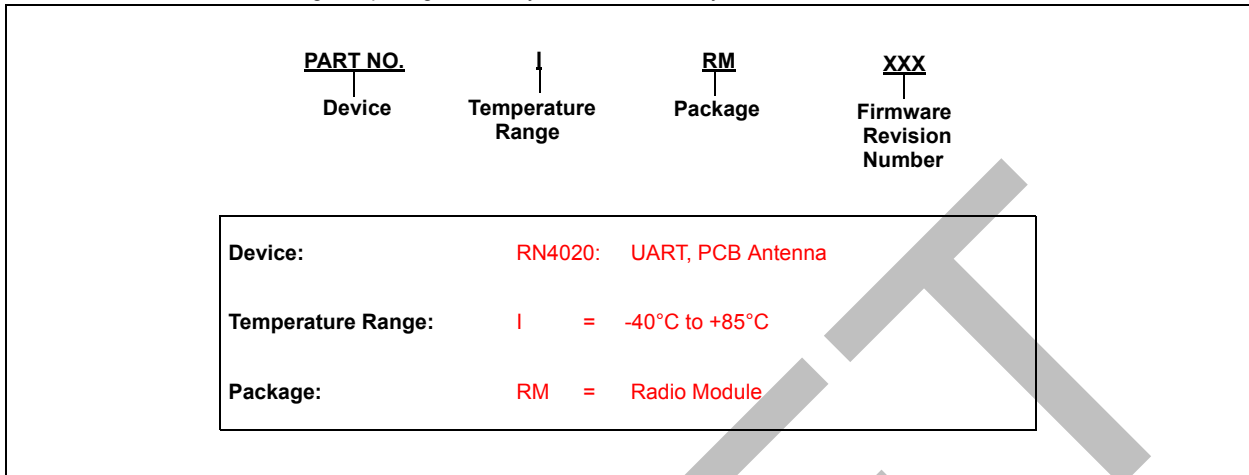

NOTES:

DRAFT

---

**Note the following details of the code protection feature on Microchip devices:**

- Microchip products meet the specification contained in their particular Microchip Data Sheet.
- Microchip believes that its family of products is one of the most secure families of its kind on the market today, when used in the intended manner and under normal conditions.
- There are dishonest and possibly illegal methods used to breach the code protection feature. All of these methods, to our knowledge, require using the Microchip products in a manner outside the operating specifications contained in Microchip's Data Sheets. Most likely, the person doing so is engaged in theft of intellectual property.
- Microchip is willing to work with the customer who is concerned about the integrity of their code.
- Neither Microchip nor any other semiconductor manufacturer can guarantee the security of their code. Code protection does not mean that we are guaranteeing the product as “unbreakable.”

Code protection is constantly evolving. We at Microchip are committed to continuously improving the code protection features of our products. Attempts to break Microchip's code protection feature may be a violation of the Digital Millennium Copyright Act. If such acts allow unauthorized access to your software or other copyrighted work, you may have a right to sue for relief under that Act.

---

Information contained in this publication regarding device applications and the like is provided only for your convenience and may be superseded by updates. It is your responsibility to ensure that your application meets with your specifications. MICROCHIP MAKES NO REPRESENTATIONS OR WARRANTIES OF ANY KIND WHETHER EXPRESS OR IMPLIED, WRITTEN OR ORAL, STATUTORY OR OTHERWISE, RELATED TO THE INFORMATION, INCLUDING BUT NOT LIMITED TO ITS CONDITION, QUALITY, PERFORMANCE, MERCHANTABILITY OR FITNESS FOR PURPOSE. Microchip disclaims all liability arising from this information and its use. Use of Microchip devices in life support and/or safety applications is entirely at the buyer's risk, and the buyer agrees to defend, indemnify and hold harmless Microchip from any and all damages, claims, suits, or expenses resulting from such use. No licenses are conveyed, implicitly or otherwise, under any Microchip intellectual property rights.

#### Trademarks

The Microchip name and logo, the Microchip logo, dsPIC, FlashFlex, KEELOQ, KEELOQ logo, MPLAB, PIC, PICmicro, PICSTART, PIC<sup>32</sup> logo, rPIC, SST, SST Logo, SuperFlash and UNI/O are registered trademarks of Microchip Technology Incorporated in the U.S.A. and other countries.

FilterLab, Hampshire, HI-TECH C, Linear Active Thermistor, MTP, SEEVAL and The Embedded Control Solutions Company are registered trademarks of Microchip Technology Incorporated in the U.S.A.

Silicon Storage Technology is a registered trademark of Microchip Technology Inc. in other countries.

Analog-for-the-Digital Age, Application Maestro, BodyCom, chipKIT, chipKIT logo, CodeGuard, dsPICDEM, dsPICDEM.net, dsPICworks, dsSPEAK, ECAN, ECONOMONITOR, FanSense, HI-TIDE, In-Circuit Serial Programming, ICSP, Mindi, MiWi, MPASM, MPF, MPLAB Certified logo, MPLIB, MPLINK, mTouch, Omniscient Code Generation, PICC, PICC-18, PICDEM, PICDEM.net, PICkit, PICtail, REAL ICE, rLAB, Select Mode, SQI, Serial Quad I/O, Total Endurance, TSHARC, UniWinDriver, WiperLock, ZENA and Z-Scale are trademarks of Microchip Technology Incorporated in the U.S.A. and other countries.

SQTP is a service mark of Microchip Technology Incorporated in the U.S.A.

GestIC and ULPP are registered trademarks of Microchip Technology Germany II GmbH & Co. KG, a subsidiary of Microchip Technology Inc., in other countries.

All other trademarks mentioned herein are property of their respective companies.

© 2014, Microchip Technology Incorporated, Printed in the U.S.A., All Rights Reserved.

 Printed on recycled paper.

ISBN:

*Microchip received ISO/TS-16949:2009 certification for its worldwide headquarters, design and wafer fabrication facilities in Chandler and Tempe, Arizona; Gresham, Oregon and design centers in California and India. The Company's quality system processes and procedures are for its PIC<sup>®</sup> MCUs and dsPIC<sup>®</sup> DSCs, KEELOQ<sup>®</sup> code hopping devices, Serial EEPROMs, microperipherals, nonvolatile memory and analog products. In addition, Microchip's quality system for the design and manufacture of development systems is ISO 9001:2000 certified.*

**QUALITY MANAGEMENT SYSTEM  
CERTIFIED BY DNV  
= ISO/TS 16949 =**



# MICROCHIP

## Worldwide Sales and Service

### AMERICAS

**Corporate Office**  
2355 West Chandler Blvd.  
Chandler, AZ 85224-6199  
Tel: 480-792-7200  
Fax: 480-792-7277  
Technical Support:  
<http://www.microchip.com/support>  
Web Address:  
[www.microchip.com](http://www.microchip.com)

**Atlanta**  
Duluth, GA  
Tel: 678-957-9614  
Fax: 678-957-1455

**Austin, TX**  
Tel: 512-257-3370

**Boston**  
Westborough, MA  
Tel: 774-760-0087  
Fax: 774-760-0088

**Chicago**  
Itasca, IL  
Tel: 630-285-0071  
Fax: 630-285-0075

**Cleveland**  
Independence, OH  
Tel: 216-447-0464  
Fax: 216-447-0643

**Dallas**  
Addison, TX  
Tel: 972-818-7423  
Fax: 972-818-2924

**Detroit**  
Novi, MI  
Tel: 248-848-4000

**Houston, TX**  
Tel: 281-894-5983

**Indianapolis**  
Noblesville, IN  
Tel: 317-773-8323  
Fax: 317-773-5453

**Los Angeles**  
Mission Viejo, CA  
Tel: 949-462-9523  
Fax: 949-462-9608

**New York, NY**  
Tel: 631-435-6000

**San Jose, CA**  
Tel: 408-735-9110

**Canada - Toronto**  
Tel: 905-673-0699  
Fax: 905-673-6509

### ASIA/PACIFIC

**Asia Pacific Office**  
Suites 3707-14, 37th Floor  
Tower 6, The Gateway  
Harbour City, Kowloon  
Hong Kong  
Tel: 852-2943-5100  
Fax: 852-2401-3431

**Australia - Sydney**  
Tel: 61-2-9868-6733  
Fax: 61-2-9868-6755

**China - Beijing**  
Tel: 86-10-8569-7000  
Fax: 86-10-8528-2104

**China - Chengdu**  
Tel: 86-28-8665-5511  
Fax: 86-28-8665-7889

**China - Chongqing**  
Tel: 86-23-8980-9588  
Fax: 86-23-8980-9500

**China - Hangzhou**  
Tel: 86-571-8792-8115  
Fax: 86-571-8792-8116

**China - Hong Kong SAR**  
Tel: 852-2943-5100  
Fax: 852-2401-3431

**China - Nanjing**  
Tel: 86-25-8473-2460  
Fax: 86-25-8473-2470

**China - Qingdao**  
Tel: 86-532-8502-7355  
Fax: 86-532-8502-7205

**China - Shanghai**  
Tel: 86-21-5407-5533  
Fax: 86-21-5407-5066

**China - Shenyang**  
Tel: 86-24-2334-2829  
Fax: 86-24-2334-2393

**China - Shenzhen**  
Tel: 86-755-8864-2200  
Fax: 86-755-8203-1760

**China - Wuhan**  
Tel: 86-27-5980-5300  
Fax: 86-27-5980-5118

**China - Xian**  
Tel: 86-29-8833-7252  
Fax: 86-29-8833-7256

**China - Xiamen**  
Tel: 86-592-2388138  
Fax: 86-592-2388130

**China - Zhuhai**  
Tel: 86-756-3210040  
Fax: 86-756-3210049

### ASIA/PACIFIC

**India - Bangalore**  
Tel: 91-80-3090-4444  
Fax: 91-80-3090-4123

**India - New Delhi**  
Tel: 91-11-4160-8631  
Fax: 91-11-4160-8632

**India - Pune**  
Tel: 91-20-3019-1500

**Japan - Osaka**  
Tel: 81-6-6152-7160  
Fax: 81-6-6152-9310

**Japan - Tokyo**  
Tel: 81-3-6880-3770  
Fax: 81-3-6880-3771

**Korea - Daegu**  
Tel: 82-53-744-4301  
Fax: 82-53-744-4302

**Korea - Seoul**  
Tel: 82-2-554-7200  
Fax: 82-2-558-5932 or  
82-2-558-5934

**Malaysia - Kuala Lumpur**  
Tel: 60-3-6201-9857  
Fax: 60-3-6201-9859

**Malaysia - Penang**  
Tel: 60-4-227-8870  
Fax: 60-4-227-4068

**Philippines - Manila**  
Tel: 63-2-634-9065  
Fax: 63-2-634-9069

**Singapore**  
Tel: 65-6334-8870  
Fax: 65-6334-8850

**Taiwan - Hsin Chu**  
Tel: 886-3-5778-366  
Fax: 886-3-5770-955

**Taiwan - Kaohsiung**  
Tel: 886-7-213-7830

**Taiwan - Taipei**  
Tel: 886-2-2508-8600  
Fax: 886-2-2508-0102

**Thailand - Bangkok**  
Tel: 66-2-694-1351  
Fax: 66-2-694-1350

### EUROPE

**Austria - Wels**  
Tel: 43-7242-2244-39  
Fax: 43-7242-2244-393

**Denmark - Copenhagen**  
Tel: 45-4450-2828  
Fax: 45-4485-2829

**France - Paris**  
Tel: 33-1-69-53-63-20  
Fax: 33-1-69-30-90-79

**Germany - Dusseldorf**  
Tel: 49-2129-3766400

**Germany - Munich**  
Tel: 49-89-627-144-0  
Fax: 49-89-627-144-44

**Germany - Pforzheim**  
Tel: 49-7231-424750

**Italy - Milan**  
Tel: 39-0331-742611  
Fax: 39-0331-466781

**Italy - Venice**  
Tel: 39-049-7625286

**Netherlands - Drunen**  
Tel: 31-416-690399  
Fax: 31-416-690340

**Poland - Warsaw**  
Tel: 48-22-3325737

**Spain - Madrid**  
Tel: 34-91-708-08-90  
Fax: 34-91-708-08-91

**Sweden - Stockholm**  
Tel: 46-8-5090-4654

**UK - Wokingham**  
Tel: 44-118-921-5800  
Fax: 44-118-921-5820

03/25/14