



Part 15C

TEST REPORT

Product Name	Wi-Fi Internet of Things Module
Model	ESP-WROOM-02
Brand Name	WROOM
FCC ID	2AC7Z-ESPWROOM02
Applicant	ESPRESSIF SYSTEMS (SHANGHAI) PTE LTD
Manufacturer	ESPRESSIF SYSTEMS (SHANGHAI) PTE LTD
Date of issue	April 17, 2015

TA Technology (Shanghai) Co., Ltd.

TA Technology (Shanghai) Co., Ltd.
Test Report

Report No.: RXA1503-0042RF01R1

Page 2 of 103

GENERAL SUMMARY

Reference Standard(s)	<p>FCC CFR47 Part 15C (2013) Radio Frequency Devices</p> <p>15.205 Restricted bands of operation;</p> <p>15.207 Conducted limits;</p> <p>15.209 Radiated emission limits; general requirements;</p> <p>15.247 Operation within the bands 902-928 MHz, 2400-2483.5 MHz, and 5725-5850MHz.</p> <p>ANSI C63.4 Methods of Measurement of Radio-Noise Emission from Low-Voltage Electrical and Electronic Equipment in the Range of 9 KHz to 40GHz. (2009)</p> <p>KDB 558074 D01 DTS Meas Guidance v03r02 Guidance for Performing Compliance Measurements on Digital Transmission Systems (DTS) Operating Under §15.247</p>
Conclusion	<p>This equipment has been measured in all cases requested by the relevant standards. Test results in Chapter 2 of this test report are below limits specified in the relevant standards.</p> <p>General Judgment: Pass</p>
Comment	<p>The test result only responds to the measured sample.</p>

Approved by *Kai Xu*

Kai Xu
Director

Revised by *Lingling Kang*

Lingling Kang
RF Manager

Performed by *Changxu Wan*

Changxu Wan
RF Engineer

TABLE OF CONTENT

1. General Information	4
1.1. Notes of the test report	4
1.2. Testing laboratory	5
1.3. Applicant Information	5
1.4. Manufacturer Information	5
1.5. Information of EUT	6
1.6. Test Date	6
2. Test Information	7
2.1. Test Mode	7
2.2. Summary of test results	8
2.3. Peak Power Output –Conducted.....	9
2.4. Occupied Bandwidth (6dB)	11
2.5. Band Edge Compliance	17
2.6. Spurious Radiated Emissions in the restricted band.....	21
2.7. Power Spectral Density.....	30
2.8. Spurious RF Conducted Emissions	36
2.9. Radiates Emission	54
2.10. Conducted Emissions	93
2. Main Test Instruments	100
ANNEX A: EUT Appearance and Test Setup.....	101
A.1 EUT Appearance	101
A.2 Test Setup	102

TA Technology (Shanghai) Co., Ltd. Test Report

Report No.: RXA1503-0042RF01R1

Page 4 of 103

1. General Information

1.1. Notes of the test report

TA Technology (Shanghai) Co., Ltd. has obtained the accreditation of China National Accreditation Service for Conformity Assessment (CNAS), and accreditation number: L2264.

TA Technology (Shanghai) Co., Ltd. has been listed on the US Federal Communications Commission list of test facilities recognized to perform electromagnetic emissions measurements. The site recognition number is 428261.

TA Technology (Shanghai) Co., Ltd. has been listed by industry Canada to perform electromagnetic emission measurement. The site recognition number is 8510A.

TA Technology (Shanghai) Co., Ltd. guarantees the reliability of the data presented in this test report, which is the results of measurements and tests performed for the items under test on the date and under the conditions stated in this test report and is based on the knowledge and technical facilities available at TA Technology (Shanghai) Co., Ltd. at the time of execution of the test.

TA Technology (Shanghai) Co., Ltd. is liable to the client for the maintenance by its personnel of the confidentiality of all information related to the items under test and the results of the test. The sample under test was selected by the Client. This report only refers to the item that has undergone the test.

The test results in this test report relate only to the devices specified in this report. This report shall not be reproduced except in full without the written approval of **TA Technology (Shanghai) Co., Ltd.**

If the electronic report is inconsistent with the printed one, it should be subject to the latter.

TA Technology (Shanghai) Co., Ltd.

Test Report

Report No.: RXA1503-0042RF01R1

Page 5 of 103

1.2. Testing laboratory

Company: TA Technology (Shanghai) Co., Ltd.
Address: No.145, Jintang Rd, Tangzhen Industry Park, Pudong
City: Shanghai
Post code: 201201
Country: P. R. China
Contact: Xu Kai
Telephone: +86-021-50791141/2/3
Fax: +86-021-50791141/2/3-8000
Website: <http://www.ta-shanghai.com>
E-mail: xukai@ta-shanghai.com

1.3. Applicant Information

Company: ESPRESSIF SYSTEMS (SHANGHAI) PTE LTD
Address: Room 204, Building 2 , 690 Bibo Road, Zhangjiang Hi-tech Park,
201203, Shanghai/China

1.4. Manufacturer Information

Company: ESPRESSIF SYSTEMS (SHANGHAI) PTE LTD
Address: Room 204, Building 2 , 690 Bibo Road, Zhangjiang Hi-tech Park,
201203, Shanghai/China

TA Technology (Shanghai) Co., Ltd.
Test Report

Report No.: RXA1503-0042RF01R1

Page 6 of 103

1.5. Information of EUT

General information

SN:	ESPWROOM02-292014-1
Hardware Version:	HW V1.0
Software Version:	SW V1.0
Antenna Type:	Internal Antennas
Device Operating Configurations:	
Test Function:	802.11b, 802.11g, 802.11n (HT20)
Test Modulation:	(802.11b)DSSS; (802.11g)OFDM; 802.11n OFDM
Max Conducted Power	22.23 dBm
Operating Frequency Range(s)	2412MHz~ 2462MHz
Tested Frequency Range(s)	2400MHz~ 2483.5 MHz

1.6. Test Date

The test is performed from March 28, 2015 to April 5, 2015.

TA Technology (Shanghai) Co., Ltd.

Test Report

2. Test Information

2.1. Test Mode

The EUT has been associated with peripherals and configuration operated in a manner tended to maximize its emission characteristics in a typical application.

The radiated emission was measured in the following position: EUT stand-up position (Z axis), lie-down position (X, Y axis). The worst emission was found in lie-down position (X axis) and the worst case was recorded.

In order to find the worst case condition, Pre-tests are needed at the presence of different data rate declared in basic standard IEEE802.11. Preliminary tests has been done on all the configuration for confirming worst case. Data rate below means worst-case rate of each test item.

Results of test modes, data rates and test channels are shown as following table.

	Test items	Modes	Data Rate	Test channel
Conducted Test cases	Peak Power Output –Conducted	802.11b	11 Mbps	1/6/11
		802.11g	6 Mbps	1/6/11
		802.11n(HT20)	MCS0	1/6/11
	Minimum 6dB bandwidth	802.11b	11 Mbps	1/6/11
		802.11g	6 Mbps	1/6/11
		802.11n(HT20)	MCS0	1/6/11
	Band Edges compliance	802.11b	11 Mbps	1/11
		802.11g	6 Mbps	1/11
		802.11n(HT20)	MCS0	1/11
	Power spectral Density	802.11b	11 Mbps	1/6/11
		802.11g	6 Mbps	1/6/11
		802.11n(HT20)	MCS0	1/6/11
	Conducted Spurious Emission	802.11b	11 Mbps	1/6/11
		802.11g	6 Mbps	1/6/11
		802.11n(HT20)	MCS0	1/6/11
Conducted Emissions	802.11b	11 Mbps	6	
	802.11g	6 Mbps	6	
	802.11n(HT20)	MCS0	6	
Radiated Test cases	Spurious Radiated Emissions in the restricted band	802.11b	11 Mbps	1/11
		802.11g	6 Mbps	1/11
		802.11n(HT20)	MCS0	1/11
	Radiates Emission	802.11b	11 Mbps	1/6/11
		802.11g	6 Mbps	1/6/11
		802.11n(HT20)	MCS0	1/6/11

TA Technology (Shanghai) Co., Ltd.
Test Report

Report No.: RXA1503-0042RF01R1

Page 8 of 103

2.2. Summary of test results

Number	Summary of measurements of results	Clause in FCC rules	Verdict
1	Peak Power Output –Conducted	15.247(b)(3)	PASS
2	Minimum 6dB bandwidth	15.247(a)(2)	PASS
3	Band Edges compliance	15.247(d)	PASS
4	Spurious Radiated Emissions in the restricted band	15.247(d),15.205,15.209	PASS
5	Power spectral Density	15.247(e)	PASS
6	Conducted Spurious Emission	15.247	PASS
7	Radiates Emission	15.247(d),15.205,15.209	PASS
8	Conducted Emissions	15.207,15.107	PASS

2.3. Peak Power Output –Conducted

Ambient condition

Temperature	Relative humidity	Pressure
23°C ~ 25°C	45% ~ 50%	101.5kPa

Methods of Measurement

During the process of the testing, The EUT was connected to the peak power meter through an external attenuator and a known loss cable. The EUT is max power transmission with proper modulation. We use 5.2.1 Maximum Peak Conducted Output Power Level Method in KDB 558074 D01 for this test.

Test Setup

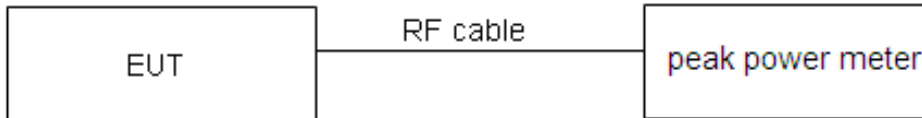

Limits

Rule Part 15.247 (b) (3) specifies that " For systems using digital modulation in the 902–928 MHz, 2400–2483.5 MHz, and 5725–5850 MHz bands: 1 Watt."

Peak Output Power	$\leq 1W$ (30dBm)
-------------------	-------------------

Measurement Uncertainty

The assessed measurement uncertainty to ensure 95% confidence level for the normal distribution is with the coverage factor $k = 2$, $U = 0.44$ dB.

TA Technology (Shanghai) Co., Ltd.
Test Report

Report No.: RXA1503-0042RF01R1

Page 10 of 103

Test Results:

Network Standards	Carrier frequency (MHz)	Peak Output Power (dBm)	Conclusion
802.11b	2412	21.67	PASS
	2437	22.08	PASS
	2462	22.23	PASS
802.11g	2412	21.57	PASS
	2437	21.17	PASS
	2462	21.39	PASS
802.11n HT20	2412	21.68	PASS
	2437	21.89	PASS
	2462	22.04	PASS

TA Technology (Shanghai) Co., Ltd.

Test Report

Report No.: RXA1503-0042RF01R1

Page 11 of 103

2.4. Occupied Bandwidth (6dB)

Ambient condition

Temperature	Relative humidity	Pressure
23°C ~25°C	45%~50%	101.5kPa

Method of Measurement

The EUT was connected to the spectrum analyzer through an external attenuator (20dB) and a known loss cable. RBW is set to 100 kHz, VBW is set to 300 kHz on spectrum analyzer.

Test Setup

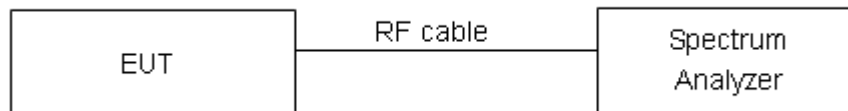

Limits

Rule Part 15.247 (a) (2) specifies that “Systems using digital modulation techniques may operate in the 902–928 MHz, 2400–2483.5 MHz, and 5725–5850 MHz bands. The minimum 6 dB bandwidth shall be at least 500 kHz.”

minimum 6 dB bandwidth	≥ 500 kHz
------------------------	-----------

Measurement Uncertainty

The assessed measurement uncertainty to ensure 95% confidence level for the normal distribution is with the coverage factor $k = 2$, $U = 936$ Hz.

TA Technology (Shanghai) Co., Ltd. Test Report

Test Results:

Network Standards	Carrier frequency (MHz)	Minimum 6 dB bandwidth (MHz)	Conclusion
802.11b	2412	12.14	PASS
	2437	12.10	PASS
	2462	12.11	PASS
802.11g	2412	15.80	PASS
	2437	15.81	PASS
	2462	15.85	PASS
802.11n HT20	2412	17.04	PASS
	2437	16.67	PASS
	2462	17.02	PASS

802.11b

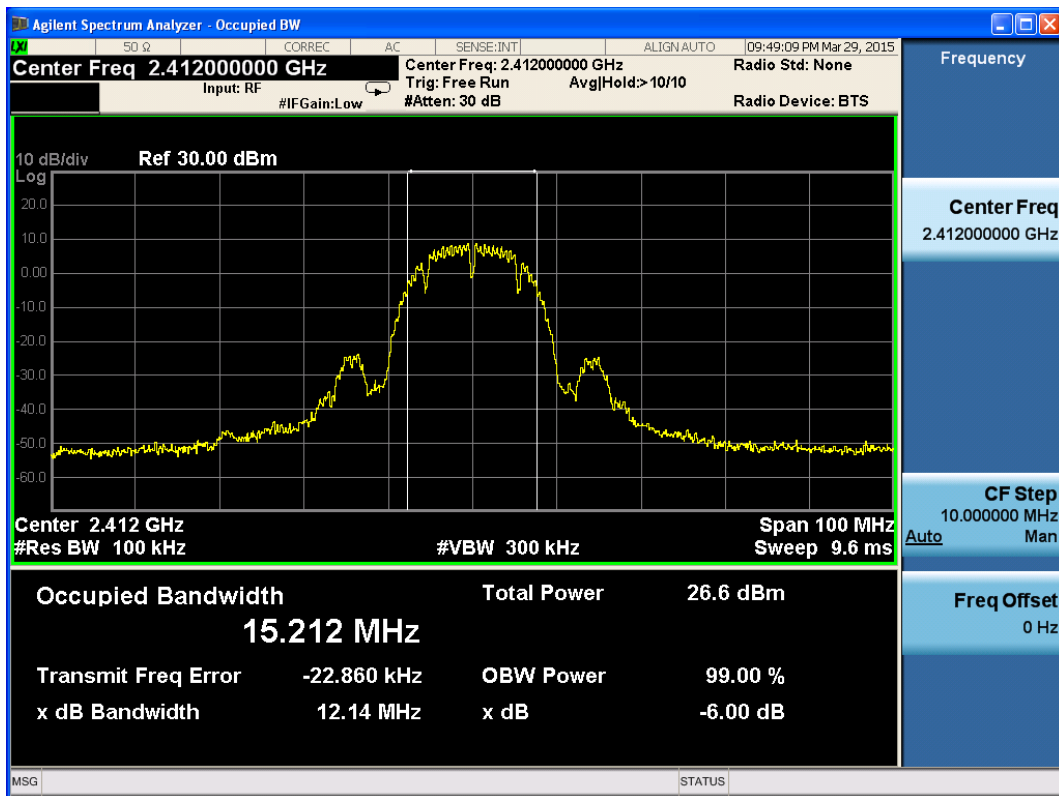

802.11b, Carrier frequency (MHz): 2412

TA Technology (Shanghai) Co., Ltd. Test Report

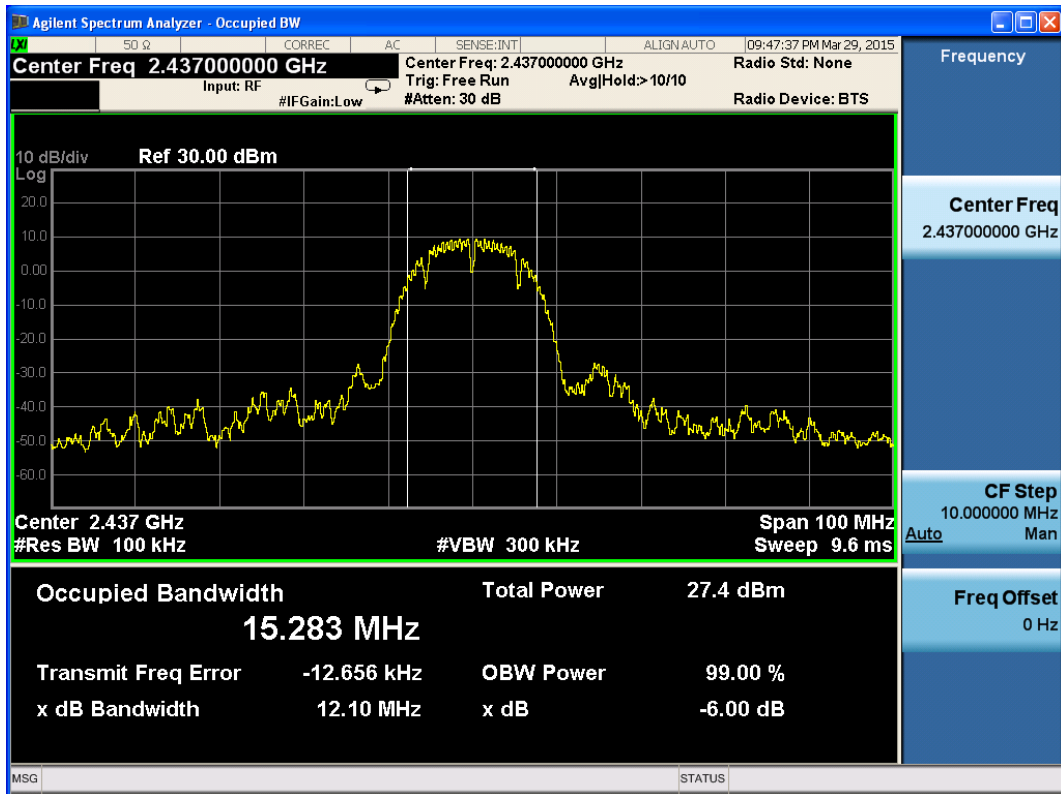

802.11b, Carrier frequency (MHz): 2437

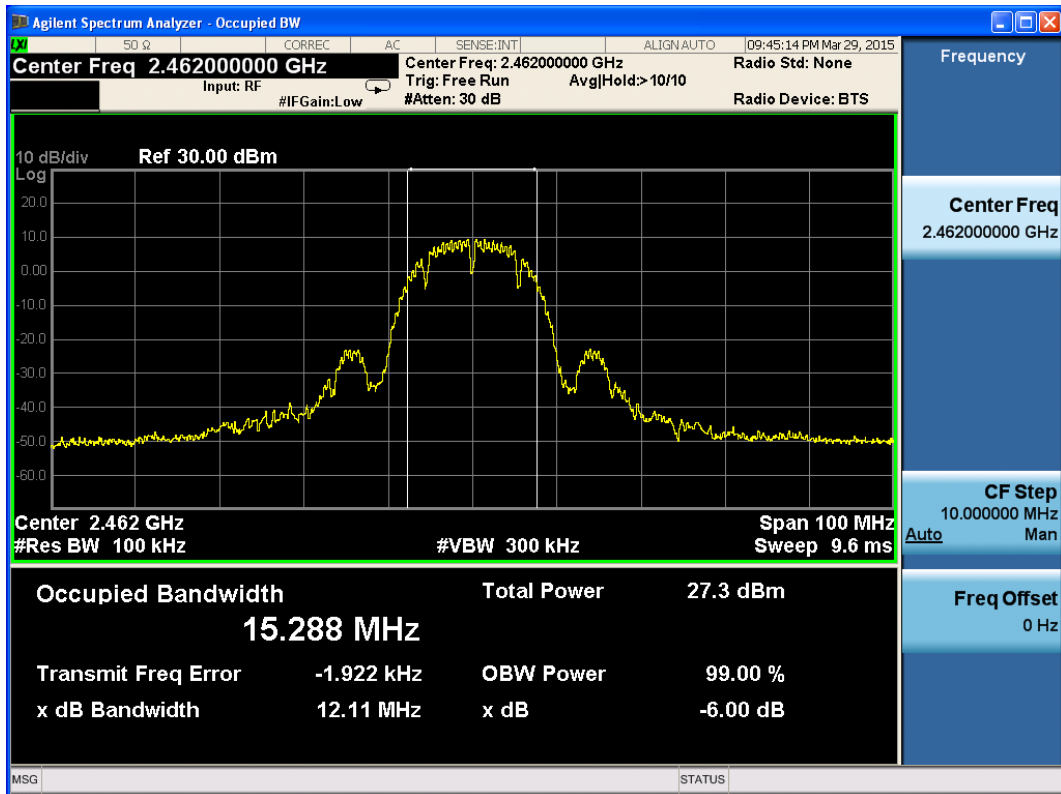

802.11b, Carrier frequency (MHz): 2462

TA Technology (Shanghai) Co., Ltd. Test Report

802.11g

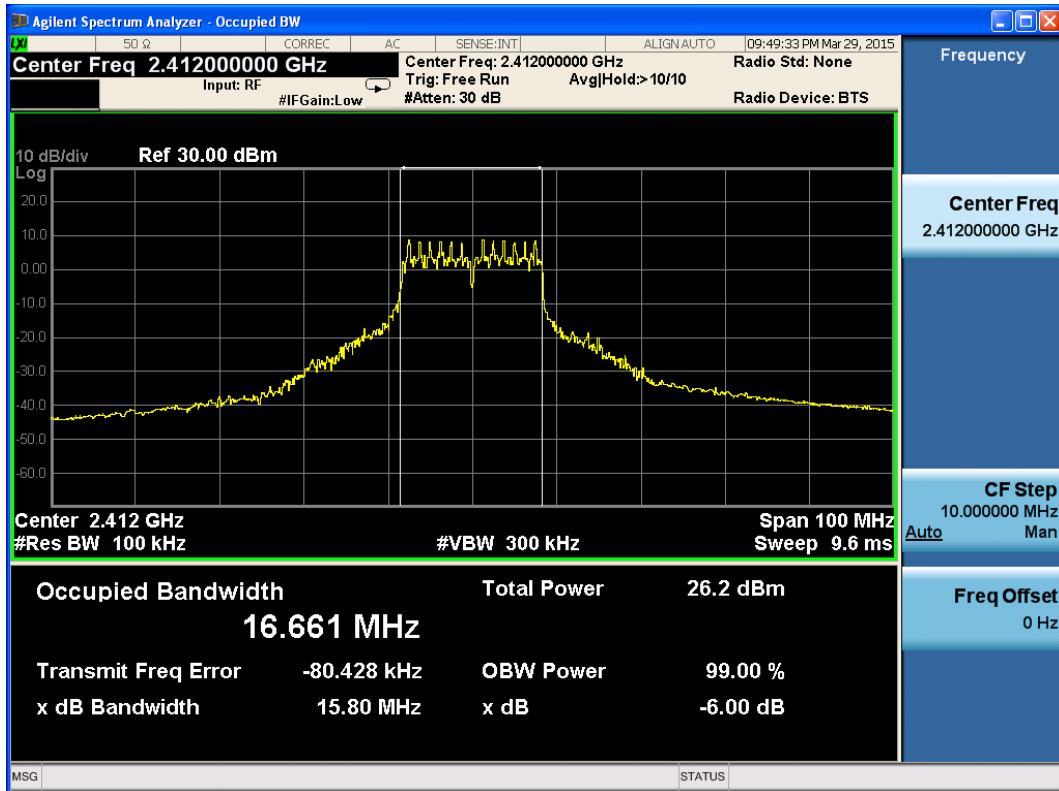

802.11g, Carrier frequency (MHz): 2412

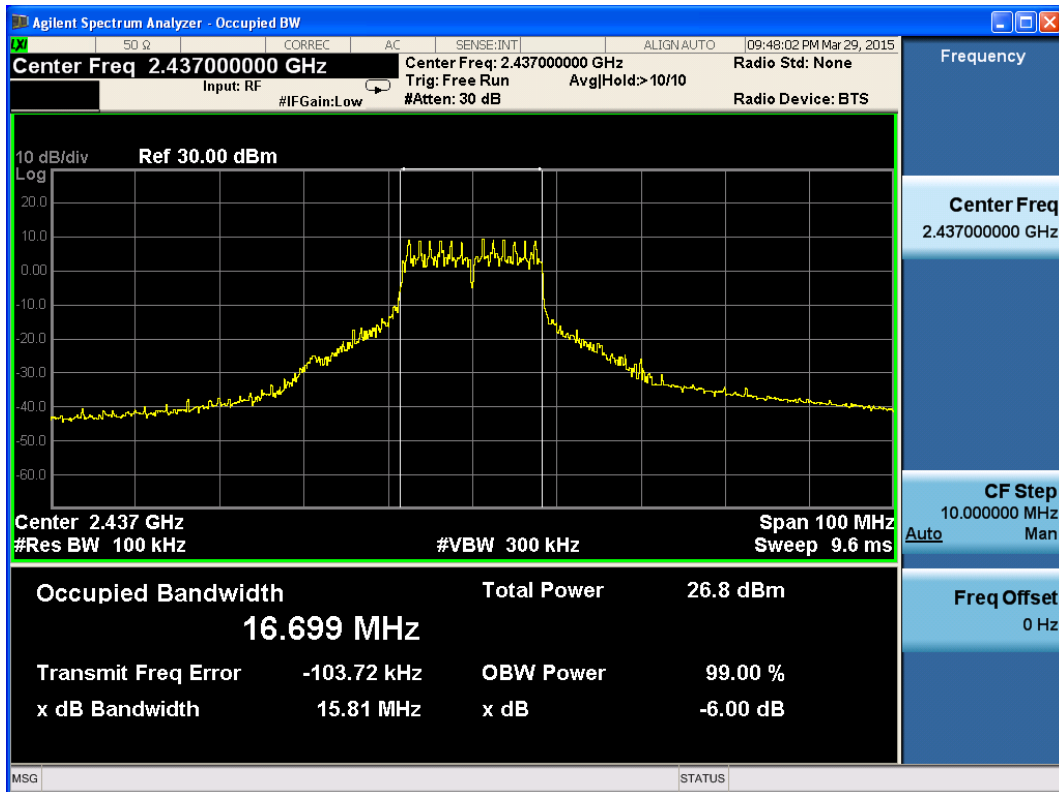

802.11g, Carrier frequency (MHz): 2437

TA Technology (Shanghai) Co., Ltd. Test Report

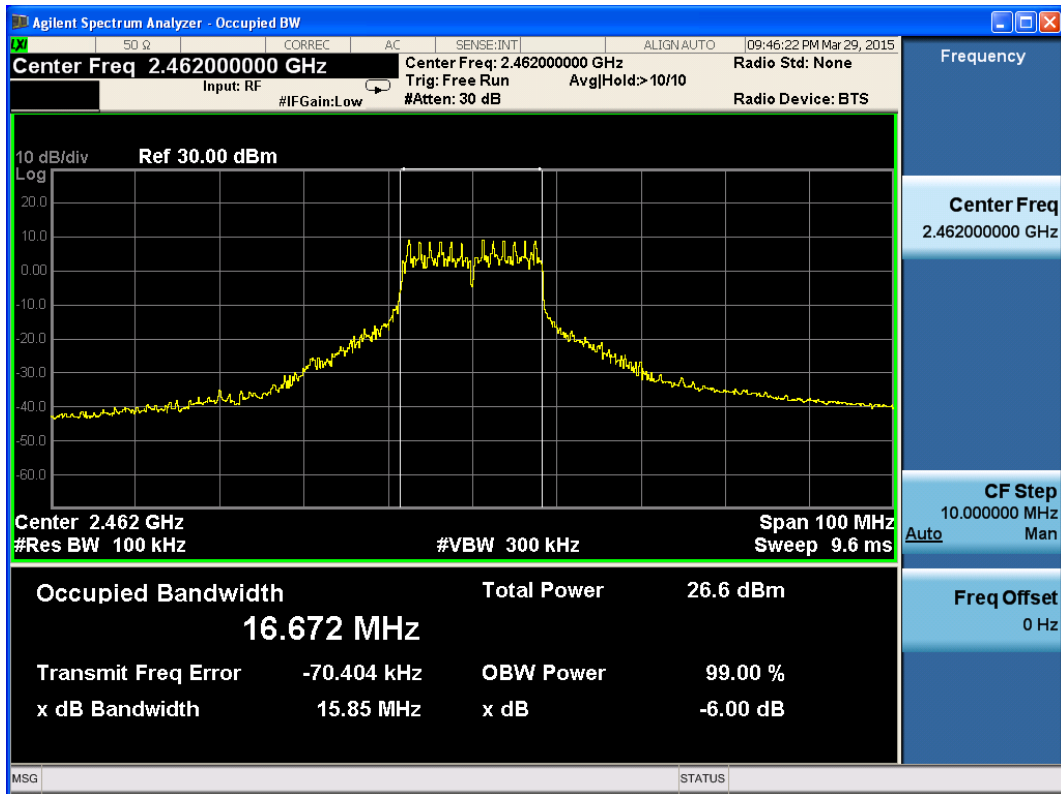

802.11g, Carrier frequency (MHz):2462

802.11n(HT20)

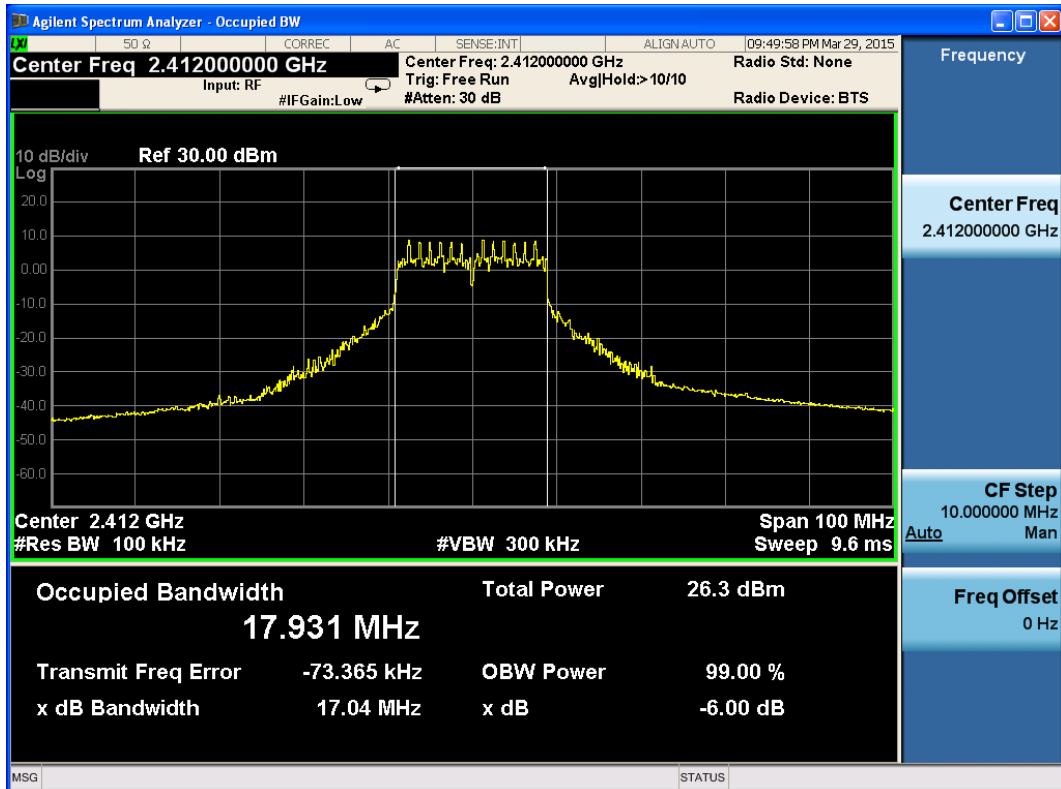

802.11n, Carrier frequency (MHz): 2412

TA Technology (Shanghai) Co., Ltd. Test Report

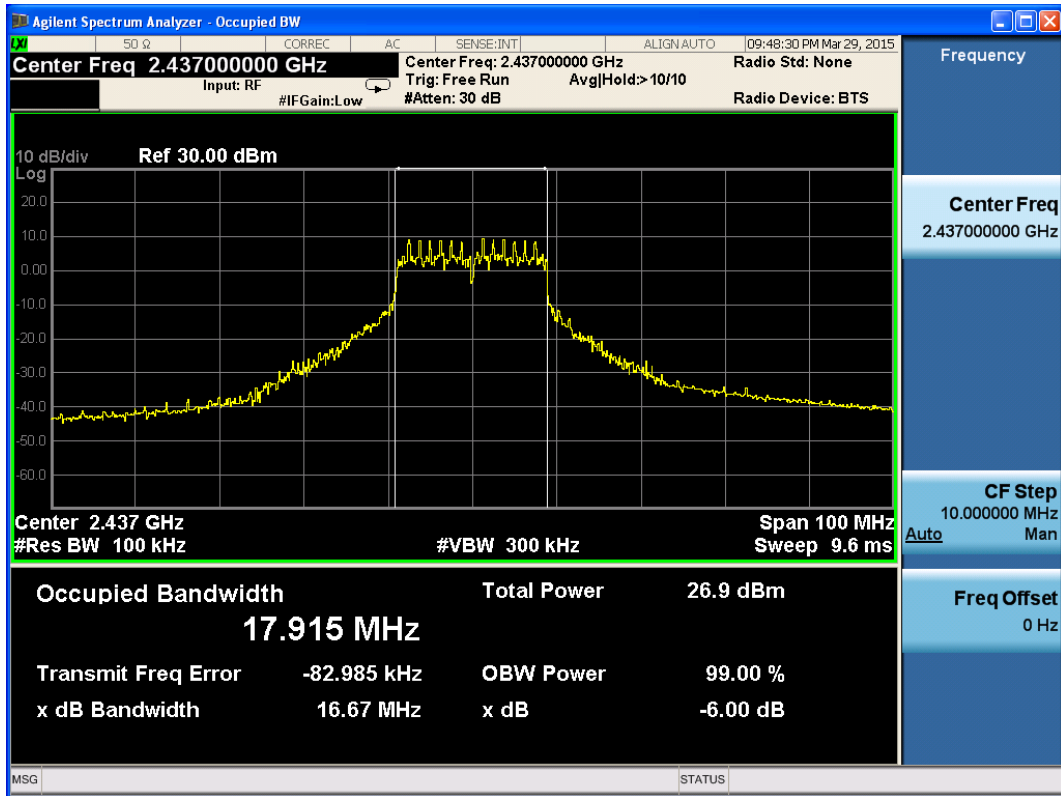

802.11n, Carrier frequency (MHz): 2437

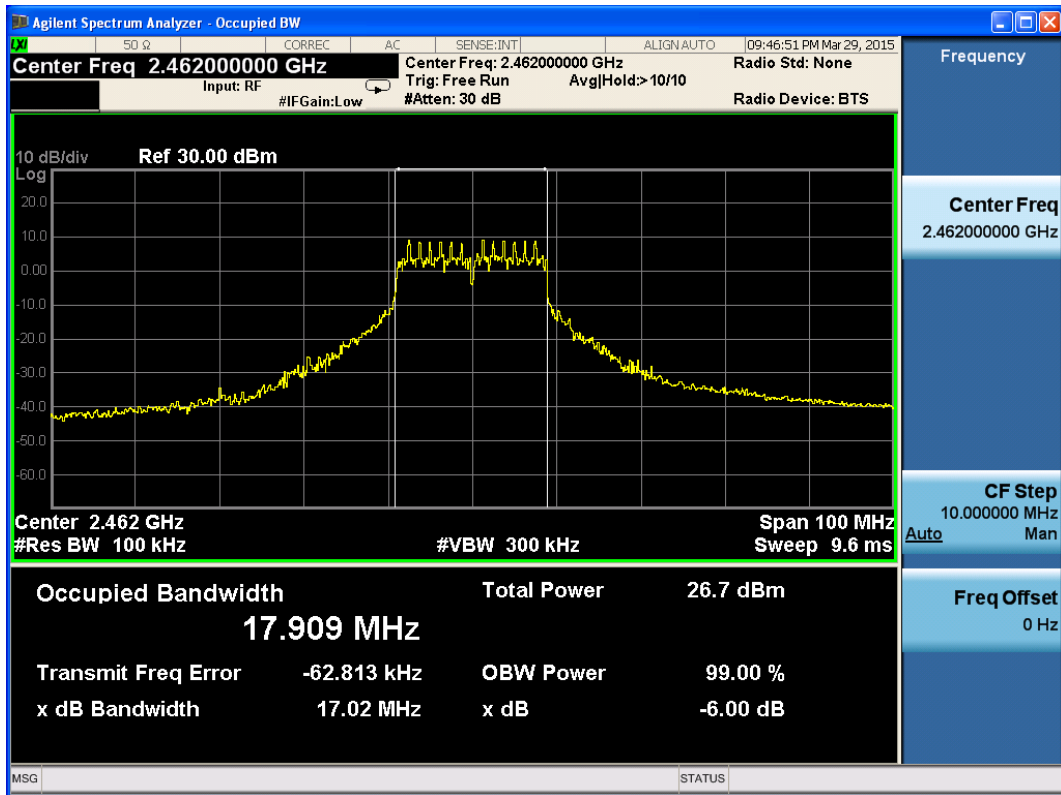

802.11n, Carrier frequency (MHz):2462

2.5. Band Edge Compliance

Ambient condition

Temperature	Relative humidity	Pressure
23°C ~25°C	45%~50%	101.5kPa

Method of Measurement

The EUT was connected to the spectrum analyzer through an external attenuator (20dB) and a known loss cable the band edge of the lowest and highest channels were measured. The peak detector is used and RBW is set to 100kHz and VBW is set to 300kHz on spectrum analyzer. Spectrum analyzer plots are included on the following pages.

Test Setup

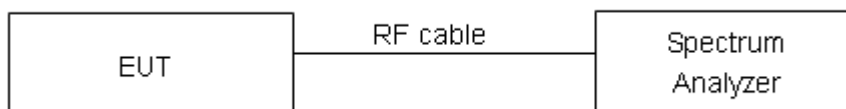

Limits

Rule Part 15.247(d) specifies that “In any 100 kHz bandwidth outside the frequency band in which the spread spectrum or digitally modulated intentional radiator is operating, the radio frequency power that is produced by the intentional radiator shall be at least 20 dB below that in the 100 kHz bandwidth within the band that contains the highest level of the desired power, based on either an RF conducted or a radiated measurement.”

Measurement Uncertainty

The assessed measurement uncertainty to ensure 95% confidence level for the normal distribution is with the coverage factor $k = 1.96$.

Frequency	Uncertainty
2GHz-3GHz	1.407 dB

TA Technology (Shanghai) Co., Ltd. Test Report

Test Results: PASS

802.11b

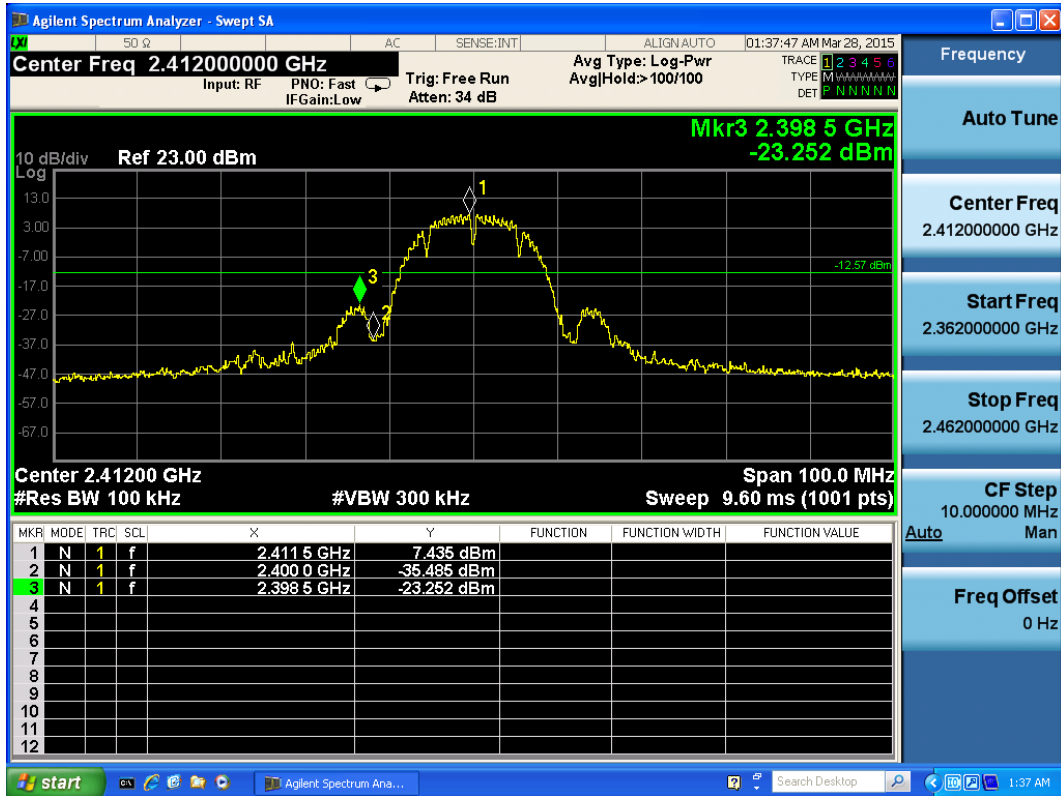

802.11b, Channel No.: 1

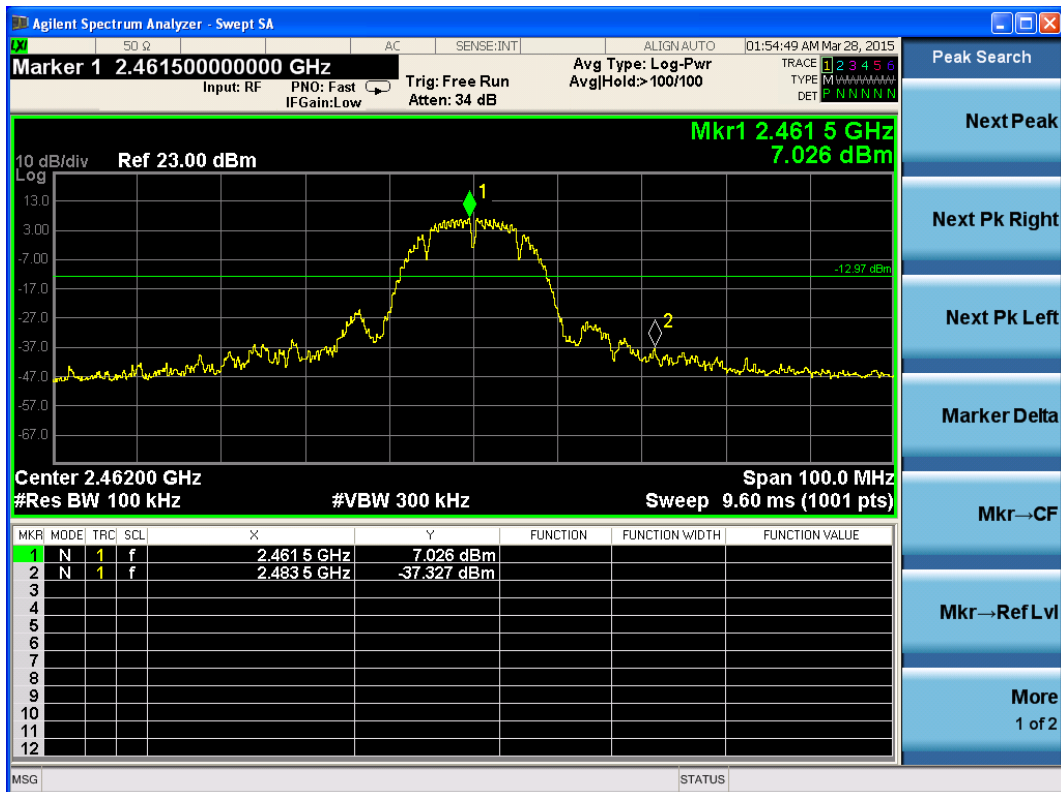

802.11b, Channel No.: 11

TA Technology (Shanghai) Co., Ltd. Test Report

802.11g

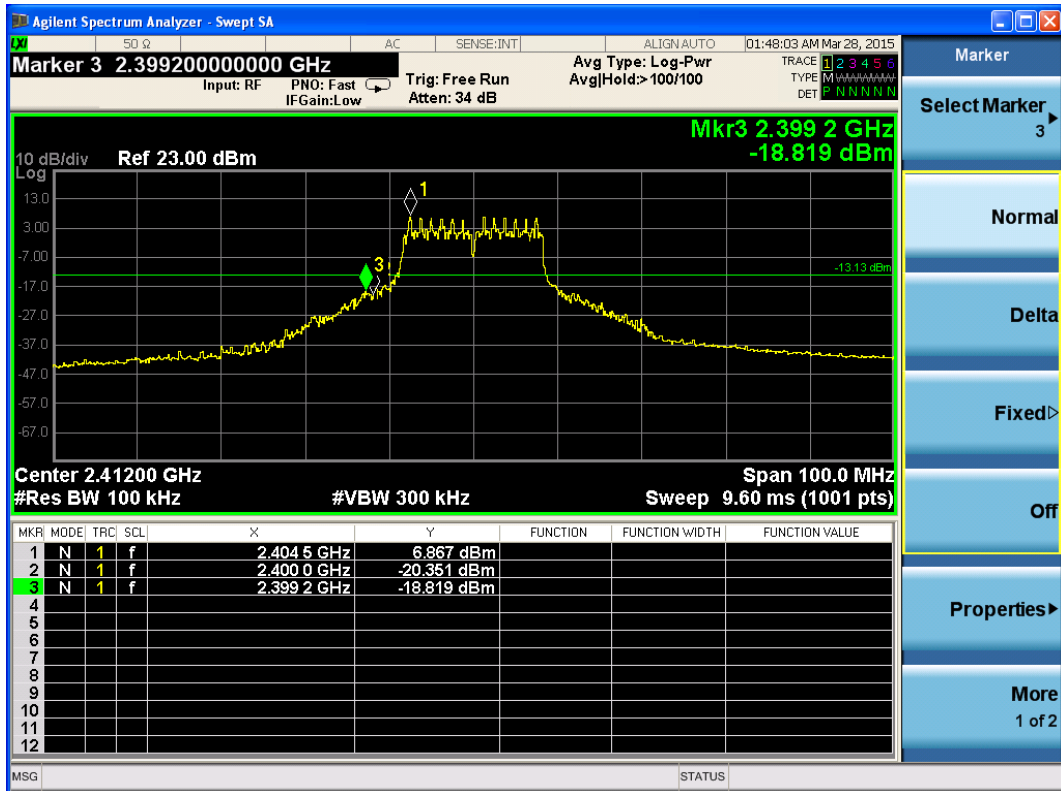

802.11g, Channel No.: 1

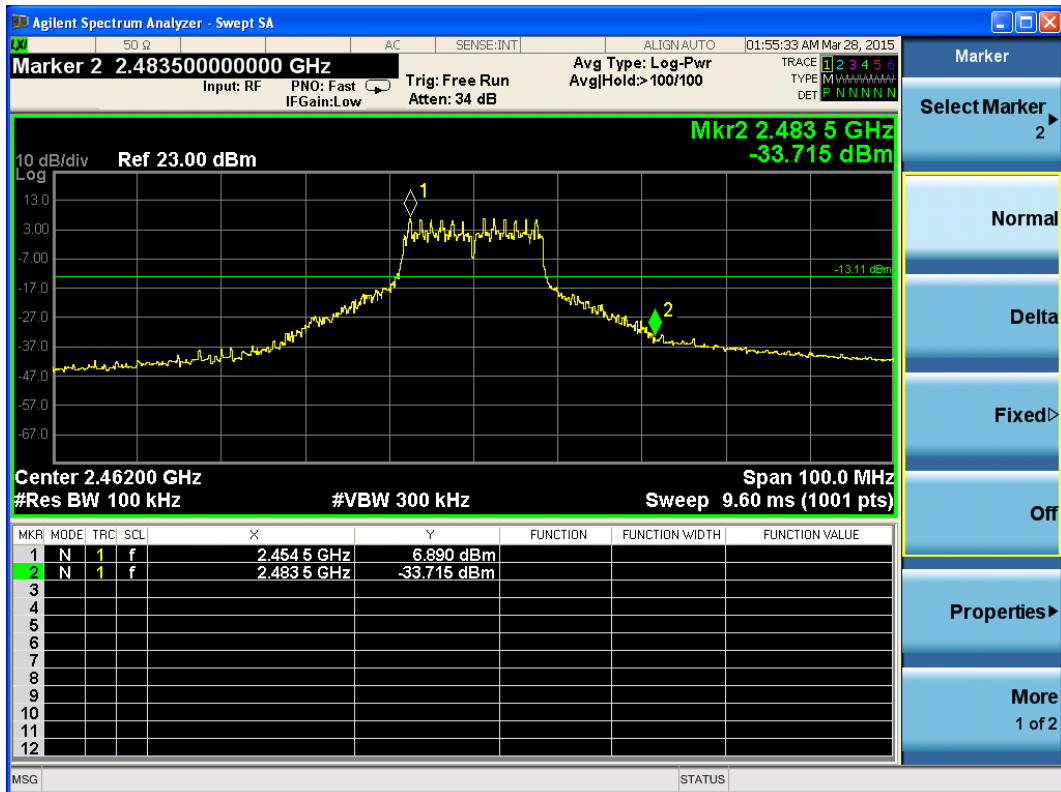

802.11g, Channel No.: 11

TA Technology (Shanghai) Co., Ltd. Test Report

802.11n(HT20)

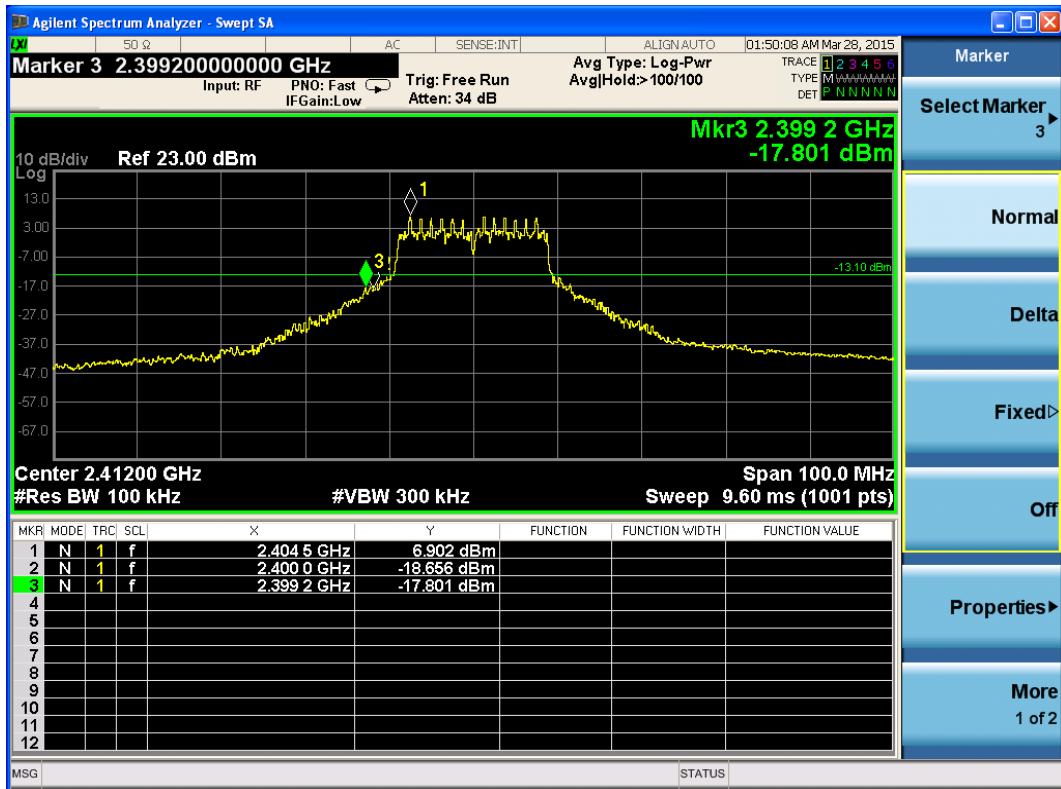

802.11n, Channel No.: 1

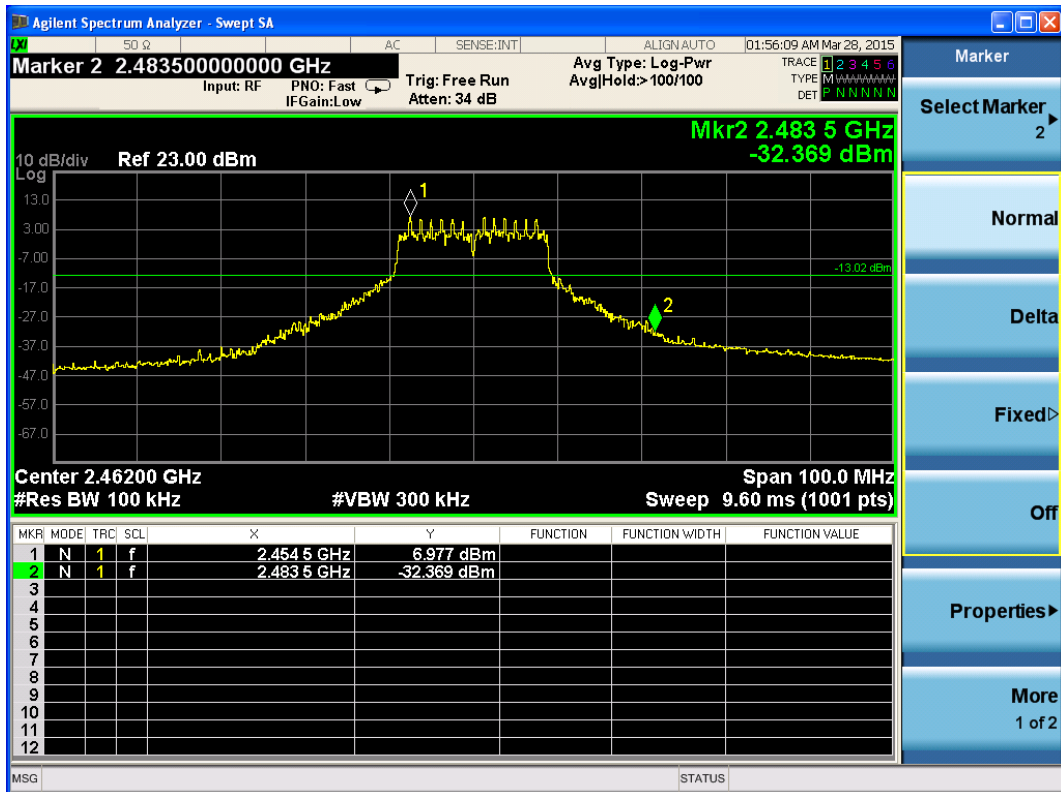

802.11n, Channel No.: 11

2.6. Spurious Radiated Emissions in the restricted band

Ambient condition

Temperature	Relative humidity	Pressure
23°C ~25°C	45%~50%	101.5kPa

The Equipment Under Test (EUT) was set up on a non-conductive table in the semi-anechoic chamber. The test was performed at the distance of 3 m between the EUT and the receiving antenna. The turntable shall be rotated from 0 to 360 degrees for detecting the maximum of radiated spurious signal level. The measurements shall be repeated with orthogonal polarization of the test antenna. RBW is set to 100kHz. The data of cable loss and antenna factor has been calibrated in full testing frequency range before the testing. Sweep the whole frequency band through the range from 9kHz to the 10th harmonic of the carrier, and the emissions less than 20 dB below the permissible value are reported.

Set the spectrum analyzer in the following:

- (a) PEAK: RBW=VBW=1MHz / Sweep=AUTO
- (b) AVERAGE: RBW=1MHz / VBW=10Hz / Sweep=AUTO

This setting method can refer to **KDB 558074**.

The field strength of spurious emission was measured in the following position: EUT stand-up position (Z axis), lie-down position (X, Y axis). The worst emission was found in lie-down position (X axis) and the antenna is vertical.

The test is in transmitting mode.

TA Technology (Shanghai) Co., Ltd. Test Report

Test setup

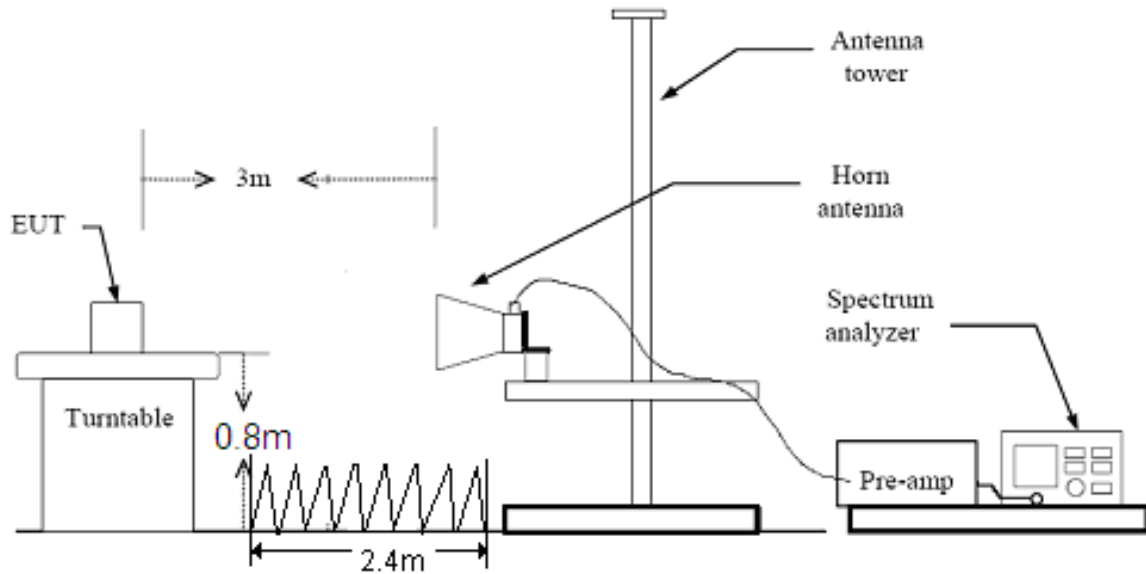

Note: Area side: 2.4m X 3.6m

Limits

Spurious Radiated Emissions are permitted in any of the frequency bands listed below:

MHz	MHz	MHz	GHz
0.090 - 0.110	16.42 - 16.423	399.9 - 410	4.5 - 5.15
¹ 0.495 - 0.505	16.69475 - 16.69525	608 - 614	5.35 - 5.46
2.1735 - 2.1905	16.80425 - 16.80475	960 - 1240	7.25 - 7.75
4.125 - 4.128	25.5 - 25.67	1300 - 1427	8.025 - 8.5
4.17725 - 4.17775	37.5 - 38.25	1435 - 1626.5	9.0 - 9.2
4.20725 - 4.20775	73 - 74.6	1645.5 - 1646.5	9.3 - 9.5
6.215 - 6.218	74.8 - 75.2	1660 - 1710	10.6 - 12.7
6.26775 - 6.26825	108 - 121.94	1718.8 - 1722.2	13.25 - 13.4
6.31175 - 6.31225	123 - 138	2200 - 2300	14.47 - 14.5
8.291 - 8.294	149.9 - 150.05	2310 - 2390	15.35 - 16.2
8.362 - 8.366	156.52475 - 156.52525	2483.5 - 2500	17.7 - 21.4
8.37625 - 8.38675	156.7 - 156.9	2690 - 2900	22.01 - 23.12
8.41425 - 8.41475	162.0125 - 167.17	3260 - 3267	23.6 - 24.0
12.29 - 12.293	167.72 - 173.2	3332 - 3339	31.2 - 31.8
12.51975 - 12.52025	240 - 285	3345.8 - 3358	36.43 - 36.5
12.57675 - 12.57725	322 - 335.4	3600 - 4400	(²)
13.36 - 13.41			

Limit in restricted band

Frequency of emission (MHz)	Field strength(uV/m)	Field strength(dBuV/m)
0.009-0.490	2400/F(kHz)	/
0.490-1.705	24000/F(kHz)	/

TA Technology (Shanghai) Co., Ltd.
Test Report

Report No.: RXA1503-0042RF01R1

Page 23 of 103

1.705–30.0	30	/
30-88	100	40
88-216	150	43.5
216-960	200	46
Above960	500	54

§15.35(b)

There is also a limit on the radio frequency emissions, as measured using instrumentation with a peak detector function, corresponding to 20 dB above the maximum permitted average limit.

Peak Limit=74 dBuV/m

Average Limit=54 dBuV/m

Measurement Uncertainty

The assessed measurement uncertainty to ensure 95% confidence level for the normal distribution is with the coverage factor $k = 1.96$, $U = 3.55$ dB.

TA Technology (Shanghai) Co., Ltd. Test Report

Report No.: RXA1503-0042RF01R1

Page 24 of 103

Test Results: PASS
802.11b-Channel 1:

Peak

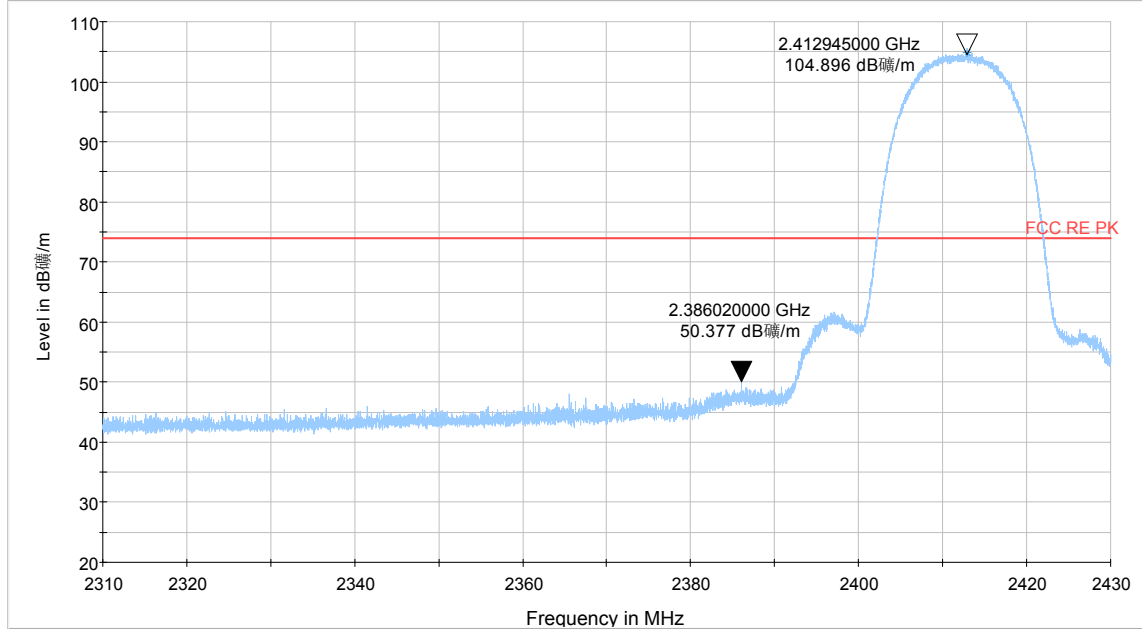

— FCC RE PK — Preview Result 1-PK+ * Data Reduction Result 1 [2]-PK+

Note: The signal beyond the limit is carrier
Channel 1

Average

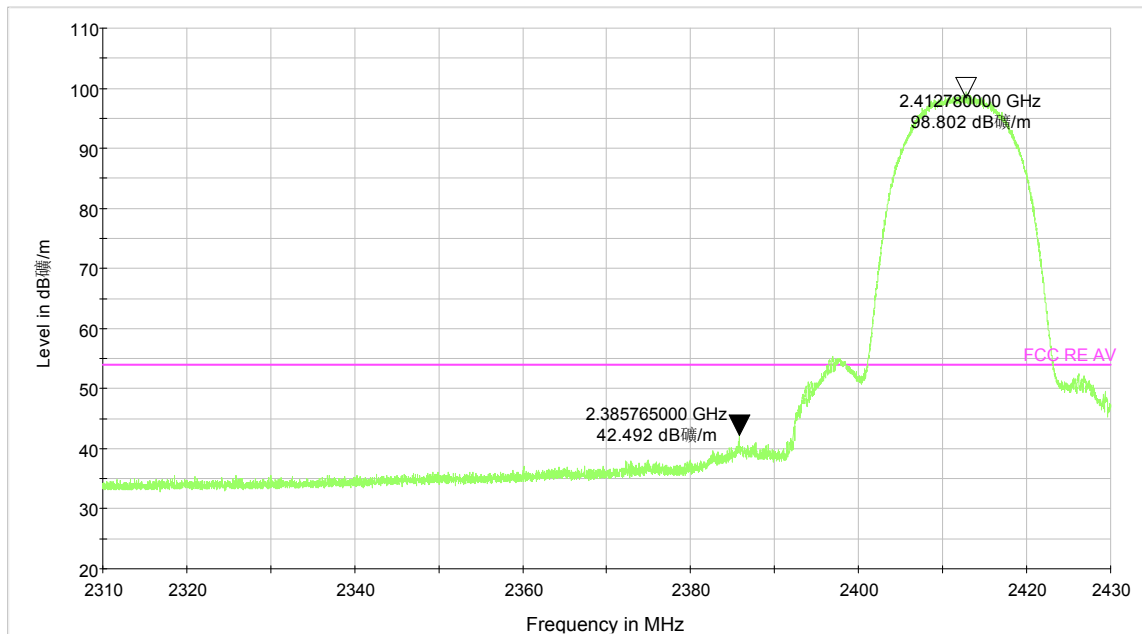

— FCC RE AV — Preview Result 2-AVG * Data Reduction Result 2 [2]-AVG

Note: The signal beyond the limit is carrier
Channel 1

802.11b-Channel 11:

Peak

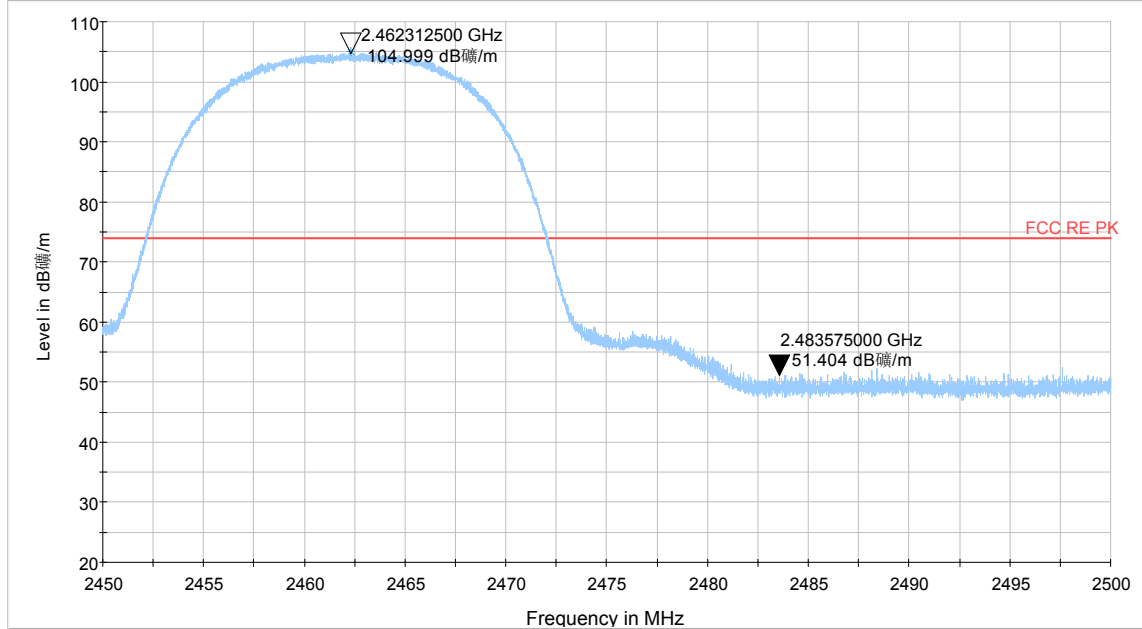

— FCC RE PK — Preview Result 1-PK+ * Data Reduction Result 1 [2]-PK+

Note: The signal beyond the limit is carrier
Channel 11

Average

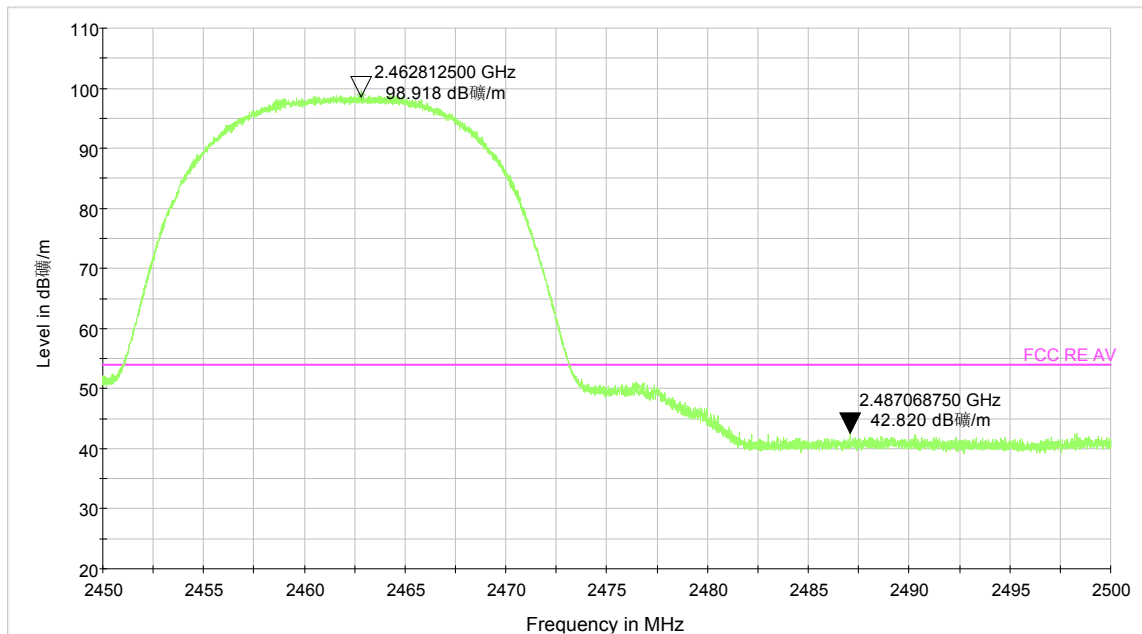

— FCC RE AV — Preview Result 2-AVG * Data Reduction Result 2 [2]-AVG

Note: The signal beyond the limit is carrier
Channel 11

802.11g-Channel 1:

Peak

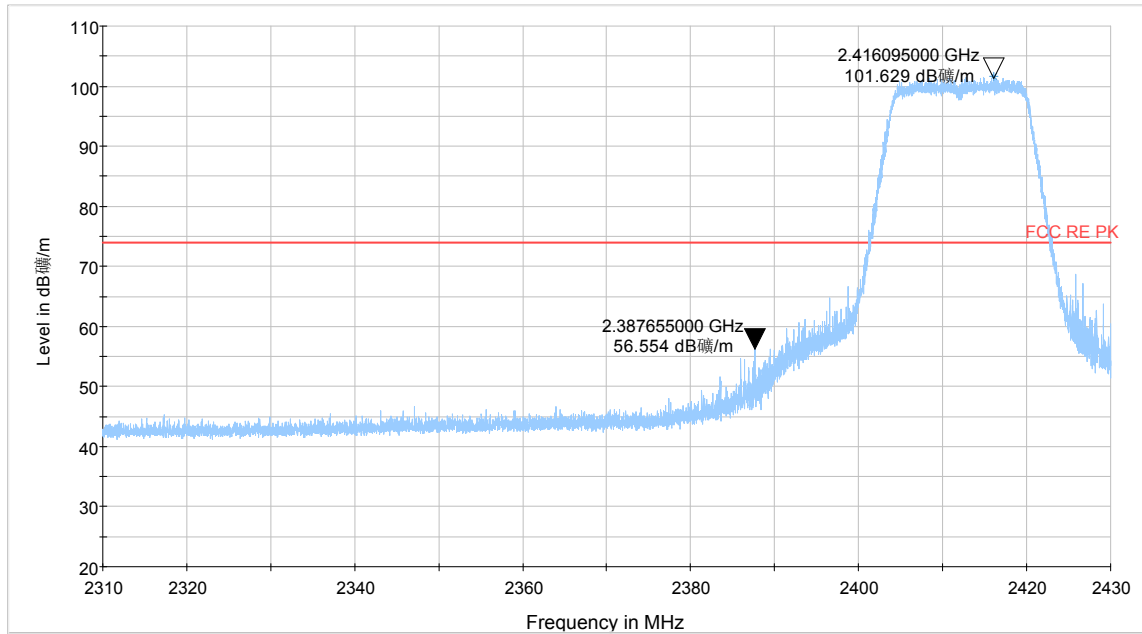

— FCC RE PK — Preview Result 1-PK+ * Data Reduction Result 1 [2]-PK+

Note: The signal beyond the limit is carrier
Channel 1

Average

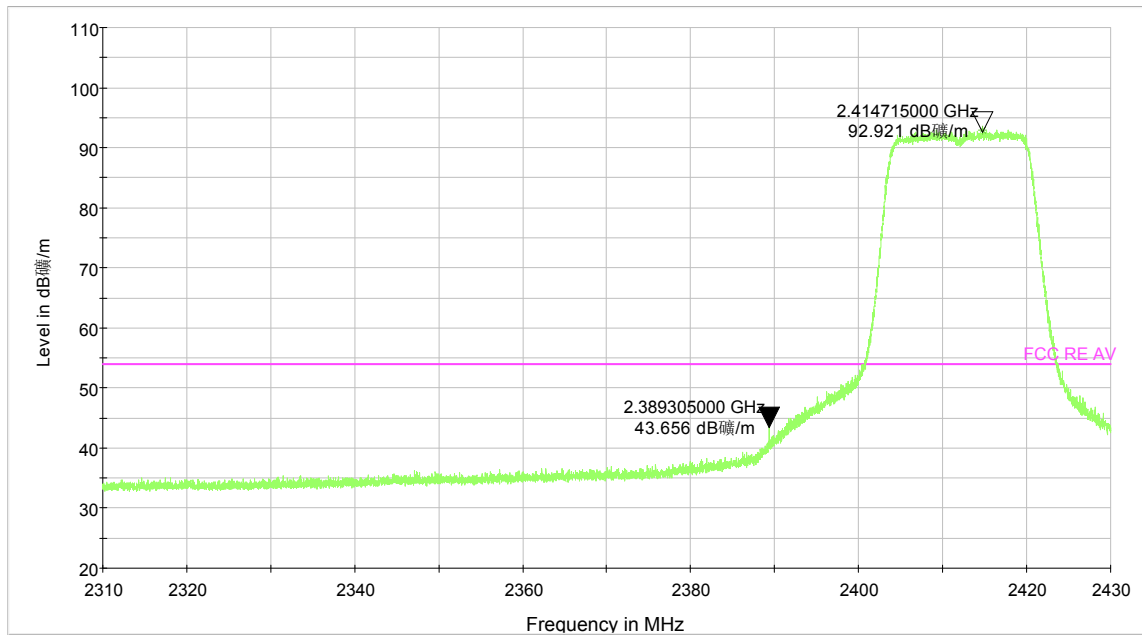

— FCC RE AV — Preview Result 2-AVG * Data Reduction Result 2 [2]-AVG

Note: The signal beyond the limit is carrier
Channel 1

802.11g-Channel 11:

Peak

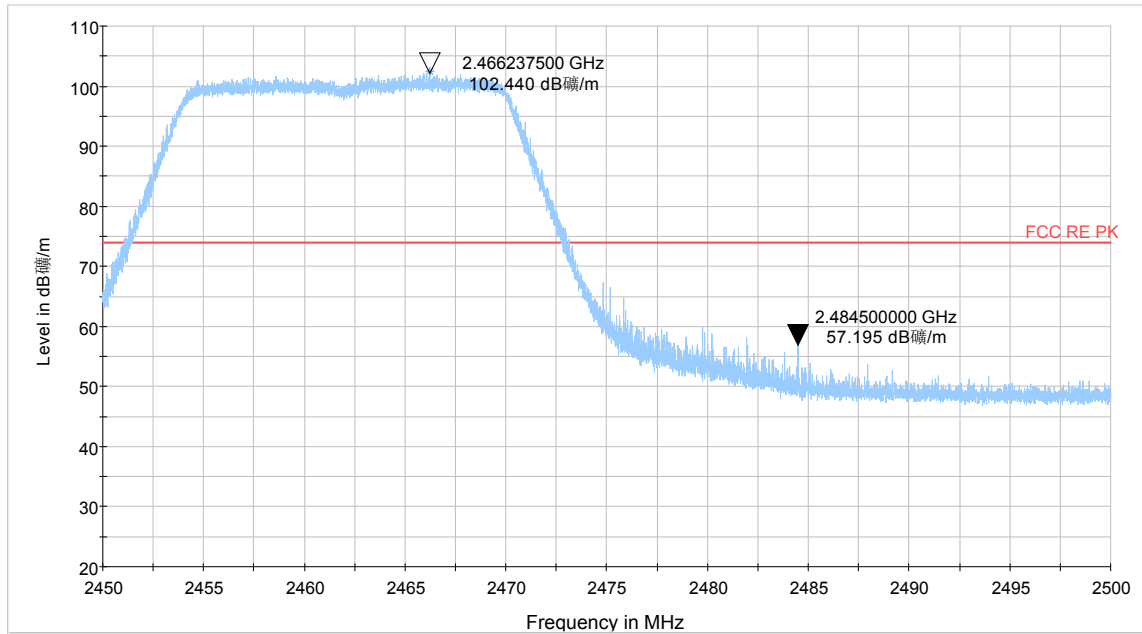

— FCC RE PK — Preview Result 1-PK+ * Data Reduction Result 1 [2]-PK+

Note: The signal beyond the limit is carrier
Channel 11

Average

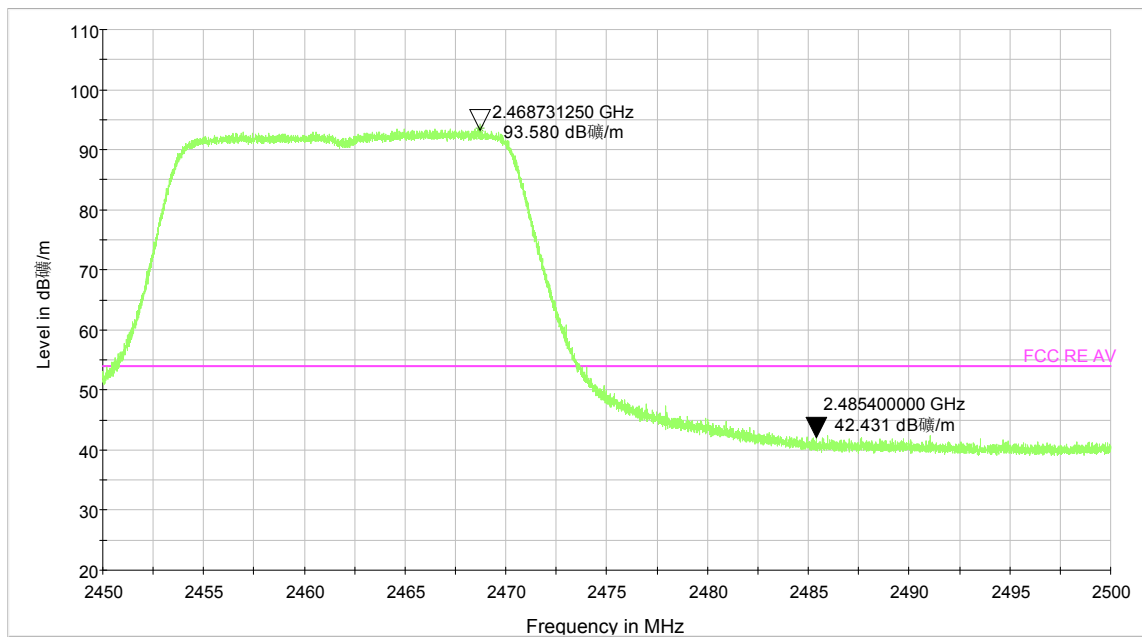

— FCC RE AV — Preview Result 2-AVG * Data Reduction Result 2 [2]-AVG

Note: The signal beyond the limit is carrier
Channel 11

802.11n-Channel 1(HT20):

Peak

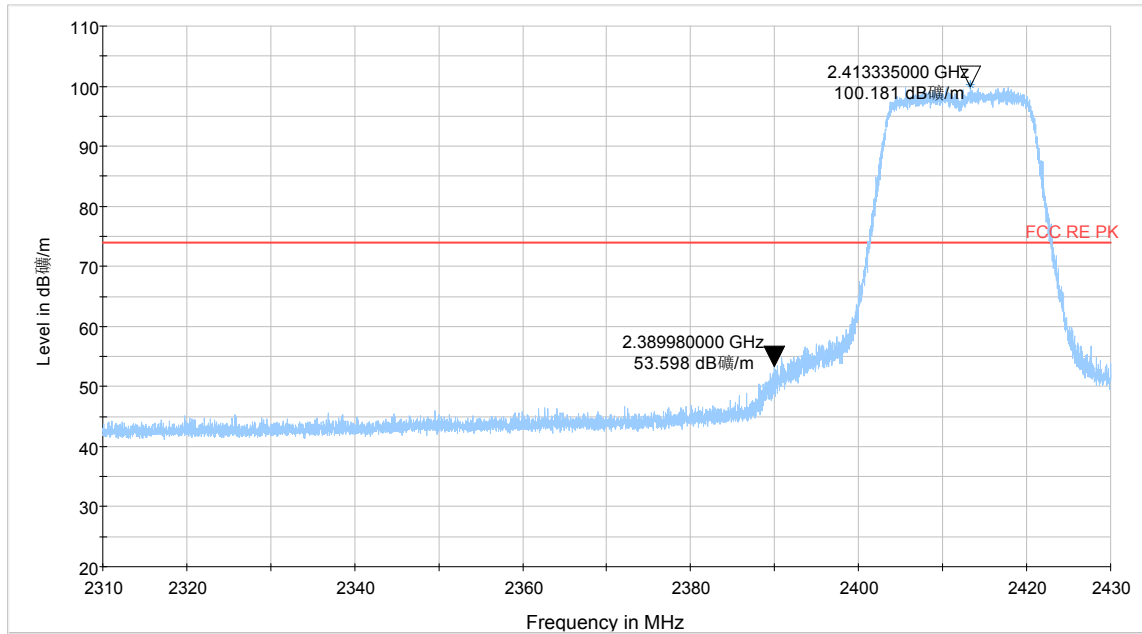

Note: The signal beyond the limit is carrier
Channel 1

Average

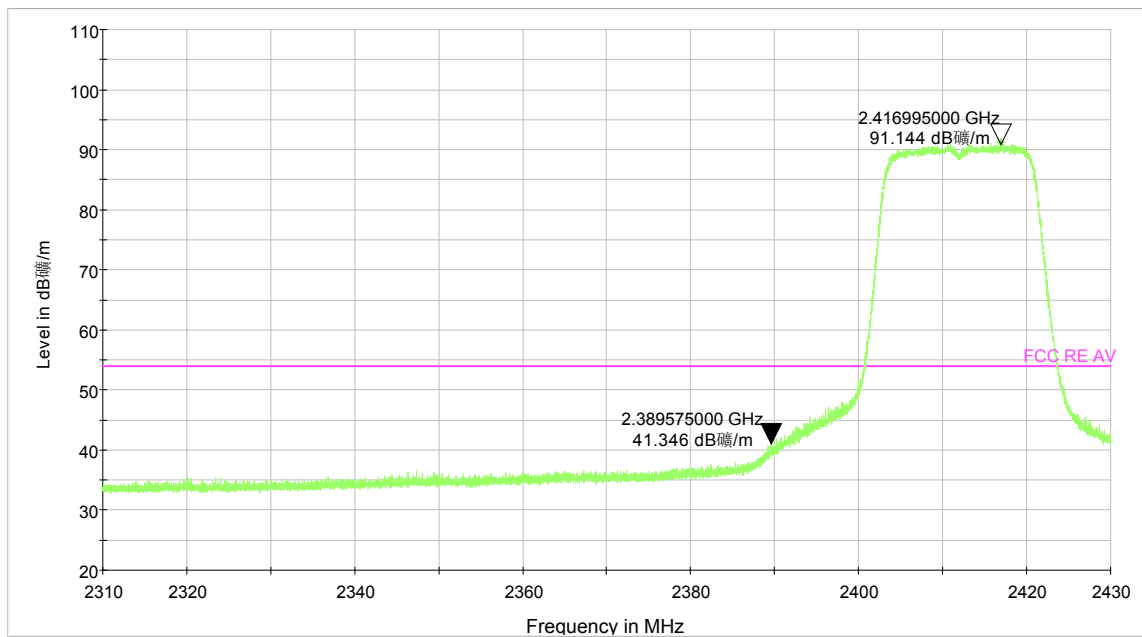

Note: The signal beyond the limit is carrier
Channel 1

802.11n-Channel 11(HT20):

Peak

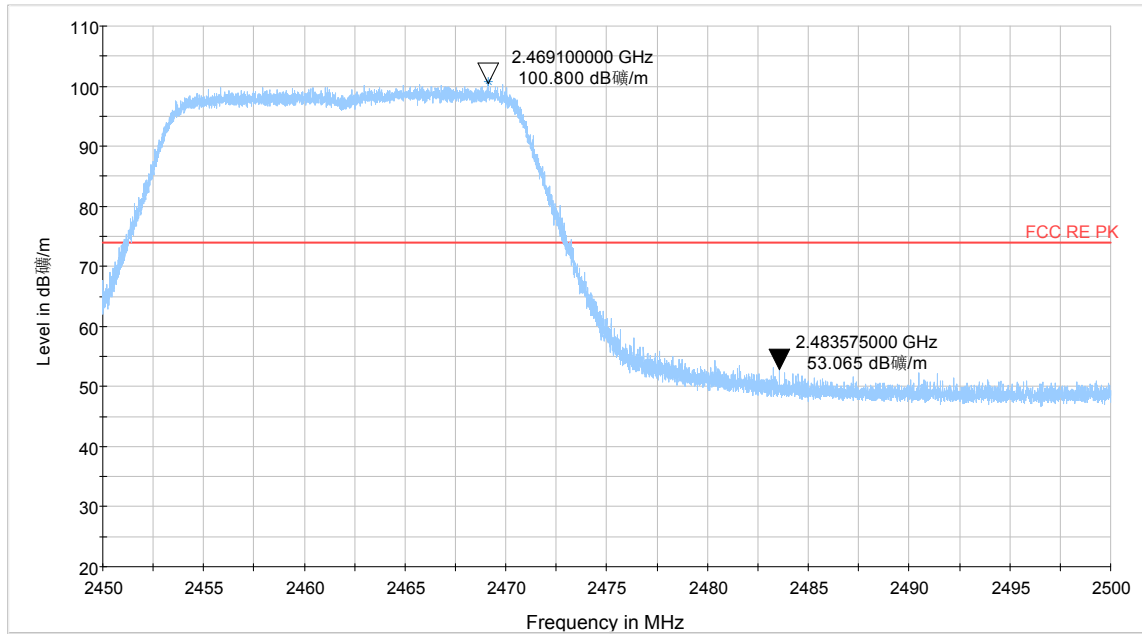

— FCC RE PK — Preview Result 1-PK+ * Data Reduction Result 1 [2]-PK+

Note: The signal beyond the limit is carrier
Channel 11

Average

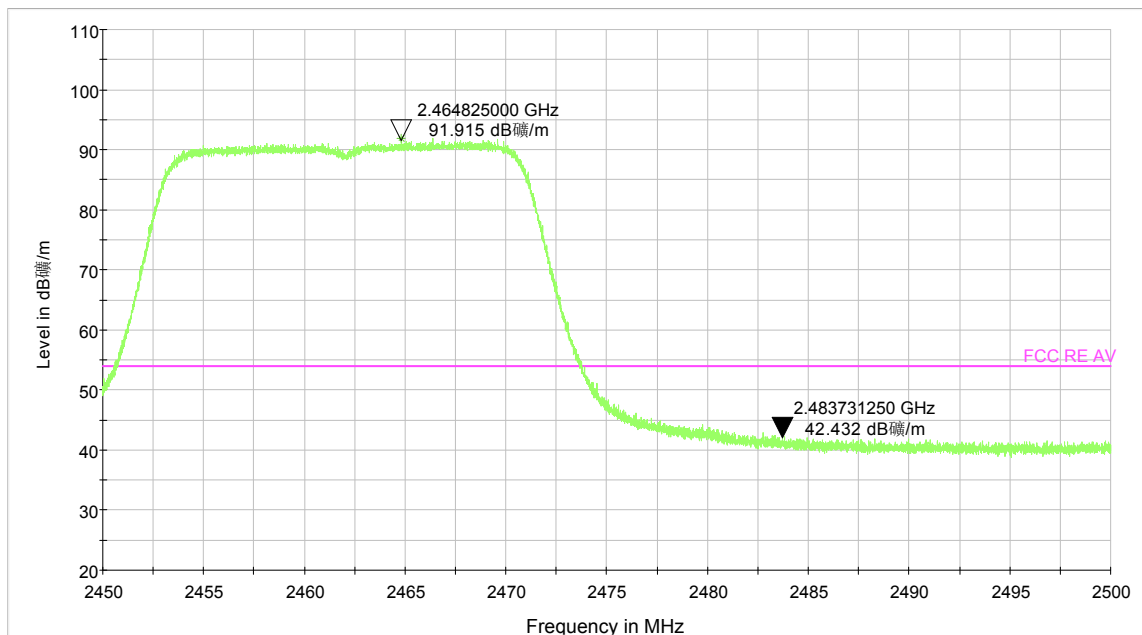

— FCC RE AV — Preview Result 2-AVG * Data Reduction Result 2 [2]-AVG

Note: The signal beyond the limit is carrier
Channel 11

2.7. Power Spectral Density

Ambient condition

Temperature	Relative humidity	Pressure
23°C ~25°C	45%~50%	101.5kPa

Method of Measurement

The EUT was connected to the spectrum analyzer through an external attenuator (20dB) and a known loss cable. RBW is set to 3 kHz and VBW is set to 10 kHz on spectrum analyzer. Set the span to at least 1.5 times the DTS channel bandwidth. Sweep time = auto couple. Trace mode = max hold. The peak power spectral density is recorded.

Test setup

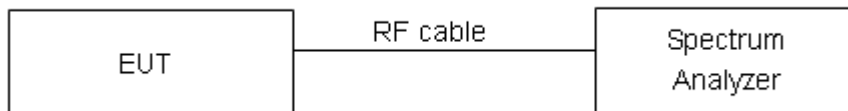

Limits

Rule Part 15.247(e) specifies that " For digitally modulated systems, the power spectral density conducted from the intentional radiator to the antenna shall not be greater than 8 dBm in any 3 kHz band during any time interval of continuous transmission. "

Limits	≤ 8 dBm / 3kHz
--------	----------------

Measurement Uncertainty

The assessed measurement uncertainty to ensure 95% confidence level for the normal distribution is with the coverage factor $k = 2$, $U = 0.75\text{dB}$.

TA Technology (Shanghai) Co., Ltd. Test Report

Report No.: RXA1503-0042RF01R1

Page 31 of 103

Test Results:

Network Standards	Channel Number	Power Spectral Density dBm / 3kHz	Conclusion
802.11b	1	6.281	PASS
	6	6.399	PASS
	11	6.563	PASS
802.11g	1	0.015	PASS
	6	0.190	PASS
	11	0.101	PASS
802.11n HT20	1	0.222	PASS
	6	0.796	PASS
	11	0.726	PASS

802.11b

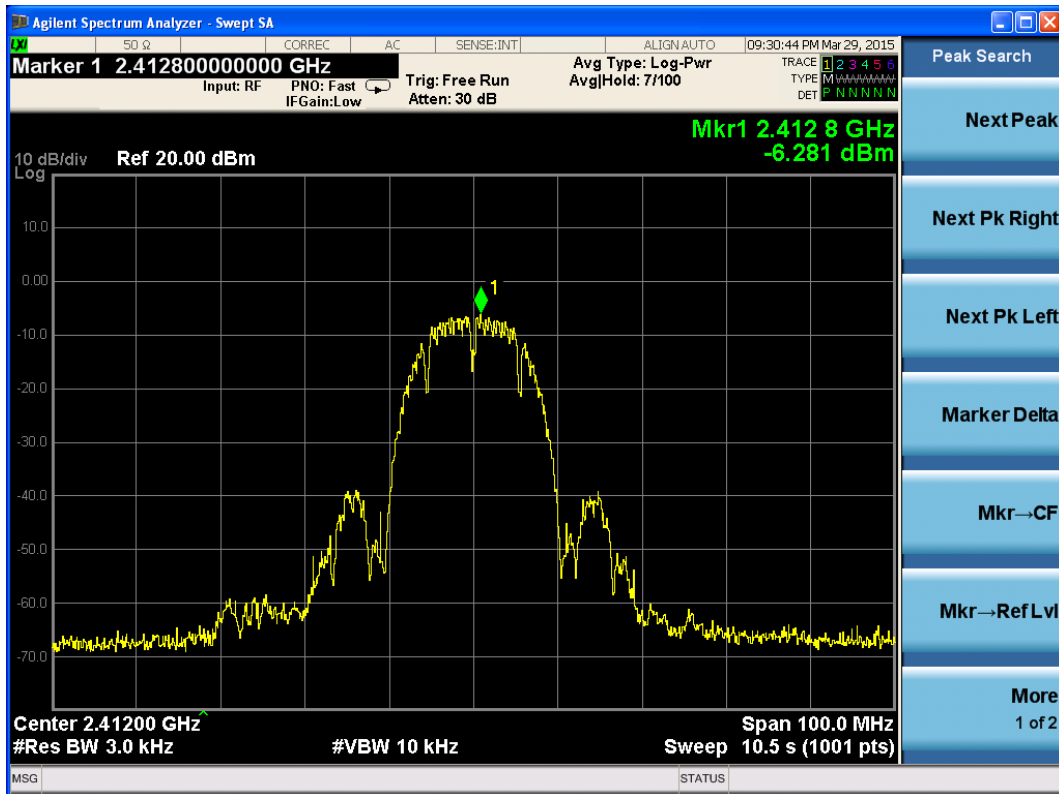

802.11b, Channel No.: 1

TA Technology (Shanghai) Co., Ltd. Test Report

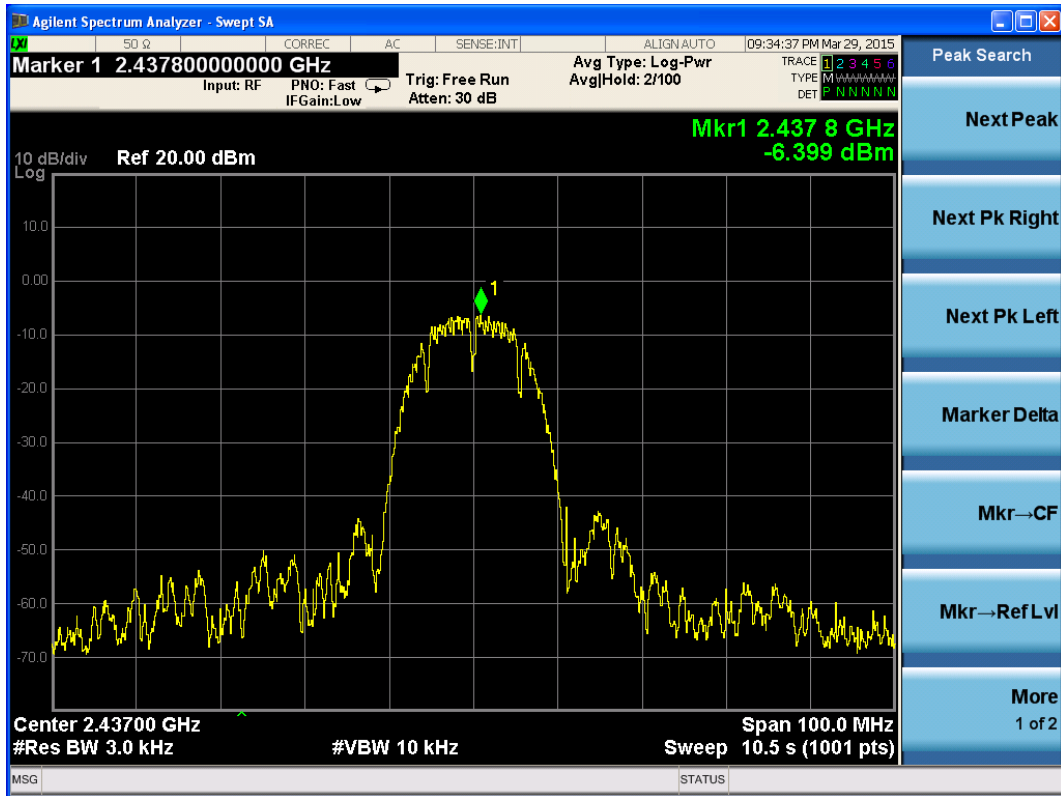

802.11b, Channel No.: 6

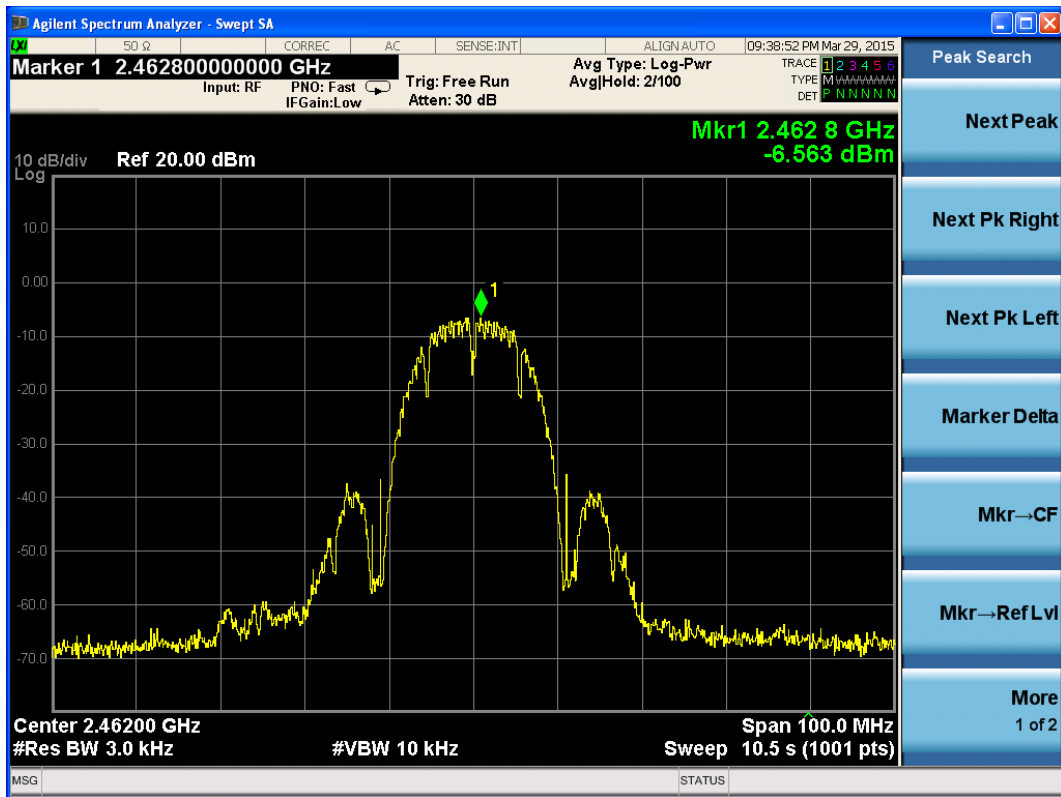

802.11b, Channel No.: 11

TA Technology (Shanghai) Co., Ltd. Test Report

802.11g

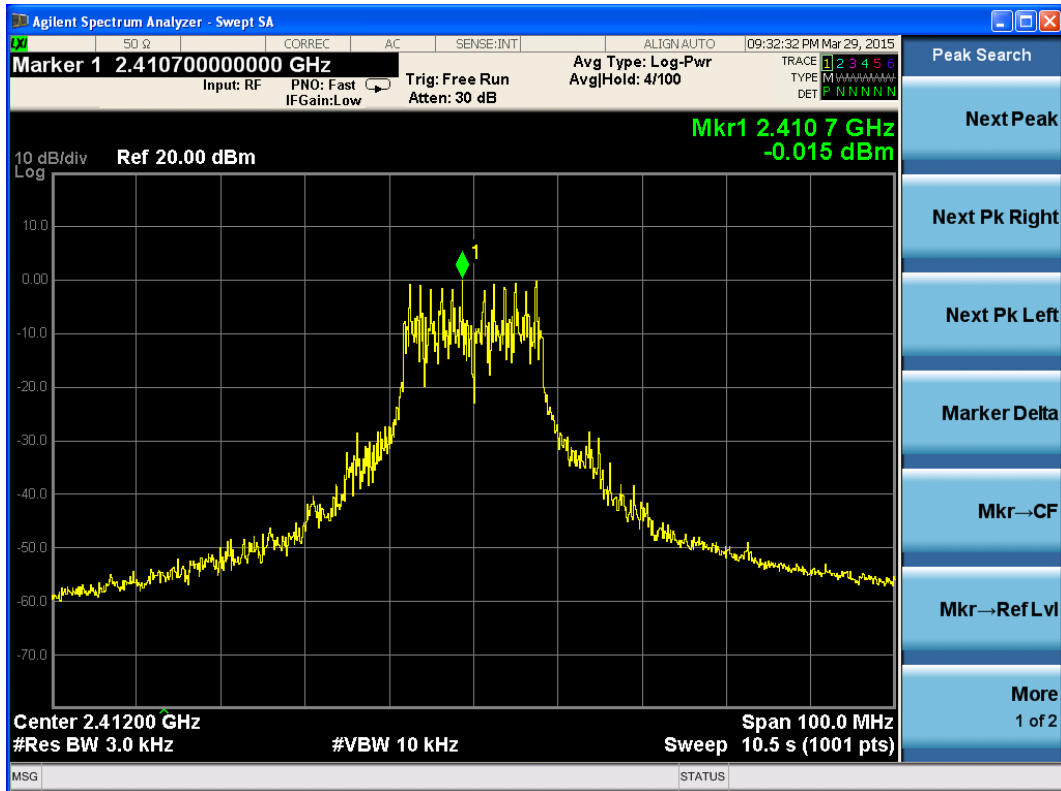

802.11g, Channel No.: 1

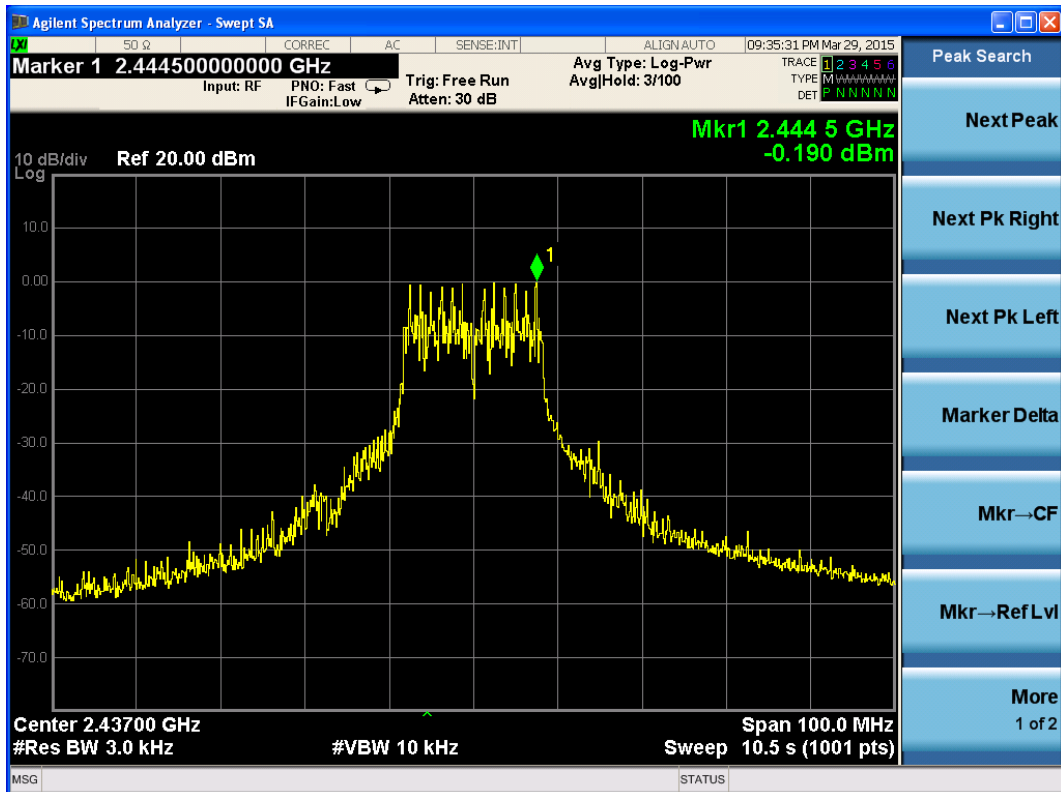

802.11g, Channel No.: 6

TA Technology (Shanghai) Co., Ltd. Test Report

Report No.: RXA1503-0042RF01R1

Page 34 of 103

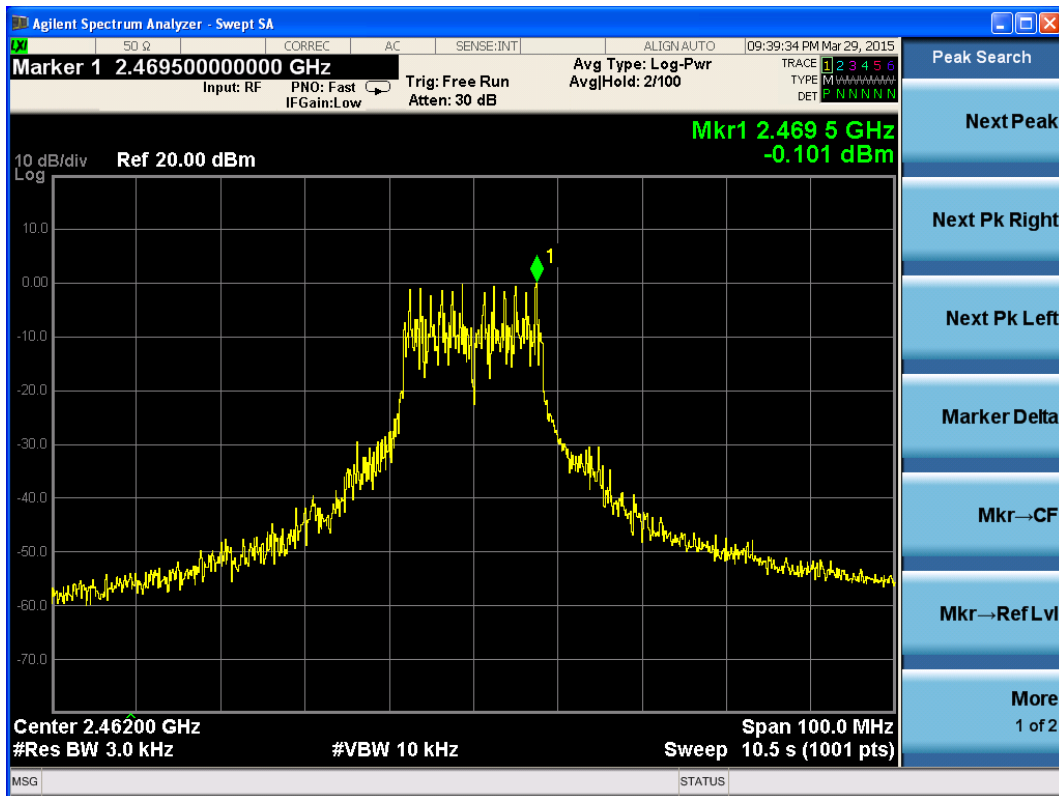

802.11g, Channel No.: 11

802.11n(HT20)

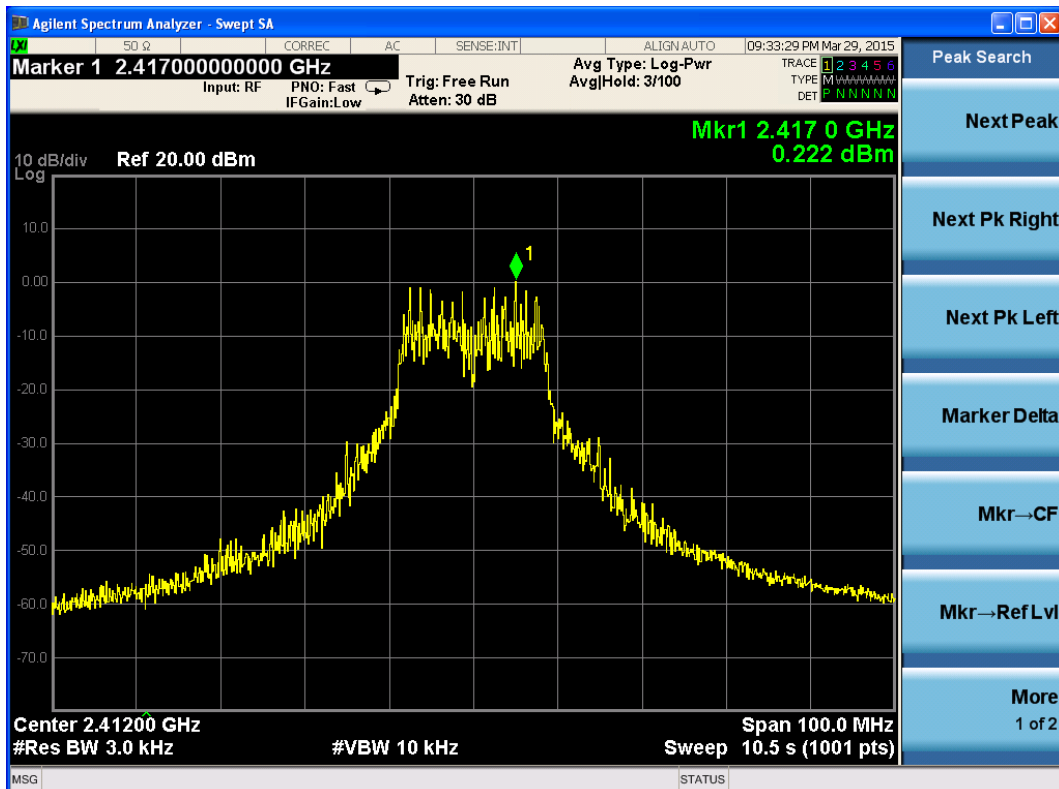

802.11n, Channel No.: 1

TA Technology (Shanghai) Co., Ltd. Test Report

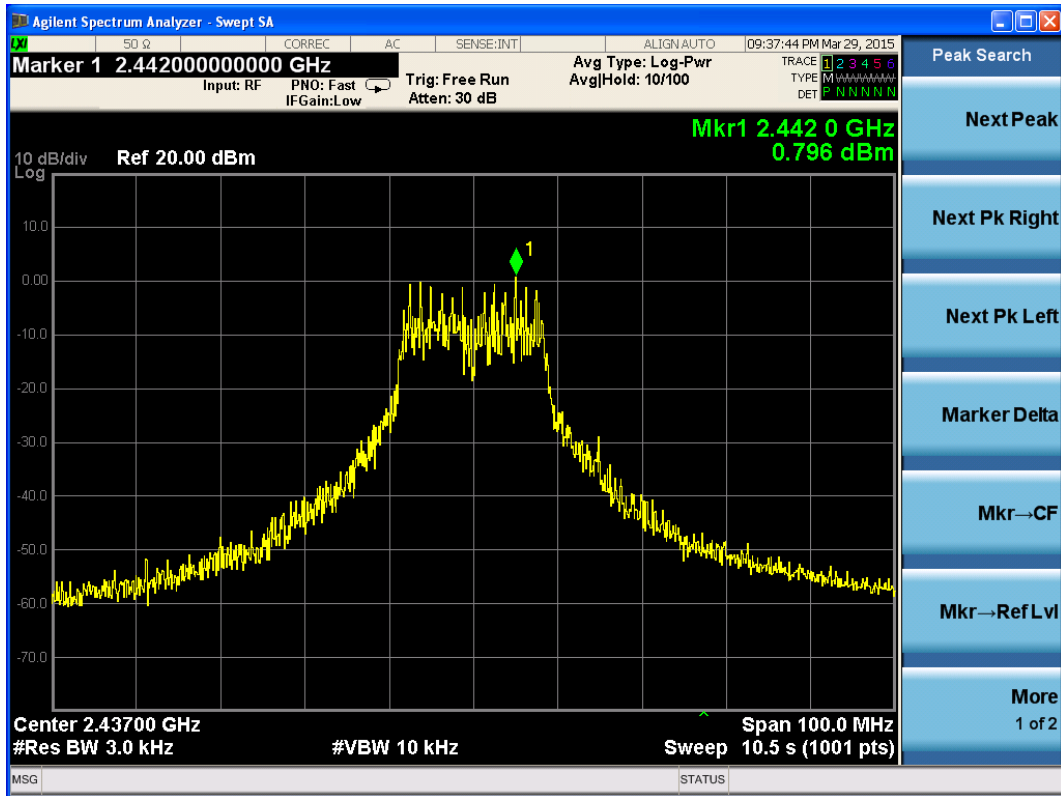

802.11n, Channel No.: 6

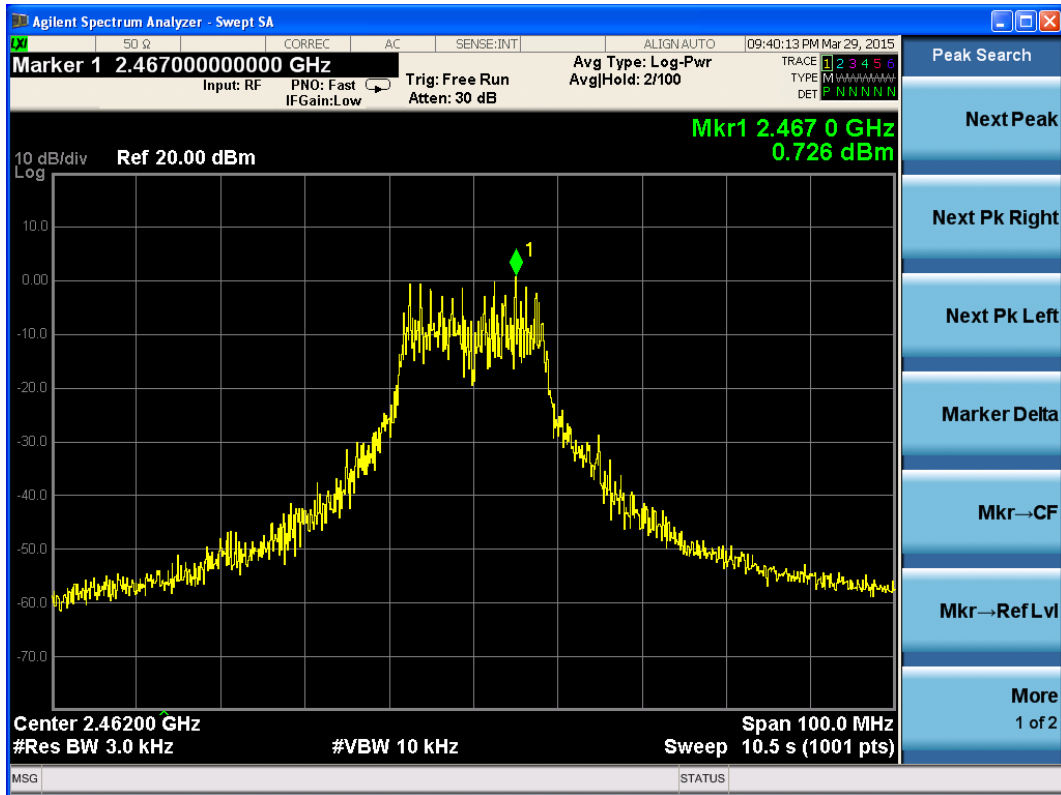

802.11n, Channel No.: 11

TA Technology (Shanghai) Co., Ltd.

Test Report

2.8. Spurious RF Conducted Emissions

Ambient condition

Temperature	Relative humidity	Pressure
23°C ~25°C	45%~50%	101.5kPa

Method of Measurement

The EUT was connected to the spectrum analyzer and WIFI test set via a power splitter with a known loss. The spectrum analyzer scans from 30MHz to the 10th harmonic of the carrier. The peak detector is used. RBW and VBW are set to 100 kHz, Sweep is set to ATUO.

The test is in transmitting mode.

Test setup



Limits

Rule Part 15.247(d) pacifies that “In any 100 kHz bandwidth outside the frequency band in which the spread spectrum intentional radiator is operating, the radio frequency power that is produced by the intentional radiator shall be at least 20 dB below that in the 100 kHz bandwidth within the band that contains the highest level of the desired power.”

Network Standards	Carrier frequency (MHz)	Reference value (dBm)	Limit
802.11b	2412	21.67	1.67
	2437	22.08	2.08
	2462	22.23	2.23
802.11g	2412	21.57	1.57
	2437	21.17	1.17
	2462	21.39	1.39
802.11n HT20	2412	21.68	1.68
	2437	21.89	1.89
	2462	22.04	2.04

TA Technology (Shanghai) Co., Ltd.
Test Report

Report No.: RXA1503-0042RF01R1

Page 37 of 103

Measurement Uncertainty

The assessed measurement uncertainty to ensure 95% confidence level for the normal distribution is with the coverage factor $k = 1.96$.

Frequency	Uncertainty
100kHz-2GHz	0.684 dB
2GHz-26.5GHz	1.407 dB

TA Technology (Shanghai) Co., Ltd. Test Report

Report No.: RXA1503-0042RF01R1

Page 38 of 103

Test Results:

802.11b CH1

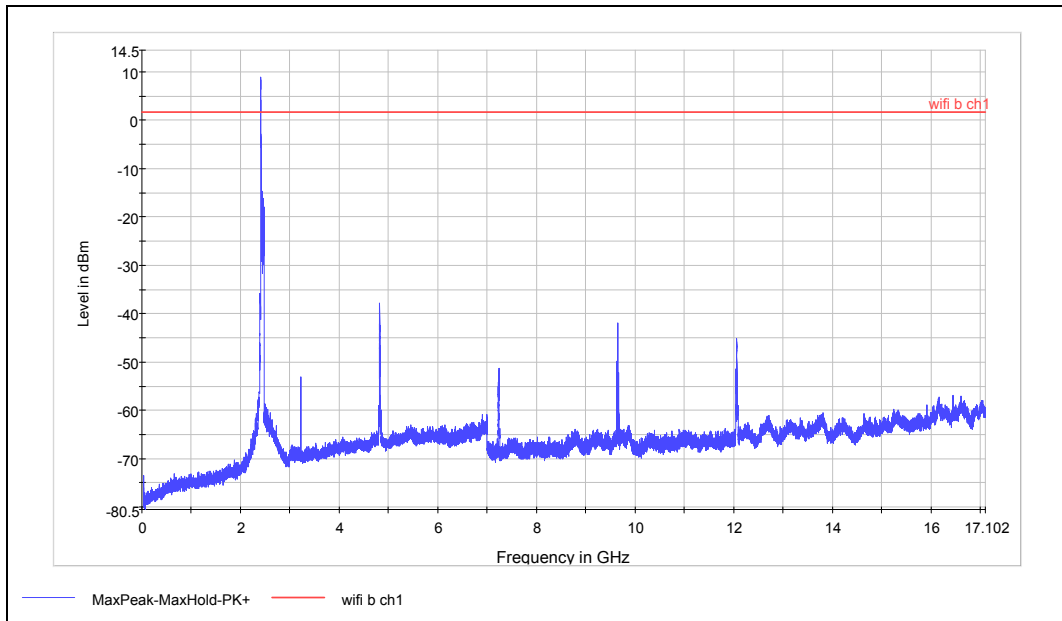

Note: The signal beyond the limit is carrier

Spurious RF conducted emissions from 30MHz to 18GHz

Harmonic	Frequency (MHz)	Level(dBm)	Margin(dB)	Limit(dBm)
2	4824.0	-37.75	39.42	1.67
3	7236.3	-51.29	52.96	1.67
4	9647.6	-41.99	43.66	1.67
5	12059.3	-45.16	46.83	1.67

TA Technology (Shanghai) Co., Ltd. Test Report

Report No.: RXA1503-0042RF01R1

Page 39 of 103

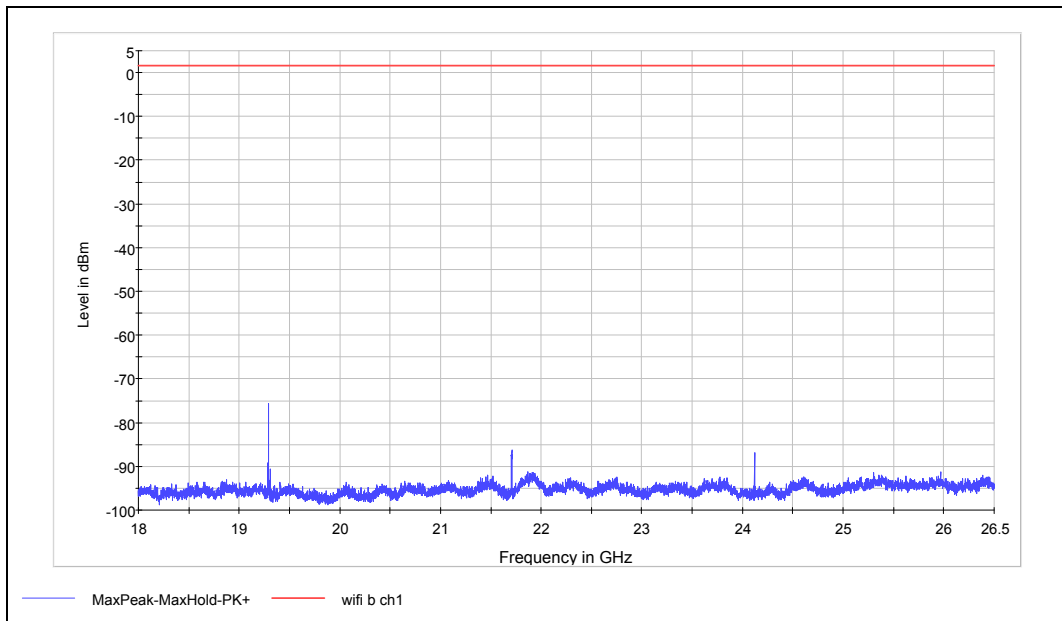

Spurious RF conducted emissions from 18GHz to 26.5GHz

Harmonic	Frequency (MHz)	Level(dBm)	Margin(dB)	Limit(dBm)
8	19295.2	-75.61	77.28	1.67
9	21708.1	-86.22	87.89	1.67
10	24120.0	-86.93	88.60	1.67

TA Technology (Shanghai) Co., Ltd. Test Report

Report No.: RXA1503-0042RF01R1

Page 40 of 103

802.11b CH6

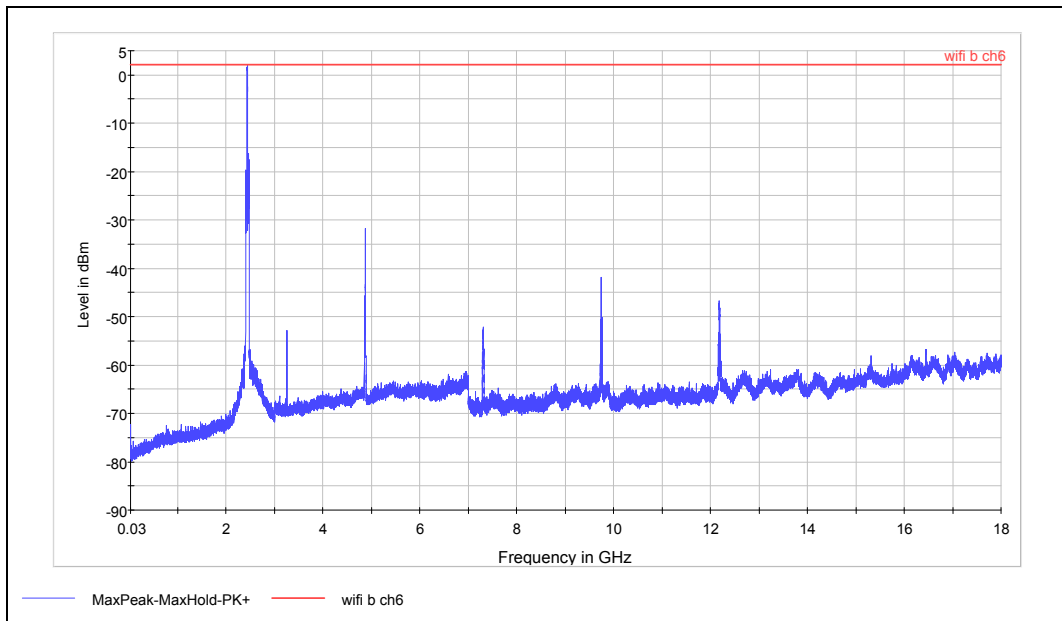

Note: The signal beyond the limit is carrier

Spurious RF conducted emissions from 30MHz to 18GHz

Harmonic	Frequency (MHz)	Level(dBm)	Margin(dB)	Limit(dBm)
2	4874.3	-31.7	33.77	2.08
3	7313.6	-52.2	54.29	2.08
4	9747.7	-41.8	43.88	2.08
5	12183.0	-46.8	48.88	2.08

TA Technology (Shanghai) Co., Ltd. Test Report

Report No.: RXA1503-0042RF01R1

Page 41 of 103

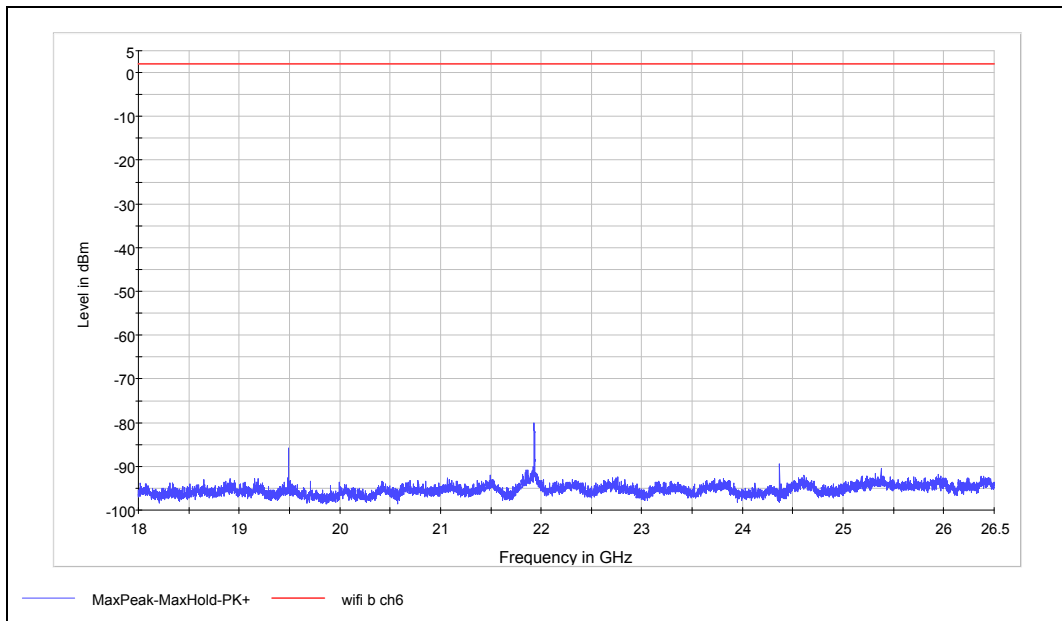

Spurious RF conducted emissions from 18GHz to 26.5GHz

Harmonic	Frequency (MHz)	Level(dBm)	Margin(dB)	Limit(dBm)
8	19494.4	-85.77	87.85	2.08
9	21930.2	-80.05	82.13	2.08
10	24369.7	-89.34	91.42	2.08

TA Technology (Shanghai) Co., Ltd. Test Report

Report No.: RXA1503-0042RF01R1

Page 42 of 103

802.11b CH11

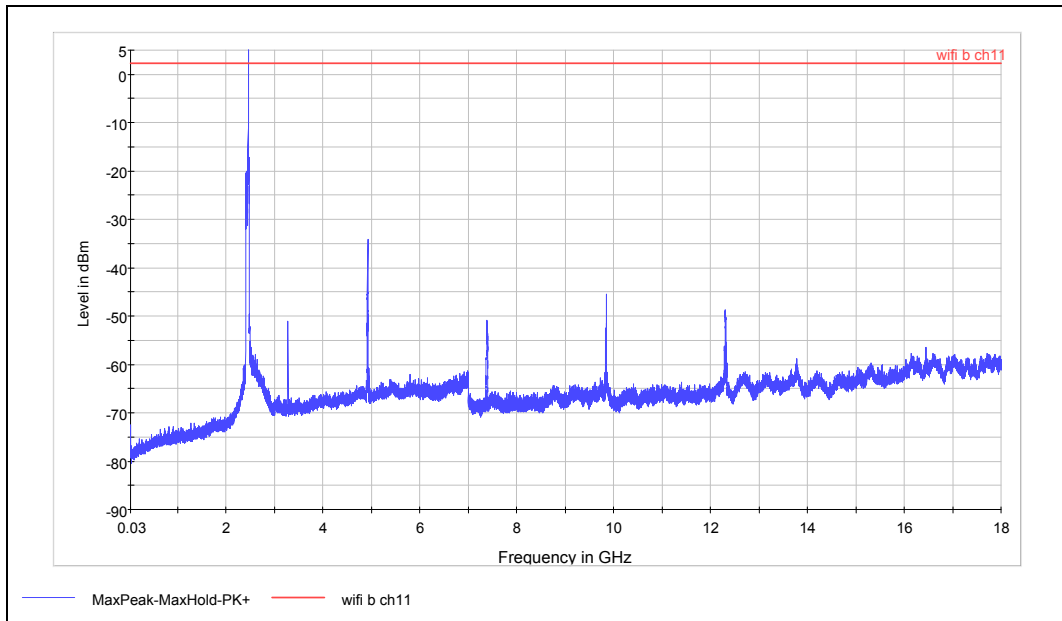

Note: The signal beyond the limit is carrier

Spurious RF conducted emissions from 30MHz to 18GHz

Harmonic	Frequency (MHz)	Level(dBm)	Margin(dB)	Limit(dBm)
2	4923.7	-34.05	36.28	2.23
3	7384.5	-51.00	53.23	2.23
4	9847.8	-45.53	47.76	2.23
5	12306.7	-48.82	51.05	2.23

TA Technology (Shanghai) Co., Ltd. Test Report

Report No.: RXA1503-0042RF01R1

Page 43 of 103

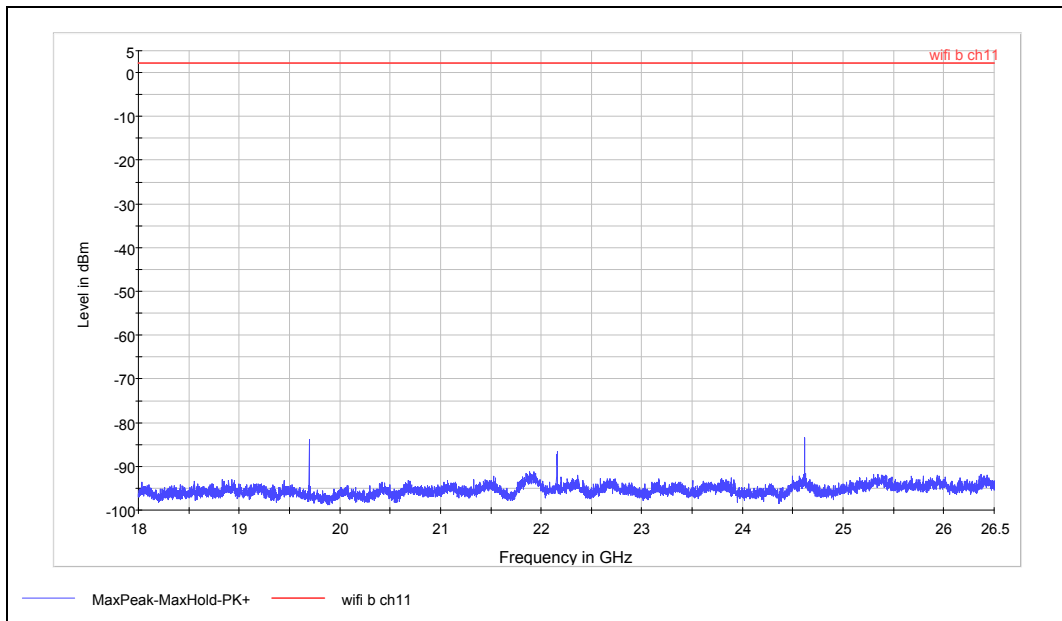

Spurious RF conducted emissions from 18GHz to 26.5GHz

Harmonic	Frequency (MHz)	Level(dBm)	Margin(dB)	Limit(dBm)
8	19695.8	-83.87	86.10	2.23
9	22160.8	-86.58	88.81	2.23
10	24620.4	-83.42	85.65	2.23

TA Technology (Shanghai) Co., Ltd. Test Report

Report No.: RXA1503-0042RF01R1

Page 44 of 103

802.11g CH1

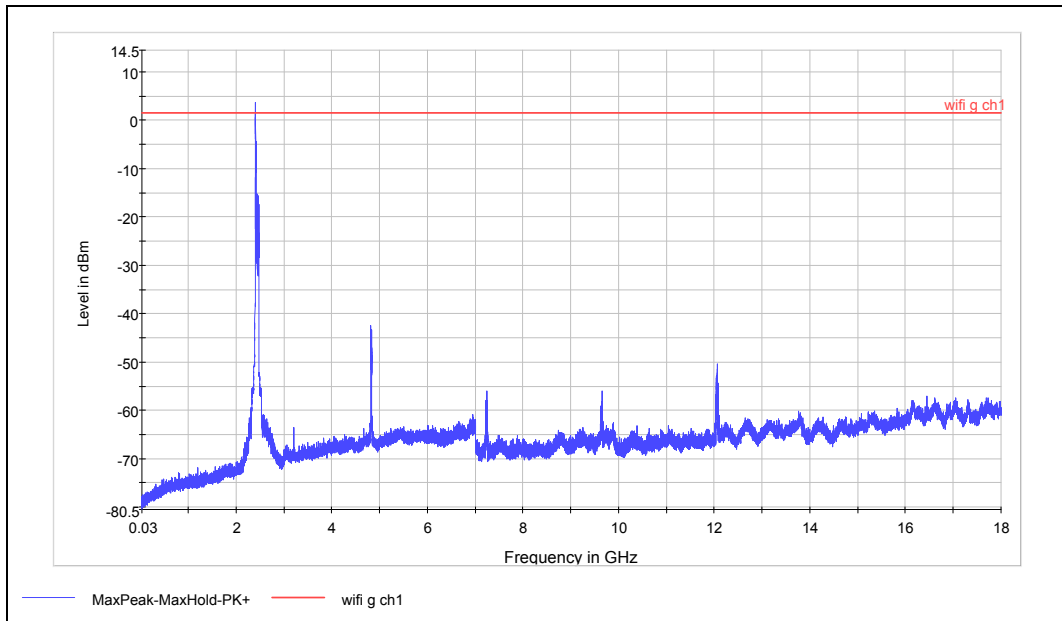

Note: The signal beyond the limit is carrier

Spurious RF conducted emissions from 30MHz to 18GHz

Harmonic	Frequency (MHz)	Level(dBm)	Margin(dB)	Limit(dBm)
2	4822.5	-42.51	44.08	1.57
3	7236.3	-55.91	57.48	1.57
4	9648.0	-55.93	57.50	1.57
5	12058.5	-50.39	51.96	1.57

TA Technology (Shanghai) Co., Ltd. Test Report

Report No.: RXA1503-0042RF01R1

Page 45 of 103

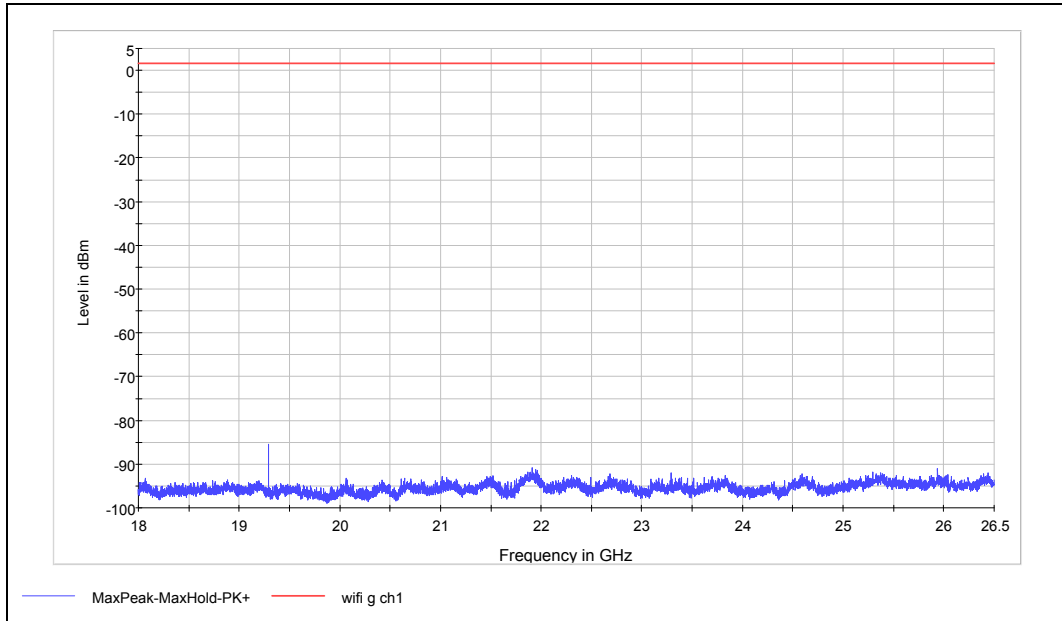

Spurious RF conducted emissions from 18GHz to 26.5GHz

Harmonic	Frequency (MHz)	Level(dBm)	Margin(dB)	Limit(dBm)
8	19295.2	-85.50	87.07	1.57

TA Technology (Shanghai) Co., Ltd.

Test Report

Report No.: RXA1503-0042RF01R1

Page 46 of 103

802.11g CH6

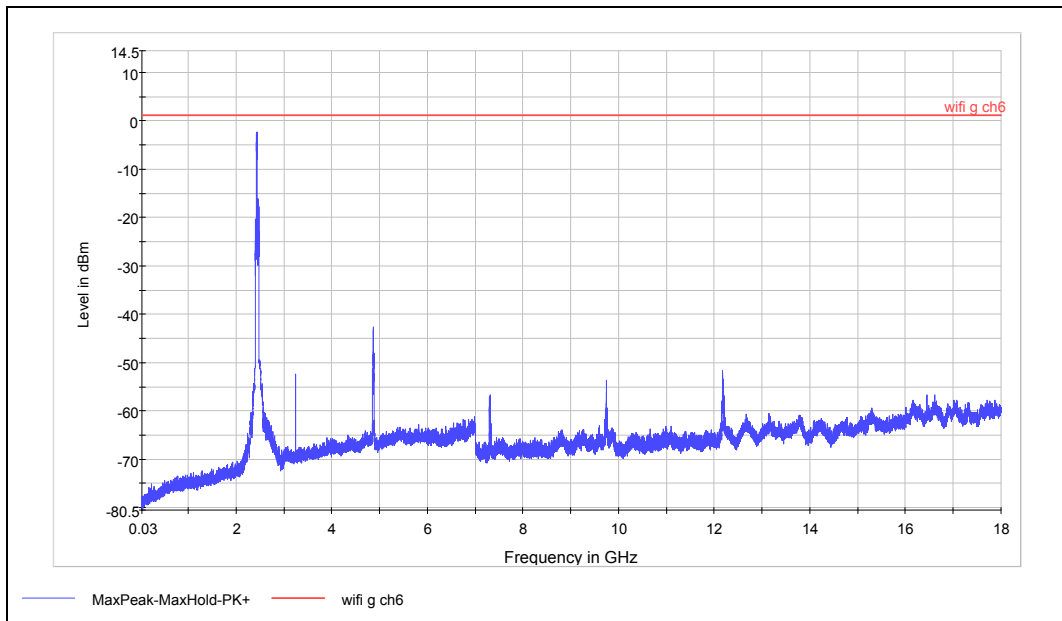

Note: The signal beyond the limit is carrier

Spurious RF conducted emissions from 30MHz to 18GHz

Harmonic	Frequency (MHz)	Level(dBm)	Margin(dB)	Limit(dBm)
2	4872.7	-42.62	43.79	1.17
3	7315.5	-56.68	57.85	1.17
4	9747.7	-53.69	54.86	1.17
5	12183.0	-51.57	52.74	1.17

TA Technology (Shanghai) Co., Ltd. Test Report

Report No.: RXA1503-0042RF01R1

Page 47 of 103

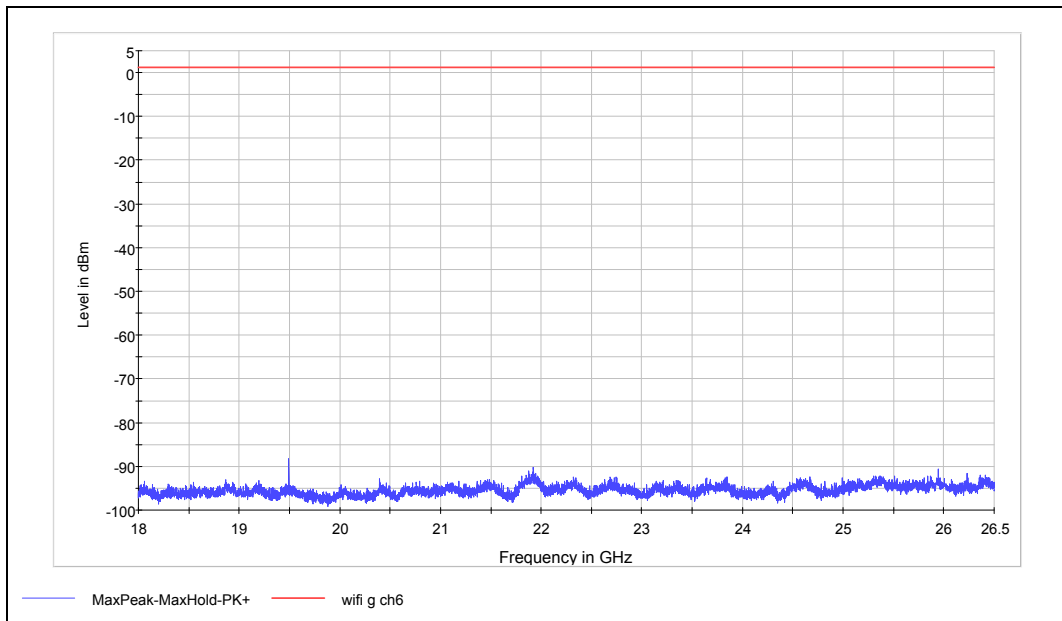

Spurious RF conducted emissions from 18GHz to 26.5GHz

Harmonic	Frequency (MHz)	Level(dBm)	Margin(dB)	Limit(dBm)
8	19496.0	-88.18	89.35	1.17

TA Technology (Shanghai) Co., Ltd. Test Report

802.11g CH11

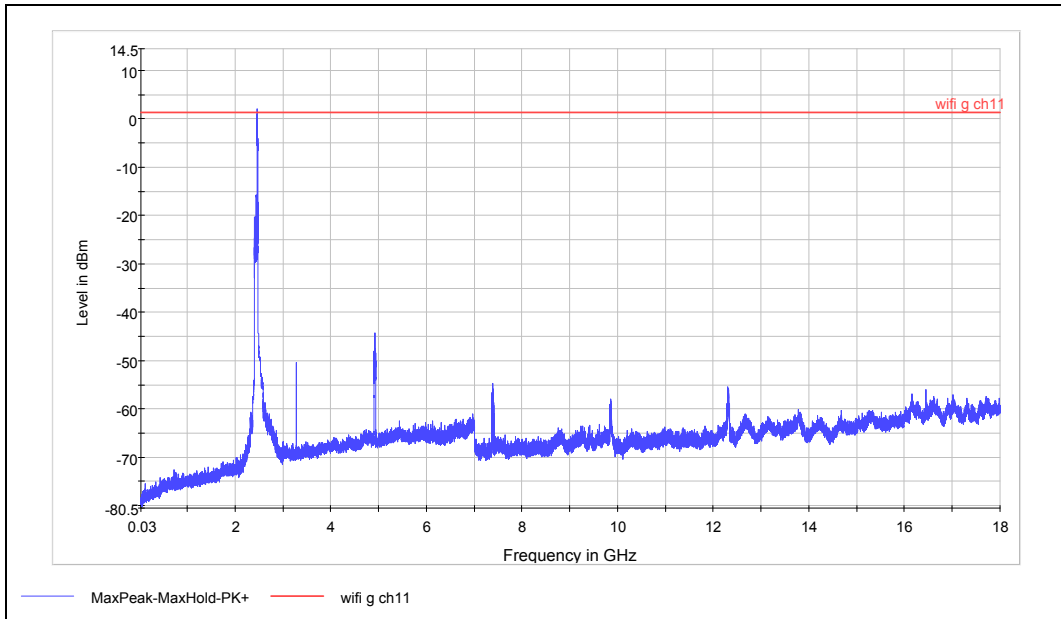

Note: The signal beyond the limit is carrier

Spurious RF conducted emissions from 30MHz to 18GHz

Harmonic	Frequency (MHz)	Level(dBm)	Margin(dB)	Limit(dBm)
2	4925.2	-44.24	45.63	1.39
3	7384.5	-54.80	56.19	1.39
4	9853.5	-57.92	59.31	1.39
5	12294.7	-55.79	57.18	1.39

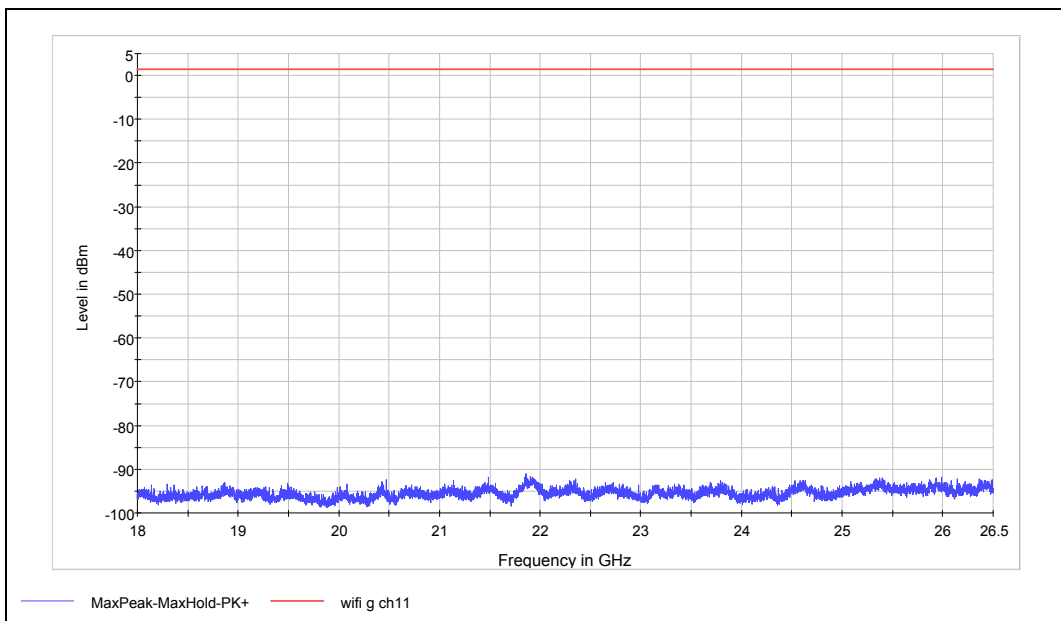

Spurious RF conducted emissions from 18GHz to 26.5GHz

TA Technology (Shanghai) Co., Ltd.

Test Report

802.11n(HT20) CH1

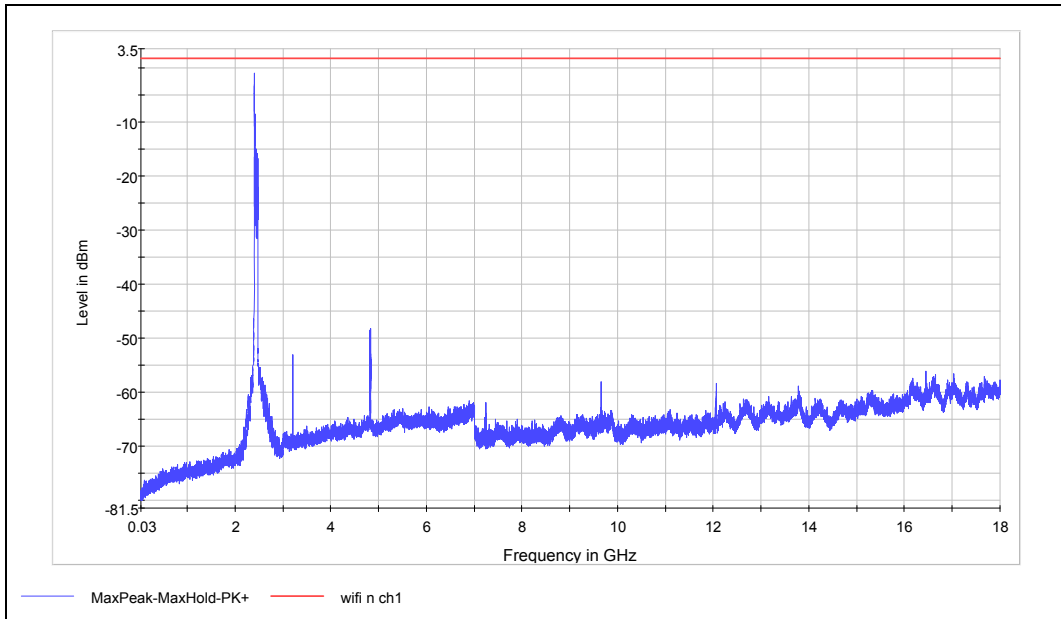

Note: The signal beyond the limit is carrier

Spurious RF conducted emissions from 30MHz to 18GHz

Harmonic	Frequency (MHz)	Level(dBm)	Margin(dB)	Limit(dBm)
2	4825.5	-48.33	50.01	1.68
3	7236.0	-61.91	63.59	1.68
4	9648.0	-58.05	59.73	1.68

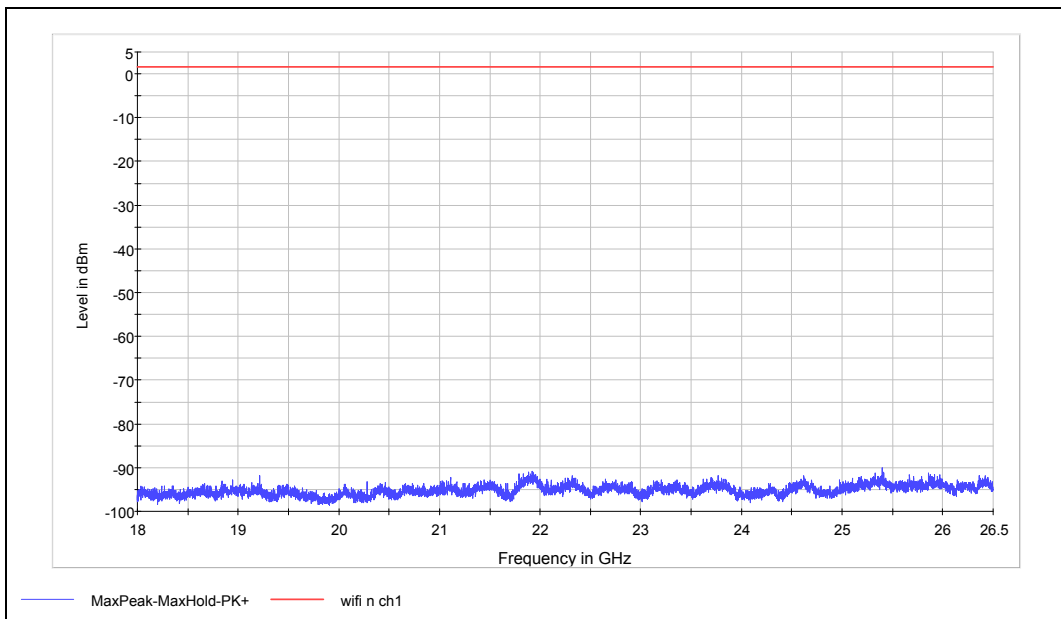

Spurious RF conducted emissions from 18GHz to 26.5GHz

TA Technology (Shanghai) Co., Ltd. Test Report

Report No.: RXA1503-0042RF01R1

Page 50 of 103

802.11n(HT20) CH6

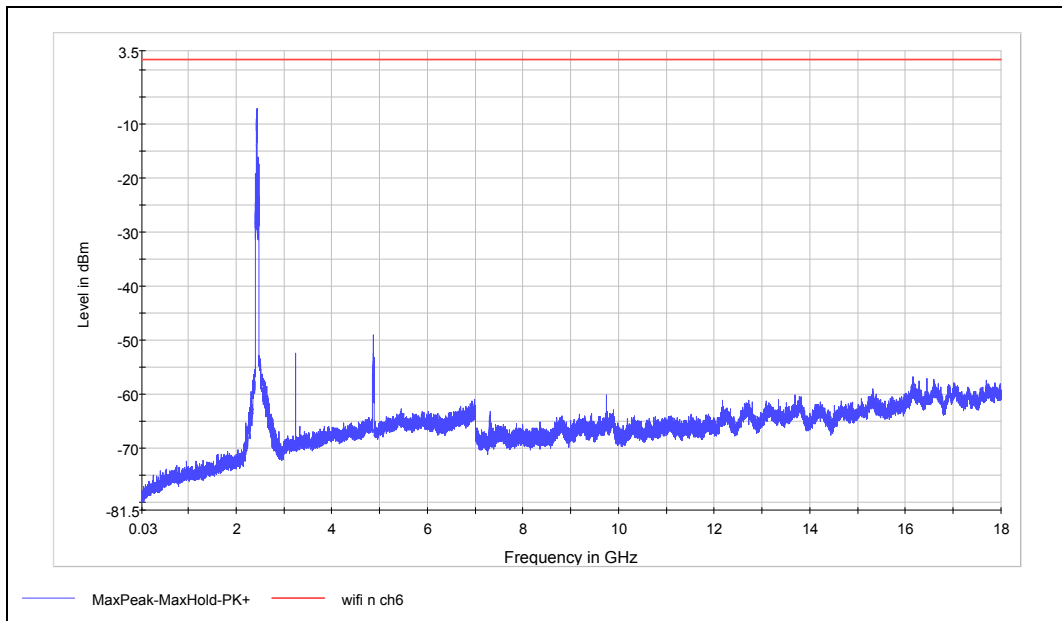

Note: The signal beyond the limit is carrier

Spurious RF conducted emissions from 30MHz to 18GHz

Harmonic	Frequency (MHz)	Level(dBm)	Margin(dB)	Limit(dBm)
2	4875.0	-49.05	50.94	1.89
3	7311.0	-63.25	65.14	1.89
4	9747.8	-60.22	62.11	1.89

TA Technology (Shanghai) Co., Ltd. Test Report

Report No.: RXA1503-0042RF01R1

Page 51 of 103

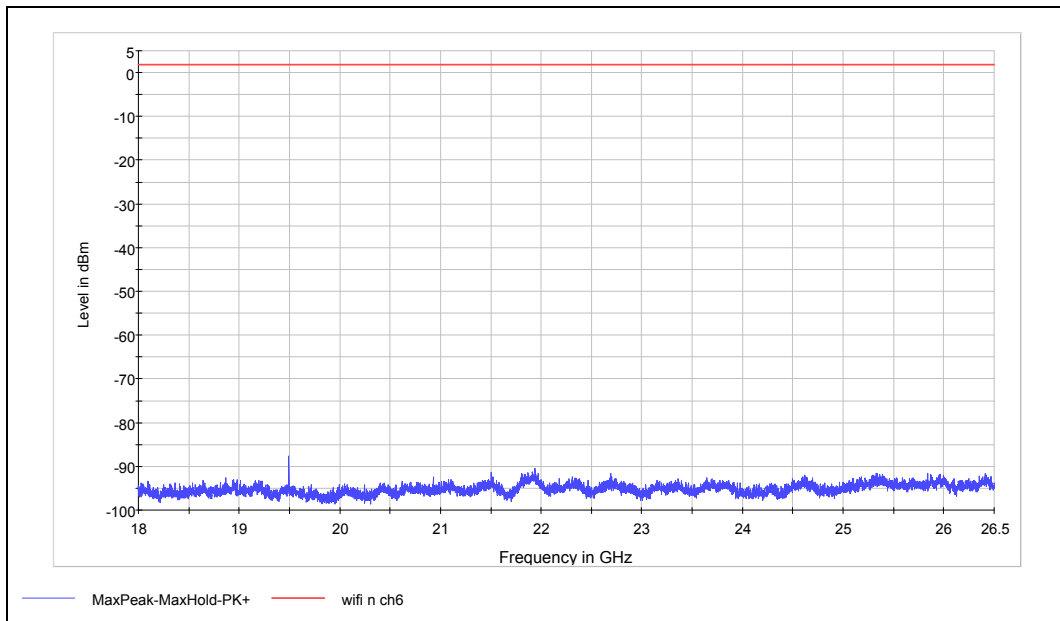

Spurious RF conducted emissions from 18GHz to 26.5GHz

Harmonic	Frequency (MHz)	Level(dBm)	Margin(dB)	Limit(dBm)
8	19496.0	-87.61	89.50	1.89

TA Technology (Shanghai) Co., Ltd. Test Report

Report No.: RXA1503-0042RF01R1

Page 52 of 103

802.11n(HT20) CH11

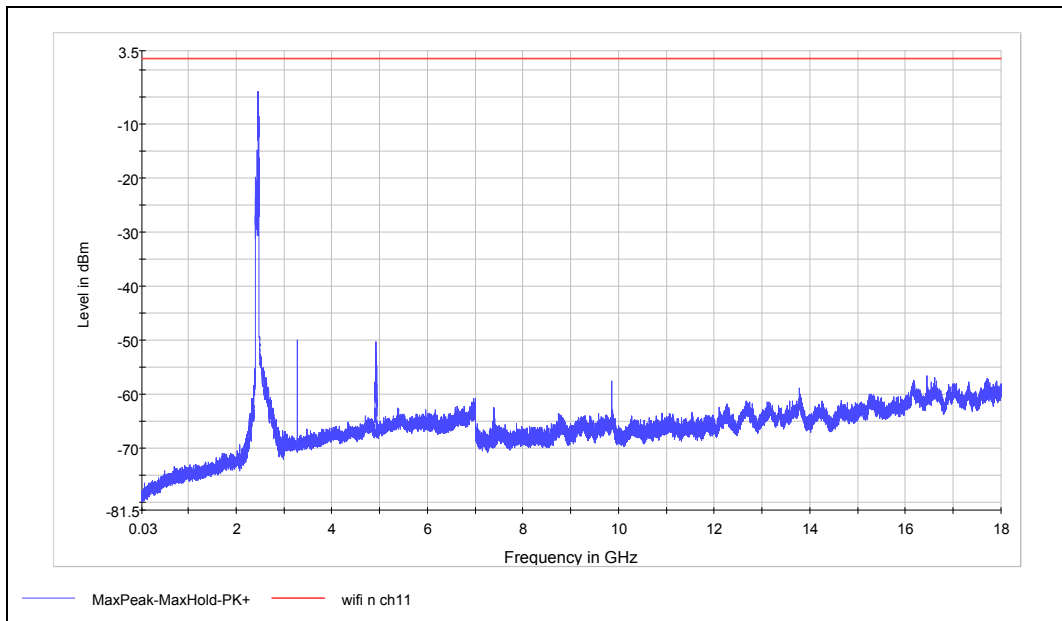

Note: The signal beyond the limit is carrier

Spurious RF conducted emissions from 30MHz to 18GHz

Harmonic	Frequency (MHz)	Level(dBm)	Margin(dB)	Limit(dBm)
2	4923.0	-50.34	52.38	2.04
3	7383.4	-62.45	64.49	2.04
4	9847.9	-57.59	59.63	2.04

TA Technology (Shanghai) Co., Ltd. Test Report

Report No.: RXA1503-0042RF01R1

Page 53 of 103

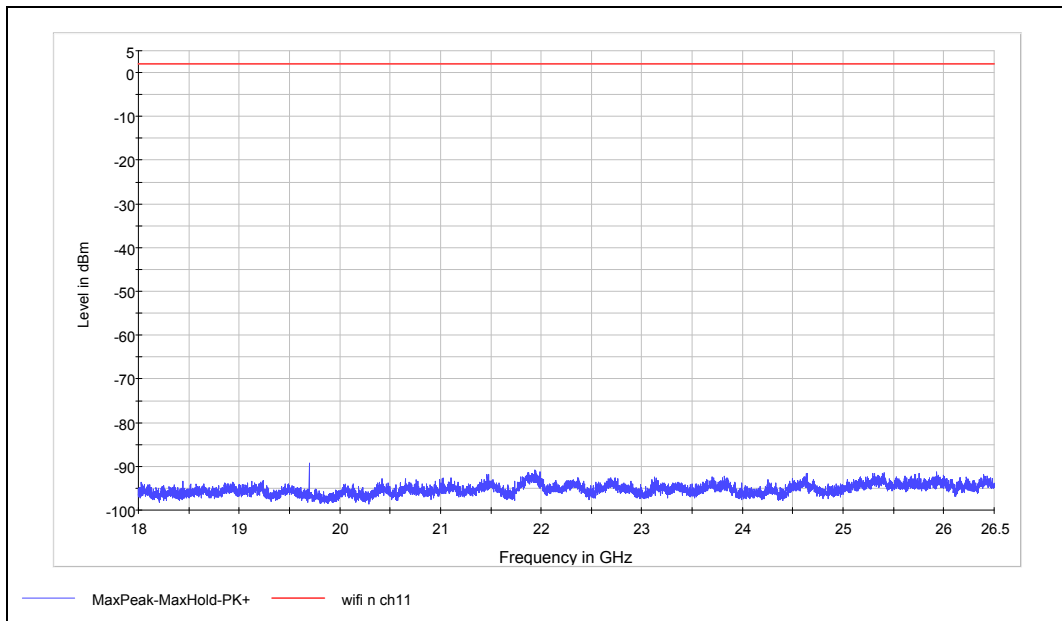

Spurious RF conducted emissions from 18GHz to 26.5GHz

Harmonic	Frequency (MHz)	Level(dBm)	Margin(dB)	Limit(dBm)
8	19695.8	-89.18	91.22	2.04

2.9. Radiates Emission

Ambient condition

Temperature	Relative humidity	Pressure
23°C ~25°C	45%~50%	101.5kPa

Method of Measurement

The test set-up was made in accordance to the general provisions of ANSI C63.4-2009. The Equipment Under Test (EUT) was set up on a non-conductive table in the semi-anechoic chamber. The test was performed at the distance of 3 m between the EUT and the receiving antenna. The radiated emissions measurements were made in a typical installation configuration. Sweep the whole frequency band through the range from 9kHz to the 10th harmonic of the carrier, and the emissions less than 20 dB below the permissible value are reported.

During the test, below 30MHz, the center of the loop shall be 1 meters; above 30MHz, the height of receive antenna shall be moved from 1 to 4 meters and the antenna shall be performed under horizontal and vertical polarization. The turntable shall be rotated from 0 to 360 degrees for detecting the maximum of radiated spurious signal level. The measurements shall be repeated with orthogonal polarization of the test antenna. The data of cable loss and antenna factor has been calibrated in full testing frequency range before the testing.

Set the spectrum analyzer in the following:

Below 1GHz (detector: Peak and Quasi-Peak)

RBW=100kHz / VBW=300kHz / Sweep=AUTO

Above 1GHz(detector: Peak):

(a) PEAK: RBW=1MHz VBW=3MHz/ Sweep=AUTO

(b) AVERAGE: RBW=1MHz / VBW=10Hz / Sweep=AUTO

The radiated emission was measured in the following position: EUT stand-up position (Z axis), lie-down position (X, Y axis). The worst emission was found in lie-down position (X axis) and the worst case was recorded.

The test is in transmitting mode.

TA Technology (Shanghai) Co., Ltd. Test Report

Test setup

9KHz~~~ 30MHz

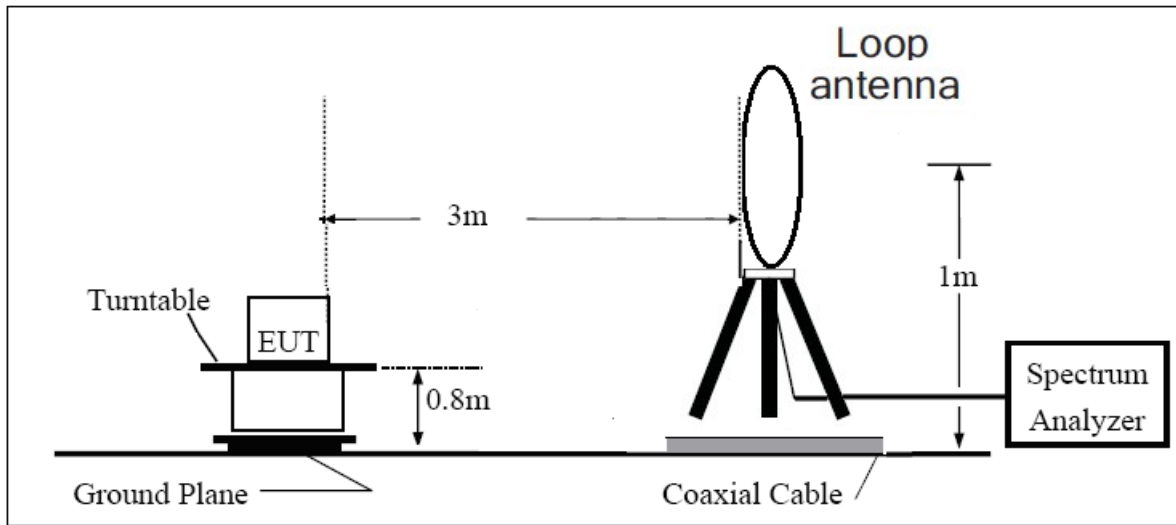

30MHz~~~ 1GHz

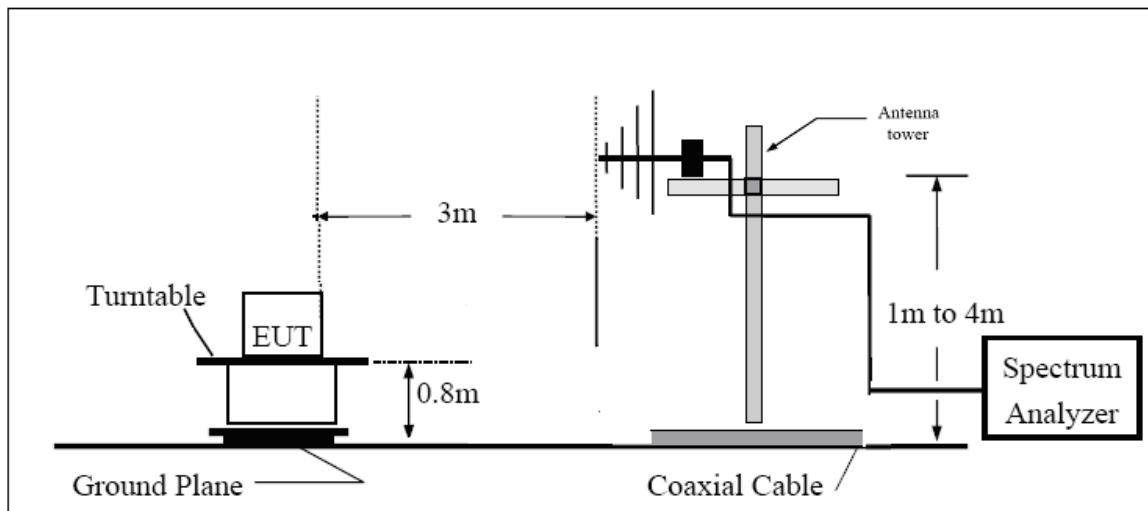

Above 1GHz

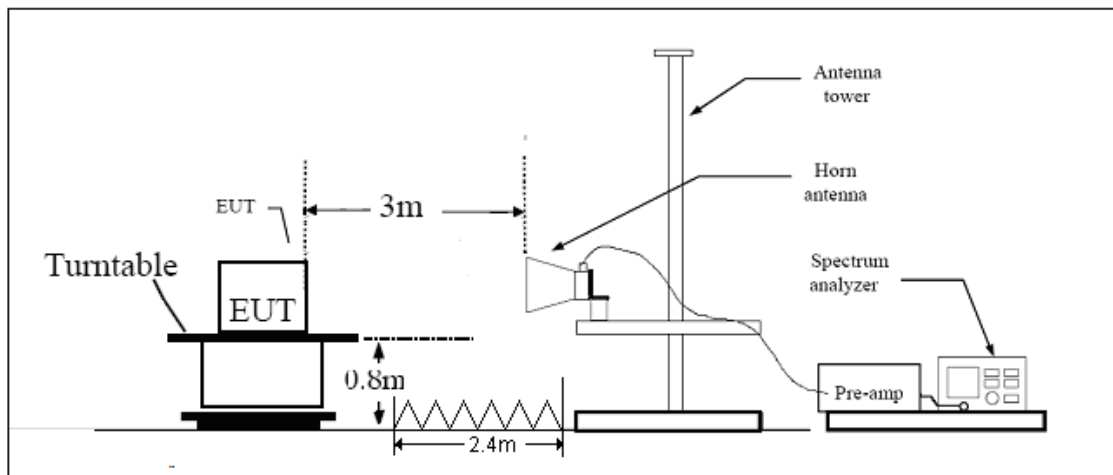

Note: Area side: 2.4mX3.6m

TA Technology (Shanghai) Co., Ltd.
Test Report

Report No.: RXA1503-0042RF01R1

Page 56 of 103

Limits

Rule Part 15.247(d) specifies that “In addition, radiated emissions which fall in the restricted bands, as defined in § 15.205(a), must also comply with the radiated emission limits specified in § 15.209(a) (see § 15.205(c)).”

Limit in restricted band

Frequency of emission (MHz)	Field strength(uV/m)	Field strength(dBuV/m)
0.009–0.490	2400/F(kHz)	/
0.490–1.705	24000/F(kHz)	/
1.705–30.0	30	/
30-88	100	40
88-216	150	43.5
216-960	200	46
Above960	500	54

Measurement Uncertainty

The assessed measurement uncertainty to ensure 95% confidence level for the normal distribution is with the coverage factor $k = 1.96$.

Frequency	Uncertainty
9KHz-30MHz	3.55 dB
30MHz-200MHz	4.19 dB
200MHz-1GHz	3.63 dB
Above 1GHz	3.68 dB

TA Technology (Shanghai) Co., Ltd.

Test Report

Test result
802.11b CH1

RE 30M-1GHz (PART15 C) QP

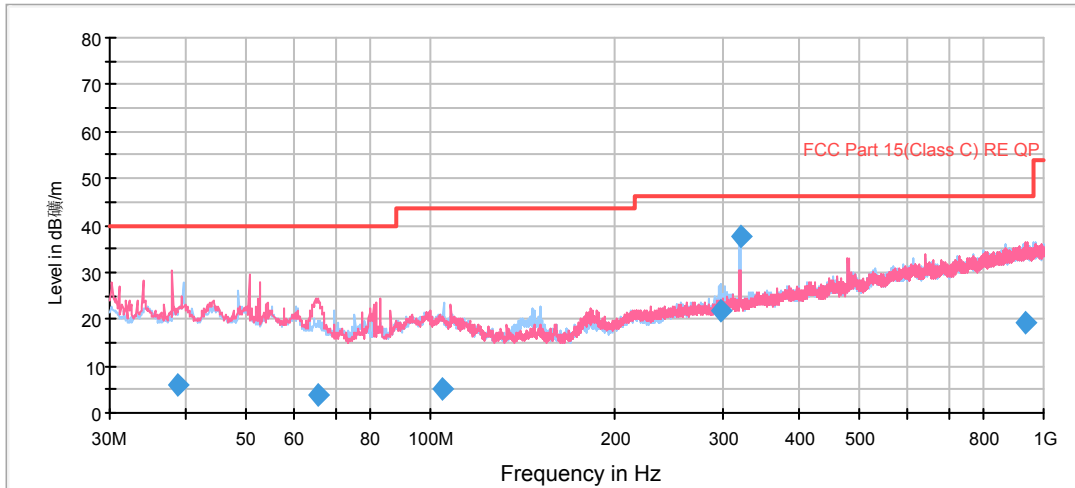

— FCC Part 15(Class C) RE QP — Preview Result 1H-PK+
— Preview Result 1V-PK+ ◆ Final Result 1-QPK

Note: This graph displays the maximum values of horizontal and vertical by software

Note: a font (Level in dB μ V/m) in the test plot =(level in dBuV/m)

Radiates Emission from 30MHz to 1GHz

Frequency (MHz)	Quasi-Peak (dBuV/m)	Height (cm)	Polarization	Azimuth (deg)	Reading value (dBuV/m)	Correct Factor (dB)	Margin (dB)	Limit (dBuV/m)
38.662500	6.1	99.0	V	8.0	25.4	-19.3	33.9	40.0
65.543750	3.8	118.0	V	82.0	29.5	-25.7	36.2	40.0
104.433750	5.0	99.0	H	207.0	29.9	-24.9	38.5	43.5
297.016250	21.6	127.0	H	272.0	44.6	-23.0	24.4	46.0
320.012500	37.6	100.0	H	112.0	60.0	-22.4	8.4	46.0
936.690000	19.1	99.0	V	88.0	30.8	-11.7	26.9	46.0

Remark: 1. Quasi-Peak = Reading value + Correction factor

2. Correction Factor = Antenna factor+ Insertion loss(cable loss+amplifier gain)

3. Margin = Limit – Quasi-Peak

TA Technology (Shanghai) Co., Ltd. Test Report

Report No.: RXA1503-0042RF01R1

Page 58 of 103

RE 1G-3GHz PK+AV

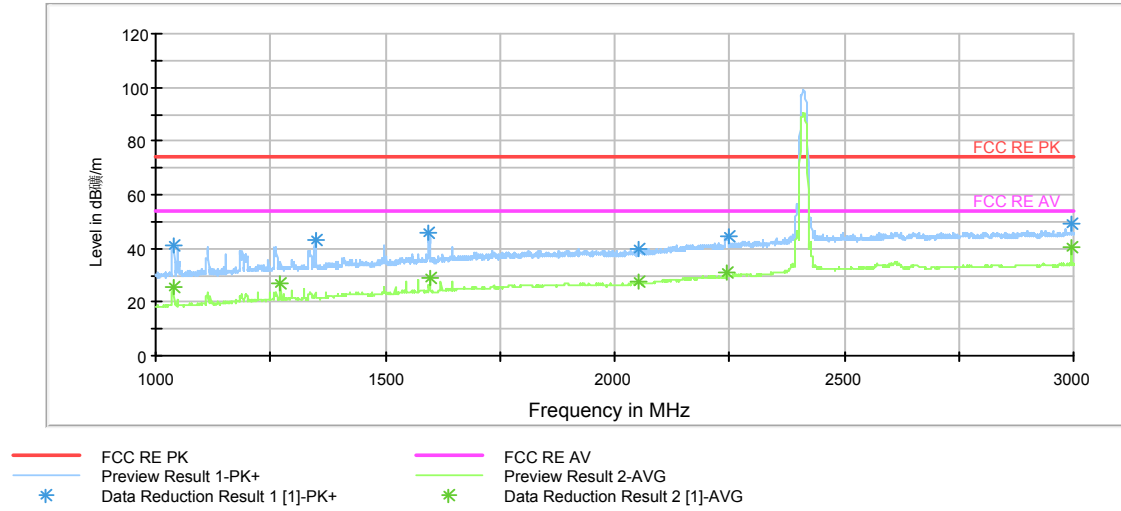

Note: This graph displays the maximum values of horizontal and vertical by software

Note: a font ($\frac{\text{Level in dBuV/m}}{\text{Height}}$) in the test plot =(level in dBuV/m)

Note: The signal beyond the limit is carrier.

Radiates Emission from 1GHz to 3GHz

Frequency (MHz)	Peak (dBuV/m)	Height (cm)	Polarization	Azimuth (deg)	Reading value (dBuV/m)	Correct Factor (dB)	Margin (dB)	Limit (dBuV/m)
1038.000000	40.2	101.0	V	171.0	51.4	-11.2	33.8	74
1272.500000	35.1	101.0	V	0.0	43.8	-8.7	38.9	74
1597.000000	41.9	101.0	V	291.0	47.9	-6.0	32.1	74
2054.000000	38.5	101.0	H	0.0	40.6	-2.1	35.5	74
2995.000000	48.9	101.0	V	251.0	53.7	-4.8	25.1	74
2244.000000	42.8	101.0	H	310.0	43.0	-0.2	31.2	74

Remark: 1. Correction Factor = Antenna factor+ Insertion loss (cable loss + amplifier gain)

Frequency (MHz)	Average (dBuV/m)	Height (cm)	Polarization	Azimuth (deg)	Reading value (dBuV/m)	Correct Factor (dB)	Margin (dB)	Limit (dBuV/m)
1038.000000	25.5	101.0	V	171.0	36.7	-11.2	28.5	54
1272.500000	26.7	101.0	V	0.0	35.4	-8.7	27.3	54
1597.000000	28.9	101.0	V	291.0	34.9	-6.0	25.1	54
2054.000000	27.4	101.0	H	0.0	29.5	-2.1	26.6	54
2995.000000	40.8	101.0	V	251.0	45.6	-4.8	13.2	54
2244.000000	31.2	101.0	H	310.0	31.4	-0.2	22.8	54

Remark: 1. Correction Factor = Antenna factor+ Insertion loss (cable loss + amplifier gain)

TA Technology (Shanghai) Co., Ltd. Test Report

RE 3-18GHz PK+AV

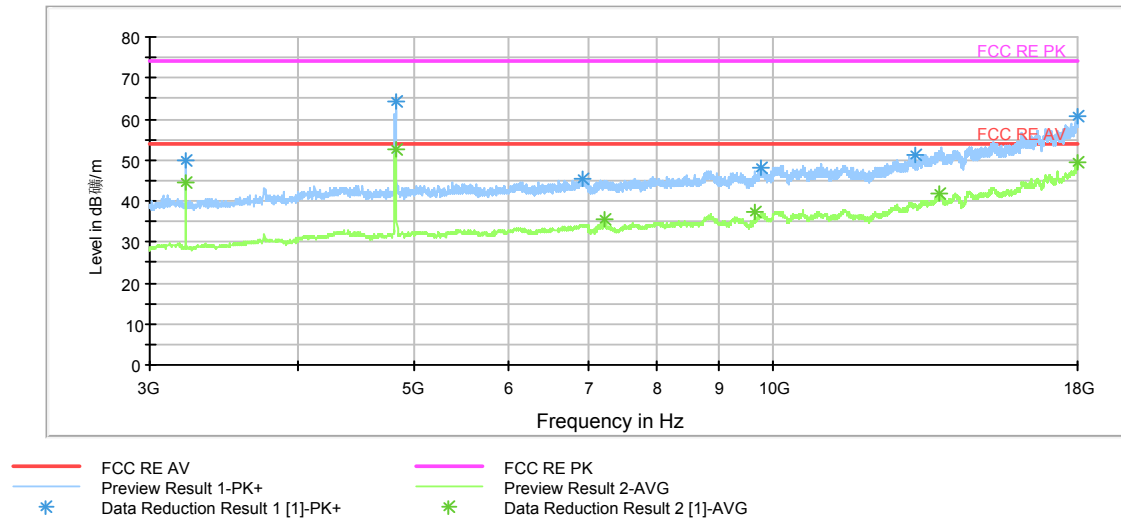

Note: This graph displays the maximum values of horizontal and vertical by software

Note: a font (Level in dBµV/m) in the test plot =(level in dBuV/m)

Note: The signal beyond the limit is harmonic of carrier.

Radiates Emission from 3GHz to 18GHz

Frequency (MHz)	Peak (dBuV/m)	Height (cm)	Polarization	Azimuth (deg)	Reading value (dBuV/m)	Correct Factor (dB)	Margin (dB)	Limit (dBuV/m)
3215.625000	49.9	101.0	V	359.0	51.6	-1.7	24.1	74
4824.375000	62.3	101.0	V	0.0	64.9	-2.6	11.7	74
17996.250000	58.7	101.0	V	318.0	83.3	-24.6	15.3	74
7233.750000	43.3	101.0	H	0.0	51.0	-7.7	30.7	74
9648.750000	47.2	101.0	V	359.0	56.6	-9.4	26.8	74
13786.875000	50.8	101.0	V	0.0	66.5	-15.7	23.2	74

Remark: 1. Correction Factor = Antenna factor+ Insertion loss (cable loss + amplifier gain)

Frequency (MHz)	Average (dBuV/m)	Height (cm)	Polarization	Azimuth (deg)	Reading value (dBuV/m)	Correct Factor (dB)	Margin (dB)	Limit (dBuV/m)
3215.625000	44.5	101.0	V	359.0	40.7	-1.7	9.5	54
4824.375000	52.5	101.0	V	0.0	46.1	-2.6	1.5	54
17996.250000	49.3	101.0	V	318.0	58.7	-24.6	4.7	54
7233.750000	35.5	101.0	H	0.0	45.1	-7.7	18.5	54
9648.750000	37.4	101.0	V	359.0	51.1	-9.4	16.6	54
13786.875000	41.7	101.0	V	0.0	64.8	-15.7	12.3	54

Remark: 1. Correction Factor = Antenna factor+ Insertion loss (cable loss + amplifier gain)

TA Technology (Shanghai) Co., Ltd. Test Report

Report No.: RXA1503-0042RF01R1

Page 60 of 103

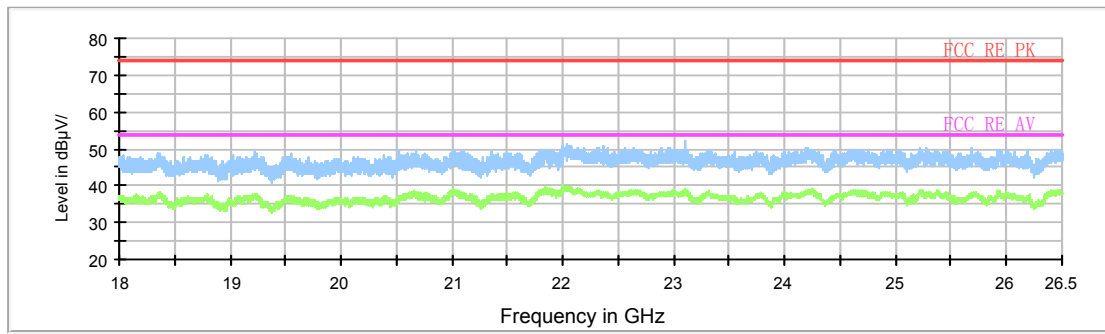

Note: This graph displays the maximum values of horizontal and vertical by software

Note: a font (Level in dBuV/m) in the test plot =(level in dBuV/m)

Radiates Emission from 18GHz to 26.5GHz

TA Technology (Shanghai) Co., Ltd. Test Report

802.11b CH6

RE 30M-1GHz QP

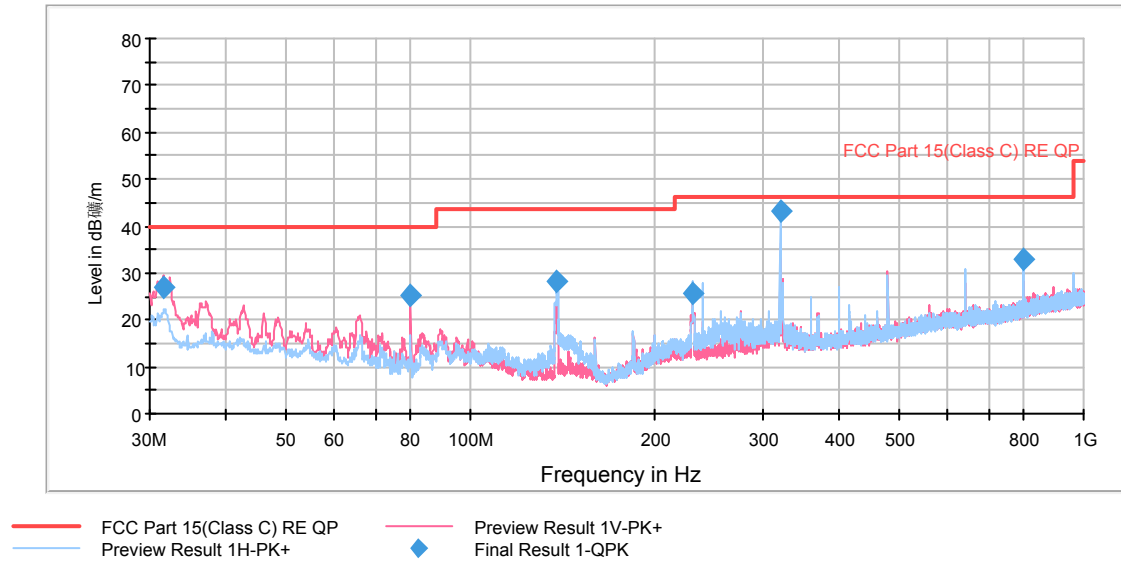

Note: This graph displays the maximum values of horizontal and vertical by software

Note: a font (Level in dBuV/m) in the test plot =(level in dBuV/m)

Radiates Emission from 30MHz to 1GHz

Frequency (MHz)	Quasi-Peak (dBuV/m)	Height (cm)	Polarization	Azimuth (deg)	Reading value (dBuV/m)	Correct Factor (dB)	Margin (dB)	Limit (dBuV/m)
31.617310	26.9	99.0	V	300.0	44.9	-18.0	13.1	40.0
79.995112	25.1	177.0	V	182.0	53.7	-28.6	14.9	40.0
138.330560	28.3	177.0	H	6.0	57.6	-29.3	15.2	43.5
230.571000	25.6	118.0	H	25.0	51.0	-25.4	20.4	46.0
319.990000	43.4	99.0	H	116.0	66.3	-22.9	2.6	46.0
799.978750	33.1	99.0	H	17.0	47.3	-14.2	12.9	46.0

Remark: 1. Quasi-Peak = Reading value + Correction factor

2. Correction Factor = Antenna factor+ Insertion loss(cable loss+amplifier gain)

3. Margin = Limit – Quasi-Peak

TA Technology (Shanghai) Co., Ltd. Test Report

RE 1G-3GHz PK+AV

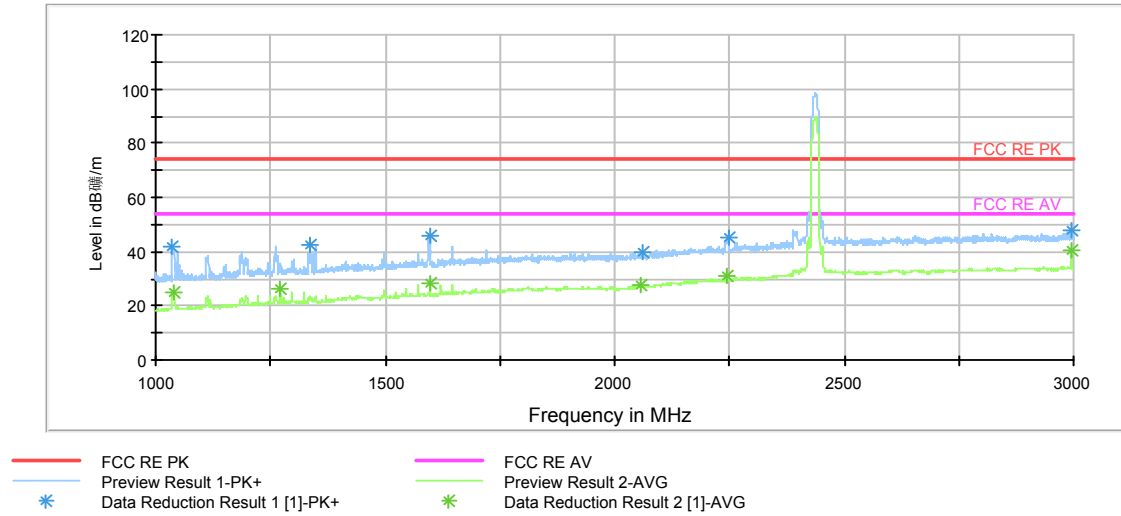

Note: This graph displays the maximum values of horizontal and vertical by software

Note: a font ($\text{Level in dB}\frac{\mu\text{V}}{\text{m}}$) in the test plot =(level in dBuV/m)

Note: The signal beyond the limit is carrier.

Radiates Emission from 1GHz to 3GHz

Frequency (MHz)	Peak (dBuV/m)	Height (cm)	Polarization	Azimuth (deg)	Reading value (dBuV/m)	Correct Factor (dB)	Margin (dB)	Limit (dBuV/m)
1039.000000	39.8	101.0	V	170.0	51.0	-11.2	34.2	74
1272.500000	35.5	101.0	V	0.0	44.2	-8.7	38.5	74
1597.000000	45.0	101.0	V	329.0	51.0	-6.0	29.0	74
2056.500000	37.5	101.0	H	32.0	39.6	-2.1	36.5	74
2995.000000	47.9	101.0	V	329.0	52.7	-4.8	26.1	74
2244.500000	43.3	101.0	H	310.0	43.5	-0.2	30.7	74

Remark: 1. Correction Factor = Antenna factor+ Insertion loss (cable loss + amplifier gain)

Frequency (MHz)	Average (dBuV/m)	Height (cm)	Polarization	Azimuth (deg)	Reading value (dBuV/m)	Correct Factor (dB)	Margin (dB)	Limit (dBuV/m)
1039.000000	25.3	101.0	V	170.0	36.5	-11.2	28.7	54
1272.500000	26.6	101.0	V	0.0	35.3	-8.7	27.4	54
1597.000000	28.4	101.0	V	329.0	34.4	-6.0	25.6	54
2056.500000	27.4	101.0	H	32.0	29.5	-2.1	26.6	54
2995.000000	40.6	101.0	V	329.0	45.4	-4.8	13.4	54
2244.500000	31.3	101.0	H	310.0	31.5	-0.2	22.7	54

Remark: 1. Correction Factor = Antenna factor+ Insertion loss (cable loss + amplifier gain)

TA Technology (Shanghai) Co., Ltd. Test Report

RE 3-18GHz PK+AV

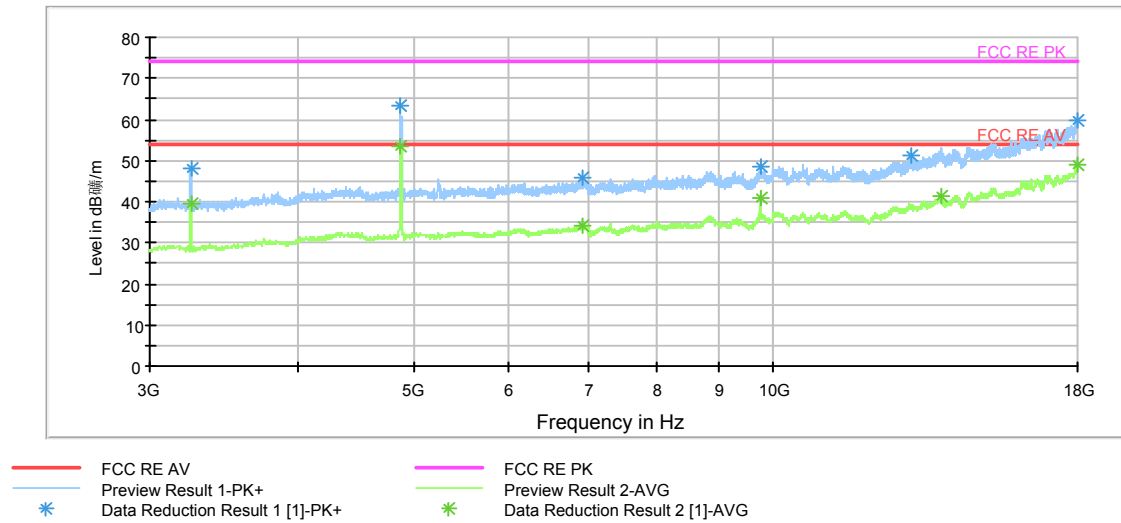

Note: This graph displays the maximum values of horizontal and vertical by software

Note: a font (Level in dBuV/m) in the test plot =(level in dBuV/m)

Radiates Emission from 3GHz to 18GHz

Frequency (MHz)	Peak (dBuV/m)	Height (cm)	Polarization	Azimuth (deg)	Reading value (dBuV/m)	Correct Factor (dB)	Margin (dB)	Limit (dBuV/m)
4873.125000	57.3	101.0	H	0.0	60.2	-2.9	16.7	74
17996.250000	59.7	101.0	H	293.0	84.3	-24.6	14.3	74
3249.375000	48.2	101.0	V	36.0	49.7	-1.5	25.8	74
6926.250000	43.2	101.0	V	301.0	48.9	-5.7	30.8	74
9748.125000	48.7	101.0	V	344.0	59.3	-10.6	25.3	74
13848.750000	50.4	101.0	H	213.0	66.4	-16.0	23.6	74

Remark: 1. Correction Factor = Antenna factor+ Insertion loss (cable loss + amplifier gain)

Frequency (MHz)	Average (dBuV/m)	Height (cm)	Polarization	Azimuth (deg)	Reading value (dBuV/m)	Correct Factor (dB)	Margin (dB)	Limit (dBuV/m)
4873.125000	53.6	101.0	H	0.0	56.5	-2.9	0.4	54
17996.250000	49.1	101.0	H	293.0	73.7	-24.6	4.9	54
3249.375000	39.5	101.0	V	36.0	41.0	-1.5	14.5	54
6926.250000	34.1	101.0	V	301.0	39.8	-5.7	19.9	54
9748.125000	40.8	101.0	V	344.0	51.4	-10.6	13.2	54
13848.750000	41.2	101.0	H	213.0	57.2	-16.0	12.8	54

Remark: 1. Correction Factor = Antenna factor+ Insertion loss (cable loss + amplifier gain)

TA Technology (Shanghai) Co., Ltd. Test Report

Report No.: RXA1503-0042RF01R1

Page 64 of 103

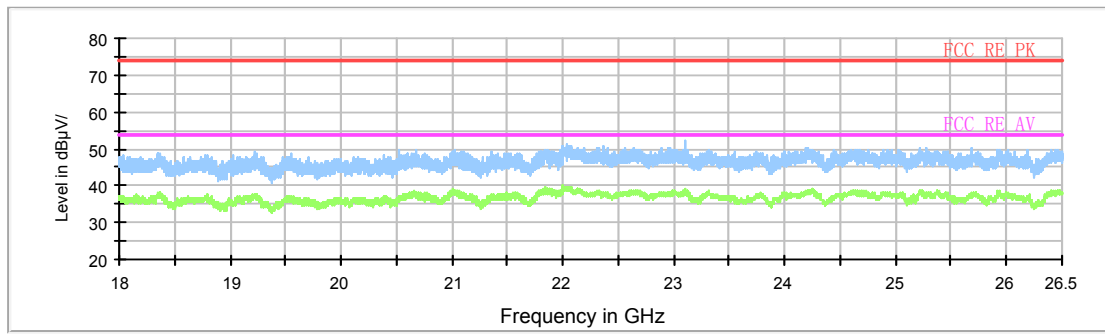

Note: This graph displays the maximum values of horizontal and vertical by software

Note: a font (Level in dBuV/m) in the test plot =(level in dBuV/m)

Radiates Emission from 18GHz to 26.5GHz

TA Technology (Shanghai) Co., Ltd. Test Report

802.11b CH11

RE 30M-1GHz QP

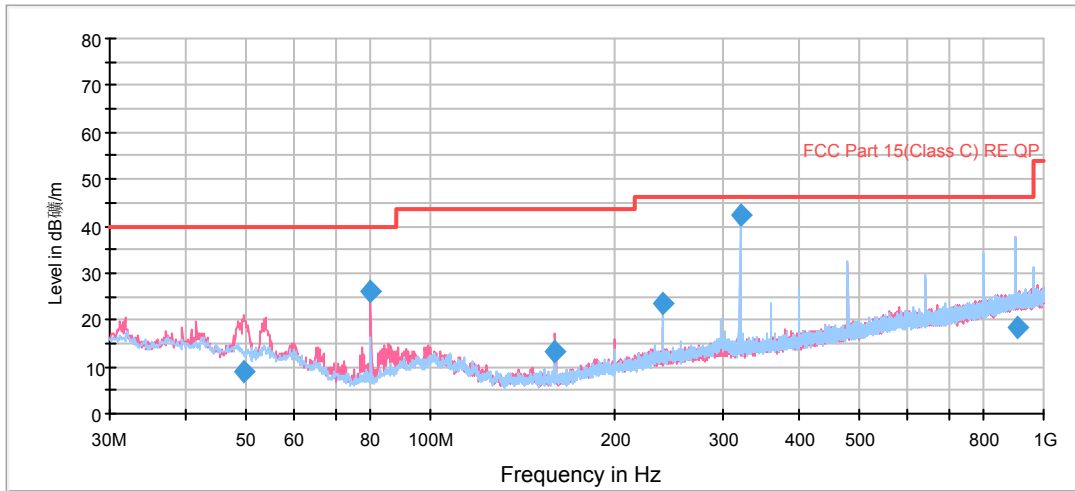

— FCC Part 15(Class C) RE QP — Preview Result 1V-PK+
— Preview Result 1H-PK+ ◆ Final Result 1-QPK

Note: This graph displays the maximum values of horizontal and vertical by software

Note: a font (Level in dBuV/m) in the test plot =(level in dBuV/m)

Radiates Emission from 30MHz to 1GHz

Frequency (MHz)	Quasi-Peak (dBuV/m)	Height (cm)	Polarization	Azimuth (deg)	Reading value (dBuV/m)	Correct Factor (dB)	Margin (dB)	Limit (dBuV/m)
49.638394	8.8	99.0	V	213.0	30.4	-21.6	31.2	40.0
79.995112	26.1	177.0	V	210.0	54.7	-28.6	13.9	40.0
159.980050	13.3	99.0	V	293.0	42.1	-28.8	30.2	43.5
240.005000	23.5	127.0	H	352.0	48.4	-24.9	22.5	46.0
319.990000	42.3	99.0	H	123.0	65.2	-22.9	3.7	46.0
904.137750	18.2	119.0	V	148.0	30.7	-12.5	27.8	46.0

Remark: 1. Quasi-Peak = Reading value + Correction factor

2. Correction Factor = Antenna factor+ Insertion loss(cable loss+amplifier gain)

3. Margin = Limit – Quasi-Peak

TA Technology (Shanghai) Co., Ltd.

Test Report

RE 1G-3GHz PK+AV

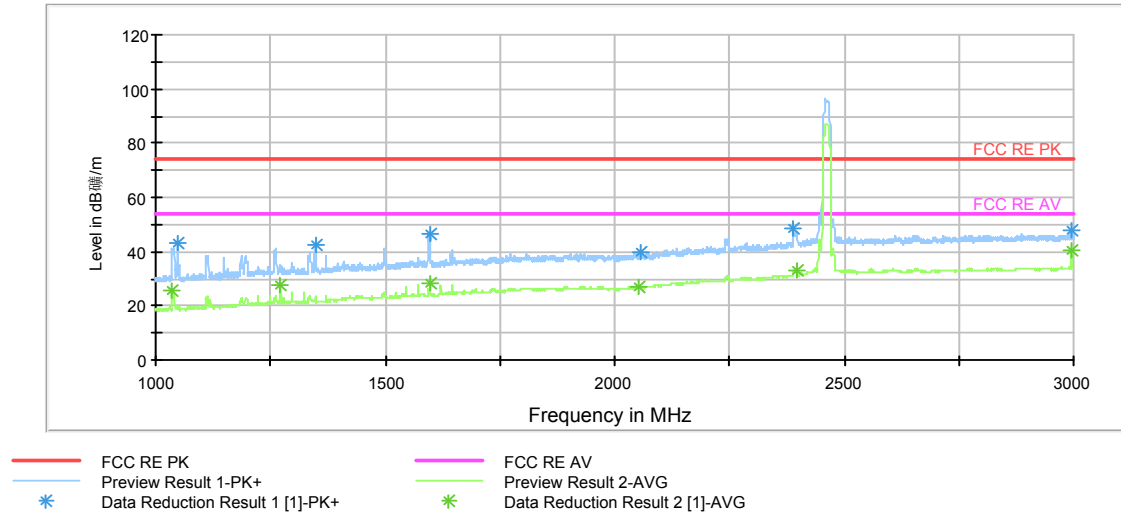

Note: This graph displays the maximum values of horizontal and vertical by software

Note: a font ($\frac{\text{Level in dBuV/m}}{\text{Height}}$) in the test plot =(level in dBuV/m)

Note: The signal beyond the limit is carrier.

Radiates Emission from 1GHz to 3GHz

Frequency (MHz)	Peak (dBuV/m)	Height (cm)	Polarization	Azimuth (deg)	Reading value (dBuV/m)	Correct Factor (dB)	Margin (dB)	Limit (dBuV/m)
1037.000000	40.3	101.0	V	0.0	51.5	-11.2	33.7	74
1272.500000	35.1	101.0	V	0.0	43.8	-8.7	38.9	74
1597.000000	44.1	101.0	V	330.0	50.1	-6.0	29.9	74
2051.500000	38.7	101.0	V	0.0	40.8	-2.1	35.3	74
2995.000000	47.8	101.0	V	0.0	52.6	-4.8	26.2	74
2397.500000	46.7	101.0	V	0.0	48.5	-1.8	27.3	74

Remark: 1. Correction Factor = Antenna factor+ Insertion loss (cable loss + amplifier gain)

Frequency (MHz)	Average (dBuV/m)	Height (cm)	Polarization	Azimuth (deg)	Reading value (dBuV/m)	Correct Factor (dB)	Margin (dB)	Limit (dBuV/m)
1037.000000	25.4	101.0	V	0.0	36.6	-11.2	28.6	54
1272.500000	27.3	101.0	V	0.0	36.0	-8.7	26.7	54
1597.000000	28.4	101.0	V	330.0	34.4	-6.0	25.6	54
2051.500000	27.3	101.0	V	0.0	29.4	-2.1	26.7	54
2995.000000	40.6	101.0	V	0.0	45.4	-4.8	13.4	54
2397.500000	32.8	101.0	V	0.0	34.6	-1.8	21.2	54

Remark: 1. Correction Factor = Antenna factor+ Insertion loss (cable loss + amplifier gain)

TA Technology (Shanghai) Co., Ltd. Test Report

Report No.: RXA1503-0042RF01R1

Page 67 of 103

RE 3-18GHz PK+AV

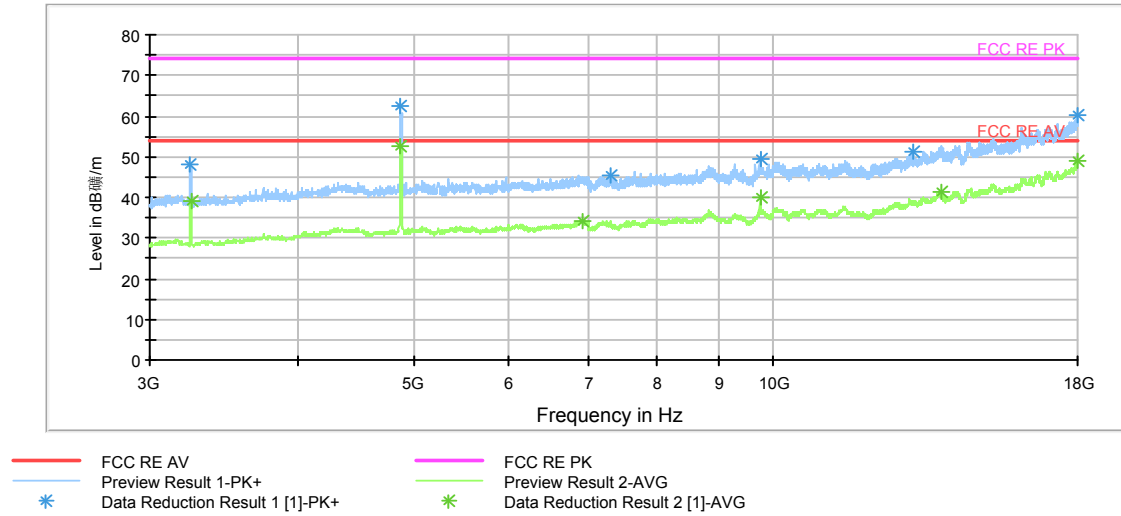

Note: This graph displays the maximum values of horizontal and vertical by software

Note: a factor ($\frac{\text{Level in dBuV/m}}{\text{Height}^2}$) in the test plot =(level in dBuV/m)

Radiates Emission from 3GHz to 18GHz

Frequency (MHz)	Peak (dBuV/m)	Height (cm)	Polarization	Azimuth (deg)	Reading value (dBuV/m)	Correct Factor (dB)	Margin (dB)	Limit (dBuV/m)
4875.000000	59.8	101.0	V	0.0	62.7	-2.9	14.2	74
17990.625000	59.3	101.0	H	123.0	83.8	-24.5	14.7	74
3249.375000	47.5	101.0	V	0.0	49.0	-1.5	26.5	74
6924.375000	44.0	101.0	V	328.0	49.7	-5.7	30.0	74
9748.125000	49.5	101.0	V	336.0	60.1	-10.6	24.5	74
13815.000000	51.0	101.0	H	181.0	66.9	-15.9	23.0	74

Remark: 1. Correction Factor = Antenna factor+ Insertion loss (cable loss + amplifier gain)

Frequency (MHz)	Average (dBuV/m)	Height (cm)	Polarization	Azimuth (deg)	Reading value (dBuV/m)	Correct Factor (dB)	Margin (dB)	Limit (dBuV/m)
4875.000000	52.7	101.0	V	0.0	55.6	-2.9	1.3	54
17990.625000	49.2	101.0	H	123.0	73.7	-24.5	4.8	54
3249.375000	39.0	101.0	V	0.0	40.5	-1.5	15.0	54
6924.375000	34.0	101.0	V	328.0	39.7	-5.7	20.0	54
9748.125000	40.1	101.0	V	336.0	50.7	-10.6	13.9	54
13815.000000	41.5	101.0	H	181.0	57.4	-15.9	12.5	54

Remark: 1. Correction Factor = Antenna factor+ Insertion loss (cable loss + amplifier gain)

TA Technology (Shanghai) Co., Ltd. Test Report

Report No.: RXA1503-0042RF01R1

Page 68 of 103

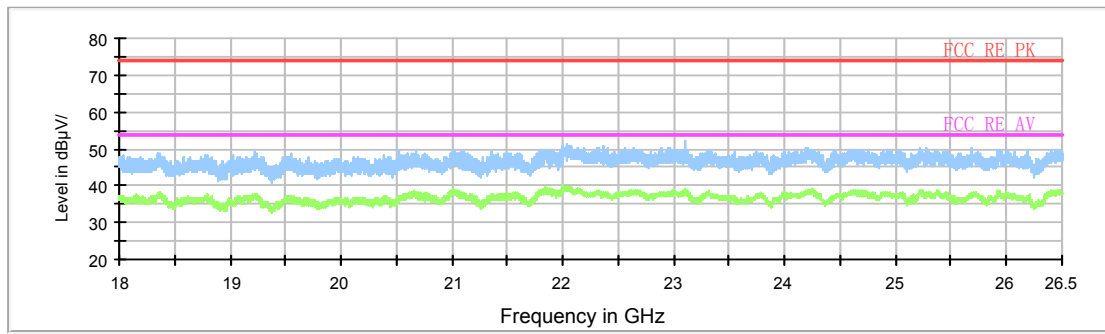

Note: This graph displays the maximum values of horizontal and vertical by software

Note: a font (Level in dBuV/m) in the test plot =(level in dBuV/m)

Radiates Emission from 18GHz to 26.5GHz

TA Technology (Shanghai) Co., Ltd. Test Report

802.11g CH1

RE 30M-1GHz QP

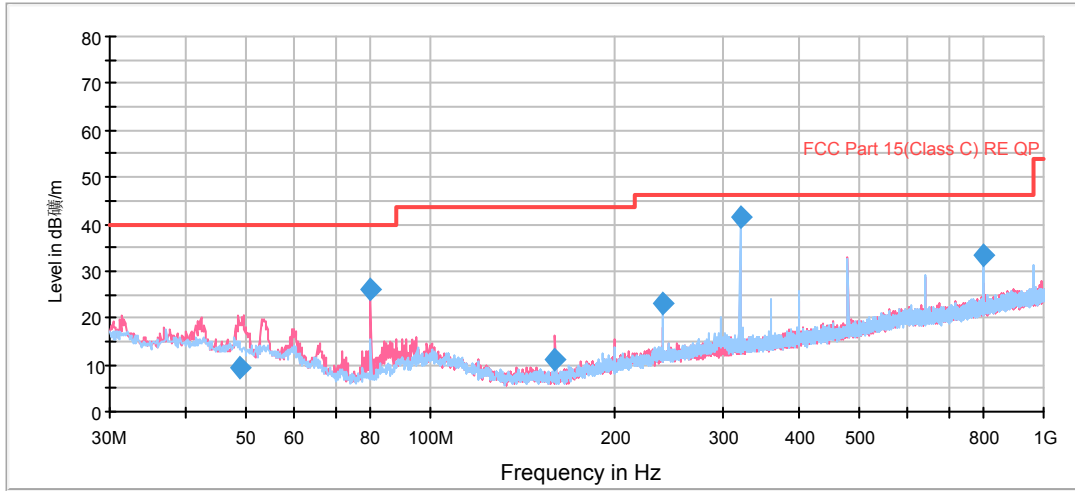

— FCC Part 15(Class C) RE QP — Preview Result 1V-PK+
— Preview Result 1H-PK+ ◆ Final Result 1-QPK

Note: This graph displays the maximum values of horizontal and vertical by software

Note: a font (Level in dBuV/m) in the test plot =(level in dBuV/m)

Radiates Emission from 30MHz to 1GHz

Frequency (MHz)	Quasi-Peak (dBuV/m)	Height (cm)	Polarization	Azimuth (deg)	Reading value (dBuV/m)	Correct Factor (dB)	Margin (dB)	Limit (dBuV/m)
48.750819	9.6	99.0	V	129.0	31.0	-21.4	30.4	40.0
79.995112	26.2	177.0	V	206.0	54.8	-28.6	13.8	40.0
159.980050	11.0	99.0	V	301.0	39.8	-28.8	32.5	43.5
240.005000	23.1	127.0	H	350.0	48.0	-24.9	22.9	46.0
319.990000	41.4	101.0	H	127.0	64.3	-22.9	4.6	46.0
799.978750	33.2	99.0	H	28.0	47.4	-14.2	12.8	46.0

Remark: 1. Quasi-Peak = Reading value + Correction factor

2. Correction Factor = Antenna factor+ Insertion loss(cable loss+amplifier gain)

3. Margin = Limit – Quasi-Peak

TA Technology (Shanghai) Co., Ltd. Test Report

RE 1G-3GHz PK+AV

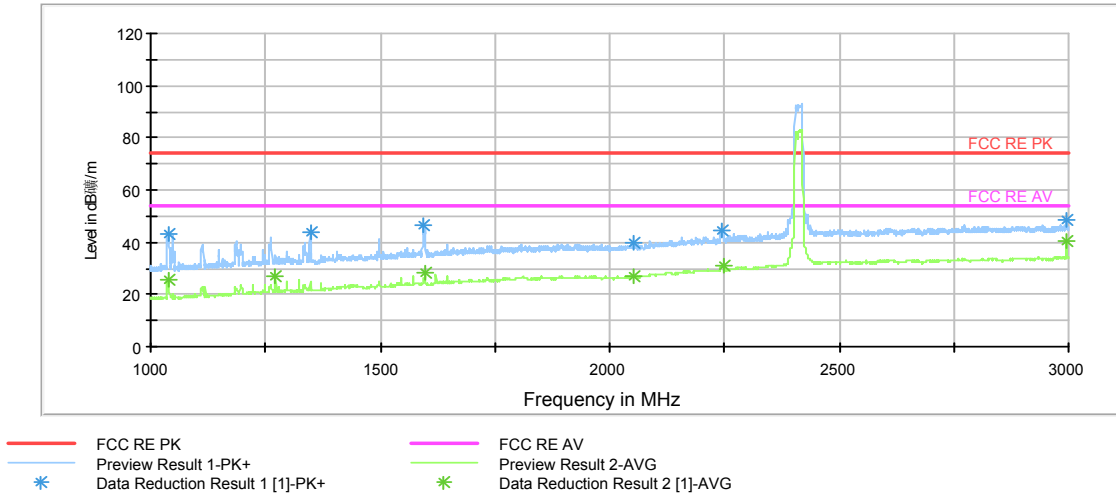

Note: This graph displays the maximum values of horizontal and vertical by software

Note: a font ($\frac{\text{Level in dB}\mu\text{V/m}}{\text{Height}}$) in the test plot =(level in dBuV/m)

Note: The signal beyond the limit is carrier.

Radiates Emission from 1GHz to 3GHz

Frequency (MHz)	Peak (dBuV/m)	Height (cm)	Polarization	Azimuth (deg)	Reading value (dBuV/m)	Correct Factor (dB)	Margin (dB)	Limit (dBuV/m)
1037.500000	41.3	101.0	V	170.0	52.5	-11.2	32.7	74
1272.500000	35.2	101.0	V	0.0	43.9	-8.7	38.8	74
1597.000000	43.7	101.0	V	291.0	49.7	-6.0	30.3	74
2053.000000	37.8	101.0	H	0.0	39.9	-2.1	36.2	74
2995.000000	48.8	101.0	V	330.0	53.6	-4.8	25.2	74
2248.000000	43.9	101.0	H	310.0	44.0	-0.1	30.1	74

Remark: 1. Correction Factor = Antenna factor+ Insertion loss (cable loss + amplifier gain)

Frequency (MHz)	Average (dBuV/m)	Height (cm)	Polarization	Azimuth (deg)	Reading value (dBuV/m)	Correct Factor (dB)	Margin (dB)	Limit (dBuV/m)
1037.500000	25.7	101.0	V	170.0	36.9	-11.2	28.3	54
1272.500000	27.2	101.0	V	0.0	35.9	-8.7	26.8	54
1597.000000	28.6	101.0	V	291.0	34.6	-6.0	25.4	54
2053.000000	27.3	101.0	H	0.0	29.4	-2.1	26.7	54
2995.000000	40.4	101.0	V	330.0	45.2	-4.8	13.6	54
2248.000000	30.9	101.0	H	310.0	31.0	-0.1	23.1	54

Remark: 1. Correction Factor = Antenna factor+ Insertion loss (cable loss + amplifier gain)

TA Technology (Shanghai) Co., Ltd. Test Report

RE 3-18GHz PK+AV

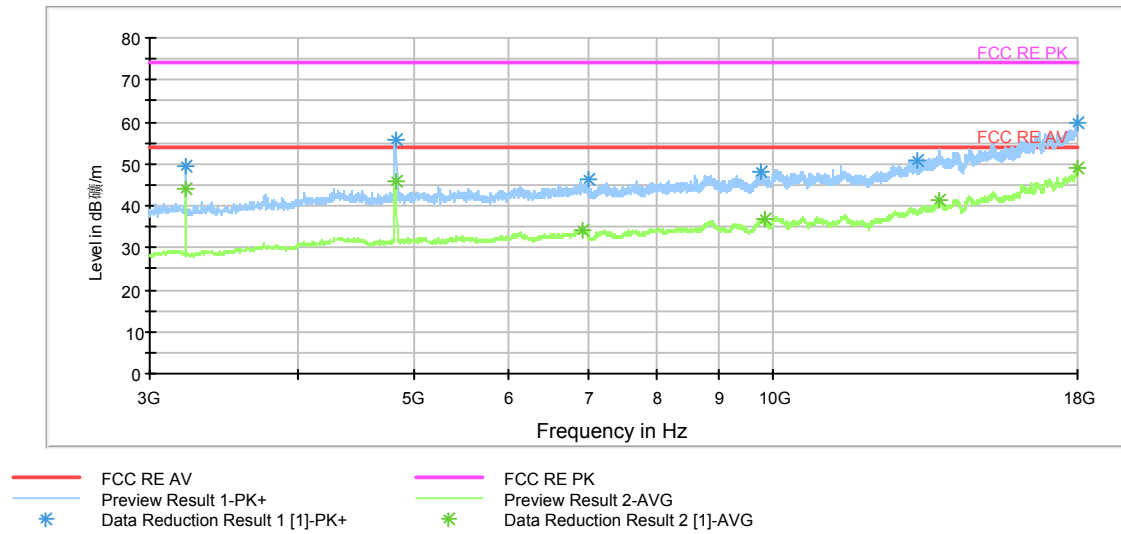

Note: This graph displays the maximum values of horizontal and vertical by software

Note: a font (Level in dB μ V/m) in the test plot =(level in dBuV/m)

Radiates Emission from 3GHz to 18GHz

Frequency (MHz)	Peak (dBuV/m)	Height (cm)	Polarization	Azimuth (deg)	Reading value (dBuV/m)	Correct Factor (dB)	Margin (dB)	Limit (dBuV/m)
3215.625000	49.5	101.0	V	355.0	51.2	-1.7	24.5	74
4824.375000	55.3	101.0	V	0.0	57.9	-2.6	18.7	74
18000.000000	58.5	101.0	V	0.0	83.2	-24.7	15.5	74
6918.750000	43.8	101.0	V	0.0	49.5	-5.7	30.2	74
9841.875000	47.5	101.0	V	267.0	58.5	-11.0	26.5	74
13786.875000	53.3	101.0	V	338.0	69.0	-15.7	20.7	74

Remark: 1. Correction Factor = Antenna factor+ Insertion loss (cable loss + amplifier gain)

Frequency (MHz)	Average (dBuV/m)	Height (cm)	Polarization	Azimuth (deg)	Reading value (dBuV/m)	Correct Factor (dB)	Margin (dB)	Limit (dBuV/m)
3215.625000	44.1	101.0	V	355.0	45.8	-1.7	9.9	54
4824.375000	46.0	101.0	V	0.0	48.6	-2.6	8.0	54
18000.000000	49.2	101.0	V	0.0	73.9	-24.7	4.8	54
6918.750000	34.0	101.0	V	0.0	39.7	-5.7	20.0	54
9841.875000	36.8	101.0	V	267.0	47.8	-11.0	17.2	54
13786.875000	41.5	101.0	V	338.0	57.2	-15.7	12.5	54

Remark: 1. Correction Factor = Antenna factor+ Insertion loss (cable loss + amplifier gain)

TA Technology (Shanghai) Co., Ltd. Test Report

Report No.: RXA1503-0042RF01R1

Page 72 of 103

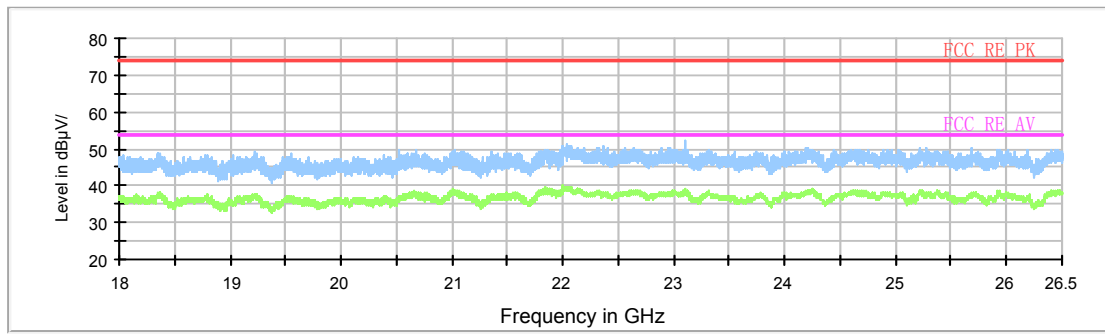

- FCC RE PK.LimitLine
- FCC RE AV.LimitLine
- Preview Result 1
- Preview Result 2
- Data Reduction Result 1 [1]
- Data Reduction Result 2 [1]

Note: This graph displays the maximum values of horizontal and vertical by software

Note: a font (Level in dBuV/m) in the test plot =(level in dBuV/m)

Radiates Emission from 18GHz to 26.5GHz

TA Technology (Shanghai) Co., Ltd. Test Report

802.11g CH6

RE 30M-1GHz QP

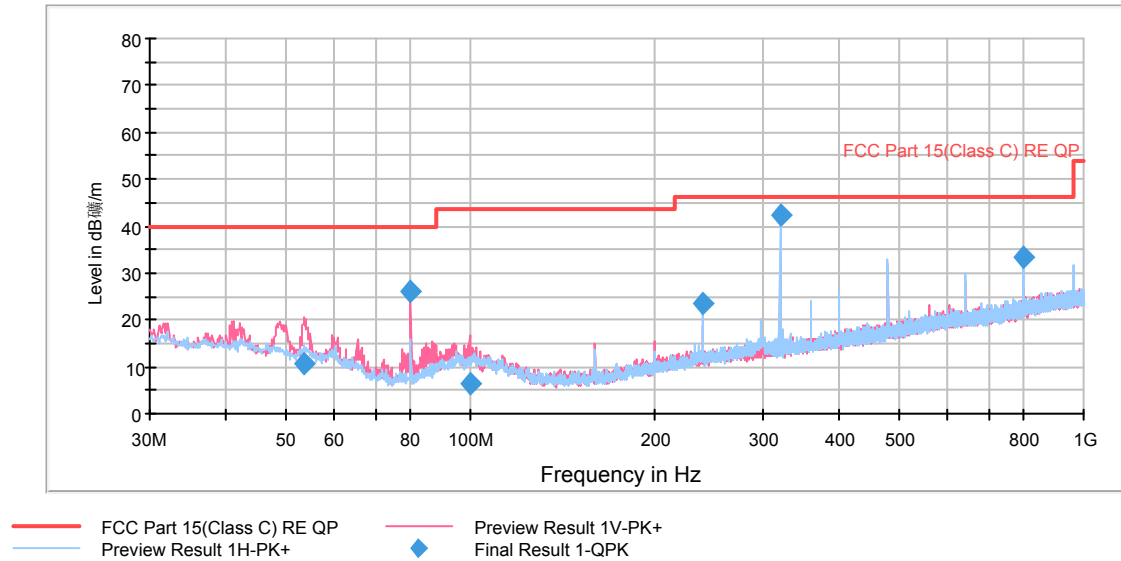

Note: This graph displays the maximum values of horizontal and vertical by software

Note: a font (Level in dBuV/m) in the test plot =(level in dBuV/m)

Radiates Emission from 30MHz to 1GHz

Frequency (MHz)	Quasi-Peak (dBuV/m)	Height (cm)	Polarization	Azimuth (deg)	Reading value (dBuV/m)	Correct Factor (dB)	Margin (dB)	Limit (dBuV/m)
53.508694	10.5	99.0	V	112.0	32.7	-22.2	29.5	40.0
79.995112	26.2	197.0	V	199.0	54.8	-28.6	13.8	40.0
99.968047	6.2	99.0	V	15.0	30.8	-24.6	37.3	43.5
240.005000	23.3	127.0	H	351.0	48.2	-24.9	22.7	46.0
319.990000	42.1	99.0	H	116.0	65.0	-22.9	3.9	46.0
799.978750	33.6	99.0	H	34.0	47.8	-14.2	12.4	46.0

Remark: 1. Quasi-Peak = Reading value + Correction factor

2. Correction Factor = Antenna factor+ Insertion loss(cable loss+amplifier gain)

3. Margin = Limit – Quasi-Peak

TA Technology (Shanghai) Co., Ltd.

Test Report

RE 1G-3GHz PK+AV

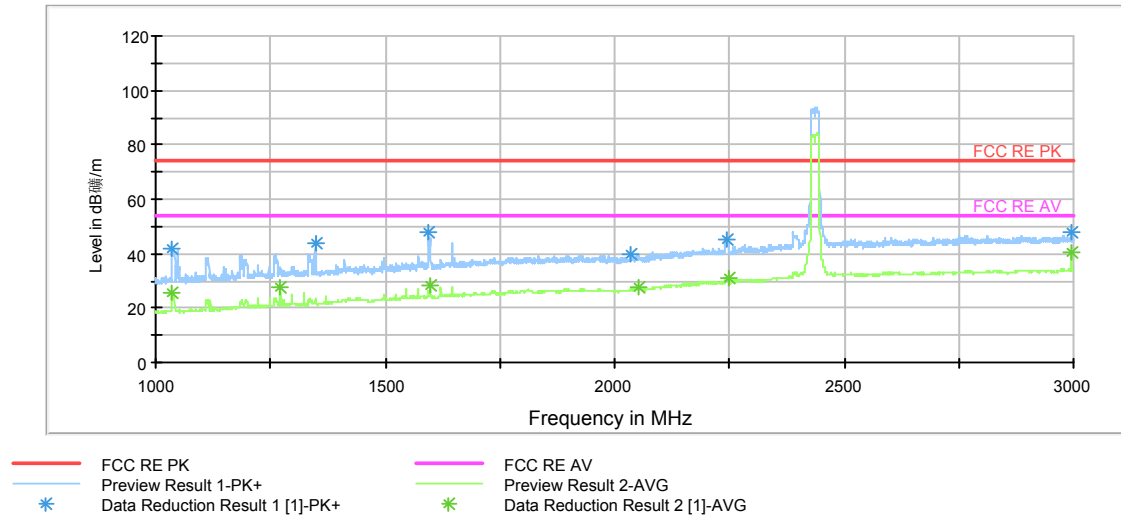

Note: This graph displays the maximum values of horizontal and vertical by software

Note: a font ($\text{Level in dB}\frac{\mu\text{V}}{\text{m}}$) in the test plot =(level in dBuV/m)

Note: The signal beyond the limit is carrier.

Radiates Emission from 1GHz to 3GHz

Frequency (MHz)	Peak (dBuV/m)	Height (cm)	Polarization	Azimuth (deg)	Reading value (dBuV/m)	Correct Factor (dB)	Margin (dB)	Limit (dBuV/m)
1037.000000	41.9	101.0	V	0.0	53.1	-11.2	32.1	74
1272.500000	35.3	101.0	V	209.0	44.0	-8.7	38.7	74
1597.000000	45.9	101.0	V	329.0	51.9	-6.0	28.1	74
2053.000000	37.8	101.0	V	0.0	39.9	-2.1	36.2	74
2995.000000	47.8	101.0	V	329.0	52.6	-4.8	26.2	74
2247.000000	44.3	101.0	H	311.0	44.4	-0.1	29.7	74

Remark: 1. Correction Factor = Antenna factor+ Insertion loss (cable loss + amplifier gain)

Frequency (MHz)	Average (dBuV/m)	Height (cm)	Polarization	Azimuth (deg)	Reading value (dBuV/m)	Correct Factor (dB)	Margin (dB)	Limit (dBuV/m)
1037.000000	25.5	101.0	V	0.0	36.7	-11.2	28.5	54
1272.500000	27.6	101.0	V	209.0	36.3	-8.7	26.4	54
1597.000000	28.2	101.0	V	329.0	34.2	-6.0	25.8	54
2053.000000	27.4	101.0	V	0.0	29.5	-2.1	26.6	54
2995.000000	40.5	101.0	V	329.0	45.3	-4.8	13.5	54
2247.000000	31.2	101.0	H	311.0	31.3	-0.1	22.8	54

Remark: 1. Correction Factor = Antenna factor+ Insertion loss (cable loss + amplifier gain)

TA Technology (Shanghai) Co., Ltd. Test Report

Report No.: RXA1503-0042RF01R1

Page 75 of 103

RE 3-18GHz PK+AV

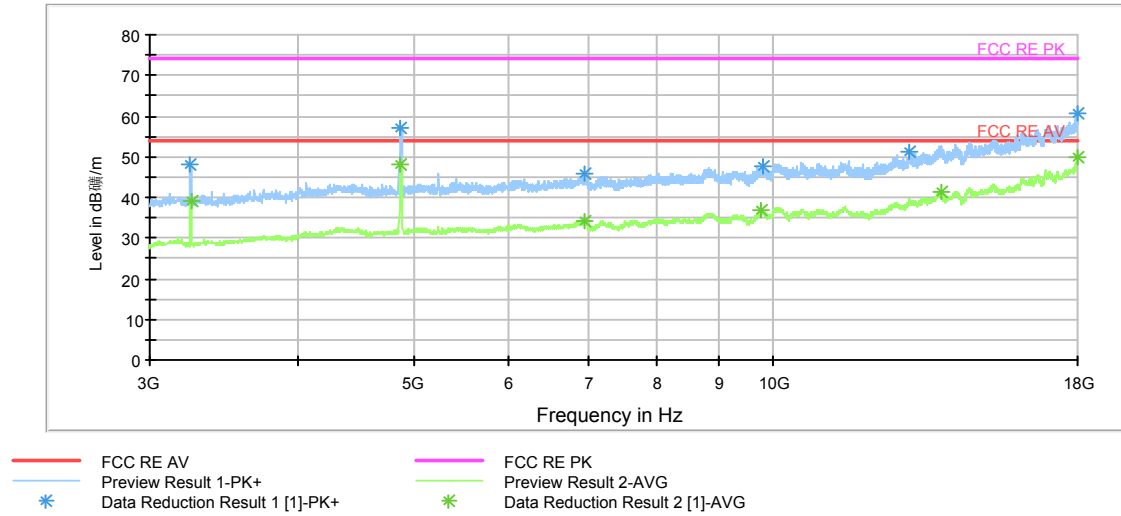

Note: This graph displays the maximum values of horizontal and vertical by software

Note: a factor ($\frac{\text{Level in dBuV/m}}{\text{Height}^2}$) in the test plot =(level in dBuV/m)

Radiates Emission from 3GHz to 18GHz

Frequency (MHz)	Peak (dBuV/m)	Height (cm)	Polarization	Azimuth (deg)	Reading value (dBuV/m)	Correct Factor (dB)	Margin (dB)	Limit (dBuV/m)
4873.125000	57.2	101.0	V	0.0	60.1	-2.9	16.8	74
17994.375000	58.6	101.0	H	218.0	83.2	-24.6	15.4	74
3249.375000	47.8	101.0	V	0.0	49.3	-1.5	26.2	74
6958.125000	44.4	101.0	H	38.0	49.9	-5.5	29.6	74
9750.000000	45.5	101.0	H	20.0	56.1	-10.6	28.5	74
13822.500000	51.1	101.0	V	286.0	67.0	-15.9	22.9	74

Remark: 1. Correction Factor = Antenna factor+ Insertion loss (cable loss + amplifier gain)

Frequency (MHz)	Average (dBuV/m)	Height (cm)	Polarization	Azimuth (deg)	Reading value (dBuV/m)	Correct Factor (dB)	Margin (dB)	Limit (dBuV/m)
4873.125000	48.0	101.0	V	0.0	50.9	-2.9	6.0	54
17994.375000	49.8	101.0	H	218.0	74.4	-24.6	4.2	54
3249.375000	38.9	101.0	V	0.0	40.4	-1.5	15.1	54
6958.125000	34.3	101.0	H	38.0	39.8	-5.5	19.7	54
9750.000000	36.9	101.0	H	20.0	47.5	-10.6	17.1	54
13822.500000	41.4	101.0	V	286.0	57.3	-15.9	12.6	54

Remark: 1. Correction Factor = Antenna factor+ Insertion loss (cable loss + amplifier gain)

TA Technology (Shanghai) Co., Ltd. Test Report

Report No.: RXA1503-0042RF01R1

Page 76 of 103

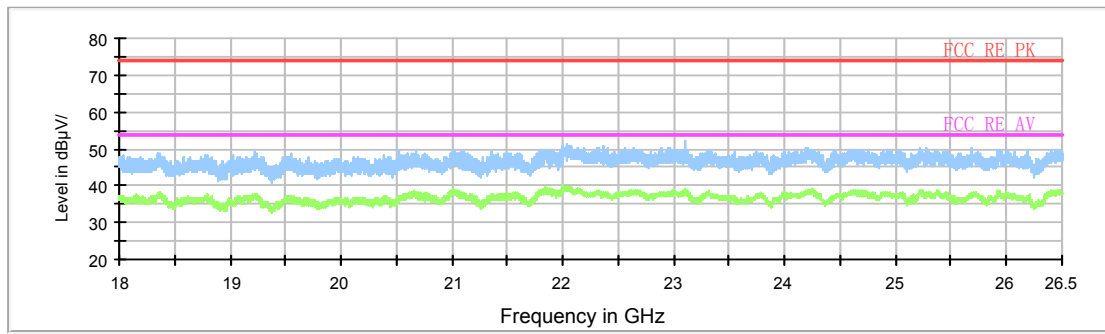

Note: This graph displays the maximum values of horizontal and vertical by software

Note: a font (Level in dBuV/m) in the test plot =(level in dBuV/m)

Radiates Emission from 18GHz to 26.5GHz

TA Technology (Shanghai) Co., Ltd. Test Report

802.11g CH11

RE 30M-1GHz QP

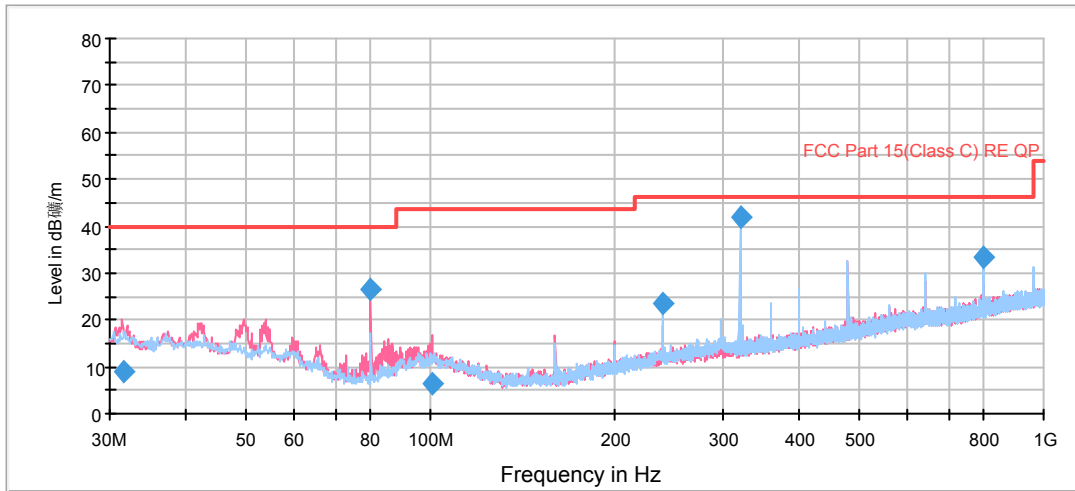

— FCC Part 15(Class C) RE QP — Preview Result 1V-PK+
— Preview Result 1H-PK+ ◆ Final Result 1-QPK

Note: This graph displays the maximum values of horizontal and vertical by software

Note: a font (Level in dBuV/m) in the test plot =(level in dBuV/m)

Radiates Emission from 30MHz to 1GHz

Frequency (MHz)	Quasi-Peak (dBuV/m)	Height (cm)	Polarization	Azimuth (deg)	Reading value (dBuV/m)	Correct Factor (dB)	Margin (dB)	Limit (dBuV/m)
31.533638	9.0	99.0	V	293.0	27.0	-18.0	31.0	40.0
79.995112	26.3	177.0	V	193.0	54.9	-28.6	13.7	40.0
100.837975	6.6	99.0	V	286.0	31.3	-24.7	36.9	43.5
240.005000	23.3	118.0	H	350.0	48.2	-24.9	22.7	46.0
319.990000	41.9	99.0	H	127.0	64.8	-22.9	4.1	46.0
799.978750	33.4	99.0	H	35.0	47.6	-14.2	12.6	46.0

Remark: 1. Quasi-Peak = Reading value + Correction factor

2. Correction Factor = Antenna factor+ Insertion loss(cable loss+amplifier gain)

3. Margin = Limit – Quasi-Peak

TA Technology (Shanghai) Co., Ltd. Test Report

RE 1G-3GHz PK+AV

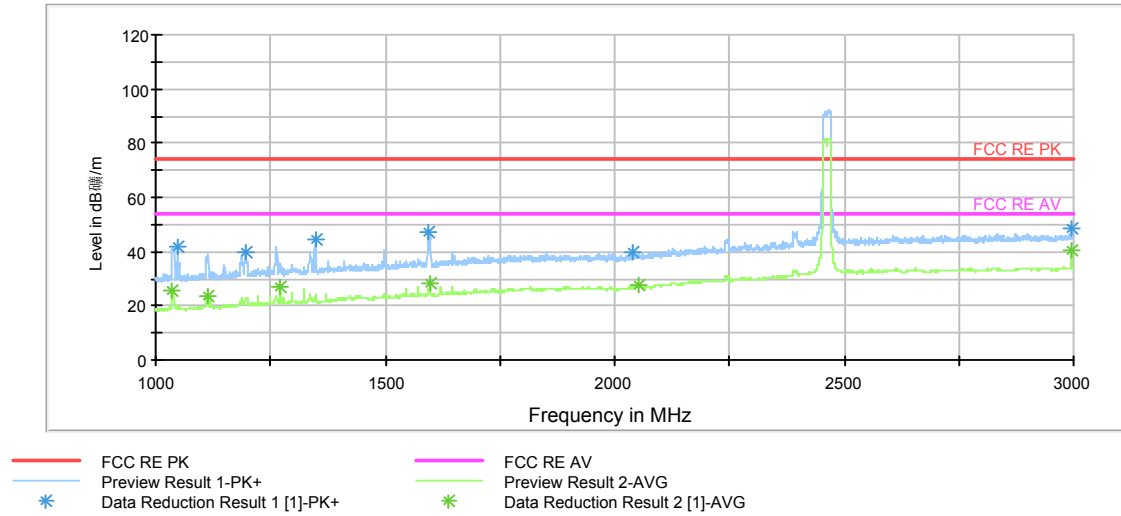

Note: This graph displays the maximum values of horizontal and vertical by software

Note: a font ($\text{Level in dB}\frac{\mu\text{V}}{\text{m}}$) in the test plot =(level in dBuV/m)

Note: The signal beyond the limit is carrier.

Radiates Emission from 1GHz to 3GHz

Frequency (MHz)	Peak (dBuV/m)	Height (cm)	Polarization	Azimuth (deg)	Reading value (dBuV/m)	Correct Factor (dB)	Margin (dB)	Limit (dBuV/m)
1037.000000	41.1	101.0	V	171.0	52.3	-11.2	32.9	74
1272.500000	35.7	101.0	V	0.0	44.4	-8.7	38.3	74
1597.000000	44.5	101.0	V	331.0	50.5	-6.0	29.5	74
2052.000000	37.7	101.0	V	0.0	39.8	-2.1	36.3	74
2995.000000	47.9	101.0	V	251.0	52.7	-4.8	26.1	74
1111.500000	38.2	101.0	V	0.0	48.6	-10.4	35.8	74

Remark: 1. Correction Factor = Antenna factor+ Insertion loss (cable loss + amplifier gain)

Frequency (MHz)	Average (dBuV/m)	Height (cm)	Polarization	Azimuth (deg)	Reading value (dBuV/m)	Correct Factor (dB)	Margin (dB)	Limit (dBuV/m)
1037.000000	25.8	101.0	V	171.0	37.0	-11.2	28.2	54
1272.500000	26.7	101.0	V	0.0	35.4	-8.7	27.3	54
1597.000000	28.2	101.0	V	331.0	34.2	-6.0	25.8	54
2052.000000	27.4	101.0	V	0.0	29.5	-2.1	26.6	54
2995.000000	40.7	101.0	V	251.0	45.5	-4.8	13.3	54
1111.500000	23.4	101.0	V	0.0	33.8	-10.4	30.6	54

Remark: 1. Correction Factor = Antenna factor+ Insertion loss (cable loss + amplifier gain)

TA Technology (Shanghai) Co., Ltd. Test Report

RE 3-18GHz PK+AV

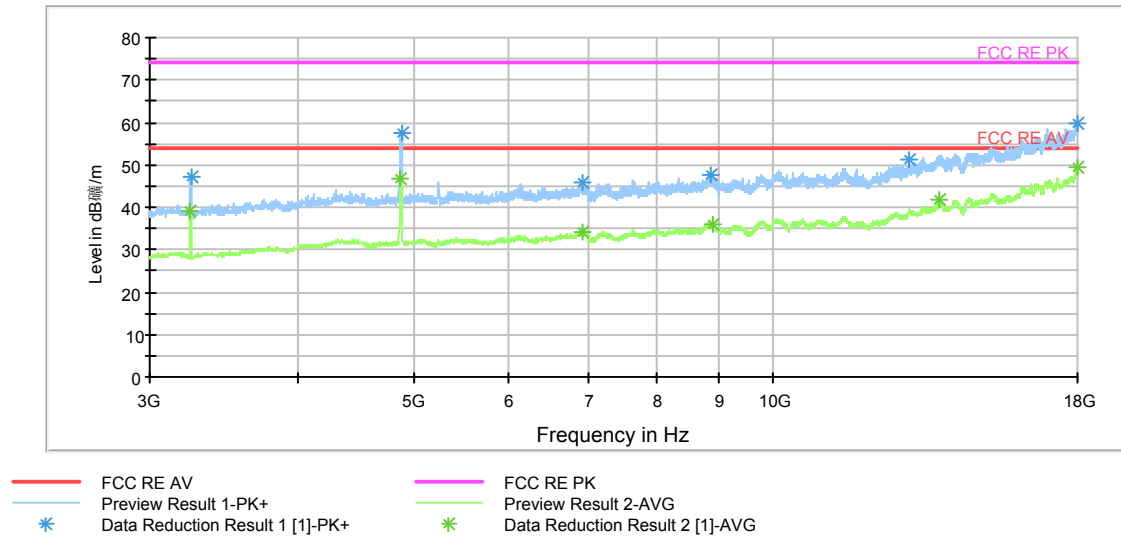

Note: This graph displays the maximum values of horizontal and vertical by software
 Note: a font (Level in dBuV/m) in the test plot =(level in dBuV/m)
 Radiates Emission from 3GHz to 18GHz

Frequency (MHz)	Peak (dBuV/m)	Height (cm)	Polarization	Azimuth (deg)	Reading value (dBuV/m)	Correct Factor (dB)	Margin (dB)	Limit (dBuV/m)
4875.000000	55.0	101.0	V	7.0	57.9	-2.9	19.0	74
18000.000000	58.1	101.0	H	157.0	82.8	-24.7	15.9	74
3247.500000	47.3	101.0	V	0.0	48.8	-1.5	26.7	74
6924.375000	43.5	101.0	V	339.0	49.2	-5.7	30.5	74
8906.250000	45.9	101.0	V	193.0	56.0	-10.1	28.1	74
13807.500000	51.2	101.0	V	0.0	67.1	-15.9	22.8	74

Remark: 1. Correction Factor = Antenna factor+ Insertion loss (cable loss + amplifier gain)

Frequency (MHz)	Average (dBuV/m)	Height (cm)	Polarization	Azimuth (deg)	Reading value (dBuV/m)	Correct Factor (dB)	Margin (dB)	Limit (dBuV/m)
4875.000000	46.7	101.0	V	7.0	49.6	-2.9	7.3	54
18000.000000	49.3	101.0	H	157.0	74.0	-24.7	4.7	54
3247.500000	38.9	101.0	V	0.0	40.4	-1.5	15.1	54
6924.375000	34.4	101.0	V	339.0	40.1	-5.7	19.6	54
8906.250000	35.9	101.0	V	193.0	46.0	-10.1	18.1	54
13807.500000	41.6	101.0	V	0.0	57.5	-15.9	12.4	54

Remark: 1. Correction Factor = Antenna factor+ Insertion loss (cable loss + amplifier gain)

TA Technology (Shanghai) Co., Ltd. Test Report

Report No.: RXA1503-0042RF01R1

Page 80 of 103

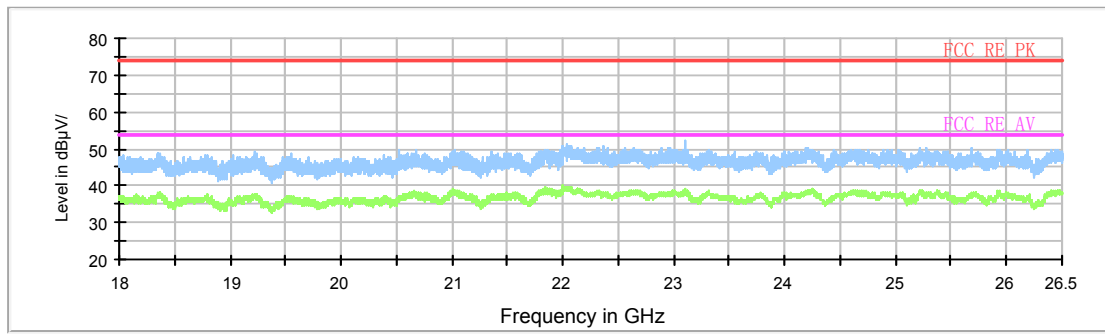

- FCC RE PK.LimitLine
- FCC RE AV.LimitLine
- Preview Result 1
- Preview Result 2
- Data Reduction Result 1 [1]
- Data Reduction Result 2 [1]

Note: This graph displays the maximum values of horizontal and vertical by software

Note: a font (Level in dBuV/m) in the test plot =(level in dBuV/m)

Radiates Emission from 18GHz to 26.5GHz

TA Technology (Shanghai) Co., Ltd. Test Report

802.11n(HT20) CH1

RE 30M-1GHz QP

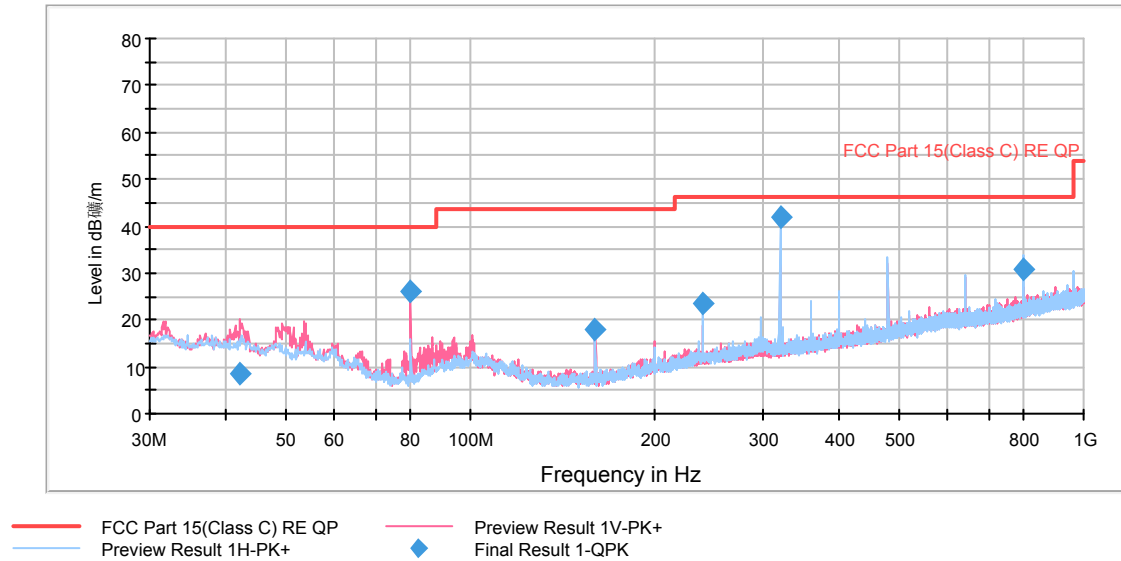

Note: This graph displays the maximum values of horizontal and vertical by software

Note: a font (Level in dBuV/m) in the test plot =(level in dBuV/m)

Radiates Emission from 30MHz to 1GHz

Frequency (MHz)	Quasi-Peak (dBuV/m)	Height (cm)	Polarization	Azimuth (deg)	Reading value (dBuV/m)	Correct Factor (dB)	Margin (dB)	Limit (dBuV/m)
42.099688	8.7	99.0	V	156.0	28.6	-19.9	31.3	40.0
79.995112	26.3	198.0	V	192.0	54.9	-28.6	13.7	40.0
159.980050	17.8	99.0	V	293.0	46.6	-28.8	25.7	43.5
240.005000	23.6	118.0	H	345.0	48.5	-24.9	22.4	46.0
319.990000	42.1	99.0	H	122.0	65.0	-22.9	3.9	46.0
799.978750	30.9	121.0	H	42.0	45.1	-14.2	15.1	46.0

Remark: 1. Quasi-Peak = Reading value + Correction factor

2. Correction Factor = Antenna factor+ Insertion loss(cable loss+amplifier gain)

3. Margin = Limit – Quasi-Peak

TA Technology (Shanghai) Co., Ltd.

Test Report

RE 1G-3GHz PK+AV

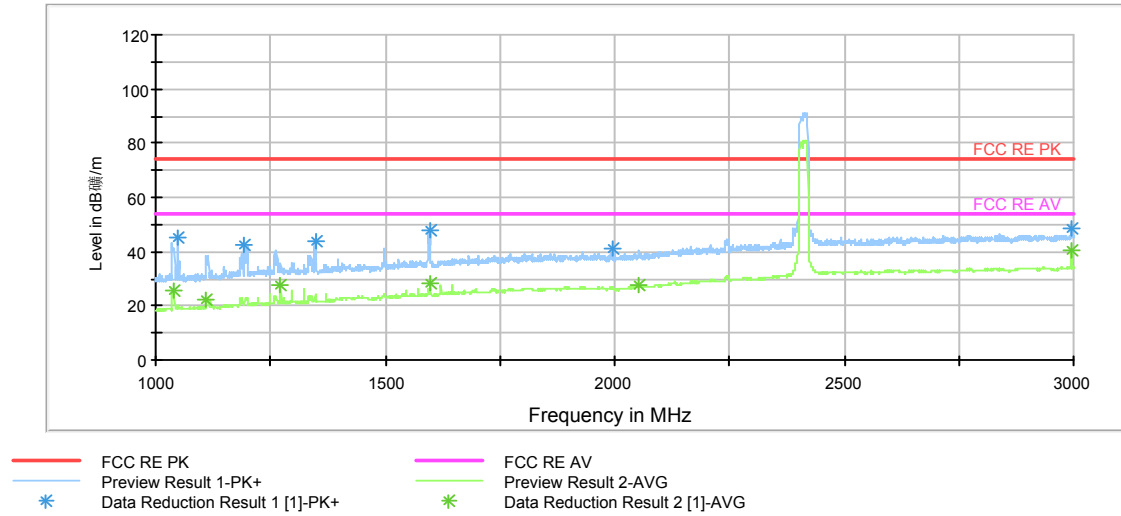

Note: This graph displays the maximum values of horizontal and vertical by software

Note: a font ($\text{Level in dB}\frac{\mu\text{V}}{\text{m}}$) in the test plot =(level in dBuV/m)

Note: The signal beyond the limit is carrier.

Radiates Emission from 1GHz to 3GHz

Frequency (MHz)	Peak (dBuV/m)	Height (cm)	Polarization	Azimuth (deg)	Reading value (dBuV/m)	Correct Factor (dB)	Margin (dB)	Limit (dBuV/m)
1038.000000	41.1	101.0	V	170.0	52.3	-11.2	32.9	74
1272.500000	35.7	101.0	V	210.0	44.4	-8.7	38.3	74
1597.000000	42.2	101.0	V	290.0	48.2	-6.0	31.8	74
2052.000000	37.4	101.0	H	270.0	39.5	-2.1	36.6	74
2995.000000	48.6	101.0	V	330.0	53.4	-4.8	25.4	74
1111.000000	38.4	101.0	V	250.0	48.8	-10.4	35.6	74

Remark: 1. Correction Factor = Antenna factor+ Insertion loss (cable loss + amplifier gain)

Frequency (MHz)	Average (dBuV/m)	Height (cm)	Polarization	Azimuth (deg)	Reading value (dBuV/m)	Correct Factor (dB)	Margin (dB)	Limit (dBuV/m)
1038.000000	25.7	101.0	V	170.0	28.6	-11.2	28.3	54
1272.500000	27.5	101.0	V	210.0	52.2	-8.7	26.5	54
1597.000000	28.3	101.0	V	290.0	29.8	-6.0	25.7	54
2052.000000	27.4	101.0	H	270.0	33.1	-2.1	26.6	54
2995.000000	40.7	101.0	V	330.0	50.8	-4.8	13.3	54
1111.000000	22.5	101.0	V	250.0	38.4	-10.4	31.5	54

Remark: 1. Correction Factor = Antenna factor+ Insertion loss (cable loss + amplifier gain)

TA Technology (Shanghai) Co., Ltd. Test Report

RE 3-18GHz PK+AV

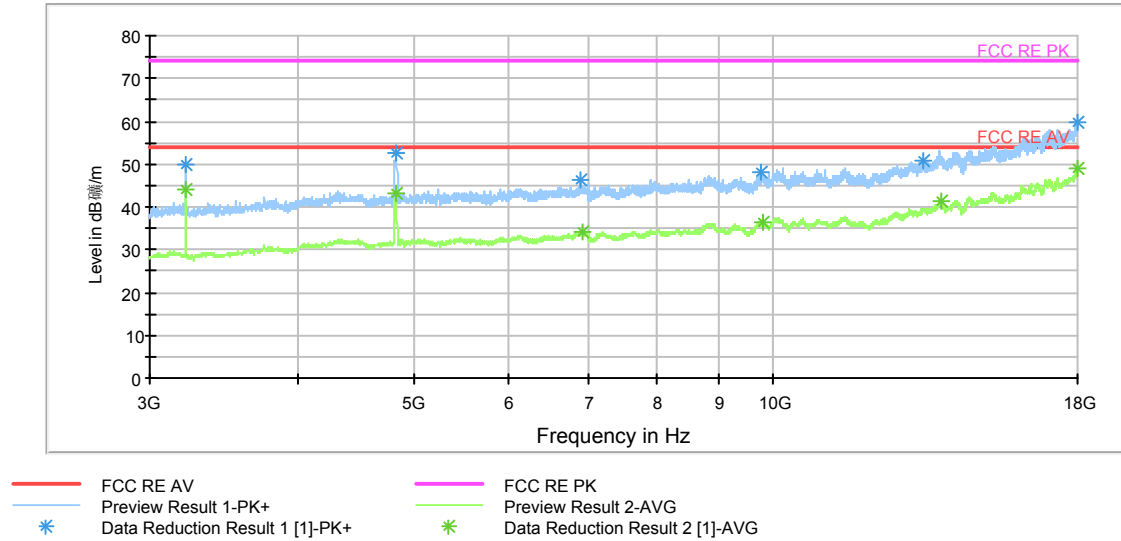

Note: This graph displays the maximum values of horizontal and vertical by software
 Note: a font (Level in dBuV/m) in the test plot =(level in dBuV/m)
 Radiates Emission from 3GHz to 18GHz

Frequency (MHz)	Peak (dBuV/m)	Height (cm)	Polarization	Azimuth (deg)	Reading value (dBuV/m)	Correct Factor (dB)	Margin (dB)	Limit (dBuV/m)
3215.625000	49.9	101.0	V	0.0	51.6	-1.7	24.1	74
17988.750000	58.8	101.0	V	0.0	83.3	-24.5	15.2	74
4824.375000	52.0	101.0	V	0.0	54.6	-2.6	22.0	74
6926.250000	44.0	101.0	V	97.0	49.7	-5.7	30.0	74
9804.375000	45.8	101.0	H	65.0	57.1	-11.3	28.2	74
13813.125000	50.9	101.0	V	0.0	66.8	-15.9	23.1	74

Remark: 1. Correction Factor = Antenna factor+ Insertion loss (cable loss + amplifier gain)

Frequency (MHz)	Average (dBuV/m)	Height (cm)	Polarization	Azimuth (deg)	Reading value (dBuV/m)	Correct Factor (dB)	Margin (dB)	Limit (dBuV/m)
3215.625000	44.0	101.0	V	0.0	45.7	-1.7	10.0	54
17988.750000	49.2	101.0	V	0.0	73.7	-24.5	4.8	54
4824.375000	43.1	101.0	V	0.0	45.7	-2.6	10.9	54
6926.250000	34.4	101.0	V	97.0	40.1	-5.7	19.6	54
9804.375000	36.6	101.0	H	65.0	47.9	-11.3	17.4	54
13813.125000	41.2	101.0	V	0.0	57.1	-15.9	12.8	54

Remark: 1. Correction Factor = Antenna factor+ Insertion loss (cable loss + amplifier gain)

TA Technology (Shanghai) Co., Ltd. Test Report

Report No.: RXA1503-0042RF01R1

Page 84 of 103

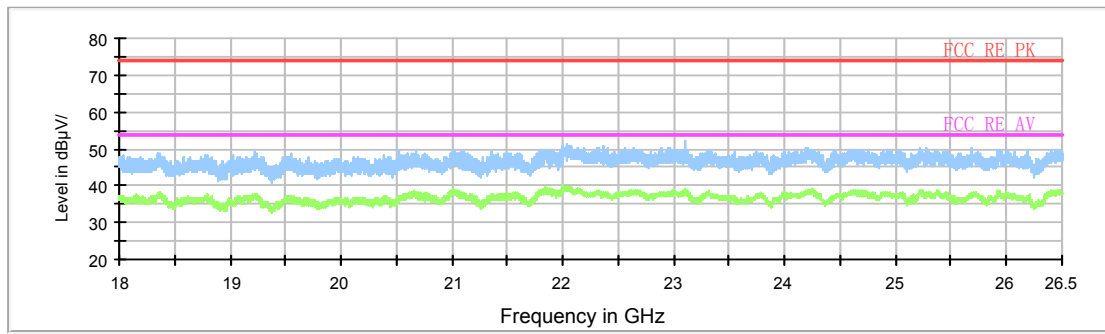

Note: This graph displays the maximum values of horizontal and vertical by software

Note: a font (Level in dBuV/m) in the test plot =(level in dBuV/m)

Radiates Emission from 18GHz to 26.5GHz

TA Technology (Shanghai) Co., Ltd. Test Report

802.11n(HT20) CH6

RE 30M-1GHz QP

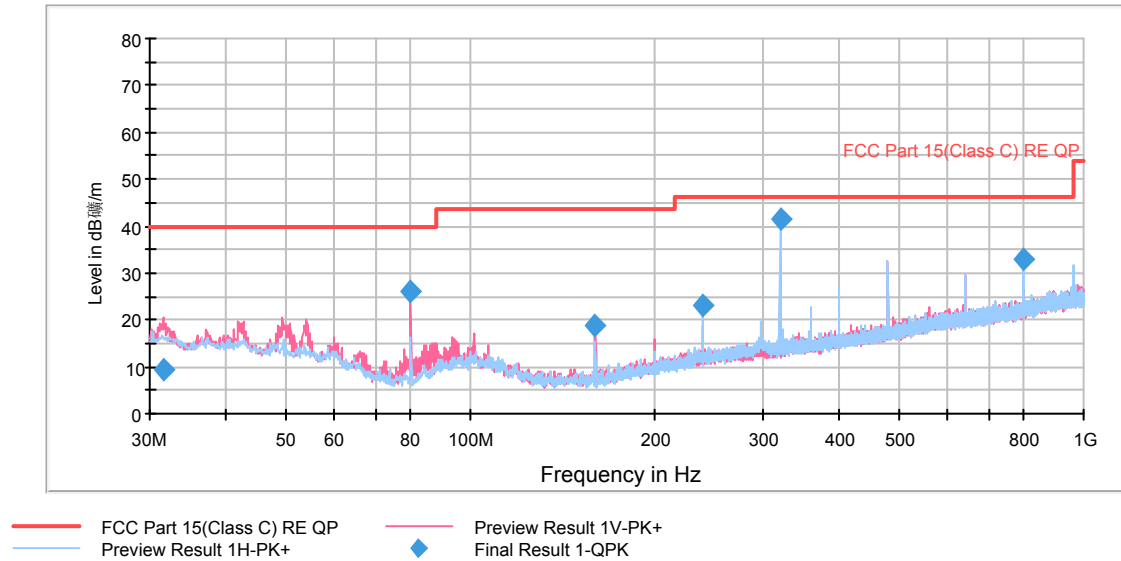

Note: This graph displays the maximum values of horizontal and vertical by software

Note: a font (Level in dBuV/m) in the test plot =(level in dBuV/m)

Radiates Emission from 30MHz to 1GHz

Frequency (MHz)	Quasi-Peak (dBuV/m)	Height (cm)	Polarization	Azimuth (deg)	Reading value (dBuV/m)	Correct Factor (dB)	Margin (dB)	Limit (dBuV/m)
31.655191	9.4	99.0	V	294.0	27.4	-18.0	30.6	40.0
79.995112	26.2	177.0	V	207.0	54.8	-28.6	13.8	40.0
159.980050	18.7	99.0	V	299.0	47.5	-28.8	24.8	43.5
240.005000	23.3	118.0	H	346.0	48.2	-24.9	22.7	46.0
319.990000	41.7	99.0	H	128.0	64.6	-22.9	4.3	46.0
799.978750	33.1	99.0	H	40.0	47.3	-14.2	12.9	46.0

Remark: 1. Quasi-Peak = Reading value + Correction factor

2. Correction Factor = Antenna factor+ Insertion loss(cable loss+amplifier gain)

3. Margin = Limit – Quasi-Peak

TA Technology (Shanghai) Co., Ltd. Test Report

RE 1G-3GHz PK+AV

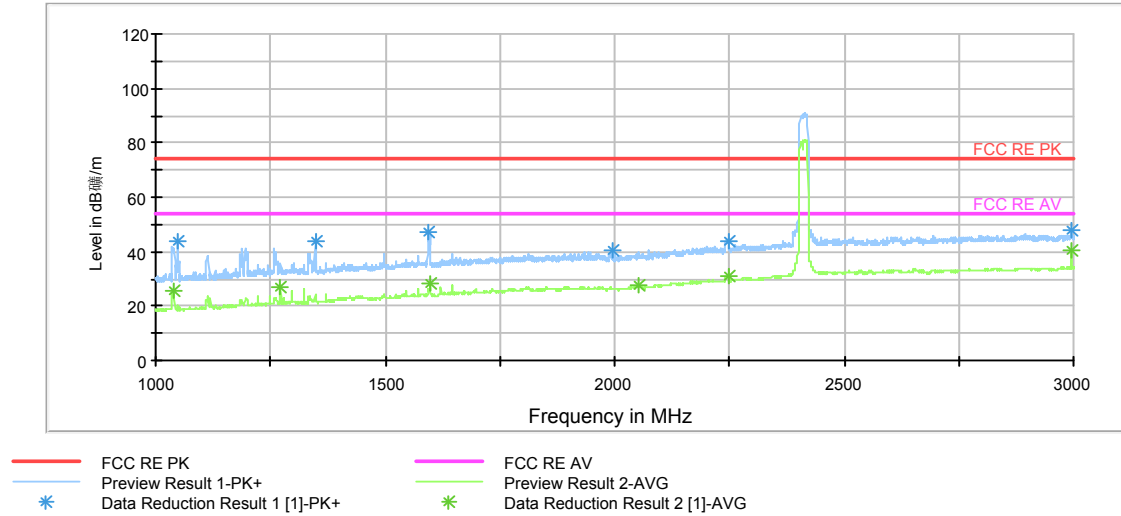

Note: This graph displays the maximum values of horizontal and vertical by software

Note: a font ($\text{Level in dB}\frac{\mu\text{V}}{\text{m}}$) in the test plot =(level in dBuV/m)

Note: The signal beyond the limit is carrier.

Radiates Emission from 1GHz to 3GHz

Frequency (MHz)	Peak (dBuV/m)	Height (cm)	Polarization	Azimuth (deg)	Reading value (dBuV/m)	Correct Factor (dB)	Margin (dB)	Limit (dBuV/m)
1039.000000	40.5	101.0	V	171.0	51.7	-11.2	33.5	74
1272.500000	35.9	101.0	V	0.0	44.6	-8.7	38.1	74
1597.000000	42.5	101.0	V	211.0	48.5	-6.0	31.5	74
2053.500000	38.1	101.0	H	71.0	40.2	-2.1	35.9	74
2995.000000	47.7	101.0	V	330.0	52.5	-4.8	26.3	74
2249.000000	43.7	101.0	H	310.0	43.7	0.0	30.3	74

Remark: 1. Correction Factor = Antenna factor+ Insertion loss (cable loss + amplifier gain)

Frequency (MHz)	Average (dBuV/m)	Height (cm)	Polarization	Azimuth (deg)	Reading value (dBuV/m)	Correct Factor (dB)	Margin (dB)	Limit (dBuV/m)
1039.000000	25.5	101.0	V	171.0	36.7	-11.2	28.5	54
1272.500000	26.9	101.0	V	0.0	35.6	-8.7	27.1	54
1597.000000	28.4	101.0	V	211.0	34.4	-6.0	25.6	54
2053.500000	27.5	101.0	H	71.0	29.6	-2.1	26.5	54
2995.000000	40.7	101.0	V	330.0	45.5	-4.8	13.3	54
2249.000000	31.0	101.0	H	310.0	31.0	0.0	23.0	54

Remark: 1. Correction Factor = Antenna factor+ Insertion loss (cable loss + amplifier gain)

TA Technology (Shanghai) Co., Ltd. Test Report

RE 3-18GHz PK+AV

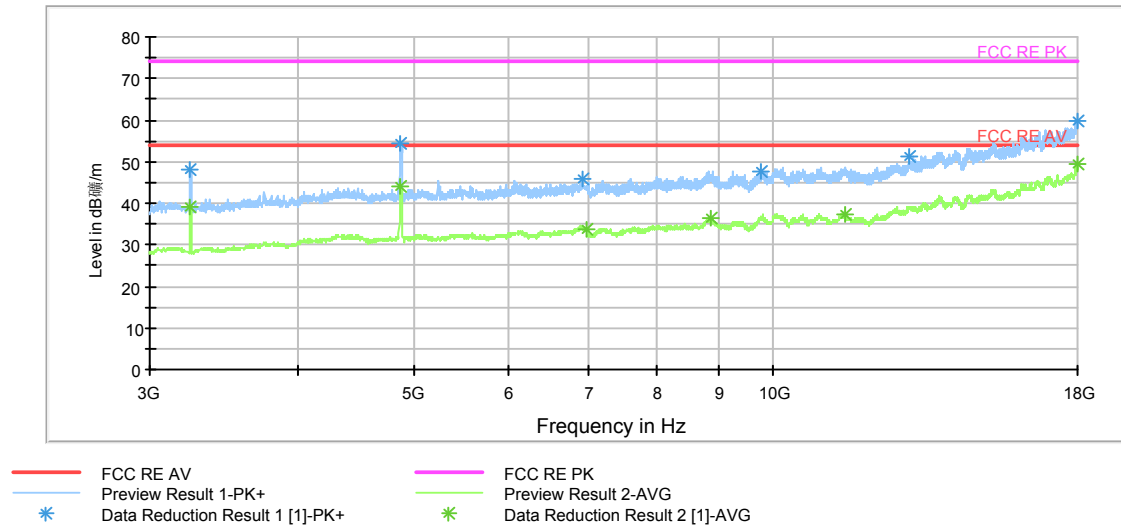

Note: This graph displays the maximum values of horizontal and vertical by software

Note: a font (Level in dBuV/m) in the test plot =(level in dBuV/m)

Radiates Emission from 3GHz to 18GHz

Frequency (MHz)	Peak (dBuV/m)	Height (cm)	Polarization	Azimuth (deg)	Reading value (dBuV/m)	Correct Factor (dB)	Margin (dB)	Limit (dBuV/m)
17998.125000	58.8	101.0	H	18.0	83.5	-24.7	15.2	74
3247.500000	47.9	101.0	V	36.0	49.4	-1.5	26.1	74
4871.250000	54.2	101.0	V	0.0	57.1	-2.9	19.8	74
6969.375000	43.3	101.0	V	324.0	48.8	-5.5	30.7	74
8870.625000	46.6	101.0	V	0.0	56.4	-9.8	27.4	74
11488.125000	46.7	101.0	V	283.0	59.1	-12.4	27.3	74

Remark: 1. Correction Factor = Antenna factor+ Insertion loss (cable loss + amplifier gain)

Frequency (MHz)	Average (dBuV/m)	Height (cm)	Polarization	Azimuth (deg)	Reading value (dBuV/m)	Correct Factor (dB)	Margin (dB)	Limit (dBuV/m)
17998.125000	49.4	101.0	H	18.0	74.1	-24.7	4.6	54
3247.500000	39.1	101.0	V	36.0	40.6	-1.5	14.9	54
4871.250000	43.9	101.0	V	0.0	46.8	-2.9	10.1	54
6969.375000	33.9	101.0	V	324.0	39.4	-5.5	20.1	54
8870.625000	36.2	101.0	V	0.0	46.0	-9.8	17.8	54
11488.125000	37.4	101.0	V	283.0	49.8	-12.4	16.6	54

Remark: 1. Correction Factor = Antenna factor+ Insertion loss (cable loss + amplifier gain)

TA Technology (Shanghai) Co., Ltd. Test Report

Report No.: RXA1503-0042RF01R1

Page 88 of 103

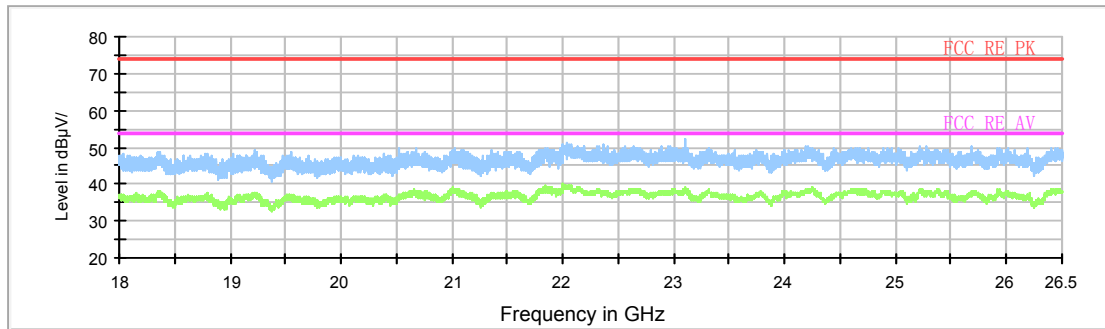

Note: This graph displays the maximum values of horizontal and vertical by software
Note: a font (Level in dBµV/m) in the test plot =(level in dBuv/m)
Radiates Emission from 18GHz to 26.5GHz

TA Technology (Shanghai) Co., Ltd. Test Report

802.11n(HT20) CH11

RE 30M-1GHz QP

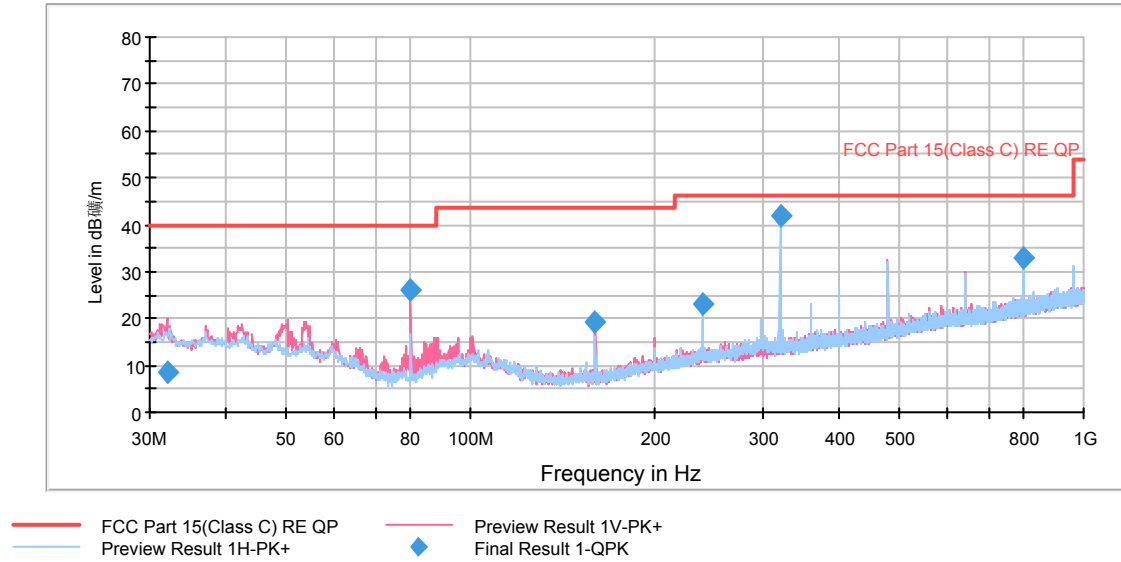

Note: This graph displays the maximum values of horizontal and vertical by software

Note: a font (Level in dB μ V/m) in the test plot =(level in dBuV/m)

Radiates Emission from 30MHz to 1GHz

Frequency (MHz)	Quasi-Peak (dBuV/m)	Height (cm)	Polarization	Azimuth (deg)	Reading value (dBuV/m)	Correct Factor (dB)	Margin (dB)	Limit (dBuV/m)
32.061097	8.4	99.0	V	320.0	26.6	-18.2	31.6	40.0
79.995112	26.2	197.0	V	192.0	54.8	-28.6	13.8	40.0
159.980050	19.1	99.0	V	298.0	47.9	-28.8	24.4	43.5
240.005000	23.2	118.0	H	351.0	48.1	-24.9	22.8	46.0
319.990000	41.8	99.0	H	126.0	64.7	-22.9	4.2	46.0
799.978750	33.1	99.0	H	40.0	47.3	-14.2	12.9	46.0

Remark: 1. Quasi-Peak = Reading value + Correction factor

2. Correction Factor = Antenna factor+ Insertion loss(cable loss+amplifier gain)

3. Margin = Limit – Quasi-Peak

TA Technology (Shanghai) Co., Ltd.

Test Report

RE 1G-3GHz PK+AV

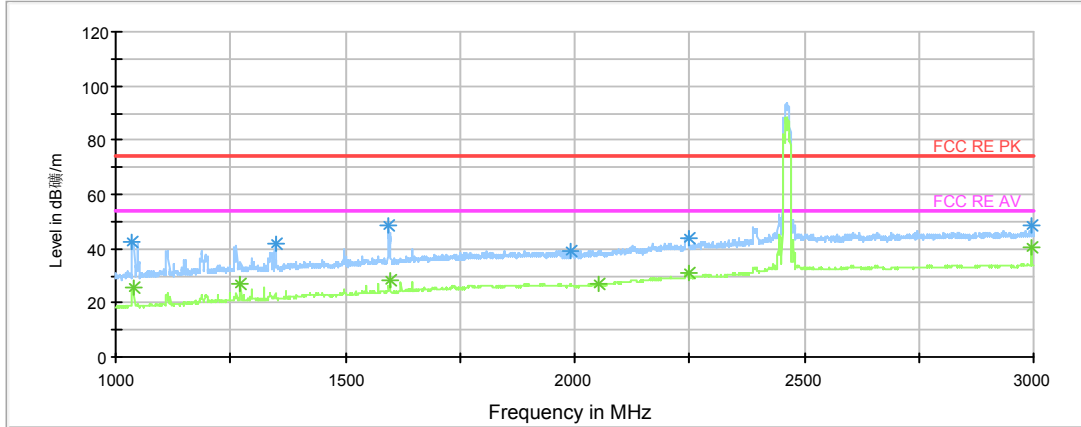

— FCC RE PK
— Preview Result 1-PK+
* Data Reduction Result 1 [1]-PK+

— FCC RE AV
— Preview Result 2-AVG
* Data Reduction Result 2 [1]-AVG

Note: This graph displays the maximum values of horizontal and vertical by software

Note: a font ($\frac{\text{Level in dBuV/m}}{\text{Height}}$) in the test plot =(level in dBuV/m)

Note: The signal beyond the limit is carrier.

Radiates Emission from 1GHz to 3GHz

Frequency (MHz)	Peak (dBuV/m)	Height (cm)	Polarization	Azimuth (deg)	Reading value (dBuV/m)	Correct Factor (dB)	Margin (dB)	Limit (dBuV/m)
1038.500000	41.3	101.0	V	0.0	52.5	-11.2	32.7	74
1272.500000	35.0	101.0	V	210.0	43.7	-8.7	39.0	74
1597.000000	46.0	101.0	V	289.0	52.0	-6.0	28.0	74
2050.500000	38.0	101.0	V	0.0	40.1	-2.1	36.0	74
2995.000000	48.7	101.0	V	329.0	53.5	-4.8	25.3	74
2249.000000	42.7	101.0	H	310.0	42.7	0.0	31.3	74

Remark: 1. Correction Factor = Antenna factor+ Insertion loss (cable loss + amplifier gain)

Frequency (MHz)	Average (dBuV/m)	Height (cm)	Polarization	Azimuth (deg)	Reading value (dBuV/m)	Correct Factor (dB)	Margin (dB)	Limit (dBuV/m)
1038.500000	25.6	101.0	V	0.0	36.8	-11.2	28.4	54
1272.500000	26.9	101.0	V	210.0	35.6	-8.7	27.1	54
1597.000000	28.1	101.0	V	289.0	34.1	-6.0	25.9	54
2050.500000	27.3	101.0	V	0.0	29.4	-2.1	26.7	54
2995.000000	40.5	101.0	V	329.0	45.3	-4.8	13.5	54
2249.000000	30.7	101.0	H	310.0	30.7	0.0	23.3	54

Remark: 1. Correction Factor = Antenna factor+ Insertion loss (cable loss + amplifier gain)

TA Technology (Shanghai) Co., Ltd. Test Report

RE 3-18GHz PK+AV

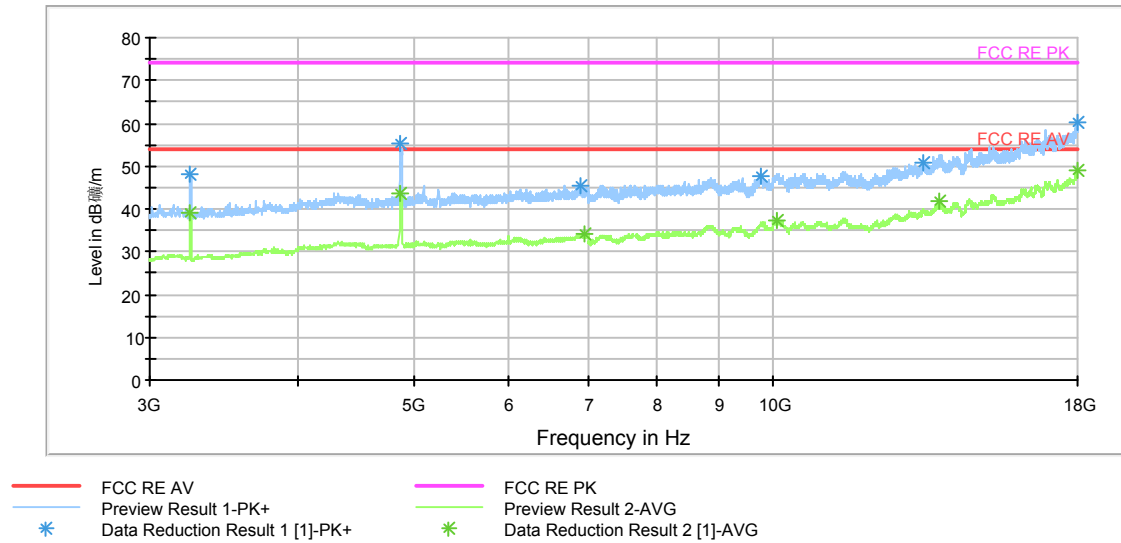

Note: This graph displays the maximum values of horizontal and vertical by software
 Note: a font (Level in dBµV/m) in the test plot =(level in dBuV/m)
 Radiates Emission from 3GHz to 18GHz

Frequency (MHz)	Peak (dBuV/m)	Height (cm)	Polarization	Azimuth (deg)	Reading value (dBuV/m)	Correct Factor (dB)	Margin (dB)	Limit (dBuV/m)
3247.500000	48.0	101.0	V	0.0	49.5	-1.5	26.0	74
4873.125000	55.4	101.0	V	0.0	58.3	-2.9	18.6	74
6960.000000	43.7	101.0	H	71.0	49.2	-5.5	30.3	74
10072.500000	47.0	101.0	V	160.0	59.8	-12.8	27.0	74
13790.625000	50.3	101.0	H	233.0	66.1	-15.8	23.7	74
17996.250000	59.1	101.0	H	271.0	83.7	-24.6	14.9	74

Remark: 1. Correction Factor = Antenna factor+ Insertion loss (cable loss + amplifier gain)

Frequency (MHz)	Average (dBuV/m)	Height (cm)	Polarization	Azimuth (deg)	Reading value (dBuV/m)	Correct Factor (dB)	Margin (dB)	Limit (dBuV/m)
3247.500000	39.0	101.0	V	0.0	40.5	-1.5	15.0	54
4873.125000	43.5	101.0	V	0.0	46.4	-2.9	10.5	54
6960.000000	34.1	101.0	H	71.0	39.6	-5.5	19.9	54
10072.500000	37.4	101.0	V	160.0	50.2	-12.8	16.6	54
13790.625000	41.7	101.0	H	233.0	57.5	-15.8	12.3	54
17996.250000	49.1	101.0	H	271.0	73.7	-24.6	4.9	54

Remark: 1. Correction Factor = Antenna factor+ Insertion loss (cable loss + amplifier gain)

TA Technology (Shanghai) Co., Ltd. Test Report

Report No.: RXA1503-0042RF01R1

Page 92 of 103

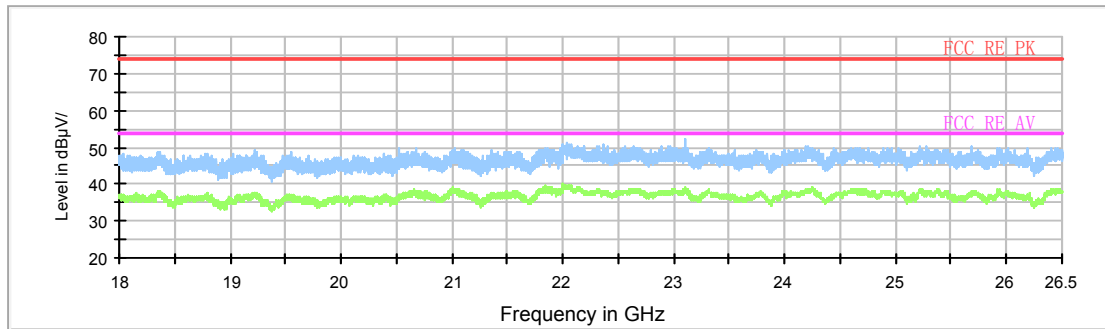

Note: This graph displays the maximum values of horizontal and vertical by software
Note: a font (Level in dBµV/m) in the test plot =(level in dBuv/m)
Radiates Emission from 18GHz to 26.5GHz

2.10. Conducted Emissions

Ambient condition

Temperature	Relative humidity	Pressure
23°C ~25°C	45%~50%	101.5kPa

Method of Measurement

The EUT IS placed on a non-metallic table of 80cm height above the horizontal metal reference ground plane. During the test, the EUT was operating in its typical mode. The test method is according to ANSIC63.4-2009.Connect the AC power line of the EUT to the LISN Use EMI receiver to detect the average and Quasi-peak value. RBW is set to 9kHz,VBW is set to 30kHz The measurement result should include both L line and N line.
The test is in transmitting mode.

Test setup

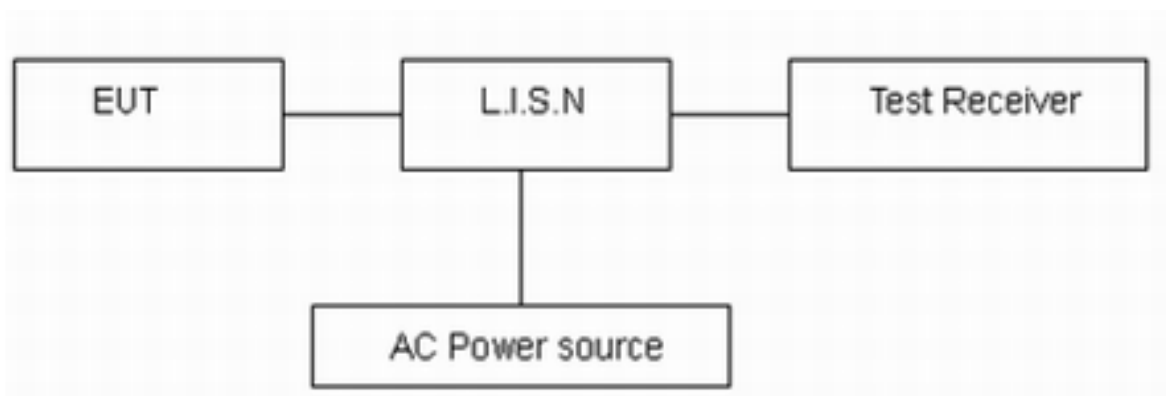

Note: AC Power source is used to change the voltage from 220V/50Hz to 110V/60Hz.

Limits

Frequency (MHz)	Conducted Limits(dBμV)	
	Quasi-peak	Average
0.15 - 0.5	66 to 56 *	56 to 46 *
0.5 - 5	56	46
5 - 30	60	50

*: Decreases with the logarithm of the frequency.

Measurement Uncertainty

The assessed measurement uncertainty to ensure 95% confidence level for the normal distribution is with the coverage factor $k = 1.96$, $U = 2.69$ dB.

TA Technology (Shanghai) Co., Ltd.

Test Report

Report No.: RXA1503-0042RF01R1

Page 94 of 103

Test Results:

802.11b CH6

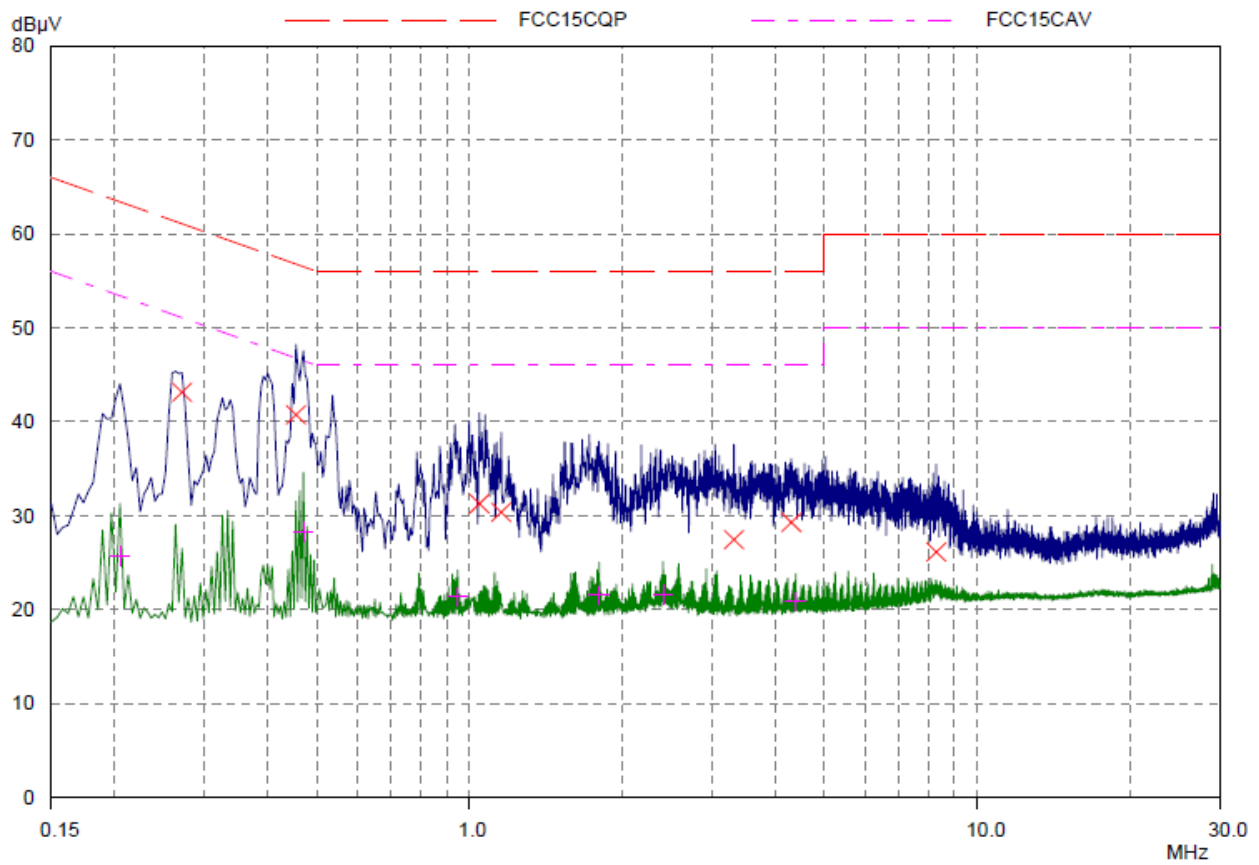

Final Measurement Results

Frequency MHz	QP Level dBµV	QP Limit dBµV	QP Delta dB	Phase -	PE -
0.27109	43.15	61.08	17.93	L1	gnd
0.45468	40.75	56.79	16.04	L1	gnd
1.04453	31.30	56.00	24.70	L1	gnd
1.1539	30.37	56.00	25.63	L1	gnd
3.31406	27.46	56.00	28.54	L1	gnd
4.29843	29.29	56.00	26.71	L1	gnd
8.29843	26.14	60.00	33.86	L1	gnd

Frequency MHz	AV Level dBµV	AV Limit dBµV	AV Delta dB	Phase -	PE -
0.20468	25.73	53.42	27.69	L1	gnd
0.47031	28.30	46.51	18.21	L1	gnd
0.94687	21.38	46.00	24.62	L1	gnd
1.79843	21.55	46.00	24.45	L1	gnd
2.4039	21.65	46.00	24.35	L1	gnd
4.38437	20.88	46.00	25.12	L1	gnd

L Line

TA Technology (Shanghai) Co., Ltd. Test Report

Report No.: RXA1503-0042RF01R1

Page 95 of 103

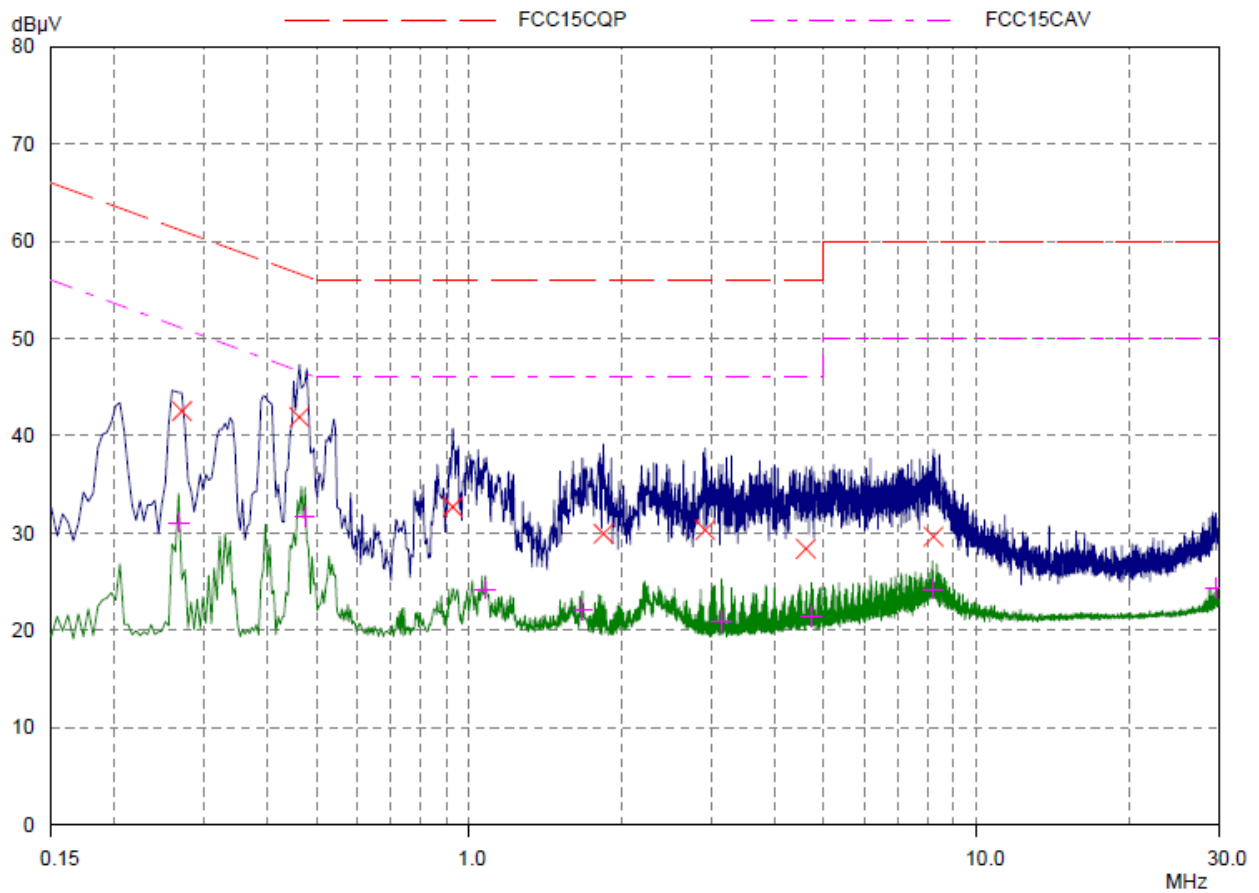

Final Measurement Results

Frequency MHz	QP Level dBμV	QP Limit dBμV	QP Delta dB	Phase -	PE -
0.27109	42.53	61.08	18.55	N	gnd
0.4625	41.94	56.65	14.71	N	gnd
0.92734	32.68	56.00	23.32	N	gnd
1.8375	29.93	56.00	26.07	N	gnd
2.91562	30.32	56.00	25.68	N	gnd
4.60703	28.38	56.00	27.62	N	gnd
8.2242	29.63	60.00	30.37	N	gnd

Frequency MHz	AV Level dBμV	AV Limit dBμV	AV Delta dB	Phase -	PE -
0.26718	31.09	51.21	20.12	N	gnd
0.47421	31.72	46.44	14.72	N	gnd
1.07578	24.21	46.00	21.79	N	gnd
1.66953	22.15	46.00	23.85	N	gnd
3.14218	20.90	46.00	25.10	N	gnd
4.72421	21.44	46.00	24.56	N	gnd
8.18515	24.25	50.00	25.75	N	gnd
29.61093	24.33	50.00	25.67	N	gnd

N Line

TA Technology (Shanghai) Co., Ltd. Test Report

Report No.: RXA1503-0042RF01R1

Page 96 of 103

802.11g CH6

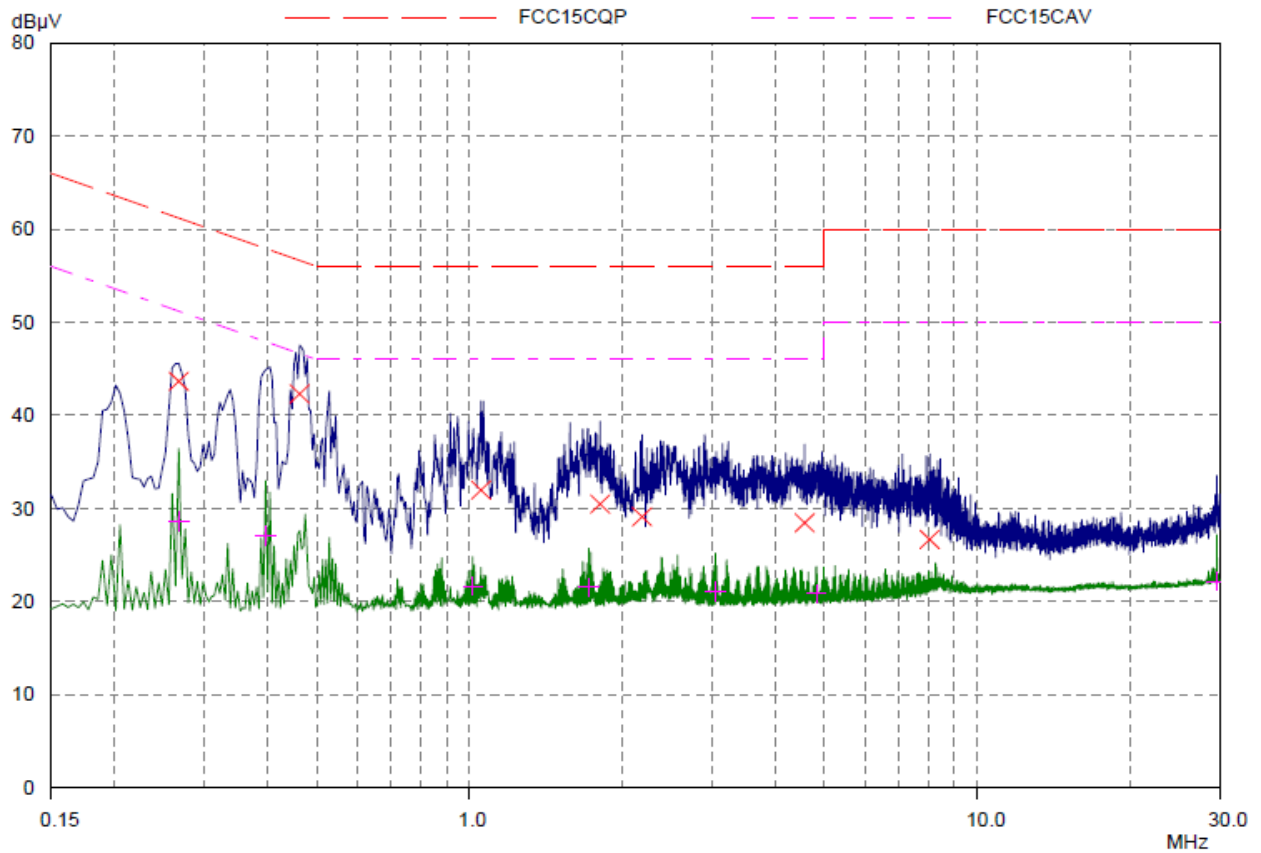

Final Measurement Results

Frequency MHz	QP Level dBµV	QP Limit dBµV	QP Delta dB	Phase -	PE -
0.26718	43.66	61.21	17.55	L1	gnd
0.4625	42.32	56.65	14.33	L1	gnd
1.05234	31.97	56.00	24.03	L1	gnd
1.80625	30.47	56.00	25.53	L1	gnd
2.18515	29.13	56.00	26.87	L1	gnd
4.56796	28.47	56.00	27.53	L1	gnd
8.05625	26.68	60.00	33.32	L1	gnd

Frequency MHz	AV Level dBµV	AV Limit dBµV	AV Delta dB	Phase -	PE -
0.26718	28.64	51.21	22.57	L1	gnd
0.39609	27.09	47.93	20.84	L1	gnd
1.01328	21.66	46.00	24.34	L1	gnd
1.7164	21.53	46.00	24.47	L1	gnd
3.04843	21.09	46.00	24.91	L1	gnd
4.81796	20.87	46.00	25.13	L1	gnd
29.63828	22.16	50.00	27.84	L1	gnd

L Line

TA Technology (Shanghai) Co., Ltd. Test Report

Report No.: RXA1503-0042RF01R1

Page 97 of 103

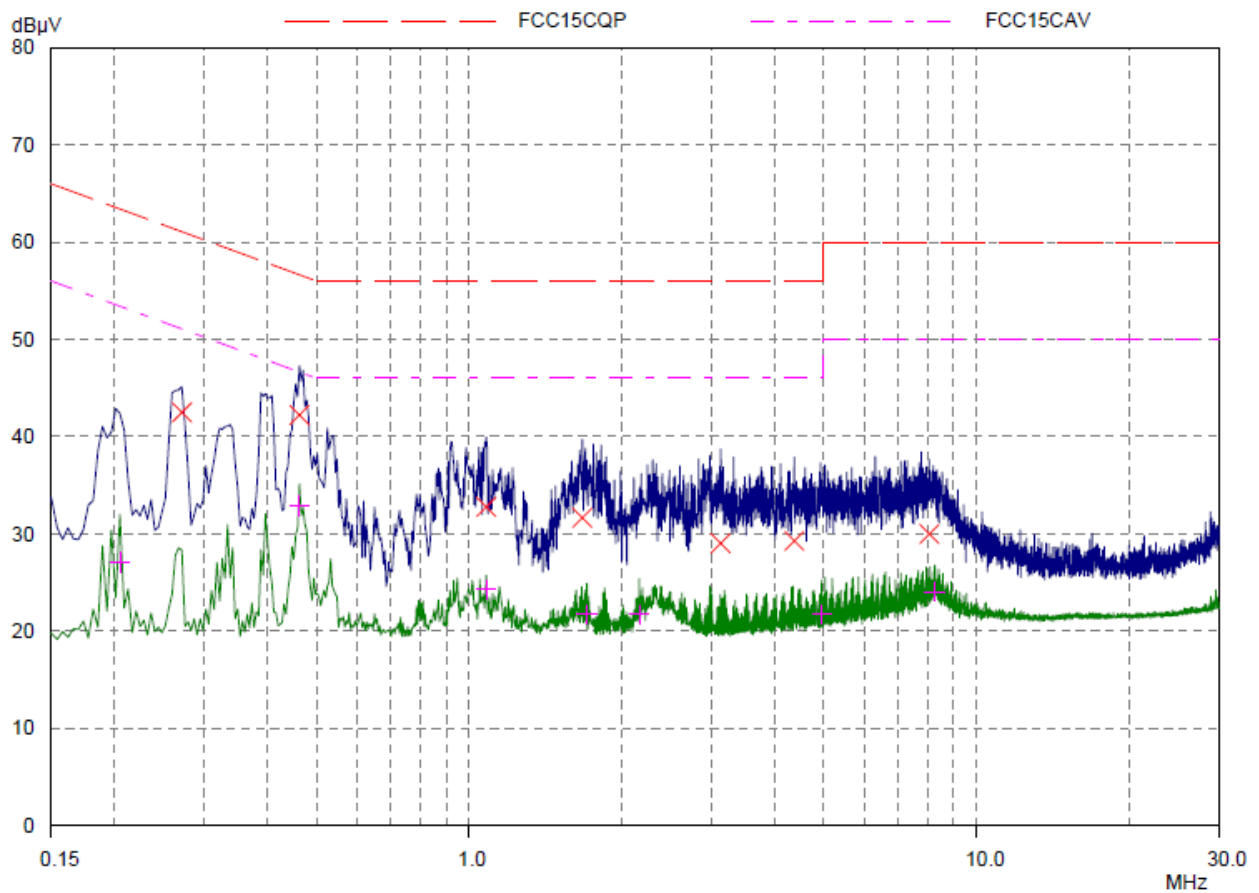

Final Measurement Results

Frequency MHz	QP Level dBµV	QP Limit dBµV	QP Delta dB	Phase -	PE -
0.27109	42.49	61.08	18.59	N	gnd
0.4625	42.22	56.65	14.43	N	gnd
1.07968	32.79	56.00	23.21	N	gnd
1.66953	31.66	56.00	24.34	N	gnd
3.13046	29.03	56.00	26.97	N	gnd
4.36875	29.28	56.00	26.72	N	gnd
8.06406	30.00	60.00	30.00	N	gnd

Frequency MHz	AV Level dBµV	AV Limit dBµV	AV Delta dB	Phase -	PE -
0.20468	27.11	53.42	26.31	N	gnd
0.4625	32.88	46.65	13.77	N	gnd
1.07968	24.26	46.00	21.74	N	gnd
1.70468	21.72	46.00	24.28	N	gnd
2.16171	21.74	46.00	24.26	N	gnd
4.95468	21.74	46.00	24.26	N	gnd
8.26718	24.04	50.00	25.96	N	gnd

N Line

TA Technology (Shanghai) Co., Ltd. Test Report

Report No.: RXA1503-0042RF01R1

Page 98 of 103

802.11n(HT20) CH6

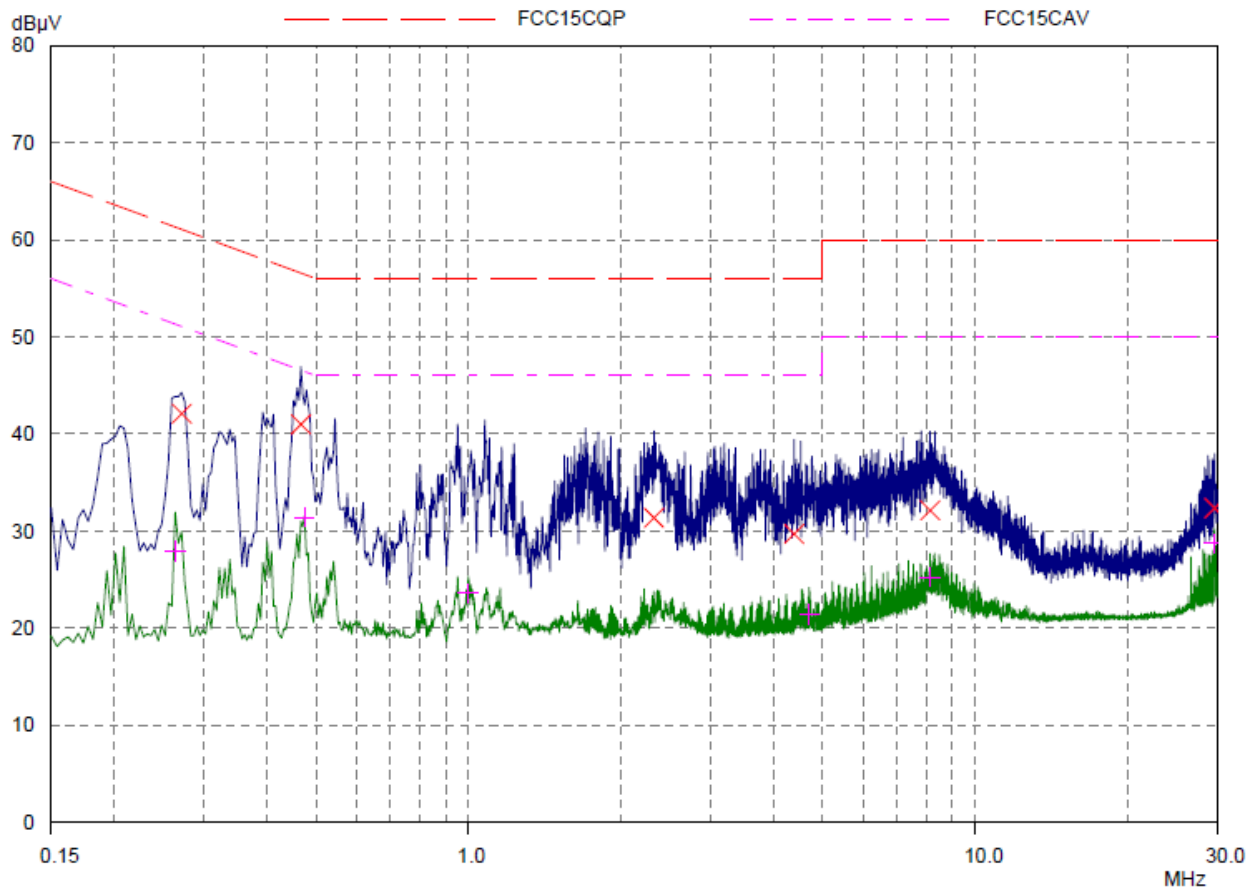

Final Measurement Results

Frequency MHz	QP Level dBµV	QP Limit dBµV	QP Delta dB	Phase -	PE -
0.27109	42.09	61.08	18.99	L1	gnd
0.4664	41.00	56.58	15.58	L1	gnd
2.32187	31.36	56.00	24.64	L1	gnd
4.38828	29.72	56.00	26.28	L1	gnd
8.14218	32.13	60.00	27.87	L1	gnd
29.66171	32.36	60.00	27.64	L1	gnd

Frequency MHz	AV Level dBµV	AV Limit dBµV	AV Delta dB	Phase -	PE -
0.26328	27.91	51.33	23.42	L1	gnd
0.47421	31.41	46.44	15.03	L1	gnd
0.99765	23.61	46.00	22.39	L1	gnd
4.69687	21.43	46.00	24.57	L1	gnd
8.13828	25.25	50.00	24.75	L1	gnd
29.66171	28.70	50.00	21.30	L1	gnd

L Line

TA Technology (Shanghai) Co., Ltd. Test Report

Report No.: RXA1503-0042RF01R1

Page 99 of 103

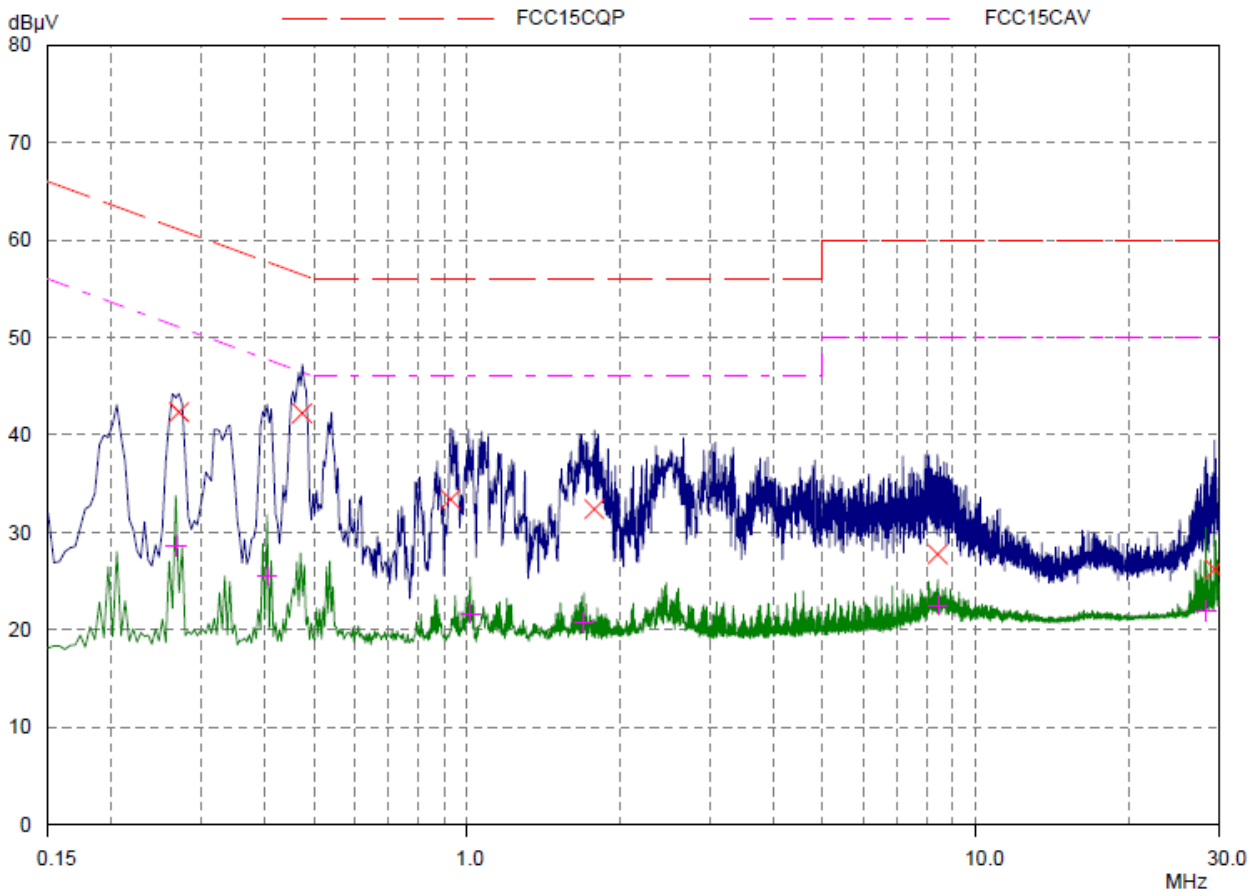

Final Measurement Results

Frequency MHz	QP Level dBµV	QP Limit dBµV	QP Delta dB	Phase -	PE -
0.27109	42.35	61.08	18.73	N	gnd
0.47421	42.22	56.44	14.22	N	gnd
0.92734	33.40	56.00	22.60	N	gnd
1.7789	32.38	56.00	23.62	N	gnd
8.40781	27.76	60.00	32.24	N	gnd
29.47031	26.24	60.00	33.76	N	gnd

Frequency MHz	AV Level dBµV	AV Limit dBµV	AV Delta dB	Phase -	PE -
0.26718	28.59	51.21	22.62	N	gnd
0.4039	25.59	47.77	22.18	N	gnd
1.01328	21.66	46.00	24.34	N	gnd
1.69687	20.72	46.00	25.28	N	gnd
8.42343	22.51	50.00	27.49	N	gnd
28.3414	21.92	50.00	28.08	N	gnd

N Line

TA Technology (Shanghai) Co., Ltd.
Test Report

Report No.: RXA1503-0042RF01R1

Page 100of 103

2. Main Test Instruments

No.	Name	Type	Manufacturer	Serial Number	Calibration Date	Expiration Time	Valid Period
01	EMI Test Receiver	ESCI	R&S	100948	2014-05-26	2015-05-25	1 year
02	Loop Antenna	FMZB1516	SCHWARZBECK	237	2014-06-29	2017-06-28	3 years
03	TRILOG Broadband Antenna	VULB 9163	Schwarzbeck	9163-201	2013-11-25	2016-11-24	3years
04	Double Ridged Waveguide Horn Antenna	HF907	R&S	100126	2012-07-02	2015-07-09	3 years
05	Standard Gain Horn	3160-09	ETS-Lindgren	00102644	2012-05-20	2015-05-19	3 years
06	EMI Test Receiver	ESCS30	R&S	100138	2014-12-18	2015-12-17	1 year
07	LISN	ENV216	R&S	101171	2014-12-18	2015-12-17	1 year
08	Spectrum Analyzer	E4445A	Agilent	MY46181146	2014-05-26	2015-05-25	1 year
09	MOB COMMS DC SUPPLY	66319D	Agilent	MY43004105	2014-05-26	2015-05-25	1 year
10	Peak Power Meter	8990B	Agilent	51000109	2014-05-26	2015-05-25	1 year
11	Wideband Power Sensors	N1923A	Agilent	MY51220004	2014-05-26	2015-05-25	1 year
12	Spectrum Analyzer	FSV30	R&S	100815	2014-05-26	2015-05-25	1 year

*****END OF REPORT BODY*****

ANNEX A: EUT Appearance and Test Setup

A.1 EUT Appearance

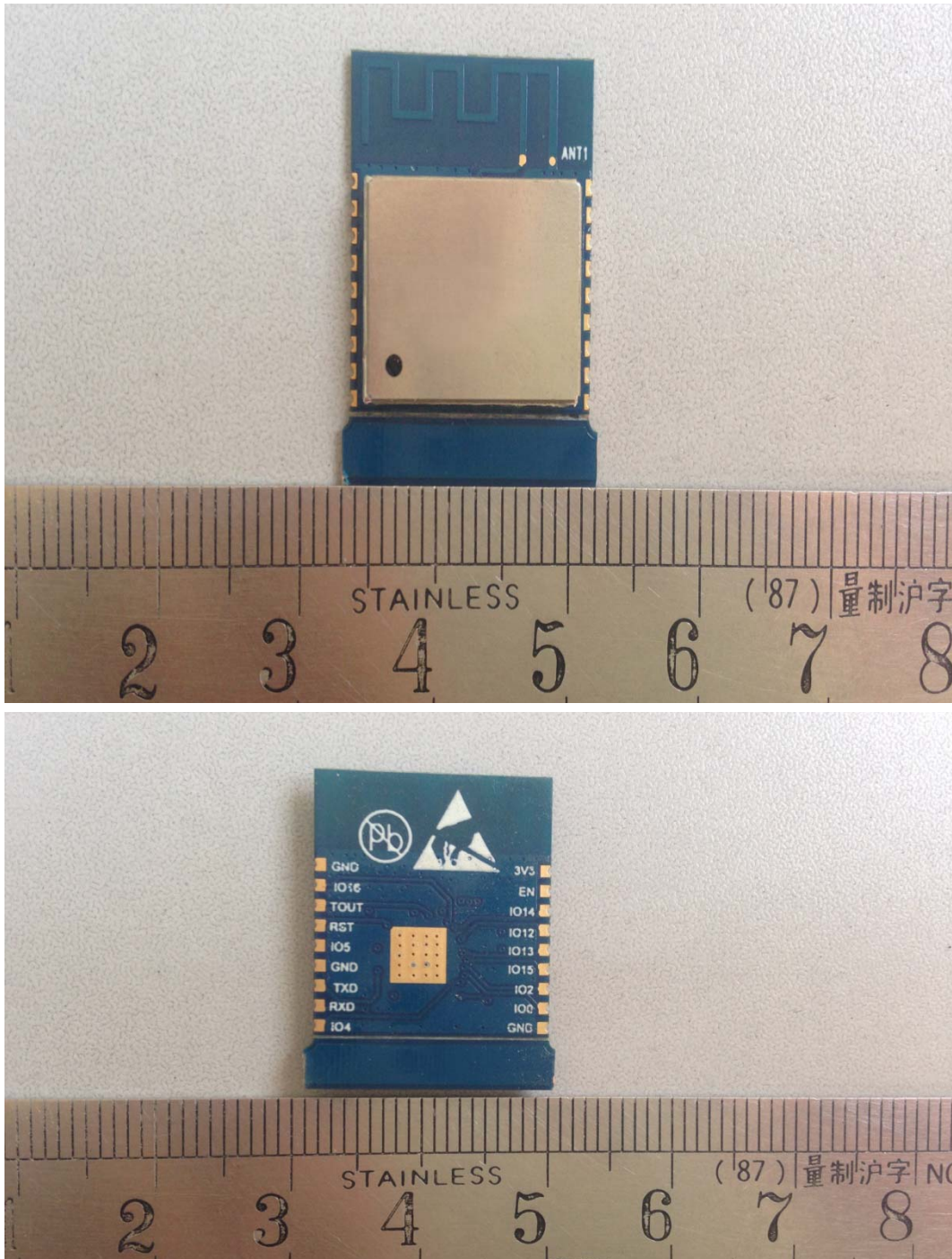

a: EUT

Picture 1 Constituents of EUT

A.2 Test Setup

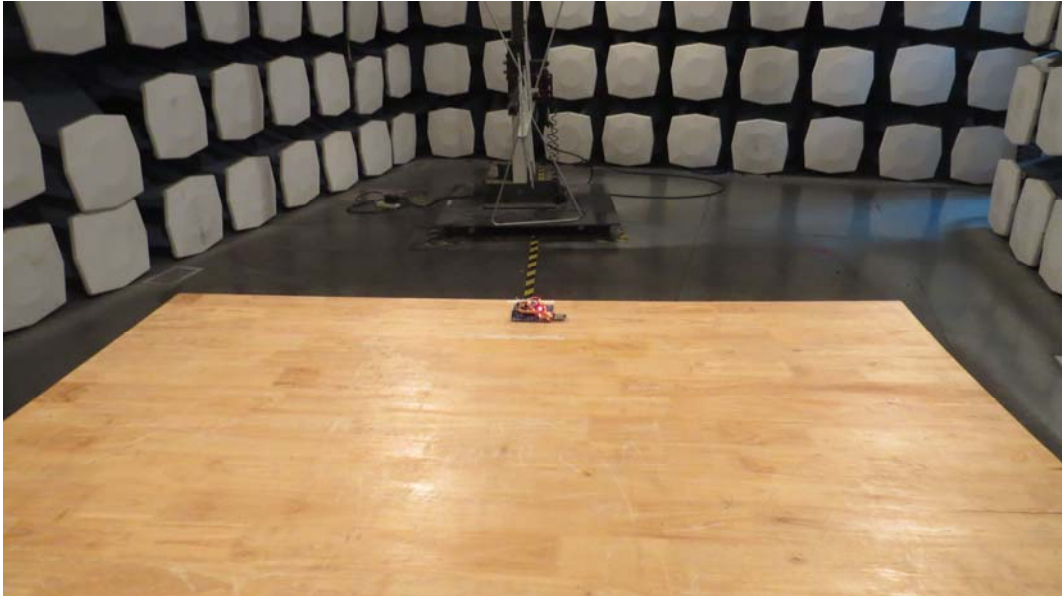

30M Hz-1GHz



Above 1GHz

Picture 2 Radiated Emission Test Setup

TA Technology (Shanghai) Co., Ltd.
Test Report

Report No.: RXA1503-0042RF01R1

Page 103 of 103



Picture 3 Conducted Emission Test Setup