

Wireless test report – 388860-1TRFWL

Applicant:

Trilliant Networks Inc.

Product type:

Access Point

Model:

AP-R9-F

FCC ID:

TMB-APR9F

IC Registration number:

6028A-APR9F

Specifications:

◆ **FCC 47 CFR Part 15 Subpart C, §15.247**

Operation in the 902–928 MHz, 2400–2483.5 MHz, and 5725–5850 MHz

◆ **RSS-247, Issue 2, Feb 2017, Section 5**

Digital Transmission Systems (DTSs), Frequency Hopping Systems (FHSs) and Licence-Exempt Local Area Network (LE-LAN) Devices

5) Standard specifications for frequency hopping systems and digital transmission systems operating in the bands 902–928 MHz, 2400–2483.5 MHz and 5725–5850 MHz

Date of issue: **January 13, 2020**

Avul Nzenza, EMC/Wireless Specialist

Tested by



Signature

Andrey Adelberg, Senior Wireless/EMC Specialist

Reviewed by

Signature



Test location(s)

Company name	Nemko Canada Inc.
Site name	Montreal
Address	292 Labrosse Avenue
City	Pointe-Claire
Province	Quebec
Postal code	H9R 5L8
Country	Canada
Telephone	+1 514 694 2684
Facsimile	+1 514 694 3528
Toll free	
Website	www.nemko.com
Site number (3 m SAC)	FCC: CA2041; IC: 2040G-5

Limits of responsibility

Note that the results contained in this report relate only to the items tested and were obtained in the period between the date of initial receipt of samples and the date of issue of the report.

This test report has been completed in accordance with the requirements of ISO/IEC 17025. All results contain in this report are within Nemko Canada's ISO/IEC 17025 accreditation.

Copyright notification

Nemko Canada Inc. authorizes the applicant to reproduce this report provided it is reproduced in its entirety and for use by the company's employees only. Any use which a third party makes of this report, or any reliance on or decisions to be made based on it, are the responsibility of such third parties.

Nemko Canada Inc. accepts no responsibility for damages, if any, suffered by any third party as a result of decisions made or actions based on this report.

© Nemko Canada Inc.



Table of contents

Table of contents	3
Section 1. Report summary	4
1.1 Applicant and manufacturer	4
1.2 Test specifications	4
1.3 Test methods.....	4
1.4 Statement of compliance	4
1.5 Exclusions	4
1.6 Test report revision history	4
Section 2. Summary of test results	5
2.1 FCC Part 15 Subpart C, general requirements test results.....	5
2.2 FCC Part 15 Subpart C, intentional radiators test results for digital transmission systems (DTS)	5
2.3 ISED RSS-Gen, Issue 5, test results.....	5
2.4 ISED RSS-247, Issue 2, test results for digital transmission systems (DTS).....	5
Section 3. Equipment under test (EUT) details	6
3.1 Sample information.....	6
3.2 EUT information	6
3.3 Technical information	6
3.4 Product description and theory of operation	6
3.5 EUT exercise details.....	6
3.6 EUT setup diagram	7
Section 4. Engineering considerations	8
4.1 Modifications incorporated in the EUT.....	8
4.2 Technical judgment.....	8
4.3 Deviations from laboratory tests procedures	8
Section 5. Test conditions	9
5.1 Atmospheric conditions	9
5.2 Power supply range.....	9
Section 6. Measurement uncertainty	10
6.1 Uncertainty of measurement	10
Section 7. Test equipment	11
7.1 Test equipment list.....	11
Section 8. Testing data	12
8.1 FCC 15.31(e) Variation of power source	12
8.2 FCC 15.31(m) and RSS-Gen 6.9 Number of frequencies	13
8.3 FCC 15.203 and RSS-Gen, section 6.8 Antenna requirement.....	15
8.4 FCC 15.207(a) and RSS-Gen 8.8 AC power line conducted emissions limits	16
8.5 FCC 15.247(a)(2) and RSS-247 5.2(a) Minimum 6 dB bandwidth for DTS systems	19
8.6 FCC 15.247(b) and RSS-247 5.4(d) Transmitter output power and e.i.r.p. requirements for DTS in 2 GHz	22
8.7 FCC 15.247(d) and RSS-247 5.5 Spurious (out-of-band) unwanted emissions.....	25
8.8 FCC 15.247(e) and RSS-247 5.2(b) Power spectral density for digitally modulated devices	32
Section 9. Block diagrams of test set-ups	34
9.1 Radiated emissions set-up for frequencies below 1 GHz.....	34
9.2 Radiated emissions set-up for frequencies above 1 GHz.....	34
9.3 Conducted emissions set-up	35
9.4 Antenna port set-up	35

Section 1. Report summary

1.1 Applicant and manufacturer

Company name	Trilliant Networks Inc.
Address	401 Harrison Oaks, Suite 300
City	Cary
Province/State	North Carolina
Postal/Zip code	27513
Country	USA

1.2 Test specifications

FCC 47 CFR Part 15, Subpart C, Clause 15.247	Operation in the 902–928 MHz, 2400–2483.5 MHz, and 5725–585 MHz
RSS-247, Issue 2, Feb 2017, Section 5	Digital Transmission Systems (DTSSs), Frequency Hopping Systems (FHSs) and Licence-Exempt Local Area Network (LE-LAN) Devices

1.3 Test methods

558074 D01 15.247 Meas Guidance v05r02 (April 2, 2019)	Guidance for compliance measurements on digital transmission system, frequency hopping spread spectrum system, and hybrid system devices operating under section 15.247 of the FCC rules.
ANSI C63.10 v2013	American National Standard of Procedures for Compliance Testing of Unlicensed Wireless Devices
RSS-Gen, Issue 5 Amendment 1, March 2019	General Requirements for Compliance of Radio Apparatus

1.4 Statement of compliance

In the configuration tested, the EUT was found compliant.

Testing was performed against all relevant requirements of the test standard except as noted in section 1.5 below. Results obtained indicate that the product under test complies in full with the requirements tested. The test results relate only to the items tested.

See “Summary of test results” for full details.

1.5 Exclusions

None

1.6 Test report revision history

Revision #	Date of issue	Details of changes made to test report
TRF	January 13, 2020	Original report issued

Section 2. Summary of test results

2.1 FCC Part 15 Subpart C, general requirements test results

Table 2.1-1: FCC general requirements results

Part	Test description	Verdict
§15.207(a)	Conducted limits	Pass
§15.31(e)	Variation of power source	Pass
§15.31(m)	Number of tested frequencies	Pass
§15.203	Antenna requirement	Pass

2.2 FCC Part 15 Subpart C, intentional radiators test results for digital transmission systems (DTS)

Table 2.2-1: FCC 15.247 results for DTS

Part	Test description	Verdict
§15.247(a)(2)	Minimum 6 dB bandwidth	Pass
§15.247(b)(3)	Maximum peak output power in the 902–928 MHz, 2400–2483.5 MHz, and 5725–5850 MHz bands	Pass
§15.247(d)	Spurious emissions	Pass
§15.247(e)	Power spectral density	Pass

Notes: Only test applicable to the EUT have been included in this table.

2.3 ISED RSS-Gen, Issue 5, test results

Table 2.3-1: RSS-Gen results

Part	Test description	Verdict
7.3	Receiver radiated emission limits	Not applicable
7.4	Receiver conducted emission limits	Not applicable
6.9	Operating bands and selection of test frequencies	Pass
8.8	AC power-line conducted emissions limits	Pass

Notes: ¹ According to sections 5.2 and 5.3 of RSS-Gen, Issue 5 the EUT does not have a stand-alone receiver neither scanner receiver, therefore exempt from receiver requirements.

2.4 ISED RSS-247, Issue 2, test results for digital transmission systems (DTS)

Table 2.4-1: RSS-247 results for DTS

Part	Test description	Verdict
5.2 (a)	Minimum 6 dB bandwidth	Pass
5.2 (b)	Maximum power spectral density	Pass
5.4	Transmitter output power and e.i.r.p. requirements	Pass
5.4 (d)	Systems employing digital modulation techniques	Pass
5.5	Unwanted emissions	Pass

Notes: Only test applicable to the EUT have been included in this table.

Section 3. Equipment under test (EUT) details

3.1 Sample information

Receipt date	December 10, 2019
Nemko sample ID number	Item # 1

3.2 EUT information

Product type	Access Point
Model	AP-R9-F
Model variant	None
Serial number	7B070053

3.3 Technical information

Applicant IC company number	6028A
IC UPN number	APR9F
All used IC test site(s) Reg. number	2040G-5
RSS number and Issue number	RSS-247 Issue 2, Feb 2017
Frequency band (MHz)	ISM: 2400–2483.5
Frequency Min (MHz)	2402
Frequency Max (MHz)	2475
RF power Max (W), Conducted	0.409 W (26.12 dBm)
Field strength, dBµV/m @ 3 m	N/A
Measured BW (kHz), 99% OBW	2011
Type of modulation	RPMA (Random Phase Multiple Access)
Emission classification (F1D, G1D, D1D)	2M01G1D
Transmitter spurious, dBµV/m @ 3 m	70.69 (Peak) and 49.97 (Average) @ 2483.5 MHz
Power requirements	100–220 Vac, 50/60 Hz
Antenna information	HyperLink 2.4 GHz Omni-Directional antenna (L-Com, MN: HG2409U-PRO), 9 dBi

3.4 Product description and theory of operation

The Trilliant SecureReach Network Access Point (AP) is the primary network infrastructure component providing secure, two-way wireless connections to all end points on the Trilliant SecureReach Low Power Wide Area Network1 (LPWAN). The Trilliant SecureReach AP is deployed in a simple and efficient star topology with its endpoints and is ideal for private network operators wishing to minimize their network infrastructure and achieve the lowest cost of ownership leveraging the Trilliant SecureReach LPWAN.

3.5 EUT exercise details

The unit was continuously transmitting during the testing

3.6 EUT setup diagram

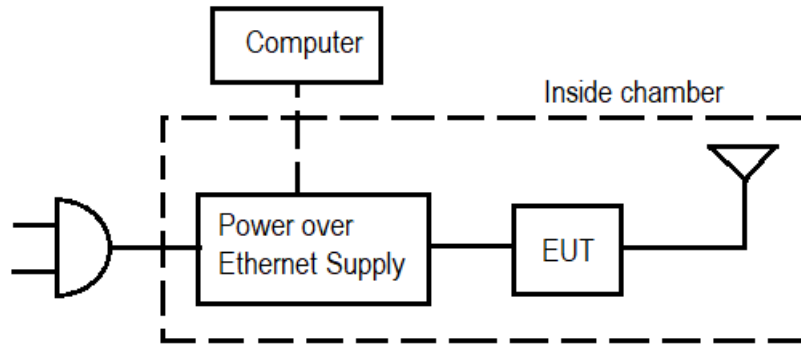

Figure 3.6-1: Setup diagram

Section 4. Engineering considerations

4.1 Modifications incorporated in the EUT

There were no modifications performed to the EUT during this assessment.

4.2 Technical judgment

None

4.3 Deviations from laboratory tests procedures

No deviations were made from laboratory procedures.

Section 5. Test conditions

5.1 Atmospheric conditions

Temperature	15–30 °C
Relative humidity	20–75 %
Air pressure	860–1060 mbar

When it is impracticable to carry out tests under these conditions, a note to this effect stating the ambient temperature and relative humidity during the tests shall be recorded and stated.

5.2 Power supply range

The normal test voltage for equipment to be connected to the mains shall be the nominal mains voltage. For the purpose of the present document, the nominal voltage shall be the declared voltage, or any of the declared voltages $\pm 5\%$, for which the equipment was designed.

Section 6. Measurement uncertainty

6.1 Uncertainty of measurement

UKAS Lab 34 and TIA-603-B have been used as guidance for measurement uncertainty reasonable estimations with regards to previous experience and validation of data. Nemko Canada, Inc. follows these test methods in order to satisfy ISO/IEC 17025 requirements for estimation of uncertainty of measurement for wireless products.

Measurement uncertainty budgets for the tests are detailed below. Measurement uncertainty calculations assume a coverage factor of $K = 2$ with 95% certainty.

Table 6.1-1: Measurement uncertainty

Test name	Measurement uncertainty, dB
All antenna port measurements	0.55
Conducted spurious emissions	1.13
Radiated spurious emissions	3.78
AC power line conducted emissions	3.55

Section 7. Test equipment

7.1 Test equipment list

Table 7.1-1: Equipment list

Equipment	Manufacturer	Model no.	Asset no.	Cal cycle	Next cal.
3 m EMI test chamber (Emissions)	TDK	SAC-3	FA002532	2 year	January 10, 2020
Flush mount turntable	Sunol	FM2022	FA002550	—	NCR
Controller	Sunol	SC104V	FA002551	—	NCR
Antenna mast	Sunol	TLT2	FA002552	—	NCR
Receiver/spectrum analyzer	Rohde & Schwarz	ESU 40	FA002071	1 year	December 9, 2020
Bilog antenna (20–2000 MHz)	Sunol	JB1	FA002517	1 year	January 3, 2020
Horn antenna (1–18 GHz)	EMCO	3115	FA001451	1 year	April 12, 2020
Pre-amplifier (0.5–18 GHz)	Com-Power	PAM-118A	FA002561	1 year	September 18, 2020
Horn antenna (18–40 GHz)	EMCO	3116	FA002487	52056	December 20, 2019
LISN	Rohde & Schwarz	ENV216	FA002514	1 year	January 23, 2020

Notes: NCR - no calibration required



Section 8. Testing data

8.1 FCC 15.31(e) Variation of power source

8.1.1 Definitions and limits

For intentional radiators, measurements of the variation of the input power or the radiated signal level of the fundamental frequency component of the emission, as appropriate, shall be performed with the supply voltage varied between 85% and 115% of the nominal rated supply voltage. For battery operated equipment, the equipment tests shall be performed using a new battery.

8.1.2 Test date

Start date December 10, 2019

8.1.3 Observations, settings and special notes

The testing was performed as per ANSI C63.10 Section 5.13.

- a) Where the device is intended to be powered from an external power adapter, the voltage variations shall be applied to the input of the adapter provided with the device at the time of sale. If the device is not marketed or sold with a specific adapter, then a typical power adapter shall be used.
- b) For devices where operating at a supply voltage deviating $\pm 15\%$ from the nominal rated value may cause damages or loss of intended function, test to minimum and maximum allowable voltage per manufacturer's specification and document in the report.
- c) For devices with wide range of rated supply voltage, test at 15% below the lowest and 15% above the highest declared nominal rated supply voltage.
- d) For devices obtaining power from an input/output (I/O) port (USB, firewire, etc.), a test jig is necessary to apply voltage variation to the device from a support power supply, while maintaining the functionalities of the device.

For battery-operated equipment, the equipment tests shall be performed using a variable power supply.

8.1.4 Test data

EUT Power requirements:

- | | | | |
|---------------------------------------------------------------------------------------------------|----------------------------------------|----------------------------------------|-----------------------------------------|
| | <input checked="" type="checkbox"/> AC | <input type="checkbox"/> DC | <input type="checkbox"/> Battery |
| If EUT is an AC or a DC powered, was the noticeable output power variation observed? | <input type="checkbox"/> YES | <input checked="" type="checkbox"/> NO | <input type="checkbox"/> N/A |
| If EUT is battery operated, was the testing performed using fresh batteries? | <input type="checkbox"/> YES | <input type="checkbox"/> NO | <input checked="" type="checkbox"/> N/A |
| If EUT is rechargeable battery operated, was the testing performed using fully charged batteries? | <input type="checkbox"/> YES | <input type="checkbox"/> NO | <input checked="" type="checkbox"/> N/A |

8.2 FCC 15.31(m) and RSS-Gen 6.9 Number of frequencies

8.2.1 Definitions and limits

FCC:

Measurements on intentional radiators or receivers shall be performed and, if required, reported for each band in which the device can be operated with the device operating at the number of frequencies in each band specified in the following table.

ISED:

Except where otherwise specified, measurements shall be performed for each frequency band of operation for which the radio apparatus is to be certified, with the device operating at the frequencies in each band of operation shown in table below. The frequencies selected for measurements shall be reported in the test report.

Table 8.2-1: Frequency Range of Operation

Frequency range over which the device operates (in each band)	Number of test frequencies required	Location of measurement frequency inside the operating frequency range
1 MHz or less	1	Center (middle of the band)
1–10 MHz	2	1 near high end, 1 near low end
Greater than 10 MHz	3	1 near high end, 1 near center and 1 near low end

Note: “near” means as close as possible to or at the centre / low end / high end of the frequency range over which the device operates.

8.2.2 Test date

Start date July 16, 2019

8.2.3 Observations, settings and special notes

Per ANSI C63.10 Subclause 5.6.2.1:

The number of channels tested can be reduced by measuring the center channel bandwidth first and then applying the following relaxations as appropriate:

- a) For each operating mode, if the measured channel bandwidth on the middle channel is at least 150% of the minimum permitted bandwidth, then it is not necessary to measure the bandwidth on the high and low channels.
- b) For multiple-input multiple-output (MIMO) systems, if the measured channel bandwidth on testing the middle channel exceeds the minimum permitted bandwidth by more than 50% on one transmit chain, then it is not necessary to repeat testing on the other chains.
- c) If the measured channel bandwidth on the middle channel is less than 50% of the maximum permitted bandwidth, then it is not necessary to measure the bandwidth on the high and low channels.

Per ANSI C63.10 Subclause 5.6.2.2:

For devices with multiple operating modes, measurements on the middle channel can be used to determine the worst-case mode(s). The worst-case modes are as follows:

- a) Band edge requirements—Measurements on the mode with the widest bandwidth can be used to cover the same channel (center frequency) on modes with narrower bandwidth that have the same or lower output power for each modulation family (e.g., OFDM and direct sequence spread spectrum).
- b) Spurious emissions—Measure the mode with the highest output power and the mode with the highest output power spectral density for each modulation family (e.g., OFDM and direct sequence spread spectrum).
- c) In-band PSD—Measurements on the mode with the narrowest bandwidth can be used to cover all modes within the same modulation family of an equal or lower output power provided the result is less than 50% of the limit.



8.2.4 Test data

Table 8.2-2: *Test channels selection*

Start of Frequency range, MHz	End of Frequency range, MHz	Frequency range bandwidth, MHz	Low channel, MHz	Mid channel, MHz	High channel, MHz
2400	2483.5	83.5	2402	2440	2475



8.3 FCC 15.203 and RSS-Gen, section 6.8 Antenna requirement

8.3.1 Definitions and limits

FCC:

An intentional radiator shall be designed to ensure that no antenna other than that furnished by the responsible party shall be used with the device. The use of a permanently attached antenna or of an antenna that uses a unique coupling to the intentional radiator shall be considered sufficient to comply with the provisions of this section. The manufacturer may design the unit so that a broken antenna can be replaced by the user, but the use of a standard antenna jack or electrical connector is prohibited. This requirement does not apply to intentional radiators that must be professionally installed, such as perimeter protection systems and some field disturbance sensors, or to other intentional radiators which, in accordance with §15.31(d), must be measured at the installation site. However, the installer shall be responsible for ensuring that the proper antenna is employed so that the limits in this part are not exceeded.

ISED:

The applicant for equipment certification shall provide a list of all antenna types that may be used with the transmitter, where applicable (i.e. for transmitters with detachable antenna), indicating the maximum permissible antenna gain (in dBi) and the required impedance for each antenna. The test report shall demonstrate the compliance of the transmitter with the limit for maximum equivalent isotropically radiated power (e.i.r.p.) specified in the applicable RSS, when the transmitter is equipped with any antenna type, selected from this list.

For expediting the testing, measurements may be performed using only the antenna with highest gain of each combination of transmitter and antenna type, with the transmitter output power set at the maximum level. However, the transmitter shall comply with the applicable requirements under all operational conditions and when in combination with any type of antenna from the list provided in the test report.

8.3.2 Test date

Start date October 30, 2019

8.3.3 Observations, settings and special notes

None

8.3.4 Test data

Must the EUT be professionally installed? YES NO
Does the EUT have detachable antenna(s)? YES NO
 If detachable, is the antenna connector(s) non-standard? YES NO N/A



8.4 FCC 15.207(a) and RSS-Gen 8.8 AC power line conducted emissions limits

8.4.1 Definitions and limits

FCC:

Except as shown in paragraphs (b) and (c) of this section, for an intentional radiator that is designed to be connected to the public utility (AC) power line, the radio frequency voltage that is conducted back onto the AC power line on any frequency or frequencies, within the band 150 kHz to 30 MHz, shall not exceed the limits in the following table, as measured using a 50 μH/50 Ω line impedance stabilization network (LISN). Compliance with the provisions of this paragraph shall be based on the measurement of the radio frequency voltage between each power line and ground at the power terminal. The lower limit applies at the boundary between the frequency ranges.

ANSI: C63.10 subclause 6.2

If the EUT normally receives power from another device that in turn connects to the public utility ac power lines, measurements shall be made on that device with the EUT in operation to demonstrate that the device continues to comply with the appropriate limits while providing the EUT with power. If the EUT is

operated only from internal or dedicated batteries, with no provisions for connection to the public utility ac power lines (600 VAC or less) to operate the EUT (such as an adapter), then ac power-line conducted measurements are not required.

For direct current (dc) powered devices where the ac power adapter is not supplied with the device, an “off-the-shelf” unmodified ac power adapter shall be used. If the device is supposed to be installed in a host (e.g., the device is a module or PC card), then it is tested in a typical compliant host.

IC:

A radio apparatus that is designed to be connected to the public utility (AC) power line shall ensure that the radio frequency voltage, which is conducted back onto the AC power line on any frequency or frequencies within the band 150 kHz to 30 MHz, shall not exceed the limits in table below.

Unless the requirements applicable to a given device state otherwise, for any radio apparatus equipped to operate from the public utility AC power supply either directly or indirectly (such as with a battery charger), the radio frequency voltage of emissions conducted back onto the AC power lines in the frequency range of 0.15 MHz to 30 MHz shall not exceed the limits shown in table below. The more stringent limit applies at the frequency range boundaries.

Table 8.4-1: Conducted emissions limit

Frequency of emission, MHz	Quasi-peak	Conducted limit, dBμV	Average**
0.15–0.5	66 to 56*		56 to 46*
0.5–5	56		46
5–30	60		50

Note: * - The level decreases linearly with the logarithm of the frequency.

** - A linear average detector is required.

8.4.2 Test date

Start date December 10, 2019



8.4.3 Observations, settings and special notes

The EUT was set up as tabletop configuration.

The spectral scan has been corrected with transducer factors (i.e. cable loss, LISN factors, and attenuators) for determination of compliance.

A preview measurement was generated with the receiver in continuous scan mode. Emissions detected within 6 dB or above limit were re-measured with the appropriate detector against the correlating limit and recorded as the final measurement.

Receiver settings for preview measurements:

Resolution bandwidth	9 kHz
Video bandwidth	30 kHz
Detector mode	Peak and Average
Trace mode	Max Hold
Measurement time	1000 ms

Receiver settings for final measurements:

Resolution bandwidth	9 kHz
Video bandwidth	30 kHz
Detector mode	Quasi-Peak and Average
Trace mode	Max Hold
Measurement time	1000 ms



8.4.4 Test data

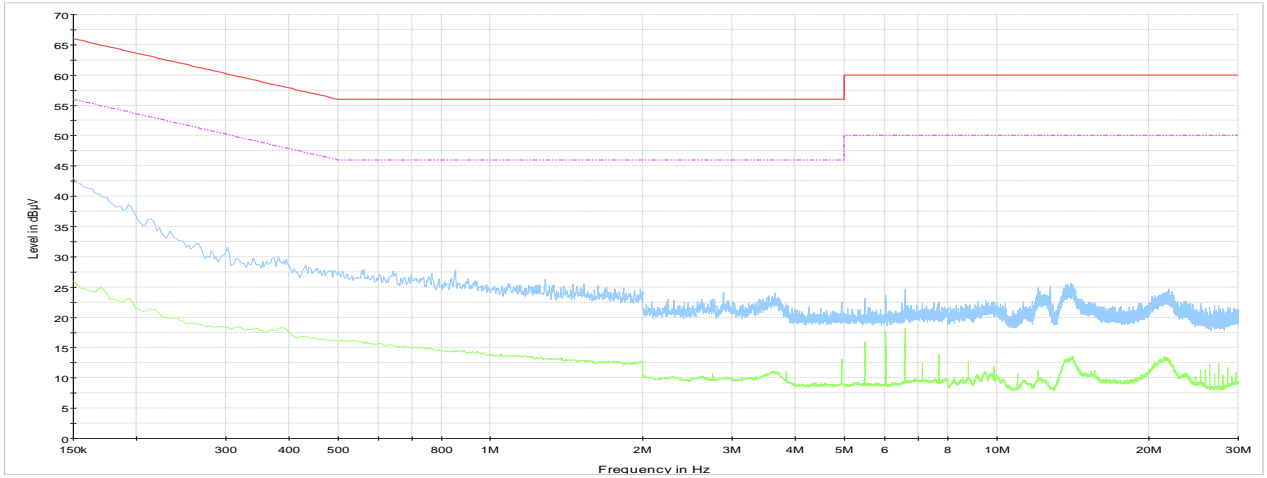

Plot 8.4-1: *Conducted emissions on phase line*

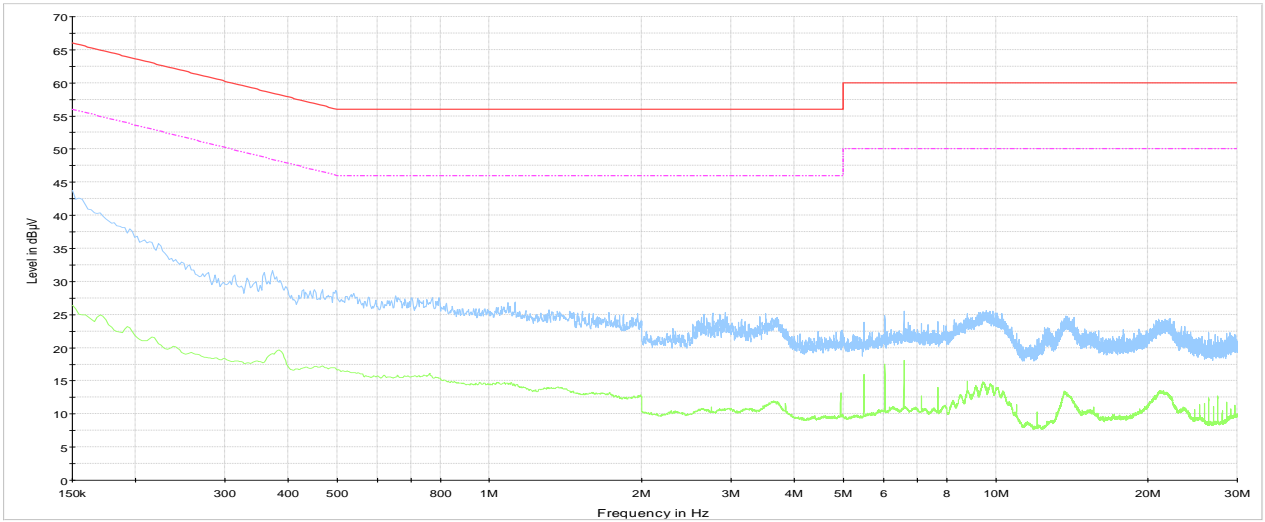

Plot 8.4-2: *Conducted emissions on neutral line*



8.5 FCC 15.247(a)(2) and RSS-247 5.2(a) Minimum 6 dB bandwidth for DTS systems

8.5.1 Definitions and limits

FCC:

Systems using digital modulation techniques may operate in the 902–928 MHz, 2400–2483.5 MHz, and 5725–5850 MHz bands. The minimum 6 dB bandwidth shall be at least 500 kHz.

ISED:

The minimum 6 dB bandwidth shall be 500 kHz.

8.5.1 Test date

Start date December 10, 2019

8.5.2 Observations, settings and special notes

The test was performed as per KDB 558074, section 8.2 with reference to ANSI C63.10 subclause 11.8.
Spectrum analyser settings:

Resolution bandwidth	100 kHz
Video bandwidth	≥3 × RBW
Frequency span	5 MHz
Detector mode	Peak
Trace mode	Max Hold

8.5.3 Test data

Table 8.5-1: 6 dB bandwidth results

Frequency, MHz	6 dB bandwidth, kHz	Minimum limit, kHz	Margin, kHz
2402	1172	500.0	672
2440	1099	500.0	599
2475	1237	500.0	737

Notes: None

Table 8.5-2: 99% OBW results

Frequency, MHz	99% OBW, kHz
2402	1982
2440	2011
2475	2004

Notes: None

8.5.4 Test data, continued

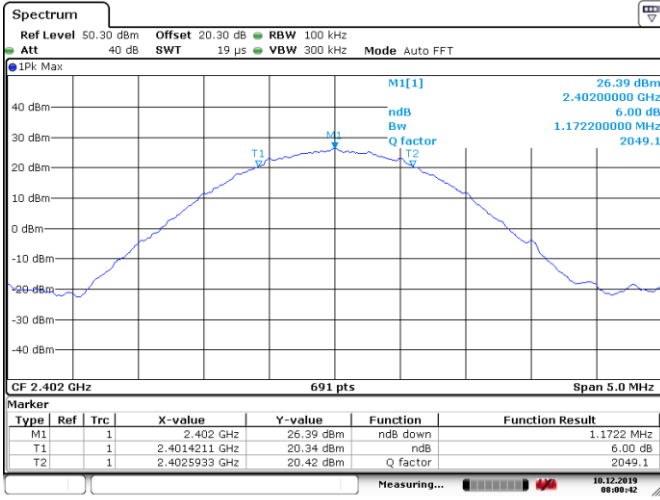

Date: 10 DEC 2019 08:00:42

Figure 8.5-1: 6 dB bandwidth on low channel

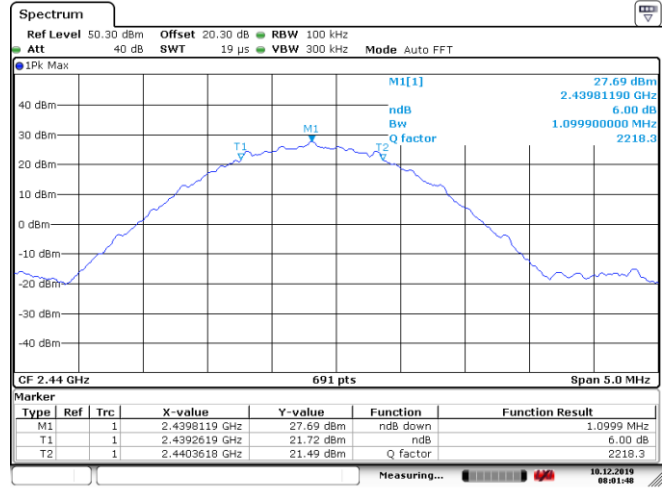

Date: 10 DEC 2019 08:01:49

Figure 8.5-2: 6 dB bandwidth on mid channel

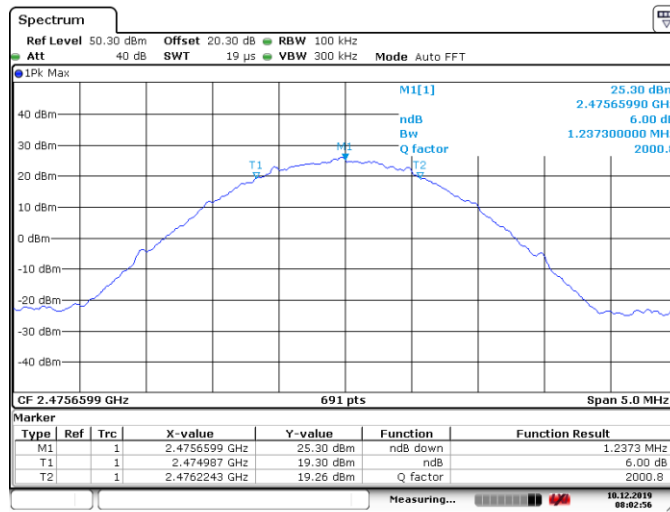

Date: 10 DEC 2019 08:02:57

Figure 8.5-3: 6 dB bandwidth on high channel

8.5.5 Test data, continued

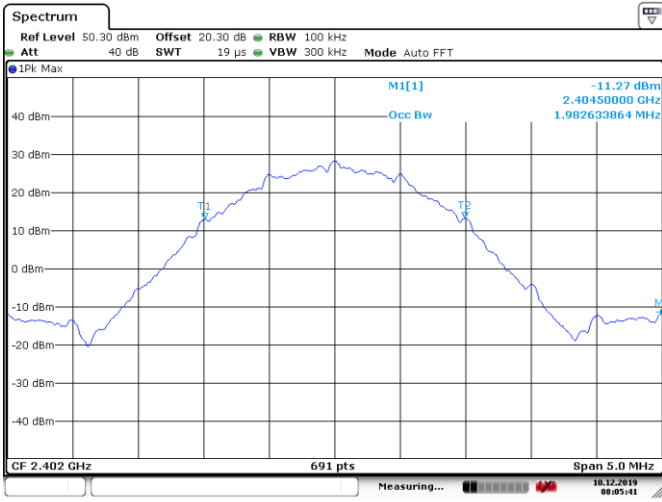

Date: 10.DEC.2019 08:05:41

Figure 8.5-4: 99% bandwidth on low channel

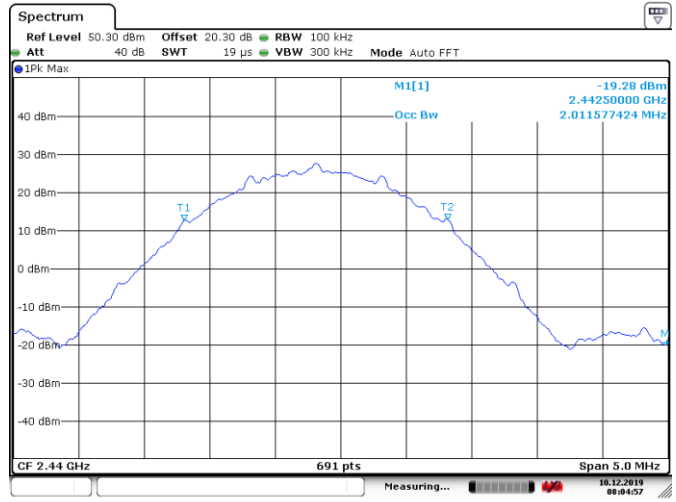

Date: 10.DEC.2019 08:04:57

Figure 8.5-5: 99% bandwidth on mid channel

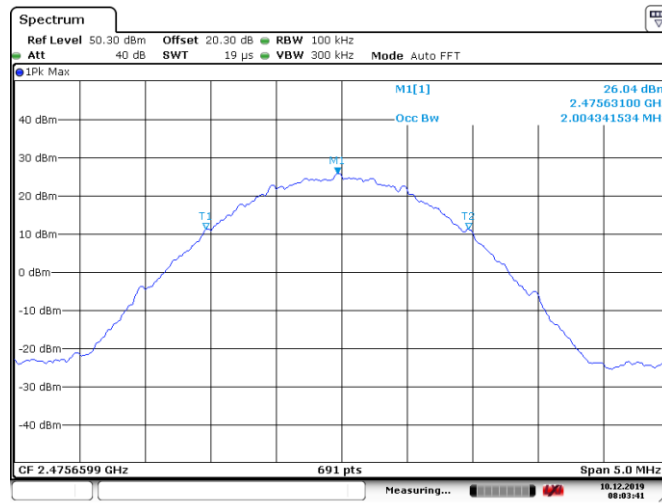

Date: 10.DEC.2019 08:03:41

Figure 8.5-6: 99% bandwidth on high channel



8.6 FCC 15.247(b) and RSS-247 5.4(d) Transmitter output power and e.i.r.p. requirements for DTS in 2 GHz

8.6.1 Definitions and limits

FCC:

- (b) The maximum peak conducted output power of the intentional radiator shall not exceed the following:
- (3) For systems using digital modulation in the 2400–2483.5 MHz band: 1 W (30 dBm). As an alternative to a peak power measurement, compliance with the one Watt limit can be based on a measurement of the maximum conducted output power. Maximum Conducted Output Power is defined as the total transmit power delivered to all antennas and antenna elements averaged across all symbols in the signaling alphabet when the transmitter is operating at its maximum power control level. Power must be summed across all antennas and antenna elements. The average must not include any time intervals during which the transmitter is off or is transmitting at a reduced power level. If multiple modes of operation are possible (e.g., alternative modulation methods), the maximum conducted output power is the highest total transmit power occurring in any mode.
 - (4) The conducted output power limit specified in paragraph (b) of this section is based on the use of antennas with directional gains that do not exceed 6 dBi. Except as shown in paragraph (c) of this section, if transmitting antennas of directional gain greater than 6 dBi are used, the conducted output power from the intentional radiator shall be reduced below the stated values in paragraphs (b)(1), (b)(2), and (b)(3) of this section, as appropriate, by the amount in dB that the directional gain of the antenna exceeds 6 dBi.
- (c) Operation with directional antenna gains greater than 6 dBi.
- (1) Fixed point-to-point operation:
- (i) Systems operating in the 2400–2483.5 MHz band that are used exclusively for fixed, point-to-point operations may employ transmitting antennas with directional gain greater than 6 dBi provided the maximum conducted output power of the intentional radiator is reduced by 1 dB for every 3 dB that the directional gain of the antenna exceeds 6 dBi.
- (iii) Fixed, point-to-point operation, as used in paragraphs (c)(1)(i) and (c)(1)(ii) of this section, excludes the use of point-to-multipoint systems, omnidirectional applications, and multiple co-located intentional radiators transmitting the same information. The operator of the spread spectrum or digitally modulated intentional radiator or, if the equipment is professionally installed, the installer is responsible for ensuring that the system is used exclusively for fixed, point-to-point operations. The instruction manual furnished with the intentional radiator shall contain language in the installation instructions informing the operator and the installer of this responsibility.
- (2) In addition to the provisions in paragraphs (b)(1), (b)(3), (b)(4) and (c)(1)(i) of this section, transmitters operating in the 2400–2483.5 MHz band that emit multiple directional beams, simultaneously or sequentially, for the purpose of directing signals to individual receivers or to groups of receivers provided the emissions comply with the following:
- (i) Different information must be transmitted to each receiver.
- (ii) If the transmitter employs an antenna system that emits multiple directional beams but does not do emit multiple directional beams simultaneously, the total output power conducted to the array or arrays that comprise the device, i.e., the sum of the power supplied to all antennas, antenna elements, staves, etc. and summed across all carriers or frequency channels, shall not exceed the limit specified in paragraph (b)(1) or (b)(3) of this section, as applicable. However, the total conducted output power shall be reduced by 1 dB below the specified limits for each 3 dB that the directional gain of the antenna/antenna array exceeds 6 dBi. The directional antenna gain shall be computed as follows:
- (A) The directional gain shall be calculated as the sum of 10 log (number of array elements or staves) plus the directional gain of the element or stave having the highest gain.
- (B) A lower value for the directional gain than that calculated in paragraph (c)(2)(ii)(A) of this section will be accepted if sufficient evidence is presented, e.g., due to shading of the array or coherence loss in the beamforming.
- (iii) If a transmitter employs an antenna that operates simultaneously on multiple directional beams using the same or different frequency channels, the power supplied to each emission beam is subject to the power limit specified in paragraph (c)(2)(ii) of this section. If transmitted beams overlap, the power shall be reduced to ensure that their aggregate power does not exceed the limit specified in paragraph (c)(2)(ii) of this section. In addition, the aggregate power transmitted simultaneously on all beams shall not exceed the limit specified in paragraph (c)(2)(ii) of this section by more than 8 dB.
- (iv) Transmitters that emit a single directional beam shall operate under the provisions of paragraph (c)(1) of this section.



ISED:

d. For DTSSs employing digital modulation techniques operating in the 2400–2483.5 MHz band, the maximum peak conducted output power shall not exceed 1 W. The e.i.r.p. shall not exceed 4 W, except as provided in section 5.4(e).

As an alternative to a peak power measurement, compliance can be based on a measurement of the maximum conducted output power. The maximum conducted output power is the total transmit power delivered to all antennas and antenna elements, averaged across all symbols in the signalling alphabet when the transmitter is operating at its maximum power control level. Power must be summed across all antennas and antenna elements. The average must not include any time intervals during which the transmitter is off or transmitting at a reduced power level. If multiple modes of operation are implemented, the maximum conducted output power is the highest total transmit power occurring in any mode.

e. Fixed point-to-point systems in the 2400–2483.5 MHz band are permitted to have an e.i.r.p. higher than 4 W provided that the higher e.i.r.p. is achieved by employing higher gain directional antennas and not higher transmitter output powers. Point-to-multipoint systems, omnidirectional applications and multiple co-located transmitters transmitting the same information are prohibited from exceeding an e.i.r.p. of 4 W.

f. Transmitters operating in the band 2400–2483.5 MHz, may employ antenna systems that emit multiple directional beams simultaneously or sequentially, for the purpose of directing signals to individual receivers or to groups of receivers, provided that the emissions comply with the following:

- i Different information must be transmitted to each receiver.
- ii If the transmitter employs an antenna system that emits multiple directional beams, but does not emit multiple directional beams simultaneously, the total output power conducted to the array or arrays that comprise the device (i.e. the sum of the power supplied to all antennas, antenna elements, staves, etc., and summed across all carriers or frequency channels) shall not exceed the applicable output power limit specified in sections 5.4(b) and 5.4(d). However, the total conducted output power shall be reduced by 1 dB below the specified limits for each 3 dB that the directional gain of the antenna/antenna array exceeds 6 dBi. The directional antenna gain shall be computed as the sum of 10 log (number of array elements or staves) plus the directional gain of the element or stave having the highest gain.
- iii If a transmitter employs an antenna that operates simultaneously on multiple directional beams using the same or different frequency channels, the power supplied to each emission beam is subject to the applicable power limit specified in sections 5.4(b) and 5.4(d). If transmitted beams overlap, the power shall be reduced to ensure that their aggregate power does not exceed the applicable limit specified in sections 5.4(b) and 5.4(d). In addition, the aggregate power transmitted simultaneously on all beams shall not exceed the applicable limit specified in sections 5.4(b) and 5.4(d) by more than 8 dB.
- iv Transmitters that transmit a single directional beam shall operate under the provisions of sections 5.4(b), 5.4(d) and 5.4(e).

8.6.1 Test date

Start date December 12, 2019

8.6.2 Observations, settings and special notes

The test was performed using method AVGSA-1 (trace averaging with the EUT transmitting at full power throughout each sweep).
Spectrum analyser settings:

Resolution bandwidth	100 kHz
Video bandwidth	1 MHz
Frequency span	5 MHz
Detector mode	RMS
Trace mode	Power Average

8.6.3 Test data

Table 8.6-1: Output power measurements results

Frequency, MHz	Conducted output power, dBm		Margin, dB	Antenna gain, dBi	EIRP, dBm	EIRP limit, dBm	EIRP margin, dB
	Measured	Limit					
2402	25.20	27.00	1.80	9.0	34.20	36.00	1.80
2440	25.51	27.00	1.49	9.0	34.51	36.00	1.49
2475	26.12	27.00	0.88	9.0	35.12	36.00	0.88

Note1: Limit Calculations: For antenna gain exceeding 6 dBi: The limit will be 30 dBm – (9 dBi – 6 dBi) = 27 dBm

Note2: Different EUT settings would allow different output powers. For these measurements, setting 29 was used.



Measurement samples

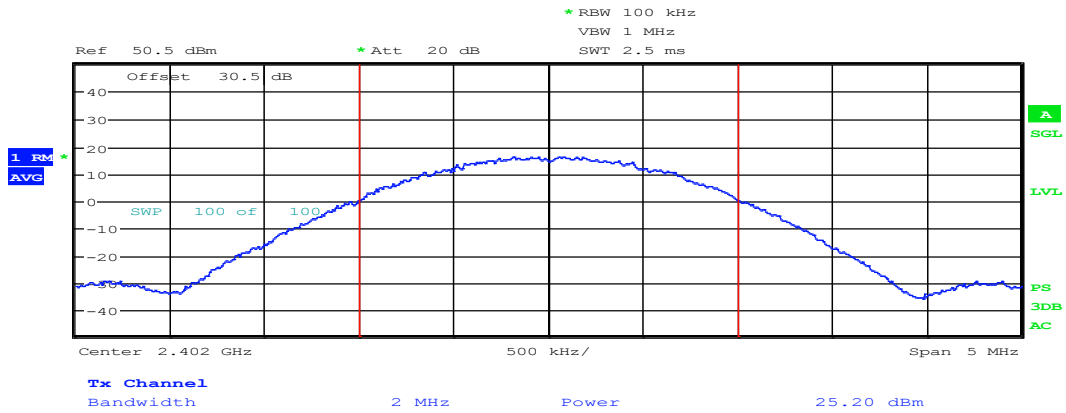

Figure 8.6-1: Output power on low channel

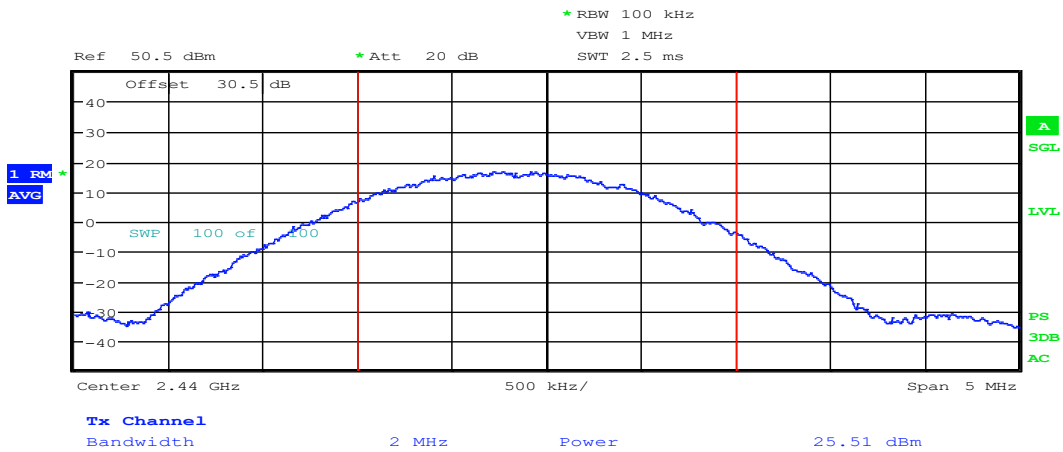

Figure 8.6-2: Output power on High channel

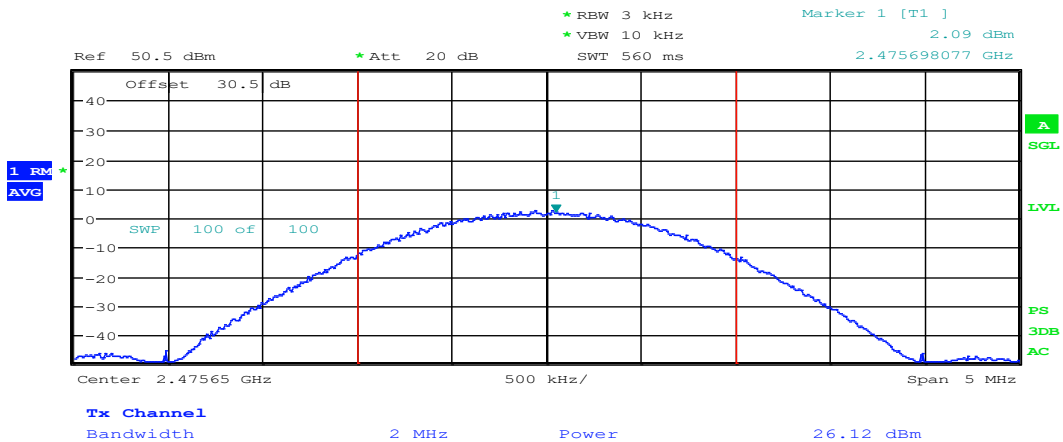

Figure 8.6-3: Output power on High channel



8.7 FCC 15.247(d) and RSS-247 5.5 Spurious (out-of-band) unwanted emissions

8.7.1 Definitions and limits

FCC:

In any 100 kHz bandwidth outside the frequency band in which the spread spectrum or digitally modulated intentional radiator is operating, the radio frequency power that is produced by the intentional radiator shall be at least 20 dB below that in the 100 kHz bandwidth within the band that contains the highest level of the desired power, based on either an RF conducted or a radiated measurement, provided the transmitter demonstrates compliance with the peak conducted power limits. If the transmitter complies with the conducted power limits based on the use of RMS averaging over a time interval, as permitted under paragraph (b)(3) of this section, the attenuation required under this paragraph shall be 30 dB instead of 20 dB. Attenuation below the general limits specified in §15.209(a) is not required. In addition, radiated emissions which fall in the restricted bands, as defined in §15.205(a), must also comply with the radiated emission limits specified in §15.209(a) (see §15.205(c)).

ISED:

In any 100 kHz bandwidth outside the frequency band in which the spread spectrum or digitally modulated device is operating, the RF power that is produced shall be at least 20 dB below that in the 100 kHz bandwidth within the band that contains the highest level of the desired power, based on either an RF conducted or a radiated measurement, provided that the transmitter demonstrates compliance with the peak conducted power limits. If the transmitter complies with the conducted power limits based on the use of root-mean-square averaging over a time interval, as permitted under section 5.4(d), the attenuation required shall be 30 dB instead of 20 dB. Attenuation below the general field strength limits specified in RSS-Gen is not required.

Table 8.7-1: FCC §15.209 and RSS-Gen – Radiated emission limits

Frequency, MHz	Field strength of emissions		Measurement distance, m
	µV/m	dBµV/m	
0.009–0.490	2400/F	67.6 – 20 × log ₁₀ (F)	300
0.490–1.705	24000/F	87.6 – 20 × log ₁₀ (F)	30
1.705–30.0	30	29.5	30
30–88	100	40.0	3
88–216	150	43.5	3
216–960	200	46.0	3
above 960	500	54.0	3

Notes: In the emission table above, the tighter limit applies at the band edges.

For frequencies above 1 GHz the limit on peak RF emissions is 20 dB above the maximum permitted average emission limit applicable to the equipment under test

Table 8.7-2: ISED restricted frequency bands

MHz	MHz	MHz	GHz
0.090–0.110	12.57675–12.57725	399.9–410	7.25–7.75
0.495–0.505	13.36–13.41	608–614	8.025–8.5
2.1735–2.1905	16.42–16.423	960–1427	9.0–9.2
3.020–3.026	16.69475–16.69525	1435–1626.5	9.3–9.5
4.125–4.128	16.80425–16.80475	1645.5–1646.5	10.6–12.7
4.17725–4.17775	25.5–25.67	1660–1710	13.25–13.4
4.20725–4.20775	37.5–38.25	1718.8–1722.2	14.47–14.5
5.677–5.683	73–74.6	2200–2300	15.35–16.2
6.215–6.218	74.8–75.2	2310–2390	17.7–21.4
6.26775–6.26825	108–138	2483.5–2500	22.01–23.12
6.31175–6.31225	149.9–150.05	2655–2900	23.6–24.0
8.291–8.294	156.52475–156.52525	3260–3267	31.2–31.8
8.362–8.366	156.7–156.9	3332–3339	36.43–36.5
8.37625–8.38675	162.0125–167.17	3345.8–3358	
8.41425–8.41475	167.72–173.2	3500–4400	
12.29–12.293	240–285	4500–5150	Above 38.6
12.51975–12.52025	322–335.4	5350–5460	

Note: Certain frequency bands listed in Table 8.7-2 and above 38.6 GHz are designated for licence-exempt applications. These frequency bands and the requirements that apply to related devices are set out in the 200 and 300 series of RSSs.



Table 8.7-3: FCC restricted frequency bands

MHz	MHz	MHz	GHz
0.090–0.110	16.42–16.423	399.9–410	4.5–5.15
0.495–0.505	16.69475–16.69525	608–614	5.35–5.46
2.1735–2.1905	16.80425–16.80475	960–1240	7.25–7.75
4.125–4.128	25.5–25.67	1300–1427	8.025–8.5
4.17725–4.17775	37.5–38.25	1435–1626.5	9.0–9.2
4.20725–4.20775	73–74.6	1645.5–1646.5	9.3–9.5
6.215–6.218	74.8–75.2	1660–1710	10.6–12.7
6.26775–6.26825	108–121.94	1718.8–1722.2	13.25–13.4
6.31175–6.31225	123–138	2200–2300	14.47–14.5
8.291–8.294	149.9–150.05	2310–2390	15.35–16.2
8.362–8.366	156.52475–156.52525	2483.5–2500	17.7–21.4
8.37625–8.38675	156.7–156.9	2690–2900	22.01–23.12
8.41425–8.41475	162.0125–167.17	3260–3267	23.6–24.0
12.29–12.293	167.72–173.2	3332–3339	31.2–31.8
12.51975–12.52025	240–285	3345.8–3358	36.43–36.5
12.57675–12.57725	322–335.4	3600–4400	Above 38.6
13.36–13.41			

8.7.1 Test date

Start date July 15, 2019

8.7.2 Observations, settings and special notes

The spectrum was searched from 30 MHz to the 10th harmonic.
 EUT was set to transmit with 100 % duty cycle.
 Radiated measurements were performed at a distance of 3 m,
 DTS emissions in non-restricted frequency bands test was performed as per KDB 558074, section 8.5 with reference to ANSI C63.10 subclause 11.11.
 Since fundamental power was tested using maximum conducted (average) output power procedure to demonstrate compliance, the spurious emissions limit is -30 dBc/100 kHz.
 DTS emissions in restricted frequency bands test was performed as per KDB 558074, section 8.6 with reference to ANSI C63.10 subclause 11.12.
 DTS band-edge emission measurements test was performed as per KDB 558074, section 8.7 with reference to ANSI C63.10 subclause 11.13.

Spectrum analyser settings for radiated measurements within restricted bands below 1 GHz:

Resolution bandwidth:	100 kHz
Video bandwidth:	300 kHz
Detector mode:	Peak
Trace mode:	Max Hold

Spectrum analyser settings for peak radiated measurements within restricted bands above 1 GHz:

Resolution bandwidth:	1 MHz (Peak); 1 MHz (Average)
Video bandwidth:	3 MHz (Peak); 10 Hz (Average)
Detector mode:	Peak
Trace mode:	Max Hold

Spectrum analyser settings for conducted spurious emissions measurements:

Resolution bandwidth:	100 kHz
Video bandwidth:	300 kHz
Detector mode:	Peak
Trace mode:	Max Hold

Table 8.7-4: Radiated field strength measurement results

Channel	Frequency, MHz	Peak Field strength, dBμV/m		Peak margin, dB	Average Field strength, dBμV/m		Margin, dB
		Measured	Limit		Measured	Limit	
Low	2390.0	68.39	74.00	5.61	50.53	54.00	3.47
High	2483.5	70.69	74.00	3.31	49.97	54.00	4.03

Notes: Field strength (dBμV/m) = Spectrum analyzer value (dBμV) + transducer factors (dB)
 Transducer factors (i.e. antenna factors, cable loss, amplifier gains, and attenuators).

8.7.4 Test data

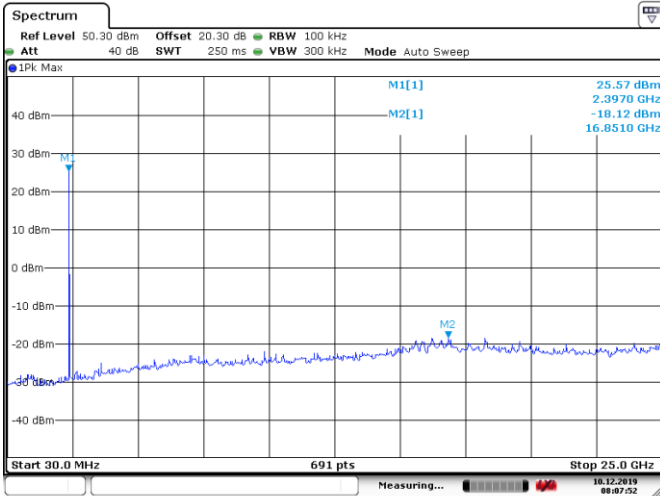

Date: 10 DEC.2019 08:07:53

Figure 8.7-1: Conducted spurious (out-of-band) emissions, low channel

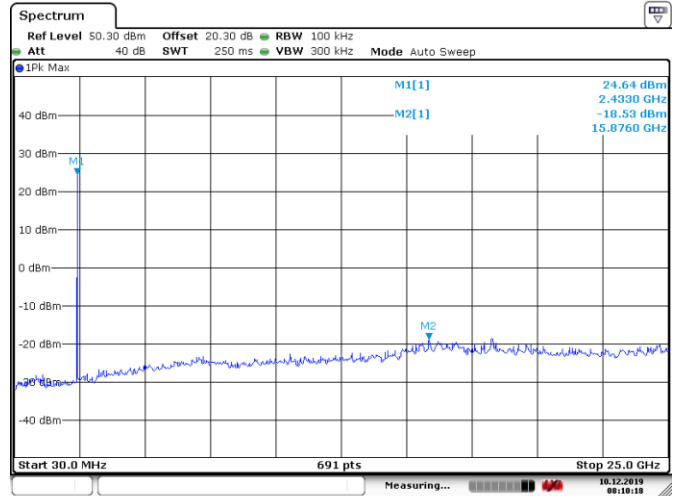

Date: 10 DEC.2019 08:10:19

Figure 8.7-2: Conducted spurious (out-of-band) emissions, mid channel

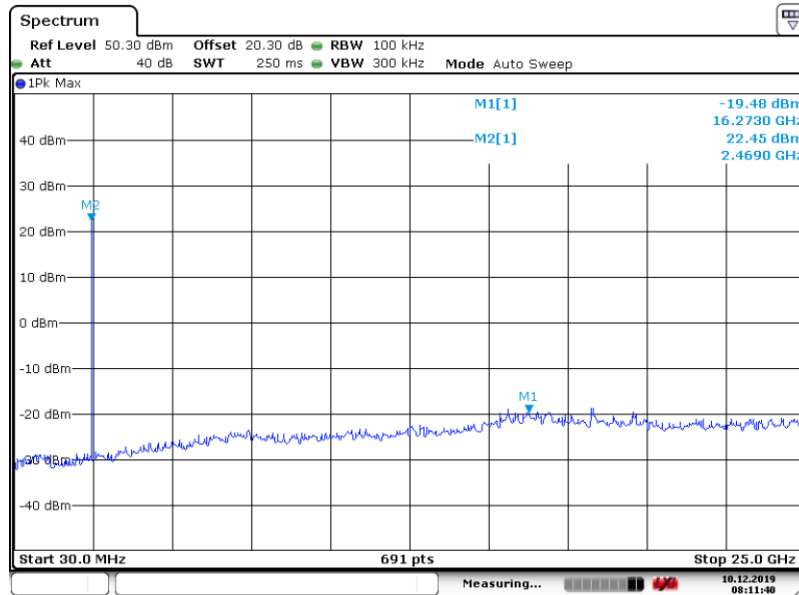

Date: 10 DEC.2019 08:11:39

Figure 8.7-3: Conducted spurious (out-of-band) emissions, high channel

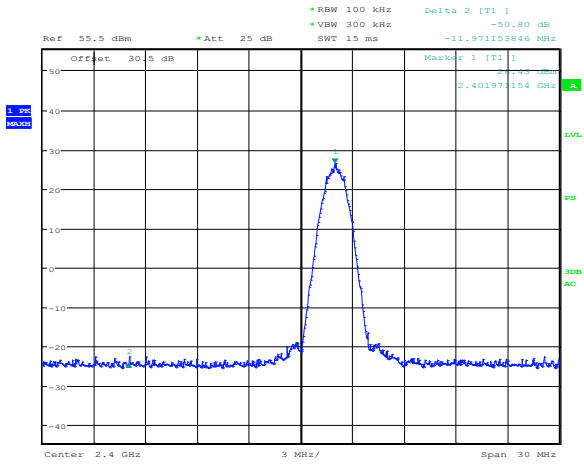

Date: 12.DEC.2019 10:34:19

Figure 8.7-4: Conducted spurious emissions, lower band edge

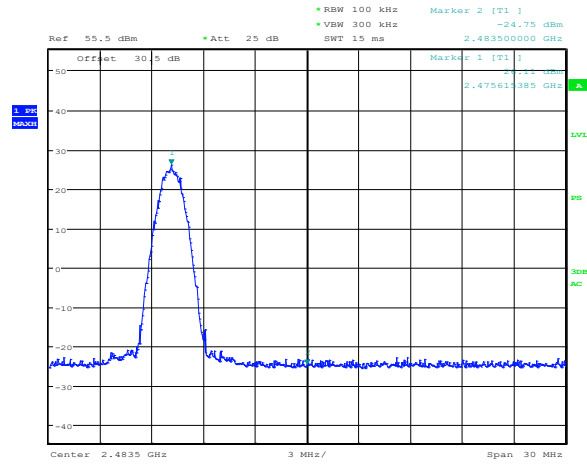

Date: 12.DEC.2019 11:03:45

Figure 8.7-5: Conducted spurious emissions, Higher band edge

Table 8.7-5: Band edge results

Band Edge	Fundamental ref. level, dBm	Frequency (MHz)	Band edge level, dBm	Limit, dBm	EIRP margin, dBm
Lower band edge	26.43	2400.0	-24.37	-3.57	20.80
Higher band edge	26.11	2483.5	-24.75	-3.89	20.86

Note: Limit = Peak – 30 dBc

8.7.4 Test data

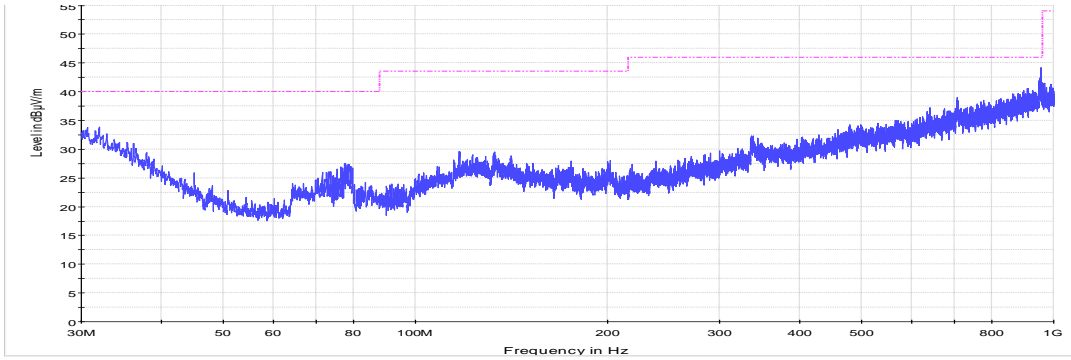

Figure 8.7-6: Radiated spurious (out-of-band) emissions, low channel

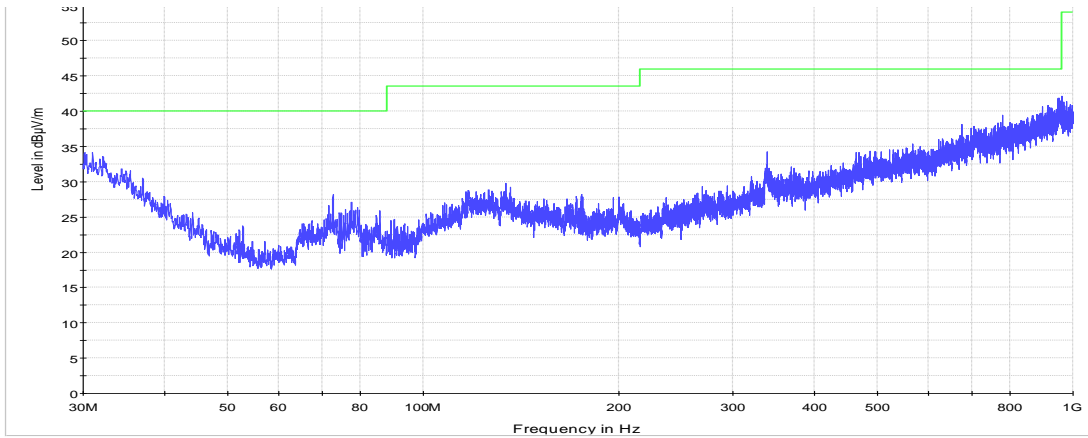

Figure 8.7-7: Radiated spurious (out-of-band) emissions, mid channel

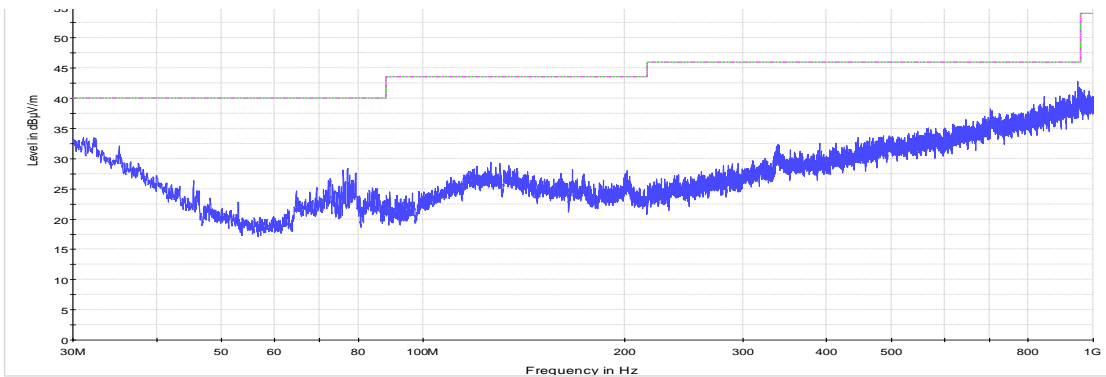

Figure 8.7-8: Radiated spurious (out-of-band) emissions, high channel

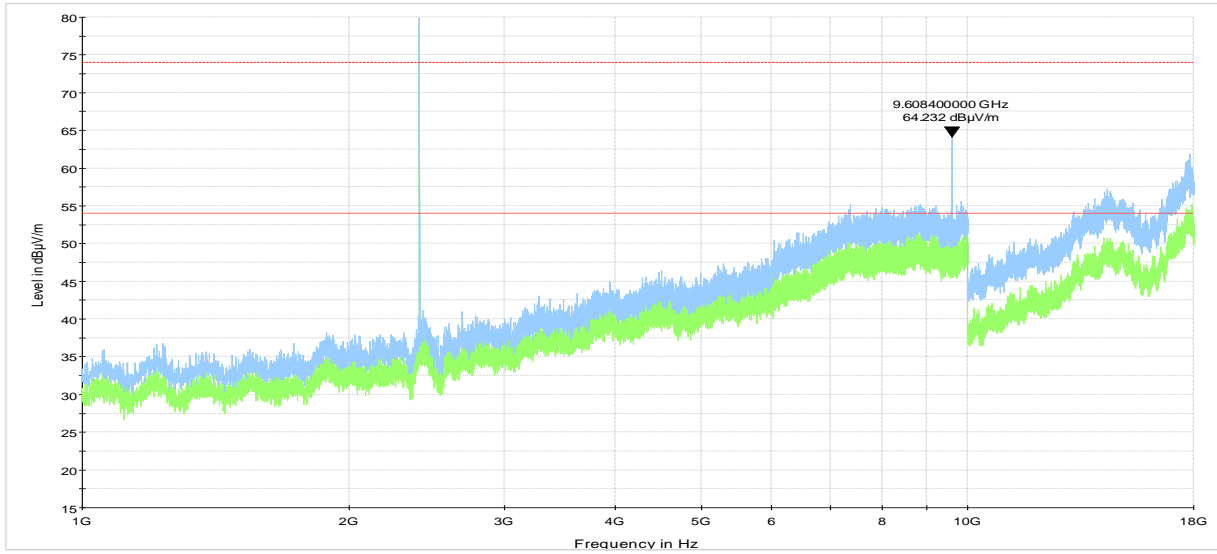

Figure 8.7-9: Radiated spurious (out-of-band) emissions, above 1 GHz low channel

Note: Spectrum was investigated up to 25 GHz, no emission related to RF transmission was detected within 6 dB below the limit above 18 GHz

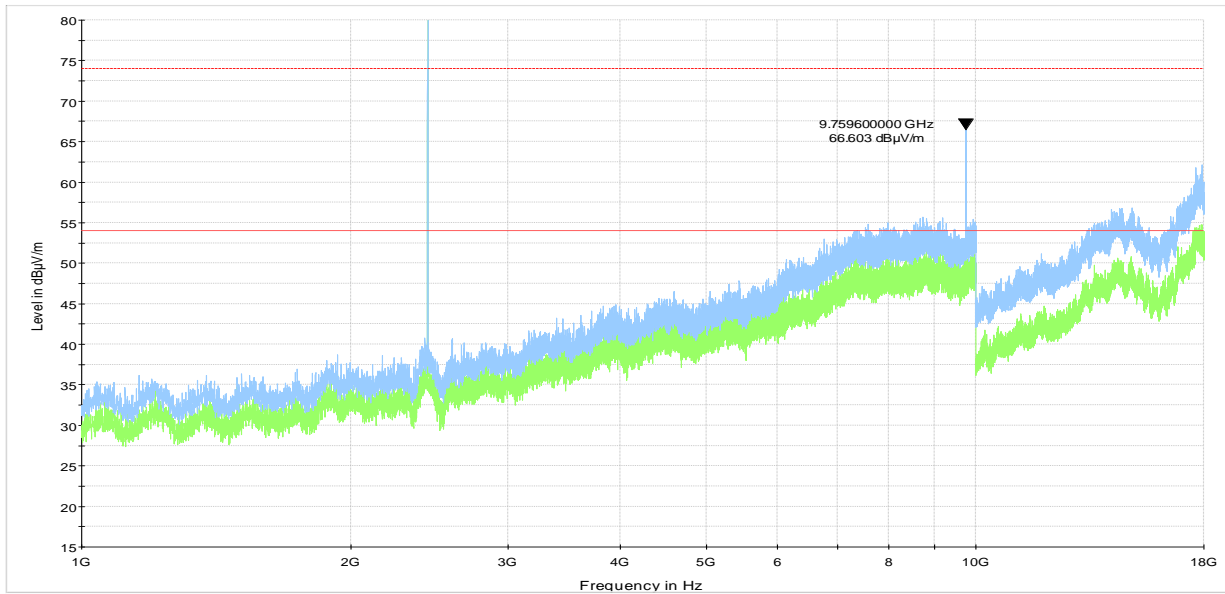

Figure 8.7-10: Radiated spurious (out-of-band) emissions, above 1 GHz, mid channel

Note: Spectrum was investigated up to 25 GHz, no emission related to RF transmission was detected within 6 dB below the limit above 18 GHz

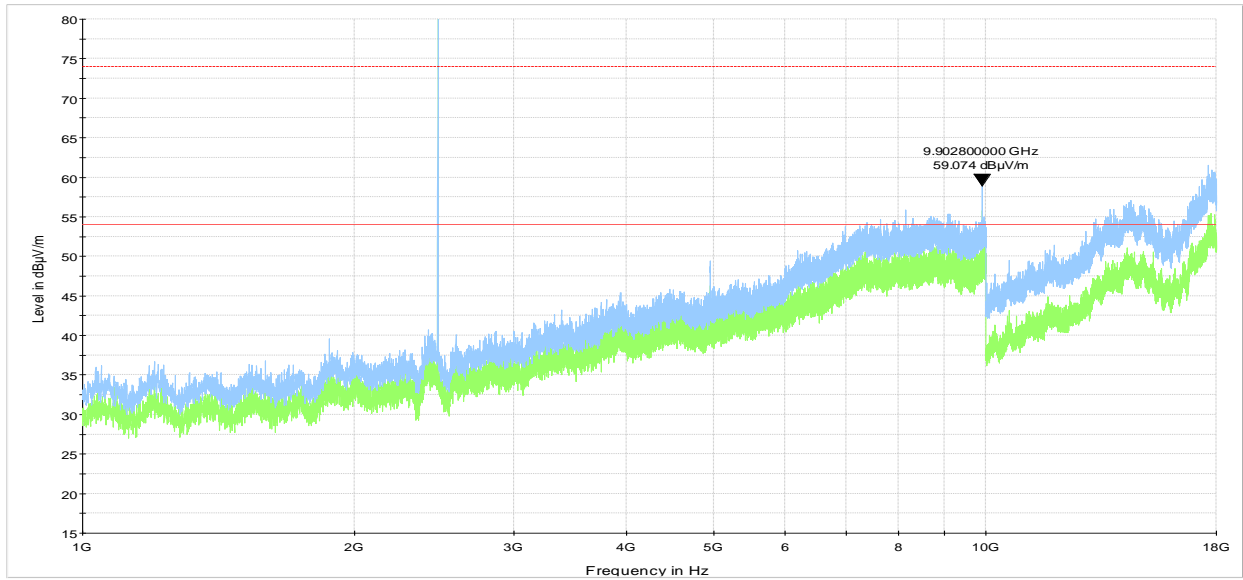

Figure 8.7-11: Radiated spurious (out-of-band) emissions, above 1 GHz, high channel

Note: Spectrum was investigated up to 25 GHz, no emission related to RF transmission was detected within 6 dB below the limit above 18 GHz



8.8 FCC 15.247(e) and RSS-247 5.2(b) Power spectral density for digitally modulated devices

8.8.1 Definitions and limits

FCC:

For digitally modulated systems, the power spectral density conducted from the intentional radiator to the antenna shall not be greater than 8 dBm in any 3 kHz band during any time interval of continuous transmission. This power spectral density shall be determined in accordance with the provisions of paragraph (b) of this section. The same method of determining the conducted output power shall be used to determine the power spectral density.

(f) For the purposes of this section, hybrid systems are those that employ a combination of both frequency hopping and digital modulation techniques. The frequency hopping operation of the hybrid system, with the direct sequence or digital modulation operation turned-off, shall have an average time of occupancy on any frequency not to exceed 0.4 seconds within a time period in seconds equal to the number of hopping frequencies employed multiplied by 0.4. The power spectral density conducted from the intentional radiator to the antenna due to the digital modulation operation of the hybrid system, with the frequency hopping operation turned off, shall not be greater than 8 dBm in any 3 kHz band during any time interval of continuous transmission.

ISED:

The transmitter power spectral density conducted from the transmitter to the antenna shall not be greater than 8 dBm in any 3 kHz band during any time interval of continuous transmission. This power spectral density shall be determined in accordance with the provisions of section 5.4(d), (i.e. the power spectral density shall be determined using the same method as is used to determine the conducted output power).

5.3 Hybrid systems

Hybrid systems employ a combination of both frequency hopping and digital transmission techniques and shall comply with the following:

- a. With the frequency hopping turned off, the digital transmission operation shall comply with the power spectral density requirements for digital modulation systems set out in of section 5.2(b) or section 6.2.4 for hybrid devices operating in the band 5725–5850 MHz.

8.8.1 Test date

Start date	December 12, 2019
------------	-------------------

8.8.2 Observations, settings and special notes

Power spectral density test was performed as per KDB 558074, section 8.4 with reference to ANSI C63.10 subclause 11.10. The test was performed using method AVGPSSD-1 (trace averaging with EUT transmitting at full power throughout each sweep).
Spectrum analyser settings:

Spectrum analyser settings:

Resolution bandwidth:	3 kHz
Video bandwidth:	10 kHz
Frequency span:	5 MHz
Detector mode:	RMS
Trace mode:	Average

8.8.3 Test data

Table 8.8-1: PSD measurements results

Frequency, MHz	PSD, dBm/3 kHz	PSD limit, dBm/3 kHz	Margin, dB
2402	2.19	8.0	5.81
2440	2.86	8.0	5.14
2475	2.09	8.0	5.91

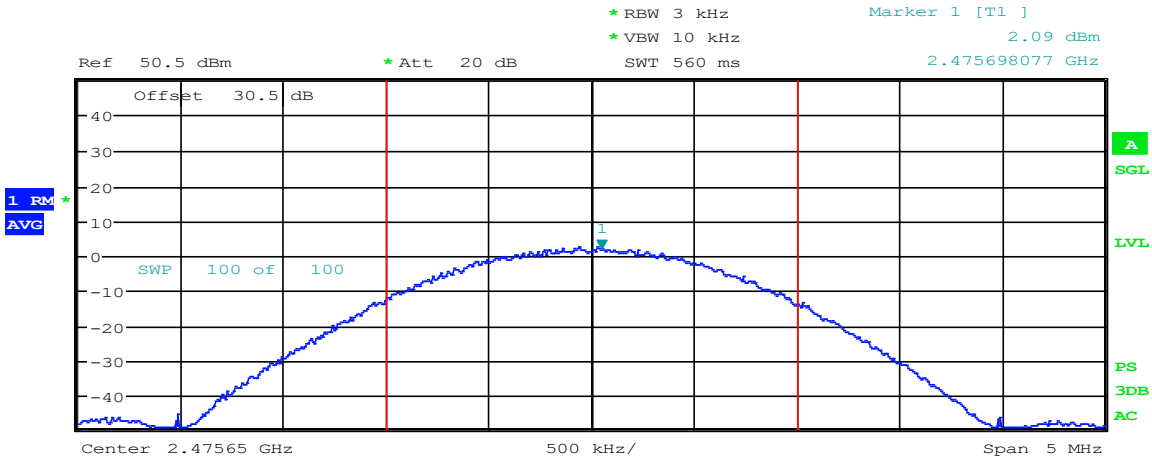
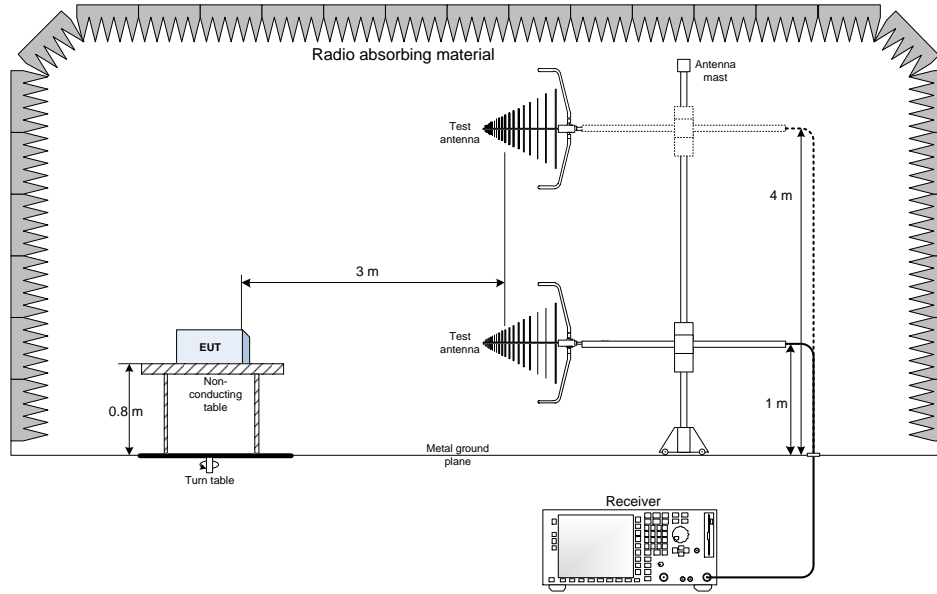

Figure 8.8-1: PSD sample plot on high channel

Section 9. Block diagrams of test set-ups

9.1 Radiated emissions set-up for frequencies below 1 GHz



9.2 Radiated emissions set-up for frequencies above 1 GHz

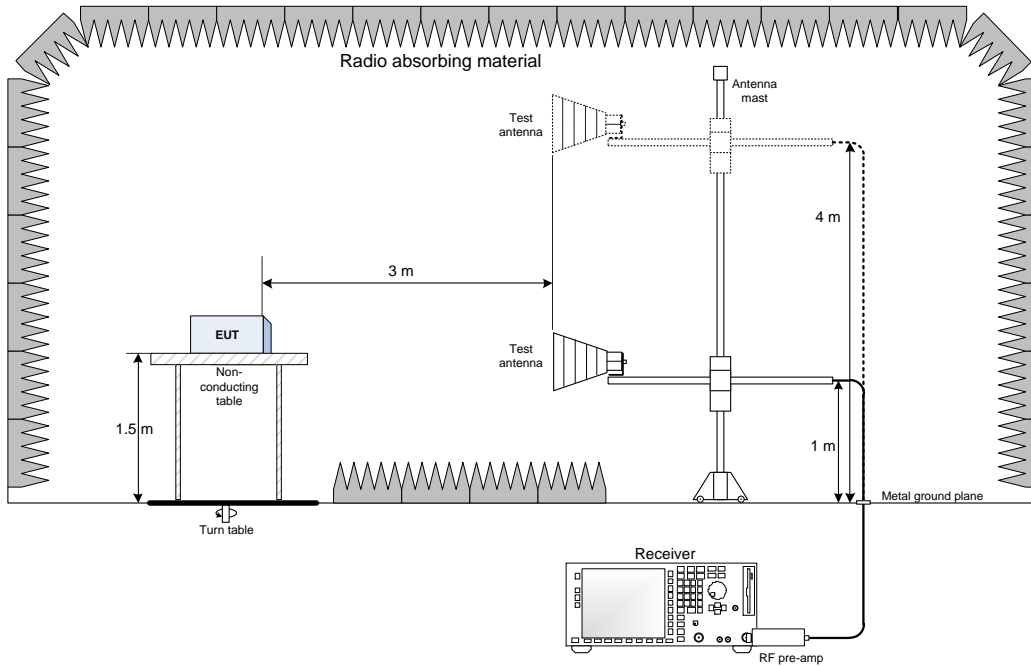

9.3 Conducted emissions set-up

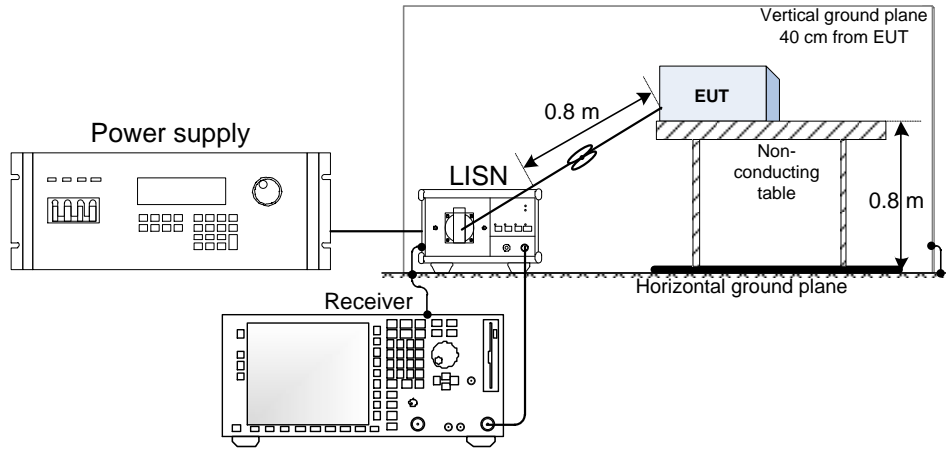

9.4 Antenna port set-up

