

FCC Test Report

Product Name : Bluetooth 5.0 LE Stamp Module
Trade Name : AzureWave
Model No. : AW-CU362
FCC ID. : TLZ-CU362

Applicant : AzureWave Technologies, Inc.
Address : 8F ., No.94, Baozhong Rd. , Xindian Dist.,
New Taipei City, Taiwan 231

Date of Receipt : Sep. 11, 2018
Issued Date : Oct. 03, 2018
Report No. : 1890134R-RFUSP02V00
Report Version : V1.0



The test results relate only to the samples tested.

The test report shall not be reproduced except in full without the written approval of DEKRA Testing and Certification Co., Ltd.

Test Report Certification

Issued Date : Oct. 03, 2018

Report No. : 1890134R-RFUSP02V00



Product Name : Bluetooth 5.0 LE Stamp Module
Applicant : AzureWave Technologies, Inc.
Address : 8F ., No.94, Baozhong Rd. , Xindian Dist., New Taipei City, Taiwan
231
Manufacturer : AzureWave Technologies, Inc.
Trade Name : AzureWave
Model No. : AW-CU362
FCC ID. : TLZ-CU362
EUT Voltage : DC 3.3V
Testing Voltage : DC 3.3V
Applicable Standard : FCC CFR Title 47 Part 15 Subpart C Section 15.247: 2017
ANSI C63.10: 2013
Laboratory Name : Hsin Chu Laboratory
Address : No.372-2, Sec. 4, Zhongxing Rd., Zhudong Township, Hsinchu
County 310, Taiwan, R.O.C.
TEL: +886-3-582-8001 / FAX: +886-3-582-8958
Test Result : Complied

Documented By :



(Demi Chang / Senior Engineering Adm. Specialist)

Tested By :



(Elwin Lin / Engineer)

Approved By :

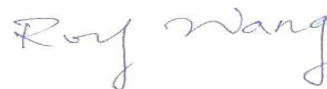

(Roy Wang / Director)

Revision History

Report No.	Version	Description	Issued Date
1890134R-RFUSP02V00	V1.0	Initial issue of report	Oct. 03, 2018

TABLE OF CONTENTS

Description	Page
1. General Information.....	6
1.1. EUT Description	6
1.2. Test Mode	7
1.3. Tested System Details	8
1.4. Configuration of tested System	8
1.5. EUT Exercise Software	8
1.6. Test Facility.....	9
1.7. List of Test Equipment	10
1.8. Duty cycle	12
1.9. Uncertainty	14
2. Conducted Emission	15
2.1. Test Setup.....	15
2.2. Limits	15
2.3. Test Procedure	16
2.4. Test Specification.....	16
2.5. Test Result.....	16
3. Maximum peak conducted output power.....	17
3.1. Test Setup.....	17
3.2. Test procedures	17
3.3. Limits	17
3.4. Test Specification.....	17
3.5. Test Result.....	18
4. Radiated Emission	19
4.1. Test Setup.....	19
4.2. Limits	20
4.3. Test Procedure	21
4.4. Test Specification.....	21
4.5. Test Result.....	22
5. RF antenna conducted test	32
5.1. Test Setup.....	32
5.2. Limits	32
5.3. Test Procedure	32
5.4. Test Specification.....	32
5.5. Test Result.....	33
6. Radiated Emission Band Edge.....	37

6.1.	Test Setup.....	37
6.2.	Limits	37
6.3.	Test Procedure	37
6.4.	Test Specification.....	37
6.5.	Test Result.....	38
7.	Occupied Bandwidth & DTS Bandwidth	44
7.1.	Test Setup.....	44
7.2.	Limits	44
7.3.	Test Procedures.....	44
7.4.	Test Specification.....	44
7.5.	Test Result.....	45
8.	Power Density	49
8.1.	Test Setup.....	49
8.2.	Limits	49
8.3.	Test Procedures.....	49
8.4.	Test Specification.....	49
8.5.	Test Result.....	50
Attachment 1	52
	Test Setup Photograph.....	52
Attachment 2	54
	EUT External Photograph.....	54
Attachment 3	55
	EUT Internal Photograph.....	55

1. General Information

1.1. EUT Description

Product Name	Bluetooth 5.0 LE Stamp Module
Trade Name	AzureWave
Model No.	AW-CU362
Frequency Range/Channel Number	2402~2480MHz / 40 Channels
Type of Modulation	GFSK

Antenna Information	
MFR. / Model No.	LYNwave / ALX18M-052AA7
Antenna Type	PIFA antenna
Antenna Gain	3.78 dBi

Working Frequency of Each Channel							
Channel	Frequency	Channel	Frequency	Channel	Frequency	Channel	Frequency
Channel 00	2402 MHz	Channel 10	2422 MHz	Channel 20	2442 MHz	Channel 30	2462 MHz
Channel 01	2404 MHz	Channel 11	2424 MHz	Channel 21	2444 MHz	Channel 31	2464 MHz
Channel 02	2406 MHz	Channel 12	2426 MHz	Channel 22	2446 MHz	Channel 32	2466 MHz
Channel 03	2408 MHz	Channel 13	2428 MHz	Channel 23	2448 MHz	Channel 33	2468 MHz
Channel 04	2410 MHz	Channel 14	2430 MHz	Channel 24	2450 MHz	Channel 34	2470 MHz
Channel 05	2412 MHz	Channel 15	2432 MHz	Channel 25	2452 MHz	Channel 35	2472 MHz
Channel 06	2414 MHz	Channel 16	2434 MHz	Channel 26	2454 MHz	Channel 36	2474 MHz
Channel 07	2416MHz	Channel 17	2436 MHz	Channel 27	2456 MHz	Channel 37	2476 MHz
Channel 08	2418 MHz	Channel 18	2438 MHz	Channel 28	2458 MHz	Channel 38	2478 MHz
Channel 09	2420 MHz	Channel 19	2440 MHz	Channel 29	2460 MHz	Channel 39	2480 MHz

Note:

1. This device is Bluetooth 5.0 LE Stamp Module support BT5.0 transmitting and receiving function.
2. Regards to the frequency band operation; the lowest , middle and highest frequency of channel were selected to perform the test, and then shown on this report.
3. This device flash has two of manufacturers that are MXIC / MX25L1006 series (main source) and Gigadevice / GD25D10 series (second source).

1.2. Test Mode

DEKRA has verified the construction and function in typical operation. All the test modes were carried out with the EUT in transmitting operation, which was shown in this test report and defined as follows:

Test Mode	Mode 1: Transmit Mode 2: Transmit (Second Source - Flash)
-----------	--

Test Items	Modulation	Channel	Result
Conducted Emission	GFSK	19	N/A
Maximum peak conducted output power	GFSK	00/19/39	Complies
Radiated Emission	GFSK	00/19/39	Complies
RF antenna conducted test	GFSK	00/39	Complies
Radiated Emission Radiated Emission Band Edge	GFSK	00/19/39	Complies
Occupied Bandwidth & DTS Bandwidth	GFSK	00/19/39	Complies
Power Density	GFSK	00/19/39	Complies

1.3. Tested System Details

The types for all equipment, plus descriptions of all cables used in the tested system (including inserted cards) are:

Product	Manufacturer	Model No.	Serial No.	FCC ID	Power Cord	
1	Notebook PC	DELL	Latitude 610	N/A	DoC	Non-Shielded, 1.7m, one ferrite core bonded
2	Fixture	N/A	AzureWave	N/A	--	--

1.4. Configuration of tested System

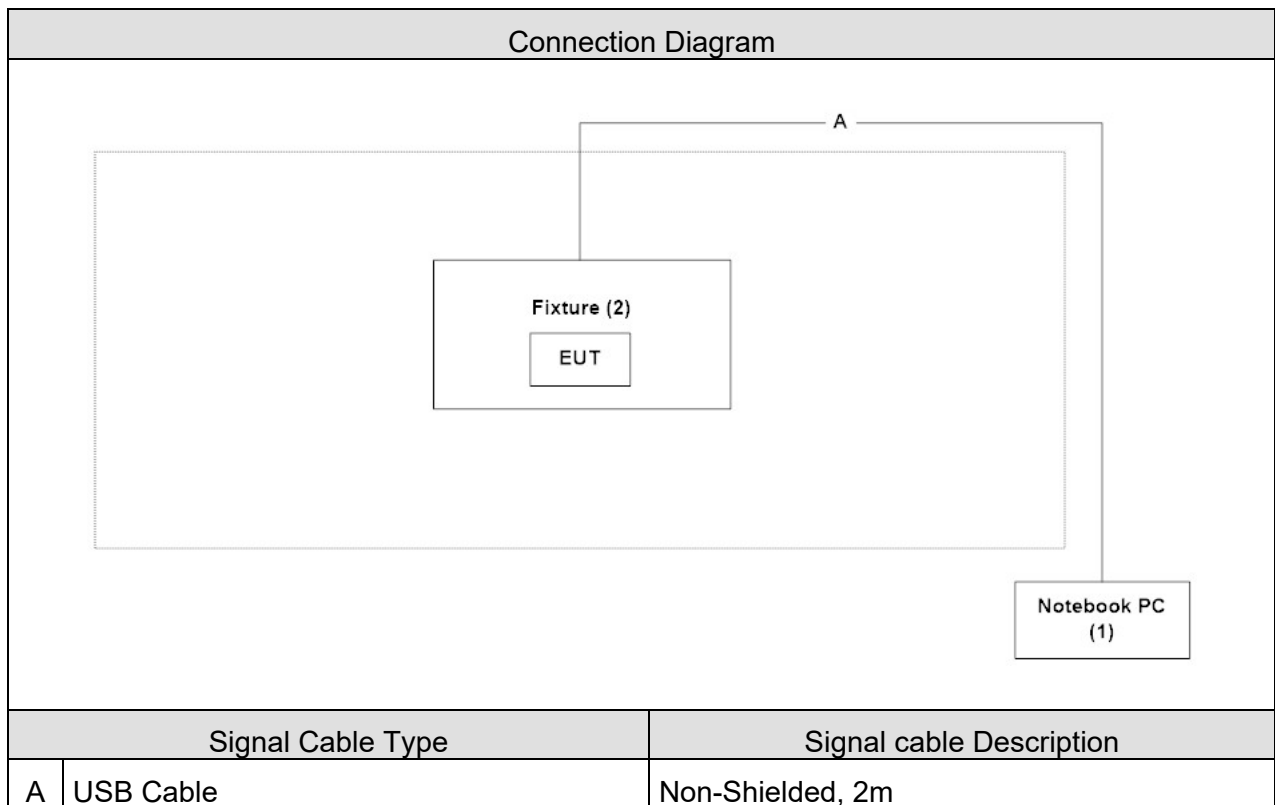

1.5. EUT Exercise Software

1	Setup the EUT as shown in Section 1.4.
2	Execute the control program "SmartSnippets Toolbox" on the laptop.
3	Configure the test mode, the test channel, and the data rate.
4	Press "Start TX" to start the continuous transmitting.
5	Verify that the EUT works properly.

1.6. Test Facility

Ambient conditions in the laboratory:

Items	Test Item	Required (IEC 68-1)	Actual	Test Site
Temperature (°C)	FCC PART 15 C 15.207 Conducted Emission	15 - 35	20	--
Humidity (%RH)		25 - 75	50	
Barometric pressure (mbar)		860 - 1060	950-1000	
Temperature (°C)	FCC PART 15 C 15.247 Maximum peak conducted output power	15 - 35	24	3
Humidity (%RH)		25 - 75	45	
Barometric pressure (mbar)		860 - 1060	950-1000	
Temperature (°C)	FCC PART 15 C 15.247 Radiated Emission	15 - 35	25	2
Humidity (%RH)		25 - 75	54	
Barometric pressure (mbar)		860 - 1060	950-1000	
Temperature (°C)	FCC PART 15 C 15.247 RF antenna conducted test	15 - 35	24	3
Humidity (%RH)		25 - 75	45	
Barometric pressure (mbar)		860 - 1060	950-1000	
Temperature (°C)	FCC PART 15 C 15.247 Radiated Emission Band Edge	15 - 35	25	2
Humidity (%RH)		25 - 75	50	
Barometric pressure (mbar)		860 - 1060	950-1000	
Temperature (°C)	FCC PART 15 C 15.247 Occupied Bandwidth & DTS Bandwidth	15 - 35	24	3
Humidity (%RH)		25 - 75	45	
Barometric pressure (mbar)		860 - 1060	950-1000	
Temperature (°C)	FCC PART 15 C 15.247 Power Density	15 - 35	24	3
Humidity (%RH)		25 - 75	45	
Barometric pressure (mbar)		860 - 1060	950-1000	

Note: Test site information refers to Laboratory Information.

USA : FCC, Registration Number: TW3024

The related certificate for our laboratories about the test site and management system can be downloaded from DEKRA Testing and Certification Co., Ltd. Web Site:

<http://www.dekra.com.tw/english/about/certificates.aspx?bval=5>

The address and introduction of DEKRA Testing and Certification Co., Ltd. laboratories can be founded in our Web site: http://www.dekra.com.tw/index_en.aspx

If you have any comments, Please don't hesitate to contact us. Our test sites as below:

- No. 75-2, 3rd Lin, WangYe Keng, Yonghxing Tsuen, Qionglin Shiang, Hsinchu County 307, Taiwan (R.O.C.)
TEL: +886-3-592-8858 / FAX: +886-3-592-8859 E-Mail : info.tw@dekra.com
- No.372, Sec. 4, Zhongxing Rd., Zhudong Township, Hsinchu County 31061, Taiwan, R.O.C.
TEL: +886-3-582-8001 / FAX: +886-3-582-8958 E-Mail : info.tw@dekra.com
- No.372-2, Sec. 4, Zhongxing Rd., Zhudong Township, Hsinchu County 31061, Taiwan, R.O.C.
TEL: +886-3-582-8001 / FAX: +886-3-582-8958 E-Mail : info.tw@dekra.com

1.7. List of Test Equipment

Maximum peak conducted output power / SR10-H

Instrument	Manufacturer	Model No.	Serial No.	Cal. Date	Next Cal. Date
High Speed Peak Power Meter Dual Input	Anritsu	ML2496A	1602004	2018/01/02	2019/01/01
Pulse Power Sensor	Anritsu	MA2411B	1531043	2018/01/02	2019/01/01
Pulse Power Sensor	Anritsu	MA2411B	1531044	2018/01/02	2019/01/01
Power Meter	Keysight	8990B	MY51000248	2018/06/07	2019/06/06
Power Sensor	Keysight	N1923A	MY57240005	2018/06/07	2019/06/06

Radiated Emission / CB4-H

Instrument	Manufacturer	Model No.	Serial No.	Cal. Date	Next Cal. Date
Signal Analyzer	R&S	FSVA40	101455	2017/11/21	2018/11/20
Signal & Spectrum Analyzer	R&S	FSV40	101049	2018/01/10	2019/01/09
EXA Signal Analyzer	Keysight	N9010A	MY51440132	2018/03/05	2019/03/04
Bilog Antenna	Teseq	CBL6112D	23191	2018/06/26	2019/06/25
Horn Antenna	Schwarzbeck	BBHA 9120D	639	2018/06/01	2019/05/31
Horn Antenna	Schwarzbeck	BBHA 9170	202	2018/01/31	2019/01/30
Pre-Amplifier	Dekra	AP-025C	201801236	2018/02/26	2019/02/25
Pre-Amplifier	EMCI	EMC11830I	980366	2018/01/08	2019/01/07
Pre-Amplifier	Dekra	AP-400C	201801231	2017/12/13	2018/12/12

RF antenna conducted test / SR10-H

Instrument	Manufacturer	Model No.	Serial No.	Cal. Date	Next Cal. Date
Spectrum Analyzer	Keysight	N9030B	MY57140404	2018/06/26	2019/06/25
Spectrum Analyzer	Keysight	N9010B	MY57110159	2018/05/25	2019/05/24
Spectrum Analyzer	Agilent	N9010A	US47140172	2018/07/18	2019/07/17
Signal & Spectrum Analyzer	R&S	FSV40	101049	2018/01/10	2019/01/09

Radiated Emission Band Edge / CB4-H

Instrument	Manufacturer	Model No.	Serial No.	Cal. Date	Next Cal. Date
Signal Analyzer	R&S	FSVA40	101455	2017/11/21	2018/11/20
Signal & Spectrum Analyzer	R&S	FSV40	101049	2018/01/10	2019/01/09
EXA Signal Analyzer	Keysight	N9010A	MY51440132	2018/03/05	2019/03/04
Bilog Antenna	Teseq	CBL6112D	23191	2018/06/26	2019/06/25
Horn Antenna	Schwarzbeck	BBHA 9120D	639	2018/06/01	2019/05/31
Horn Antenna	Schwarzbeck	BBHA 9170	202	2018/01/31	2019/01/30
Pre-Amplifier	Dekra	AP-025C	201801236	2018/02/26	2019/02/25
Pre-Amplifier	EMCI	EMC11830I	980366	2018/01/08	2019/01/07
Pre-Amplifier	Dekra	AP-400C	201801231	2017/12/13	2018/12/12

Occupied Bandwidth & DTS Bandwidth / SR10-H

Instrument	Manufacturer	Model No.	Serial No.	Cal. Date	Next Cal. Date
Spectrum Analyzer	Keysight	N9030B	MY57140404	2018/06/26	2019/06/25
Spectrum Analyzer	Keysight	N9010B	MY57110159	2018/05/25	2019/05/24
Spectrum Analyzer	Agilent	N9010A	US47140172	2018/07/18	2019/07/17
Signal & Spectrum Analyzer	R&S	FSV40	101049	2018/01/10	2019/01/09

Power Density / SR10-H

Instrument	Manufacturer	Model No.	Serial No.	Cal. Date	Next Cal. Date
Spectrum Analyzer	Keysight	N9030B	MY57140404	2018/06/26	2019/06/25
Spectrum Analyzer	Keysight	N9010B	MY57110159	2018/05/25	2019/05/24
Spectrum Analyzer	Agilent	N9010A	US47140172	2018/07/18	2019/07/17
Signal & Spectrum Analyzer	R&S	FSV40	101049	2018/01/10	2019/01/09

Note: All equipment upon which need to calibrated are with calibration period of 1 year.

1.8. Duty cycle

2402MHz

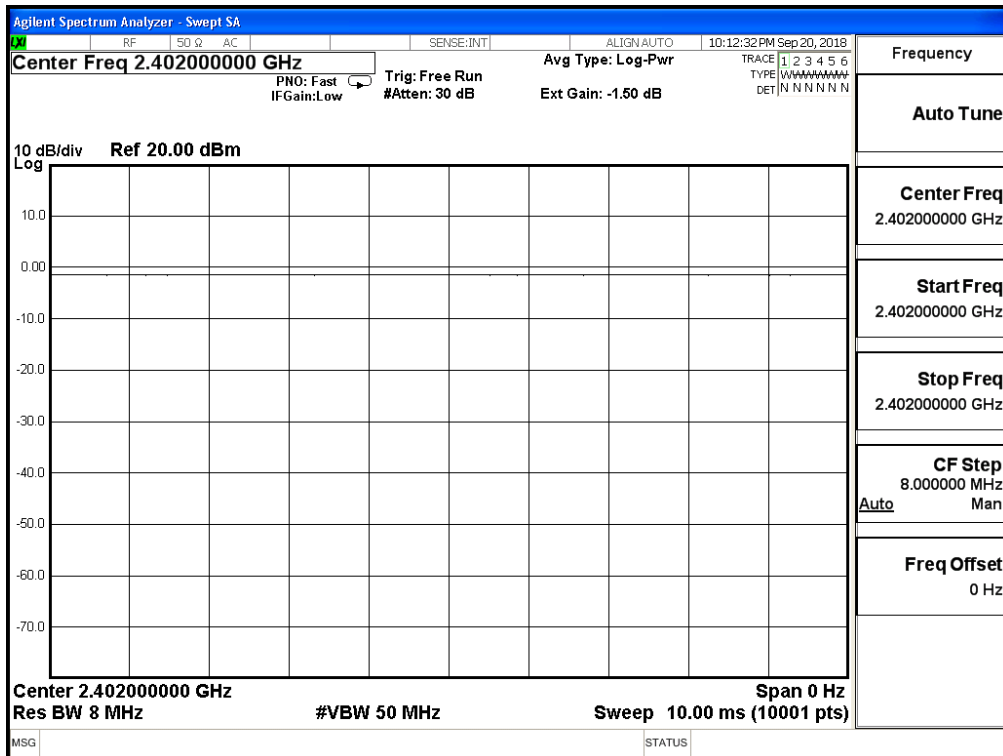

2440MHz

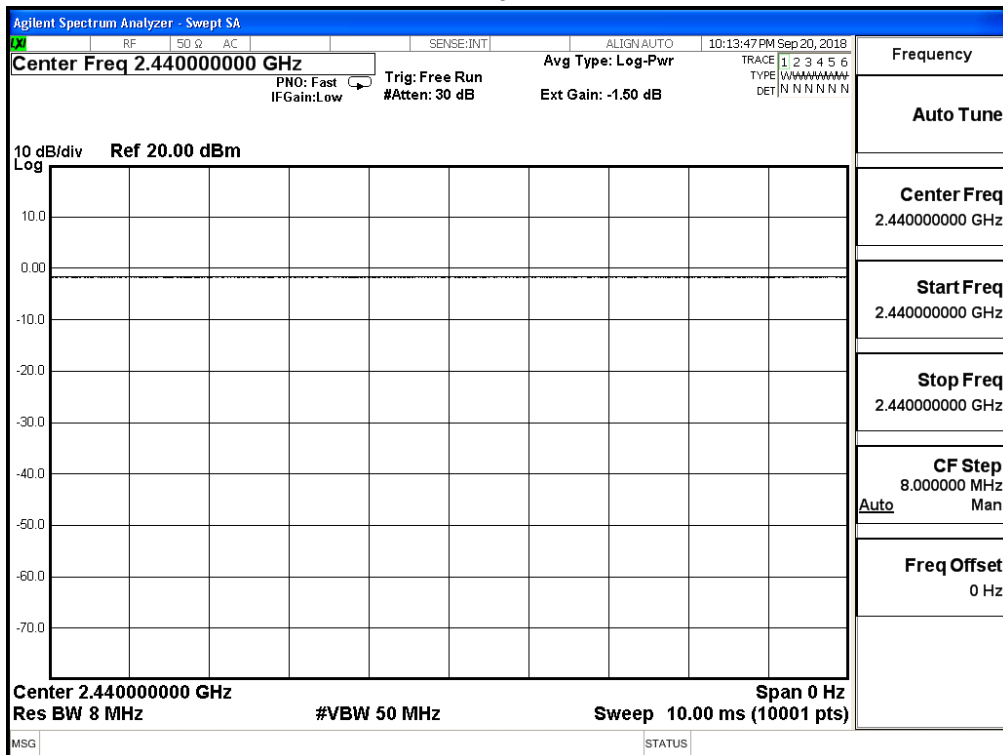

2480MHz

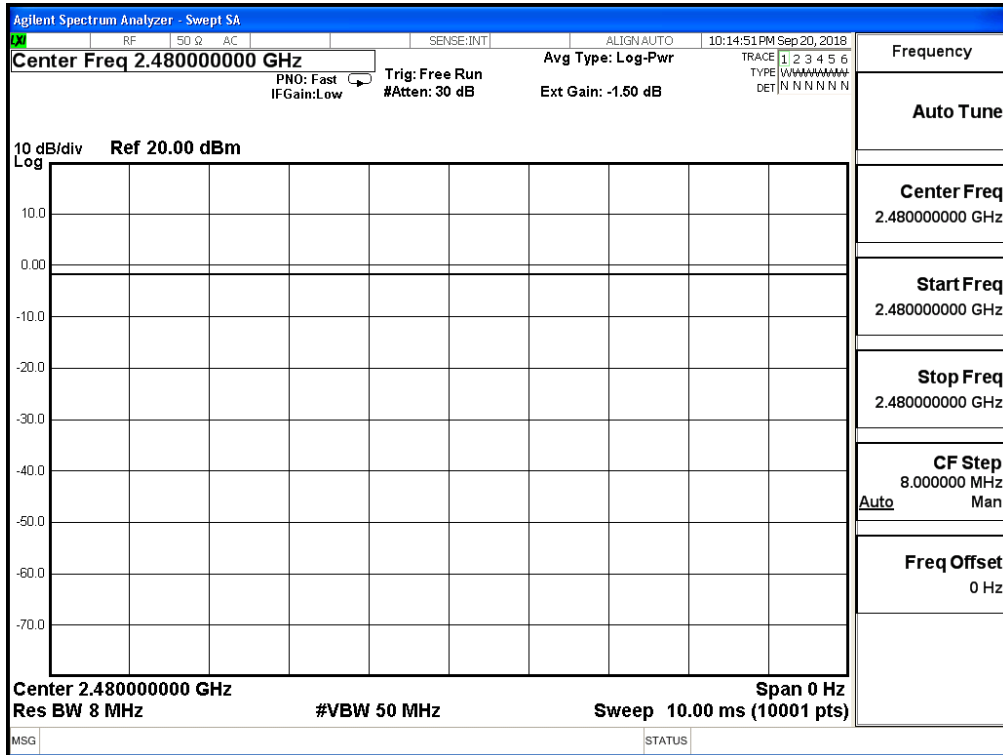

1.9. Uncertainty

Test item	Uncertainty
Conducted Emission	± 2.26 dB
Maximum peak conducted output power	± 1.27 dB
Radiated Emission	30MHz~1GHz as ± 3.43 dB 1GHz~26.5GHz as ± 3.65 dB
RF antenna conducted test	± 1.27 dB
Radiated Emission Radiated Emission Band Edge	± 3.9 dB
Occupied Bandwidth	± 150 Hz
DTS Bandwidth	± 150 Hz
Power Density	± 1.27 dB

2. Conducted Emission

2.1. Test Setup

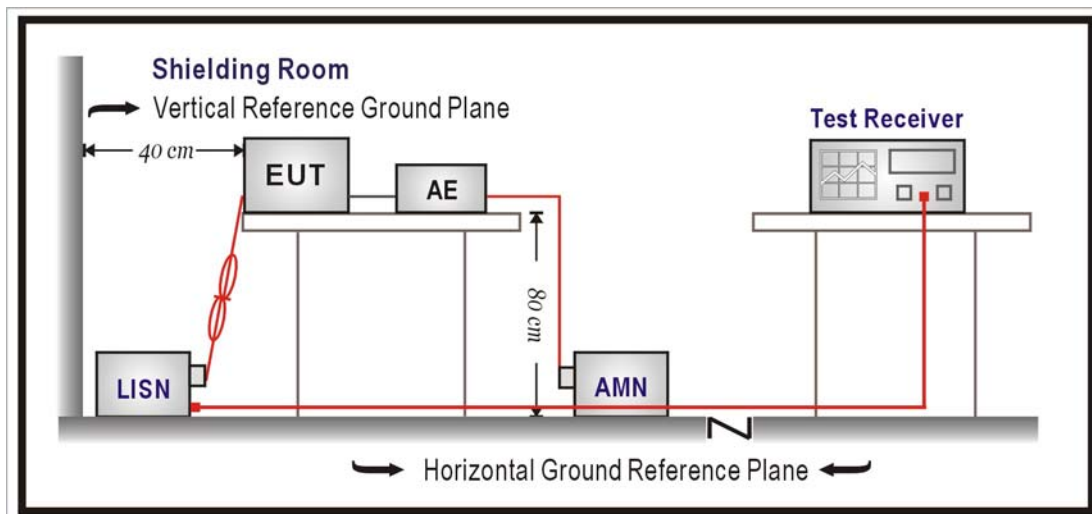

2.2. Limits

FCC Part 15 Subpart C Paragraph 15.207 Limits (dBuV)		
Frequency MHz	QP	AV
0.15 - 0.50	66 - 56	56 - 46
0.50 - 5.0	56	46
5.0 - 30	60	50

Remarks: In the above table, the tighter limit applies at the Radiated Emission Band Edges.

2.3. Test Procedure

The EUT and simulators are connected to the main power through a line impedance stabilization network (L.I.S.N.). This provides a 50 ohm /50uH coupling impedance for the measuring equipment. The peripheral devices are also connected to the main power through a LISN that provides a 50ohm/50uH coupling impedance with 50ohm termination. (Please refer to the block diagram of the test setup and photographs.)

Both sides of A.C. line are checked for maximum conducted interference. In order to find the maximum emission, the relative positions of equipment and all of the interface cables must be changed according to ANSI C63.4: 2014 on conducted measurement.

Conducted emissions were investigated over the frequency range from 0.15MHz to 30MHz using a receiver bandwidth of 9kHz.

2.4. Test Specification

According to FCC Part 15 Subpart C Paragraph 15.207: 2017

2.5. Test Result

Owing to the DC operation of EUT, this test item is not performed.

3. Maximum peak conducted output power

3.1. Test Setup

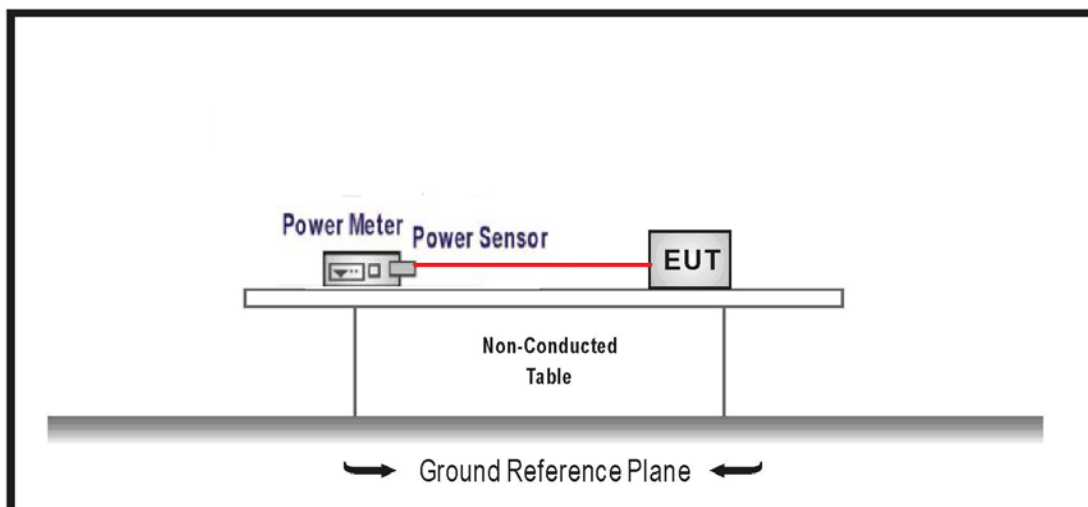

3.2. Test procedures

The EUT was setup according to ANSI C63.10: 2013; tested according to DTS test procedure of KDB558074 D01V04 for compliance to FCC 47CFR 15.247 requirements.

3.3. Limits

The maximum peak power shall be less 1 Watt.

3.4. Test Specification

According to FCC Part 15 Subpart C Paragraph 15.247: 2017

3.5. Test Result

Product	Bluetooth 5.0 LE Stamp Module		
Test Item	Maximum peak conducted output power		
Test Mode	Mode 1: Transmit		
Date of Test	2018/09/21	Test Site	SR10-H

Channel No.	Frequency (MHz)	Measure Level (dBm)	Limit (dBm)
00	2402	0.670	30
19	2440	0.510	30
39	2480	0.280	30

4. Radiated Emission

4.1. Test Setup

Under 30MHz Test Setup:

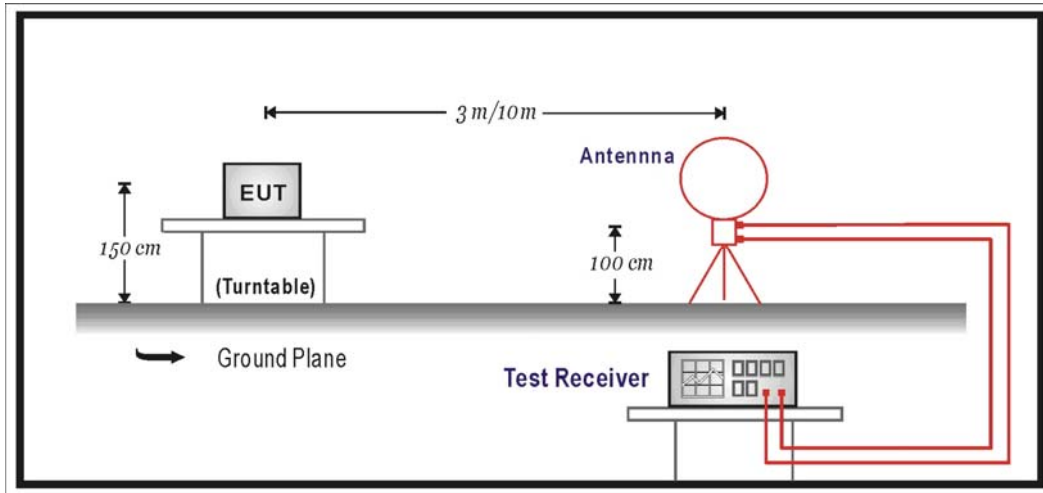

Under 1GHz Test Setup:

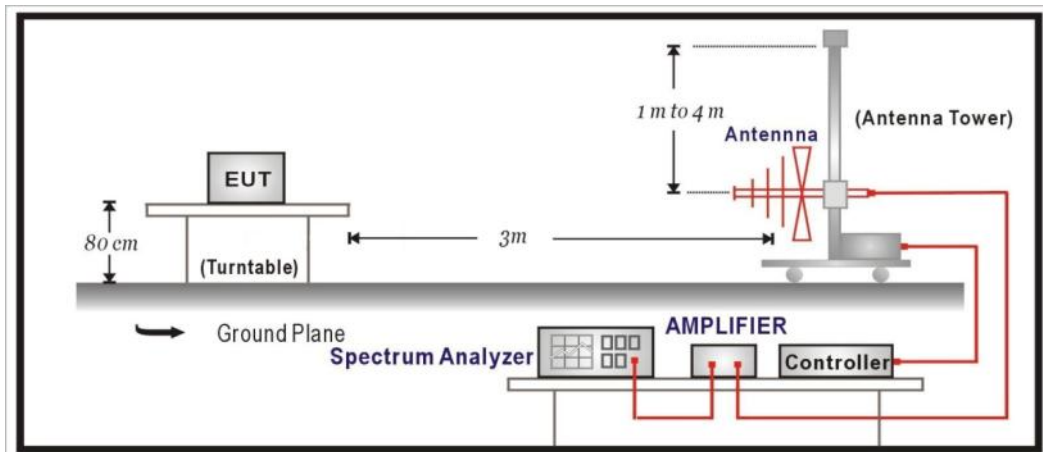

Above 1GHz Test Setup:

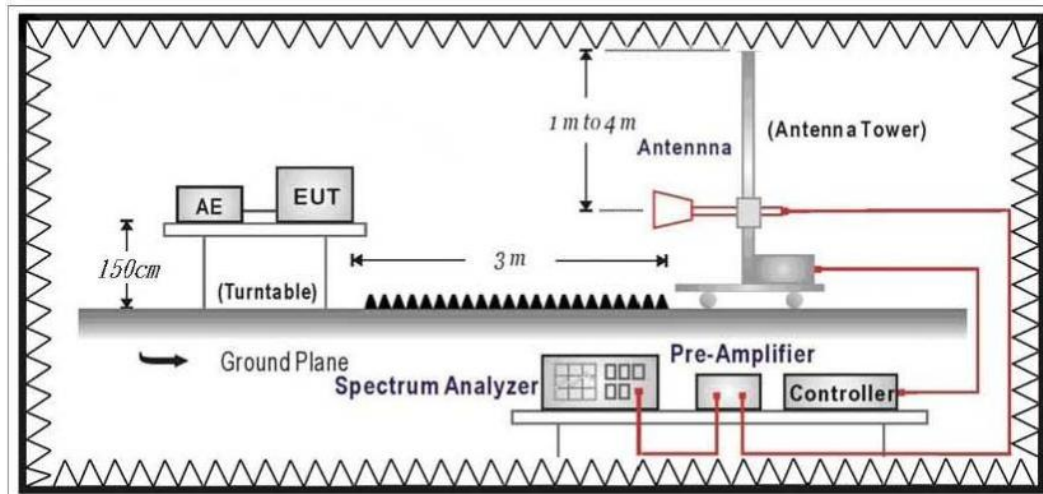

4.2. Limits

Emissions radiated outside of the specified frequency bands, except for harmonics, shall be attenuated by at least 20dB below the level of the fundamental or to the general radiated emission limits in paragraph 15.209, whichever is the lesser attenuation.

FCC Part 15 Subpart C Paragraph 15.209 Limits		
Frequency MHz	uV/m	dBuV/m
30 - 88	100	40
88 - 216	150	43.5
216 - 960	200	46
Above 960	500	54

- Remarks:
1. RF Voltage (dBuV) = 20 log RF Voltage (uV)
 2. In the Above Table, the tighter limit applies at the Radiated Emission Band Edges.
 3. Distance refers to the distance in meters between the measuring instrument antenna and the closed point of any part of the device or system.

4.3. Test Procedure

The EUT was setup according to ANSI C63.10: 2013 and tested according to DTS test procedure of KDB558074 D01V04 for compliance to FCC 47CFR 15.247 requirements. The EUT and its simulators are placed on a turn table which is 0.8 or 1.5 meter above ground. The turn table can rotate 360 degrees to determine the position of the maximum emission level.

The antenna can move up and down between 1 meter and 4 meters to find out the maximum emission level.

Both horizontal and vertical polarization of the antenna are set on measurement. In order to find the maximum emission, all of the interface cables must be manipulated according to ANSI C63.10: 2013 on radiated measurement.

On any frequency or frequencies from 9kHz (include The the lowest oscillator frequency generated within the device up to the 10th harmonic) to 1000 MHz, the limits shown are based on measuring equipment employing a quasi-peak detector function and on any frequency or frequencies above 1000 MHz the radiated limits shown are based upon the use of measurement instrumentation employing an average detector function. When average radiated emission measurement are included emission measurement below 1000 MHz, there also is a limit on the radio frequency emissions, as measured using instrumentation with a peak detector function, corresponding to 20 dB above the maximum permitted average limit. The bandwidth below 1GHz setting on the field strength meter is 120 kHz and above 1GHz is 1MHz.

4.4. Test Specification

According to FCC Part 15 Subpart C Paragraph 15.247:2017

4.5. Test Result

30MHz-1GHz Spurious

Site :	CB4-H	Engineer :	Elwin
Model No :	AW-CU362	Test Date :	2018/9/21
Test Voltage :	DC 3.3V	Polarity :	Horizontal
Test Mode :	Mode 1: Transmit		
Note :	BT5.0_2440MHz		

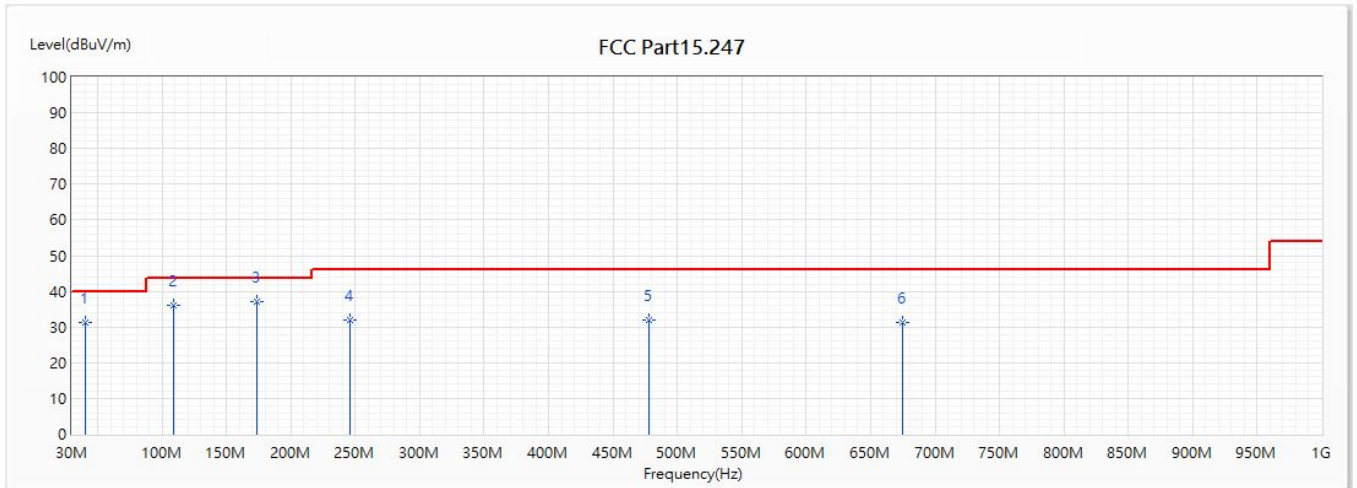

No	Frequency (MHz)	Emission Level (dBuV/m)	Limit (dBuV/m)	Margin (dB)	Reading Level (dBuV)	Correct Factor (dB)	Detector Type
1	39.991	31.20	40.00	-8.80	47.45	-16.25	QP
2	109.152	36.02	43.50	-7.48	57.80	-21.78	QP
* 3	173.851	37.08	43.50	-6.42	58.78	-21.70	QP
4	246.019	31.83	46.00	-14.17	53.03	-21.20	QP
5	478.237	32.00	46.00	-14.00	46.13	-14.13	QP
6	675.05	31.20	46.00	-14.80	42.70	-11.50	QP

Note:

1. All Reading Levels is Quasi-Peak value.
2. “ * ”, means this data is the worst emission level.
3. Emission Level = Reading Level + Correct Factor
4. The Emission under 30MHz were not included is because their levels are lower than 20dB away from limit.

Site :	CB4-H	Engineer :	Elwin
Model No :	AW-CU362	Test Date :	2018/9/21
Test Voltage :	DC 3.3V	Polarity :	Vertical
Test Mode :	Mode 1: Transmit		
Note :	BT5.0_2440MHz		

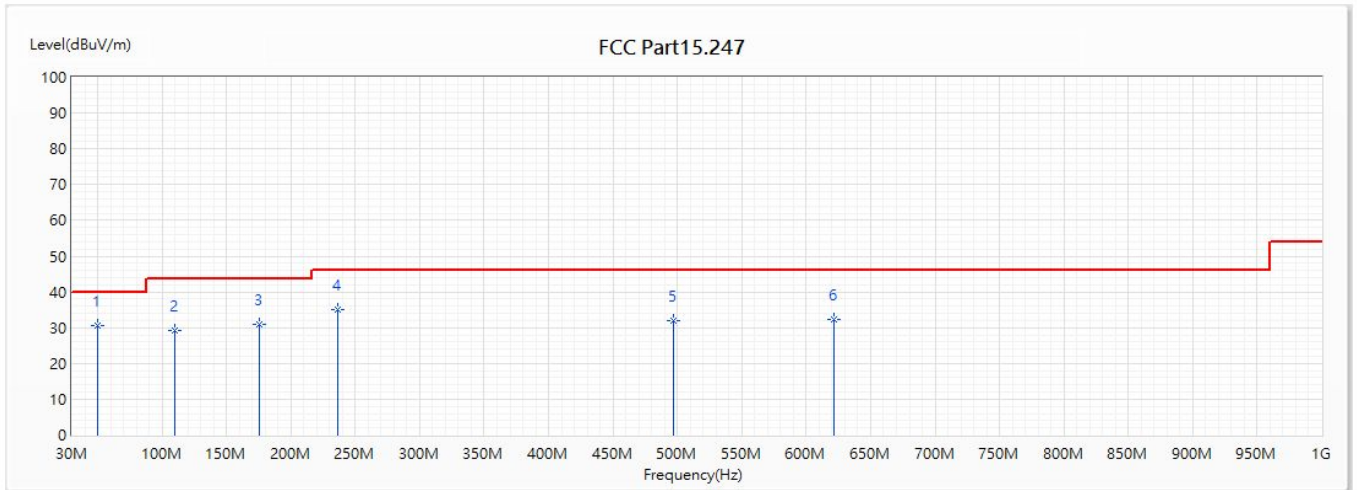

No	Frequency (MHz)	Emission Level (dBuV/m)	Limit (dBuV/m)	Margin (dB)	Reading Level (dBuV)	Correct Factor (dB)	Detector Type
* 1	49.594	30.43	40.00	-9.57	53.29	-22.86	QP
2	110.316	29.14	43.50	-14.36	51.07	-21.93	QP
3	175.694	30.82	43.50	-12.68	52.51	-21.69	QP
4	236.804	35.22	46.00	-10.78	56.08	-20.86	QP
5	496.861	31.93	46.00	-14.07	46.73	-14.80	QP
6	621.7	32.38	46.00	-13.62	45.80	-13.42	QP

Note:

1. All Reading Levels is Quasi-Peak value.
2. “ * ”, means this data is the worst emission level.
3. Emission Level = Reading Level + Correct Factor
4. The Emission under 30MHz were not included is because their levels are lower than 20dB away from limit.

Site :	CB4-H	Engineer :	Elwin
Model No :	AW-CU362	Test Date :	2018/9/27
Test Voltage :	DC 3.3V	Polarity :	Horizontal
Test Mode :	Mode 2: Transmit (Second Source - Flash)		
Note :	BT5.0_2440MHz		

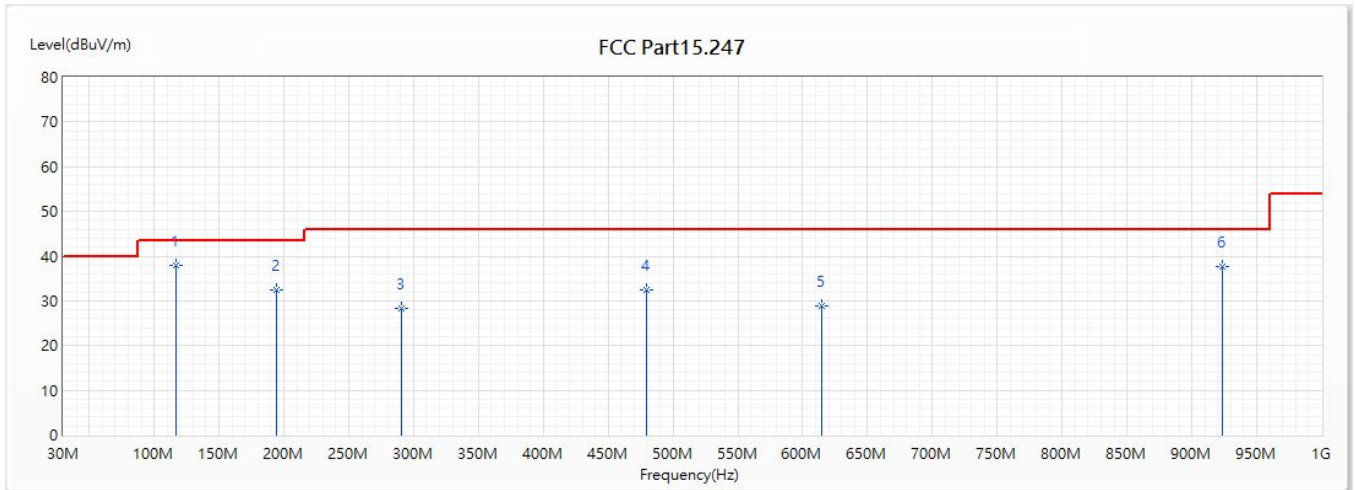

No	Frequency (MHz)	Emission Level (dBuV/m)	Limit (dBuV/m)	Margin (dB)	Reading Level (dBuV)	Correct Factor (dB)	Detector Type
* 1	116.621	37.86	43.50	-5.64	60.52	-22.66	QP
2	193.93	32.33	43.50	-11.17	54.72	-22.39	QP
3	290.833	28.37	46.00	-17.63	47.59	-19.22	QP
4	479.983	32.46	46.00	-13.54	46.39	-13.93	QP
5	614.91	28.73	46.00	-17.27	41.44	-12.71	QP
6	923.952	37.73	46.00	-8.27	46.87	-9.14	QP

Note:

1. All Reading Levels is Quasi-Peak value.
2. “ * ”, means this data is the worst emission level.
3. Emission Level = Reading Level + Correct Factor
4. The Emission under 30MHz were not included is because their levels are lower than 20dB away from limit.

Site :	CB4-H	Engineer :	Elwin
Model No :	AW-CU362	Test Date :	2018/9/27
Test Voltage :	DC 3.3V	Polarity :	Vertical
Test Mode :	Mode 2: Transmit (Second Source - Flash)		
Note :	BT5.0_2440MHz		

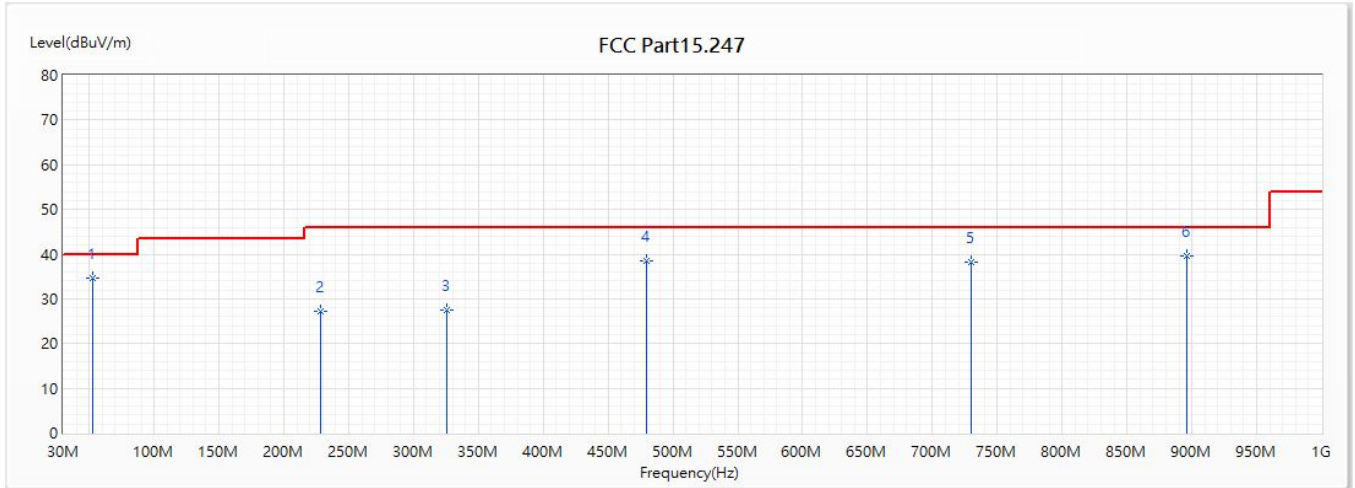

No	Frequency (MHz)	Emission Level (dBuV/m)	Limit (dBuV/m)	Margin (dB)	Reading Level (dBuV)	Correct Factor (dB)	Detector Type
* 1	52.989	34.52	40.00	-5.48	58.03	-23.51	QP
2	228.074	27.26	46.00	-18.74	47.87	-20.61	QP
3	325.85	27.55	46.00	-18.45	45.95	-18.40	QP
4	479.886	38.47	46.00	-7.53	52.42	-13.95	QP
5	729.855	38.17	46.00	-7.83	49.30	-11.13	QP
6	896.501	39.54	46.00	-6.46	49.01	-9.47	QP

Note:

1. All Reading Levels is Quasi-Peak value.
2. “ * ”, means this data is the worst emission level.
3. Emission Level = Reading Level + Correct Factor
4. The Emission under 30MHz were not included is because their levels are lower than 20dB away from limit.

Harmonic & Spurious:

Site :	CB4-H	Engineer :	Elwin
Model No :	AW-CU362	Test Date :	2018/9/21
Test Voltage :	DC 3.3V	Polarity :	Horizontal
Test Mode :	Mode 1: Transmit		
Note :	BT5.0_2402MHz		

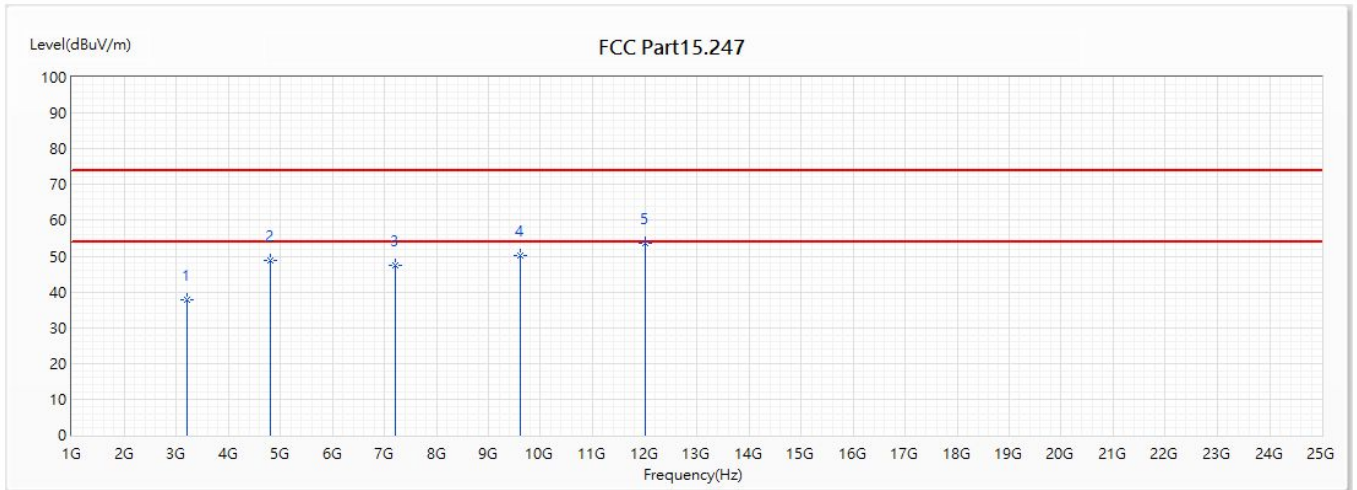

No	Frequency (MHz)	Emission Level (dBuV/m)	Limit (dBuV/m)	Margin (dB)	Reading Level (dBuV)	Correct Factor (dB)	Detector Type
1	3202	37.68	74.00	-36.32	42.09	-4.41	PK
2	4804	48.86	74.00	-25.14	47.68	1.18	PK
3	7206	47.53	74.00	-26.47	37.99	9.54	PK
4	9608	50.02	74.00	-23.98	35.60	14.42	PK
* 5	12010	53.67	74.00	-20.33	34.90	18.77	PK

Note:

1. All reading above 1GHz is performed with peak measurements as necessary.
2. “ * ”, means this data is the worst emission level.
3. Emission Level = Reading Level + Correct Factor.
4. The average measurement was not performed when the peak measured data under the limit of average detection.
5. The Emission above 13GHz were not included is because their levels are lower than 20dB away from limit.

Site :	CB4-H	Engineer :	Elwin
Model No :	AW-CU362	Test Date :	2018/9/21
Test Voltage :	DC 3.3V	Polarity :	Vertical
Test Mode :	Mode 1: Transmit		
Note :	BT5.0_2402MHz		

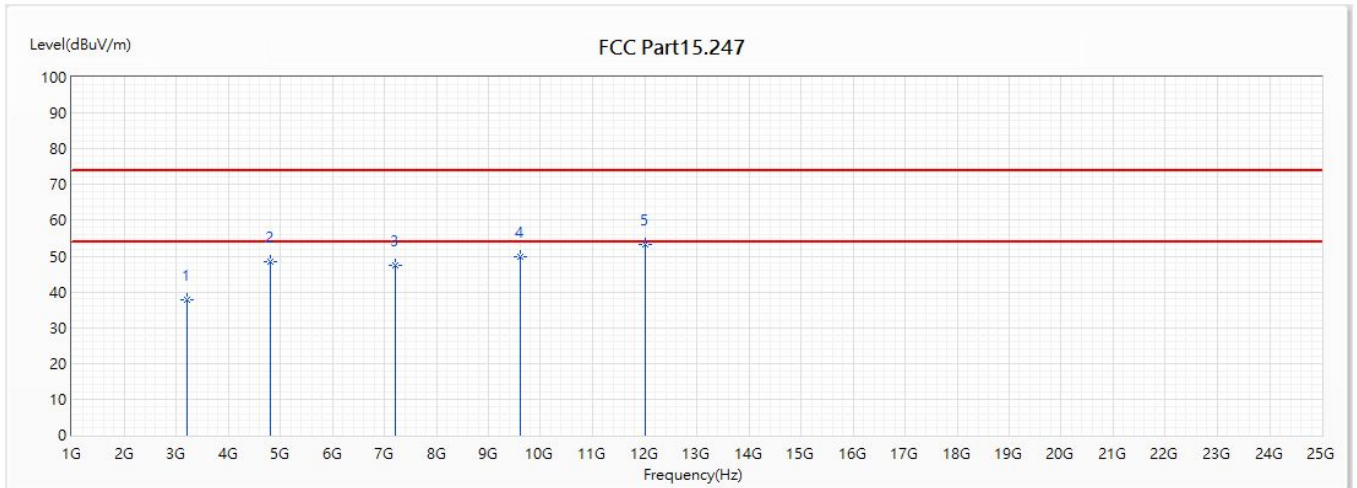

No	Frequency (MHz)	Emission Level (dBuV/m)	Limit (dBuV/m)	Margin (dB)	Reading Level (dBuV)	Correct Factor (dB)	Detector Type
1	3202	37.81	74.00	-36.19	42.22	-4.41	PK
2	4804	48.60	74.00	-25.40	47.42	1.18	PK
3	7206	47.35	74.00	-26.65	37.81	9.54	PK
4	9608	49.77	74.00	-24.23	35.35	14.42	PK
* 5	12010	53.34	74.00	-20.66	34.57	18.77	PK

Note:

1. All reading above 1GHz is performed with peak measurements as necessary.
2. “ * ”, means this data is the worst emission level.
3. Emission Level = Reading Level + Correct Factor.
4. The average measurement was not performed when the peak measured data under the limit of average detection.
5. The Emission above 13GHz were not included is because their levels are lower than 20dB away from limit.

Site :	CB4-H	Engineer :	Elwin
Model No :	AW-CU362	Test Date :	2018/9/21
Test Voltage :	DC 3.3V	Polarity :	Horizontal
Test Mode :	Mode 1: Transmit		
Note :	BT5.0_2440MHz		

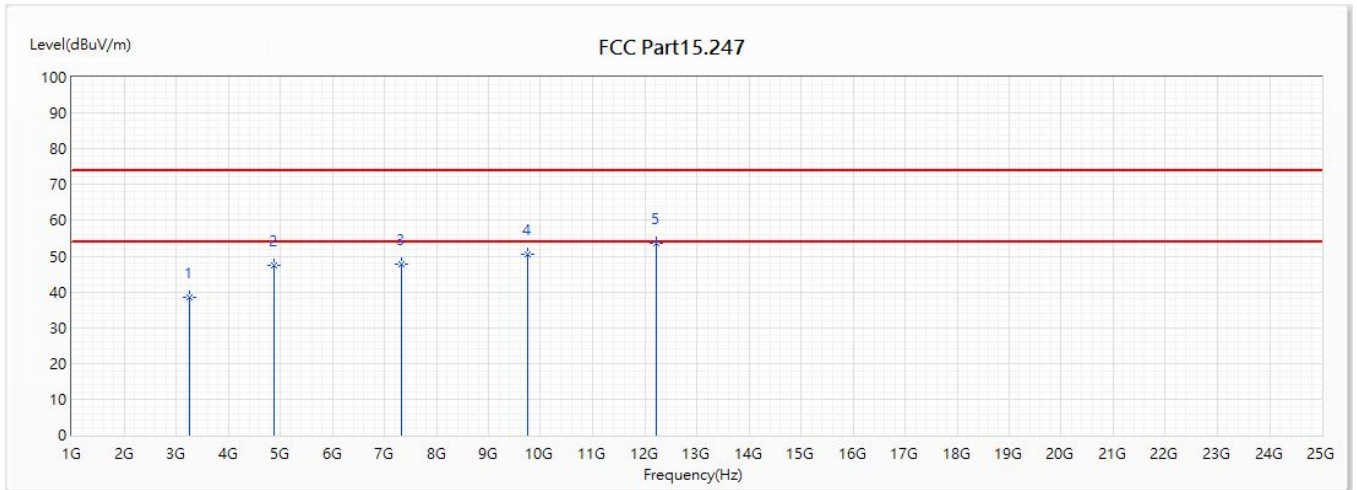

No	Frequency (MHz)	Emission Level (dBuV/m)	Limit (dBuV/m)	Margin (dB)	Reading Level (dBuV)	Correct Factor (dB)	Detector Type
1	3253.3	38.56	74.00	-35.44	42.91	-4.35	PK
2	4880	47.59	74.00	-26.41	45.99	1.60	PK
3	7320	47.71	74.00	-26.29	37.81	9.90	PK
4	9760	50.54	74.00	-23.46	35.90	14.64	PK
* 5	12220	53.54	74.00	-20.46	35.17	18.37	PK

Note:

1. All reading above 1GHz is performed with peak measurements as necessary.
2. “ * ”, means this data is the worst emission level.
3. Emission Level = Reading Level + Correct Factor.
4. The average measurement was not performed when the peak measured data under the limit of average detection.
5. The Emission above 13GHz were not included is because their levels are lower than 20dB away from limit.

Site :	CB4-H	Engineer :	Elwin
Model No :	AW-CU362	Test Date :	2018/9/21
Test Voltage :	DC 3.3V	Polarity :	Vertical
Test Mode :	Mode 1: Transmit		
Note :	BT5.0_2440MHz		

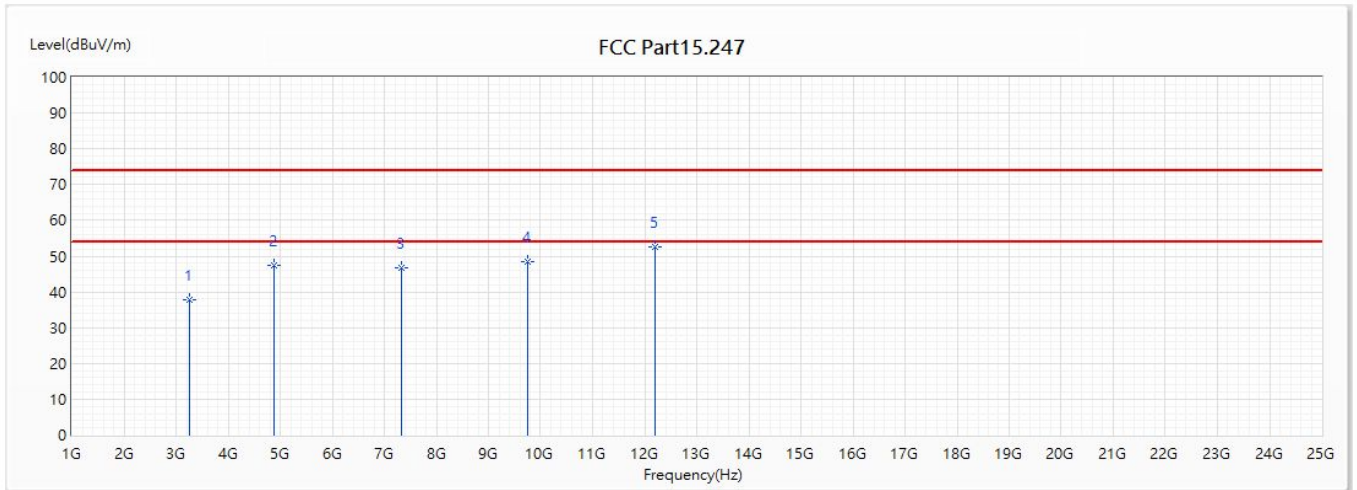

No	Frequency (MHz)	Emission Level (dBuV/m)	Limit (dBuV/m)	Margin (dB)	Reading Level (dBuV)	Correct Factor (dB)	Detector Type
1	3253.3	37.68	74.00	-36.32	42.03	-4.35	PK
2	4880	47.45	74.00	-26.55	45.85	1.60	PK
3	7320	46.78	74.00	-27.22	36.88	9.90	PK
4	9760	48.62	74.00	-25.38	33.98	14.64	PK
* 5	12200	52.73	74.00	-21.27	34.33	18.40	PK

Note:

1. All reading above 1GHz is performed with peak measurements as necessary.
2. “ * ”, means this data is the worst emission level.
3. Emission Level = Reading Level + Correct Factor.
4. The average measurement was not performed when the peak measured data under the limit of average detection.
5. The Emission above 13GHz were not included is because their levels are lower than 20dB away from limit.

Site :	CB4-H	Engineer :	Elwin
Model No :	AW-CU362	Test Date :	2018/9/21
Test Voltage :	DC 3.3V	Polarity :	Horizontal
Test Mode :	Mode 1: Transmit		
Note :	BT5.0_2480MHz		

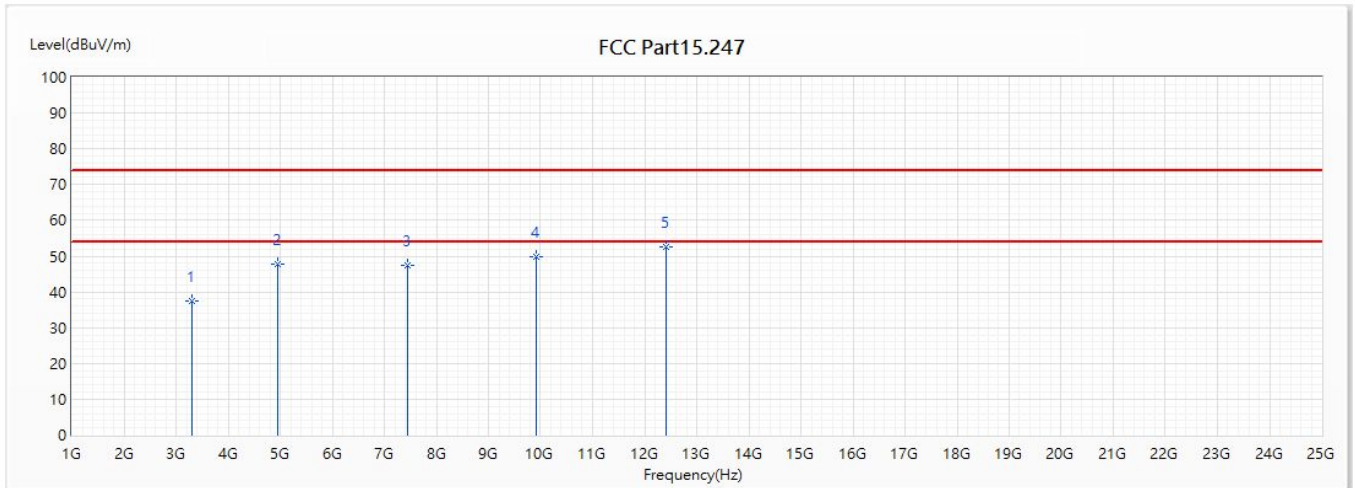

No	Frequency (MHz)	Emission Level (dBuV/m)	Limit (dBuV/m)	Margin (dB)	Reading Level (dBuV)	Correct Factor (dB)	Detector Type
1	3306	37.46	74.00	-36.54	41.78	-4.32	PK
2	4960	47.68	74.00	-26.32	45.58	2.10	PK
3	7440	47.26	74.00	-26.74	36.75	10.51	PK
4	9920	49.87	74.00	-24.13	34.81	15.06	PK
* 5	12400	52.68	74.00	-21.32	34.69	17.99	PK

Note:

1. All reading above 1GHz is performed with peak measurements as necessary.
2. “ * ”, means this data is the worst emission level.
3. Emission Level = Reading Level + Correct Factor.
4. The average measurement was not performed when the peak measured data under the limit of average detection.
5. The Emission above 13GHz were not included is because their levels are lower than 20dB away from limit.

Site :	CB4-H	Engineer :	Elwin
Model No :	AW-CU362	Test Date :	2018/9/21
Test Voltage :	DC 3.3V	Polarity :	Vertical
Test Mode :	Mode 1: Transmit		
Note :	BT5.0_2480MHz		

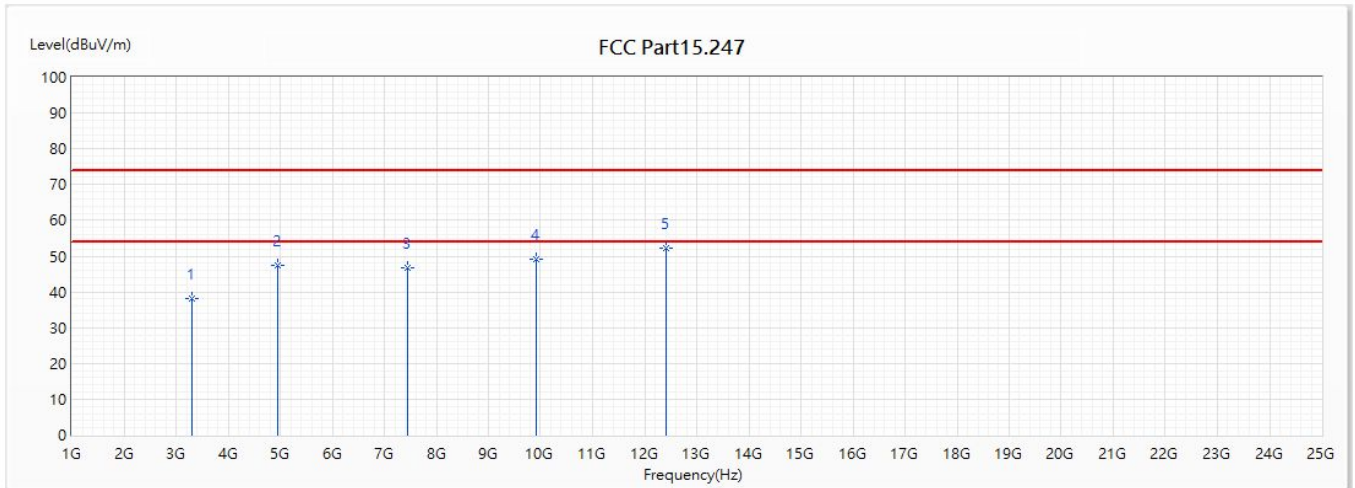

No	Frequency (MHz)	Emission Level (dBuV/m)	Limit (dBuV/m)	Margin (dB)	Reading Level (dBuV)	Correct Factor (dB)	Detector Type
1	3306	38.20	74.00	-35.80	42.52	-4.32	PK
2	4960	47.49	74.00	-26.51	45.38	2.11	PK
3	7440	46.69	74.00	-27.31	36.18	10.51	PK
4	9920	48.98	74.00	-25.02	33.92	15.06	PK
* 5	12400	52.25	74.00	-21.75	34.26	17.99	PK

Note:

1. All reading above 1GHz is performed with peak measurements as necessary.
2. “ * ”, means this data is the worst emission level.
3. Emission Level = Reading Level + Correct Factor.
4. The average measurement was not performed when the peak measured data under the limit of average detection.
5. The Emission above 13GHz were not included is because their levels are lower than 20dB away from limit.

5. RF antenna conducted test

5.1. Test Setup

RF Conducted Measurement:

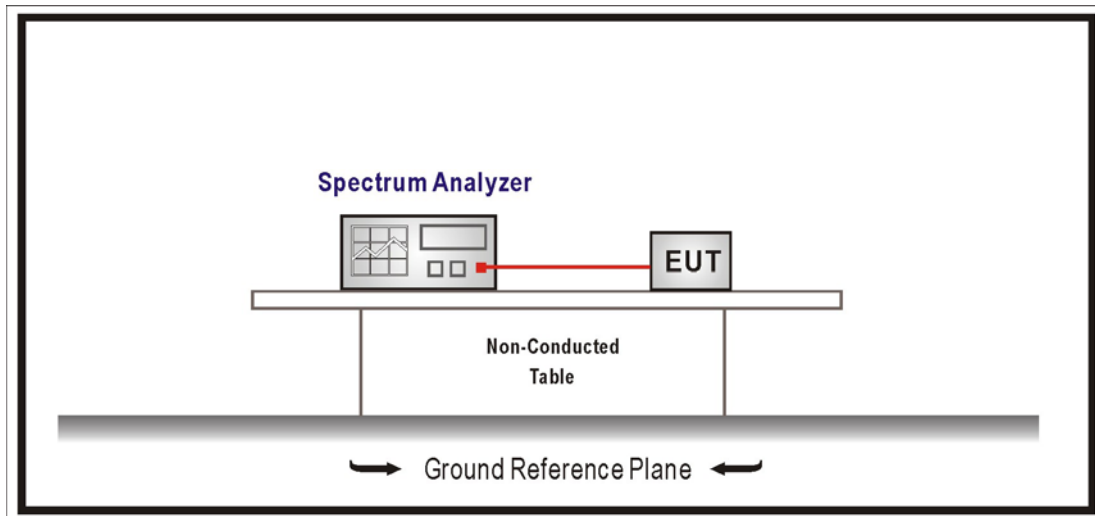

5.2. Limits

In any 100 kHz bandwidth outside the frequency band in which the spread spectrum or digitally modulated intentional radiator is operating, the radio frequency power that is produced by the intentional radiator shall be at least 20 dB below that in the 100 kHz bandwidth within the band that contains the highest level of the desired power, based on either an RF conducted or a radiated measurement, provided the transmitter demonstrates compliance with the peak conducted power limits. If the transmitter complies with the conducted power limits based on the use of RMS averaging over a time interval, the attenuation required under this paragraph shall be 30 dB instead of 20 dB. Attenuation below the general limits specified in §15.209(a) is not required. In addition, radiated emissions which fall in the restricted bands, as defined in §15.205(a), must also comply with the radiated emission limits specified in §15.209(a) (see §15.205(c)).

5.3. Test Procedure

The EUT was setup according to ANSI C63.10: 2013 and tested according to DTS test procedure of KDB558074 D01V04 for compliance to FCC 47CFR 15.247 requirements. Set RBW = 100 kHz, Set VBW > RBW, scan up through 10th harmonic.

5.4. Test Specification

According to FCC Part 15 Subpart C Paragraph 15.247: 2017

5.5. Test Result

Product	Bluetooth 5.0 LE Stamp Module		
Test Item	RF antenna conducted test		
Test Mode	Mode 1: Transmit		
Date of Test	2018/09/20	Test Site	SR10-H

GFSK

Channel	Frequency (MHz)	Measure Level (dBc)	Limit (dBc)
00	2402	48.309	≥ 20
19	2440	46.454	≥ 20
39	2480	47.159	≥ 20

Channel 00

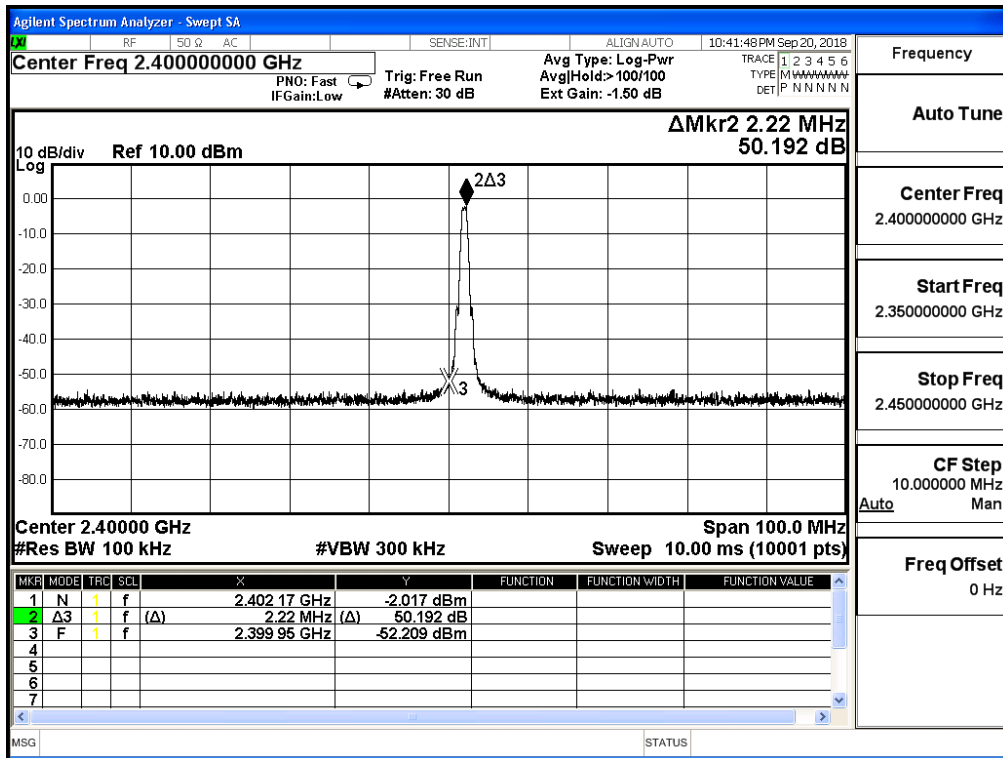

Channel 19

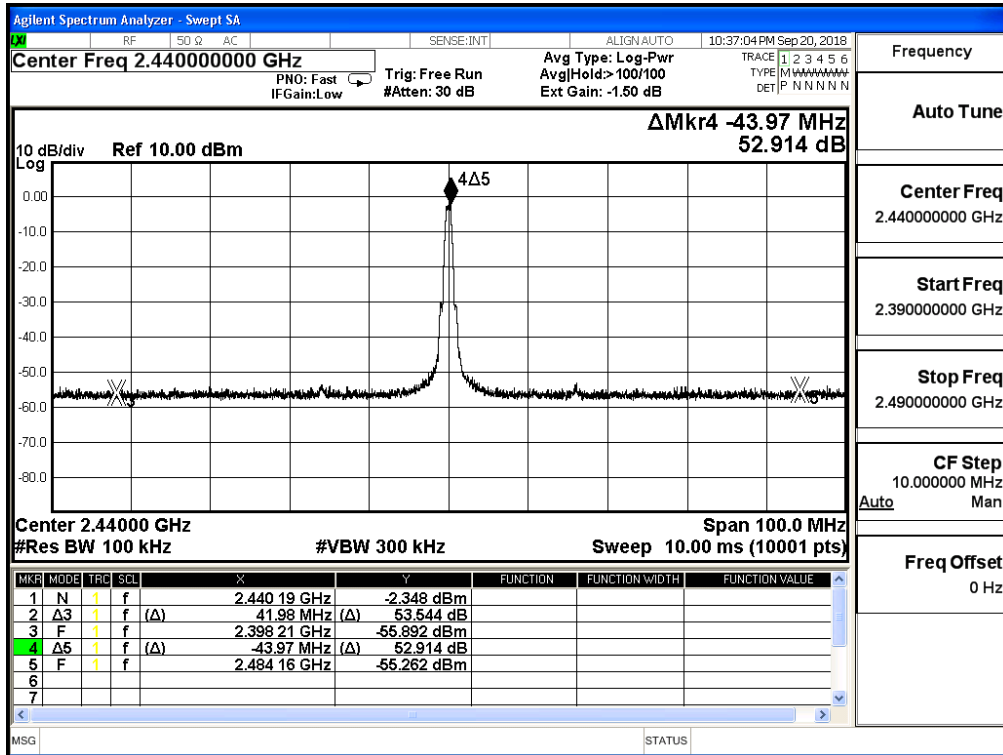

Channel 39

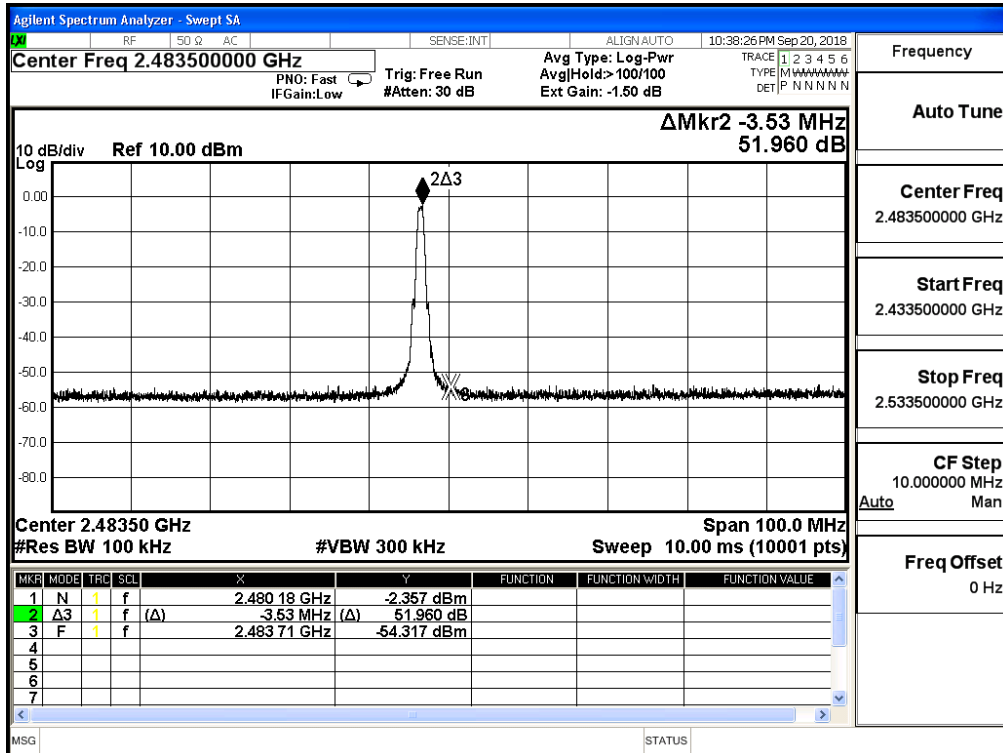

Product	Bluetooth 5.0 LE Stamp Module		
Test Item	RF antenna conducted test		
Test Mode	Mode 1: Transmit		
Date of Test	2018/09/21	Test Site	SR10-H

Channel 00 (30MHz-25GHz)- GFSK

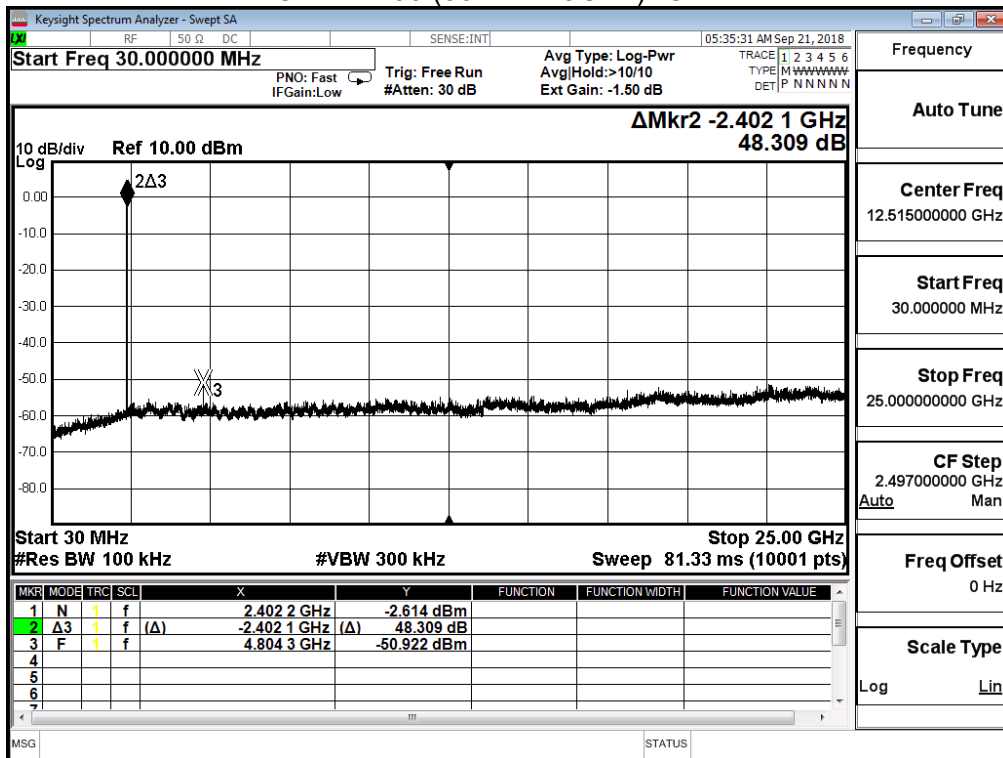

Channel 19 (30MHz-25GHz)- GFSK

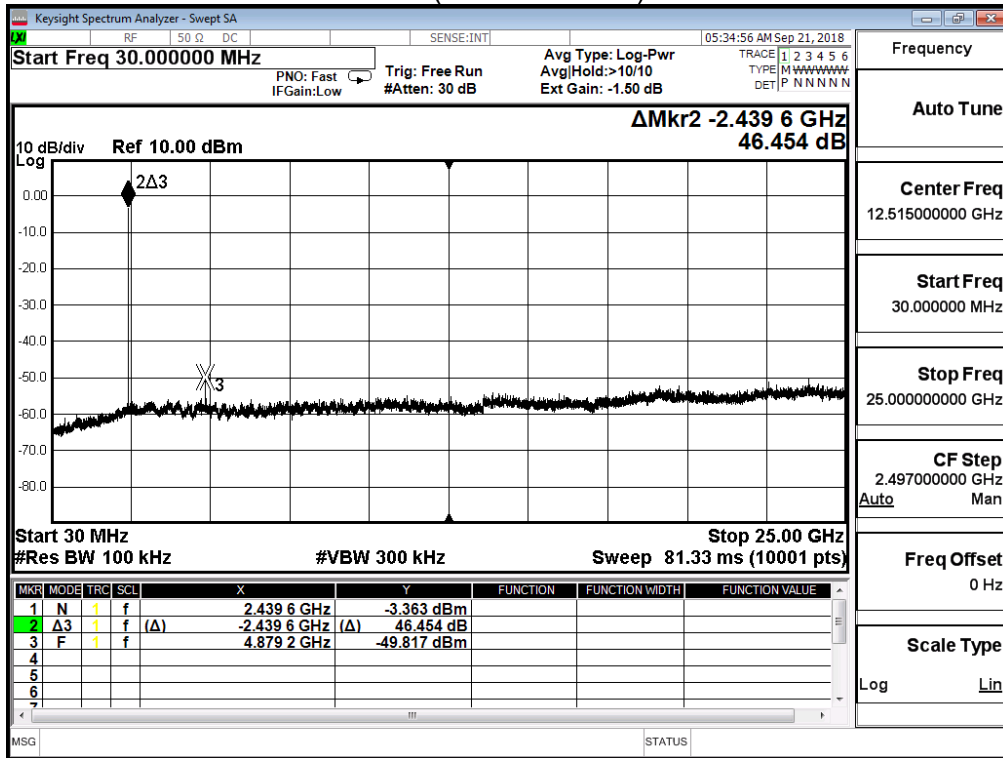

Channel 39 (30MHz-25GHz)- GFSK

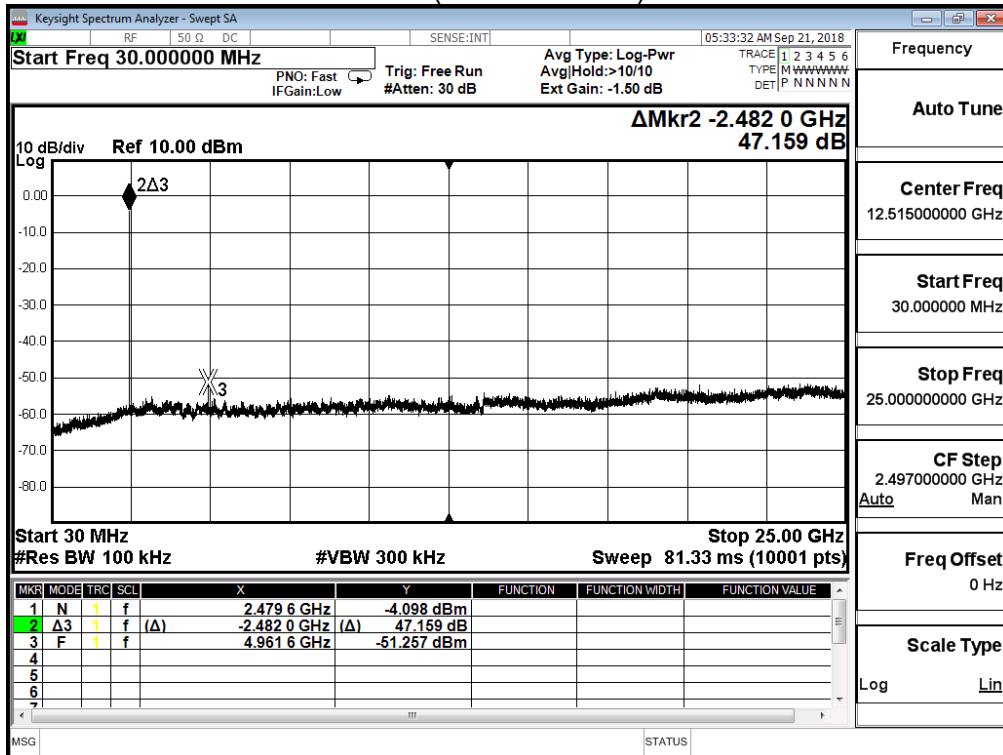

6. Radiated Emission Band Edge

6.1. Test Setup

RF Radiated Measurement:

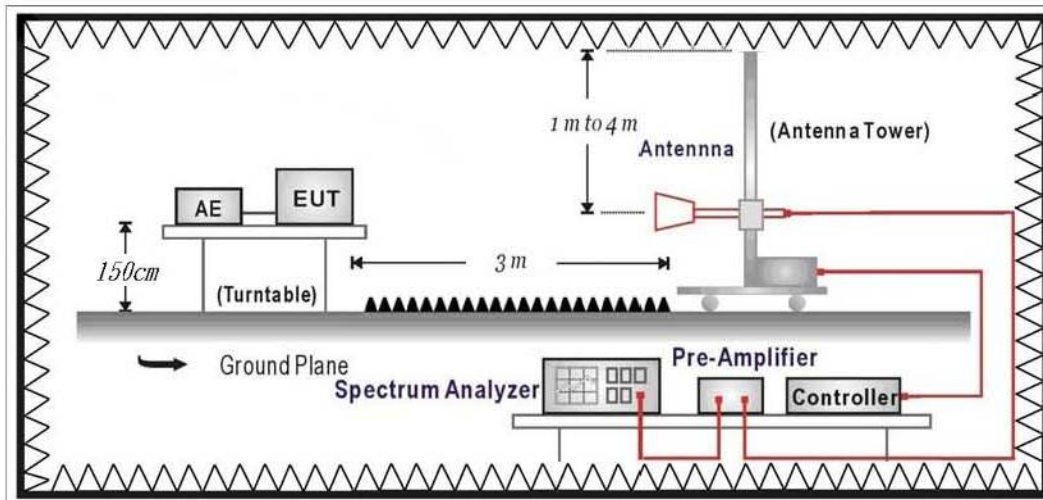

6.2. Limits

Emissions radiated outside of the specified frequency bands, except for harmonics, shall be attenuated by at least 20dB below the level of the fundamental or to the general radiated emission limits in paragraph 15.209, whichever is the lesser attenuation.

6.3. Test Procedure

The EUT was setup according to ANSI C63.10: 2013 and tested according to DTS test procedure of KDB558074 D01V04 for compliance to FCC 47CFR 15.247 requirements. The EUT and its simulators are placed on a turn table which is 0.8 meter above ground. The turn table can rotate 360 degrees to determine the position of the maximum emission level. The EUT was positioned such that the distance from antenna to the EUT was 3 meters.

The antenna can move up and down between 1 meter and 4 meters to find out the maximum emission level.

Both horizontal and vertical polarization of the antenna are set on measurement. In order to find the maximum emission, all of the interface cables must be manipulated according to ANSI C63.10: 2013 on radiated measurement.

6.4. Test Specification

According to FCC Part 15 Subpart C Paragraph 15.247:2017

6.5. Test Result

Site :	CB4-H	Engineer :	Elwin
Model No :	AW-CU362	Test Date :	2018/9/21
Test Voltage :	DC 3.3V	Polarity :	Horizontal
Test Mode :	Mode 1: Transmit		
Note :	BT5.0_2402MHz		

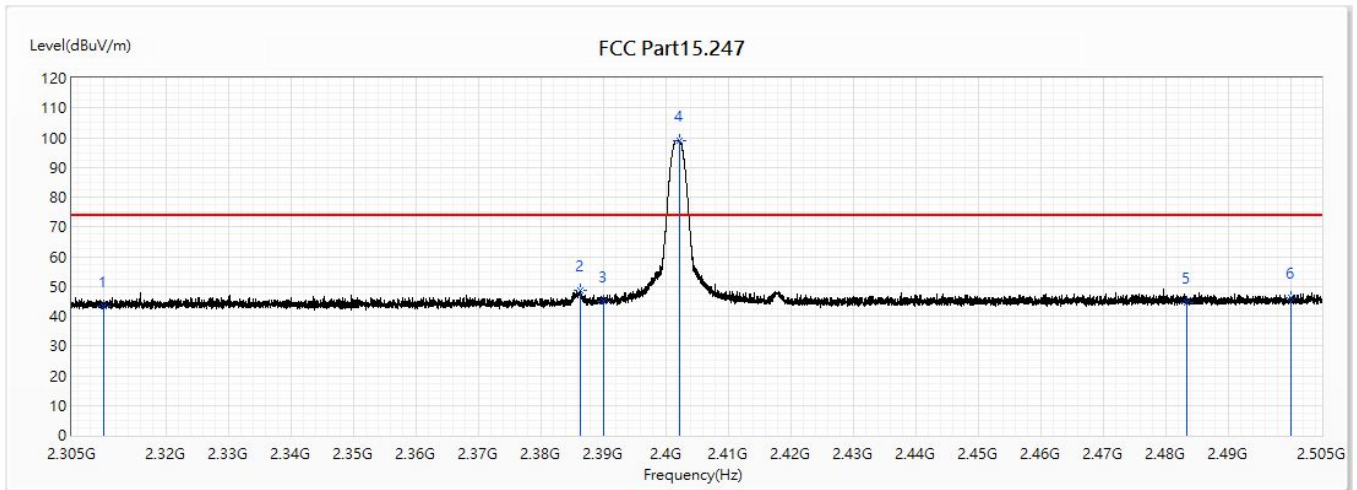

No	Frequency (MHz)	Emission Level (dBuV/m)	Limit (dBuV/m)	Margin (dB)	Reading Level (dBuV)	Correct Factor (dB)	Detector Type
1	2310	43.21	74.00	-30.79	29.13	14.08	PK
2	2386.44	48.66	74.00	-25.34	34.14	14.52	PK
3	2390	45.09	74.00	-28.91	30.56	14.53	PK
! 4	2402.24	98.98	74.00	24.98	84.38	14.60	PK
5	2483.5	44.61	74.00	-29.39	29.52	15.09	PK
6	2500	46.31	74.00	-27.69	31.12	15.19	PK

Note:

1. All reading above 1GHz is performed with peak measurements as necessary.
2. “ * ”, means this data is the worst emission level.
3. Emission Level = Reading Level + Correct Factor.
4. The average measurement was not performed when the peak measured data under the limit of average detection. If the readings given are average, peak measurement should also be supplied.
5. The fundamental for reference only, it’s not restricted by unwanted emission limit.

Site :	CB4-H	Engineer :	Elwin
Model No :	AW-CU362	Test Date :	2018/9/21
Test Voltage :	DC 3.3V	Polarity :	Vertical
Test Mode :	Mode 1: Transmit		
Note :	BT5.0_2402MHz		

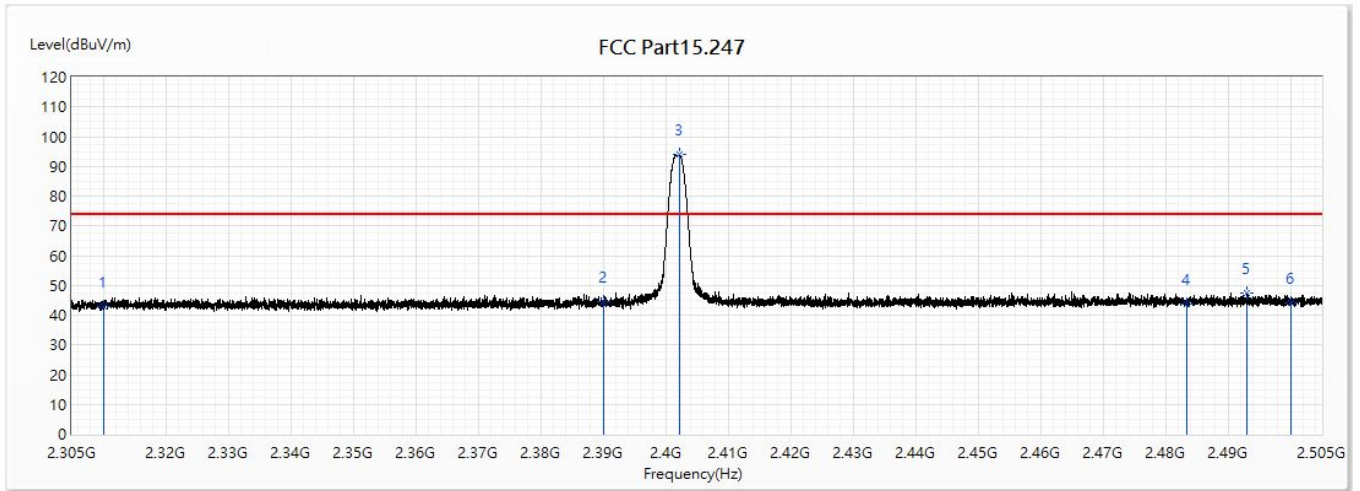

No	Frequency (MHz)	Emission Level (dBuV/m)	Limit (dBuV/m)	Margin (dB)	Reading Level (dBuV)	Correct Factor (dB)	Detector Type
1	2310	43.01	74.00	-30.99	28.93	14.08	PK
2	2390	44.59	74.00	-29.41	30.06	14.53	PK
! 3	2402.16	93.82	74.00	19.82	79.22	14.60	PK
4	2483.5	43.79	74.00	-30.21	28.70	15.09	PK
5	2493.06	47.54	74.00	-26.46	32.39	15.15	PK
6	2500	44.11	74.00	-29.89	28.92	15.19	PK

Note:

1. All reading above 1GHz is performed with peak measurements as necessary.
2. “ * ”, means this data is the worst emission level.
3. Emission Level = Reading Level + Correct Factor.
4. The average measurement was not performed when the peak measured data under the limit of average detection. If the readings given are average, peak measurement should also be supplied.
5. The fundamental for reference only, it’s not restricted by unwanted emission limit.

Site :	CB4-H	Engineer :	Elwin
Model No :	AW-CU362	Test Date :	2018/9/21
Test Voltage :	DC 3.3V	Polarity :	Horizontal
Test Mode :	Mode 1: Transmit		
Note :	BT5.0_2440MHz		

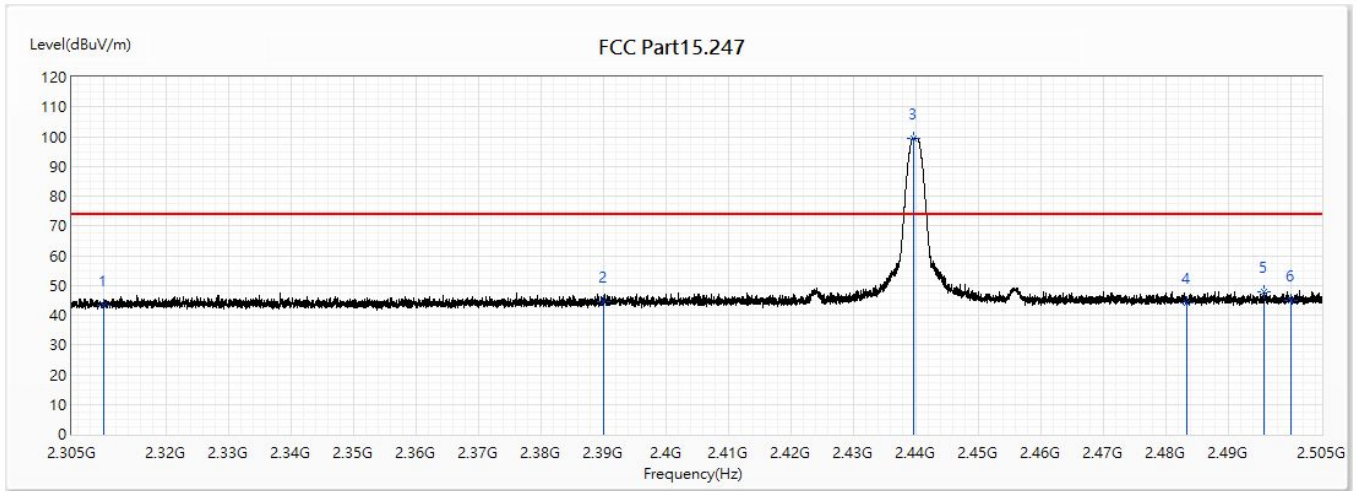

No	Frequency (MHz)	Emission Level (dBuV/m)	Limit (dBuV/m)	Margin (dB)	Reading Level (dBuV)	Correct Factor (dB)	Detector Type
1	2310	43.18	74.00	-30.82	29.10	14.08	PK
2	2390	44.50	74.00	-29.50	29.97	14.53	PK
! 3	2439.68	99.56	74.00	25.56	84.73	14.83	PK
4	2483.5	44.25	74.00	-29.75	29.16	15.09	PK
5	2495.7	47.85	74.00	-26.15	32.69	15.16	PK
6	2500	45.04	74.00	-28.96	29.85	15.19	PK

Note:

1. All reading above 1GHz is performed with peak measurements as necessary.
2. “ * ”, means this data is the worst emission level.
3. Emission Level = Reading Level + Correct Factor.
4. The average measurement was not performed when the peak measured data under the limit of average detection. If the readings given are average, peak measurement should also be supplied.
5. The fundamental for reference only, it's not restricted by unwanted emission limit.

Site :	CB4-H	Engineer :	Elwin
Model No :	AW-CU362	Test Date :	2018/9/21
Test Voltage :	DC 3.3V	Polarity :	Vertical
Test Mode :	Mode 1: Transmit		
Note :	BT5.0_2440MHz		

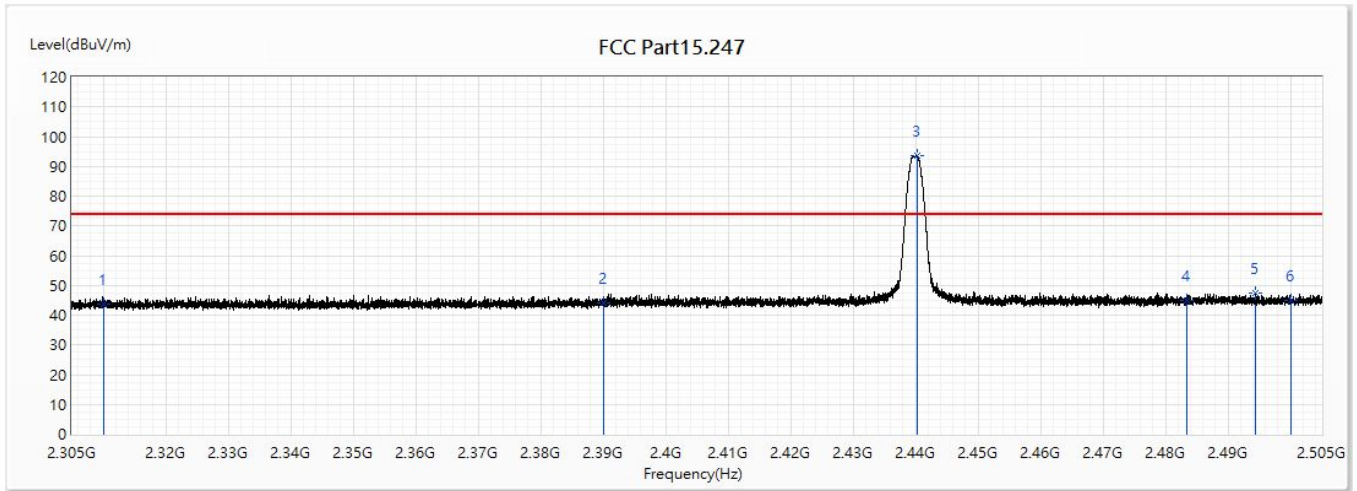

No	Frequency (MHz)	Emission Level (dBuV/m)	Limit (dBuV/m)	Margin (dB)	Reading Level (dBuV)	Correct Factor (dB)	Detector Type
1	2310	43.78	74.00	-30.22	29.70	14.08	PK
2	2390	44.13	74.00	-29.87	29.60	14.53	PK
! 3	2440.22	93.44	74.00	19.44	78.61	14.83	PK
4	2483.5	44.90	74.00	-29.10	29.81	15.09	PK
5	2494.38	47.44	74.00	-26.56	32.29	15.15	PK
6	2500	44.86	74.00	-29.14	29.67	15.19	PK

Note:

1. All reading above 1GHz is performed with peak measurements as necessary.
2. “ * ”, means this data is the worst emission level.
3. Emission Level = Reading Level + Correct Factor.
4. The average measurement was not performed when the peak measured data under the limit of average detection. If the readings given are average, peak measurement should also be supplied.
5. The fundamental for reference only, it's not restricted by unwanted emission limit.

Site :	CB4-H	Engineer :	Elwin
Model No :	AW-CU362	Test Date :	2018/9/21
Test Voltage :	DC 3.3V	Polarity :	Horizontal
Test Mode :	Mode 1: Transmit		
Note :	BT5.0_2480MHz		

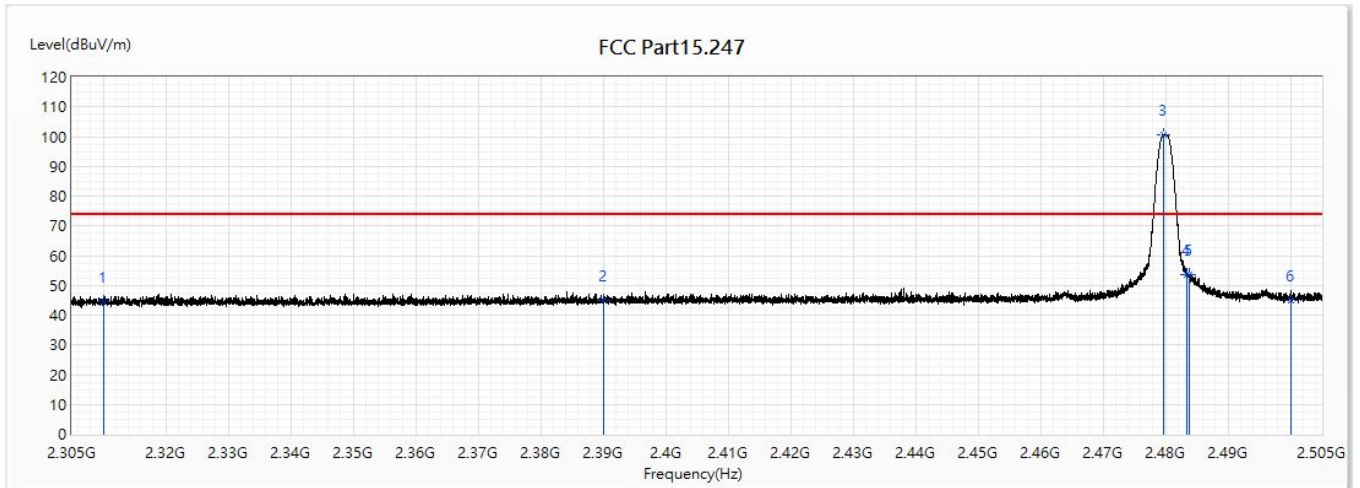

No	Frequency (MHz)	Emission Level (dBuV/m)	Limit (dBuV/m)	Margin (dB)	Reading Level (dBuV)	Correct Factor (dB)	Detector Type
1	2310	44.36	74.00	-29.64	30.28	14.08	PK
2	2390	44.88	74.00	-29.12	30.35	14.53	PK
! 3	2479.68	100.61	74.00	26.61	85.54	15.07	PK
4	2483.5	53.77	74.00	-20.23	38.68	15.09	PK
5	2483.82	53.59	74.00	-20.41	38.50	15.09	PK
6	2500	44.85	74.00	-29.15	29.66	15.19	PK

Note:

1. All reading above 1GHz is performed with peak measurements as necessary.
2. “ * ”, means this data is the worst emission level.
3. Emission Level = Reading Level + Correct Factor.
4. The average measurement was not performed when the peak measured data under the limit of average detection. If the readings given are average, peak measurement should also be supplied.
5. The fundamental for reference only, it’s not restricted by unwanted emission limit.

Site :	CB4-H	Engineer :	Elwin
Model No :	AW-CU362	Test Date :	2018/9/21
Test Voltage :	DC 3.3V	Polarity :	Vertical
Test Mode :	Mode 1: Transmit		
Note :	BT5.0_2480MHz		

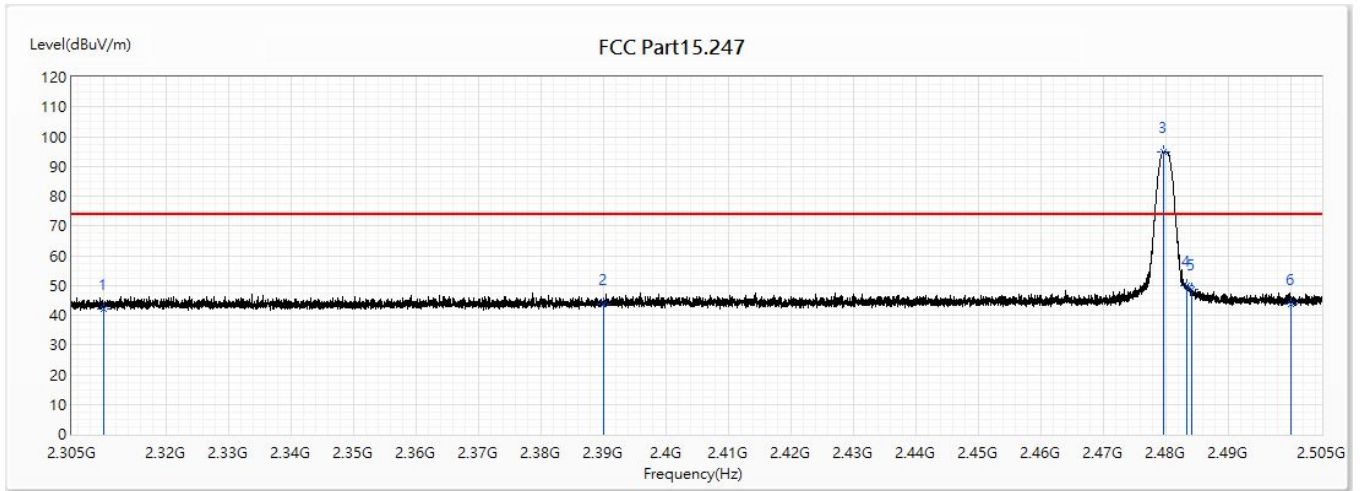

No	Frequency (MHz)	Emission Level (dBuV/m)	Limit (dBuV/m)	Margin (dB)	Reading Level (dBuV)	Correct Factor (dB)	Detector Type
1	2310	42.05	74.00	-31.95	27.97	14.08	PK
2	2390	43.75	74.00	-30.25	29.22	14.53	PK
! 3	2479.68	94.87	74.00	20.87	79.80	15.07	PK
4	2483.5	49.74	74.00	-24.26	34.65	15.09	PK
5	2484.24	48.80	74.00	-25.20	33.71	15.09	PK
6	2500	43.77	74.00	-30.23	28.58	15.19	PK

Note:

1. All reading above 1GHz is performed with peak measurements as necessary.
2. “ * ”, means this data is the worst emission level.
3. Emission Level = Reading Level + Correct Factor.
4. The average measurement was not performed when the peak measured data under the limit of average detection. If the readings given are average, peak measurement should also be supplied.
5. The fundamental for reference only, it’s not restricted by unwanted emission limit.

7. Occupied Bandwidth & DTS Bandwidth

7.1. Test Setup

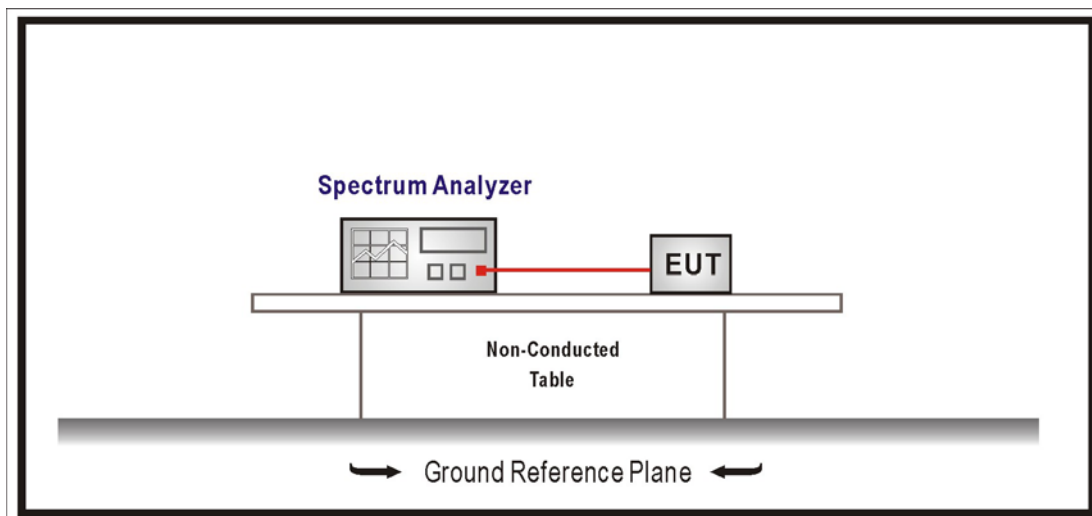

7.2. Limits

The 6 dB bandwidth: ≥ 500 kHz.

Occupied Bandwidth: NA

7.3. Test Procedures

The EUT was setup according to ANSI C63.10: 2013; tested according to DTS test procedure of KDB558074 D01V04 for compliance to FCC 47CFR 15.247 requirements.

7.4. Test Specification

According to FCC Part 15 Subpart C Paragraph 15.247:2017

7.5. Test Result

Product	Bluetooth 5.0 LE Stamp Module		
Test Item	Occupied Bandwidth		
Test Mode	Mode 1: Transmit		
Date of Test	2018/09/20	Test Site	SR10-H

Occupied Bandwidth:

Channel No.	Frequency (MHz)	Measure Level (MHz)	Limit (MHz)
00	2402	1.072	--
19	2440	1.085	--
39	2480	1.106	--

Channel 00

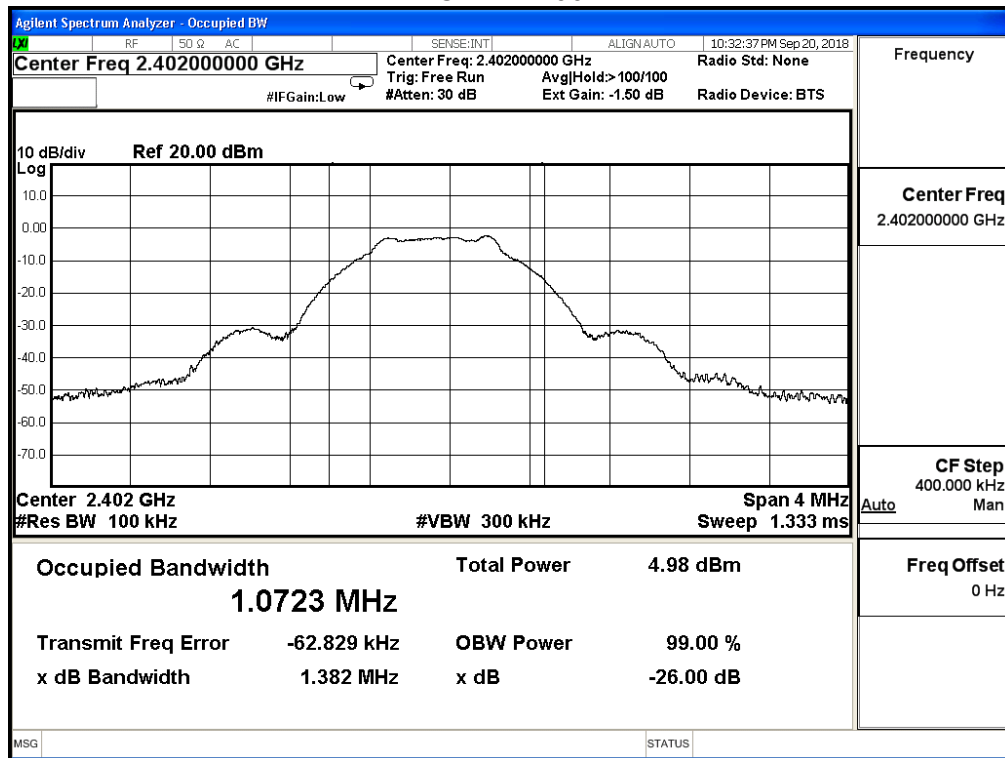

Channel 19

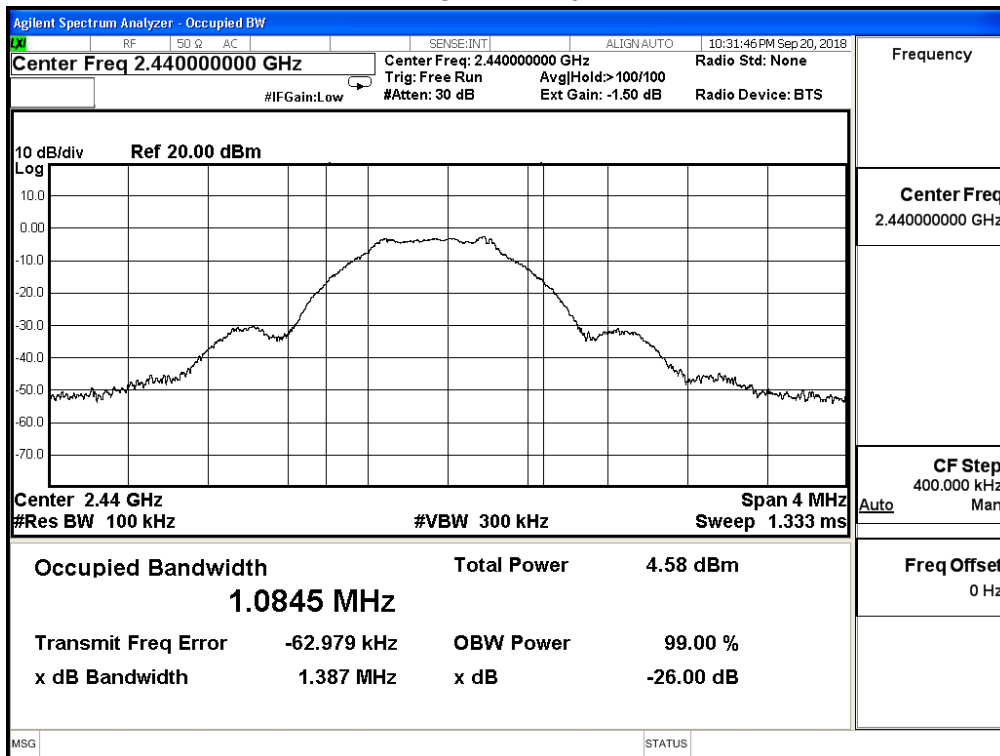

Channel 39

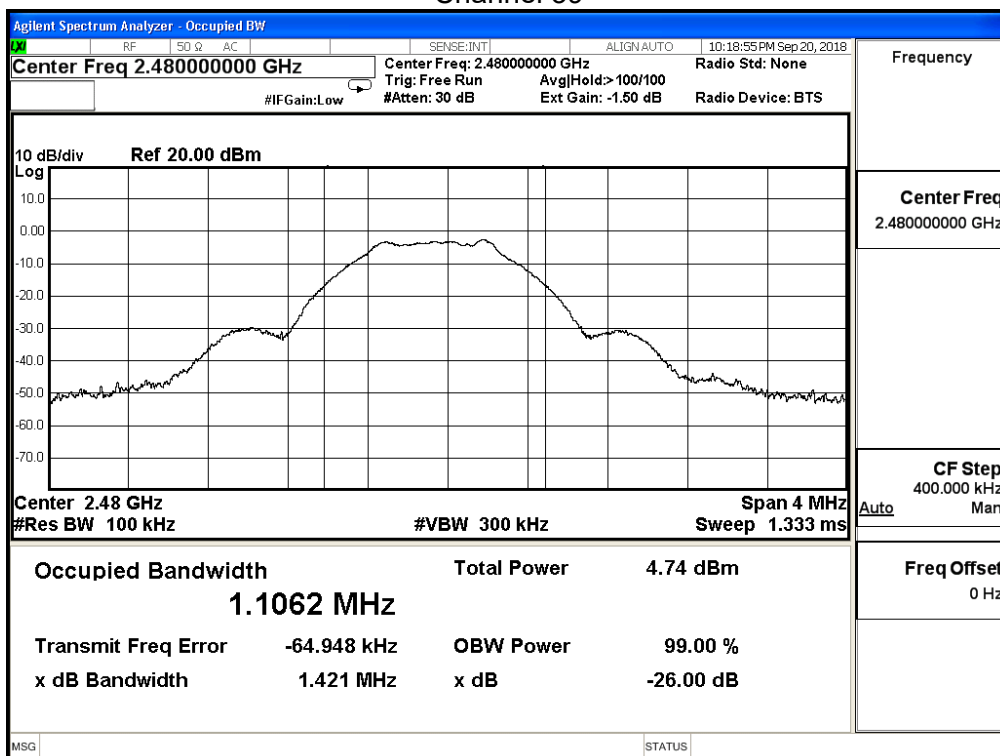

Product	Bluetooth 5.0 LE Stamp Module		
Test Item	DTS Bandwidth		
Test Mode	Mode 1: Transmit		
Date of Test	2018/09/20	Test Site	SR10-H

DTS Bandwidth:

Channel No.	Frequency (MHz)	Measure Level (kHz)	Limit (kHz)
00	2402	719.600	≥ 500
19	2440	739.300	≥ 500
39	2480	744.800	≥ 500

Channel 00

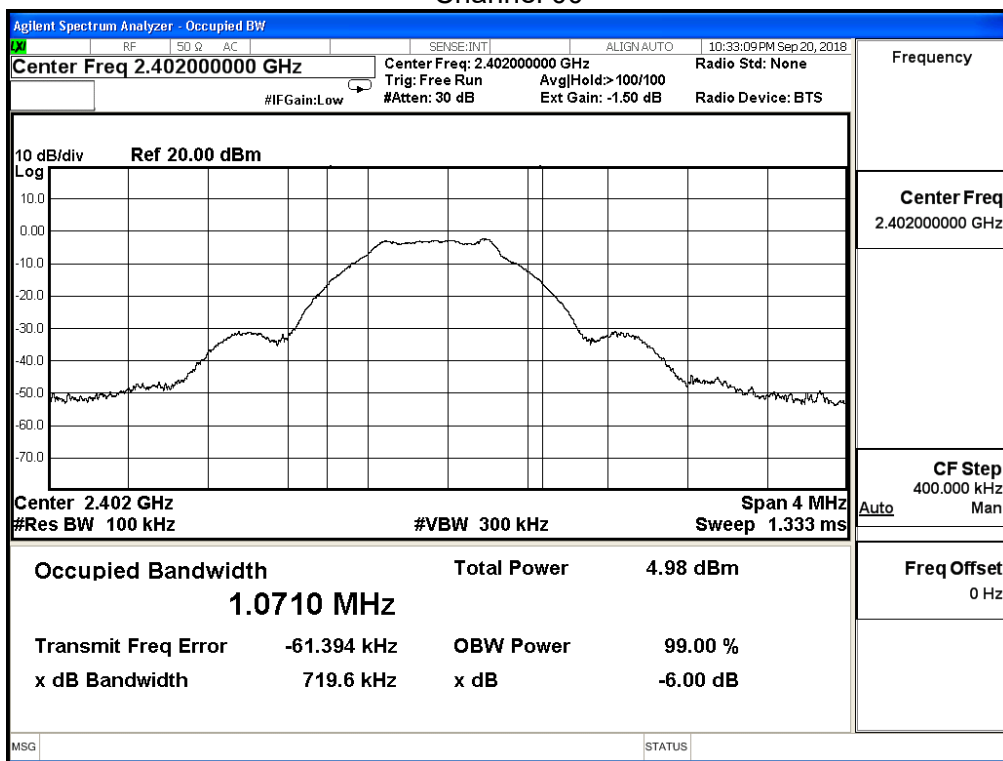

Channel 19

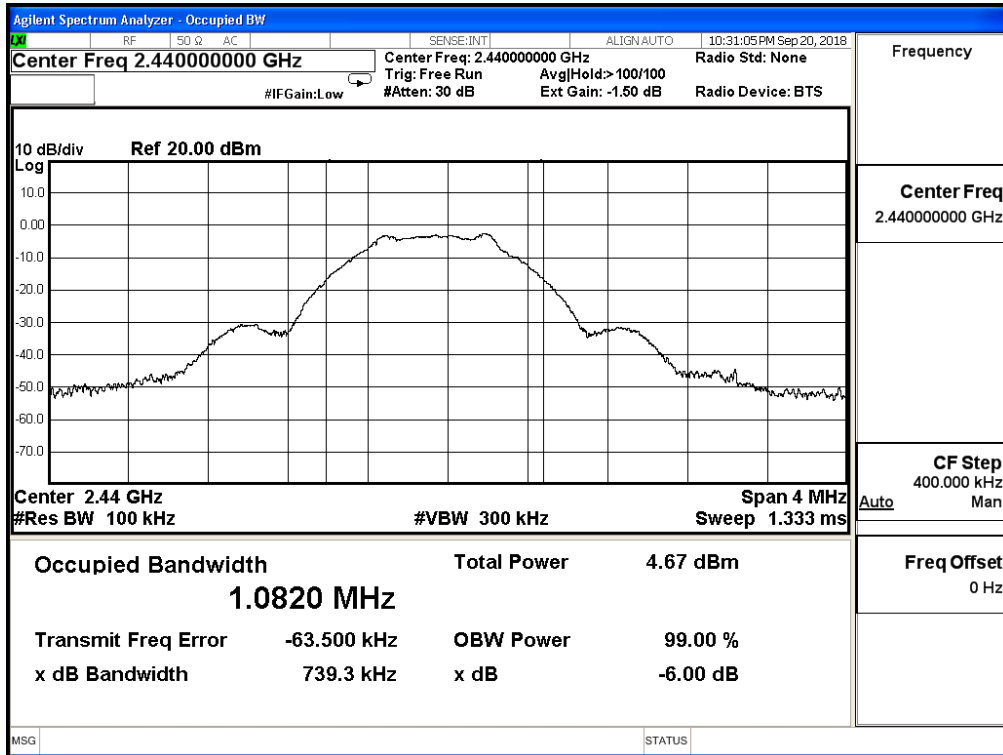

Channel 39

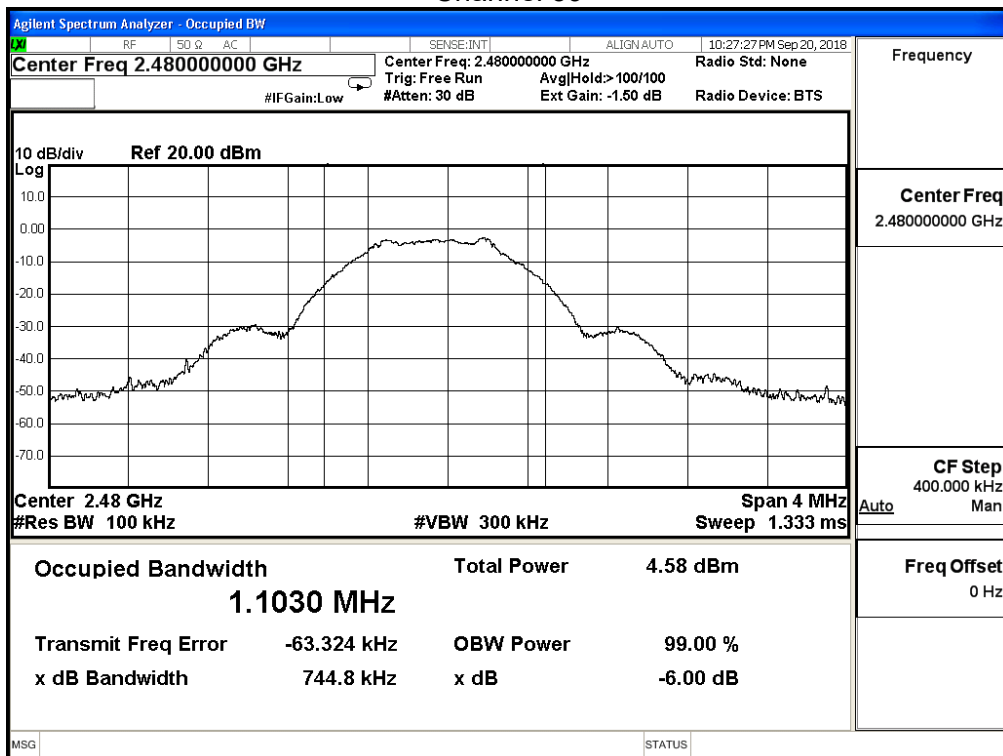

8. Power Density

8.1. Test Setup

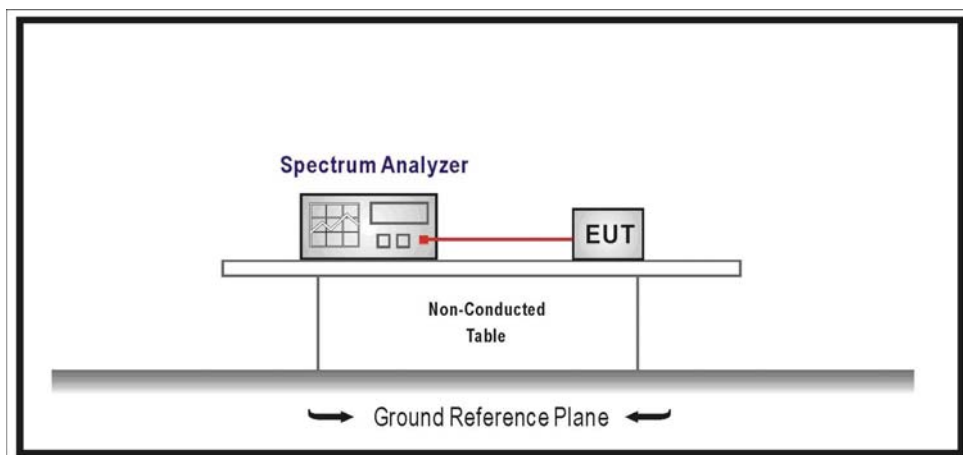

8.2. Limits

The peak power spectral density conducted from the intentional radiated to the antenna shall not be greater than +8dBm in any 3kHz band during any time interval of continuous transmission.

8.3. Test Procedures

The EUT was setup according to ANSI C63.10: 2013; tested according to DTS test procedure of KDB558074 D01V04 for compliance to FCC 47CFR 15.247 requirements.

8.4. Test Specification

According to FCC Part 15 Subpart C Paragraph 15.247

8.5. Test Result

Product	Bluetooth 5.0 LE Stamp Module		
Test Item	Power Density		
Test Mode	Mode 1: Transmit		
Date of Test	2018/09/20	Test Site	SR10-H

Channel No.	Frequency (MHz)	Measure Vaule (dBm/10kHz)	Limit (dBm/10kHz)
00	2402	-11.560	≤ 8
19	2440	-11.827	≤ 8
39	2480	-11.937	≤ 8

Channel 00

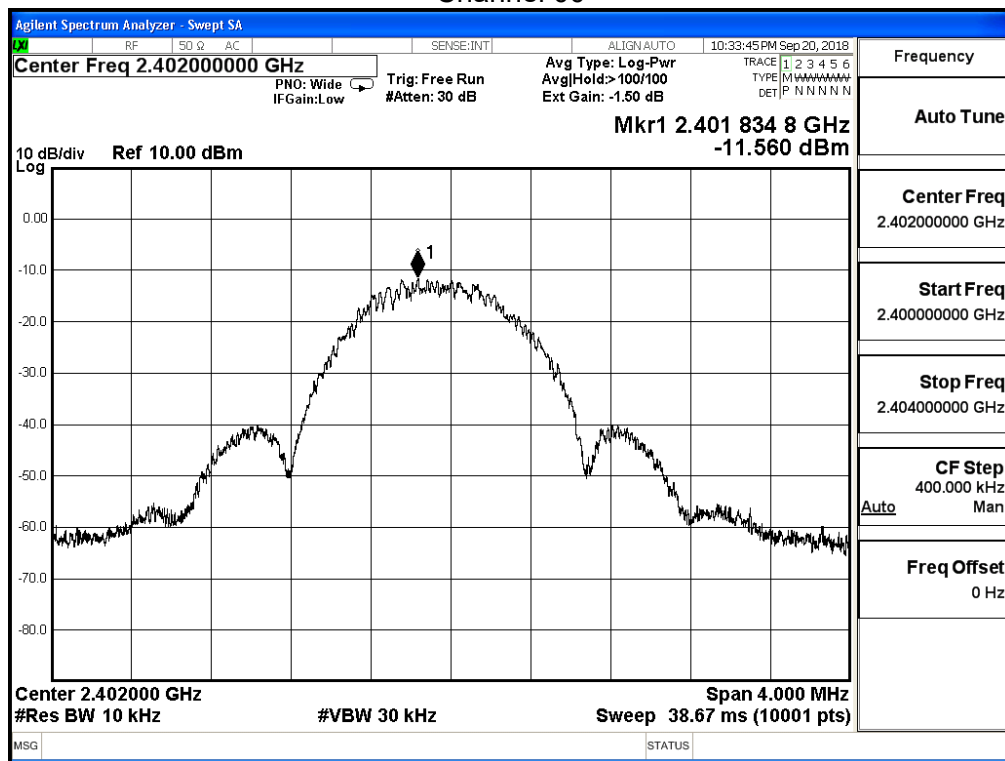

Channel 19

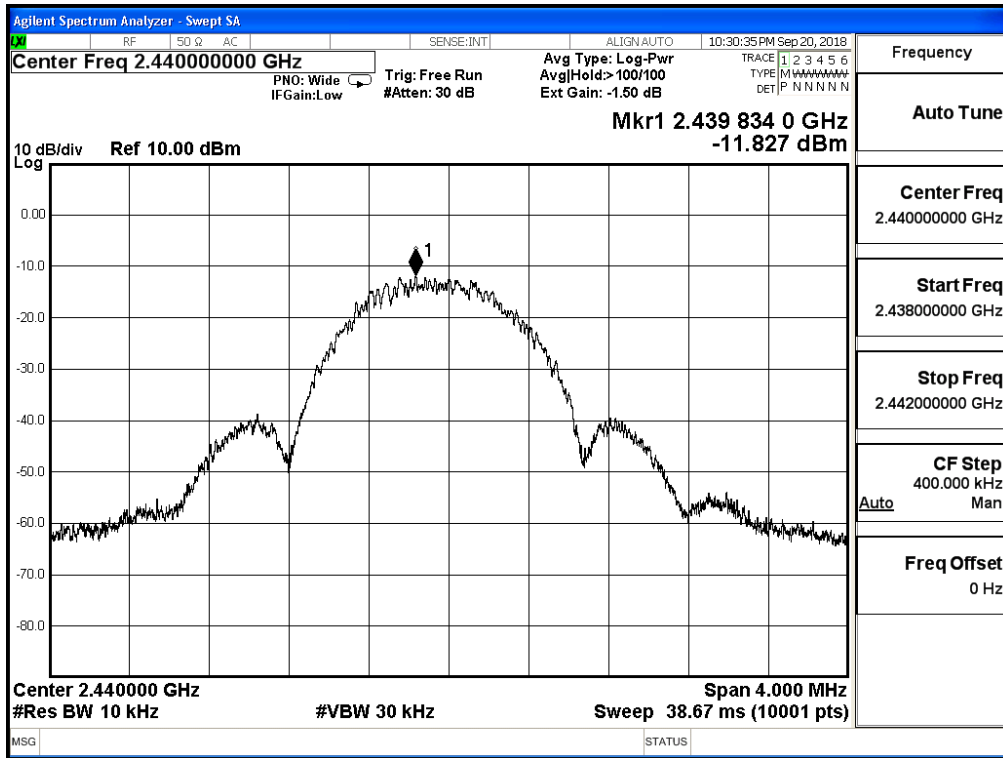

Channel 39

