



RADIO TEST REPORT

FCC ID : TLZ-XM9098

Equipment : IEEE 802.112X2 WiFi 6 SU and MU-MIMO DBC
Wireless LAN + Bluetooth 5.1 Combo Module

Brand Name : AzureWave

Model Name : AW-XM458, AW-XM369, AW-XM458MA-XXX,
AW-XM369MA-XXX

Applicant : AzureWave Technologies, Inc.
8F., No.94, Baozhong Rd. , Xindian Dist., New
Taipei City , Taiwan 231

Manufacturer : AzureWave Technologies (Shanghai) Inc.
No. 1355, Jiaxin Road, Malu Twon, Jiading District
Shanghai, P.R. China

Standard : 47 CFR FCC Part 15.247

The product was received on Apr. 13, 2021, and testing was started from May 28, 2021 and completed on Sep. 24, 2021. We, Sporton International Inc. Hsinchu Laboratory, would like to declare that the tested sample has been evaluated in accordance with the procedures given in ANSI C63.10-2013 and shown compliance with the applicable technical standards.

The test results in this report apply exclusively to the tested model / sample. Without written approval of Sporton International Inc. Hsinchu Laboratory, the test report shall not be reproduced except in full.



Approved by: Sam Chen

Sporton International Inc. Hsinchu Laboratory
No.8, Ln. 724, Bo'ai St., Zhubei City, Hsinchu County 302010, Taiwan (R.O.C.)



Table of Contents

History of this test report.....3

Summary of Test Result.....4

1 General Description5

1.1 Information.....5

1.2 Applicable Standards8

1.3 Testing Location Information8

1.4 Measurement Uncertainty9

2 Test Configuration of EUT10

2.1 Test Channel Mode10

2.2 The Worst Case Measurement Configuration11

2.3 EUT Operation during Test12

2.4 Accessories12

2.5 Support Equipment.....13

2.6 Test Setup Diagram14

3 Transmitter Test Result17

3.1 AC Power-line Conducted Emissions17

3.2 DTS Bandwidth19

3.3 Maximum Conducted Output Power20

3.4 Power Spectral Density23

3.5 Emissions in Non-restricted Frequency Bands25

3.6 Emissions in Restricted Frequency Bands.....26

4 Test Equipment and Calibration Data30

Appendix A. Test Results of AC Power-line Conducted Emissions

Appendix B. Test Results of DTS Bandwidth

Appendix C. Test Results of Maximum Conducted Output Power

Appendix D. Test Results of Power Spectral Density

Appendix E. Test Results of Emissions in Non-restricted Frequency Bands

Appendix F. Test Results of Emissions in Restricted Frequency Bands

Appendix G. Test Photos

Photographs of EUT v01



History of this test report

Report No.	Version	Description	Issued Date
FR132339AD	01	Initial issue of report.	Sep. 29, 2021



Summary of Test Result

Report Clause	Ref Std. Clause	Test Items	Result (PASS/FAIL)	Remark
1.1.2	15.203	Antenna Requirement	PASS	-
3.1	15.207	AC Power-line Conducted Emissions	PASS	-
3.2	15.247(a)	DTS Bandwidth	PASS	-
3.3	15.247(b)	Maximum Conducted Output Power	PASS	-
3.4	15.247(e)	Power Spectral Density	PASS	-
3.5	15.247(d)	Emissions in Non-restricted Frequency Bands	PASS	-
3.6	15.247(d)	Emissions in Restricted Frequency Bands	PASS	-

Declaration of Conformity:

The test results with all measurement uncertainty excluded are presented in accordance with the regulation limits or requirements declared by manufacturers.

Comments and Explanations:

The declared of product specification for EUT presented in the report are provided by the manufacturer, and the manufacturer takes all the responsibilities for the accuracy of product specification.

Reviewed by: Sam Chen
Report Producer: Sandy Chuang



1 General Description

1.1 Information

1.1.1 RF General Information

Frequency Range (MHz)	Bluetooth Mode	Ch. Frequency (MHz)	Channel Number
2400-2483.5	LE	2402-2480	0-39 [40]

Band	Mode	BWch (MHz)	Nant
2.4-2.4835GHz	BT-LE(1Mbps)	1.0	1TX
2.4-2.4835GHz	BT-LE(500Kb/s)	1.0	1TX
2.4-2.4835GHz	BT-LE(125Kb/s)	1.0	1TX
2.4-2.4835GHz	BT-LE(2Mbps)	2.0	1TX

Note:

- ♦ Bluetooth LE uses a GFSK modulation.
- ♦ BWch is the nominal channel bandwidth.



1.1.2 Antenna Information

Ant.	Port		Brand	Model Name	Antenna Type	Connector	Gain (dBi)
	2.4GHz	5GHz					
1	1	1	MAG. LAYERS	MSA-4008-25GC1-A2	PIFA	I-PEX	Note 1
2	2	2	MAG. LAYERS	MSA-4008-25GC1-A2	PIFA	I-PEX	
3	1	1	MAG. LAYERS	MSA-4008-25GC1-A2	PIFA	I-PEX	

Note1:

Ant.	Port		Antenna Gain (dBi)		
	2.4GHz	5GHz	WLAN 2.4GHz	WLAN 5GHz	Bluetooth
1	1	1	2.98	5.16	-
2	2	2	2.98	5.16	-
3	1	1	-	-	2.98

Note2: The above information was declared by manufacturer.

Note3:

<WLAN 2.4GHz Function>

For IEEE 802.11b/g/n/ax (2TX/2RX):

Port 1 and Port 2 can be used as transmitting/receiving antenna.

Port 1 and Port 2 could transmit/receive simultaneously.

<WLAN 5GHz Function>

For IEEE 802.11a/n/ac/ax (2TX/2RX):

Port 1 and Port 2 can be used as transmitting/receiving antenna.

Port 1 and Port 2 could transmit/receive simultaneously.

<Bluetooth Function> (1TX/1RX)

Only Port 1 can be used as transmitting/receiving.



1.1.3 Mode Test Duty Cycle

Mode	DC	DCF(dB)	T(s)	VBW(Hz) ≥ 1/T
BT-LE(1Mbps)	0.632	1.99	395u	3k
BT-LE(2Mbps)	0.632	1.99	394.844u	3k

Note:

- ◆ DC is Duty Cycle.
- ◆ DCF is Duty Cycle Factor.

1.1.4 EUT Operational Condition

EUT Power Type	From host system			
Function	<input checked="" type="checkbox"/> Point-to-multipoint	<input type="checkbox"/> Point-to-point		
Test Software Version	DutApiMimoApApp (Version : 2.0.0.80)			
Support Mode	<input checked="" type="checkbox"/> LE 1M PHY: 1 Mb/s			
	<input checked="" type="checkbox"/> LE Coded PHY (S=2): 500 Kb/s			
	<input checked="" type="checkbox"/> LE Coded PHY (S=8): 125 Kb/s			
	<input checked="" type="checkbox"/> LE 2M PHY: 2 Mb/s			

Note: The above information was declared by manufacturer.

1.1.5 Table for Multiple Listing

Model No.	GPIO	Description
AW-XM458	Without GPIO	All the model names are identical, the difference model names served as marketing strategy.
AW-XM369		
AW-XM458MA-XXX	With GPIO	All the model names are identical, the difference model names served as marketing strategy.
AW-XM369MA-XXX		

Note 1: From the above models, model: AW-XM458MA-XXX was selected as representative model for the test and its data was recorded in this report.

Note 2: The above information was declared by manufacturer.



1.2 Applicable Standards

According to the specifications of the manufacturer, the EUT must comply with the requirements of the following standards:

- ◆ 47 CFR FCC Part 15
- ◆ ANSI C63.10-2013

The following reference test guidance is not within the scope of accreditation of TAF.

- ◆ FCC KDB 558074 D01 v05r02
- ◆ FCC KDB 414788 D01 v01r01

1.3 Testing Location Information

Testing Location Information	
Test Lab. : Sporton International Inc. Hsinchu Laboratory	
Hsinchu (TAF: 3787)	ADD: No.8, Ln. 724, Bo'ai St., Zhubei City, Hsinchu County 302010, Taiwan (R.O.C.) TEL: 886-3-656-9065 FAX: 886-3-656-9085 Test site Designation No. TW3787 with FCC. Conformity Assessment Body Identifier (CABID) TW3787 with ISED.

Test Condition	Test Site No.	Test Engineer	Test Environment (°C / %)	Test Date
RF Conducted	TH02-CB	Paul Chen	23.4-25.7 / 64-66	Jun. 02, 2021~ Aug. 19, 2021
Radiated (Below 1GHz)	10CH01-CB	Peter Wu	24~25 / 58~59	Sep. 24, 2021
Radiated (Above 1GHz)	03CH01-CB	JN Chang	23.9-26.1 / 55-58	May 28, 2021~ Jun. 03, 2021
AC Conduction	CO01-CB	Wei Li	22~24 / 57~59	Sep. 24, 2021



1.4 Measurement Uncertainty

ISO/IEC 17025 requires that an estimate of the measurement uncertainties associated with the emissions test results be included in the report. The measurement uncertainties given below are based on a 95% confidence level (based on a coverage factor (k=2))

Test Items	Uncertainty	Remark
Conducted Emission (150kHz ~ 30MHz)	2.0 dB	Confidence levels of 95%
Radiated Emission (9kHz ~ 30MHz)	1.6 dB	Confidence levels of 95%
Radiated Emission (30MHz ~ 1,000MHz)	4.2 dB	Confidence levels of 95%
Radiated Emission (1GHz ~ 18GHz)	4.7 dB	Confidence levels of 95%
Radiated Emission (18GHz ~ 40GHz)	4.2 dB	Confidence levels of 95%
Conducted Emission	2.5 dB	Confidence levels of 95%
Output Power Measurement	1.3 dB	Confidence levels of 95%
Power Density Measurement	2.5 dB	Confidence levels of 95%
Bandwidth Measurement	0.9%	Confidence levels of 95%



2 Test Configuration of EUT

2.1 Test Channel Mode

Mode	Power Setting
BT-LE(1Mbps)	-
2402MHz	4
2440MHz	4
2480MHz	4
BT-LE(2Mbps)	-
2402MHz	4
2440MHz	4
2480MHz	4



2.2 The Worst Case Measurement Configuration

The Worst Case Mode for Following Conformance Tests	
Tests Item	AC power-line conducted emissions
Condition	AC power-line conducted measurement for line and neutral
Operating Mode	Normal Link
1	EUT with GPIO + WLAN 2.4GHz + WLAN 5GHz + Bluetooth + Ant.

The Worst Case Mode for Following Conformance Tests	
Tests Item	DTS Bandwidth Maximum Conducted Output Power Power Spectral Density Emissions in Non-restricted Frequency Bands
Test Condition	Conducted measurement at transmit chains



The Worst Case Mode for Following Conformance Tests	
Tests Item	Emissions in Restricted Frequency Bands
Test Condition	Radiated measurement If EUT consist of multiple antenna assembly (multiple antenna are used in EUT regardless of spatial multiplexing MIMO configuration), the radiated test should be performed with highest antenna gain of each antenna type.
Operating Mode < 1GHz	Normal Link
1	EUT with GPIO in Z axis + WLAN 2.4GHz + WLAN 5GHz + Bluetooth + Ant.
2	EUT with GPIO in Y axis + WLAN 2.4GHz + WLAN 5GHz + Bluetooth + Ant.
For operating mode 2 is the worst case and it was record in this test report.	
Operating Mode > 1GHz	CTX
The EUT was performed at X axis, Y axis and Z axis position, and the worst case as below:	
1	EUT with GPIO in Y axis

The Worst Case Mode for Following Conformance Tests	
Tests Item	Simultaneous Transmission Analysis - Co-location RF Exposure Evaluation
Operating Mode	
1	WLAN 2.4GHz + WLAN 5GHz + Bluetooth
Refer to Sporton Test Report No.: FA132339 for Co-location RF Exposure Evaluation.	

2.3 EUT Operation during Test

For CTX Mode:

The EUT was programmed to be in continuously transmitting mode.

For Normal Link Mode:

During the test, the EUT operation to normal function.

2.4 Accessories

N/A



2.5 Support Equipment

For AC Conduction:

Support Equipment				
No.	Equipment	Brand Name	Model Name	FCC ID
A	NB	DELL	E6430	N/A
B	Fixture	Azurewave	2460 I2	N/A
C	AP Router	ASUS	RP-N53	MSQ-RPN53
D	Earphone	SHYARO CHI	MIC-04	N/A
E	Mouse	HP	FM100	N/A
F	AP NB	DELL	E6430	N/A

For Radiated (below 1GHz):

Support Equipment				
No.	Equipment	Brand Name	Model Name	FCC ID
A	NB	Dell	V14-5490-R1528STW	N/A
B	Fixture	Azurewave	2460 I2	N/A
C	AP Router	ASUS	RP-N53	MSQ-RPN53
D	Earphone	SHYARO CHI	MIC-04	N/A
E	Mouse	HP	FM100	N/A
F	AP NB	DELL	E6430	N/A

For Radiated (above 1GHz) and RF Conducted:

Support Equipment				
No.	Equipment	Brand Name	Model Name	FCC ID
A	NB	DELL	E4300	N/A
B	NB	DELL	E4300	N/A
C	Fixture	Azurewave	CB162NF	N/A
D	Fixture	Azurewave	2458SM I2	N/A

2.6 Test Setup Diagram

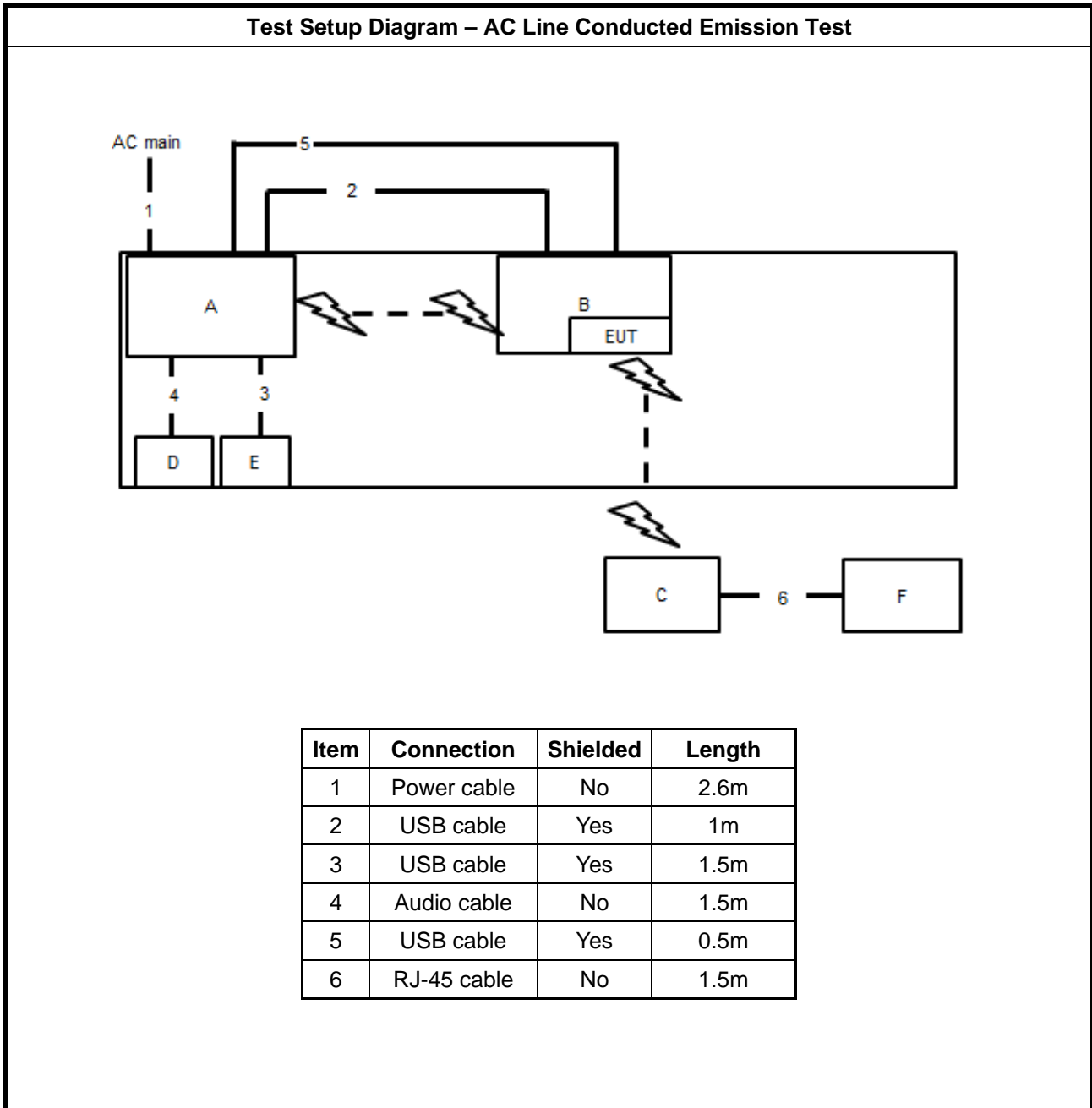

Test Setup Diagram - Radiated Test < 1GHz

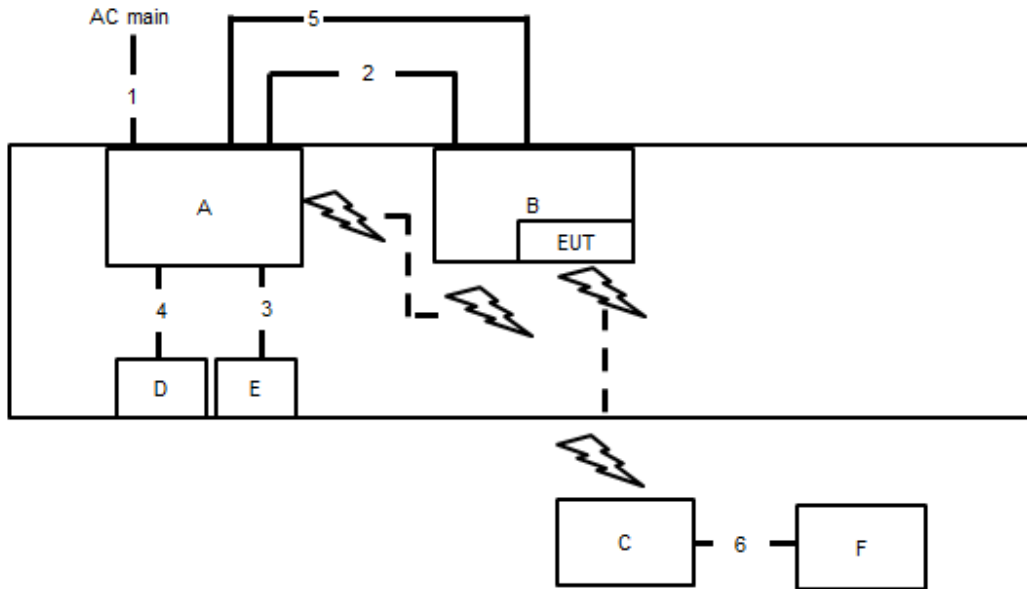

Item	Connection	Shielded	Length
1	Power cable	No	2.6m
2	USB cable	Yes	1m
3	USB cable	Yes	1.5m
4	Audio cable	No	1.5m
5	USB cable	Yes	0.5m
6	RJ-45 cable	No	1.5m

Test Setup Diagram - Radiated Test > 1GHz

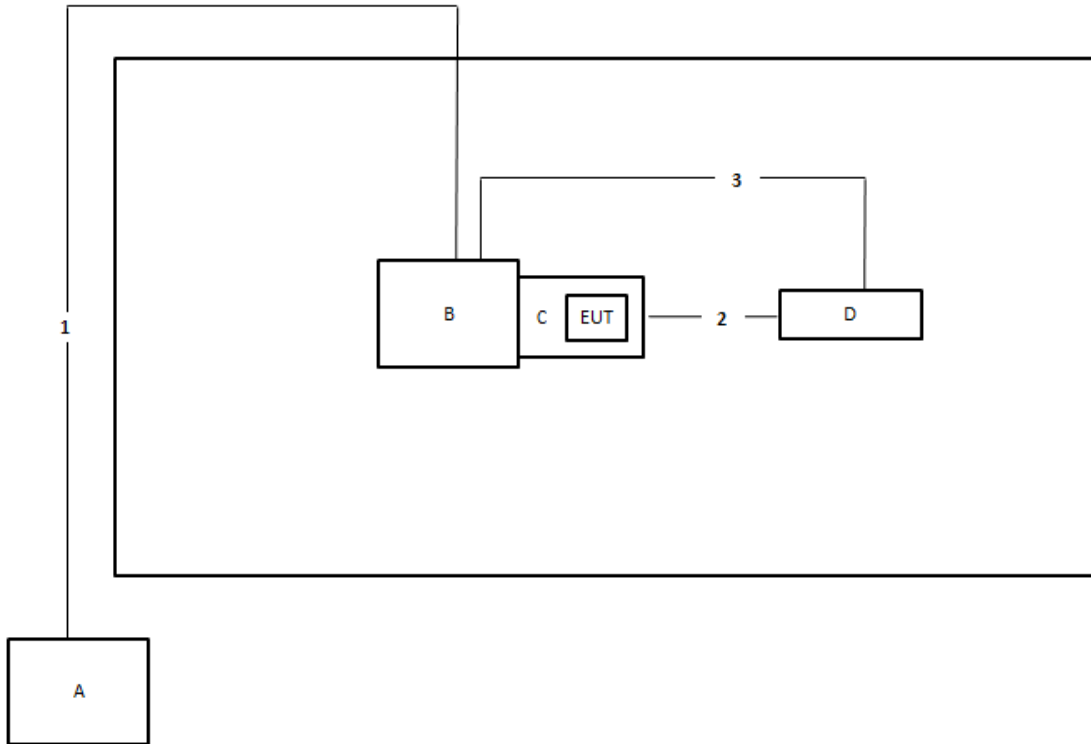

Item	Connection	Shielded	Length
1	RJ-45 cable	No	10m
2	Console cable	No	0.18m
3	USB cable	No	1.2m



3 Transmitter Test Result

3.1 AC Power-line Conducted Emissions

3.1.1 AC Power-line Conducted Emissions Limit

AC Power-line Conducted Emissions Limit		
Frequency Emission (MHz)	Quasi-Peak	Average
0.15-0.5	66 - 56 *	56 - 46 *
0.5-5	56	46
5-30	60	50

Note 1: * Decreases with the logarithm of the frequency.

3.1.2 Measuring Instruments

Refer a test equipment and calibration data table in this test report.

3.1.3 Test Procedures

Test Method
▪ Refer as ANSI C63.10-2013, clause 6.2 for AC power-line conducted emissions.

3.1.4 Test Setup

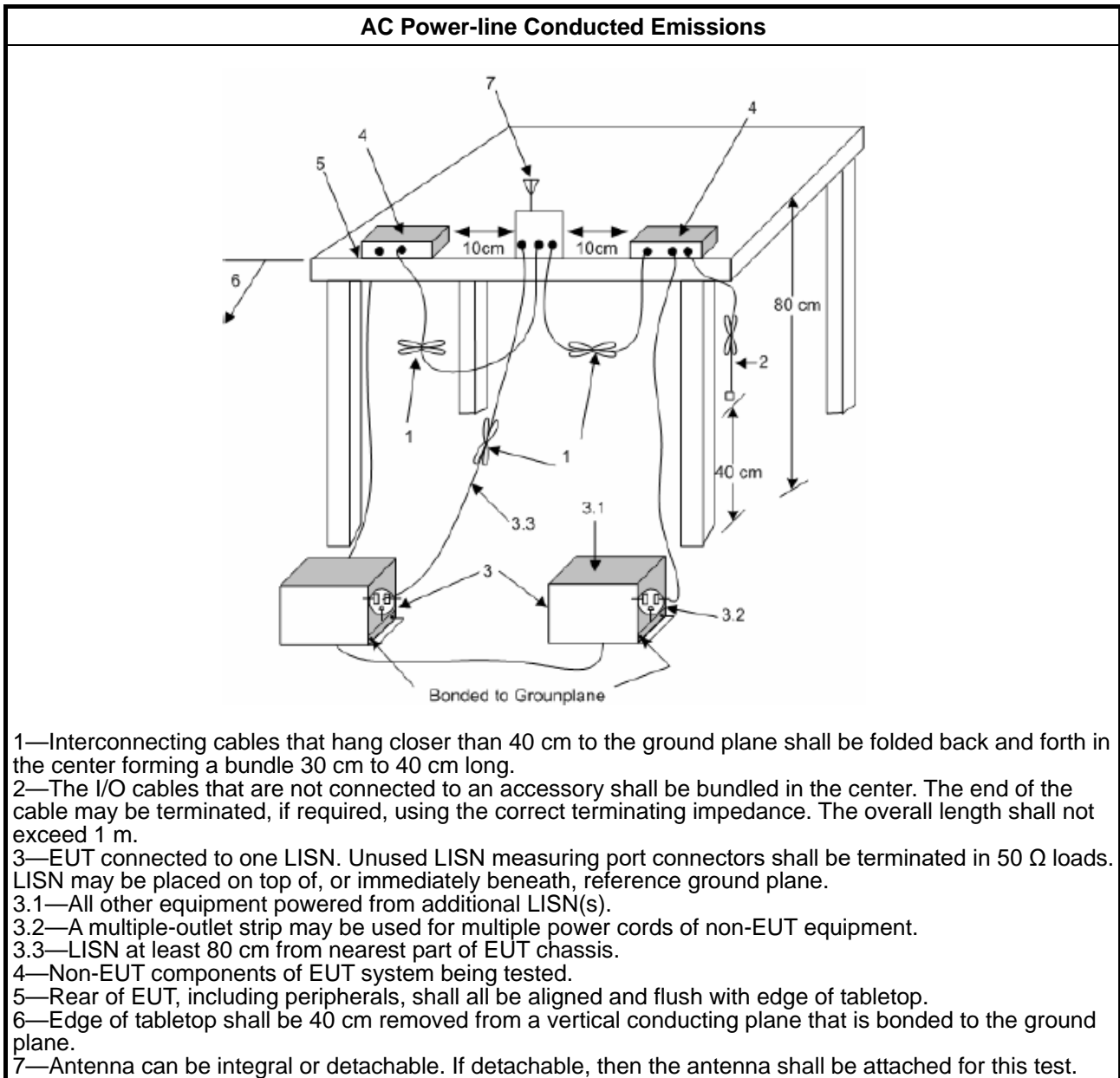

1.1.1. Measurement Results Calculation

The measured Level is calculated using:

- a. Corrected Reading: LISN Factor (LISN) + Attenuator (AT/AUX) + Cable Loss (CL) + Read Level (Raw) = Level
- b. Margin = -Limit + Level

3.1.5 Test Result of AC Power-line Conducted Emissions

Refer as Appendix A

3.2 DTS Bandwidth

3.2.1 6dB Bandwidth Limit

6dB Bandwidth Limit
Systems using digital modulation techniques:
<ul style="list-style-type: none"> ▪ 6 dB bandwidth \geq 500 kHz.

3.2.2 Measuring Instruments

Refer a test equipment and calibration data table in this test report.

3.2.3 Test Procedures

Test Method
<ul style="list-style-type: none"> ▪ For the emission bandwidth shall be measured using one of the options below:
<input checked="" type="checkbox"/> Refer as FCC KDB 558074, clause 8.2 & C63.10 clause 11.8.1 Option 1 for 6 dB bandwidth measurement.
<input type="checkbox"/> Refer as FCC KDB 558074, clause 8.2 & C63.10 clause 11.8.2 Option 2 for 6 dB bandwidth measurement.
<input type="checkbox"/> Refer as ANSI C63.10, clause 6.9.1 for occupied bandwidth testing.

3.2.4 Test Setup

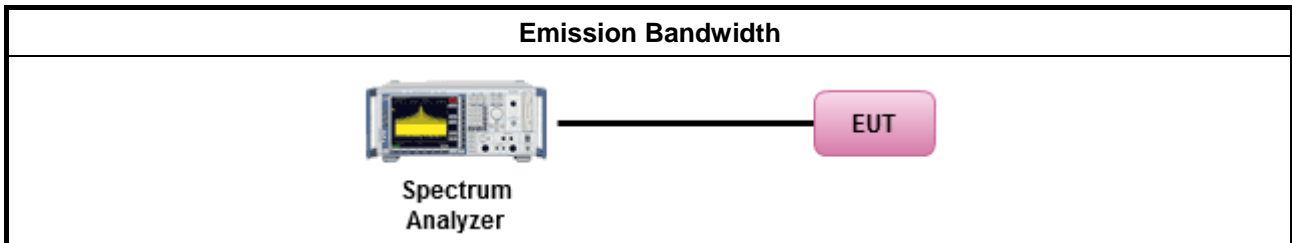

3.2.5 Test Result of Emission Bandwidth

Refer as Appendix B



3.3 Maximum Conducted Output Power

3.3.1 Maximum Conducted Output Power Limit

Maximum Conducted Output Power Limit	
	<ul style="list-style-type: none">▪ If $G_{TX} \leq 6$ dBi, then $P_{Out} \leq 30$ dBm (1 W)
	<ul style="list-style-type: none">▪ Point-to-multipoint systems (P2M): If $G_{TX} > 6$ dBi, then $P_{Out} = 30 - (G_{TX} - 6)$ dBm
	<ul style="list-style-type: none">▪ Point-to-point systems (P2P): If $G_{TX} > 6$ dBi, then $P_{Out} = 30 - (G_{TX} - 6)/3$ dBm
	<ul style="list-style-type: none">▪ Smart antenna system (SAS):
	<ul style="list-style-type: none">- Single beam: If $G_{TX} > 6$ dBi, then $P_{Out} = 30 - (G_{TX} - 6)/3$ dBm
	<ul style="list-style-type: none">- Overlap beam: If $G_{TX} > 6$ dBi, then $P_{Out} = 30 - (G_{TX} - 6)/3$ dBm
	<ul style="list-style-type: none">- Aggregate power on all beams: If $G_{TX} > 6$ dBi, then $P_{Out} = 30 - (G_{TX} - 6)/3 + 8$ dB dBm
P_{Out} = maximum peak conducted output power or maximum conducted output power in dBm, G_{TX} = the maximum transmitting antenna directional gain in dBi.	

3.3.2 Measuring Instruments

Refer a test equipment and calibration data table in this test report.

3.3.3 Test Procedures

Test Method	
<ul style="list-style-type: none"> ▪ Maximum Peak Conducted Output Power 	
	<input type="checkbox"/> Refer as FCC KDB 558074, clause 8.3.1.1 & C63.10 clause 11.9.1.1 (RBW ≥ EBW method).
	<input type="checkbox"/> Refer as FCC KDB 558074, clause 8.3.1.3 & C63.10 clause 11.9.1.3 (peak power meter).
<ul style="list-style-type: none"> ▪ Maximum Conducted Output Power 	
[duty cycle ≥ 98% or external video / power trigger]	
	<input type="checkbox"/> Refer as FCC KDB 558074, clause 8.3.2.2 & C63.10 clause 11.9.2.2.2 Method AVGSA-1.
	<input type="checkbox"/> Refer as FCC KDB 558074, clause 8.3.2.2 & C63.10 clause 11.9.2.2.3 Method AVGSA-1A. (alternative)
duty cycle < 98% and average over on/off periods with duty factor	
	<input type="checkbox"/> Refer as FCC KDB 558074, clause 8.3.2.2 & C63.10 clause 11.9.2.2.4 Method AVGSA-2.
	<input type="checkbox"/> Refer as FCC KDB 558074, clause 8.3.2.2 & C63.10 clause 11.9.2.2.5 Method AVGSA-2A (alternative)
	<input type="checkbox"/> Refer as FCC KDB 558074, clause 8.3.2.2 & C63.10 clause 11.9.2.2.6 Method AVGSA-3
	<input type="checkbox"/> Refer as FCC KDB 558074, clause 8.3.2.2 & C63.10 clause 11.9.2.2.7 Method AVGSA-3A (alternative)
Measurement using a power meter (PM)	
	<input type="checkbox"/> Refer as FCC KDB 558074, clause 8.3.2.3 & C63.10 clause 11.9.2.3.1 Method AVGPM (using an RF average power meter).
	<input checked="" type="checkbox"/> Refer as FCC KDB 558074, clause 8.3.2.3 & C63.10 clause 11.9.2.3.2 Method AVGPM-G (using an gate RF average power meter).
<ul style="list-style-type: none"> ▪ For conducted measurement. 	
<ul style="list-style-type: none"> ▪ If the EUT supports multiple transmit chains using options given below: Refer as FCC KDB 662911, In-band power measurements. Using the measure-and-sum approach, measured all transmit ports individually. Sum the power (in linear power units e.g., mW) of all ports for each individual sample and save them. 	
<ul style="list-style-type: none"> ▪ If multiple transmit chains, EIRP calculation could be following as methods: $P_{total} = P_1 + P_2 + \dots + P_n$ (calculated in linear unit [mW] and transfer to log unit [dBm]) $EIRP_{total} = P_{total} + DG$ 	

3.3.4 Test Setup

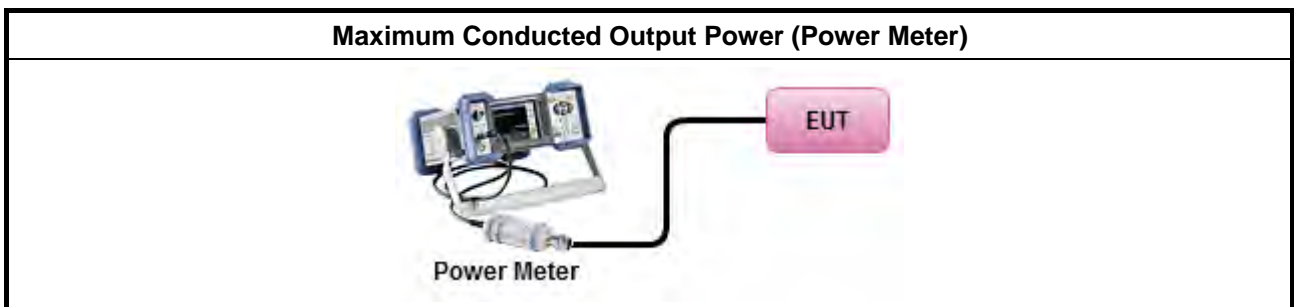



3.3.5 Test Result of Maximum Conducted Output Power

Refer as Appendix C



3.4 Power Spectral Density

3.4.1 Power Spectral Density Limit

Power Spectral Density Limit
<ul style="list-style-type: none"> Power Spectral Density (PSD) ≤ 8 dBm/3kHz

3.4.2 Measuring Instruments

Refer a test equipment and calibration data table in this test report.

3.4.3 Test Procedures

Test Method
<ul style="list-style-type: none"> Peak power spectral density procedures that the same method as used to determine the conducted output power. If maximum peak conducted output power was measured to demonstrate compliance to the output power limit, then the peak PSD procedure below (Method PKPSD) shall be used. If maximum conducted output power was measured to demonstrate compliance to the output power limit, then one of the average PSD procedures shall be used, as applicable based on the following criteria (the peak PSD procedure is also an acceptable option).
<input checked="" type="checkbox"/> Refer as FCC KDB 558074, clause 8.4 & C63.10 clause 11.10 Method Max. PSD. [duty cycle ≥ 98% or external video / power trigger]
<ul style="list-style-type: none"> For conducted measurement.
<ul style="list-style-type: none"> If The EUT supports multiple transmit chains using options given below: <ul style="list-style-type: none"> <input type="checkbox"/> Option 1: Measure and sum the spectra across the outputs. Refer as FCC KDB 662911, In-band power spectral density (PSD). Sample all transmit ports simultaneously using a spectrum analyzer for each transmit port. Where the trace bin-by-bin of each transmit port summing can be performed. (i.e., in the first spectral bin of output 1 is summed with that in the first spectral bin of output 2 and that from the first spectral bin of output 3, and so on up to the NTX output to obtain the value for the first frequency bin of the summed spectrum.). Add up the amplitude (power) values for the different transmit chains and use this as the new data trace. <input type="checkbox"/> Option 2: Measure and sum spectral maxima across the outputs. With this technique, spectra are measured at each output of the device at the required resolution bandwidth. The maximum value (peak) of each spectrum is determined. These maximum values are then summed mathematically in linear power units across the outputs. These operations shall be performed separately over frequency spans that have different out-of-band or spurious emission limits, <input type="checkbox"/> Option 3: Measure and add 10 log(N) dB, where N is the number of transmit chains. Refer as FCC KDB 662911, In-band power spectral density (PSD). Performed at each transmit chains and each transmit chains shall be compared with the limit have been reduced with 10 log(N). Or each transmit chains shall be add 10 log(N) to compared with the limit.

3.4.4 Test Setup

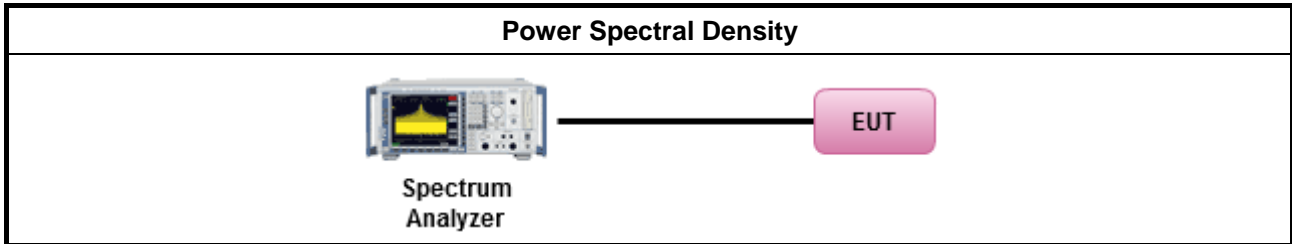

3.4.5 Test Result of Power Spectral Density

Refer as Appendix D

3.5 Emissions in Non-restricted Frequency Bands

3.5.1 Emissions in Non-restricted Frequency Bands Limit

Un-restricted Band Emissions Limit	
RF output power procedure	Limit (dBc)
Peak output power procedure	20
Average output power procedure	30

Note 1: If the peak output power procedure is used to measure the fundamental emission power to demonstrate compliance to requirements, then the peak conducted output power measured within any 100 kHz outside the authorized frequency band shall be attenuated by at least 20 dB relative to the maximum measured in-band peak PSD level.

Note 2: If the average output power procedure is used to measure the fundamental emission power to demonstrate compliance to requirements, then the power in any 100 kHz outside of the authorized frequency band shall be attenuated by at least 30 dB relative to the maximum measured in-band average PSD level.

3.5.2 Measuring Instruments

Refer a test equipment and calibration data table in this test report.

3.5.3 Test Procedures

Test Method
<ul style="list-style-type: none"> Refer as FCC KDB 558074, clause 8.5 for unwanted emissions into non-restricted bands.

3.5.4 Test Setup

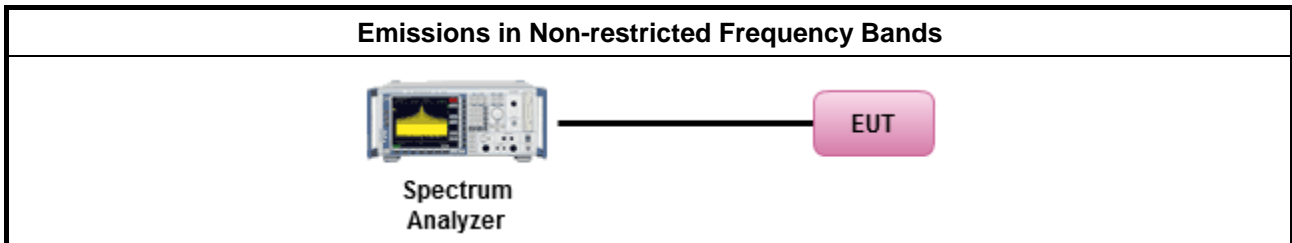

3.5.5 Test Result of Emissions in Non-restricted Frequency Bands

Refer as Appendix E



3.6 Emissions in Restricted Frequency Bands

3.6.1 Emissions in Restricted Frequency Bands Limit

Restricted Band Emissions Limit			
Frequency Range (MHz)	Field Strength (uV/m)	Field Strength (dBuV/m)	Measure Distance (m)
0.009~0.490	2400/F(kHz)	48.5 - 13.8	300
0.490~1.705	24000/F(kHz)	33.8 - 23	30
1.705~30.0	30	29	30
30~88	100	40	3
88~216	150	43.5	3
216~960	200	46	3
Above 960	500	54	3

Note 1: Test distance for frequencies at or above 30 MHz, measurements may be performed at a distance other than the limit distance provided they are not performed in the near field and the emissions to be measured can be detected by the measurement equipment. When performing measurements at a distance other than that specified, the results shall be extrapolated to the specified distance using an extrapolation factor of 20 dB/decade (inverse of linear distance for field-strength measurements, inverse of linear distance-squared for power-density measurements).

Note 2: Test distance for frequencies at below 30 MHz, measurements may be performed at a distance closer than the EUT limit distance; however, an attempt should be made to avoid making measurements in the near field. When performing measurements below 30 MHz at a closer distance than the limit distance, the results shall be extrapolated to the specified distance by either making measurements at a minimum of two or more distances on at least one radial to determine the proper extrapolation factor or by using the square of an inverse linear distance extrapolation factor (40 dB / decade). The test report shall specify the extrapolation method used to determine compliance of the EUT.

Note 3: Using the distance of 1m during the test for above 18 GHz, and the test value to correct for the distance factor at 3m.

3.6.2 Measuring Instruments

Refer a test equipment and calibration data table in this test report.



3.6.3 Test Procedures

Test Method	
<ul style="list-style-type: none"> ▪ The average emission levels shall be measured in [duty cycle \geq 98 or duty factor]. 	
<ul style="list-style-type: none"> ▪ Refer as ANSI C63.10, clause 6.10.3 band-edge testing shall be performed at the lowest frequency channel and highest frequency channel within the allowed operating band. 	
<ul style="list-style-type: none"> ▪ For the transmitter unwanted emissions shall be measured using following options below: 	
	<ul style="list-style-type: none"> ▪ Refer as FCC KDB 558074, clause 8.6 for unwanted emissions into restricted bands.
	<input type="checkbox"/> Refer as FCC KDB 558074, clause 8.6 & C63.10 clause 11.12.2.5.1(trace averaging for duty cycle \geq 98%).
	<input type="checkbox"/> Refer as FCC KDB 558074, clause 8.6 & C63.10 clause 11.12.2.5.2(trace averaging + duty factor).
	<input checked="" type="checkbox"/> Refer as FCC KDB 558074, clause 8.6 & C63.10 clause 11.12.2.5.3(Reduced VBW \geq 1/T).
	<input type="checkbox"/> Refer as ANSI C63.10, clause 11.12.2.5.3 (Reduced VBW). VBW \geq 1/T, where T is pulse time.
	<input type="checkbox"/> Refer as ANSI C63.10, clause 7.5 average value of pulsed emissions.
	<input checked="" type="checkbox"/> Refer as FCC KDB 558074, clause 8.6 & C63.10 clause 11.12.2.4 measurement procedure peak limit.
<ul style="list-style-type: none"> ▪ For the transmitter band-edge emissions shall be measured using following options below: 	
	<ul style="list-style-type: none"> ▪ Refer as FCC KDB 558074 clause 8.7 & c63.10 clause 11.13.1, When the performing peak or average radiated measurements, emissions within 2 MHz of the authorized band edge may be measured using the marker-delta method described below.
	<ul style="list-style-type: none"> ▪ Refer as FCC KDB 558074, clause 8.7 (ANSI C63.10, clause 6.10.6) for marker-delta method for band-edge measurements.
	<ul style="list-style-type: none"> ▪ Refer as FCC KDB 558074, clause 8.7 for narrower resolution bandwidth (100kHz) using the band power and summing the spectral levels (i.e., 1 MHz).
	<ul style="list-style-type: none"> ▪ For conducted unwanted emissions into restricted bands (absolute emission limits). Devices with multiple transmit chains using options given below: (1) Measure and sum the spectra across the outputs or (2) Measure and add 10 log(N) dB
	<ul style="list-style-type: none"> ▪ For FCC KDB 662911 The methodology described here may overestimate array gain, thereby resulting in apparent failures to satisfy the out-of-band limits even if the device is actually compliant. In such cases, compliance may be demonstrated by performing radiated tests around the frequencies at which the apparent failures occurred.

3.6.4 Test Setup

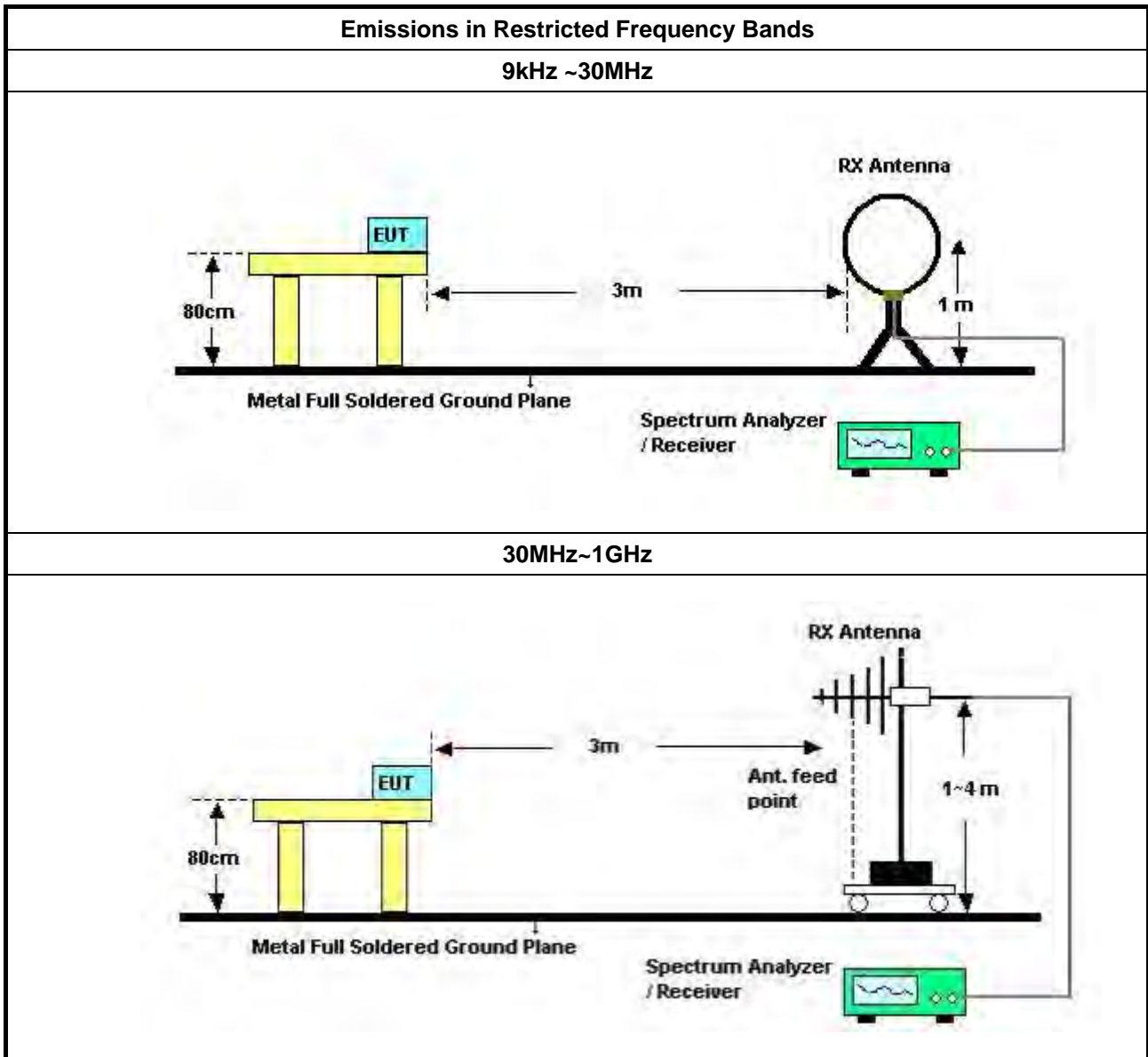

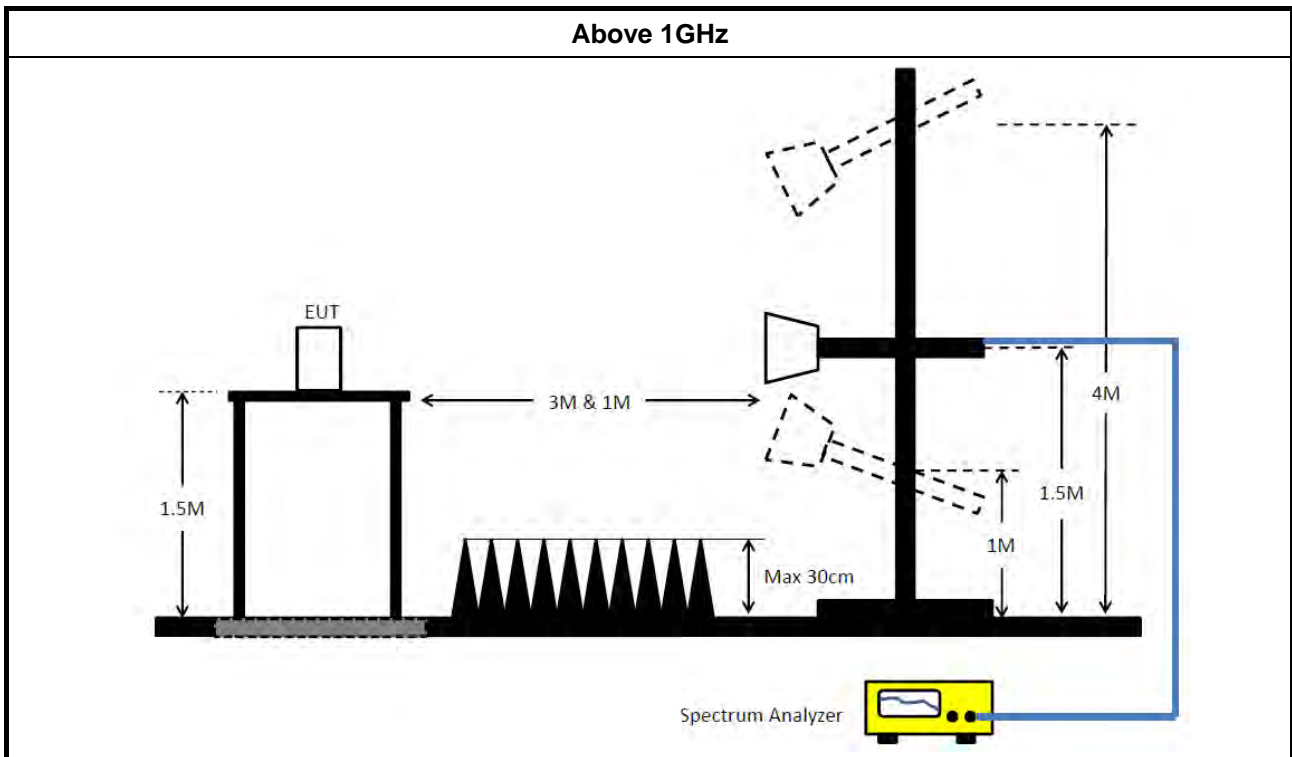

3.6.5 Measurement Results Calculation

The measured Level is calculated using:

Corrected Reading: Antenna factor (AF) + Cable loss (CL) + Read level (Raw) - Preamp factor (PA)(if applicable) = Level.

3.6.6 Emissions in Restricted Frequency Bands (Below 30MHz)

There is a comparison data of both open-field test site and alternative test site - semi-Anechoic chamber according to KDB414788 Radiated Test Site, and the result came out very similar.

All amplitude of spurious emissions that are attenuated by more than 20 dB below the permissible value has no need to be reported.

The radiated emissions were investigated from 9 kHz or the lowest frequency generated within the device, up to the 10th harmonic or 40 GHz, whichever is appropriate.

3.6.7 Test Result of Emissions in Restricted Frequency Bands

Refer as Appendix F



4 Test Equipment and Calibration Data

Instrument	Brand	Model No.	Serial No.	Characteristics	Calibration Date	Calibration Due Date	Remark
EMI Receiver	Agilent	N9038A	My52260123	9kHz ~ 8.4GHz	Mar. 03, 2021	Mar. 02, 2022	Conduction (CO01-CB)
LISN	F.C.C.	FCC-LISN-50-16-2	04083	150kHz ~ 100MHz	Jan. 06, 2021	Jan. 05, 2022	Conduction (CO01-CB)
LISN	Schwarzbeck	NSLK 8127	8127647	9kHz ~ 30MHz	Mar. 07, 2021	Mar. 06, 2022	Conduction (CO01-CB)
COND Cable	Woken	Cable	Low cable-CO01	9kHz ~ 30MHz	May 19, 2021	May 18, 2022	Conduction (CO01-CB)
Pulse Limiter	Rohde&Schwarz	ESH3-Z2	100430	9kHz ~ 30MHz	Jan. 30, 2021	Jan. 29, 2022	Conduction (CO01-CB)
Software	SPORTON	SENSE	V5.10	-	N.C.R.	N.C.R.	Conduction (CO01-CB)
Loop Antenna	Teseq	HLA 6120	24155	9kHz - 30 MHz	Apr. 14, 2021	Apr. 13, 2022	Radiation (10CH01-CB)
10m Semi Anechoic Chamber NSA	TDK	SAC-10M	10CH01-CB	30MHz~1GHz 10m,3m	Jan. 28, 2021	Jan. 27, 2022	Radiation (10CH01-CB)
Pre-Amplifier	Agilent	8447D	2944A10783	9kHz ~ 1.3GHz	Mar. 11, 2021	Mar. 10, 2022	Radiation (10CH01-CB)
Pre-Amplifier	Agilent	8447D	2944A10784	9kHz ~ 1.3GHz	Mar. 11, 2021	Mar. 10, 2022	Radiation (10CH01-CB)
Low Cable	Woken	SUCOFLEX 104	low cable-01	25MHz ~ 1GHz	Oct. 20, 2020	Oct. 19, 2021	Radiation (10CH01-CB)
High Cable	Woken	SUCOFLEX 104	low cable-02	25MHz ~ 1GHz	Oct. 20, 2020	Oct. 19, 2021	Radiation (10CH01-CB)
Bilog Antenna with 6dB Attenuator	Chase & EMCI	CBL6111A &N-6-06	1543 &AT-N0609	30MHz ~ 1GHz	Jul. 01, 2021	Jun. 30, 2022	Radiation (10CH01-CB)
EMI Receiver	Agilent	N9038A	MY52260140	9kHz ~ 8.4GHz	May 05, 2021	May 04, 2022	Radiation (10CH01-CB)
Software	SPORTON	SENSE	V5.10	-	N.C.R.	N.C.R.	Radiation (10CH01-CB)
3m Semi Anechoic Chamber VSWR	TDK	SAC-3M	03CH01-CB	1GHz ~18GHz 3m	May 07, 2021	May 06, 2022	Radiation (03CH01-CB)
Horn Antenna	ETS-LINDGREN	3115	00075790	750MHz ~ 18GHz	Nov. 06, 2020	Nov. 05, 2021	Radiation (03CH01-CB)
Horn Antenna	Schwarzbeck	BBHA 9170	BBHA9170252	15GHz ~ 40GHz	Jul. 21, 2020	Jul. 20, 2021	Radiation (03CH01-CB)
Pre-Amplifier	Agilent	8449B	3008A02310	1GHz ~ 26.5GHz	Jan. 07, 2021	Jan. 06, 2022	Radiation (03CH01-CB)
Pre-Amplifier	MITEQ	TTA1840-35-HG	1864479	18GHz ~ 40GHz	Jul. 08, 2020	Jul. 07, 2021	Radiation (03CH01-CB)
Spectrum Analyzer	R&S	FSP40	100056	9kHz ~ 40GHz	May 03, 2021	May 02, 2022	Radiation (03CH01-CB)



Instrument	Brand	Model No.	Serial No.	Characteristics	Calibration Date	Calibration Due Date	Remark
RF Cable-high	Woken	RG402	High Cable-16	1 GHz ~ 18 GHz	Oct. 05, 2020	Oct. 04, 2021	Radiation (03CH01-CB)
RF Cable-high	Woken	RG402	High Cable-16+17	1 GHz ~ 18 GHz	Oct. 05, 2020	Oct. 04, 2021	Radiation (03CH01-CB)
RF Cable-high	Woken	RG402	High Cable-40G#1	18GHz ~ 40 GHz	Jul. 16, 2020	Jul. 15, 2021	Radiation (03CH01-CB)
RF Cable-high	Woken	RG402	High Cable-40G#2	18GHz ~ 40 GHz	Jul. 16, 2020	Jul. 15, 2021	Radiation (03CH01-CB)
Test Software	SPORTON	SENSE	V5.10	-	N.C.R.	N.C.R.	Radiation (03CH01-CB)
Spectrum analyzer	R&S	FSV40	101028	9kHz~40GHz	Dec. 31, 2020	Dec. 30, 2021	Conducted (TH02-CB)
Power Sensor	Anritsu	MA2411B	1126203	300MHz~40GHz	Sep. 17, 2020	Sep. 16, 2021	Conducted (TH02-CB)
Power Meter	Anritsu	ML2495A	1210004	300MHz~40GHz	Sep. 17, 2020	Sep. 16, 2021	Conducted (TH02-CB)
RF Cable-high	Woken	RG402	High Cable-01	1 GHz – 18 GHz	Oct. 05, 2020	Oct. 04, 2021	Conducted (TH02-CB)
RF Cable-high	Woken	RG402	High Cable-02	1 GHz – 18 GHz	Oct. 05, 2020	Oct. 04, 2021	Conducted (TH02-CB)
RF Cable-high	Woken	RG402	High Cable-03	1 GHz – 18 GHz	Oct. 05, 2020	Oct. 04, 2021	Conducted (TH02-CB)
RF Cable-high	Woken	RG402	High Cable-04	1 GHz – 18 GHz	Oct. 05, 2020	Oct. 04, 2021	Conducted (TH02-CB)
RF Cable-high	Woken	RG402	High Cable-05	1 GHz – 18 GHz	Oct. 05, 2020	Oct. 04, 2021	Conducted (TH02-CB)
Test Software	SPORTON	SENSE	V5.10	-	N.C.R.	N.C.R.	Conducted (TH02-CB)

Note: Calibration Interval of instruments listed above is one year.

N.C.R. means Non-Calibration required.



Summary

Mode	Result	Type	Freq (Hz)	Level (dBuV)	Limit (dBuV)	Margin (dB)	Condition
Mode 1	Pass	AV	429k	34.14	47.28	-13.14	Neutral

Mode 1

24/09/2021

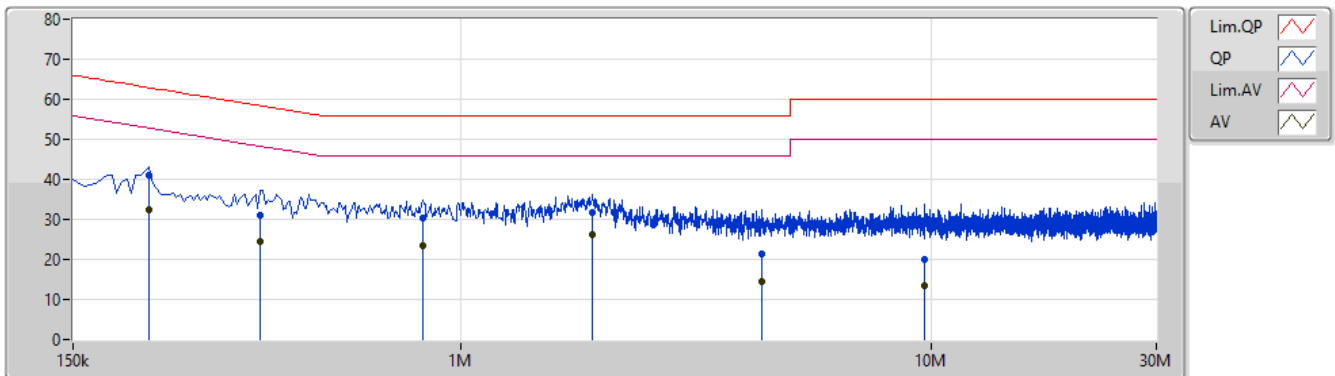

Type	Freq (Hz)	Level (dBuV)	Limit (dBuV)	Margin (dB)	Factor (dB)	Condition	Comment	Raw (dBuV)	LISN (dB)	CL (dB)	AT (dB)
QP	217.5k	40.98	62.92	-21.94	9.89	Line	-	31.09	0.04	0.04	9.81
AV	217.5k	32.51	52.92	-20.41	9.89	Line	-	22.62	0.04	0.04	9.81
QP	375k	30.97	58.39	-27.42	9.90	Line	-	21.07	0.04	0.04	9.82
AV	375k	24.56	48.39	-23.83	9.90	Line	-	14.66	0.04	0.04	9.82
QP	829.5k	30.19	56.00	-25.81	9.93	Line	-	20.26	0.06	0.04	9.83
AV	829.5k	23.58	46.00	-22.42	9.93	Line	-	13.65	0.06	0.04	9.83
QP	1.905M	31.71	56.00	-24.29	9.98	Line	-	21.73	0.09	0.07	9.82
AV	1.905M	26.05	46.00	-19.95	9.98	Line	"Worst"	16.07	0.09	0.07	9.82
QP	4.353M	21.33	56.00	-34.67	10.13	Line	-	11.20	0.14	0.12	9.87
AV	4.353M	14.38	46.00	-31.62	10.13	Line	-	4.25	0.14	0.12	9.87
QP	9.636M	19.92	60.00	-40.08	10.28	Line	-	9.64	0.22	0.16	9.90
AV	9.636M	13.31	50.00	-36.69	10.28	Line	-	3.03	0.22	0.16	9.90

Mode 1

24/09/2021

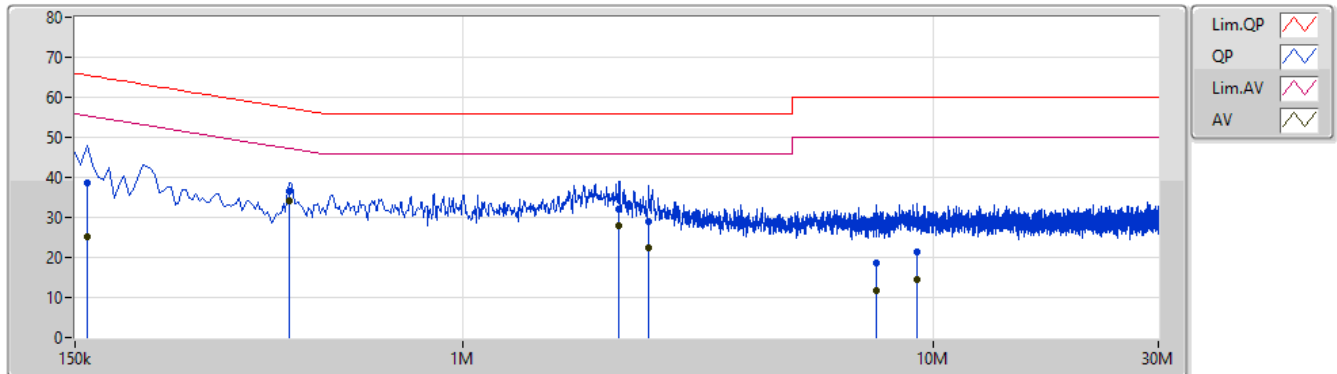

Type	Freq (Hz)	Level (dBuV)	Limit (dBuV)	Margin (dB)	Factor (dB)	Condition	Comment	Raw (dBuV)	LISN (dB)	CL (dB)	AT (dB)
QP	159k	38.57	65.52	-26.95	9.88	Neutral	-	28.69	0.03	0.04	9.81
AV	159k	25.06	55.52	-30.46	9.88	Neutral	-	15.18	0.03	0.04	9.81
QP	429k	36.49	57.28	-20.79	9.89	Neutral	-	26.60	0.03	0.04	9.82
AV	429k	34.14	47.28	-13.14	9.89	Neutral	"Worst"	24.25	0.03	0.04	9.82
QP	2.148M	32.21	56.00	-23.79	9.98	Neutral	-	22.23	0.07	0.08	9.83
AV	2.148M	27.85	46.00	-18.15	9.98	Neutral	-	17.87	0.07	0.08	9.83
QP	2.481M	29.06	56.00	-26.94	10.01	Neutral	-	19.05	0.08	0.09	9.84
AV	2.481M	22.43	46.00	-23.57	10.01	Neutral	-	12.42	0.08	0.09	9.84
QP	7.535M	18.72	60.00	-41.28	10.21	Neutral	-	8.51	0.17	0.15	9.89
AV	7.535M	11.79	50.00	-38.21	10.21	Neutral	-	1.58	0.17	0.15	9.89
QP	9.204M	21.25	60.00	-38.75	10.25	Neutral	-	11.00	0.19	0.16	9.90
AV	9.204M	14.40	50.00	-35.60	10.25	Neutral	-	4.15	0.19	0.16	9.90

Summary

Mode	Max-N dB (Hz)	Max-OBW (Hz)	ITU-Code	Min-N dB (Hz)	Min-OBW (Hz)
2.4-2.4835GHz	-	-	-	-	-
BT-LE(1Mbps)	701.25k	1.028M	1M03F1D	693.75k	1.027M
BT-LE(2Mbps)	1.155M	2.051M	2M05F1D	1.15M	2.041M

Max-N dB = Maximum 6dB down bandwidth; **Max-OBW** = Maximum 99% occupied bandwidth;
Min-N dB = Minimum 6dB down bandwidth; **Min-OBW** = Minimum 99% occupied bandwidth;

Result

Mode	Result	Limit (Hz)	Port 1-N dB (Hz)	Port 1-OBW (Hz)
BT-LE(1Mbps)	-	-	-	-
2402MHz	Pass	500k	701.25k	1.027M
2440MHz	Pass	500k	700k	1.028M
2480MHz	Pass	500k	693.75k	1.028M
BT-LE(2Mbps)	-	-	-	-
2402MHz	Pass	500k	1.15M	2.041M
2440MHz	Pass	500k	1.155M	2.041M
2480MHz	Pass	500k	1.155M	2.051M

Port X-N dB = Port X 6dB down bandwidth; **Port X-OBW** = Port X 99% occupied bandwidth;

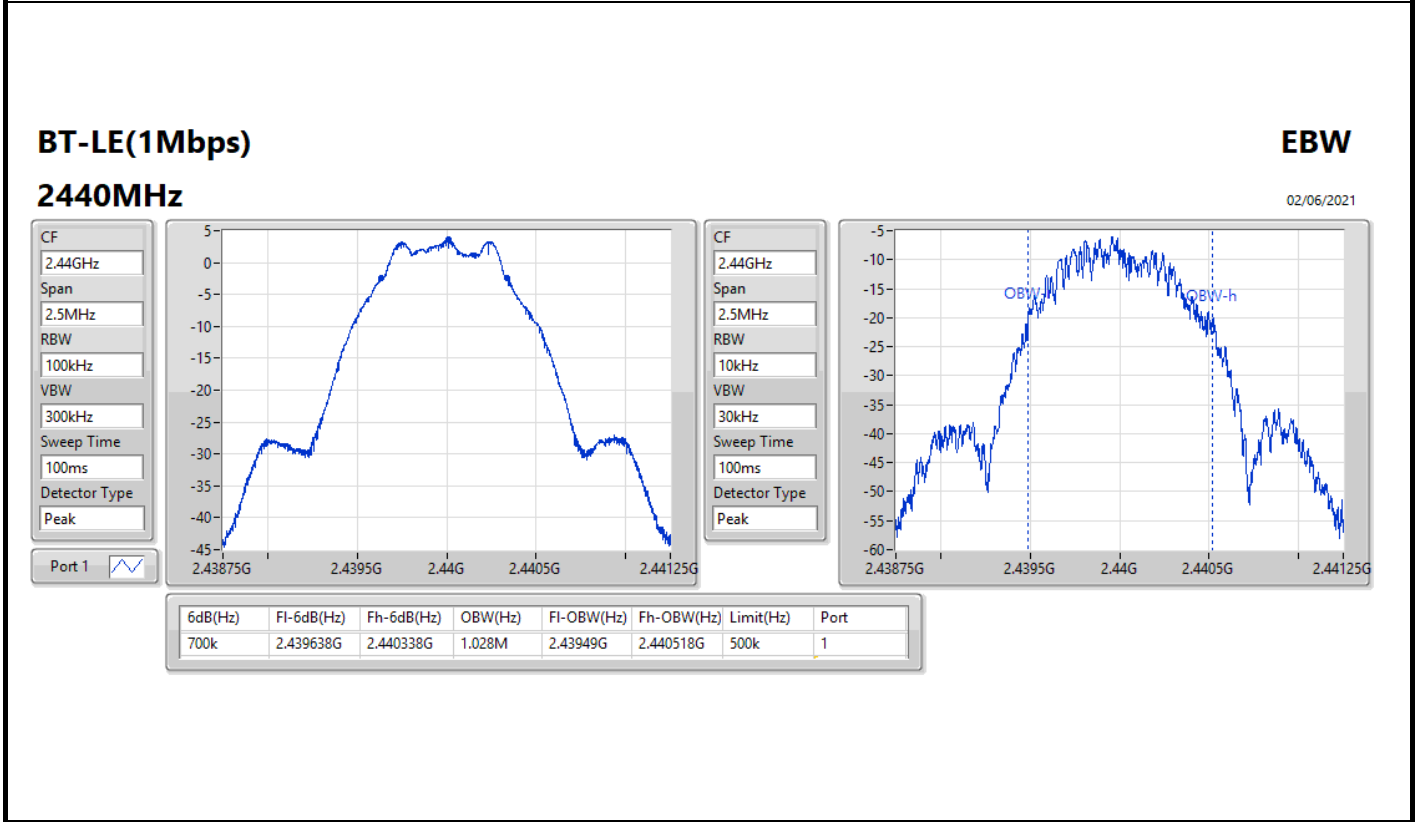
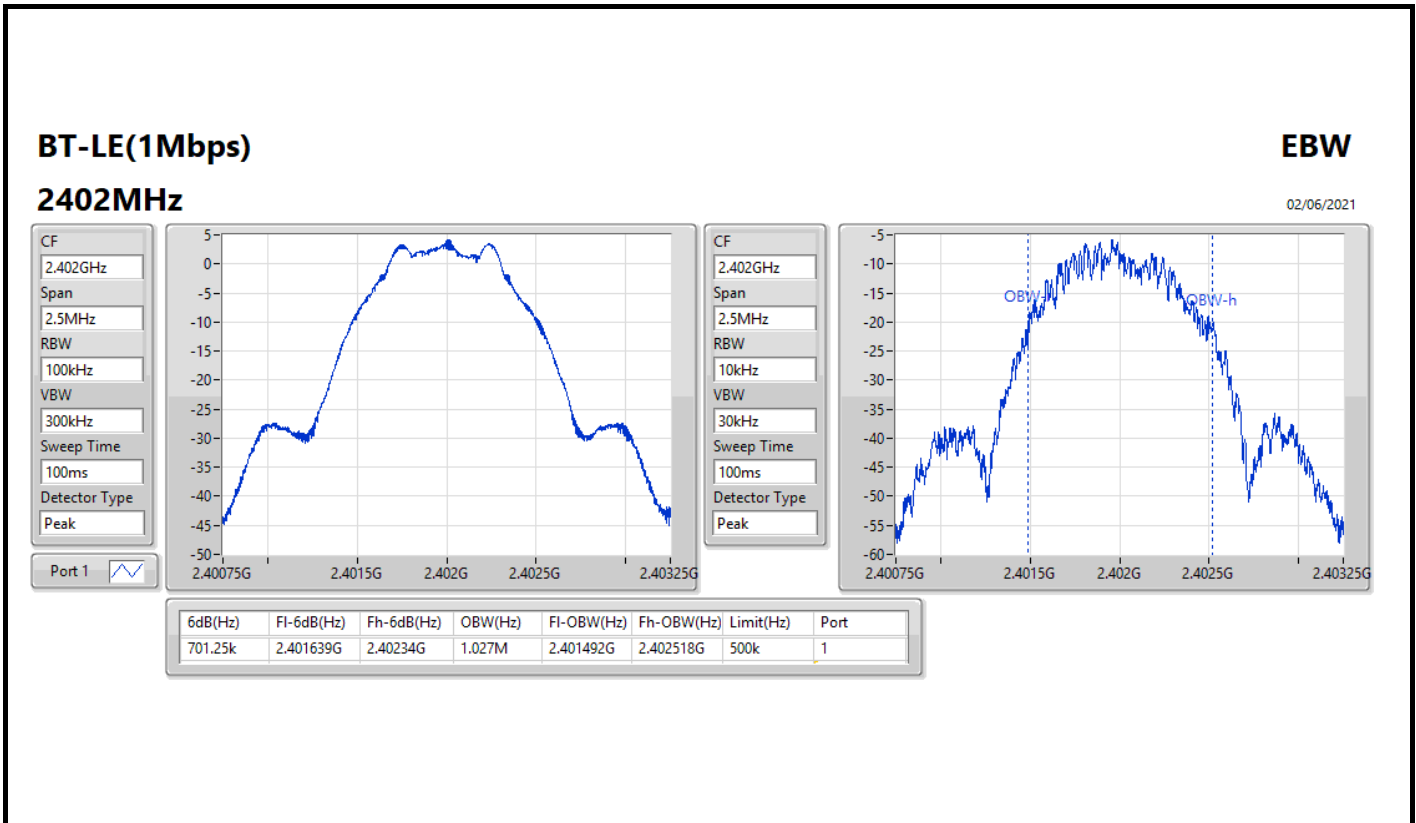

BT-LE(1Mbps)

EBW

2480MHz

02/06/2021

CF
2.48GHz
Span
2.5MHz
RBW
100kHz
VBW
300kHz
Sweep Time
100ms
Detector Type
Peak
Port 1

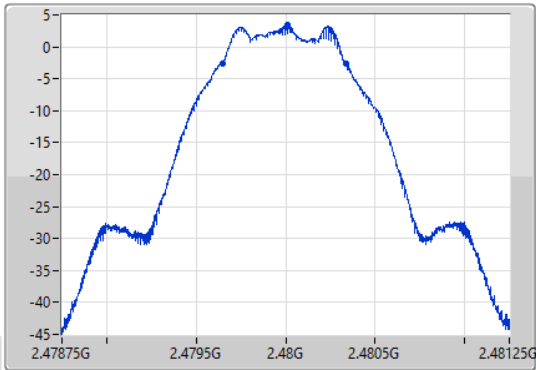

CF
2.48GHz
Span
2.5MHz
RBW
10kHz
VBW
30kHz
Sweep Time
100ms
Detector Type
Peak

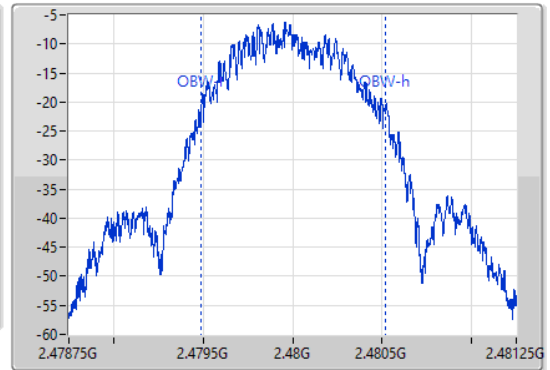

6dB(Hz)	Fl-6dB(Hz)	Fh-6dB(Hz)	OBW(Hz)	Fl-OBW(Hz)	Fh-OBW(Hz)	Limit(Hz)	Port
693.75k	2.479646G	2.48034G	1.028M	2.47949G	2.480518G	500k	1

BT-LE(2Mbps)

EBW

2402MHz

02/06/2021

CF
2.402GHz
Span
5MHz
RBW
100kHz
VBW
300kHz
Sweep Time
100ms
Detector Type
Peak
Port 1

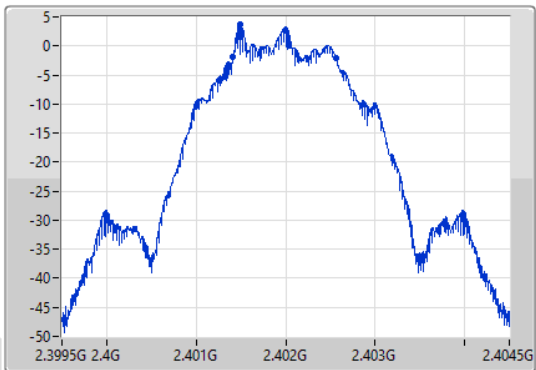

CF
2.402GHz
Span
5MHz
RBW
20kHz
VBW
100kHz
Sweep Time
100ms
Detector Type
Peak

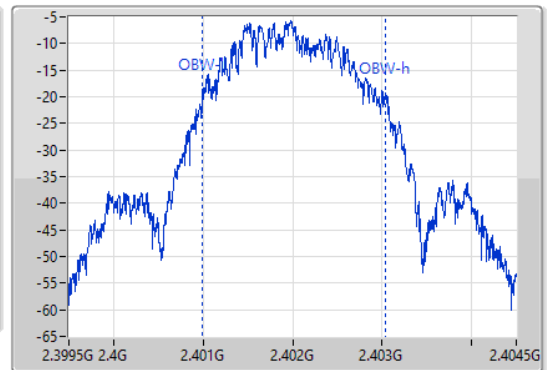

6dB(Hz)	Fl-6dB(Hz)	Fh-6dB(Hz)	OBW(Hz)	Fl-OBW(Hz)	Fh-OBW(Hz)	Limit(Hz)	Port
1.15M	2.401415G	2.402565G	2.041M	2.400996G	2.403037G	500k	1

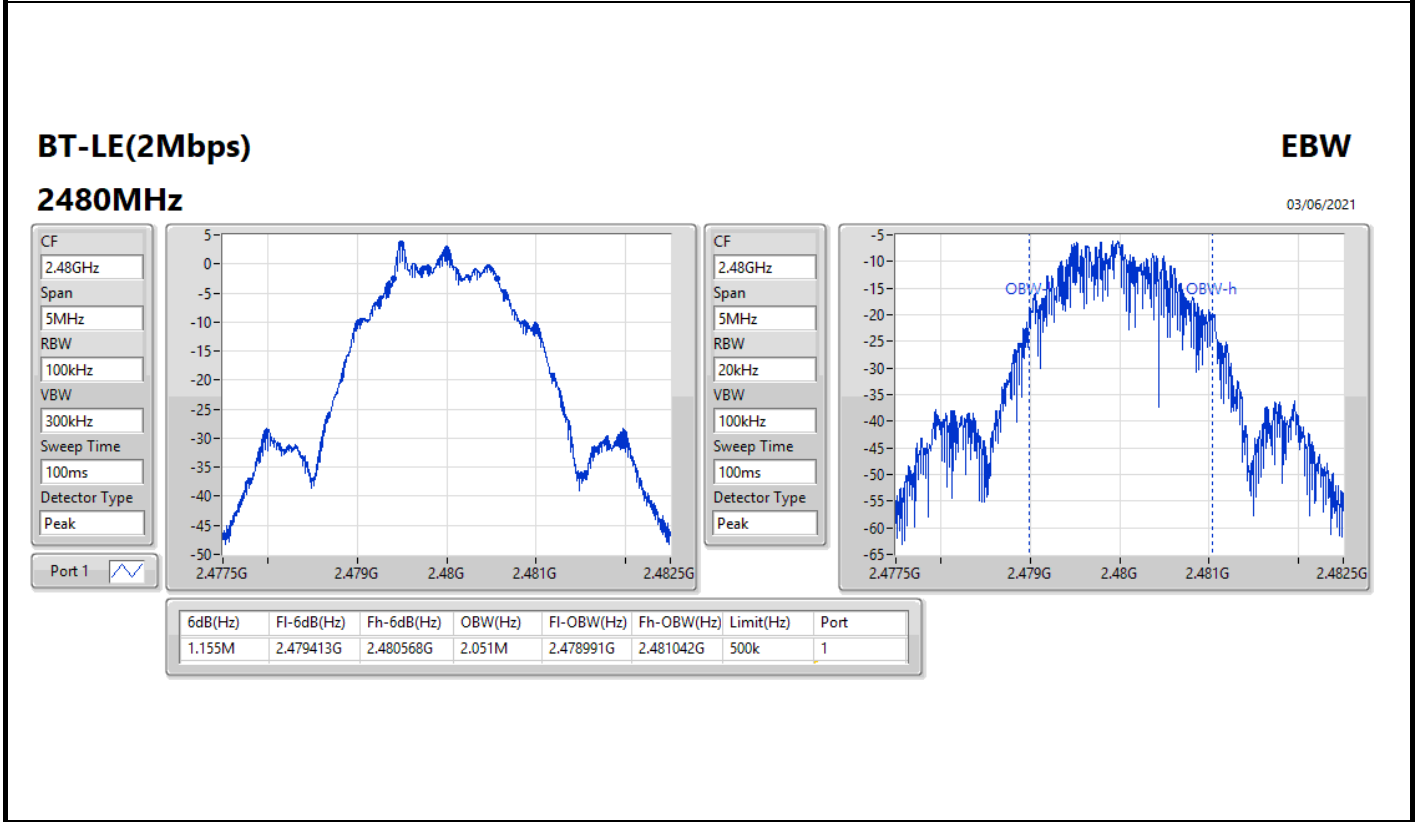
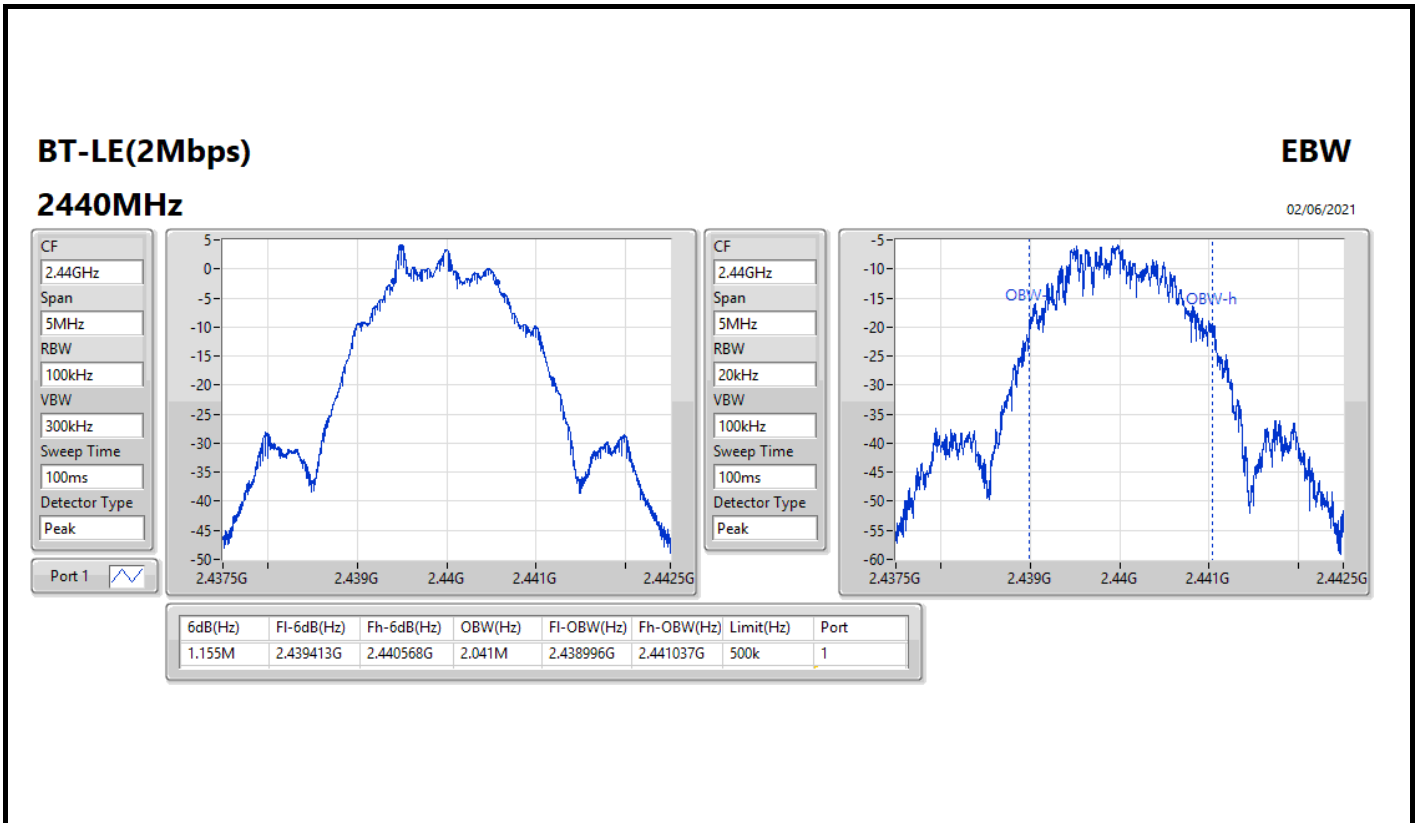



Summary

Mode	Power (dBm)	Power (W)
2.4-2.4835GHz	-	-
BT-LE(1Mbps)	3.66	0.00232
BT-LE(2Mbps)	3.39	0.00218



Result

Mode	Result	Gain (dBi)	Power (dBm)	Power Limit (dBm)
BT-LE(1Mbps)	-	-	-	-
2402MHz	Pass	2.98	3.66	30.00
2440MHz	Pass	2.98	3.21	30.00
2480MHz	Pass	2.98	3.01	30.00
BT-LE(2Mbps)	-	-	-	-
2402MHz	Pass	2.98	3.39	30.00
2440MHz	Pass	2.98	3.06	30.00
2480MHz	Pass	2.98	2.80	30.00

DG = Directional Gain; Port X = Port X output power



Summary

Mode	PD (dBm/RBW)
2.4-2.4835GHz	-
BT-LE(1Mbps)	-11.37
BT-LE(2Mbps)	-14.39

RBW=3 kHz.



Result

Mode	Result	Gain (dBi)	PD (dBm/RBW)	PD Limit (dBm/RBW)
BT-LE(1Mbps)	-	-	-	-
2402MHz	Pass	2.98	-11.37	8.00
2440MHz	Pass	2.98	-11.71	8.00
2480MHz	Pass	2.98	-12.15	8.00
BT-LE(2Mbps)	-	-	-	-
2402MHz	Pass	2.98	-14.39	8.00
2440MHz	Pass	2.98	-15.84	8.00
2480MHz	Pass	2.98	-15.28	8.00

DG = Directional Gain; RBW=3 kHz;

PD = trace bin-by-bin of each transmits port summing can be performed maximum power density; Port X = Port X power density;

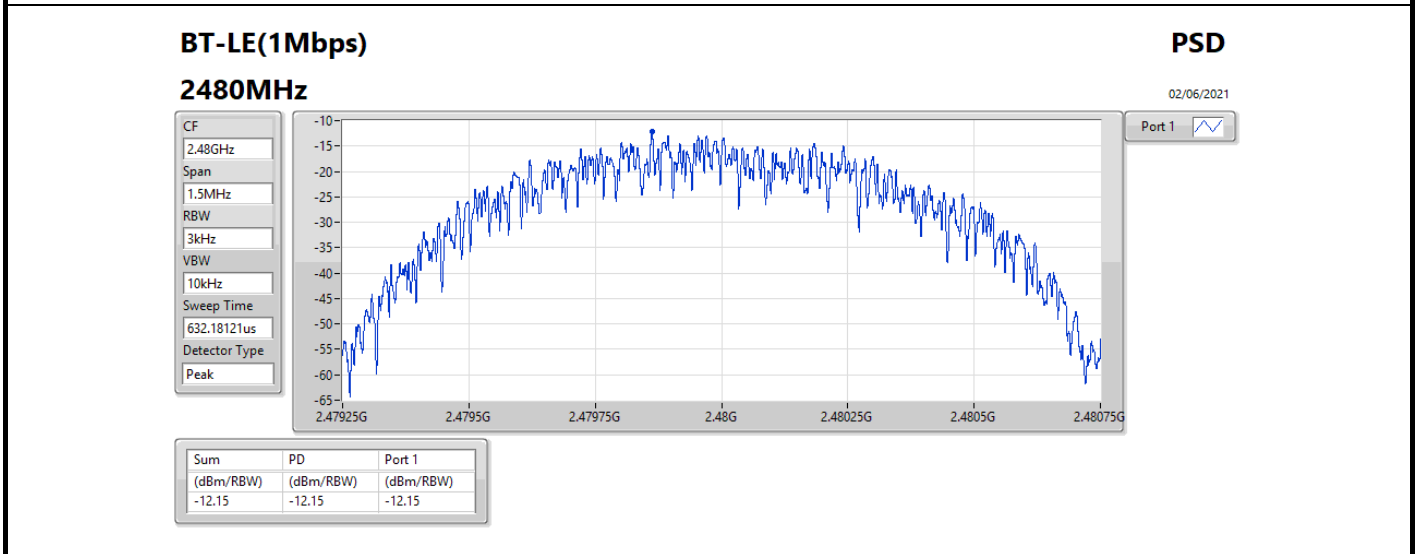
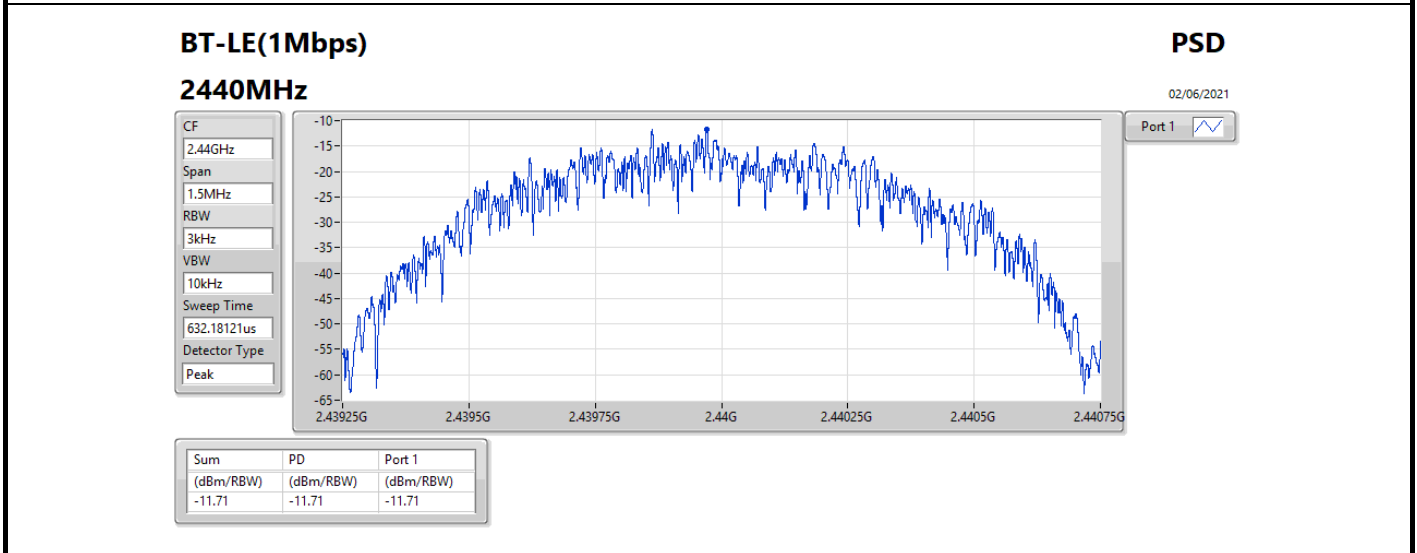
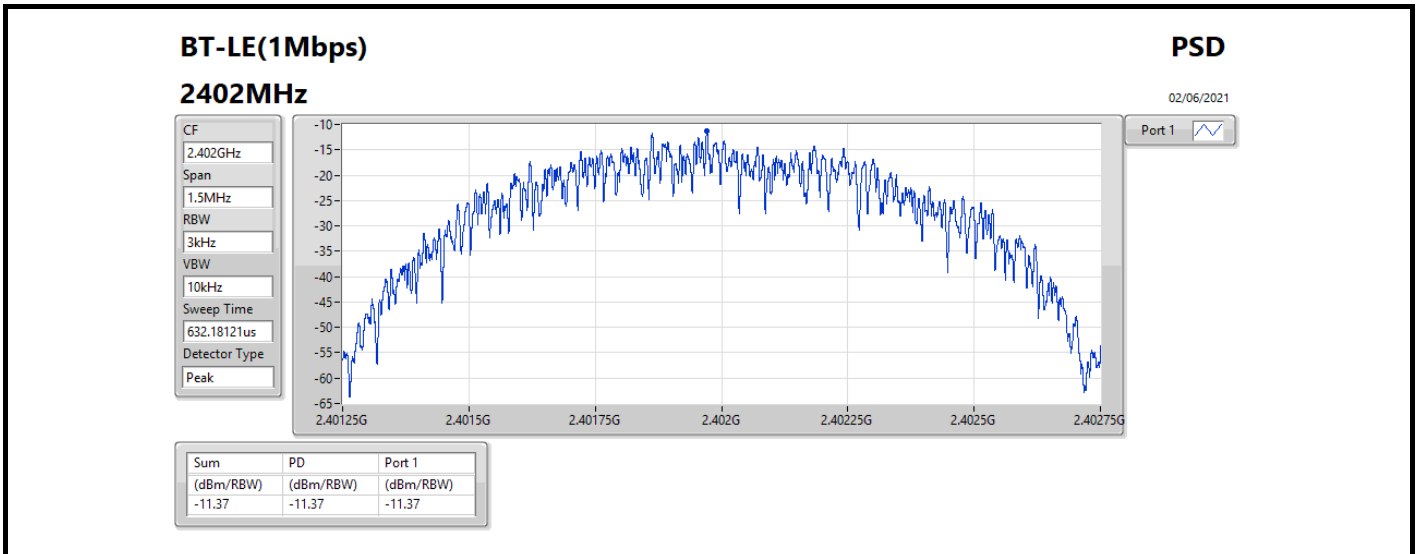

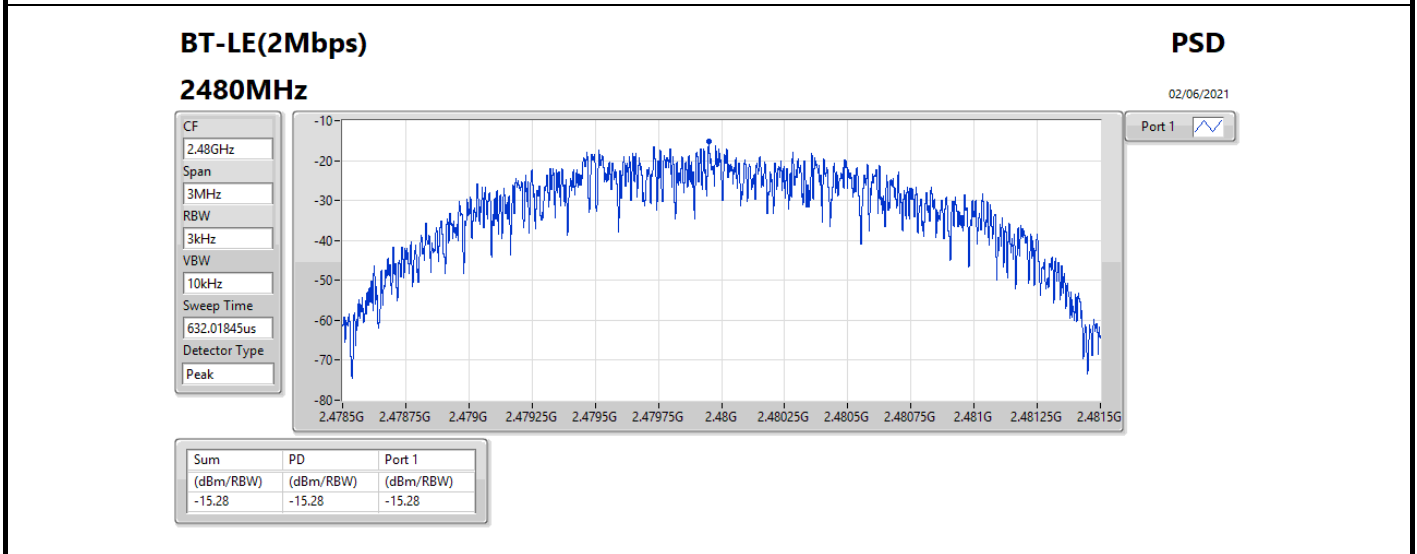
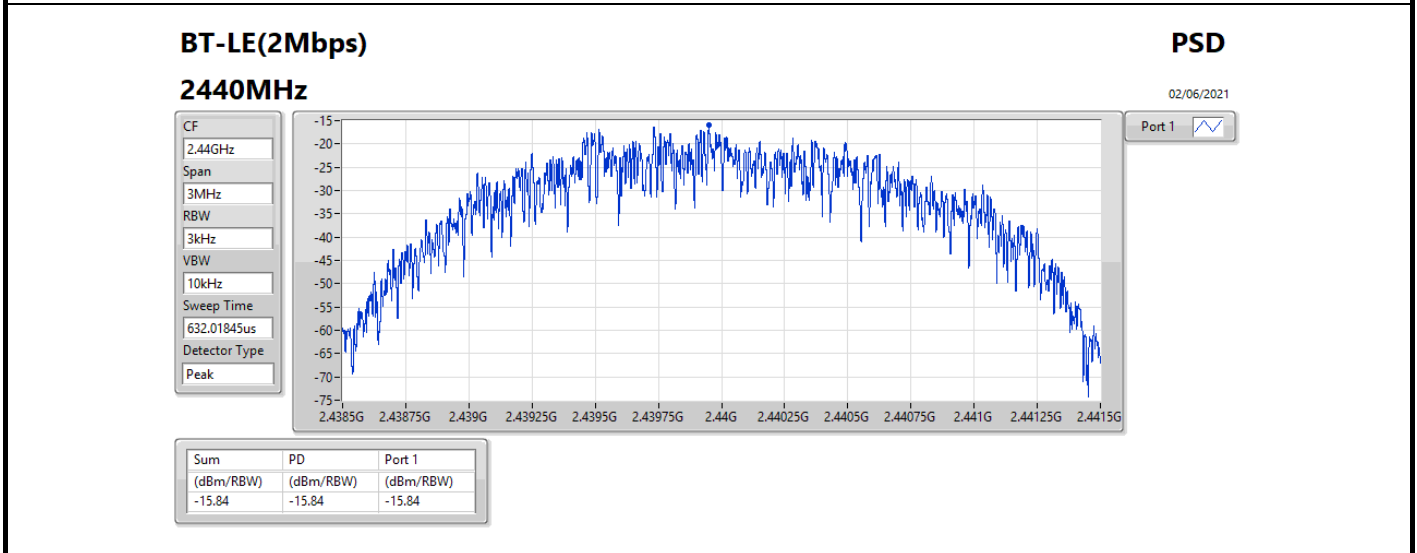
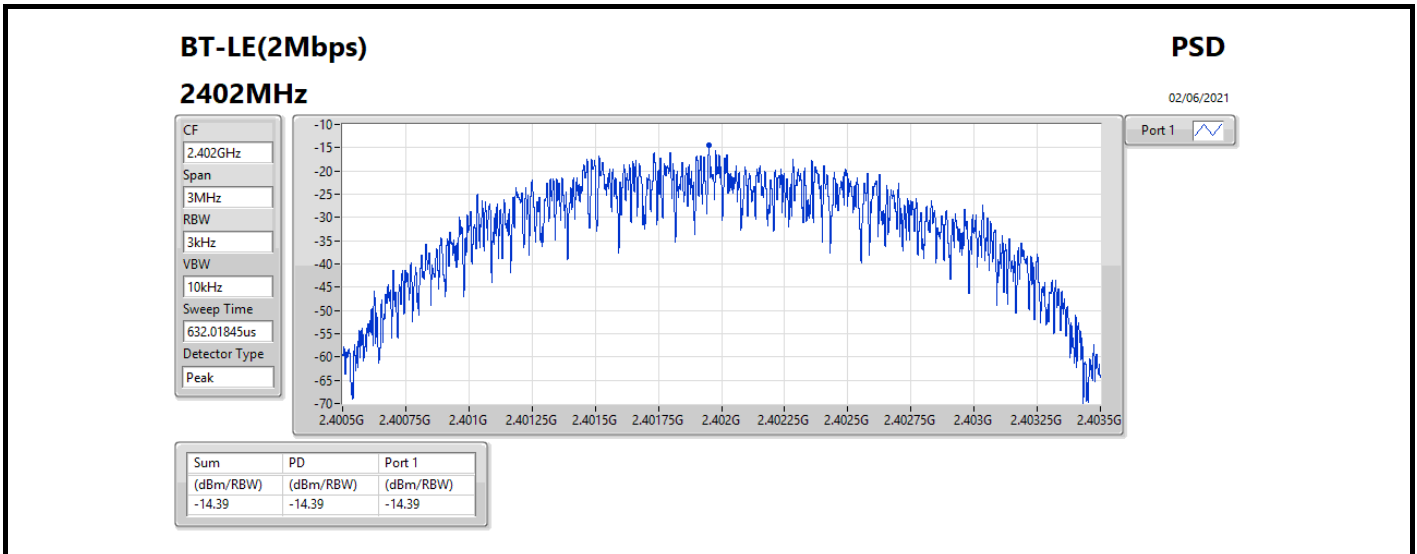



Summary

Mode	Result	Ref (Hz)	Ref (dBm)	Limit (dBm)	Freq (Hz)	Level (dBm)	Freq (Hz)	Level (dBm)	Freq (Hz)	Level (dBm)	Freq (Hz)	Level (dBm)	Freq (Hz)	Level (dBm)	Port
2.4-2.4835GHz	-	-	-	-	-	-	-	-	-	-	-	-	-	-	-
BT-LE(1Mbps)	Pass	2.40196G	3.40	-26.60	47.92M	-45.23	2.39976G	-48.84	2.4G	-53.02	2.48746G	-50.07	6.99718G	-45.56	1
BT-LE(2Mbps)	Pass	2.40146G	3.69	-26.31	47.92M	-44.97	2.4G	-28.52	2.4G	-29.45	2.48873G	-50.48	24.47696G	-44.59	1

Result

Mode	Result	Ref (Hz)	Ref (dBm)	Limit (dBm)	Freq (Hz)	Level (dBm)	Freq (Hz)	Level (dBm)	Freq (Hz)	Level (dBm)	Freq (Hz)	Level (dBm)	Freq (Hz)	Level (dBm)	Port
BT-LE(1Mbps)	-	-	-	-	-	-	-	-	-	-	-	-	-	-	-
2402MHz	Pass	2.40196G	3.40	-26.60	47.63M	-46.04	2.39458G	-51.00	2.4G	-53.51	2.48831G	-49.80	14.46039G	-45.15	1
2440MHz	Pass	2.40196G	3.40	-26.60	47.92M	-45.85	2.39993G	-47.14	2.4G	-53.85	2.48661G	-50.38	24.78628G	-44.58	1
2480MHz	Pass	2.40196G	3.40	-26.60	47.92M	-45.23	2.39976G	-48.84	2.4G	-53.02	2.48746G	-50.07	6.99718G	-45.56	1
BT-LE(2Mbps)	-	-	-	-	-	-	-	-	-	-	-	-	-	-	-
2402MHz	Pass	2.40146G	3.69	-26.31	47.92M	-44.97	2.4G	-28.52	2.4G	-29.45	2.48873G	-50.48	24.47696G	-44.59	1
2440MHz	Pass	2.40146G	3.69	-26.31	47.63M	-46.25	2.39413G	-51.24	2.4G	-53.34	2.49674G	-46.17	24.83971G	-44.56	1
2480MHz	Pass	2.40146G	3.69	-26.31	47.63M	-45.89	2.39047G	-50.74	2.4G	-53.11	2.48706G	-49.48	24.18731G	-45.25	1

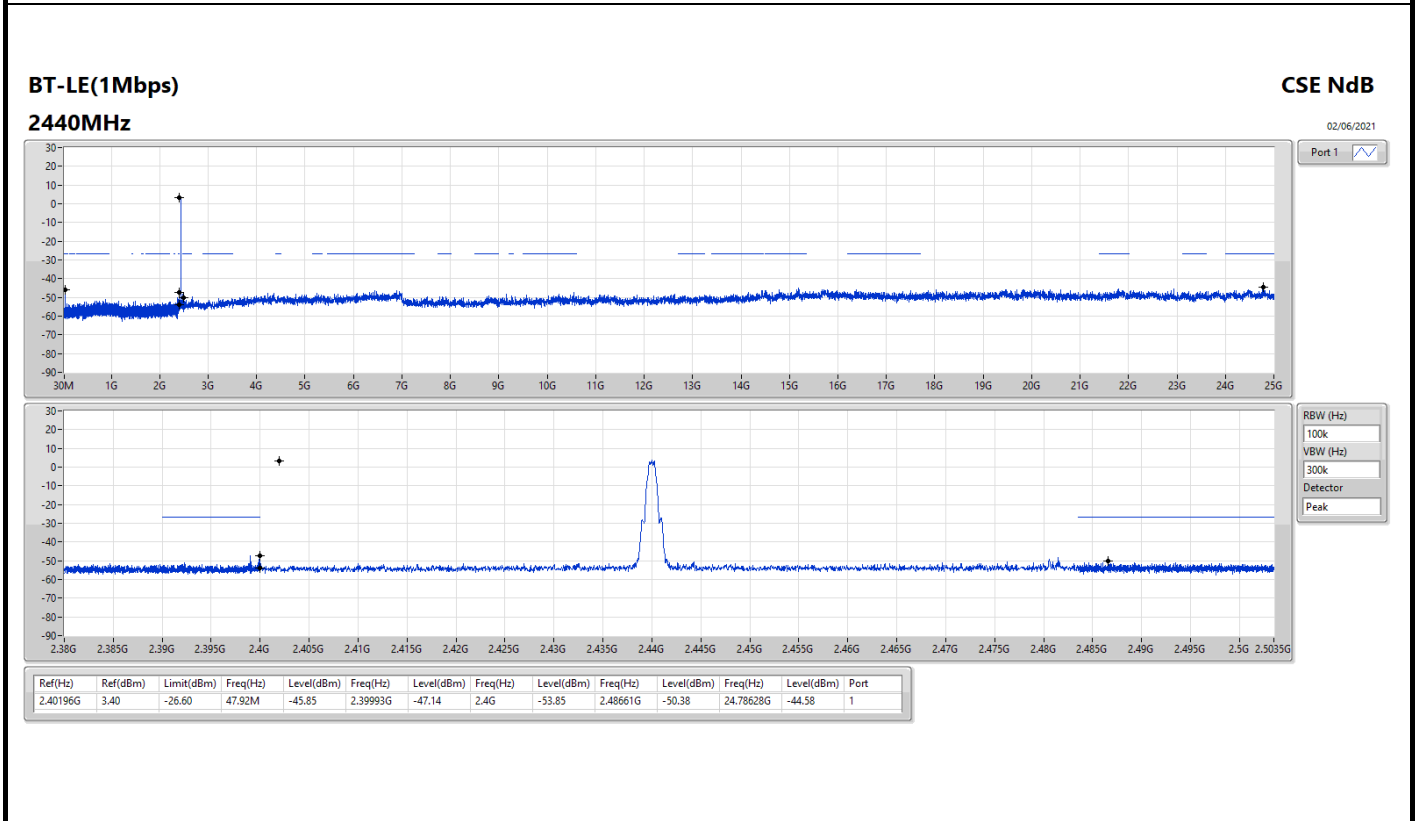
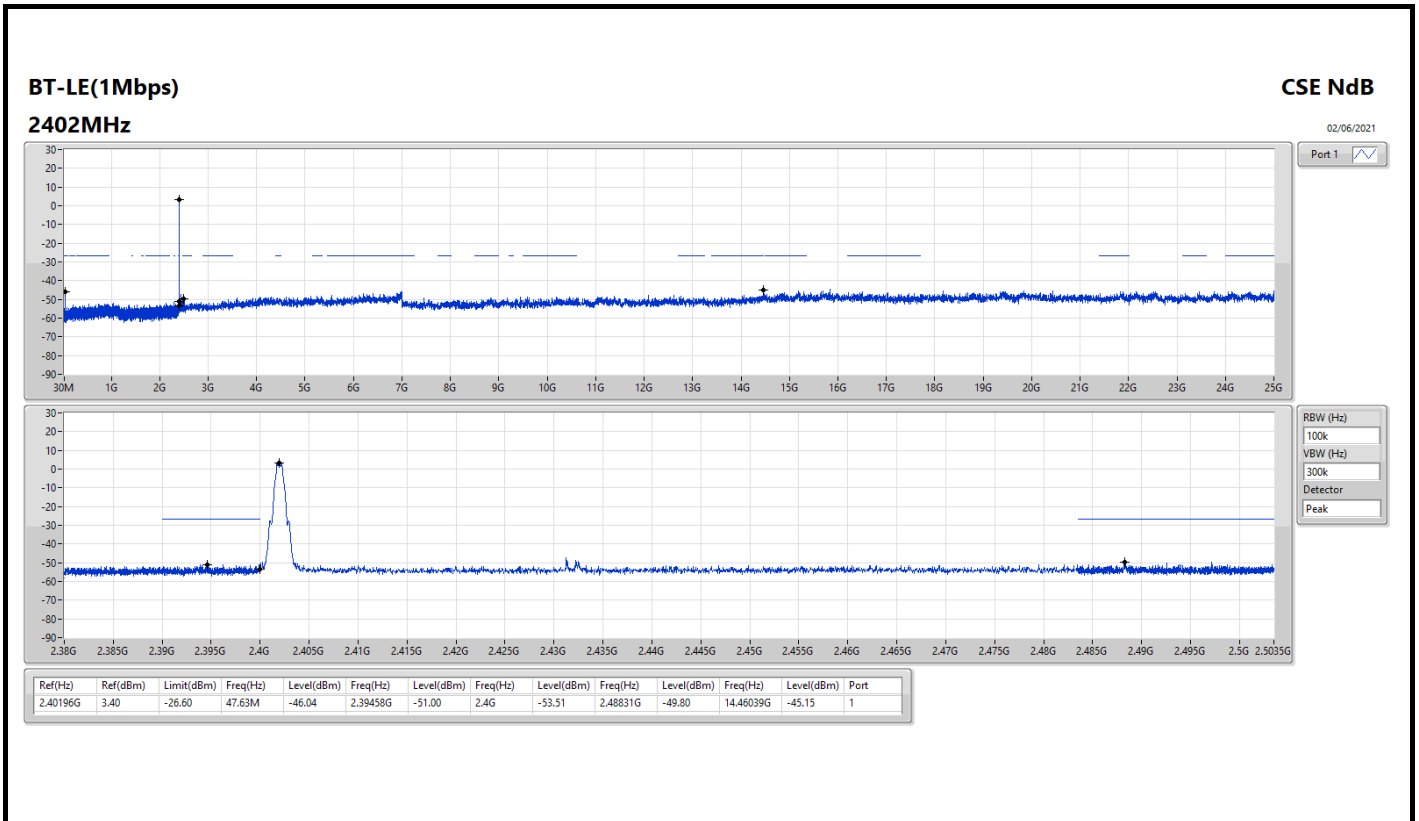

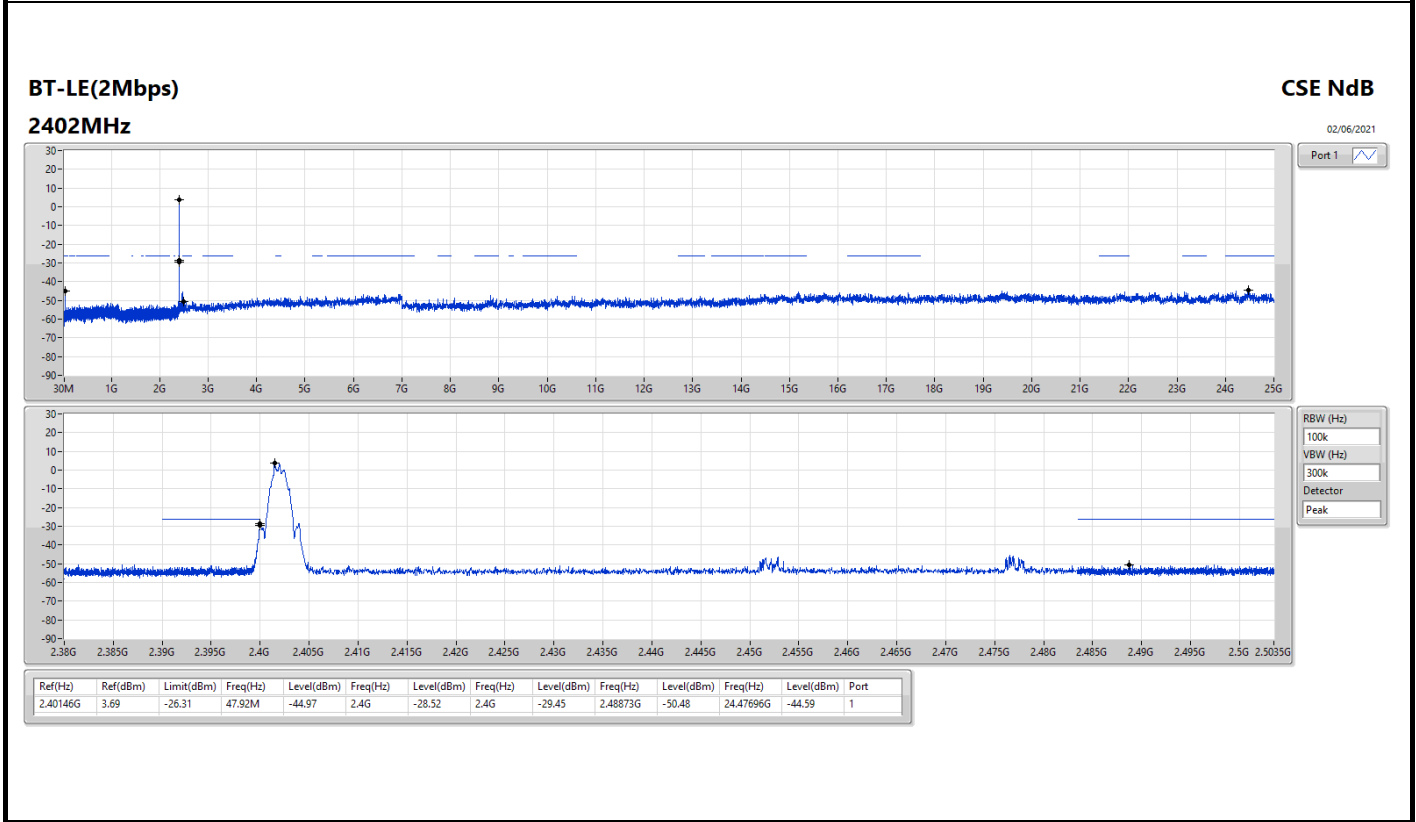
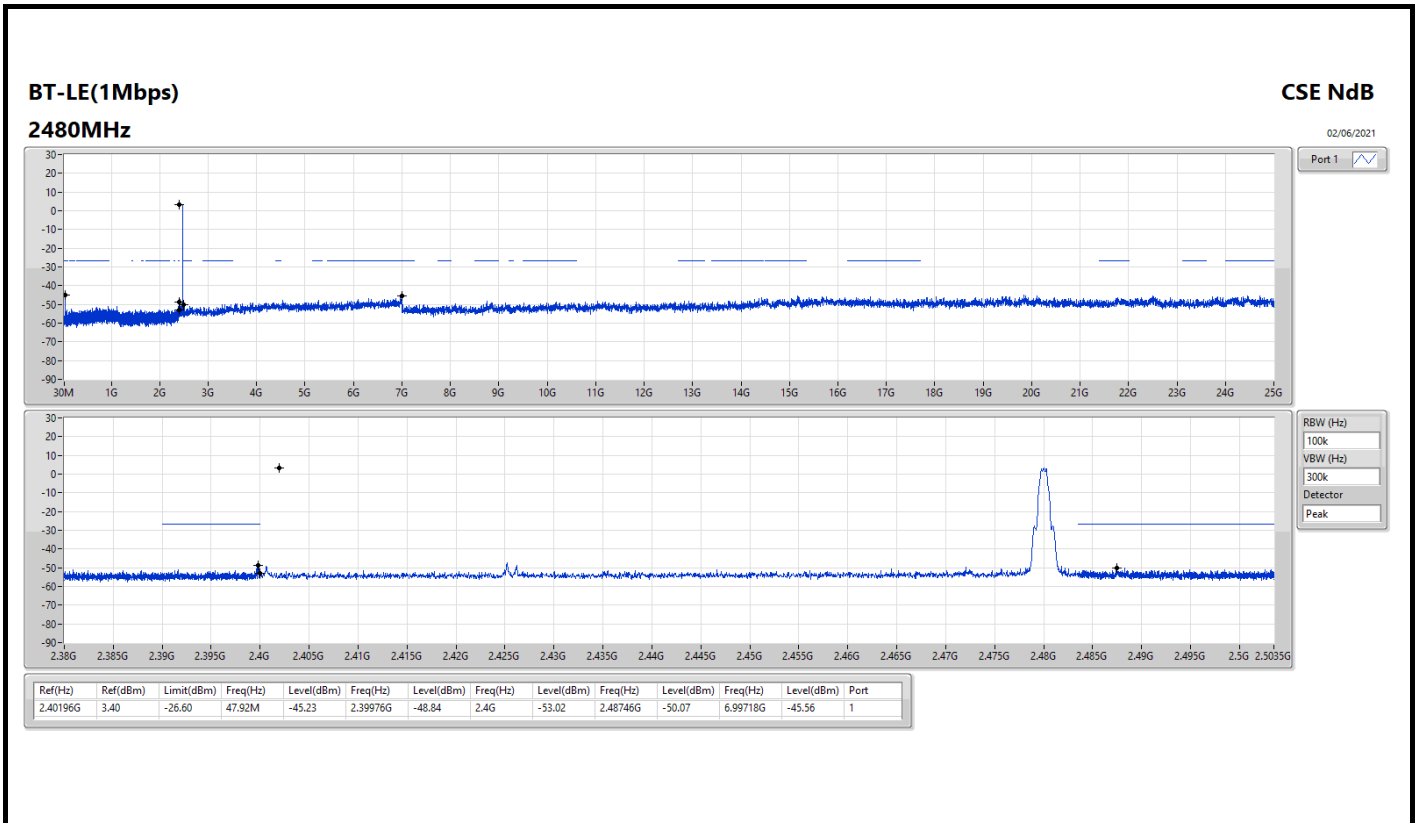

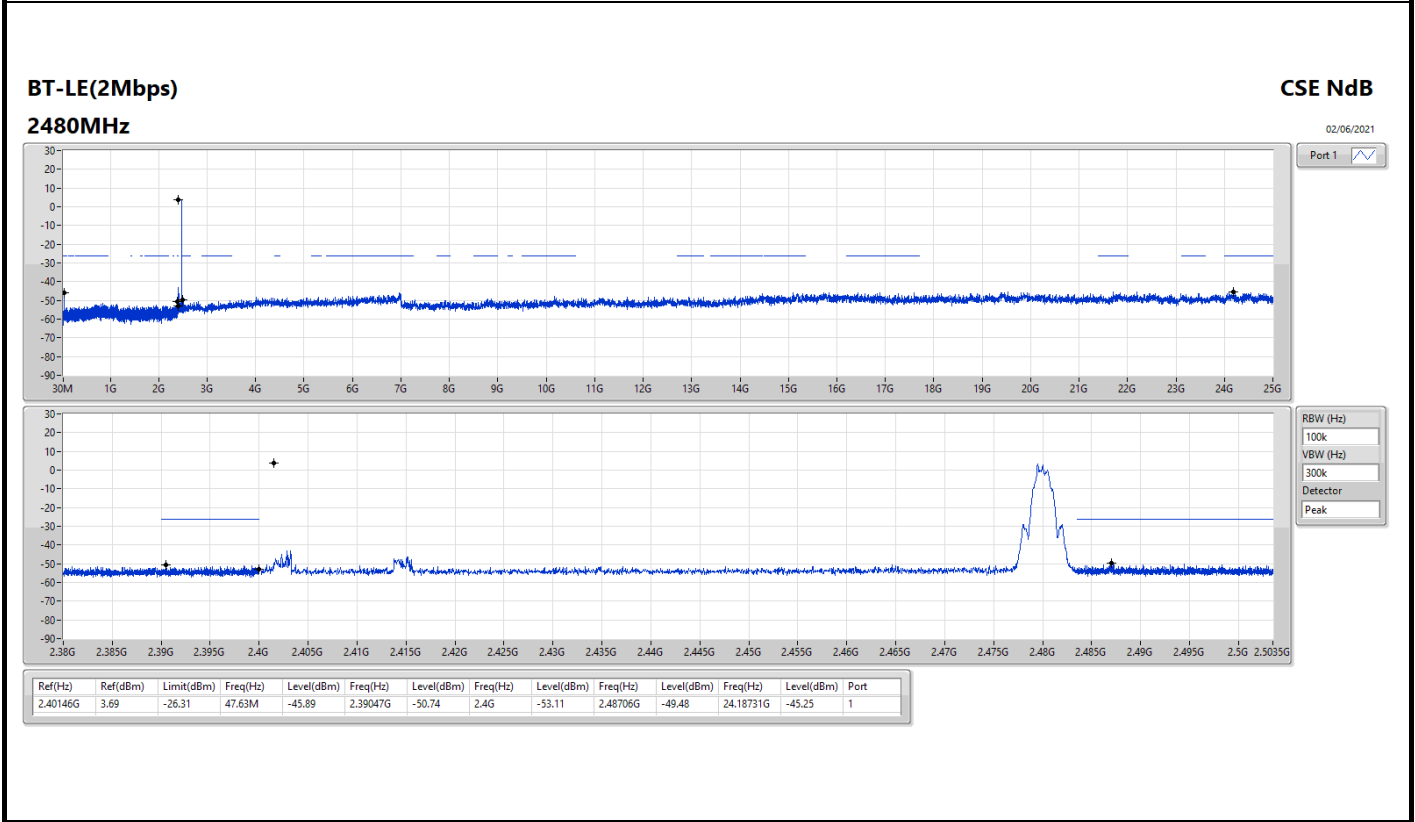
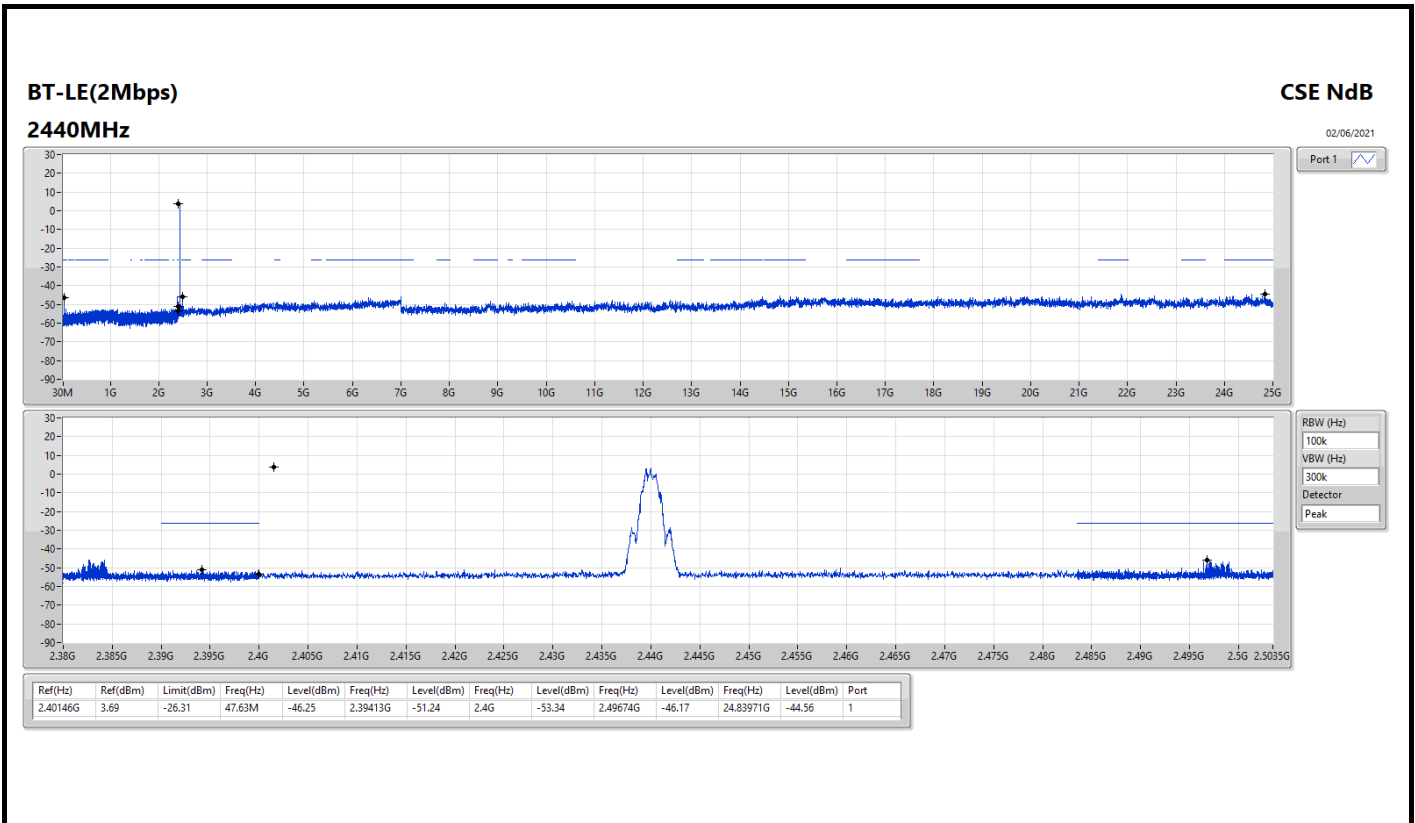



Summary

Mode	Result	Type	Freq (Hz)	Level (dBuV/m)	Limit (dBuV/m)	Margin (dB)	Condition
Mode 2	Pass	PK	90.18M	38.76	43.50	-4.74	Vertical

24/09/2021

Mode 2

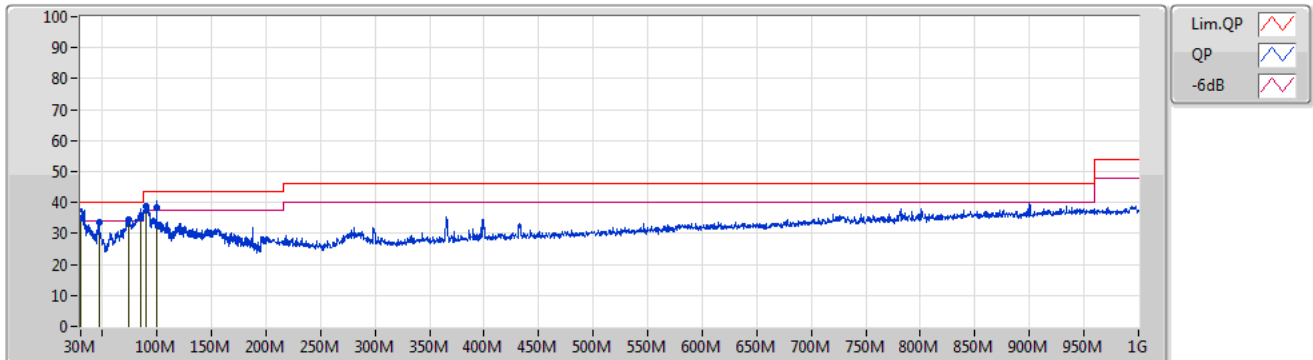

Type	Freq (Hz)	Level (dBuV/m)	Limit (dBuV/m)	Margin (dB)	Factor (dB)	Dist (m)	Condition	Azimuth (°)	Height (m)	Comment	Raw (dBuV)	AF (dB)	CL (dB)	PA (dB)
QP	30.51M	34.86	40.00	-5.14	-3.21	3	Vertical	17	1.00	-	38.07	23.65	1.02	27.88
PK	46.58M	33.77	40.00	-6.23	-11.51	3	Vertical	44	1.00	-	45.28	15.00	1.43	27.94
PK	73.44M	34.51	40.00	-5.49	-13.62	3	Vertical	96	1.00	-	48.13	12.19	1.97	27.78
QP	84.91M	34.76	40.00	-5.24	-11.97	3	Vertical	350	2.00	-	46.73	13.68	2.20	27.85
PK	90.18M	38.76	43.50	-4.74	-10.78	3	Vertical	301	4.00	"Worst"	49.54	14.87	2.20	27.85
QP	99.96M	38.32	43.50	-5.18	-8.43	3	Vertical	279	1.00	-	46.75	16.98	2.40	27.81

Mode 2

24/09/2021

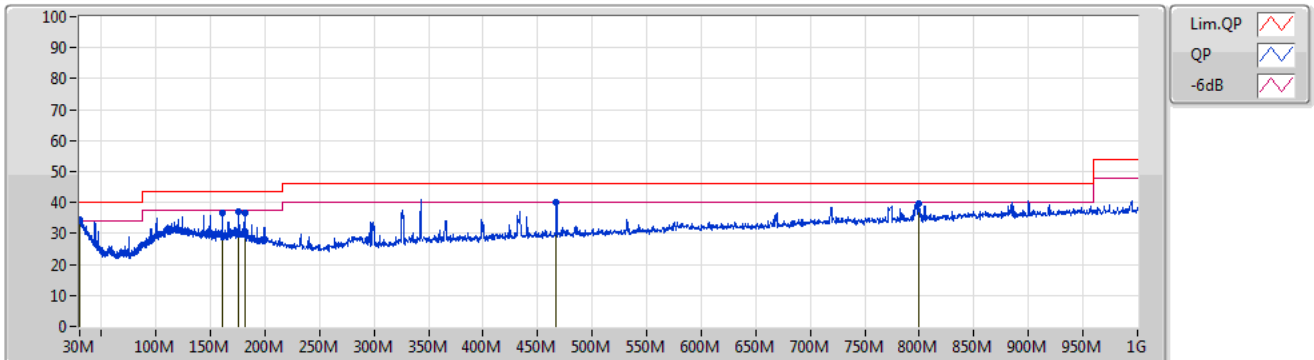

Type	Freq (Hz)	Level (dBuV/m)	Limit (dBuV/m)	Margin (dB)	Factor (dB)	Dist (m)	Condition	Azimuth (°)	Height (m)	Comment	Raw (dBuV)	AF (dB)	CL (dB)	PA (dB)
PK	30.43M	34.66	40.00	-5.34	-3.19	3	Horizontal	28	2.00	"Worst"	37.85	23.67	1.02	27.88
PK	176.03M	37.25	43.50	-6.25	-8.53	3	Horizontal	3	2.00	-	45.78	15.43	3.44	27.40
PK	181.22M	36.85	43.50	-6.65	-8.60	3	Horizontal	81	2.00	-	45.45	15.25	3.51	27.36
PK	467.2M	39.94	46.00	-6.06	-6.09	3	Horizontal	102	1.00	-	46.03	17.01	4.67	27.77
PK	799.2M	39.83	46.00	-6.17	-0.24	3	Horizontal	354	2.00	-	40.07	20.59	6.30	27.13
PK	160.82M	36.51	43.50	-6.99	-8.36	3	Horizontal	208	2.00	-	44.87	15.94	3.21	27.51



Summary

Mode	Result	Type	Freq (Hz)	Level (dBuV/m)	Limit (dBuV/m)	Margin (dB)	Dist (m)	Condition	Azimuth (°)	Height (m)	Comments
2.4-2.4835GHz	-	-	-	-	-	-	-	-	-	-	-
BT-LE(1Mbps)	Pass	AV	4.95968G	49.34	54.00	-4.66	3	Horizontal	16	1.47	-

BT-LE(1Mbps)

03/06/2021

2402MHz_TX

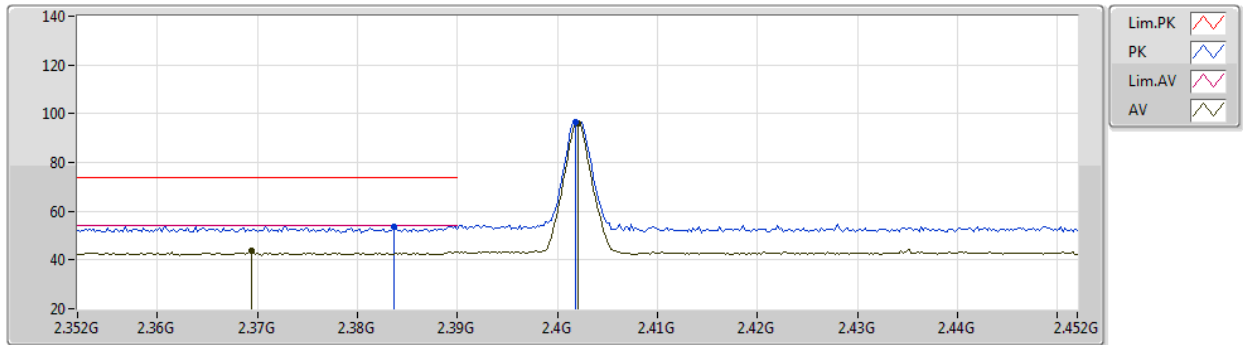

EUT Y_1TX
Setting 4
01-A-J-7

Type	Freq (Hz)	Level (dBuV/m)	Limit (dBuV/m)	Margin (dB)	Raw (dBuV)	Dist (m)	Condition	Azimuth (°)	Height (m)	Comment	AF (dB)	CL (dB)	PA (dB)
PK	2.3836G	53.76	74.00	-20.24	24.21	3	Vertical	330	1.76	-	27.37	2.18	-
AV	2.3694G	43.54	54.00	-10.46	14.03	3	Vertical	330	1.76	-	27.34	2.17	-
PK	2.4018G	96.77	Inf	-Inf	67.17	3	Vertical	330	1.76	-	27.40	2.20	-
AV	2.402G	95.81	Inf	-Inf	66.21	3	Vertical	330	1.76	-	27.40	2.20	-

BT-LE(1Mbps)

03/06/2021

2402MHz_TX

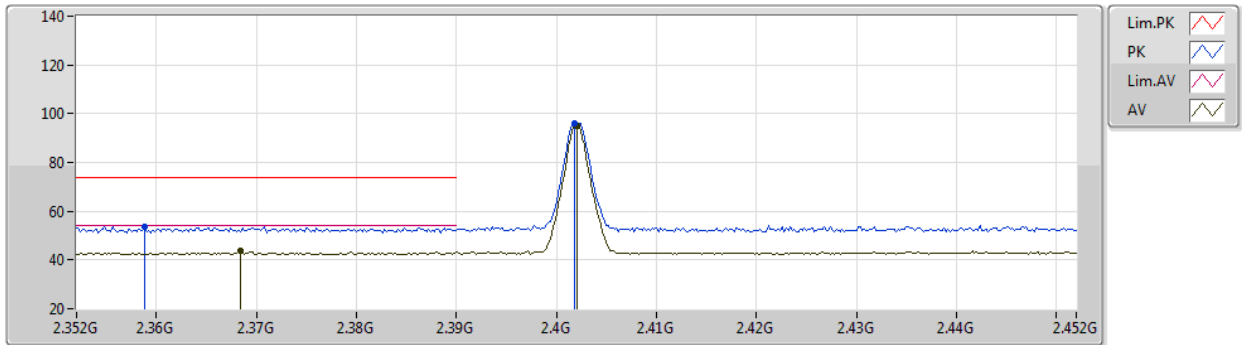

EUT Y_1TX
Setting 4
01-A-J-7

Type	Freq (Hz)	Level (dBuV/m)	Limit (dBuV/m)	Margin (dB)	Raw (dBuV)	Dist (m)	Condition	Azimuth (°)	Height (m)	Comment	AF (dB)	CL (dB)	PA (dB)
PK	2.3588G	53.74	74.00	-20.26	24.26	3	Horizontal	201	1.80	-	27.32	2.16	-
AV	2.3684G	43.74	54.00	-10.26	14.23	3	Horizontal	201	1.80	-	27.34	2.17	-
PK	2.4018G	96.09	Inf	-Inf	66.49	3	Horizontal	201	1.80	-	27.40	2.20	-
AV	2.402G	95.13	Inf	-Inf	65.53	3	Horizontal	201	1.80	-	27.40	2.20	-

BT-LE(1Mbps)

03/06/2021

2402MHz_TX

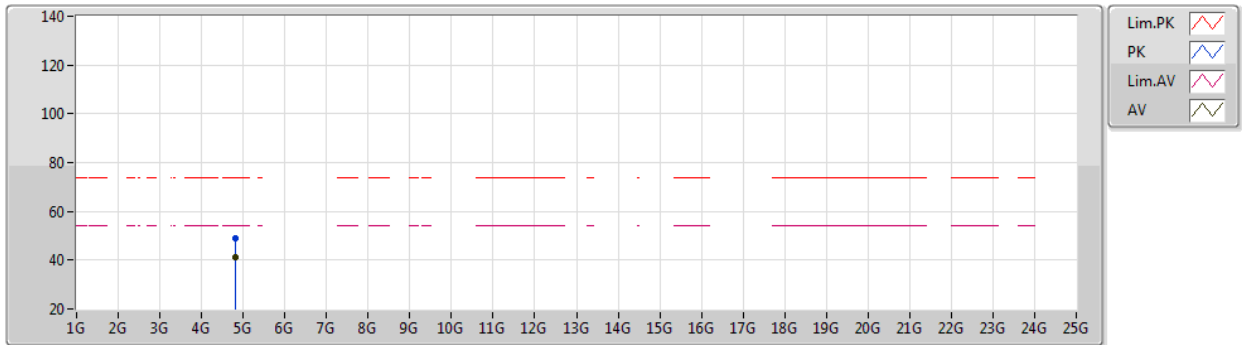

EUT Y_1TX
Setting 4
01-A-J-7

Type	Freq (Hz)	Level (dBuV/m)	Limit (dBuV/m)	Margin (dB)	Raw (dBuV)	Dist (m)	Condition	Azimuth (°)	Height (m)	Comment	AF (dB)	CL (dB)	PA (dB)
PK	4.80449G	49.04	74.00	-24.96	44.90	3	Vertical	309	1.53	-	32.13	5.00	32.99
AV	4.80369G	41.10	54.00	-12.90	36.97	3	Vertical	309	1.53	-	32.12	5.00	32.99

BT-LE(1Mbps)

03/06/2021

2402MHz_TX

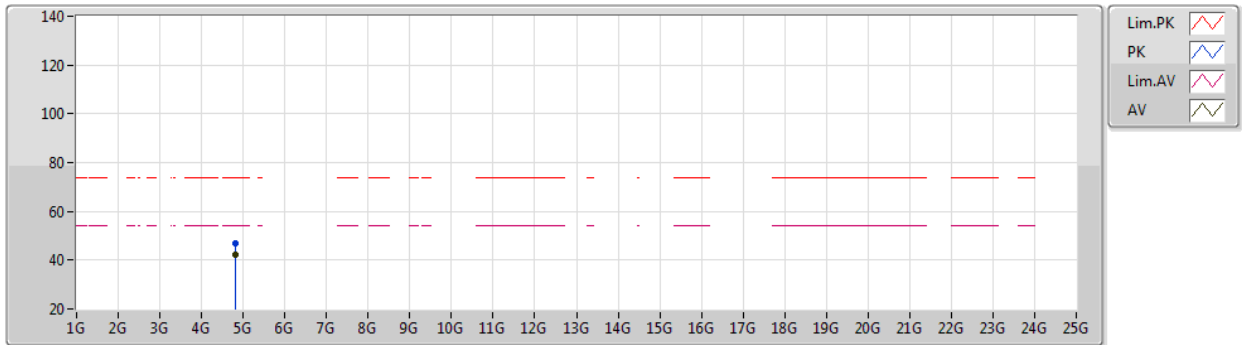

EUT Y_1TX
Setting 4
01-A-J-7

Type	Freq (Hz)	Level (dBuV/m)	Limit (dBuV/m)	Margin (dB)	Raw (dBuV)	Dist (m)	Condition	Azimuth (°)	Height (m)	Comment	AF (dB)	CL (dB)	PA (dB)
PK	4.80371G	46.68	74.00	-27.32	42.55	3	Horizontal	8	1.80	-	32.12	5.00	32.99
AV	4.80345G	42.41	54.00	-11.59	38.28	3	Horizontal	8	1.80	-	32.12	5.00	32.99

BT-LE(1Mbps)

03/06/2021

2440MHz_TX

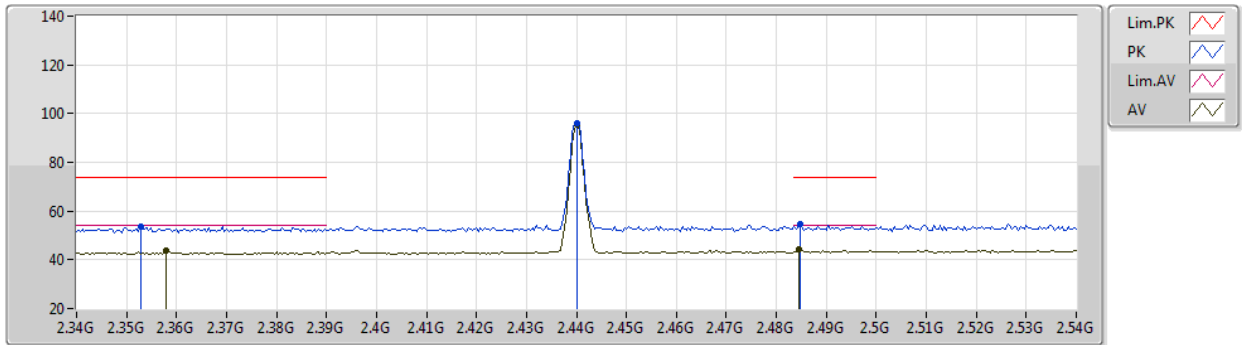

EUT Y_1TX
Setting 4
01-A-J-7

Type	Freq (Hz)	Level (dBuV/m)	Limit (dBuV/m)	Margin (dB)	Raw (dBuV)	Dist (m)	Condition	Azimuth (°)	Height (m)	Comment	AF (dB)	CL (dB)	PA (dB)
PK	2.3528G	53.72	74.00	-20.28	24.26	3	Vertical	159	1.76	-	27.31	2.15	-
AV	2.358G	43.75	54.00	-10.25	14.27	3	Vertical	159	1.76	-	27.32	2.16	-
PK	2.44G	96.23	Inf	-Inf	66.51	3	Vertical	159	1.76	-	27.48	2.24	-
AV	2.44G	95.28	Inf	-Inf	65.56	3	Vertical	159	1.76	-	27.48	2.24	-
PK	2.4848G	54.62	74.00	-19.38	24.63	3	Vertical	159	1.76	-	27.71	2.28	-
AV	2.4844G	44.08	54.00	-9.92	14.09	3	Vertical	159	1.76	-	27.71	2.28	-

BT-LE(1Mbps)

03/06/2021

2440MHz_TX

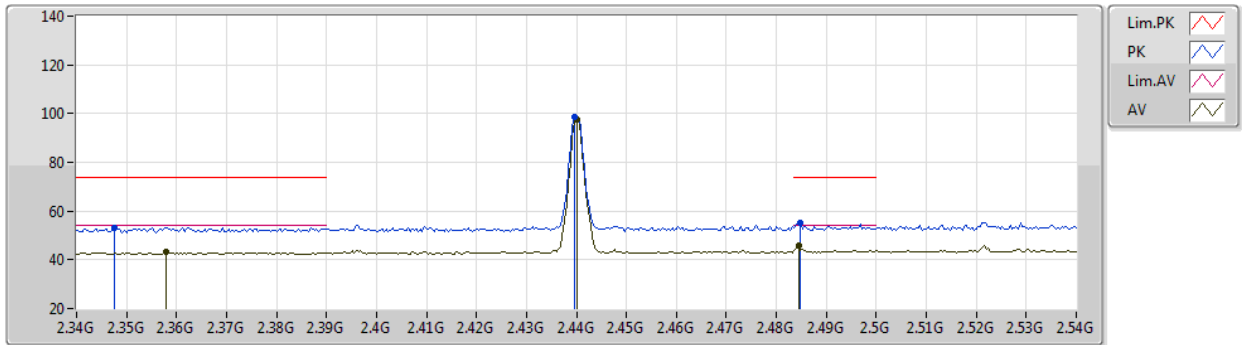

EUT Y_1TX
Setting 4
01-A-J-7

Type	Freq (Hz)	Level (dBuV/m)	Limit (dBuV/m)	Margin (dB)	Raw (dBuV)	Dist (m)	Condition	Azimuth (°)	Height (m)	Comment	AF (dB)	CL (dB)	PA (dB)
PK	2.3476G	53.24	74.00	-20.76	23.79	3	Horizontal	348	2.30	-	27.30	2.15	-
AV	2.358G	43.35	54.00	-10.65	13.87	3	Horizontal	348	2.30	-	27.32	2.16	-
PK	2.4396G	98.81	Inf	-Inf	69.09	3	Horizontal	348	2.30	-	27.48	2.24	-
AV	2.44G	97.78	Inf	-Inf	68.06	3	Horizontal	348	2.30	-	27.48	2.24	-
PK	2.4848G	55.26	74.00	-18.74	25.27	3	Horizontal	348	2.30	-	27.71	2.28	-
AV	2.4844G	45.64	54.00	-8.36	15.65	3	Horizontal	348	2.30	-	27.71	2.28	-

BT-LE(1Mbps)

03/06/2021

2440MHz_TX

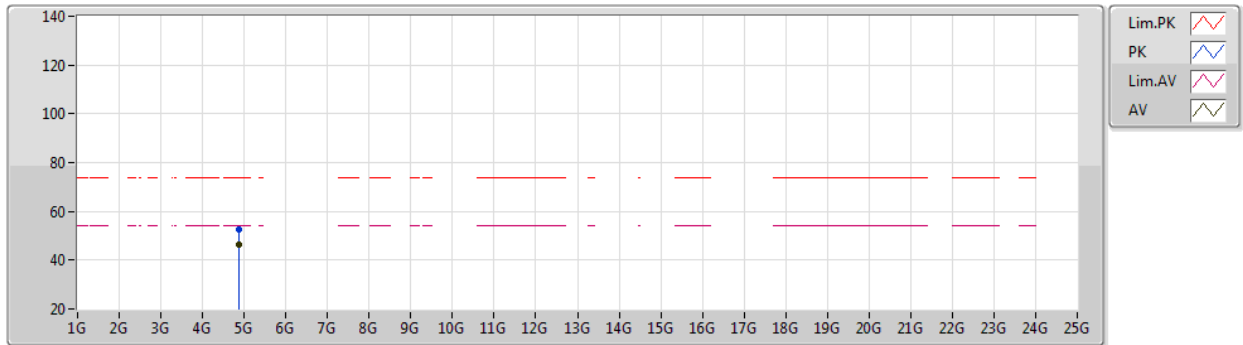

EUT Y_1TX
Setting 4
01-A-J-7

Type	Freq (Hz)	Level (dBuV/m)	Limit (dBuV/m)	Margin (dB)	Raw (dBuV)	Dist (m)	Condition	Azimuth (°)	Height (m)	Comment	AF (dB)	CL (dB)	PA (dB)
PK	4.87945G	52.58	74.00	-21.42	48.06	3	Vertical	313	1.34	-	32.46	5.04	32.98
AV	4.87957G	46.14	54.00	-7.86	41.62	3	Vertical	313	1.34	-	32.46	5.04	32.98

BT-LE(1Mbps)

03/06/2021

2440MHz_TX

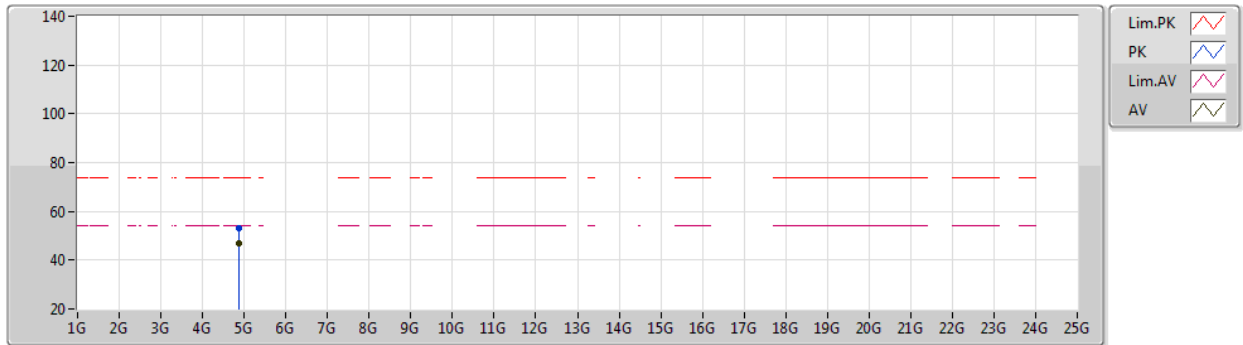

EUT Y_1TX
Setting 4
01-A-J-7

Type	Freq (Hz)	Level (dBuV/m)	Limit (dBuV/m)	Margin (dB)	Raw (dBuV)	Dist (m)	Condition	Azimuth (°)	Height (m)	Comment	AF (dB)	CL (dB)	PA (dB)
PK	4.88039G	53.10	74.00	-20.90	48.58	3	Horizontal	7	1.35	-	32.46	5.04	32.98
AV	4.87967G	46.71	54.00	-7.29	42.19	3	Horizontal	7	1.35	-	32.46	5.04	32.98

BT-LE(1Mbps)

03/06/2021

2480MHz_TX

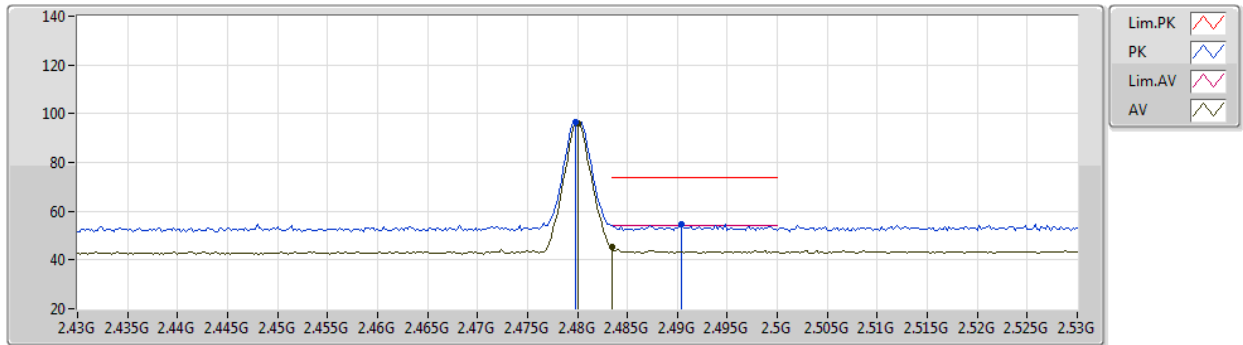

EUT Y_1TX
Setting 4
01-A-J-7

Type	Freq (Hz)	Level (dBuV/m)	Limit (dBuV/m)	Margin (dB)	Raw (dBuV)	Dist (m)	Condition	Azimuth (°)	Height (m)	Comment	AF (dB)	CL (dB)	PA (dB)
PK	2.4798G	96.81	Inf	-Inf	66.85	3	Vertical	165	1.37	-	27.68	2.28	-
AV	2.48G	95.81	Inf	-Inf	65.85	3	Vertical	165	1.37	-	27.68	2.28	-
PK	2.4904G	54.79	74.00	-19.21	24.76	3	Vertical	165	1.37	-	27.74	2.29	-
AV	2.4835G	45.14	54.00	-8.86	15.16	3	Vertical	165	1.37	-	27.70	2.28	-

BT-LE(1Mbps)

03/06/2021

2480MHz_TX

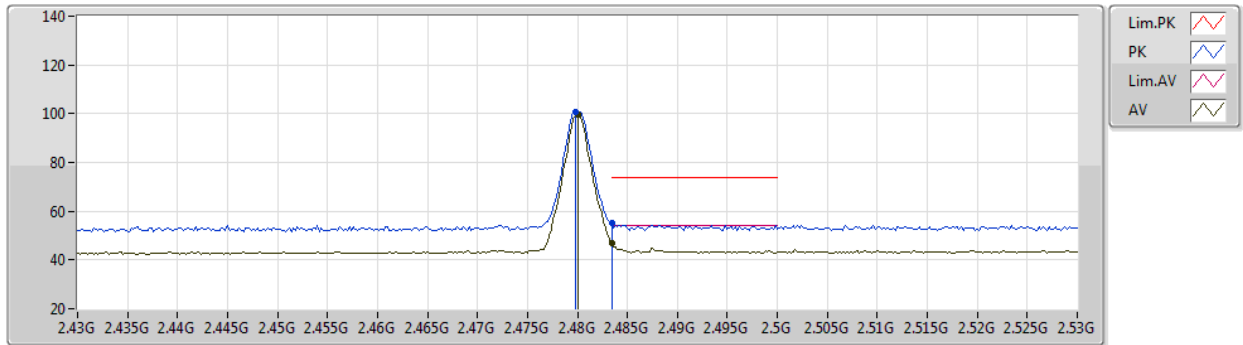

EUT Y_1TX
Setting 4
01-A-J-7

Type	Freq (Hz)	Level (dBuV/m)	Limit (dBuV/m)	Margin (dB)	Raw (dBuV)	Dist (m)	Condition	Azimuth (°)	Height (m)	Comment	AF (dB)	CL (dB)	PA (dB)
PK	2.4798G	100.53	Inf	-Inf	70.57	3	Horizontal	349	2.78	-	27.68	2.28	-
AV	2.48G	99.54	Inf	-Inf	69.58	3	Horizontal	349	2.78	-	27.68	2.28	-
PK	2.4835G	55.27	74.00	-18.73	25.29	3	Horizontal	349	2.78	-	27.70	2.28	-
AV	2.4835G	47.08	54.00	-6.92	17.10	3	Horizontal	349	2.78	-	27.70	2.28	-

BT-LE(1Mbps)

03/06/2021

2480MHz_TX

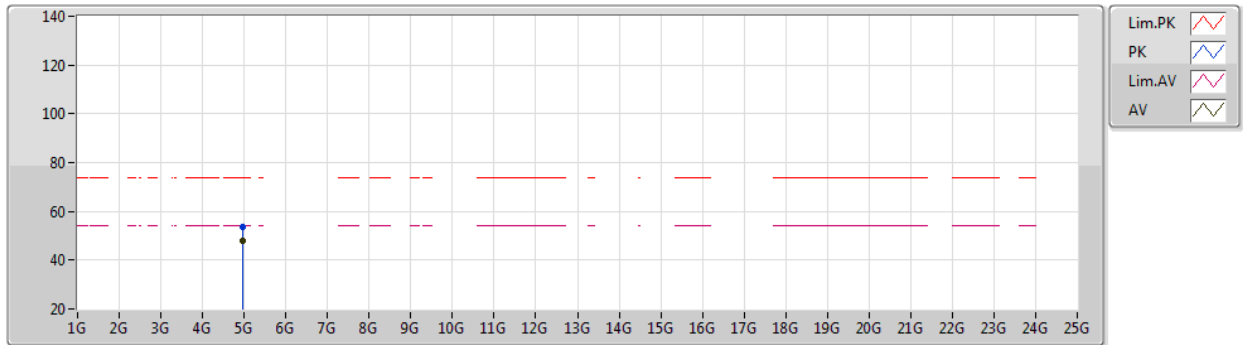

EUT Y_1TX
Setting 4
01-A-J-7

Type	Freq (Hz)	Level (dBuV/m)	Limit (dBuV/m)	Margin (dB)	Raw (dBuV)	Dist (m)	Condition	Azimuth (°)	Height (m)	Comment	AF (dB)	CL (dB)	PA (dB)
PK	4.96031G	53.51	74.00	-20.49	48.62	3	Vertical	312	1.19	-	32.78	5.08	32.97
AV	4.9597G	47.75	54.00	-6.25	42.86	3	Vertical	312	1.19	-	32.78	5.08	32.97

BT-LE(1Mbps)

03/06/2021

2480MHz_TX

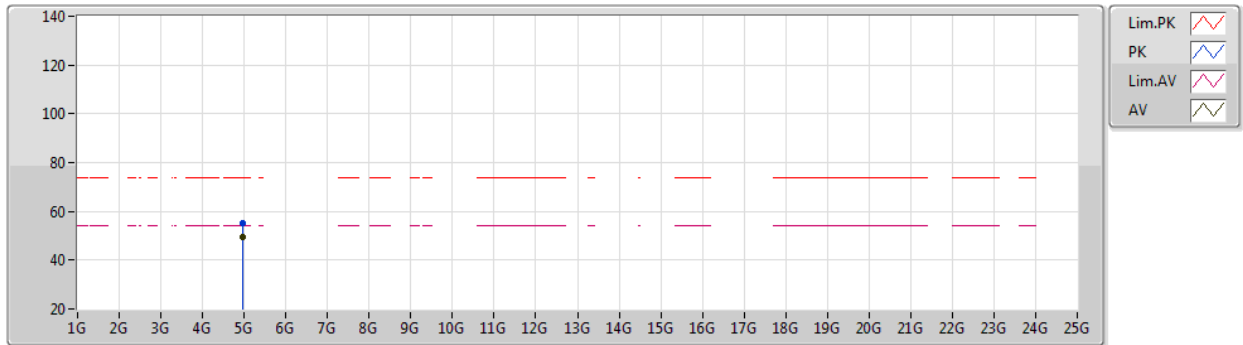

EUT Y_1TX
Setting 4
01-A-J-7

Type	Freq (Hz)	Level (dBuV/m)	Limit (dBuV/m)	Margin (dB)	Raw (dBuV)	Dist (m)	Condition	Azimuth (°)	Height (m)	Comment	AF (dB)	CL (dB)	PA (dB)
PK	4.95941G	55.27	74.00	-18.73	50.38	3	Horizontal	16	1.47	-	32.78	5.08	32.97
AV	4.95968G	49.34	54.00	-4.66	44.45	3	Horizontal	16	1.47	-	32.78	5.08	32.97

BT-LE(2Mbps)

03/06/2021

2402MHz_TX

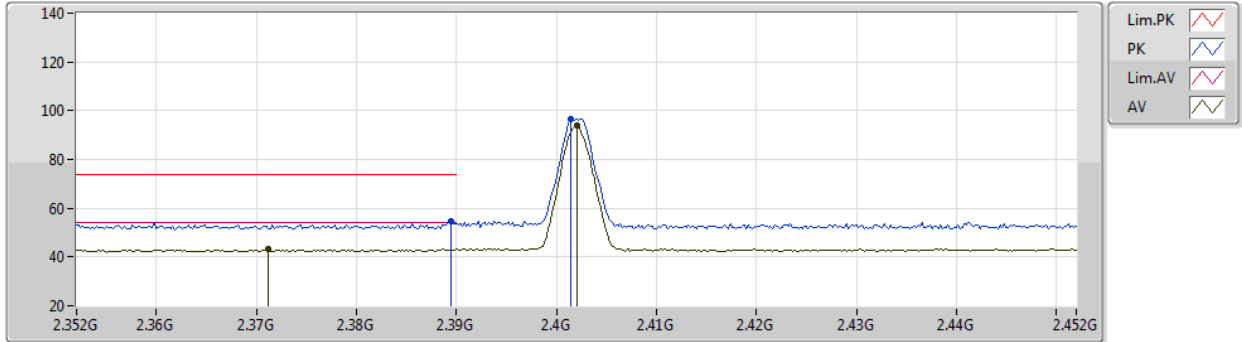

EUT Y_1TX
Setting 4
01-A-J-7

Type	Freq (Hz)	Level (dBuV/m)	Limit (dBuV/m)	Margin (dB)	Raw (dBuV)	Dist (m)	Condition	Azimuth (°)	Height (m)	Comment	AF (dB)	CL (dB)	PA (dB)
PK	2.3894G	54.74	74.00	-19.26	25.17	3	Vertical	331	1.75	-	27.38	2.19	-
AV	2.3712G	43.26	54.00	-10.74	13.75	3	Vertical	331	1.75	-	27.34	2.17	-
PK	2.4014G	96.58	Inf	-Inf	66.98	3	Vertical	331	1.75	-	27.40	2.20	-
AV	2.402G	93.80	Inf	-Inf	64.20	3	Vertical	331	1.75	-	27.40	2.20	-

BT-LE(2Mbps)

03/06/2021

2402MHz_TX

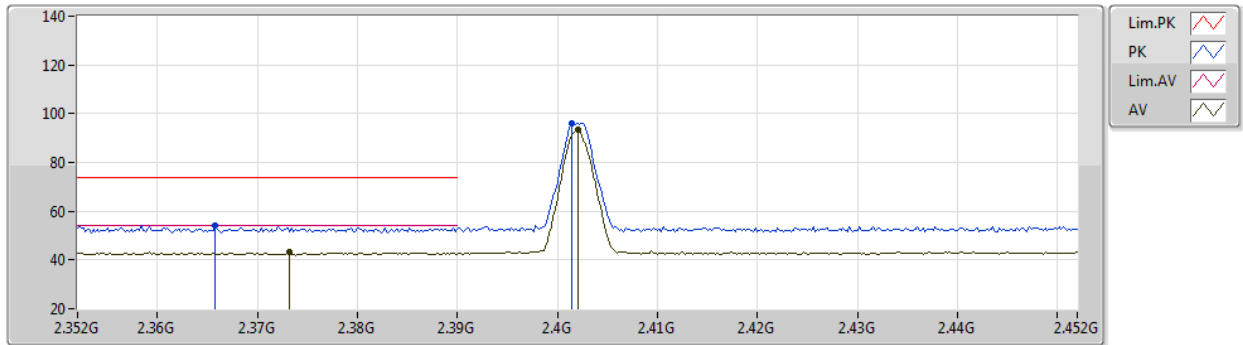

EUT Y_1TX
Setting 4
01-A-J-7

Type	Freq (Hz)	Level (dBuV/m)	Limit (dBuV/m)	Margin (dB)	Raw (dBuV)	Dist (m)	Condition	Azimuth (°)	Height (m)	Comment	AF (dB)	CL (dB)	PA (dB)
PK	2.3658G	54.25	74.00	-19.75	24.75	3	Horizontal	201	1.80	-	27.33	2.17	-
AV	2.3732G	43.08	54.00	-10.92	13.56	3	Horizontal	201	1.80	-	27.35	2.17	-
PK	2.4014G	96.10	Inf	-Inf	66.50	3	Horizontal	201	1.80	-	27.40	2.20	-
AV	2.402G	93.28	Inf	-Inf	63.68	3	Horizontal	201	1.80	-	27.40	2.20	-

BT-LE(2Mbps)

03/06/2021

2402MHz_TX

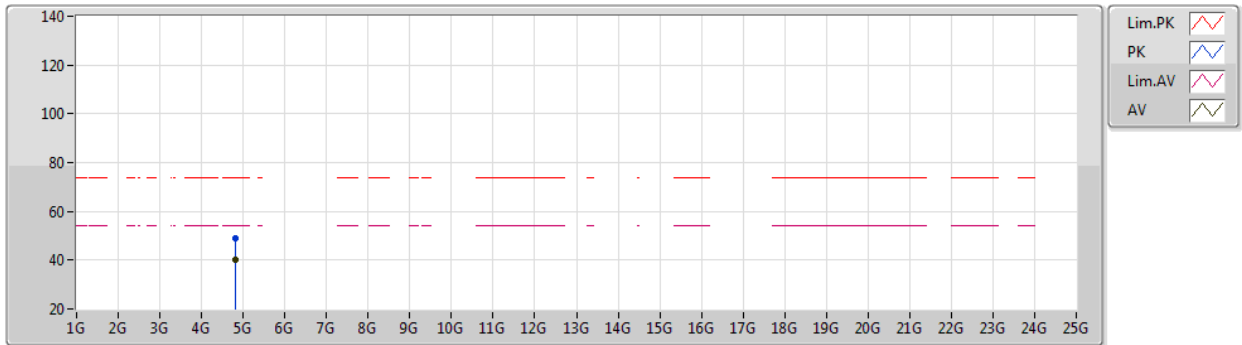

EUT Y_1TX
Setting 4
01-A-J-7

Type	Freq (Hz)	Level (dBuV/m)	Limit (dBuV/m)	Margin (dB)	Raw (dBuV)	Dist (m)	Condition	Azimuth (°)	Height (m)	Comment	AF (dB)	CL (dB)	PA (dB)
PK	4.80282G	49.22	74.00	-24.78	45.09	3	Vertical	71	1.56	-	32.12	5.00	32.99
AV	4.80476G	40.42	54.00	-13.58	36.28	3	Vertical	71	1.56	-	32.13	5.00	32.99

BT-LE(2Mbps)

03/06/2021

2402MHz_TX

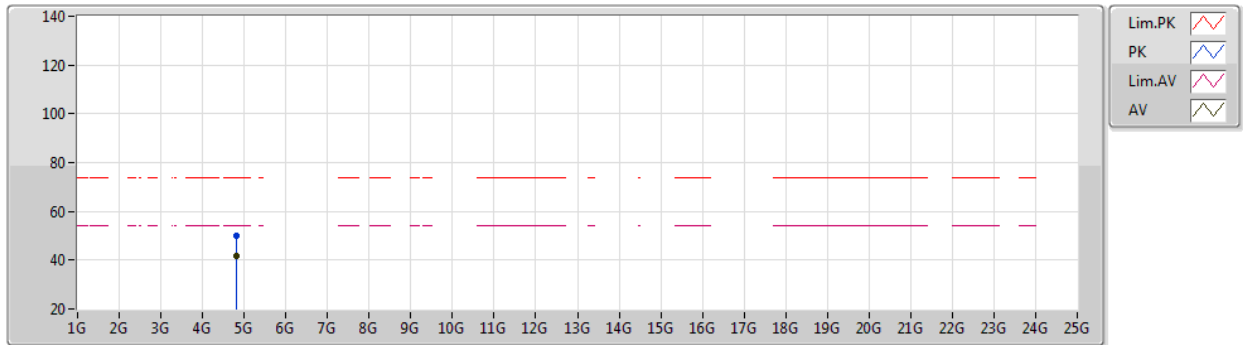

EUT Y_1TX
Setting 4
01-A-J-7

Type	Freq (Hz)	Level (dBuV/m)	Limit (dBuV/m)	Margin (dB)	Raw (dBuV)	Dist (m)	Condition	Azimuth (°)	Height (m)	Comment	AF (dB)	CL (dB)	PA (dB)
PK	4.80291G	49.80	74.00	-24.20	45.67	3	Horizontal	3	1.93	-	32.12	5.00	32.99
AV	4.80305G	41.97	54.00	-12.03	37.84	3	Horizontal	3	1.93	-	32.12	5.00	32.99

BT-LE(2Mbps)

03/06/2021

2440MHz_TX

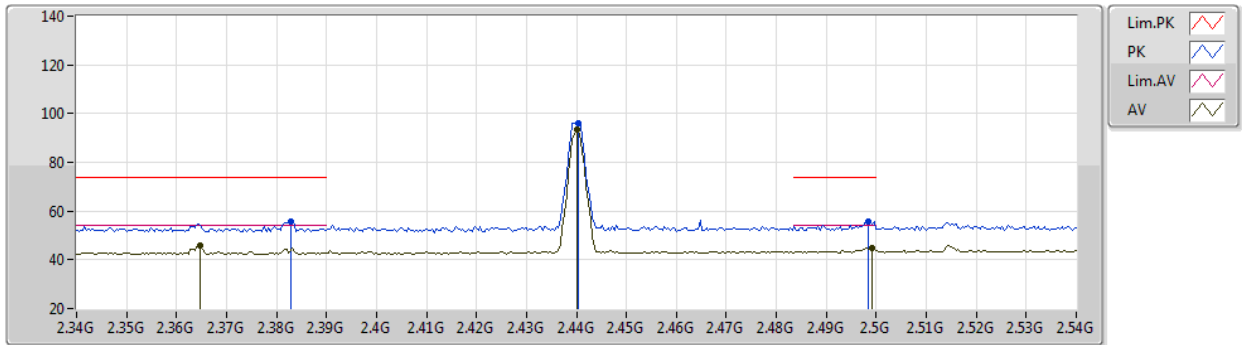

EUT Y_1TX
Setting 4
01-A-J-7

Type	Freq (Hz)	Level (dBuV/m)	Limit (dBuV/m)	Margin (dB)	Raw (dBuV)	Dist (m)	Condition	Azimuth (°)	Height (m)	Comment	AF (dB)	CL (dB)	PA (dB)
PK	2.3828G	55.47	74.00	-18.53	25.92	3	Vertical	159	1.56	-	27.37	2.18	-
AV	2.3648G	45.88	54.00	-8.12	16.39	3	Vertical	159	1.56	-	27.33	2.16	-
PK	2.4404G	96.20	Inf	-Inf	66.48	3	Vertical	159	1.56	-	27.48	2.24	-
AV	2.44G	93.36	Inf	-Inf	63.64	3	Vertical	159	1.56	-	27.48	2.24	-
PK	2.4984G	55.94	74.00	-18.06	25.85	3	Vertical	159	1.56	-	27.79	2.30	-
AV	2.4992G	44.93	54.00	-9.07	14.83	3	Vertical	159	1.56	-	27.80	2.30	-

BT-LE(2Mbps)

03/06/2021

2440MHz_TX

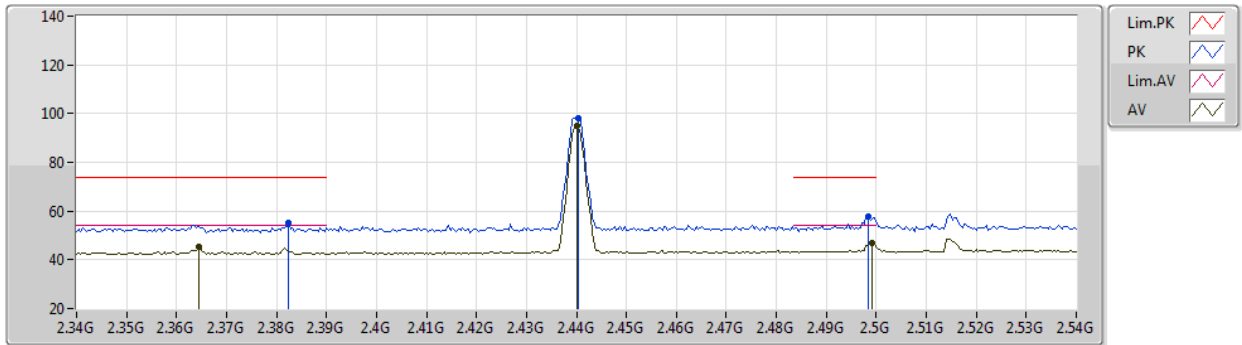

EUT Y_1TX
Setting 4
01-A-J-7

Type	Freq (Hz)	Level (dBuV/m)	Limit (dBuV/m)	Margin (dB)	Raw (dBuV)	Dist (m)	Condition	Azimuth (°)	Height (m)	Comment	AF (dB)	CL (dB)	PA (dB)
PK	2.3824G	55.28	74.00	-18.72	25.74	3	Horizontal	352	1.93	-	27.36	2.18	-
AV	2.3644G	45.60	54.00	-8.40	16.11	3	Horizontal	352	1.93	-	27.33	2.16	-
PK	2.4404G	97.95	Inf	-Inf	68.23	3	Horizontal	352	1.93	-	27.48	2.24	-
AV	2.44G	95.18	Inf	-Inf	65.46	3	Horizontal	352	1.93	-	27.48	2.24	-
PK	2.4984G	57.73	74.00	-16.27	27.64	3	Horizontal	352	1.93	-	27.79	2.30	-
AV	2.4992G	46.65	54.00	-7.35	16.55	3	Horizontal	352	1.93	-	27.80	2.30	-

BT-LE(2Mbps)

03/06/2021

2440MHz_TX

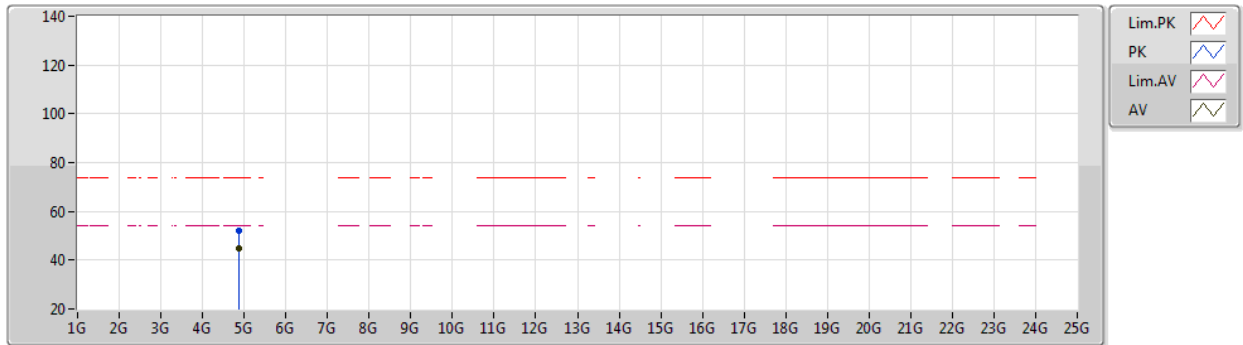

EUT Y_1TX
Setting 4
01-A-J-7

Type	Freq (Hz)	Level (dBuV/m)	Limit (dBuV/m)	Margin (dB)	Raw (dBuV)	Dist (m)	Condition	Azimuth (°)	Height (m)	Comment	AF (dB)	CL (dB)	PA (dB)
PK	4.88099G	51.97	74.00	-22.03	47.45	3	Vertical	312	1.28	-	32.46	5.04	32.98
AV	4.87886G	44.70	54.00	-9.30	40.18	3	Vertical	312	1.28	-	32.46	5.04	32.98

BT-LE(2Mbps)

03/06/2021

2440MHz_TX

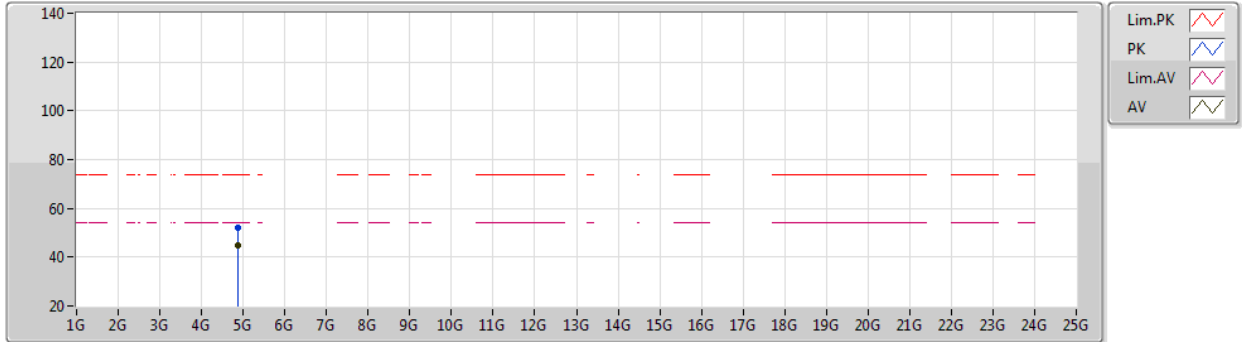

EUT Y_1TX
Setting 4
01-A-J-7

Type	Freq (Hz)	Level (dBuV/m)	Limit (dBuV/m)	Margin (dB)	Raw (dBuV)	Dist (m)	Condition	Azimuth (°)	Height (m)	Comment	AF (dB)	CL (dB)	PA (dB)
PK	4.88096G	51.96	74.00	-22.04	47.44	3	Horizontal	312	1.32	-	32.46	5.04	32.98
AV	4.87906G	44.73	54.00	-9.27	40.21	3	Horizontal	312	1.32	-	32.46	5.04	32.98

BT-LE(2Mbps)

03/06/2021

2480MHz_TX

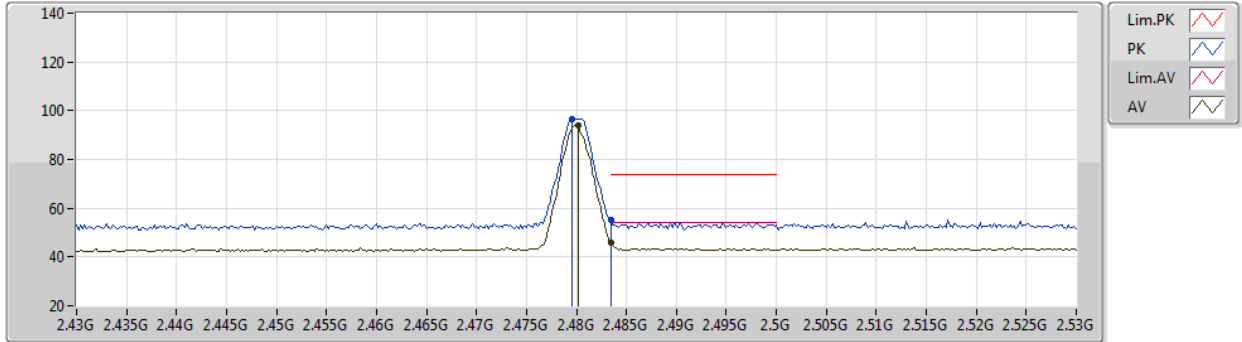

EUT Y_1TX
Setting 4
01-A-K-3

Type	Freq (Hz)	Level (dBuV/m)	Limit (dBuV/m)	Margin (dB)	Raw (dBuV)	Dist (m)	Condition	Azimuth (°)	Height (m)	Comment	AF (dB)	CL (dB)	PA (dB)
PK	2.4796G	96.80	Inf	-Inf	66.84	3	Vertical	147	2.59	-	27.68	2.28	-
AV	2.4802G	93.99	Inf	-Inf	64.03	3	Vertical	147	2.59	-	27.68	2.28	-
PK	2.4835G	54.98	74.00	-19.02	25.00	3	Vertical	147	2.59	-	27.70	2.28	-
AV	2.4835G	45.87	54.00	-8.13	15.89	3	Vertical	147	2.59	-	27.70	2.28	-

BT-LE(2Mbps)

03/06/2021

2480MHz_TX

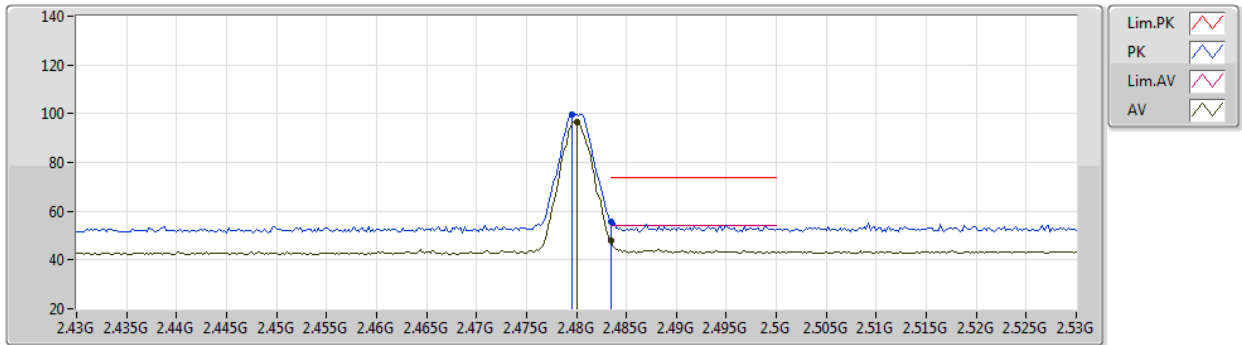

EUT Y_1TX
Setting 4
01-A-K-3

Type	Freq (Hz)	Level (dBuV/m)	Limit (dBuV/m)	Margin (dB)	Raw (dBuV)	Dist (m)	Condition	Azimuth (°)	Height (m)	Comment	AF (dB)	CL (dB)	PA (dB)
PK	2.4796G	99.59	Inf	-Inf	69.63	3	Horizontal	359	1.90	-	27.68	2.28	-
AV	2.48G	96.79	Inf	-Inf	66.83	3	Horizontal	359	1.90	-	27.68	2.28	-
PK	2.4835G	55.79	74.00	-18.21	25.81	3	Horizontal	359	1.90	-	27.70	2.28	-
AV	2.4835G	47.70	54.00	-6.30	17.72	3	Horizontal	359	1.90	-	27.70	2.28	-

BT-LE(2Mbps)

03/06/2021

2480MHz_TX

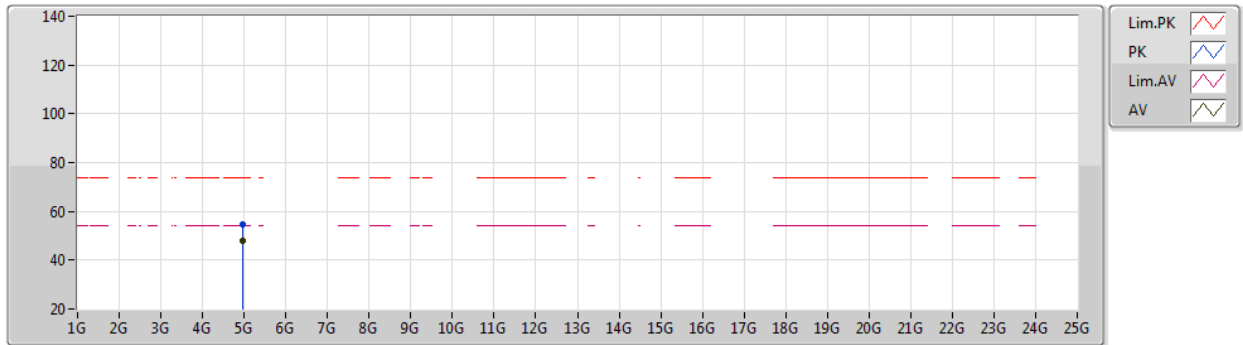

EUT Y_1TX
Setting 4
01-A-K-3

Type	Freq (Hz)	Level (dBuV/m)	Limit (dBuV/m)	Margin (dB)	Raw (dBuV)	Dist (m)	Condition	Azimuth (°)	Height (m)	Comment	AF (dB)	CL (dB)	PA (dB)
PK	4.95903G	54.46	74.00	-19.54	49.57	3	Vertical	299	1.38	-	32.78	5.08	32.97
AV	4.95904G	48.00	54.00	-6.00	43.11	3	Vertical	299	1.38	-	32.78	5.08	32.97

BT-LE(2Mbps)

03/06/2021

2480MHz_TX

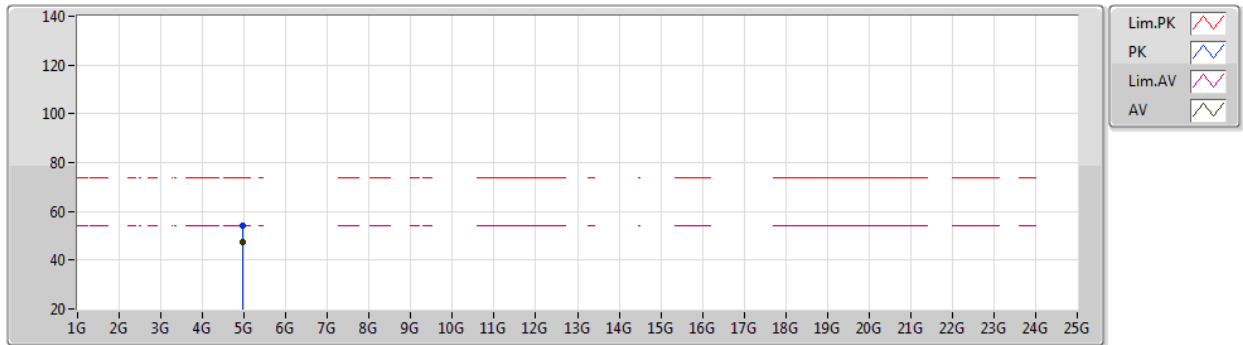

EUT Y_1TX
Setting 4
01-A-K-3

Type	Freq (Hz)	Level (dBuV/m)	Limit (dBuV/m)	Margin (dB)	Raw (dBuV)	Dist (m)	Condition	Azimuth (°)	Height (m)	Comment	AF (dB)	CL (dB)	PA (dB)
PK	4.95899G	54.14	74.00	-19.86	49.25	3	Horizontal	16	1.50	-	32.78	5.08	32.97
AV	4.95894G	47.51	54.00	-6.49	42.62	3	Horizontal	16	1.50	-	32.78	5.08	32.97