

# FCC Test Report

**EQUIPMENT** : WirelessHD TX Module

**BRAND NAME** : AzureWave

**MODEL NO.** : AW-WH029T

**FCC ID** : TLZ-WH029T

**STANDARD** : 47 CFR FCC Part 15.255

**APPLICANT** : AzureWave Technologies, Inc.  
8F., No. 94, Baozhong Rd. Xindian Taipei,  
Taiwan 231

**MANUFACTURER** : AzureWave Technologies, Inc.

The product sample received on Nov. 19, 2010 and completely tested on Jul. 04, 2011. We, SPORTON, would like to declare that the tested sample has been evaluated in accordance with the procedures given in ANSI C63.10-2009 and shown compliance with the applicable technical standards.

The test results in this report apply exclusively to the tested model / sample. Without written approval of SPORTON INTERNATIONAL INC., the test report shall not be reproduced except in full.



*Reviewed by: Jordan Hsiao*





# TABLE OF CONTENTS

**TABLE OF CONTENTS** .....2

**SUMMARY OF TEST RESULT** .....3

**REVISION HISTORY**.....4

**1 GENERAL DESCRIPTION** .....5

1.1 Information.....5

1.2 Additional Information Provided by the Submitter .....8

1.3 Ancillary and/or Support Equipment.....9

1.4 EUT Setups .....9

1.5 Testing Applied Standards .....13

1.6 Testing Location .....13

1.7 Abbreviations Used for the Test Report .....13

**2 TEST CONFIGURATION OF EQUIPMENT UNDER TEST** .....14

2.1 Test Channel Frequencies .....14

2.2 Conformance Tests and Related Test Frequencies .....14

**3 TRANSMITTER TEST RESULT** .....15

3.1 AC Power Conducted Emissions .....15

3.2 Occupied Bandwidth .....19

3.3 EIRP Power and Power Density.....25

3.4 Peak Conducted Power.....33

3.5 Transmitter Spurious Emissions.....36

3.6 Frequency Stability.....48

3.7 Publicly-accessible Coordination Channel .....51

3.8 Operation Restriction and Group Installation .....54

3.9 Transmitter Identification .....55

3.10 Maximum Permissible Exposure .....56

**4 LIST OF MEASURING EQUIPMENTS**.....58

**5 CERTIFICATION OF TAF ACCREDITATION**.....60

**APPENDIX A. TEST PHOTOS** .....61

**APPENDIX B. PHOTOGRAPHS OF EUT** .....66



### SUMMARY OF TEST RESULT

FCC Standard Requirements and Conformance Test Specifications				
Report Clause	Ref. Std. Clause	Description	Result	Remark
3.1	15.207	AC Power Conducted Emissions	Complied	-
3.2	15.255(e)	Occupied Bandwidth	Complied	-
3.3	15.255(b)(1)	EIRP Power and Power Density	Complied	-
3.4	15.255(e)	Peak Conducted Power	Complied	-
3.5	15.255(c)	Transmitter Spurious Emissions	Complied	-
3.6	15.255(f)	Frequency Stability	Complied	-
3.7	15.255(d)	Publicly-accessible Coordination Channel	Complied	-
3.8	15.255(a),(h)	Operation Restriction and Group Installation	Complied	-
3.9	15.255(i)	Transmitter Identification	Complied	-
3.10	15.255(g)	Maximum Permissible Exposure	Complied	-



# 1 General Description

## 1.1 Information

### 1.1.1 The Channel Plan(s)

The Channel Plan(s)	
Low-rate PHY (LRP) Band	60.32 – 60.64 GHz/ 62.48-62.80GHz
LRP Channel List:	60.32 +n x 0.16 (n=0, 1, 2) GHz / 62.48 +n x 0.16 (n=0, 1, 2) GHz
High rate PHY (HRP) Band	60.48 GHz / 62.64GHz

### 1.1.2 Transmit Operating Modes

The Different Transmit Operating Modes	
<input checked="" type="checkbox"/>	Operating mode 1: Smart Antenna Systems - with beam forming
<input type="checkbox"/>	Operating mode 2: Smart Antenna Systems - without beam forming
<input type="checkbox"/>	Operating mode 3: Single Antenna Equipment

### 1.1.3 Smart Antenna Systems

In Case of Smart Antenna Systems	
The number of Receive chains:	4
The number of Transmit chains:	31
Equal power distribution among the transmit chains:	<input checked="" type="checkbox"/> Yes <input type="checkbox"/> No
<input checked="" type="checkbox"/> In case of beam forming, the maximum beam forming gain:	22 dB

### 1.1.4 Antenna Information

Antenna Information	
<input type="checkbox"/>	Equipment placed on the market without antennas
<input checked="" type="checkbox"/>	Integral antenna
Integral antenna gain:	16.00 dBi for LRP      22.00 dBi for HRP
(Beam forming gain)	<input type="checkbox"/> Temporary RF connector provided
	<input checked="" type="checkbox"/> No temporary RF connector provided
<input type="checkbox"/>	External antenna (dedicated antennas)
	<input type="checkbox"/> Single power level with corresponding antenna(s)
	<input type="checkbox"/> Multiple power settings and corresponding antenna(s)



1.1.5 Type of Equipment

Type of Equipment	
<input checked="" type="checkbox"/>	Stand-alone
<input type="checkbox"/>	Combined Equipment (The radio part is fully integrated within another type of equipment)
<input type="checkbox"/>	Plug-in radio device (Equipment intended for a variety of host systems)
<input type="checkbox"/>	Other:

1.1.6 Power Levels

(a) Worst Power Levels for LRP (Integrated Antenna)			
Applicable power levels:	<input type="checkbox"/> Conducted	<input checked="" type="checkbox"/> EIRP	
Integral antenna gain:	16.00 dBi		
Frequency (GHz)	Highest setting ( $P_{high}$ ): (dBm)		
	Modulation	Data Rate (Mb/s)	AV Power(dBm)
62.80	BPSK	20.337	23.27
Frequency (GHz)	Modulation	Data Rate (Mb/s)	Peak Power(dBm)
62.48	BPSK	20.337	28.16

(b) Worst Power Levels for HRP (Integrated Antenna)			
Applicable power levels:	<input type="checkbox"/> Conducted	<input checked="" type="checkbox"/> EIRP	
Integral antenna gain:	22.00 dBi		
Frequency (GHz)	Highest setting ( $P_{high}$ ): (dBm)		
	Modulation	Data Rate (Gb/s)	AV Power(dBm)
62.64	QPSK	0.952	31.49
Frequency (GHz)	Modulation	Data Rate (Gb/s)	Peak Power(dBm)
62.64	QPSK	0.952	38.15



1.1.7 Extreme Operating

The Extreme Operating Temperature Range that Apply to the Equipment	
<input type="checkbox"/>	-20 °C to +50 °C
<input checked="" type="checkbox"/>	0 °C to +40 °C
<input type="checkbox"/>	Other:
The nominal voltages of the stand-alone radio equipment or the nominal voltages of the combined (host) equipment or test jig in case of plug-in devices.	
Details provided are for the:	<input checked="" type="checkbox"/> stand-alone equipment
	<input type="checkbox"/> combined (or host) equipment
	<input type="checkbox"/> test jig
Supply Voltage	<input type="checkbox"/> AC mains      State AC voltage      V
Supply Voltage	<input checked="" type="checkbox"/> DC                      State DC voltage    5      V
In case of DC, indicate the type of power source:	
<input type="checkbox"/>	Internal Power Supply
<input checked="" type="checkbox"/>	External Power Supply or AC/DC adapter
<input type="checkbox"/> Battery	<input type="checkbox"/> Nickel Cadmium
	<input type="checkbox"/> Alkaline
	<input type="checkbox"/> Nickel-Metal Hydride
	<input type="checkbox"/> Lithium-Ion
	<input type="checkbox"/> Lead acid (Vehicle regulated)
	<input type="checkbox"/> Other:

1.1.8 Equipment Use Condition

Equipment Use Condition
<input type="checkbox"/> Fixed field disturbance sensors at 61-61.5GHz
<input type="checkbox"/> Except fixed field disturbance sensors at 61-61.5GHz
<input checked="" type="checkbox"/> Except fixed field disturbance sensors

## 1.2 Additional Information Provided by the Submitter

### 1.2.1 Modulation

Modulation	
ITU Class of emission	G1D (BPSK, QPSK), OFDM LRP – BPSK at 20.337 Mb/s (FEC 1/3) HRP – QPSK at 0.952 Gb/s (Quarter Rate), QPSK at 1.904 Gb/s (Half Rate) D1D (16QAM), OFDM HRP – 16-QAM at 3.807 Gb/s (Full Rate)
Can the transmitter operate un-modulated:	<input checked="" type="checkbox"/> Yes <input type="checkbox"/> No

### 1.2.2 Duty Cycle

Duty Cycle			
The transmitter is intended for:	<input checked="" type="checkbox"/>	Continuous Duty:	HRP: 97.09 %
	<input checked="" type="checkbox"/>	Continuous Duty:	LRP: 25.25 %
	<input type="checkbox"/>	Intermittent Duty:	%
	<input type="checkbox"/>	Continuous operation possible for testing purposes	

### 1.2.3 About the EUT

About the EUT	
<input checked="" type="checkbox"/>	The equipment submitted are representative production models.
<input type="checkbox"/>	If not, the equipment submitted are pre-production models
<input type="checkbox"/>	If pre-production equipment is submitted, the final production equipment will be identical in all respects with the equipment tested.
<input type="checkbox"/>	If not, supply full details:



### 1.3 Ancillary and/or Support Equipment

Ancillary Equipment (AE)				
Item	Equipment	Brand Name	Model Name	Serial No.
AE01	AC Power Adapter	Bestec	BT-AG1005AE	-

Support Equipment (SE)				
Item	Equipment	Brand Name	Model Name	Serial No.
SE01	LCD Monitor	DELL	1704FPTt	LM-A
SE02	PS3	SONY	CECH-2007A	-
SE03	WirelessHD Module	AzureWave	AW-WH029	-

### 1.4 EUT Setups

High Definition Audio / Video in the 1080p format was sent from the TX device to the receiver via the wireless link. A Blu-Ray player furnished HD A/V to the TX device. The receiver furnished HD A/V to the television. The television was placed outside the chamber. A laptop computer with test software was utilized to vary the radio configuration and antenna beam orientation for testing purposes. This computer was not connected during measurements. For Extreme environmental tests, an external Variable DC power supply was utilized in place of the AC/DC adapter to furnish power to the EUT.

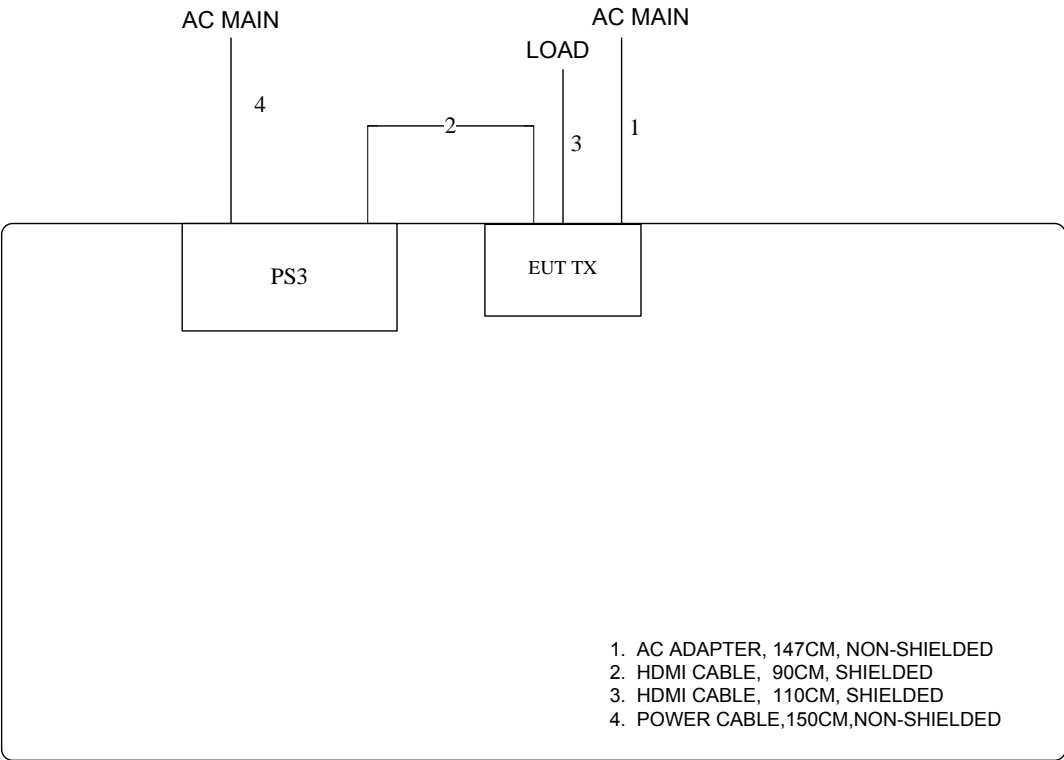
Setup No.	Combination of EUT with AE or SE	Description
Setup_01	EUT + AE01 + SE01 + SE02 + SE03	Setup for radiated emission below 1GHz
 <p>1. AC ADAPTER, 147CM, NON-SHIELDED  2. HDMI CABLE, 90CM, SHIELDED  3. HDMI CABLE, 110CM, SHIELDED  4. POWER CABLE, 150CM, NON-SHIELDED</p>		

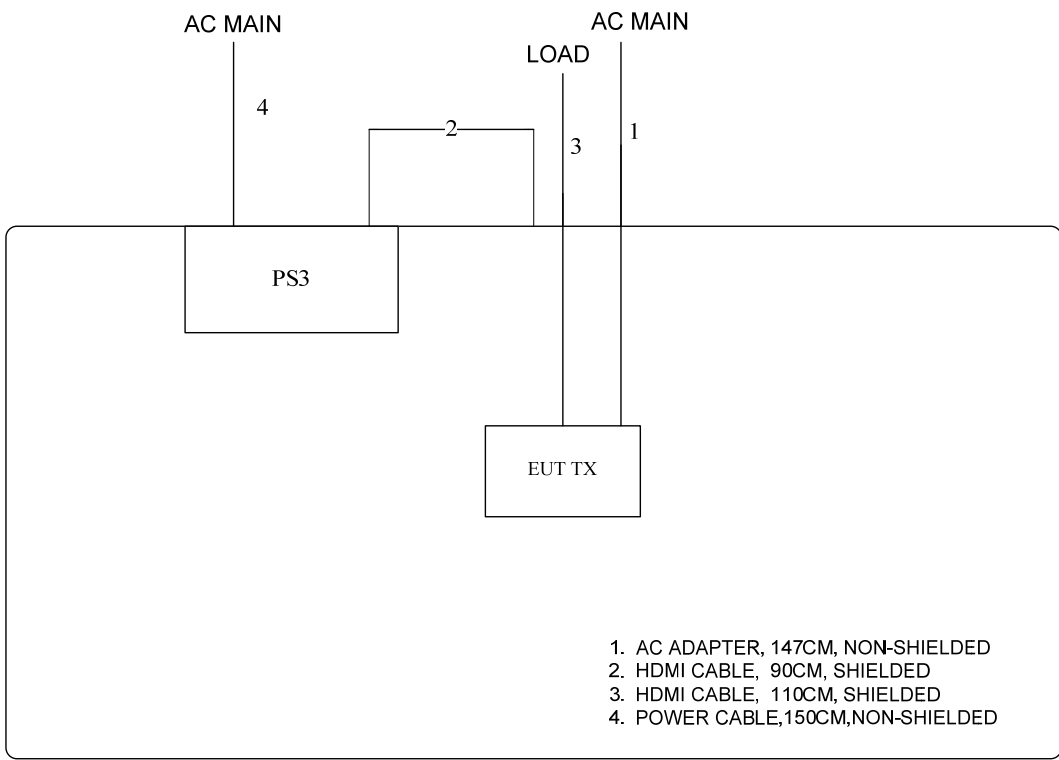
Setup No.	Combination of EUT with AE or SE	Description
Setup_01	EUT + AE01 + SE01 + SE02 +SE03	Setup for radiated emission above 1GHz
 <p>AC MAIN</p> <p>AC MAIN</p> <p>LOAD</p> <p>4</p> <p>2</p> <p>3</p> <p>1</p> <p>PS3</p> <p>EUT TX</p> <p>1. AC ADAPTER, 147CM, NON-SHIELDED 2. HDMI CABLE, 90CM, SHIELDED 3. HDMI CABLE, 110CM, SHIELDED 4. POWER CABLE, 150CM, NON-SHIELDED</p> <p>AC MAIN</p> <p>AC MAIN</p> <p>4</p> <p>2</p> <p>4</p> <p>RX</p> <p>TV</p>		

Setup No.	Combination of EUT with AE or SE	Description
Setup_02	EUT + AE01 + SE01 +SE02+SE03	Setup for AC power conducted emission

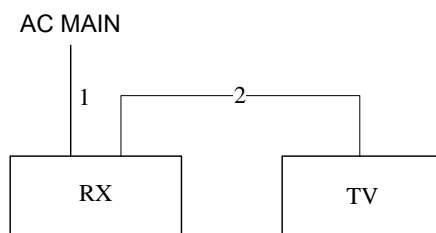
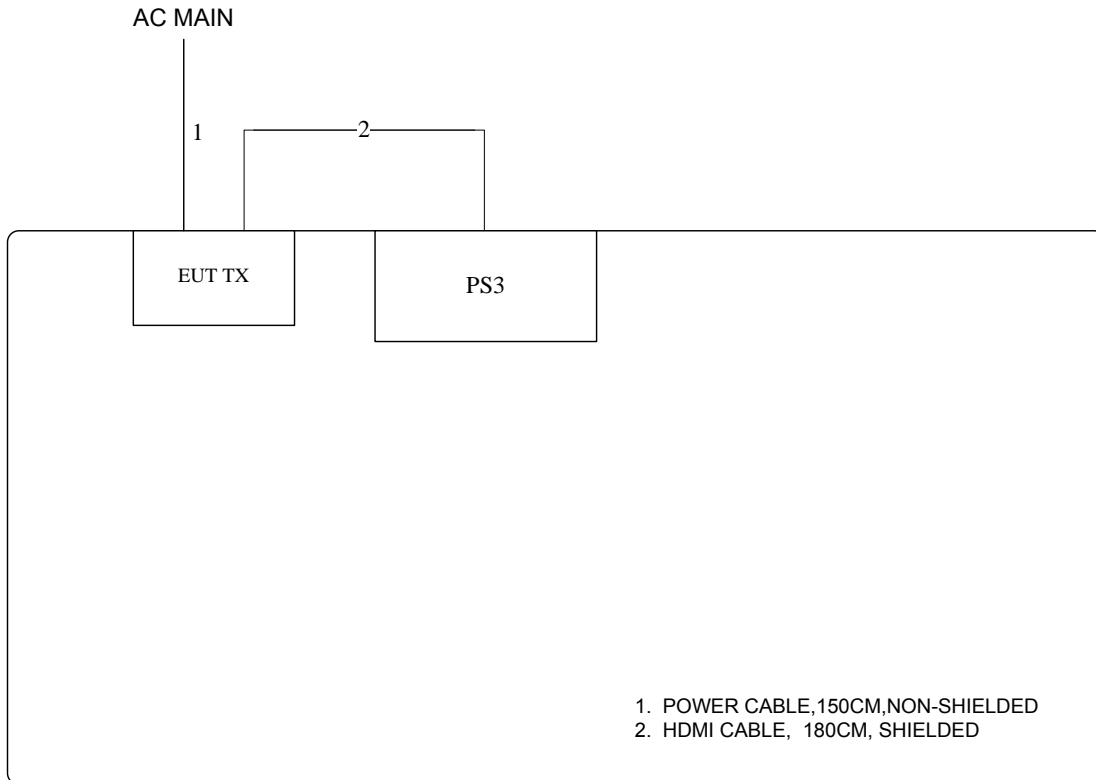



### 1.5 Testing Applied Standards

According to the specifications of the manufacturer, the EUT must comply with the requirements of the following standards:

- ♦ 47 CFR FCC Part 15.255
- ♦ ANSI C63.10-2009

### 1.6 Testing Location

Testing Location			
<input type="checkbox"/>	HWA YA	ADD : No. 52, Hwa Ya 1st Rd., Kwei-Shan Hsiang, Tao Yuan Hsien, Taiwan, R.O.C. TEL : 886-3-327-3456      FAX : 886-3-318-0055	
<input checked="" type="checkbox"/>	JHUBEI	ADD : No.8, Lane 724, Bo-ai St., Jhubei City, HsinChu County 302, Taiwan, R.O.C. TEL : 886-3-656-9065      FAX : 886-3-656-9085	
Testing Site No.			
CO01-CB	TH01-CB	03CH01-CB	

### 1.7 Abbreviations Used for the Test Report

- ♦ Test Channel: B (Bottom channel), M (Middle channel), and T (Top channel).
- ♦ EUT: Equipment under Test.
- ♦ AE: EUT's Ancillary Equipment
- ♦ SE: Testing Support Equipment
- ♦ LRP: Low-rate PHY
- ♦ HRP: High rate PHY

## 2 Test Configuration of Equipment under Test

### 2.1 Test Channel Frequencies

Nominal Channel Bandwidth 1				
Frequency Band	Channel Plan	B (Bottom channel)	M (Middle channel)	T (Top channel)
60.32 – 60.64 GHz	1 (LRP)	60.32 GHz (F1)	60.48 GHz (F2)	60.64 GHz (F3)
60.48 GHz	2 (HRP)	-	60.48 GHz (F4)	-
62.48 – 62.80 GHz	3 (LRP)	62.48 GHz (F1)	62.64 GHz (F2)	62.80 GHz (F3)
62.64 GHz	4 (HRP)	-	62.64 GHz (F4)	-

### 2.2 Conformance Tests and Related Test Frequencies

Test	Test frequencies (MHz)	
	LRP – Channel Plan 1&3 ( 60.32 GHz to 60.64 GHz)/ (62.48GHz to 62.80GHz)	HRP – Channel Plan 2&4 ( 60.48 GHz)/(62.64GHz)
AC Power Conducted Emissions	-	F4
Occupied Bandwidth	F1, F2, F3	F4
Power Density	F1, F2, F3	F4
Peak Conducted Power	F1, F2, F3	F4
Transmitter Spurious Emissions	-	F4
Frequency Stability	-	F4

F1: The centre frequency of the lowest declared channel for every declared nominal bandwidth within this band.

F2, F4: The centre frequency of the middle declared channel for every declared nominal bandwidth within this band.

F3: The centre frequency of the highest declared channel for every declared nominal bandwidth within this band.

### 3 Transmitter Test Result

#### 3.1 AC Power Conducted Emissions

##### 3.1.1 Limit of AC Power Conducted Emissions

AC Power Conducted Emissions Limit		
Frequency Emission (MHz)	Quasi-Peak	Average
0.15-0.5	66 - 56 *	56 - 46 *
0.5-5	56	46
5-30	60	50

Note: \* Decreases with the logarithm of the frequency.

##### 3.1.2 Measuring Instruments

Refer a measuring instruments list in this test report.

##### 3.1.3 Test Procedures

Method of measurement: Refer as ANSI C63.10-2009, clause 6.2.

##### 3.1.4 Test Setup

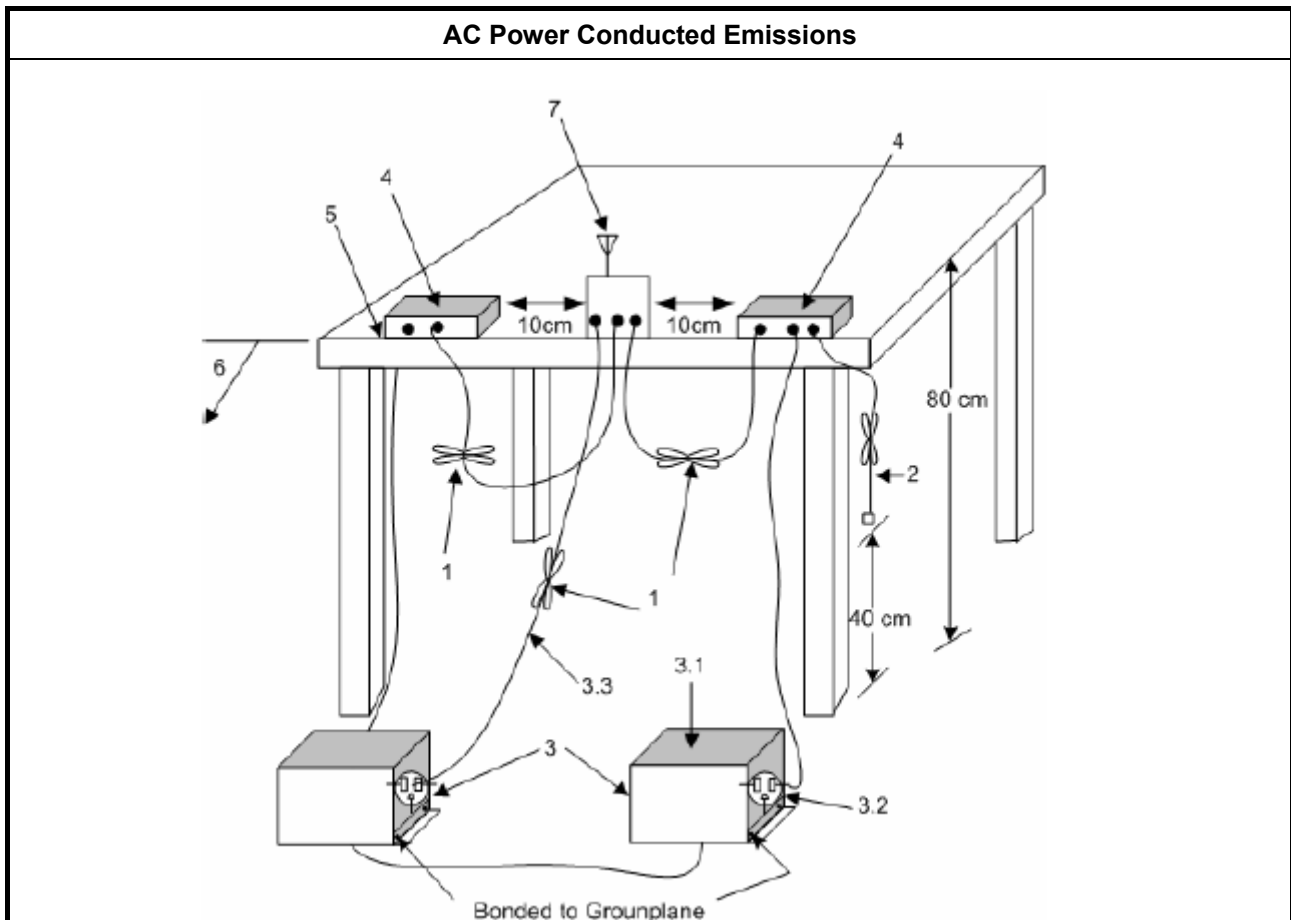

<b>AC Power Conducted Emissions</b>	
1.	Interconnecting cables that hang closer than 40 cm to the ground plane shall be folded back and forth in the center forming a bundle 30 cm to 40 cm long (see ANSI C63.10, clause 6.2.3.1).
2.	I/O cables that are not connected to an accessory shall be bundled in the center. The end of the cable may be terminated, if required, using the correct terminating impedance. The overall length shall not exceed 1 m (see ANSI C63.10, clause 6.2.2).
3.	EUT connected to one LISN. Unused LISN measuring port connectors shall be terminated in 50 ohm loads. LISN can be placed on top of, or immediately beneath, reference ground plane (see ANSI C63.10, clauses 6.2.2 and 6.2.3). 3.1. All other equipment powered from additional LISN(s). 3.2. A multiple-outlet strip can be used for multiple power cords of non-EUT equipment. 3.3. LISN at least 80 cm from nearest part of EUT chassis.
4.	Non-EUT components of EUT system being tested.
5.	Rear of EUT, including peripherals, shall all be aligned and flush with edge of tabletop (see ANSI C63.10, clause 6.2.3.1).
6.	Edge of tabletop shall be 40 cm removed from a vertical conducting plane that is bonded to the ground plane (see ANSI C63.10, clause 6.2.2 for options).
7.	Antenna may be integral or detachable. If detachable, the antenna shall be attached for this test.

**3.1.5 Test Result of AC Power Conducted Emissions**

<b>Test Conditions:</b>	see ANSI C63.10, clause 5.11
<b>Test Setup:</b>	see ANSI C63.10, clause 6.2.3
<b>Test Frequency Band:</b>	60.48 GHz (HRP) Band
<p>NOTE 1: If equipment having different channel plan and nominal channel bandwidth modes (see test report clause 1.1.1), the measurements are uninfluenced by different channel plan and nominal channel bandwidth modes, may not need to be repeated for all modes. If equipment having different transmit operating modes (see test report clause 1.1.2), the measurements are uninfluenced by different transmit operating modes, may not need to be repeated for all the operating modes. Similar, if the equipment supports different modulations and/or data rates, the measurements described in ANSI C63.10, clause 5.12 may not need to be repeated for all these modulations and data rates. Simple comparison of engineering test across all operating modes, modulations and data rates may need to be performed to define the worse case combination to be used for the conformance testing.</p> <p>NOTE 2: “&gt;20dB” means the tables in this clause should only list values of spurious emissions that exceed the level of 20 dB below the applicable limit, see ANSI C63.4, clause 10.1.8.1.</p>	





Temp:	23 °C	Humidity:	58%
Test Engineer:	Sin Chang	Phase:	Neutral
Configuration	Normal Link		

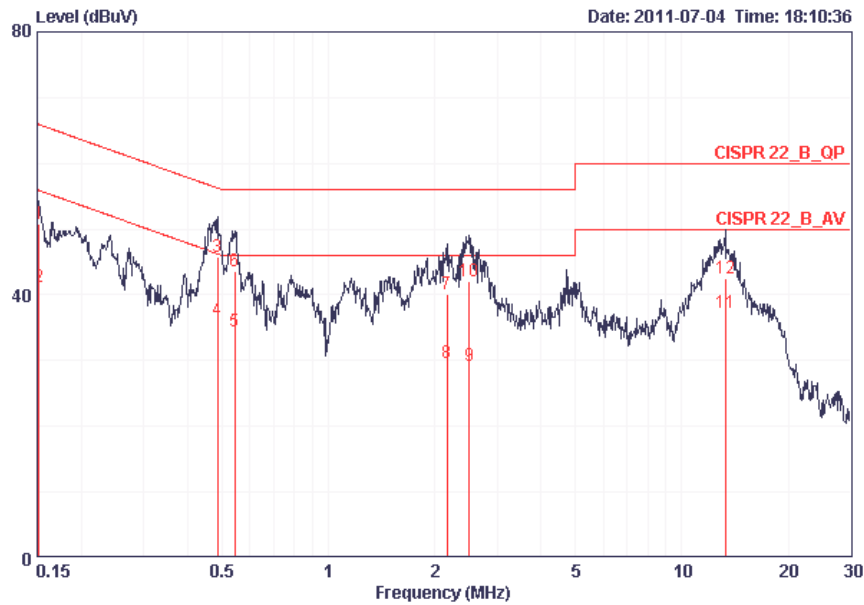

	Freq	Level	Over Limit	Limit Line	Read Level	LISN Factor	Cable Loss	Remark
	MHz	dBuV	dB	dBuV	dBuV	dB	dB	
1	0.15160	50.71	-15.20	65.91	50.41	0.10	0.20	QP
2	0.15160	41.24	-14.67	55.91	40.94	0.10	0.20	AVERAGE
3	0.48632	45.84	-10.39	56.23	45.66	0.07	0.11	QP
4	0.48632	36.24	-9.99	46.23	36.06	0.07	0.11	AVERAGE
5	0.54355	34.54	-11.46	46.00	34.27	0.07	0.20	AVERAGE
6	0.54355	43.66	-12.34	56.00	43.39	0.07	0.20	QP
7	2.167	40.22	-15.78	56.00	39.92	0.10	0.20	QP
8	2.167	29.55	-16.45	46.00	29.25	0.10	0.20	AVERAGE
9	2.500	29.18	-16.82	46.00	28.87	0.11	0.20	AVERAGE
10	2.500	42.18	-13.82	56.00	41.87	0.11	0.20	QP
11	13.267	37.25	-12.75	50.00	36.33	0.52	0.40	AVERAGE
12	13.267	42.45	-17.55	60.00	41.53	0.52	0.40	QP

Measurement uncertainty: ±2.26 dB



Temp:	23 °C	Humidity:	58%
Test Engineer:	Sin Chang	Phase:	Line
Configuration	Normal Link		

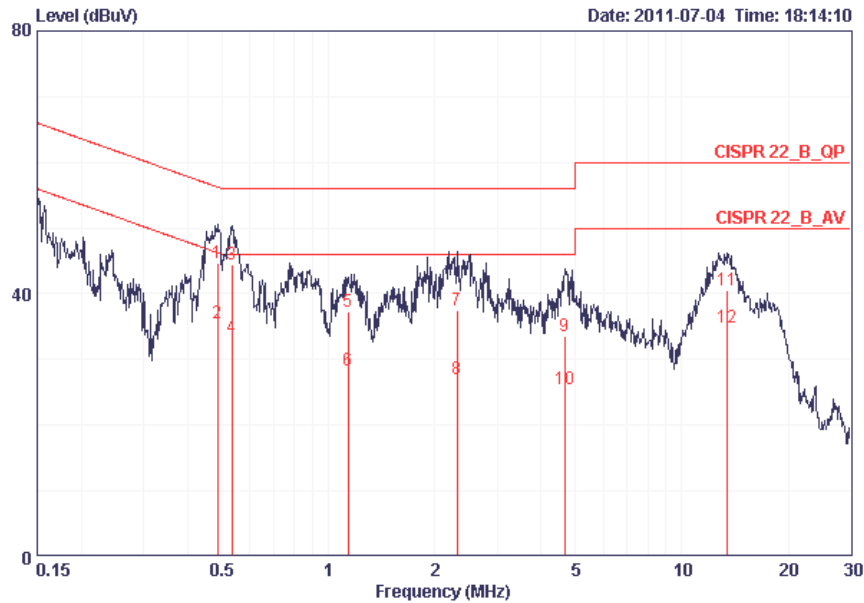

	Freq	Level	Over Limit	Limit Line	Read Level	LISN Factor	Cable Loss	Remark
	MHz	dBuV	dB	dBuV	dBuV	dB	dB	
1	0.48632	44.75	-11.48	56.23	44.61	0.03	0.11	QP
2	0.48632	35.62	-10.61	46.23	35.48	0.03	0.11	AVERAGE
3	0.53215	44.41	-11.59	56.00	44.18	0.03	0.20	QP
4	0.53215	33.25	-12.75	46.00	33.02	0.03	0.20	AVERAGE
5	1.135	37.34	-18.66	56.00	37.14	0.03	0.17	QP
6	1.135	28.25	-17.75	46.00	28.05	0.03	0.17	AVERAGE
7	2.309	37.49	-18.51	56.00	37.23	0.06	0.20	QP
8	2.309	27.07	-18.93	46.00	26.81	0.06	0.20	AVERAGE
9	4.672	33.62	-22.38	56.00	33.18	0.14	0.30	QP
10	4.672	25.42	-20.58	46.00	24.98	0.14	0.30	AVERAGE
11	13.479	40.65	-19.35	60.00	39.75	0.50	0.40	QP
12	13.479	34.83	-15.17	50.00	33.93	0.50	0.40	AVERAGE

Measurement uncertainty: ±2.26 dB

### 3.2 Occupied Bandwidth

#### 3.2.1 Limit of Occupied Bandwidth

<b>6dBc Bandwidth</b> (see Note 1)	None
<b>26dBc Bandwidth</b>	None
<b>99% Occupied Bandwidth</b> (see Note 2)	None

NOTE 1: Refer as FCC 15.255(e). The 6dBc bandwidth is the frequency bandwidth of the signal power at the -6 dBc points when measured with a 100 kHz resolution bandwidth. These measurements shall also be performed at normal test conditions.

NOTE 2: The 99% occupied bandwidth is the frequency bandwidth of the signal power at the 99% channel power of occupied bandwidth when resolution bandwidth should be approximately 1 % to 5 % of the occupied bandwidth (OBW). These measurements shall also be performed at normal test conditions.

#### 3.2.2 Measuring Instruments

Refer a measuring instruments list in this test report.

#### 3.2.3 Test Procedures

Method of measurement: Refer as ANSI C63.10-2009, clauses 6.9.1 and 7.8.5.

#### 3.2.4 Test Setup

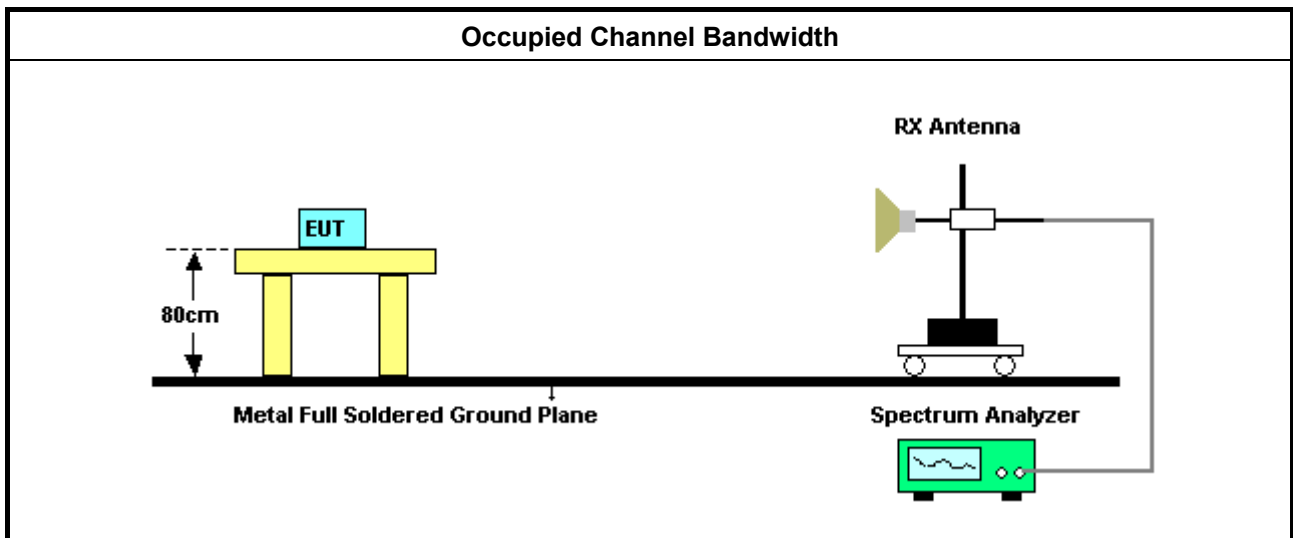



**3.2.5 Test Result of Occupied Bandwidth**

<b>Test Conditions:</b>	see ANSI C63.10, clause 5.11
<b>Test Setup:</b>	see ANSI C63.10, clause 7.8.5
<b>Test Frequency Band:</b>	60.32 – 60.64 GHz /62.48 – 62.80(LRP) Band 60.48 GHz / 62.64GHz (HRP) Band
<p>NOTE: If equipment having different transmit operating modes (see test report clause 1.1.2), the measurements are uninfluenced by different transmit operating modes, may not need to be repeated for all the operating modes. Similar, if the equipment supports different modulations and/or data rates, the measurements described in ANSI C63.10, clause 5.12 may not need to be repeated for all these modulations and data rates. Simple comparison of engineering test across all operating modes, modulations and data rates may need to be performed to define the worse case combination to be used for the conformance testing. Refer as ANSI C63.10, clause 6.9.1, observe and record with plotted graphs or photographs the worst-case (i.e., widest) occupied bandwidth produced by these different modulation sources.</p>	

<b>Test Conditions:</b>	see ANSI C63.10, clause 5.12	<b>Rel. Humidity:</b>	50 %		
<b>Test Engineer:</b>	Sam Chen	<b>Ambient Temp.:</b>	24°C		
<b>Test Date:</b>	Jul. 02, 2011	<b>Test Conditions:</b>	0.5 m		
<b>Test results</b>					
Test Frequency:	6 dBc Bandwidth (MHz)	Occupied Bandwidth (MHz)	26 dBc Bandwidth (MHz)	Limit (MHz)	Margin (MHz)
F1 60.32 GHz	90.60	272.00	407.00	NA	NA
F2 60.48 GHz	91.20	254.00	361.00	NA	NA
F3 60.64 GHz	92.40	244.00	340.00	NA	NA
F4 60.48 GHz	1760.00	1770.00	1930.00	NA	NA
F1 62.48 GHz	91.80	254.00	361.00	NA	NA
F2 62.64 GHz	91.20	248.00	345.00	NA	NA
F3 62.80 GHz	91.80	249.00	334.00	NA	NA
F4 62.64 GHz	1750.00	1760.00	2030.00	NA	NA
<b>Measurement uncertainty:</b>	$\pm 8.5 \times 10^{-8}$ Hz				



3.2.5.1 Bandwidth Plots for 60.32 – 60.64 GHz (LRP) Band

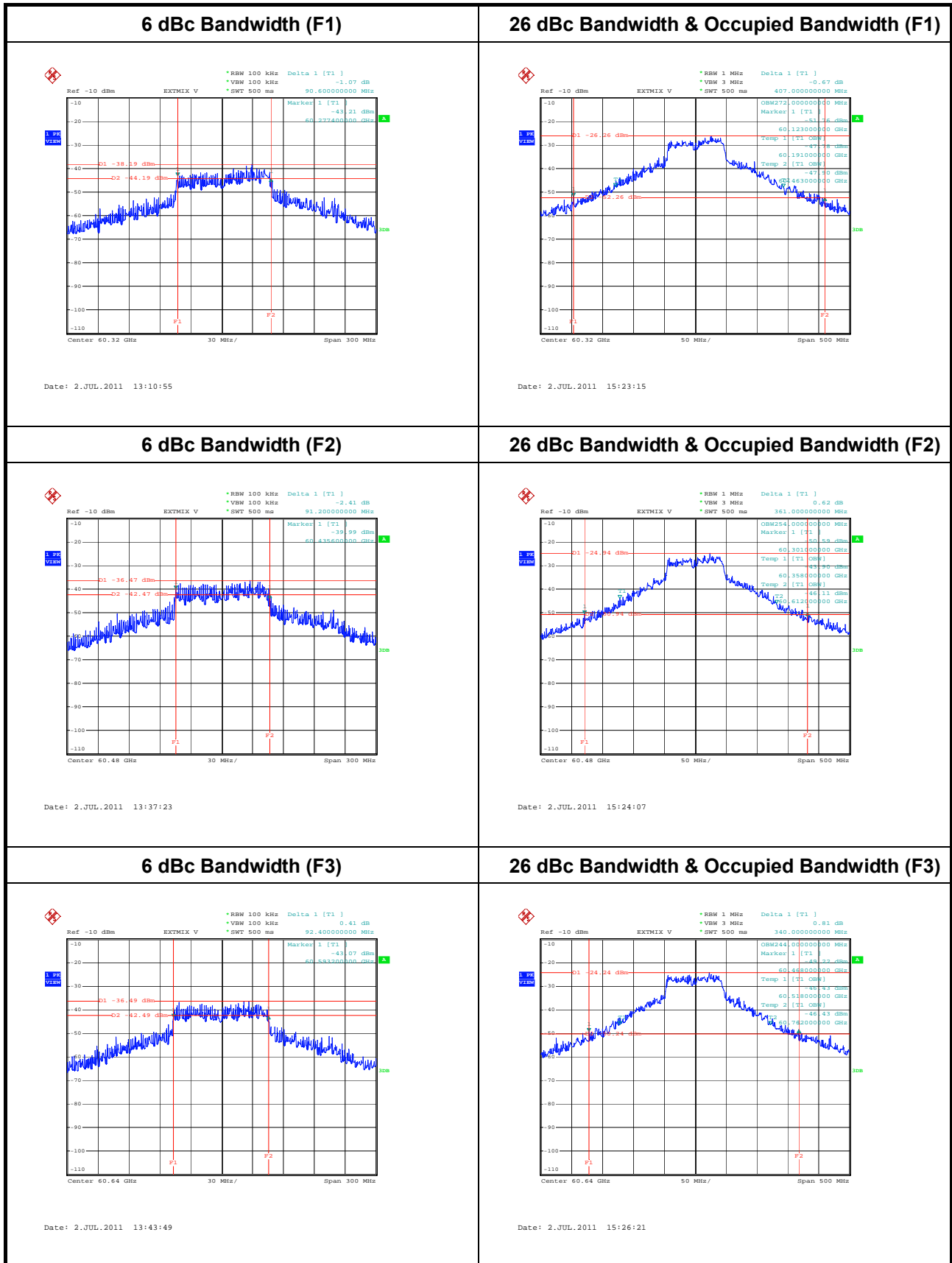



3.2.5.2 Bandwidth Plots for 60.48 GHz (HRP) Band

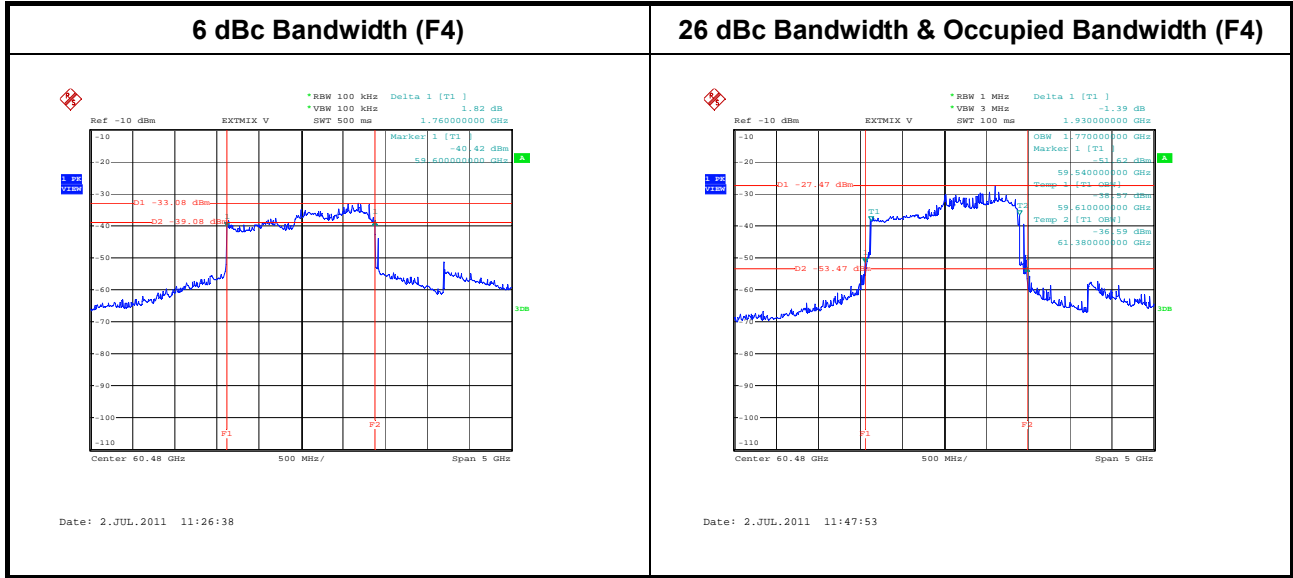

3.2.5.3 Bandwidth Plots for 62.48 – 62.80 GHz (LRP) Band

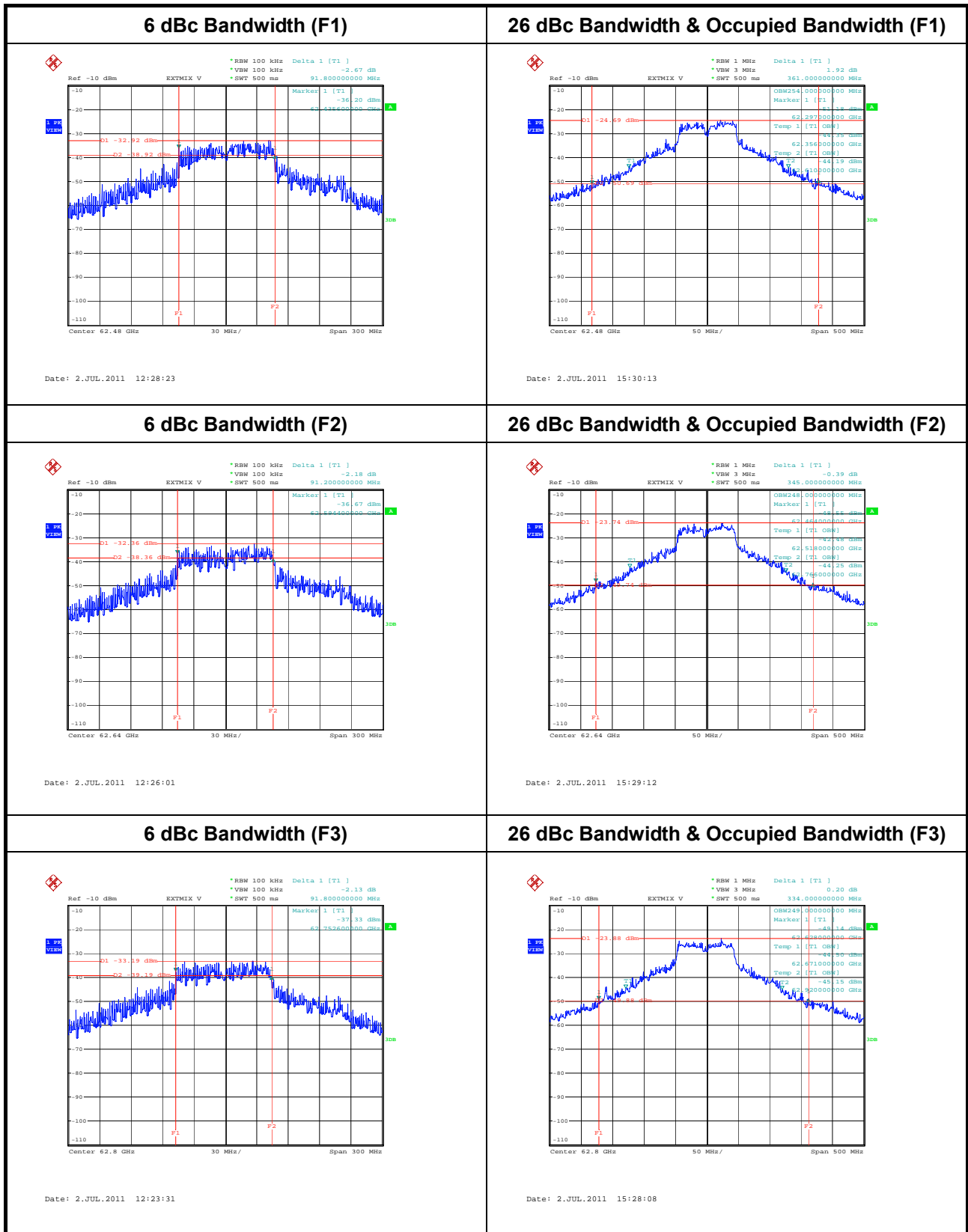



### 3.2.5.4 Bandwidth Plots for 62.64 GHz (HRP) Band

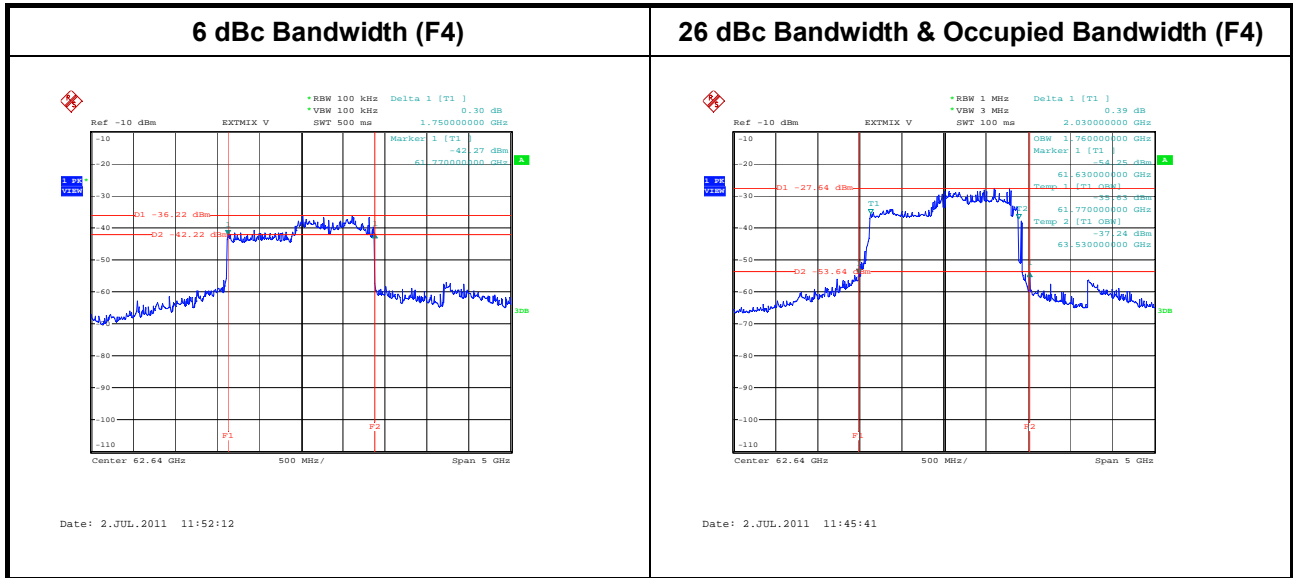



### 3.3 EIRP Power and Power Density

#### 3.3.1 Limit of EIRP Power and Power Density

Power Density Limit		
Use Condition	EIRP Average Power Density	EIRP Peak Power Density
Fixed field disturbance sensors at 61-61.5GHz	9 nW/cm <sup>2</sup> equivalent 10.2 mW (10.08 dBm)	18 nW/cm <sup>2</sup> equivalent 10.2 mW (13.09 dBm)
Except fixed field disturbance sensors at 61-61.5GHz	N/A	9 nW/cm <sup>2</sup> equivalent 10.2 mW (10.08 dBm)
Except fixed field disturbance sensors	9 μW/cm <sup>2</sup> equivalent 10.2 mW (40.08 dBm)	18 μW/cm <sup>2</sup> equivalent 10.2 mW (43.08 dBm)

NOTE: For the applicable limit, see FCC 15.255 (b)

#### 3.3.2 Measuring Instruments

Refer a measuring instruments list in this test report.

#### 3.3.3 Test Procedures

Method of measurement: Refer as ANSI C63.10-2009, clauses 7.8.3 and 7.8.6.

#### 3.3.4 Test Setup

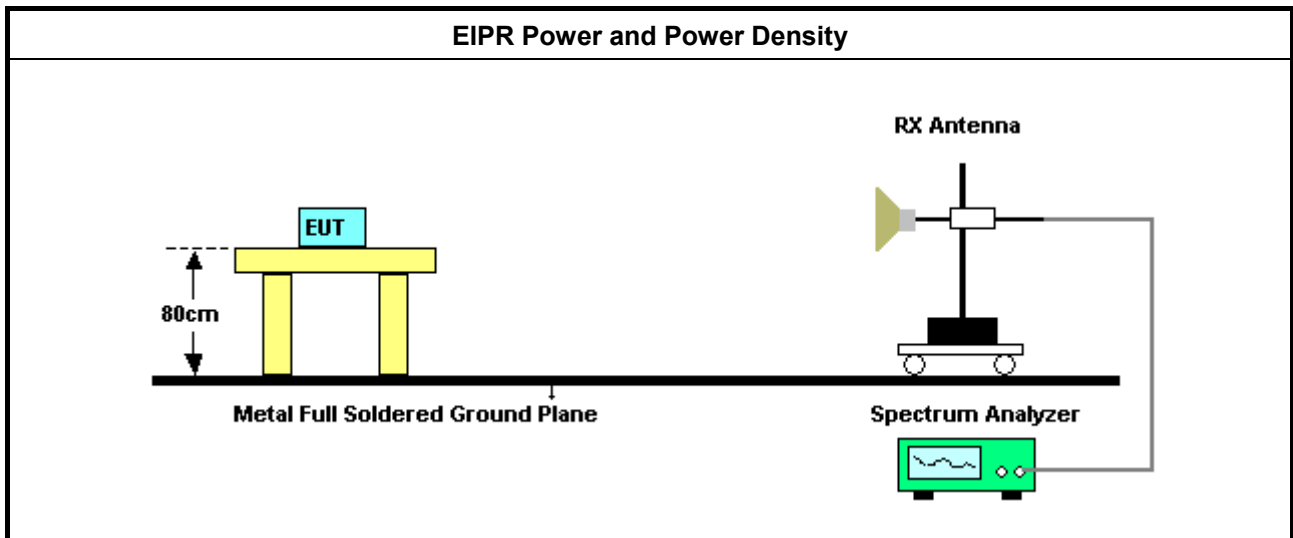



### 3.3.5 Test Result of EIRP Power and Power Density

<b>Test Conditions:</b>	see ANSI C63.10, clause 5.11
<b>Test Setup:</b>	see ANSI C63.10, clause 7.8.6
<b>Test Frequency Band:</b>	60.32 – 60.64 GHz /62.48 – 62.80(LRP) Band 60.48 GHz / 62.64GHz (HRP) Band
NOTE: If the equipment supports different modulations and/or data rates, the measurements described in ANSI C63.10, clause 5.12 may not need to be repeated for all these modulations and data rates. Simple comparison of engineering test across all operating modes, modulations and data rates may need to be performed to define the worse case combination to be used for the conformance testing.	



3.3.5.1 Test Result of EIRP Power

<b>Maximum Antenna Gain:</b>		16	dBi for 60.32 – 60.64 GHz /62.48 – 62.80(LRP) Band							
<b>Maximum Antenna Gain:</b>		22	dBi for 60.48 GHz / 62.64GHz (HRP) Band							
<b>Equipment Use Condition:</b>		<input type="checkbox"/> Fixed field disturbance sensors at 61-61.5GHz <input type="checkbox"/> Except fixed field disturbance sensors at 61-61.5GHz <input checked="" type="checkbox"/> Except fixed field disturbance sensors								
<b>Test Conditions:</b>		0.5 m			<b>Rel. Humidity:</b>		50 %			
<b>Test Engineer:</b>		Sam Chen			<b>Ambient Temp.:</b>		24°C			
<b>Test Date:</b>		Jul. 02, 2011								
<b>Test results</b>										
Test Frequency:	Measured Power (dBm)		EIRP (dBm)		EIRP Limit (dBm) (note 2)		Margin (dB)			
	AV	Peak	AV	Peak	AV	Peak	AV	Peak	AV	Peak
<b>F1 60.32 GHz</b>	-22.35	-11.62	22.66	27.41	40.08	43.08	17.42	15.67		
<b>F2 60.48 GHz</b>	-22.12	-11.45	22.91	27.60	40.08	43.08	17.17	15.48		
<b>F3 60.64 GHz</b>	-22.25	-11.42	22.80	27.66	40.08	43.08	17.28	15.42		
<b>F4 60.48 GHz</b>	-8.75	-1.31	30.43	37.74	40.08	43.08	9.65	5.34		
<b>F1 62.48 GHz</b>	-22.42	-11.18	22.89	28.16	40.08	43.08	17.19	14.92		
<b>F2 62.64 GHz</b>	-22.20	-11.41	23.14	27.95	40.08	43.08	16.94	15.13		
<b>F3 62.80 GHz</b>	-22.09	-11.42	23.27	27.96	40.08	43.08	16.81	15.12		
<b>F4 62.64 GHz</b>	-8.00	-1.21	31.49	38.15	40.08	43.08	8.59	4.93		
<b>Measurement uncertainty:</b>		±2.7 dB								
<p>The measured power level is converted to EIRP using the Friis equation:</p> $EIRP = P_T * G_T = (P_R / G_R) * (4 * \pi * D / \lambda)^2$ <p><math>P_R</math> = measured channel power  <math>G_R</math> = 23 dBi, The gain of the receive measurement antenna  <math>D</math> = 0.5 m, The measurement distance  <math>\lambda</math> = The wavelength.</p> <p>NOTE 2: For the applicable limit, see FCC 15.255(b)          NOTE 3: AV is average EIRP power.</p>										



3.3.5.2 Test Result of EIRP Power Density

<b>Maximum Antenna Gain:</b>		16	dBi for 60.32 – 60.64 GHz /62.48 – 62.80(LRP) Band							
<b>Maximum Antenna Gain:</b>		22	dBi for 60.48 GHz / 62.64GHz (HRP) Band							
<b>Equipment Use Condition:</b>		<input type="checkbox"/> Fixed field disturbance sensors at 61-61.5GHz <input type="checkbox"/> Except fixed field disturbance sensors at 61-61.5GHz <input checked="" type="checkbox"/> Except fixed field disturbance sensors								
<b>Test Conditions:</b>		0.5 m			<b>Rel. Humidity:</b>		50 %			
<b>Test Engineer:</b>		Sam Chen			<b>Ambient Temp.:</b>		24°C			
<b>Test Date:</b>		Jul. 02, 2011								
Test results										
Test Frequency:	EIRP Power (dBm) (note 1)		EIRP Power Density (μW/cm <sup>2</sup> )		EIRP Power Density Limit (μW/cm <sup>2</sup> )		Margin (μW/cm <sup>2</sup> )			
	AV	Peak	AV	Peak	AV	Peak	AV	Peak		
F1 60.32 GHz	22.66	27.41	0.16	0.49	9.00	18.00	8.84	17.51		
F2 60.48 GHz	22.91	27.60	0.17	0.51	9.00	18.00	8.83	17.49		
F3 60.64 GHz	22.80	27.66	0.17	0.52	9.00	18.00	8.83	17.49		
F4 60.48 GHz	30.43	37.74	0.98	5.26	9.00	18.00	8.02	12.74		
F1 62.48 GHz	22.89	28.16	0.17	0.58	9.00	18.00	8.83	17.42		
F2 62.64 GHz	23.14	27.95	0.18	0.55	9.00	18.00	8.82	17.45		
F3 62.80 GHz	23.27	27.96	0.19	0.55	9.00	18.00	8.81	17.45		
F4 62.64 GHz	31.49	38.15	1.25	5.77	9.00	18.00	7.76	12.23		
<b>Measurement uncertainty:</b>		±2.7 dB								
<p>NOTE 1: The EIRP is converted to Power Density using the equation:  <math>PD = EIRP / (4 * \pi * D_s^2)</math>  <math>D_s = 3m</math>, the specification distance</p> <p>NOTE 2: For the applicable limit, see FCC 15.255(b)</p> <p>NOTE 3: AV is average power density.</p>										



3.3.5.3 Measured Power Plots for 60.32 – 60.64 GHz (LRP) Band & 60.48 GHz (HRP) Band

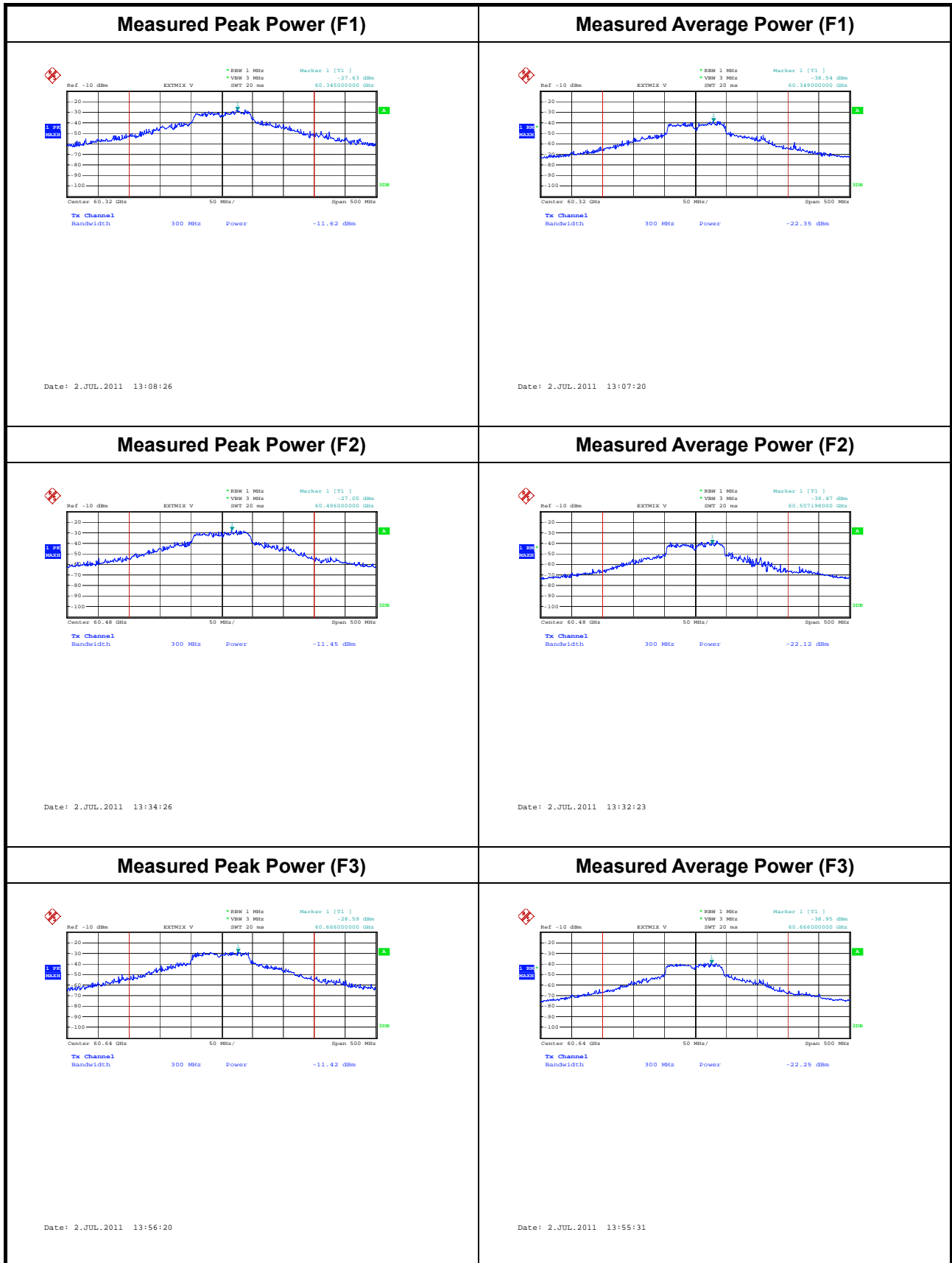



Measured Peak Power (F4)

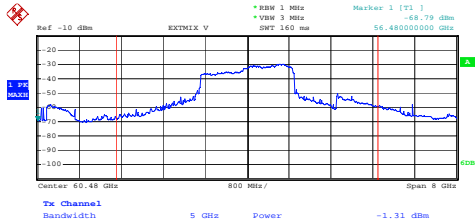

Date: 2.JUL.2011 11:10:51

Measured Average Power (F4)

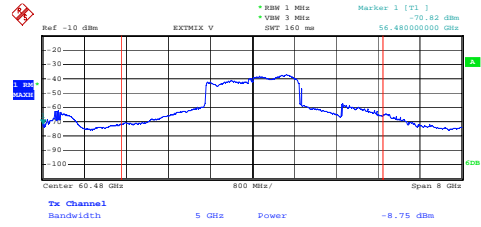

Date: 2.JUL.2011 11:13:40



3.3.5.4 Measured Power Plots for 62.48 – 60.80 GHz (LRP) Band & 62.64 GHz (HRP) Band

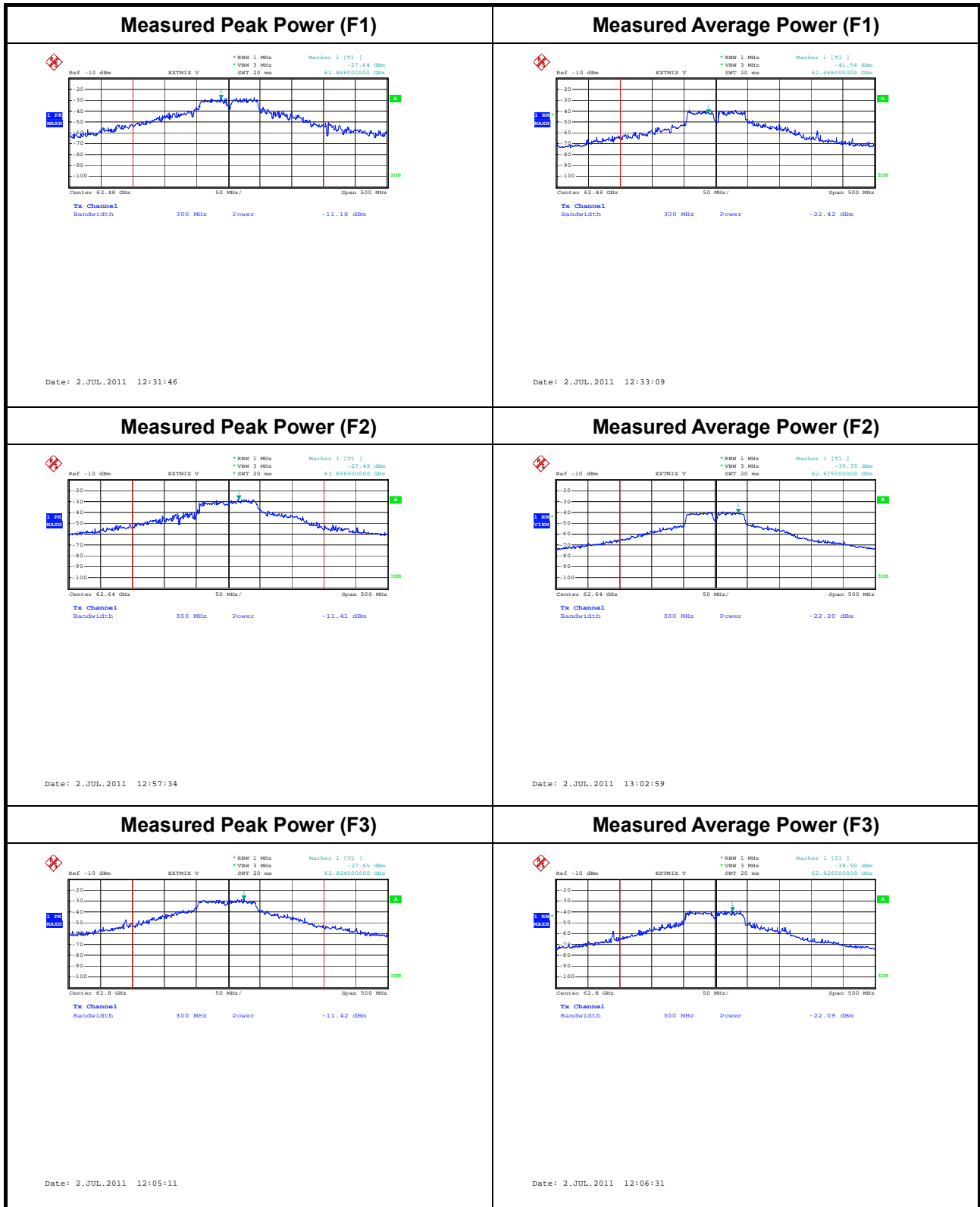



Measured Peak Power (F4)

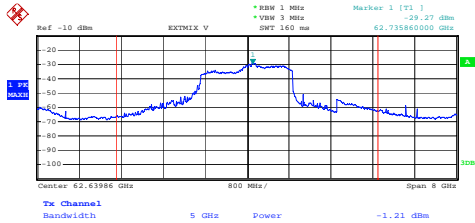

Date: 2.JUL.2011 12:02:10

Measured Average Power (F4)

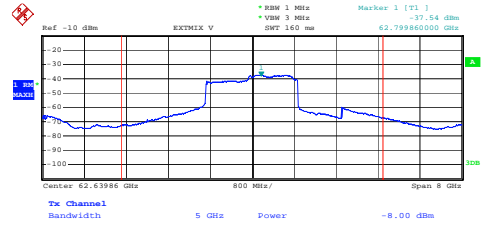

Date: 2.JUL.2011 12:01:02



### 3.4 Peak Conducted Power

#### 3.4.1 Limit of Peak Conducted Power

Peak Conducted Power Limit	
6dBc Bandwidth	Peak Conducted Power (note 1)
> 100MHz	500mW
≤ 100MHz	500mW x (B/100) (see note 2)

NOTE 1: For the applicable limit, see FCC 15.255(e)  
 NOTE 2: B= 6dB bandwidth (measured at RBW 100kHz)

#### 3.4.2 Measuring Instruments

Refer a measuring instruments list in this test report.

#### 3.4.3 Test Procedures

Method of measurement: Refer as ANSI C63.10-2009, clauses 7.8.3 and 7.8.6.

#### 3.4.4 Test Setup

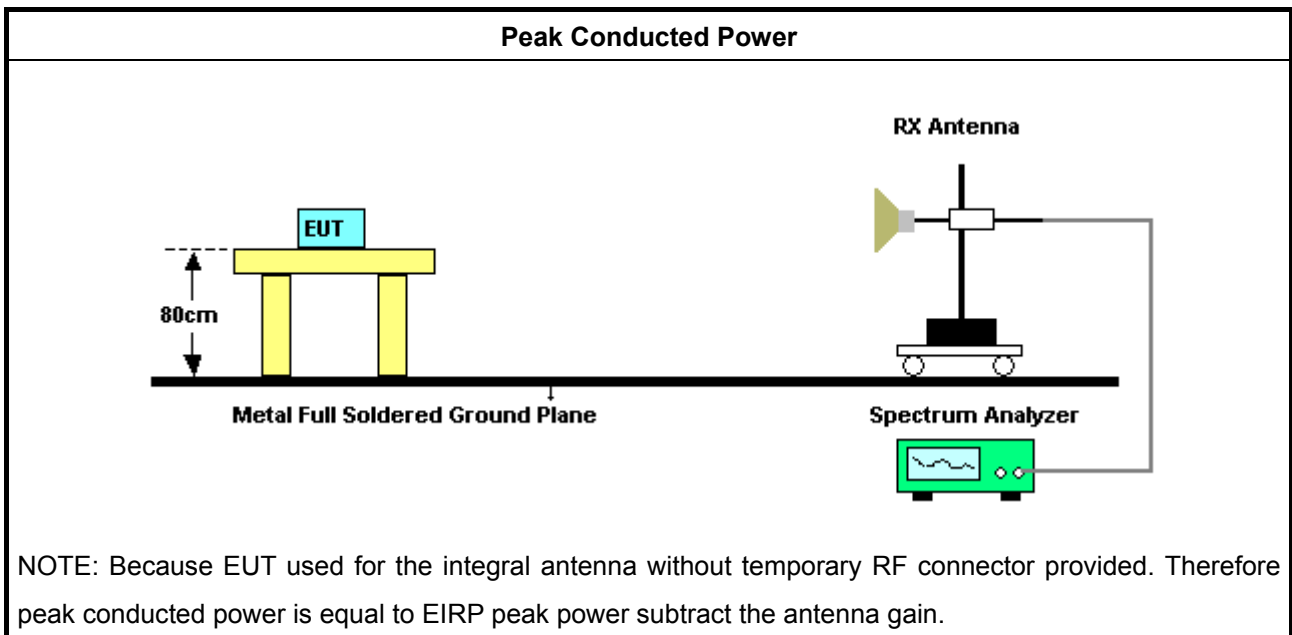



### 3.4.5 Test Result of Peak Conducted Power

<b>Test Conditions:</b>	see ANSI C63.10, clause 5.11
<b>Test Setup:</b>	see ANSI C63.10, clause 7.8.6
<b>Test Frequency Band:</b>	60.32 – 60.64 GHz /62.48 – 62.80(LRP) Band 60.48 GHz / 62.64GHz (HRP) Band
NOTE: If the equipment supports different modulations and/or data rates, the measurements described in ANSI C63.10, clause 5.12 may not need to be repeated for all these modulations and data rates. Simple comparison of engineering test across all operating modes, modulations and data rates may need to be performed to define the worse case combination to be used for the conformance testing.	



3.4.5.1 Peak Conducted Power

<b>Test Conditions:</b> 0.5 m				<b>Rel. Humidity:</b> 50 %					
<b>Test Engineer:</b> Sam Chen				<b>Ambient Temp.:</b> 24°C					
<b>Test Date:</b> Jul. 02, 2011									
Test results									
Test Frequency:		EIRP (dBm)	Max. Ant. Gain	Peak Power (dBm) (note 1)	Peak Power (mW)	6dBc BW (MHz) (note 2)	Peak Power Limit (mW) (note 3)	Margin (mW)	
F1	60.32 GHz	27.41	13.00	14.41	27.61	90.60	453.00	425.39	
F2	60.48 GHz	27.60	13.00	14.60	28.86	91.20	456.00	427.14	
F3	60.64 GHz	27.66	13.00	14.66	29.22	92.40	462.00	432.78	
F4	60.48 GHz	37.74	17.00	20.74	118.67	1,760.00	500.00	381.33	
F1	62.48 GHz	28.16	13.00	15.16	32.78	91.80	459.00	426.22	
F2	62.64 GHz	27.95	13.00	14.95	31.25	91.20	456.00	424.75	
F3	62.80 GHz	27.96	13.00	14.96	31.34	91.80	459.00	427.67	
F4	62.64 GHz	38.15	17.00	21.15	130.26	1,750.00	500.00	369.74	
<b>Measurement uncertainty:</b> ±2.7 dB									
NOTE 1: Because EUT used for the integral antenna without temporary RF connector provided. Therefore peak conducted power is equal to EIRP power subtract the antenna gain.									
NOTE 2: For the 6dBc bandwidth, see test report clause 3.2.5.									
NOTE 3: For the applicable limit, see FCC 15.255(e)									

### 3.5 Transmitter Spurious Emissions

#### 3.5.1 Limit of Transmitter Spurious Emissions

Frequency Range	Limit
Radiated emissions below 40 GHz	FCC Part 15.209
Radiated emissions above 40 GHz – 200GHz	90 pW/cm <sup>2</sup> @ 3 m (Equivalent EIRP 102 μW, -9.91dBm)
NOTE: Spurious emissions shall not exceed the level of the fundamental emission.	

#### 3.5.2 Measuring Instruments

Refer a measuring instruments list in this test report.

#### 3.5.3 Test Procedures

Method of measurement: Refer as ANSI C63.10-2009, clauses 6.3, 6.4, 6.5, 6.6 and 7.8.6.

#### 3.5.4 Test Setup

**Transmitter Spurious Emissions**

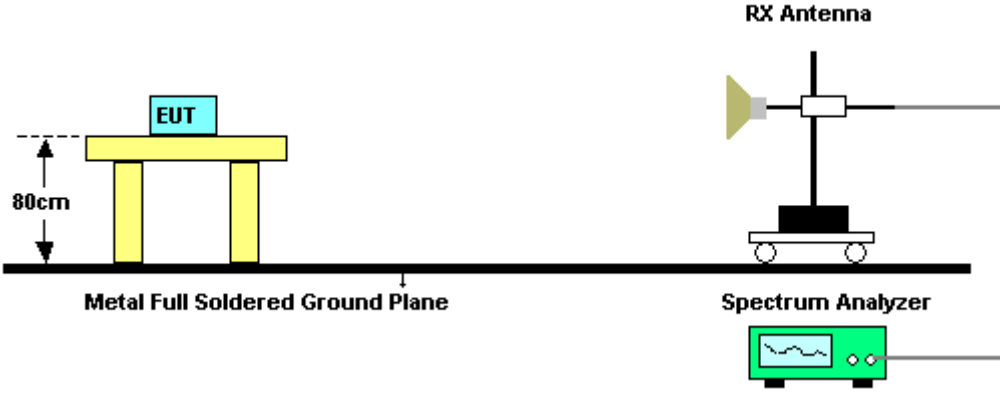

A measuring distance of at 3 m shall be used for measurements at frequencies up to 15 GHz. For frequencies above 15 GHz, any suitable measuring distance may be used. The measurement distance is chosen up to far field distance, depending on the test system noise floor for detecting spurious emission signals. Then above 15 GHz shall be extrapolated to the specified distance using an extrapolation factor of 20 dB/decade from spec. distance (3 m) to measurement distance. Distance extrapolation factor = 20 log (spec. distance [3 m] / measurement distance [N m]) (dB) .The measurements described in ANSI C63.10, clause 7.8.6. If the emission cannot be detected at 1 m, reduce the RBW to increase system sensitivity. Note the value. If the emission still cannot be detected, move the horn closer to the EUT, noting the distance at which a measurement is made.



### **3.5.5 Test Result of Transmitter Spurious Emissions**

<b>Test Conditions:</b>	see ANSI C63.10, clause 5.11
<b>Test Setup:</b>	see ANSI C63.10, clauses 6.3, 6.4, 6.5, 6.6 and 7.8.6
<b>Test Frequency Band:</b>	60.48 GHz (HRP) Band
NOTE: If equipment having different channel plan and nominal channel bandwidth modes (see test report clause 1.1.1), the measurements are uninfluenced by different channel plan and nominal channel bandwidth modes, may not need to be repeated for all modes.	



3.5.5.1 60.48 GHz (HRP) band, Test Frequency F4, Radiated Testing

<b>Test Conditions:</b>	see ANSI C63.10, clause 5.11	<b>Polarization:</b>	Vertical
<b>Test Engineer:</b>	Sam Chen	<b>Test Distance:</b>	3 m
<b>Test Range:</b>	9kHz~30MHz		

Freq. (MHz)	Level (dBuV)	Over Limit (dB)	Limit Line (dBuV)	Remark
-	-	-	-	See Note

Note:

The amplitude of spurious emissions that are attenuated by more than 20dB below the permissible value has no need to be reported.

Distance extrapolation factor =  $40 \log(\text{specific distance} / \text{test distance})$  (dB);

Limit line = specific limits (dBuV) + distance extrapolation factor.



<b>Test Conditions:</b>	see ANSI C63.10, clause 5.11	<b>Polarization:</b>	Vertical
<b>Test Engineer:</b>	Sam Chen	<b>Test Distance:</b>	3 m
<b>Test Range:</b>	30 MHz – 1000 MHz		

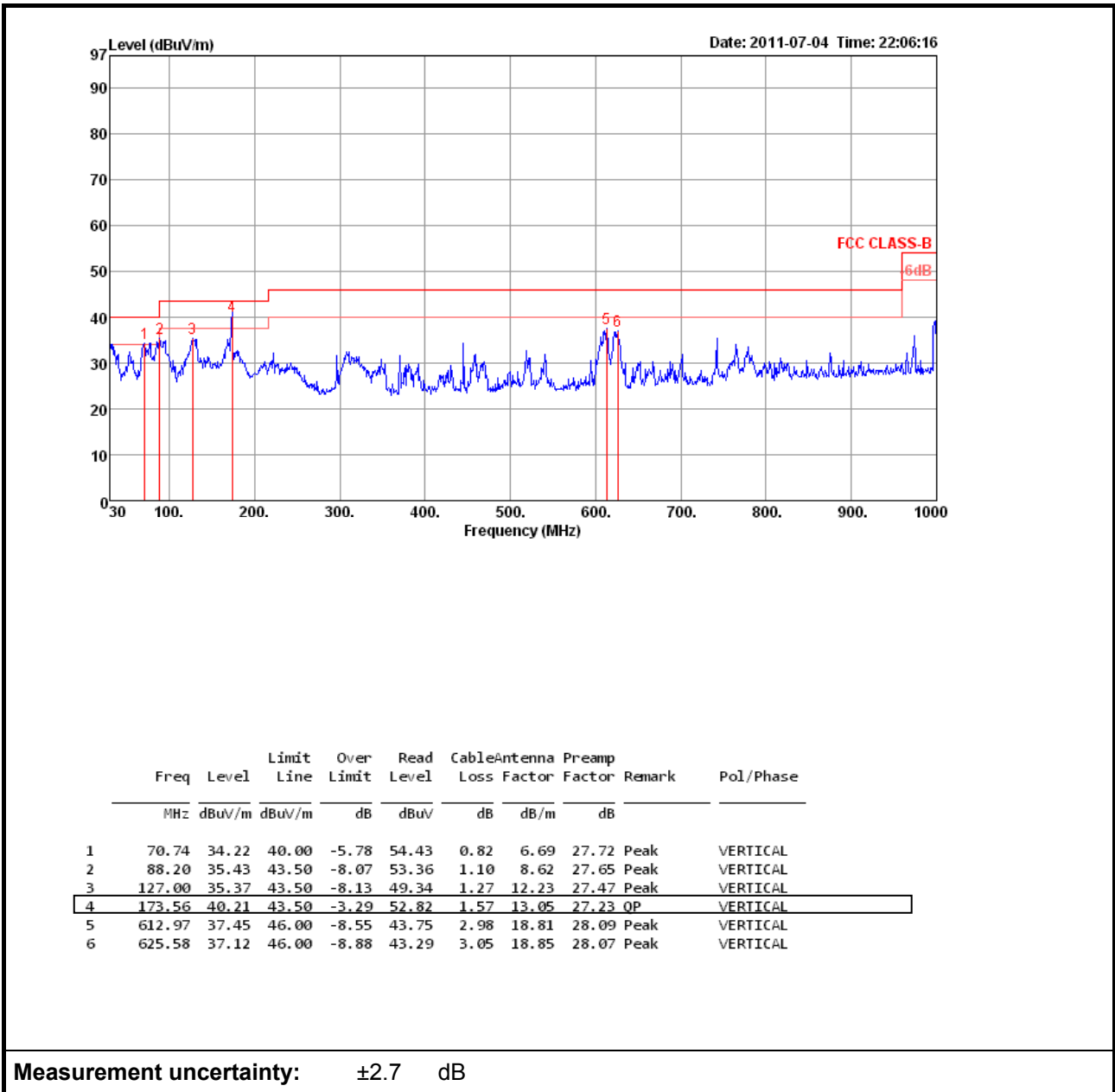



<b>Test Conditions:</b>	see ANSI C63.10, clause 5.11	<b>Polarization:</b>	Horizontal
<b>Test Engineer:</b>	Sam Chen	<b>Test Distance:</b>	3 m
<b>Test Range:</b>	30 MHz – 1000 MHz		

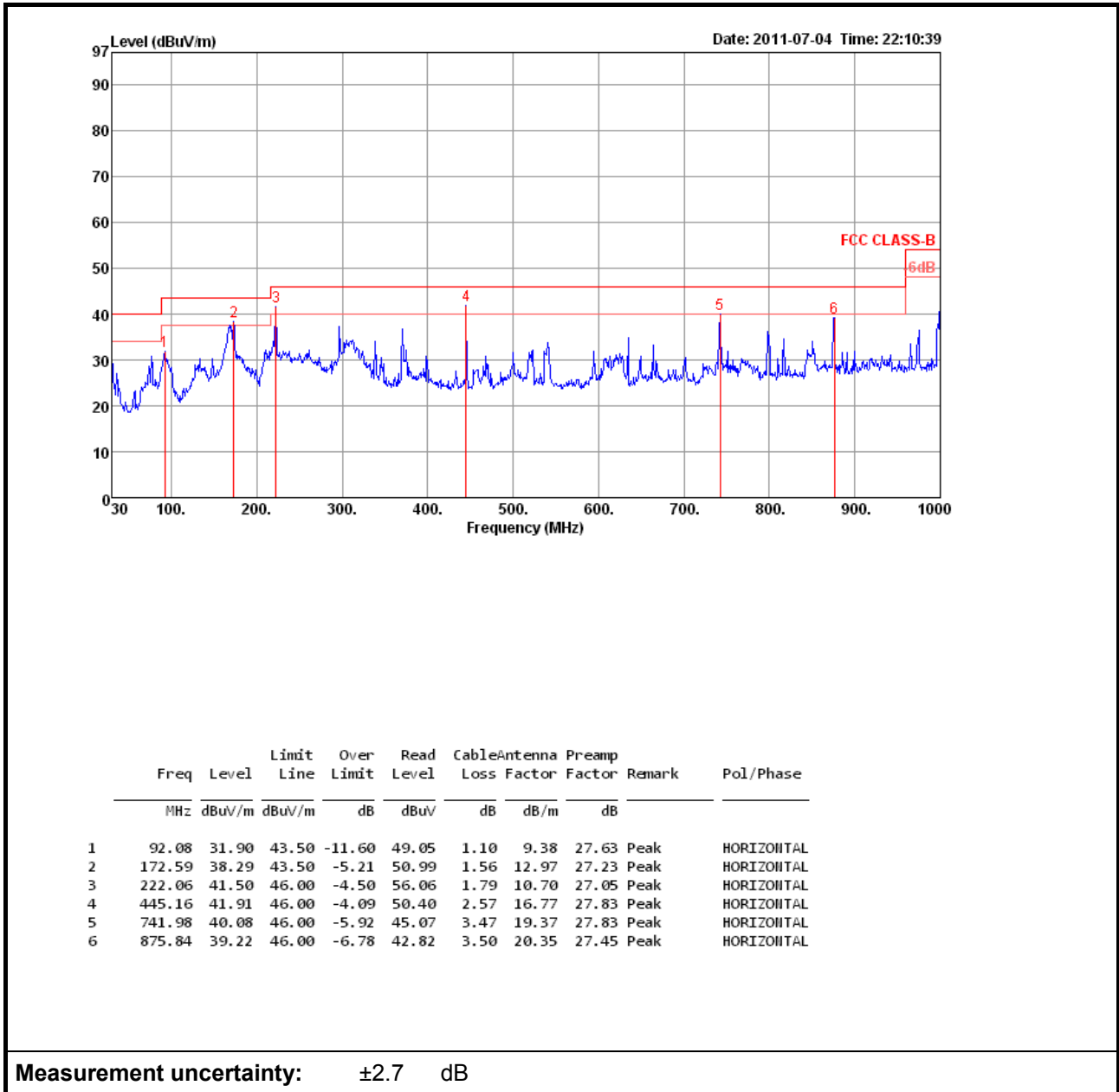





<b>Test Conditions:</b>	see ANSI C63.10, clause 5.11	<b>Polarization:</b>	Vertical
<b>Test Engineer:</b>	Sam Chen	<b>Test Distance:</b>	3 m
<b>Test Range:</b>	1 GHz – 18 GHz		

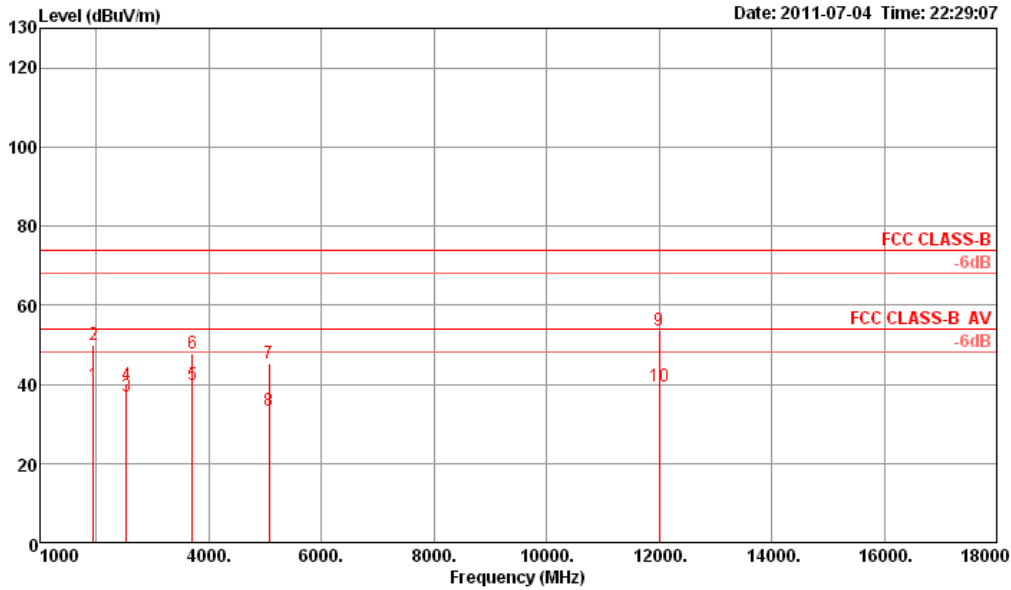

	Freq	Level	Limit	Over	Read	Cable	Antenna	Preamp	Remark	Pol/Phase
	MHz	dBuV/m	dBuV/m	dB	dBuV	dB	dB/m	dB		
1	1944.66	39.87	54.00	-14.13	45.28	2.55	26.94	34.90	Average	VERTICAL
2	1945.12	49.84	74.00	-24.16	55.25	2.55	26.94	34.90	Peak	VERTICAL
3	2537.97	36.85	74.00	-37.15	40.46	2.95	28.46	35.02	Peak	VERTICAL
4	2538.01	39.72	54.00	-14.28	43.33	2.95	28.46	35.02	Average	VERTICAL
5	3708.66	39.89	54.00	-14.11	40.02	3.43	31.64	35.20	Average	VERTICAL
6	3708.79	47.87	74.00	-26.13	48.00	3.43	31.64	35.20	Peak	VERTICAL
7	5073.64	45.21	74.00	-28.79	42.10	4.47	33.84	35.20	Peak	VERTICAL
8	5074.27	33.23	54.00	-20.77	30.12	4.47	33.84	35.20	Average	VERTICAL
9	11999.55	53.77	74.00	-20.23	42.53	6.94	39.30	35.00	Peak	VERTICAL
10	11999.88	39.53	54.00	-14.47	28.29	6.94	39.30	35.00	Average	VERTICAL

Measurement uncertainty: ±2.7 dB



<b>Test Conditions:</b>	see ANSI C63.10, clause 5.11	<b>Polarization:</b>	Horizontal
<b>Test Engineer:</b>	Sam Chen	<b>Test Distance:</b>	3 m
<b>Test Range:</b>	1 GHz – 18 GHz		

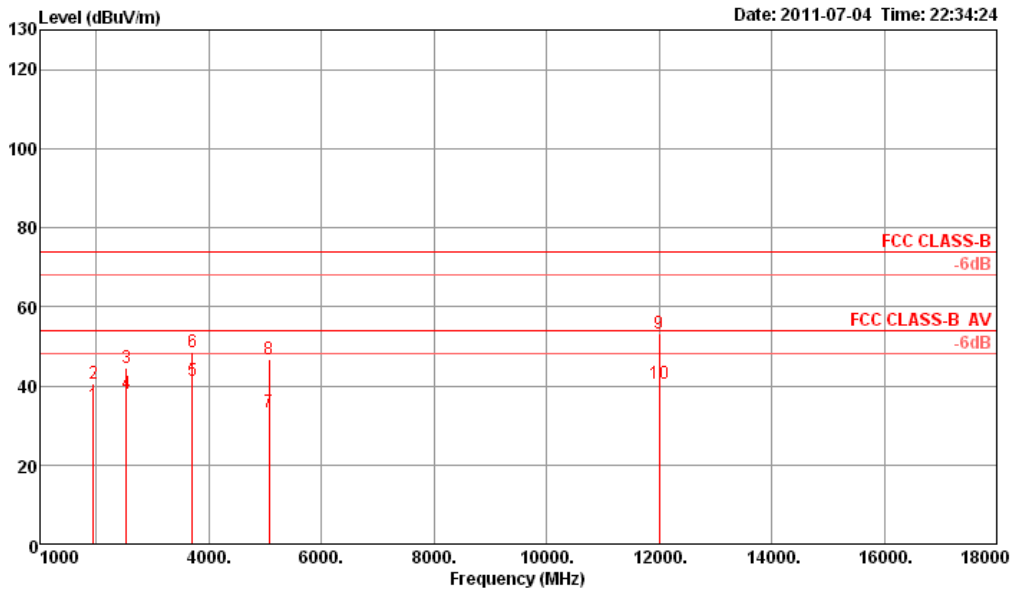

	Freq	Level	Limit	Over	Read	CableAntenna	Preamp	Remark	Pol/Phase
	MHz	dBuV/m	dBuV/m	dB	dBuV	dB	dB/m	dB	
1	1944.82	35.10	54.00	-18.90	40.51	2.55	26.94	34.90 Average	HORIZONTAL
2	1944.87	40.50	74.00	-33.50	45.91	2.55	26.94	34.90 Peak	HORIZONTAL
3	2537.99	44.66	74.00	-29.34	48.27	2.95	28.46	35.02 Peak	HORIZONTAL
4	2538.03	38.17	54.00	-15.83	41.78	2.95	28.46	35.02 Average	HORIZONTAL
5	3708.73	41.27	54.00	-12.73	41.40	3.43	31.64	35.20 Average	HORIZONTAL
6	3709.00	48.47	74.00	-25.53	48.60	3.43	31.64	35.20 Peak	HORIZONTAL
7	5074.14	33.25	54.00	-20.75	30.14	4.47	33.84	35.20 Average	HORIZONTAL
8	5074.40	46.75	74.00	-27.25	43.64	4.47	33.84	35.20 Peak	HORIZONTAL
9	12000.38	53.36	74.00	-20.64	42.12	6.94	39.30	35.00 Peak	HORIZONTAL
10	12000.46	40.43	54.00	-13.57	29.19	6.94	39.30	35.00 Average	HORIZONTAL

Measurement uncertainty: ±2.7 dB



<b>Test Conditions:</b>	see ANSI C63.10, clause 5.11	<b>Polarization:</b>	Vertical
<b>Test Engineer:</b>	Sam Chen	<b>Test Distance:</b>	1.5 m
<b>Test Range:</b>	18 GHz – 26.5 GHz		

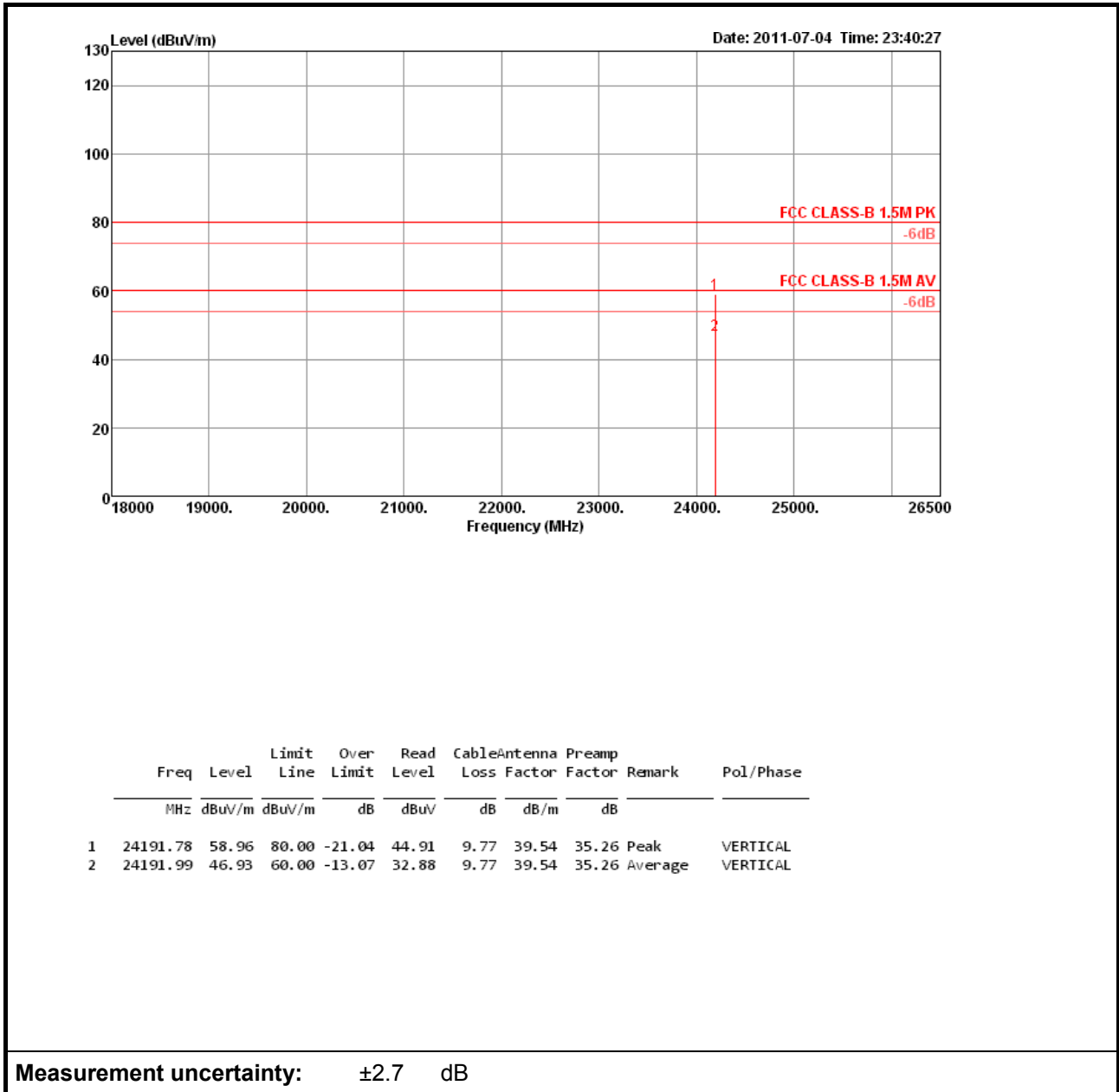





<b>Test Conditions:</b>	see ANSI C63.10, clause 5.11	<b>Polarization:</b>	Vertical
<b>Test Engineer:</b>	Sam Chen	<b>Test Distance:</b>	1.5 m
<b>Test Range:</b>	26.5 GHz – 40 GHz		

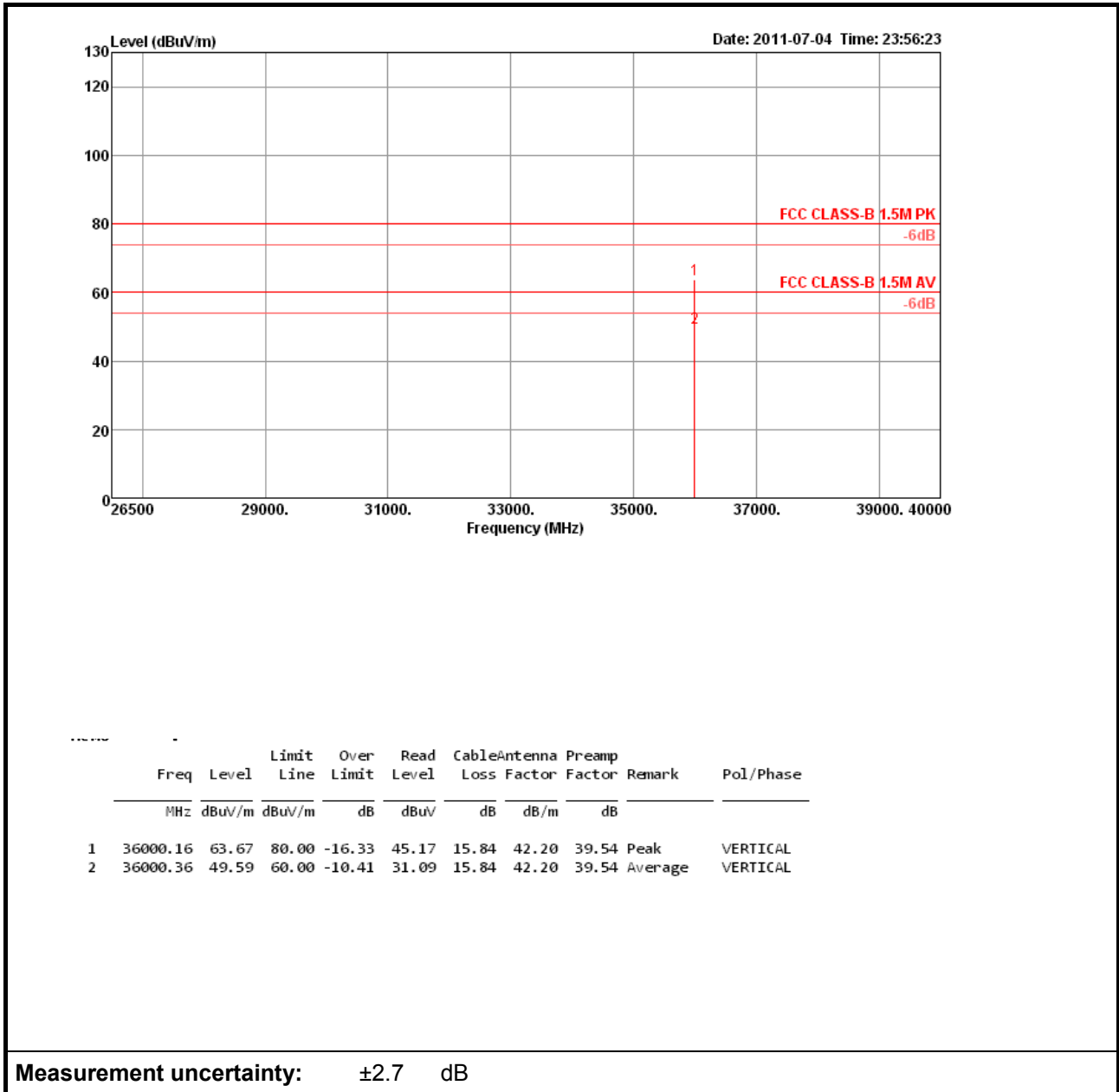



<b>Test Conditions:</b>	see ANSI C63.10, clause 5.11	<b>Polarization:</b>	Horizontal
<b>Test Engineer:</b>	Sam Chen	<b>Test Distance:</b>	1.5 m
<b>Test Range:</b>	26.5 GHz – 40 GHz		

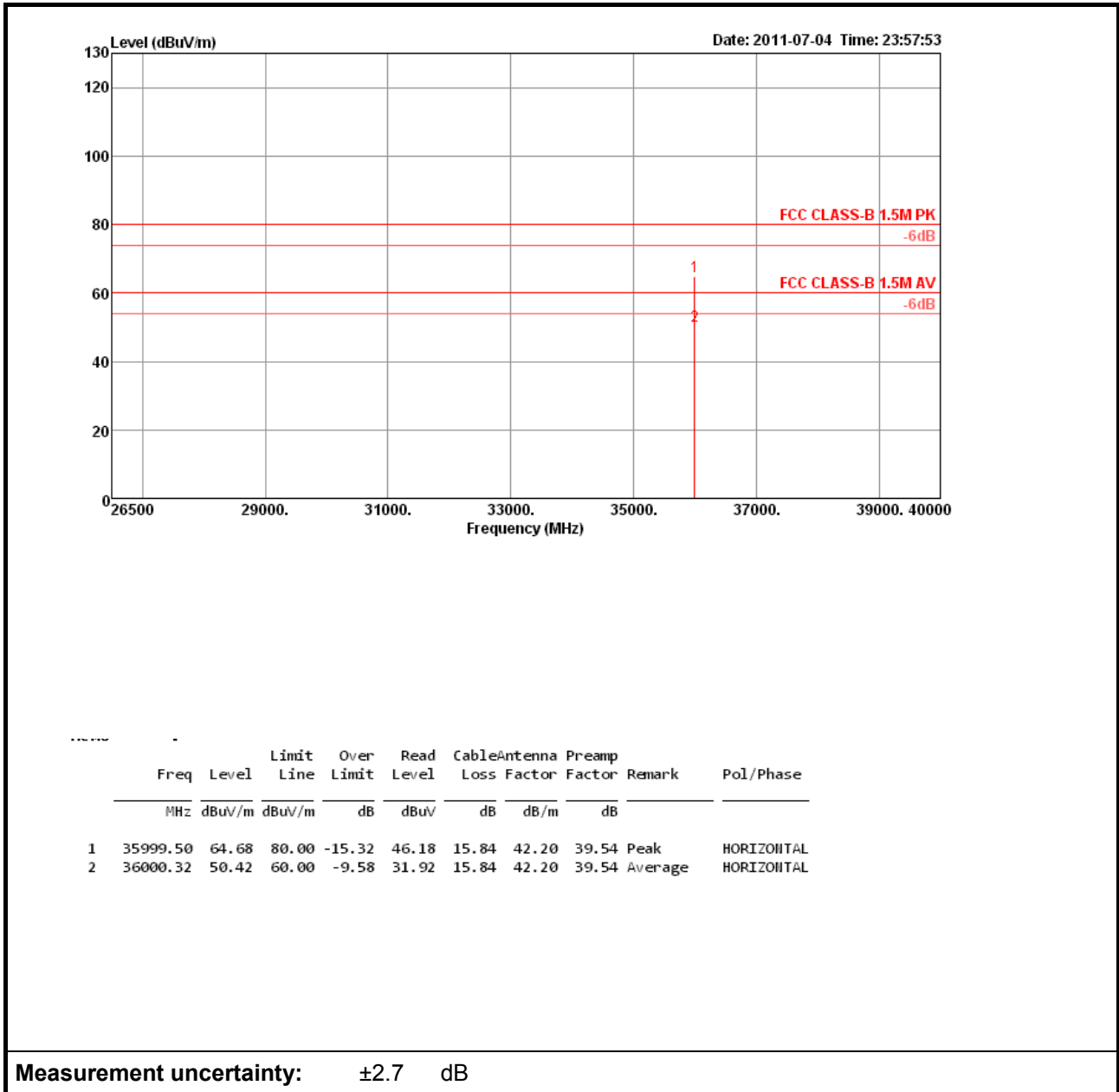



<b>Test Conditions:</b>	see ANSI C63.10, clause 5.11	<b>Test Range:</b>	40GHz – 200GHz
<b>Test Engineer:</b>	Sam Chen	<b>Test Distance:</b>	0.5 m
<b>Test Date:</b>	Jul. 02, 2011		

Frequency (GHz)	Measurement Distance (m)	Peak Power (dBm)	Rx Antenna Gain (dBi)	EIRP (dBm)
49.02	0.5	-63.80	23	-26.57
EIRP (W)	Specification Distance (m)	Power Density (W/m <sup>2</sup> )	Power Density (pW/cm <sup>2</sup> )	Limit (pW/cm <sup>2</sup> )
2.20223E-06	3	1.95E-08	19.47202	90.00

Note: The peak density is less than the average limit.

### 3.6 Frequency Stability

#### 3.6.1 Limit of Frequency Stability

Frequency Stability	Limit
Refer as FCC 15.255(f)	within the frequency bands
Note: These measurements shall also be performed at normal and extreme test conditions.	

#### 3.6.2 Measuring Instruments

Refer a measuring instruments list in this test report.

#### 3.6.3 Test Procedures

Method of measurement: Refer as ANSI C63.10-2009, clauses 6.8 and 7.8.7.

#### 3.6.4 Test Setup

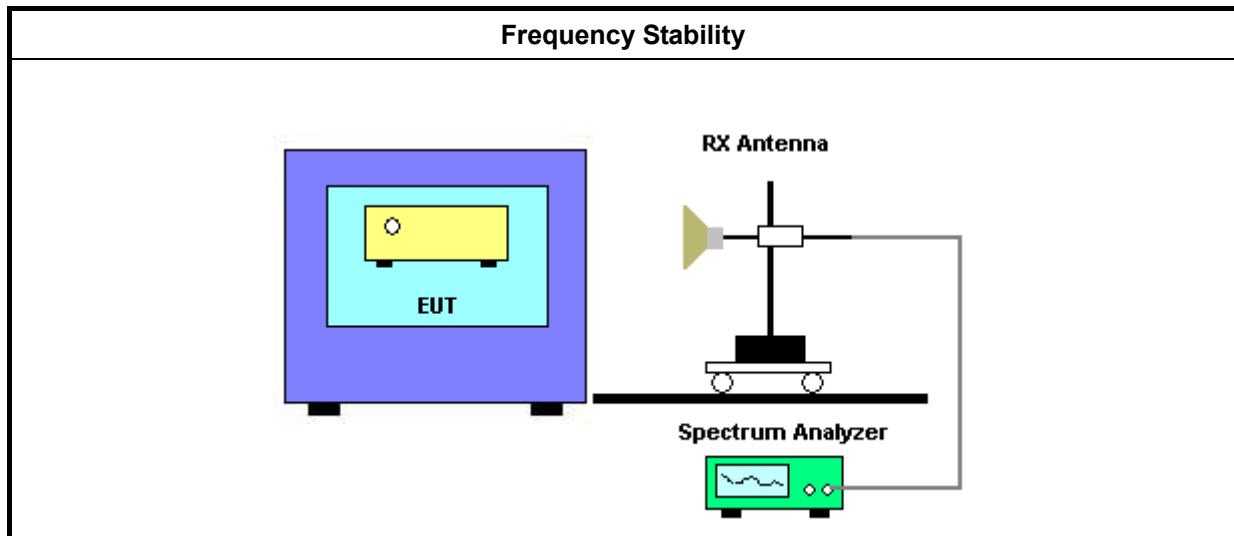



**3.6.5 Test Result of Frequency Stability**

<b>Test Conditions:</b>	see ANSI C63.10, clause 5.11
<b>Test Setup:</b>	see ANSI C63.10, clauses 6.8 and 7.8.7
<b>Test Frequency Band:</b>	60.48 GHz (HRP) Band
Worse case modulation for this operating mode:	HRP – QPSK
Worse case data rate for this operating mode:	HRP – 0.952 Gb/s (Quarter Rate)
NOTE: If equipment having different channel plan and nominal channel bandwidth modes (see test report clause 1.1.1), the measurements are uninfluenced by different channel plan and nominal channel bandwidth modes, may not need to be repeated for all modes.	

**3.6.5.1 Frequency Stability with Respect to Ambient Temperature**

Frequency Stability with Respect to Ambient Temperature			
<b>Test Conditions:</b> see ANSI C63.10, clause 5.11			
<b>Test Engineer:</b> Sam Chen			
<b>Test Date:</b> Jul. 02, 2011			
Test results			
Test Temperature: (°C)	Measured Frequency (MHz)	Delta Frequency (kHz)	Limit (±kHz)
0	60480.095	-62	within band
10	60480.135	-22	within band
20	60480.157	reference	within band
30	60480.211	54	within band
40	60480.198	41	within band
<b>Measurement uncertainty:</b> $\pm 8.5 \times 10^{-8}$ Hz			
NOTE: 1. For the applicable limit, see FCC 15.255(f). 2. The EUT is intended for indoor use only with a manufacturer’s specified temperature range of 0 to 40°C.			



3.6.5.2 Frequency Stability When Varying Supply Voltage

Frequency Stability When Varying Supply Voltage			
<b>Test Conditions:</b> see ANSI C63.10, clause 5.11			
<b>Test Engineer:</b> Sam Chen			
<b>Test Date:</b> Jul. 02, 2011			
Test results			
Test Voltage: (Vdc)	Measured Frequency (MHz)	Delta Frequency (kHz)	Limit (±kHz)
4.25	60480.156	23	within band
5	60480.133	reference	within band
5.75	60480.121	121	within band
<b>Measurement uncertainty:</b> $\pm 8.5 \times 10^{-8}$ Hz			
NOTE: For the applicable limit, see FCC 15.255(f).			

### 3.7 Publicly-accessible Coordination Channel

#### 3.7.1 Limit of Publicly-accessible Coordination Channel

Frequency Range	Limit
57 GHz-57.05 GHz	No emissions appear in the range 57-57.05 GHz
NOTE: For the applicable limit, see FCC 15.255(d)	

#### 3.7.2 Measuring Instruments

Refer a measuring instruments list in this test report.

#### 3.7.3 Test Procedures

Method of measurement: Refer as ANSI C63.10-2009, clauses 6.3, 6.4, 6.5, 6.6 and 7.8.6.

#### 3.7.4 Test Setup

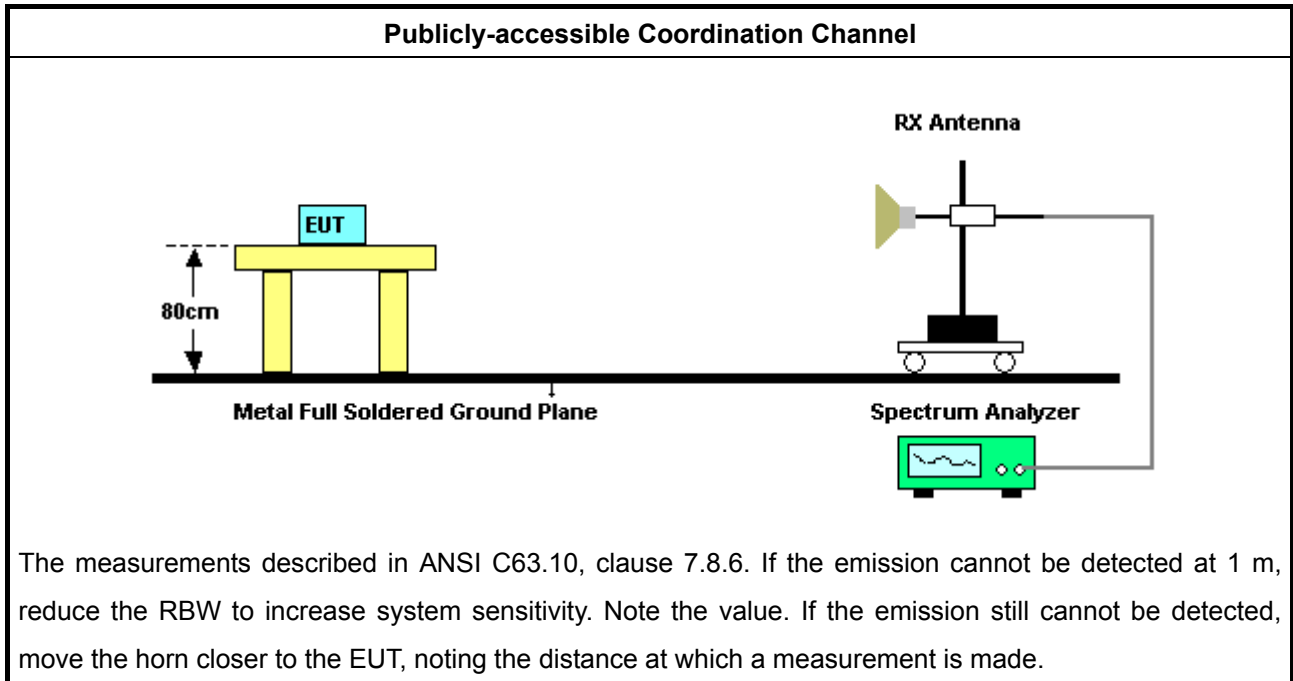



**3.7.5 Test Result of Publicly-accessible Coordination Channel**

<b>Test Conditions:</b>	see ANSI C63.10, clause 5.11
<b>Test Setup:</b>	see ANSI C63.10, clauses 6.3, 6.4, 6.5, 6.6 and 7.8.6
<b>Test Frequency Band:</b>	60.48 GHz (HRP) Band
NOTE: If equipment having different channel plan and nominal channel bandwidth modes (see test report clause 1.1.1), the measurements are uninfluenced by different channel plan and nominal channel bandwidth modes, may not need to be repeated for all modes.	



3.7.5.1.1 60.48 GHz (HRP) band, Test Frequency F4, Radiated Testing

<b>Test Conditions:</b>	see ANSI C63.10, clause 5.11	<b>Test Range:</b>	57 GHz-57.05 GHz		
<b>Test Engineer:</b>	Sam Chen	<b>Test Distance:</b>	0.5 m		
<b>Duty Cycle:</b>	50 %	<b>Test Date:</b>	Jul. 02, 2011		
<b>Rel. Humidity:</b>	61 %				
<b>Test Results</b>					
<b>Test Range</b>	<b>Emission Frequency (MHz)</b>	<b>Emission Observed (dBm)</b>	<b>Limit (dBm)</b>	<b>Margin (dB)</b>	<b>Remark</b>
57 GHz-57.05 GHz	N/F	N/F	-9.91	N/F	
<b>Measurement uncertainty:</b> $\pm 2.7$ dB					
NOTE 1: "N/F" means Nothing Found (No spurious emissions were detected.)					

### 3.8 Operation Restriction and Group Installation

#### 3.8.1 Limit of Operation Restriction and Group Installation

Item	Limit
Operation Restriction	Operation is not permitted for the following products: <ul style="list-style-type: none"> <li>♦ Equipment used on aircraft or satellites. (Refer as FCC 15.255 (a))</li> <li>♦ Field disturbance sensors, including vehicle radar systems, unless the field disturbance sensors are employed for fixed operation. (Refer as FCC 15.255 (a))</li> </ul>
Group Installation	Operation is not permitted for the following products: <ul style="list-style-type: none"> <li>♦ External phase-locking (Refer as FCC Part 15.255 (h))</li> </ul>

#### 3.8.2 Result of Operation Restriction

Manufacturer declares that EUT will not be used on aircraft or satellites. Then user manual will include a statement to caution EUT is not permitted for use on aircraft or satellites. EUT is a wireless video area network (WVAN) for the connection of consumer electronic (CE) audio and video devices.

#### 3.8.3 Result of Group Installation

The frequency, amplitude and phase of the transmit signal are set within the EUT. There are no external phase-locking inputs or any other means of combining two or more units together to realize a beam-forming array.

### 3.9 Transmitter Identification

#### 3.9.1 Limit of Transmitter Identification

Item	Limit
Transmitter Identification	Indoor use and transmitter emanate directed outside the building and peak power $\geq 0.1\text{mW}$ (EIRP) or $3\text{nW}/\text{cm}^2$ , transmitter identification data block must provide the following fields: FCC ID, Serial Number, information at least 24 bytes data
NOTE: For the applicable limit, see FCC 15.255(i)	

#### 3.9.2 Result of Transmitter Identification

EUT's application is the WirelessHD targets the wireless video area network (WVAN). All units of the WVAN are for indoor operation only. There are no outdoor units therefore no transmissions are directed outside the building. EUT is not applicable for transmitter Identification.

### 3.10 Maximum Permissible Exposure

#### 3.10.1 Limit of Maximum Permissible Exposure

Limits for Occupational / Controlled Exposure				
Frequency Range (MHz)	Electric Field Strength (E) (V/m)	Magnetic Field Strength (H) (A/m)	Power Density (S) (mW/ cm <sup>2</sup> )	Averaging Time  E  <sup>2</sup> , H  <sup>2</sup> or S (minutes)
0.3-3.0	614	1.63	(100)*	6
3.0-30	1842 / f	4.89 / f	(900 / f)*	6
30-300	61.4	0.163	1.0	6
300-1500			F/300	6
1500-100,000			5	6
Limits for General Population / Uncontrolled Exposure				
Frequency Range (MHz)	Electric Field Strength (E) (V/m)	Magnetic Field Strength (H) (A/m)	Power Density (S) (mW/ cm <sup>2</sup> )	Averaging Time  E  <sup>2</sup> , H  <sup>2</sup> or S (minutes)
0.3-1.34	614	1.63	(100)*	30
1.34-30	824/f	2.19/f	(180/f)*	30
30-300	27.5	0.073	0.2	30
300-1500			F/1500	30
1500-100,000			1.0	30
NOTE 1: f = frequency in MHz ; *Plane-wave equivalent power density				
NOTE 2: For the applicable limit, see FCC 1.1310				

#### 3.10.2 MPE Calculation Method

$$E \text{ (V/m)} = \frac{\sqrt{30 \times P \times G}}{d} \qquad \text{Power Density: } Pd \text{ (W/m}^2\text{)} = \frac{E^2}{377}$$

**E** = Electric field (V/m)

**P** = RF output power (W)

**G** = EUT Antenna numeric gain (numeric)

**d** = Separation distance between radiator and human body (m)

The formula can be changed to

$$Pd = \frac{30 \times P \times G}{377 \times d^2}$$





3.10.3 Result of Maximum Permissible Exposure

<b>Exposure Environment:</b> General Population / Uncontrolled Exposure						
<b>Test results</b>						
<b>Maximum EIRP Power of Test Frequency:</b>	<b>Average EIRP Power (dBm)</b>	<b>Average EIRP Power (mW)</b>	<b>Power Density (S) (mW/cm<sup>2</sup>)</b>	<b>Separation Distance (cm)</b>	<b>Limit of Power Density (S) (mW/cm<sup>2</sup>)</b>	
<b>LRP 62.80 GHz</b>	23.27	212.1930	0.042236	20	1.00	
<b>HRP 60.48 GHz</b>	31.49	1408.1769	0.280290	20	1.00	
<b>Measurement uncertainty:</b> ±2.7 dB						
NOTE: For the applicable limit, see FCC 1.1310						

## 4 List of Measuring Equipments

Instrument	Manufacturer	Model No.	Serial No.	Spec.	Calibration Date	Remark
EMI Test Receiver	R&S	ESCS 30	100377	9kHz ~ 2.75GHz	Sep. 01, 2010	Conduction (CO01-CB)
LISN	F.C.C.	FCC-LISN-50-16-2	04083	150kHz ~ 100MHz	Apr. 24, 2011	Conduction (CO01-CB)
V- LISN	Schwarzbeck	NSLK 8127	8127-478	9K ~ 30MHz	Oct. 30, 2010	Conduction (CO01-CB)
PULSE LIMITER	R&S	ESH3-Z2	100430	9K~30MHz	Jan. 04, 2011	Conduction (CO01-CB)
COND Cable	-	Cable	-	0.15MHz~30MHz	Dec. 01, 2010	Conduction (CO01-CB)
BILOG ANTENNA	Schaffner	CBL6112D	22021	20MHz ~ 2GHz	Oct. 17, 2010	Radiation (03CH01-CB)
Horn Antenna	EMCO	3115	00075790	750MHz~18GHz	Nov. 13, 2010	Radiation (03CH01-CB)
Horn Antenna	SCHWARZBEAK	BBHA 9170	BBHA9170252	15GHz ~ 40GHz	Oct. 08, 2010	Radiation (03CH01-CB)
Pre-Amplifier	Agilent	8447D	2944A10991	0.1MHz ~ 1.3GHz	Nov. 10, 2010	Radiation (03CH01-CB)
Pre-Amplifier	Agilent	8449B	3008A02310	1GHz ~ 26.5GHz	Nov. 06, 2010	Radiation (03CH01-CB)
Pre-Amplifier	WM	TF-130N-R1	923365	26.5GHz ~ 40GHz	Nov. 06, 2010	Radiation (03CH01-CB)
Spectrum analyzer	R&S	FSP	100304	9kHz ~ 40GHz	Nov. 06, 2010	Radiation (03CH01-CB)
EMI Test Receiver	R&S	ESCS 30	100355	9KHz ~ 2.75GHz	Mar. 06, 2010	Radiation (03CH01-CB)
Loop Antenna	R&S	HFH2-Z2	860004/001	9 kHz - 30 MHz	Jul. 28, 2010*	Radiation (03CH01-CB)
Turn Table	INN CO	CO 2000	N/A	0 ~ 360 degree	N/A	Radiation (03CH01-CB)
Antenna Mast	INN CO	CO2000	N/A	1 m - 4 m	N/A	Radiation (03CH01-CB)
RF Cable-low	Woken	Low Cable-1	-	30 MHz - 1 GHz	Nov. 06, 2010	Radiation (03CH01-CB)
RF Cable-high	Woken	High Cable-1	-	1 GHz – 26.5 GHz	Nov. 06, 2010	Radiation (03CH01-CB)
RF Cable-high	Woken	High Cable-2	-	1 GHz – 26.5 GHz	Nov. 06, 2010	Radiation (03CH01-CB)
RF Cable-high	Woken	High Cable-3	-	1 GHz - 40 GHz	Nov. 06, 2010	Radiation (03CH01-CB)
RF Cable-high	Woken	High Cable-4	-	1 GHz - 40 GHz	Nov. 06, 2010	Radiation (03CH01-CB)
Mixer	OML	M19HW/A	U91113-1	40 ~ 60 GHz	Nov. 06, 2010**	Radiation (03CH01-CB)
Mixer	OML	M15HW/A	V91113-1	50 ~ 75 GHz	Nov. 06, 2010**	Radiation (03CH01-CB)
Amplifier	HXI	HLNAV-361	2K911130	57~66GHz	Feb. 12, 2011	Radiation (03CH01-CB)
Isolator	HXI	HM15-385-60-4	2K911125	60~64GHz	Feb. 12, 2011	Radiation (03CH01-CB)



Instrument	Manufacturer	Model No.	Serial No.	Spec.	Calibration Date	Remark
Diplexer	OML	DPL313B	N/A	40~200GHz	N.C.R	Radiation (03CH01-CB)
Mixer	OML	M12HW/A	E91113-1	60 ~ 90 GHz	Nov. 06, 2010**	Radiation (03CH01-CB)
Mixer	OML	M08HW/A	F91113-1	90 ~ 140 GHz	Nov. 06, 2010**	Radiation (03CH01-CB)
Mixer	OML	M05HW/A	G91113-1	140 ~ 220 GHz	Nov. 06, 2010**	Radiation (03CH01-CB)
Standard Horn Antenna	Custom Microwave	HO19R	U91113-A	40 ~ 60 GHz	N.C.R	Radiation (03CH01-CB)
Standard Horn Antenna	Custom Microwave	HO15R	V91113-A	50 ~ 75 GHz	N.C.R	Radiation (03CH01-CB)
Standard Horn Antenna	Custom Microwave	HO12R	E91113-A	60 ~ 90 GHz	N.C.R	Radiation (03CH01-CB)
Standard Horn Antenna	Custom Microwave	HO08R	F91113-A	90 ~ 140 GHz	N.C.R	Radiation (03CH01-CB)
Standard Horn Antenna	Custom Microwave	HO05R	G91113-A	140 ~ 220 GHz	N.C.R	Radiation (03CH01-CB)
Spectrum analyzer	R&S	FSV40	101026	9KHz~30GHz	July. 23,2010	Conducted (TH01-CB)
Temp. and Humidity Chamber	TEN BILLION	TTH-D3SP	TBN-931011	-30~100°C	May. 21, 2010	Conducted (TH01-CB)
RF Power Divider	HP	11636A	00306	2GHz ~ 18GHz	N/A	Conducted (TH01-CB)
RF Power Splitter	Anaren	44100	1839	2GHz ~ 18GHz	N/A	Conducted (TH01-CB)
RF Power Splitter	Anaren	42100	17930	2GHz ~ 18GHz	N/A	Conducted (TH01-CB)
RF Cable-high	Woken	High Cable-7	-	1 GHz – 26.5 GHz	Nov. 06, 2010	Conducted (TH01-CB)
RF Cable-high	Woken	High Cable-8	-	1 GHz – 26.5 GHz	Nov. 06, 2010	Conducted (TH01-CB)
RF Cable-high	Woken	High Cable-9	-	1 GHz – 26.5 GHz	Nov. 06, 2010	Conducted (TH01-CB)
RF Cable-high	Woken	High Cable-10	-	1 GHz – 26.5 GHz	Nov. 06, 2010	Conducted (TH01-CB)
RF Cable-high	Woken	High Cable-11	-	1 GHz – 26.5 GHz	Nov. 06, 2010	Conducted (TH01-CB)
RF Cable-high	Woken	High Cable-12	-	1 GHz – 26.5 GHz	Nov. 06, 2010	Conducted (TH01-CB)
RF Cable-high	Woken	High Cable-13	-	1 GHz – 26.5 GHz	Nov. 06, 2010	Conducted (TH01-CB)

Note: Calibration Interval of instruments listed above is one year.

Calibration Interval of instruments listed above is two year.

Calibration Interval of instruments listed above is three year.

N.C.R. means Non-Calibration required.

## 5 Certification of TAF Accreditation



Certificate No. : L1190-091230

財團法人全國認證基金會  
Taiwan Accreditation Foundation

### Certificate of Accreditation

This is to certify that

**Sporton International Inc.**  
**EMC & Wireless Communications Laboratory**  
No.52, Hwa Ya 1st Rd., Hwa Ya Technology Park, Kwei-Shan Hsiang, Tao Yuan Hsien,  
Taiwan, R.O.C.

**is accredited in respect of laboratory**

<b>Accreditation Criteria</b>	: ISO/IEC 17025:2005
<b>Accreditation Number</b>	: 1190
<b>Originally Accredited</b>	: December 15, 2003
<b>Effective Period</b>	: January 10, 2010 to January 09, 2013
<b>Accredited Scope</b>	: Testing Field, see described in the Appendix
<b>Specific Accreditation Program</b>	: Accreditation Program for Designated Testing Laboratory for Commodities Inspection Accreditation Program for Telecommunication Equipment Testing Laboratory Accreditation Program for BSMI Mutual Recognition Arrangement with Foreign Authorities

  
Jay-San Chen  
President, Taiwan Accreditation Foundation  
Date : December 30, 2009

P1, total 22 pages

The Appendix forms an integral part of this Certificate, which shall be invalid when use without the Appendix