



**FCC 47 CFR PART 15 SUBPART C
(Class II Permissive Change)**

TEST REPORT

For

802.11 b/g/n Wireless USB half size mini card

Model: AW-NU706H

Trade Name: AzureWave

Issued to

**AzureWave Technologies, Inc.
8F., No.94, Baozhong Rd., Xindian, Taipei, Taiwan 231**

Issued by

**Compliance Certification Services Inc.
No. 11, Wu-Gong 6th Rd., Wugu Industrial Park,
Taipei Hsien 248, Taiwan (R.O.C.)
<http://www.ccsrf.com>
service@ccsrf.com**



Note: This report shall not be reproduced except in full, without the written approval of Compliance Certification Services Inc. This document may be altered or revised by Compliance Certification Services Inc. personnel only, and shall be noted in the revision section of the document.



TABLE OF CONTENTS

1. TEST RESULT CERTIFICATION.....	3
2. EUT DESCRIPTION	4
3. TEST METHODOLOGY	5
3.1 EUT CONFIGURATION	5
3.2 EUT EXERCISE.....	5
3.3 GENERAL TEST PROCEDURES.....	5
3.4 FCC PART 15.205 RESTRICTED BANDS OF OPERATIONS.....	6
3.5 DESCRIPTION OF TEST MODES	7
4. INSTRUMENT CALIBRATION.....	9
4.1 MEASURING INSTRUMENT CALIBRATION	9
4.2 MEASUREMENT EQUIPMENT USED	9
4.3 MEASUREMENT UNCERTAINTY	10
5. FACILITIES AND ACCREDITATIONS	11
5.1 FACILITIES	11
5.2 EQUIPMENT.....	11
5.3 TABLE OF ACCREDITATIONS AND LISTINGS.....	12
6. SETUP OF EQUIPMENT UNDER TEST	13
6.1 SETUP CONFIGURATION OF EUT.....	13
6.2 SUPPORT EQUIPMENT	13
7. FCC PART 15.247 REQUIREMENTS.....	14
7.1 PEAK POWER.....	14
7.2 AVERAGE POWER	16
7.3 BAND EDGES MEASUREMENT	18
7.4 RADIATED EMISSIONS	35
APPENDIX I RADIO FREQUENCY EXPOSURE	52
APPENDIX II PHOTOGRAPHS OF TEST SETUP	55
APPENDIX 1 - PHOTOGRAPHS OF EUT	



1. TEST RESULT CERTIFICATION

Applicant: AzureWave Technologies, Inc.
 8F., No.94, Baozhong Rd., Xindian, Taipei, Taiwan 231

Equipment Under Test: 802.11 b/g/n Wireless USB half size mini card

Trade Name: AzureWave

Model: AW-NU706H

Date of Test: October 20 ~ 21, 2010

APPLICABLE STANDARDS	
STANDARD	TEST RESULT
FCC 47 CFR Part 15 Subpart C	No non-compliance noted

We hereby certify that:

The above equipment was tested by Compliance Certification Services Inc. The test data, data evaluation, test procedures, and equipment configurations shown in this report were made in accordance with the procedures given in ANSI C63.4: 2003 and the energy emitted by the sample EUT tested as described in this report is in compliance with the requirements of FCC Rules Part 15.207, 15.209, 15.247.

The test results of this report relate only to the tested sample EUT identified in this report.

Approved by:

Reviewed by:

Rex Lai
 Section Manager
 Compliance Certification Services Inc.

Gina Lo
 Section Manager
 Compliance Certification Services Inc.



2. EUT DESCRIPTION

Product	802.11 b/g/n Wireless USB half size mini card
Trade Name	AzureWave
Model Number	AW-NU706H
Model Discrepancy	N/A
Power Rating	Power from host device.
Frequency Range	2412 ~ 2462 MHz
Transmit Power	IEEE 802.11b mode: 14.08 dBm IEEE 802.11g mode: 17.21 dBm Standard 802.11n 20 MHz mode: 16.12 dBm Standard 802.11n wide 40 MHz mode: 14.12 dBm
Modulation Technique	IEEE 802.11b mode: DSSS IEEE 802.11g mode: OFDM Standard 802.11n 20 MHz mode: OFDM Standard 802.11n wide 40 MHz mode: OFDM
Number of Channels	IEEE 802.11b/g mode: 11 Channels Standard 802.11n 20 MHz mode: 11 Channels Standard 802.11n wide 40 MHz mode: 7 Channels
Antenna Specification	Approved Antenna: 1. ARISTOILE / PIFA Antenna P/N: RFA-02-G05-70B-300/ Gain: 2 dBi 2. YAGEO / PIFA Antenna P/N: Main: CAN4313 820 012701B / Gain: 0.41 dBi P/N: Aux: CAN4313 820 022701B/ Gain: -0.23 dBi 3. ASUS / PIFA Antenna P/N: Main: 14G152209000 / Gain: 0.71 dBi P/N: AUX: 14G152209100 / Gain: -0.22 dBi *New antenna: 1. Part Number: RFD-0710004 Dipole Antenna / Gain: 3dBi 2. Part Number: WF04PC-21070-4 Dipole Antenna / Gain:-1.44dBi
Class II Permissive Change	Added two set of antenna, please see ""*"" in this report, for detail descriptions, please refers to the antenna specification.

Remark:

1. The sample selected for test was production product and was provided by manufacturer.
2. This submittal(s) (test report) is intended for FCC ID: **TLZ-NU706** filing to comply with Section 15.207, 15.209 and 15.247 of the FCC Part 15, Subpart C Rules.



3. TEST METHODOLOGY

The tests documented in this report were performed in accordance with ANSI C63.4 and FCC CFR 47 2.1046, 2.1047, 2.1049, 2.1051, 2.1053, 2.1055, 2.1057, 15.207, 15.209 and 15.247.

3.1 EUT CONFIGURATION

The EUT configuration for testing is installed on RF field strength measurement to meet the Commissions requirement and operating in a manner that intends to maximize its emission characteristics in a continuous normal application.

3.2 EUT EXERCISE

The EUT was operated in the engineering mode to fix the TX frequency that was for the purpose of the measurements.

According to its specifications, the EUT must comply with the requirements of the Section 15.207, 15.209 and 15.247 under the FCC Rules Part 15 Subpart C.

3.3 GENERAL TEST PROCEDURES

Conducted Emissions

The EUT is placed on the turntable, which is 0.8 m above ground plane. According to the requirements in Section 13.1.4.1 of ANSI C63.4 Conducted emissions from the EUT measured in the frequency range between 0.15 MHz and 30MHz using CISPR Quasi-peak and average detector modes.

Radiated Emissions

The EUT is placed on a turn table, which is 0.8 m above ground plane. The turntable shall rotate 360 degrees to determine the position of maximum emission level. EUT is set 3m away from the receiving antenna, which varied from 1m to 4m to find out the highest emission. And also, each emission was to be maximized by changing the polarization of receiving antenna both horizontal and vertical. In order to find out the maximum emissions, exploratory radiated emission measurements were made according to the requirements in Section 13.1.4.1 of ANSI C63.4.



3.4 FCC PART 15.205 RESTRICTED BANDS OF OPERATIONS

(a) Except as shown in paragraph (d) of this section, only spurious emissions are permitted in any of the frequency bands listed below:

MHz	MHz	MHz	GHz
0.090 - 0.110	16.42 - 16.423	399.9 - 410	4.5 - 5.15
¹ 0.495 - 0.505	16.69475 - 16.69525	608 - 614	5.35 - 5.46
2.1735 - 2.1905	16.80425 - 16.80475	960 - 1240	7.25 - 7.75
4.125 - 4.128	25.5 - 25.67	1300 - 1427	8.025 - 8.5
4.17725 - 4.17775	37.5 - 38.25	1435 - 1626.5	9.0 - 9.2
4.20725 - 4.20775	73 - 74.6	1645.5 - 1646.5	9.3 - 9.5
6.215 - 6.218	74.8 - 75.2	1660 - 1710	10.6 - 12.7
6.26775 - 6.26825	108 - 121.94	1718.8 - 1722.2	13.25 - 13.4
6.31175 - 6.31225	123 - 138	2200 - 2300	14.47 - 14.5
8.291 - 8.294	149.9 - 150.05	2310 - 2390	15.35 - 16.2
8.362 - 8.366	156.52475 -	2483.5 - 2500	17.7 - 21.4
8.37625 - 8.38675	156.52525	2655 - 2900	22.01 - 23.12
8.41425 - 8.41475	156.7 - 156.9	3260 - 3267	23.6 - 24.0
12.29 - 12.293	162.0125 - 167.17	3332 - 3339	31.2 - 31.8
12.51975 - 12.52025	167.72 - 173.2	3345.8 - 3358	36.43 - 36.5
12.57675 - 12.57725	240 - 285	3600 - 4400	(²)
13.36 - 13.41	322 - 335.4		

¹ Until February 1, 1999, this restricted band shall be 0.490-0.510 MHz.

² Above 38.6

(b) Except as provided in paragraphs (d) and (e), the field strength of emissions appearing within these frequency bands shall not exceed the limits shown in Section 15.209. At frequencies equal to or less than 1000 MHz, compliance with the limits in Section 15.209 shall be demonstrated using measurement instrumentation employing a CISPR quasi-peak detector. Above 1000 MHz, compliance with the emission limits in Section 15.209 shall be demonstrated based on the average value of the measured emissions. The provisions in Section 15.35 apply to these measurements.



3.5 DESCRIPTION OF TEST MODES

The EUT (model: AW-NU706H) is a 1*1 SISO and had been tested under operating condition.

Test program used to control the EUT for staying in continuous transmitting mode was programmed.

Software used to control the EUT for staying in continuous transmitting mode was programmed.

The EUT comes with two different antennas (RFD-0710004 & WF04PC-21070-4) for sale. After the preliminary test, the antenna with part number FD-0710004 was found to emit the worst emissions and therefore had been tested under operating condition.

After verification, all tests were carried out with the worst case test modes as shown below except radiated spurious emission below 1GHz only.

IEEE 802.11b mode:

Channel Low (2412MHz), Channel Mid (2437MHz) and Channel High (2462MHz) with 1Mbps data rate were chosen for full testing.

IEEE 802.11g mode:

Channel Low (2412MHz), Channel Mid (2437MHz) and Channel High (2462MHz) with 6Mbps data rate were chosen for full testing.

Standard 802.11n 20 MHz mode:

Channel Low (2412MHz), Channel Mid (2437MHz) and Channel High (2462MHz) with 6.5Mbps data rate were chosen for full testing.

Standard 802.11n wide 40 MHz mode:

Channel Low (2422MHz), Channel Mid (2437MHz) and Channel High (2452MHz) with 13.5Mbps data rate were chosen for full testing.

About reduce output power; please see the detail as list below.

Test mode: IEEE 802.11b

Channel	Frequency (MHz)	Original Output Power (dBm)	New Output Power (dBm)	Reduce Output Power (dBm)
Low	2412	16.66	13.87	2.79
Mid	2437	16.25	13.33	2.92
High	2462	15.73	14.08	1.65

Test mode: IEEE 802.11g

Channel	Frequency (MHz)	Original Output Power (dBm)	New Output Power (dBm)	Reduce Output Power (dBm)
Low	2412	17.58	17.03	0.55
Mid	2437	17.37	17.21	0.16
High	2462	16.68	16.54	0.14



Test mode: Standard 802.11n 20 MHz mode

Channel	Frequency (MHz)	Original Output Power (dBm)	New Output Power (dBm)	Reduce Output Power (dBm)
Low	2412	16.31	14.61	1.70
Mid	2437	16.26	16.12	0.14
High	2462	15.80	15.15	0.65

Test mode: Standard 802.11n wide 40 MHz mode

Channel	Frequency (MHz)	Original Output Power (dBm)	New Output Power (dBm)	Reduce Output Power (dBm)
Low	2422	14.24	14.12	0.12
Mid	2437	14.11	14.02	0.09
High	2452	13.28	13.23	0.05



4. INSTRUMENT CALIBRATION

4.1 MEASURING INSTRUMENT CALIBRATION

The measuring equipment, which was utilized in performing the tests documented herein, has been calibrated in accordance with the manufacturer's recommendations for utilizing calibration equipment, which is traceable to recognized national standards.

4.2 MEASUREMENT EQUIPMENT USED

Equipment Used for Emissions Measurement

Remark: Each piece of equipment is scheduled for calibration once a year and Loop Antenna is scheduled for calibration once three years.

Conducted Emissions Test Site				
Name of Equipment	Manufacturer	Model	Serial Number	Calibration Due
Power Meter	Agilent	E4416A	GB41291611	06/27/2011
Power Sensor	Agilent	E9327A	US40441097	06/27/2011

3M Semi Anechoic Chamber				
Name of Equipment	Manufacturer	Model	Serial Number	Calibration Due
Spectrum Analyzer	Agilent	E4446A	US42510252	10/26/2010
EMI Test Receiver	R&S	ESCI	100064	02/04/2011
Pre-Amplifier	Mini-Circuits	ZFL-1000LN	SF350700823	01/13/2011
Pre-Amplifier	MITEQ	AFS44-00102650-42-10P-44	1415367	11/20/2010
Bilog Antenna	Sunol Sciences	JB3	A030105	09/10/2011
Horn Antenna	EMCO	3117	00055165	12/07/2010
Loop Antenna	EMCO	6502	8905/2356	06/10/2013
Turn Table	CCS	CC-T-1F	N/A	N.C.R
Antenna Tower	CCS	CC-A-1F	N/A	N.C.R
Controller	CCS	CC-C-1F	N/A	N.C.R
Site NSA	CCS	N/A	N/A	12/31/2010
Test S/W	EZ-EMC (CCS-3A1RE)			



4.3 MEASUREMENT UNCERTAINTY

PARAMETER	UNCERTAINTY
3M Semi Anechoic Chamber / 30M~200M	+/- 4.0606
3M Semi Anechoic Chamber / 200M~1000M	+/- 3.9979
3M Semi Anechoic Chamber / 1G~8G	+/- 2.5790
3M Semi Anechoic Chamber / 8G~18G	+/- 2.5928
3M Semi Anechoic Chamber / 18G~26G	+/- 2.7212
3M Semi Anechoic Chamber / 26G~40G	+/- 2.9520

Remark: This uncertainty represents an expanded uncertainty expressed at approximately the 95% confidence level using a coverage factor of $k=2$.



5. FACILITIES AND ACCREDITATIONS

5.1 FACILITIES

All measurement facilities used to collect the measurement data are located at

No.199, Chunghsen Road, Hsintien City, Taipei Hsien, Taiwan, R.O.C.

Tel: 886-2-2217-0894 / Fax: 886-2-2217-1029

No.11, Wugong 6th Rd., Wugu Industrial Park, Taipei Hsien 248, Taiwan

Tel: 886-2-2299-9720 / Fax: 886-2-2298-4045

No.81-1, Lane 210, Bade 2nd Rd., Luchu Hsiang, Taoyuan Hsien 338, Taiwan

Tel: 886-3-324-0332 / Fax: 886-3-324-5235

The sites are constructed in conformance with the requirements of ANSI C63.7, ANSI C63.4 and CISPR Publication 22.

5.2 EQUIPMENT

Radiated emissions are measured with one or more of the following types of linearly polarized antennas: tuned dipole, biconical, log periodic, bi-log, and/or ridged waveguide, horn. Spectrum analyzers with pre-selectors and quasi-peak detectors are used to perform radiated measurements.



Conducted emissions are measured with Line Impedance Stabilization Networks and EMI Test Receivers.

Calibrated wideband preamplifiers, coaxial cables, and coaxial attenuators are also used for making measurements.

All receiving equipment conforms to CISPR Publication 16-1, "Radio Interference Measuring Apparatus and Measurement Methods."



5.3 TABLE OF ACCREDITATIONS AND LISTINGS

Country	Agency	Scope of Accreditation	Logo
USA	FCC	3M Semi Anechoic Chamber (FCC MRA: TW1039) to perform FCC Part 15 measurements	 FCC MRA: TW1039
Taiwan	TAF	LP0002, RTTE01, FCC Method-47 CFR Part 15 Subpart C, D, E, RSS-210, RSS-310 IDA TS SRD, AS/NZS 4268, AS/NZS 4771, TS 12.1 & 12.2, ETSI EN 300 440-1, ETSI EN 300 440-2, ETSI EN 300 328, ETSI EN 300 220-1, ETSI EN 300 220-2, ETSI EN 301 893, ETSI EN 301 489-1/3/7/17 FCC OET Bulletin 65 + Supplement C, EN 50360, EN 50361, EN 50371, RSS 102, EN 50383, EN 50385, EN 50392, IEC 62209, CNS 14958-1, CNS 14959 FCC Method -47 CFR Part 15 Subpart B IEC / EN 61000-3-2, IEC / EN 61000-3-3, IEC / EN 61000-4-2/3/4/5/6/8/11	
Canada	Industry Canada	3M Semi Anechoic Chamber (IC 2324G-1 / IC 2324G-2) to perform	 IC 2324G-1 IC 2324G-2

* No part of this report may be used to claim or imply product endorsement by A2LA or any agency of the US Government.



6. SETUP OF EQUIPMENT UNDER TEST

6.1 SETUP CONFIGURATION OF EUT

See test photographs attached in Appendix II for the actual connections between EUT and support equipment.

6.2 SUPPORT EQUIPMENT

No	Device Type	Brand	Model	Series No.	FCC ID	Data Cable	Power Cord
1.	Notebook PC	DELL	PP05L	7T390 A03	E2K5HCKT	N/A	AC I/P: Unshielded, 1.8m DC O/P: Unshielded, 1.8m with a core

Remark:

- 1. All the equipment/cables were placed in the worst-case configuration to maximize the emission during the test.*
- 2. Grounding was established in accordance with the manufacturer's requirements and conditions for the intended use.*



7. FCC PART 15.247 REQUIREMENTS

7.1 PEAK POWER

LIMIT

The maximum peak output power of the intentional radiator shall not exceed the following:

1. According to §15.247(b)(3), for systems using digital modulation in the bands of 902-928 MHz, 2400-2483.5 MHz, and 5725-5850 MHz: 1 Watt.
2. According to §15.247(b)(4), the conducted output power limit specified in paragraph (b) of this section is based on the use of antennas with directional gains that do not exceed 6 dBi. Except as shown in paragraph (c) of this section, if transmitting antennas of directional gain greater than 6 dBi are used, the conducted output power from the intentional radiator shall be reduced below the stated values in paragraphs (b)(1), (b)(2), and (b)(3) of this section, as appropriate, by the amount in dB that the directional gain of the antenna exceeds 6 dBi.

Test Configuration

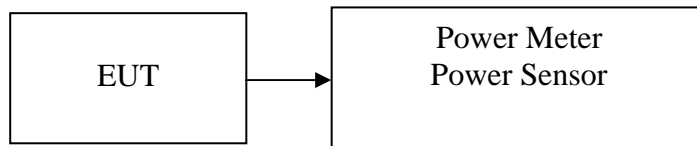

TEST PROCEDURE

The transmitter output is connected to the Power Meter. The Power Meter is set to the peak power detection.

TEST RESULTS

No non-compliance noted.



Test Data

Test mode: IEEE 802.11b

Channel	Frequency (MHz)	Output Power (dBm)	Output Power (W)	Limit (W)	Result
Low	2412	13.87	0.0244	1.00	PASS
Mid	2437	13.33	0.0215		PASS
High	2462	14.08	0.0256		PASS

Test mode: IEEE 802.11g

Channel	Frequency (MHz)	Output Power (dBm)	Output Power (W)	Limit (W)	Result
Low	2412	17.03	0.0505	1.00	PASS
Mid	2437	17.21	0.0526		PASS
High	2462	16.54	0.0451		PASS

Standard 802.11n 20 MHz mode

Channel	Frequency (MHz)	Output Power (dBm)	Output Power (W)	Limit (W)	Result
Low	2412	14.61	0.0289	1.00	PASS
Mid	2437	16.12	0.0409		PASS
High	2462	15.15	0.0327		PASS

Standard 802.11n wide 40 MHz mode

Channel	Frequency (MHz)	Output Power (dBm)	Output Power (W)	Limit (W)	Result
Low	2422	14.12	0.0258	1.00	PASS
Mid	2437	14.02	0.0252		PASS
High	2452	13.23	0.0210		PASS



7.2 AVERAGE POWER

LIMIT

None; for reporting purposes only.

Test Configuration

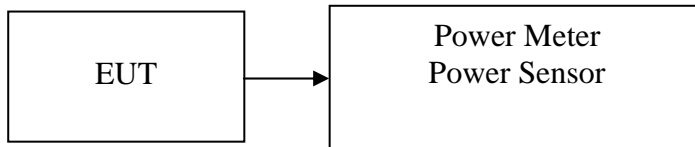

TEST PROCEDURE

The transmitter output is connected to the Power Meter. The Power Meter is set to the peak power detection.

TEST RESULTS

No non-compliance noted.



Test Data

Test mode: IEEE 802.11b mode

Channel	Frequency (MHz)	Output Power (dBm)
Low	2412	10.39
Mid	2437	10.58
High	2462	11.31

Test mode: IEEE 802.11g mode

Channel	Frequency (MHz)	Output Power (dBm)
Low	2412	13.28
Mid	2437	13.79
High	2462	13.11

Standard 802.11n 20 MHz mode

Channel	Frequency (MHz)	Output Power (dBm)
Low	2412	10.95
Mid	2437	12.84
High	2462	11.66

Standard 802.11n wide 40 MHz mode

Channel	Frequency (MHz)	Output Power (dBm)
Low	2422	10.48
Mid	2437	10.47
High	2452	9.87



7.3 BAND EDGES MEASUREMENT

LIMIT

According to §15.247(d), in any 100 kHz bandwidth outside the frequency bands in which the spread spectrum intentional radiator is operating, the radio frequency power that is produced by the intentional radiator shall be at least 20 dB below that in the 100 kHz bandwidth within the band that contains the highest level of the desired power, based on either an RF conducted or a radiated measurement, provided the transmitter demonstrates compliance with the peak conducted power limits. In addition, radiated emissions which fall in the restricted bands, as defined in §15.205(a), must also comply with the radiated emission limits specified in 15.209(a) (see Section 15.205(c)).

Test Configuration

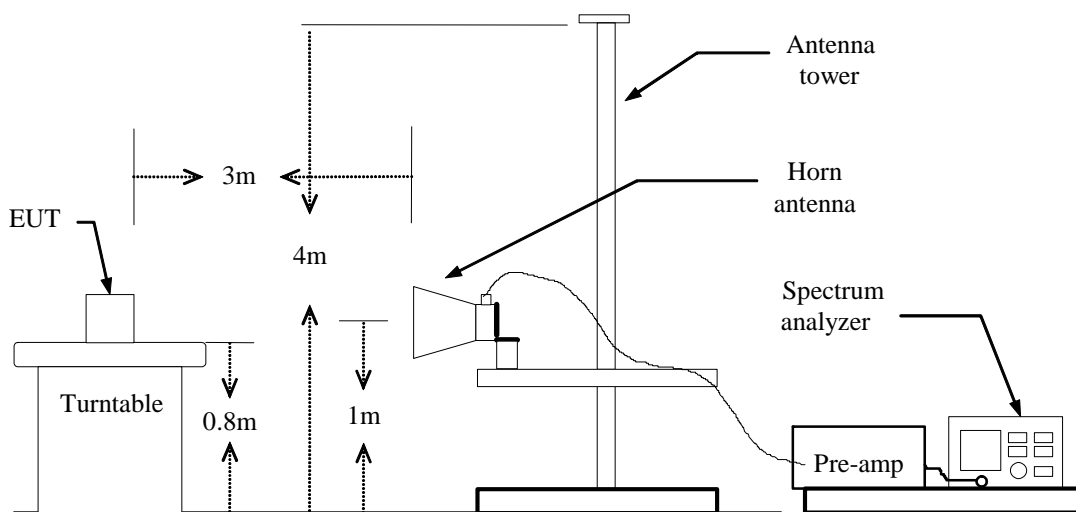

TEST PROCEDURE

1. The EUT is placed on a turntable, which is 0.8m above the ground plane.
2. The turntable shall be rotated for 360 degrees to determine the position of maximum emission level.
3. EUT is set 3m away from the receiving antenna, which is varied from 1m to 4m to find out the highest emission.
4. Set the spectrum analyzer in the following setting in order to capture the lower and upper band-edges of the emission:
 - (a) PEAK: RBW=VBW=1MHz / Sweep=AUTO
 - (b) AVERAGE: RBW=1MHz / VBW=10Hz / Sweep=AUTO
5. Repeat the procedures until all the PEAK and AVERAGE versus POLARIZATION are measured.

TEST RESULTS

Refer to attach spectrum analyzer data chart.



Band Edges (IEEE 802.11b mode / CH Low)

Detector mode: Peak

Polarity: Vertical

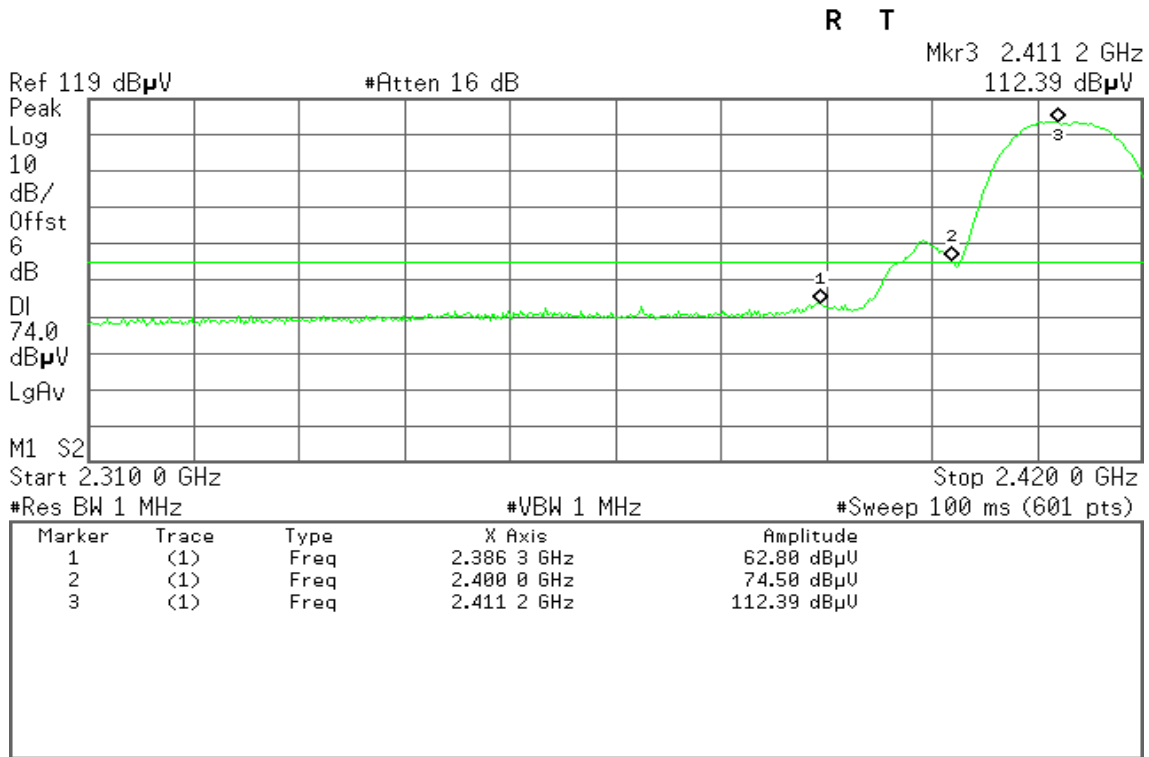

Detector mode: Average

Polarity: Vertical

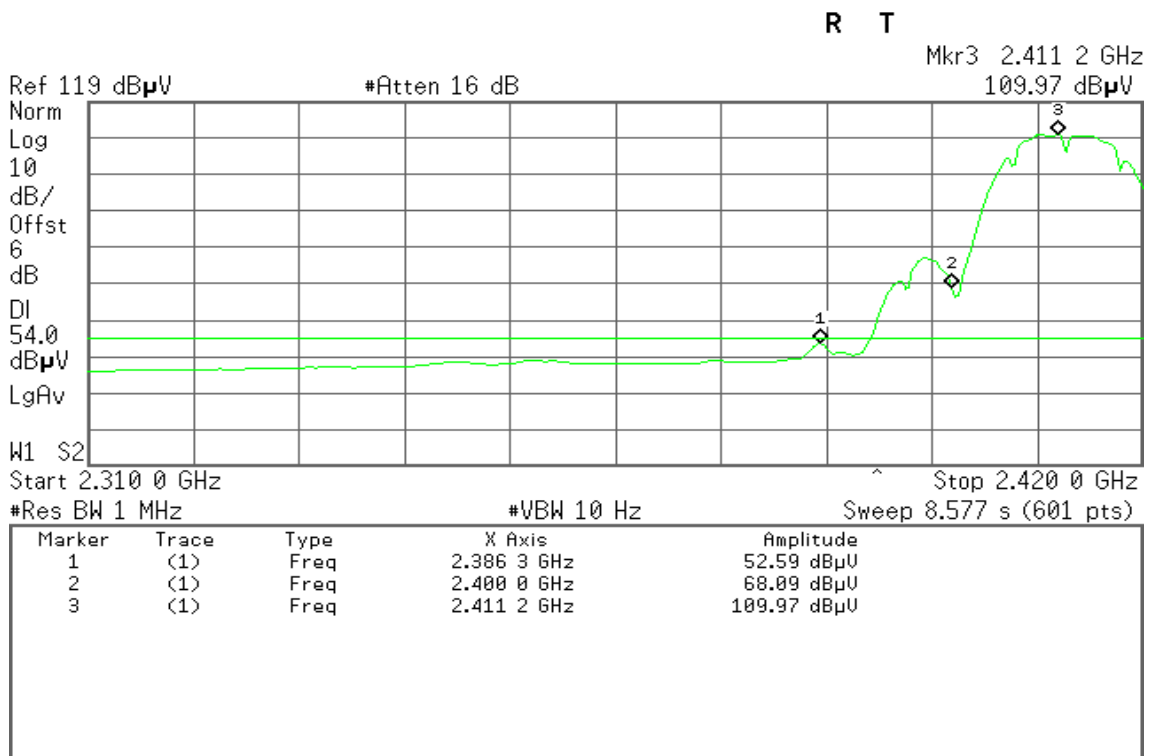



Detector mode: Peak

Polarity: Horizontal

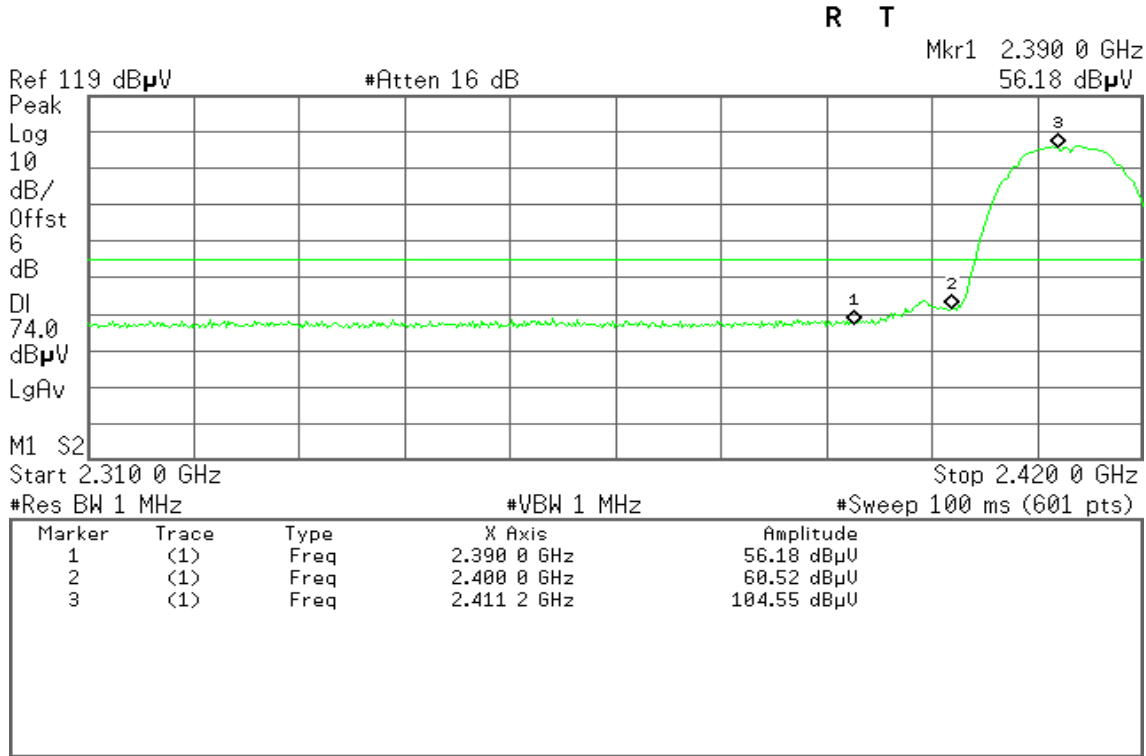

Detector mode: Average

Polarity: Horizontal

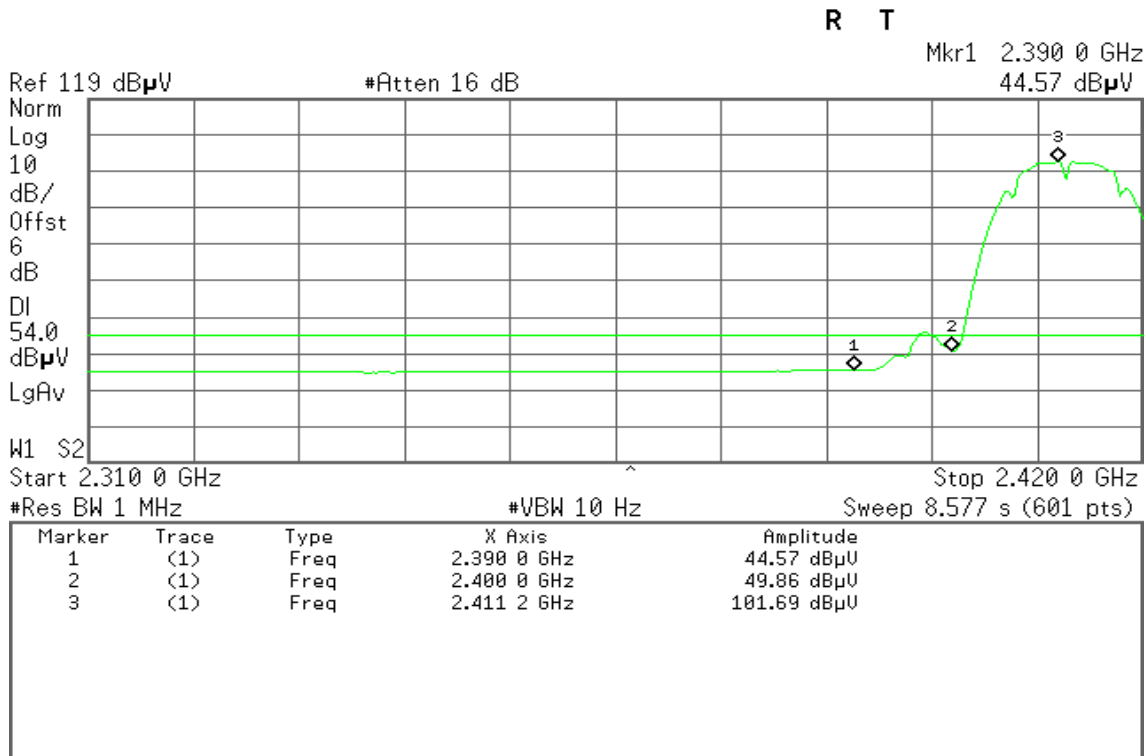



Band Edges (IEEE 802.11b mode / CH High)

Detector mode: Peak

Polarity: Vertical

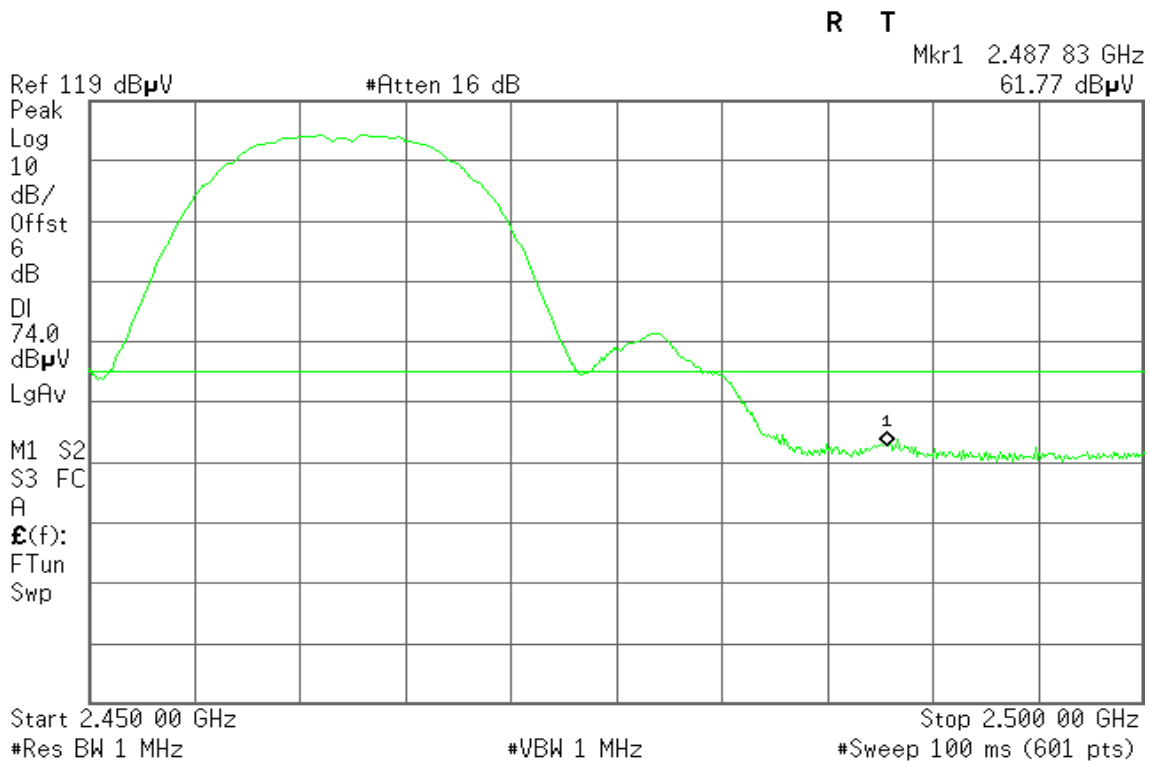

Detector mode: Average

Polarity: Vertical

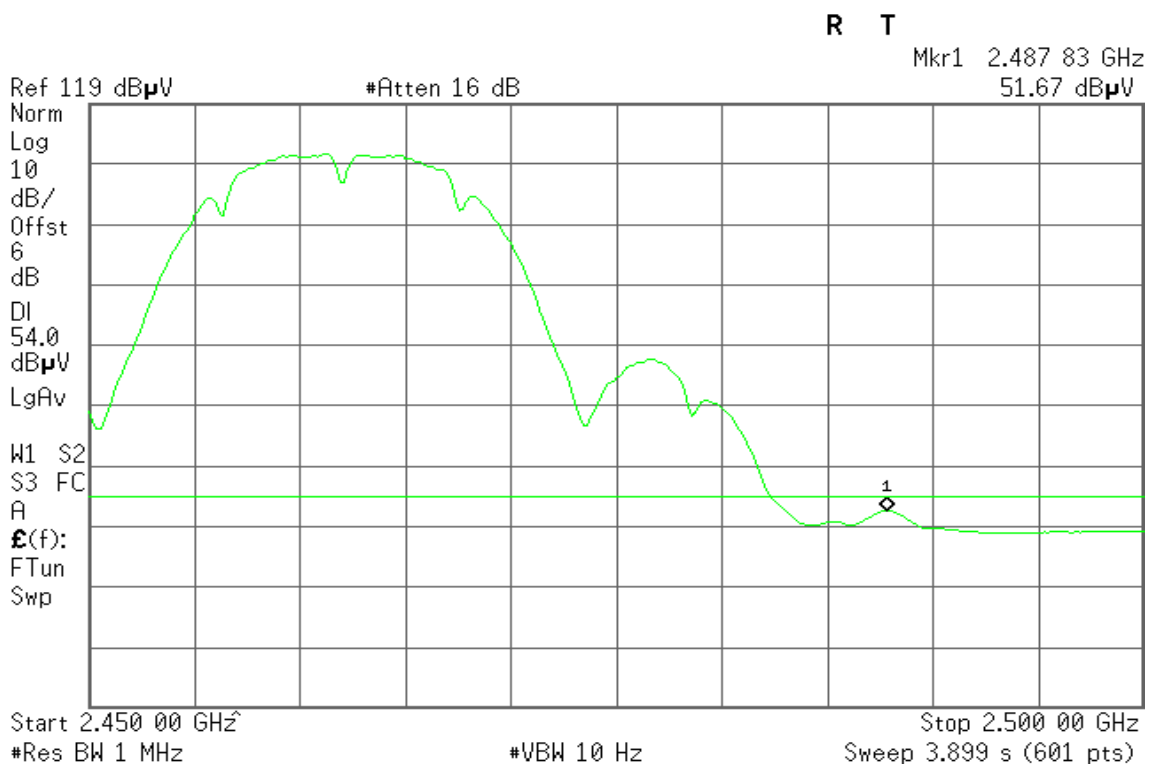



Detector mode: Peak

Polarity: Horizontal

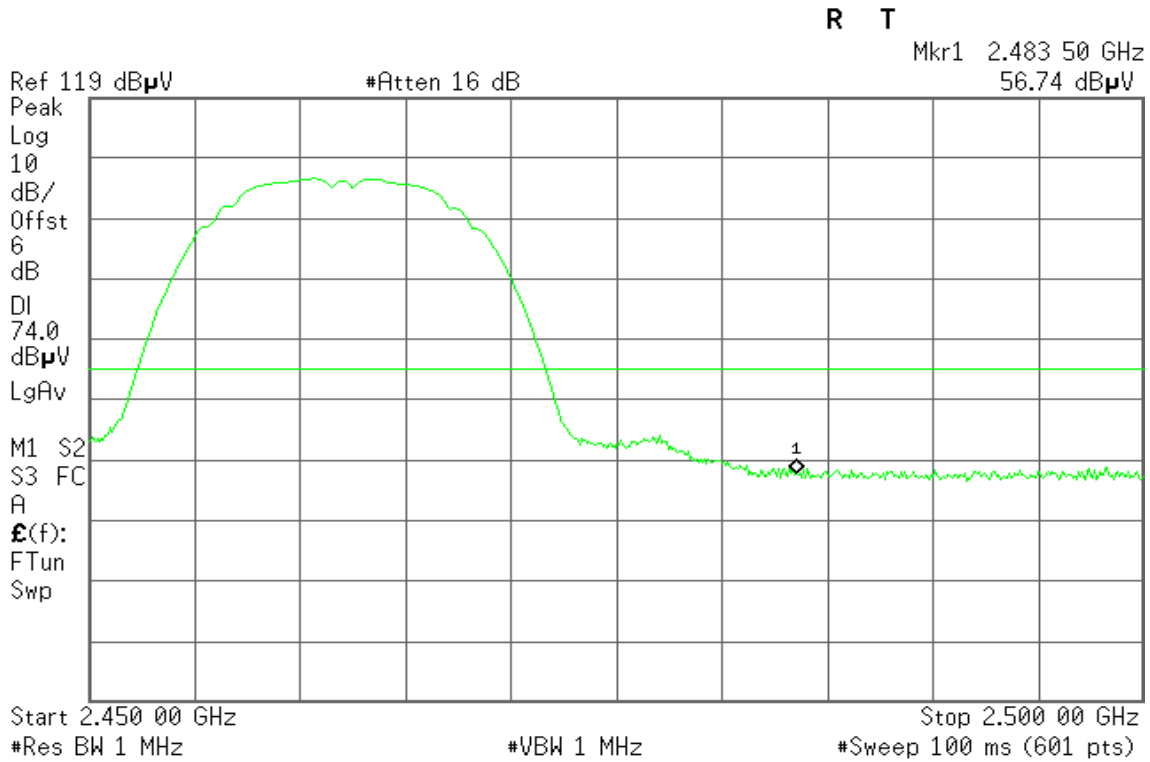

Detector mode: Average

Polarity: Horizontal

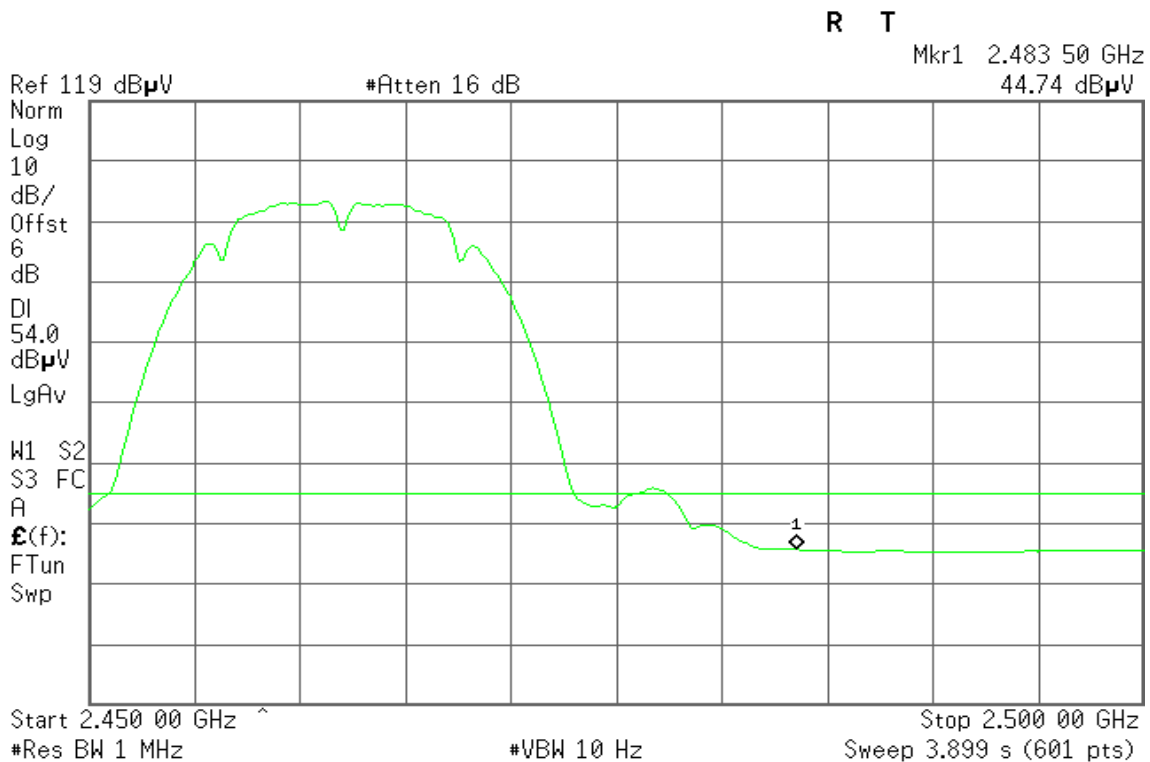



Band Edges (IEEE 802.11g mode / CH Low)

Detector mode: Peak

Polarity: Vertical

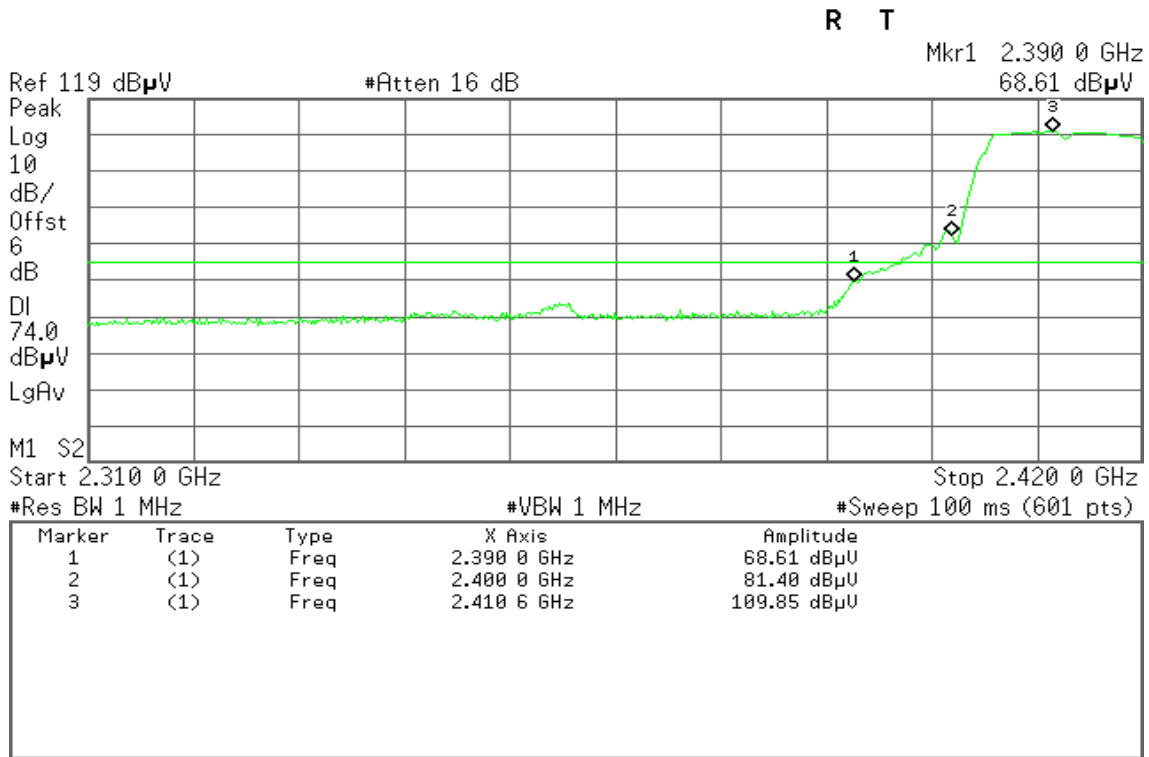

Detector mode: Average

Polarity: Vertical

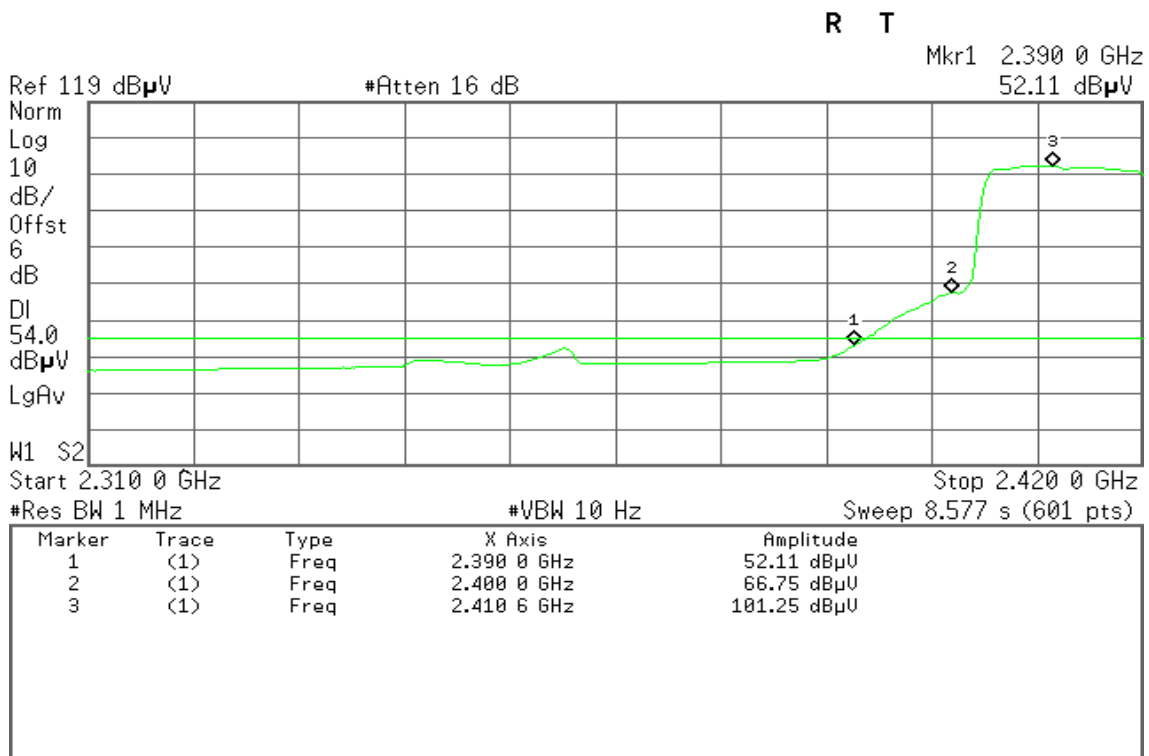



Detector mode: Peak

Polarity: Horizontal

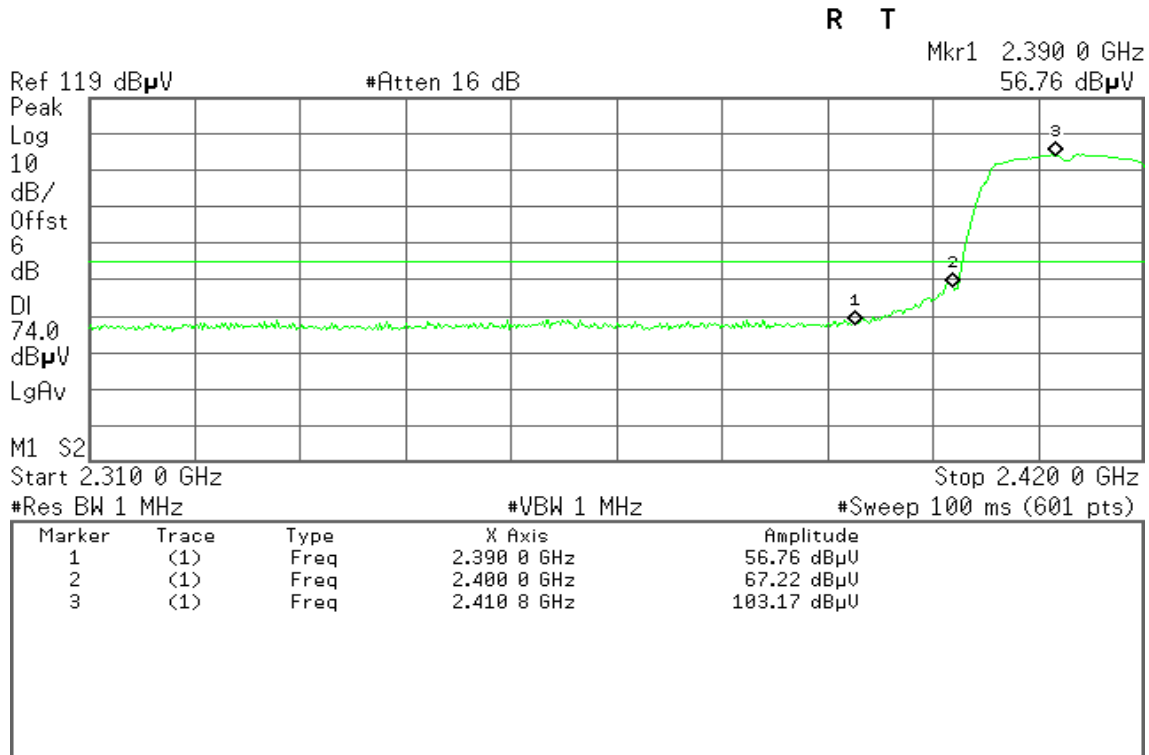

Detector mode: Average

Polarity: Horizontal

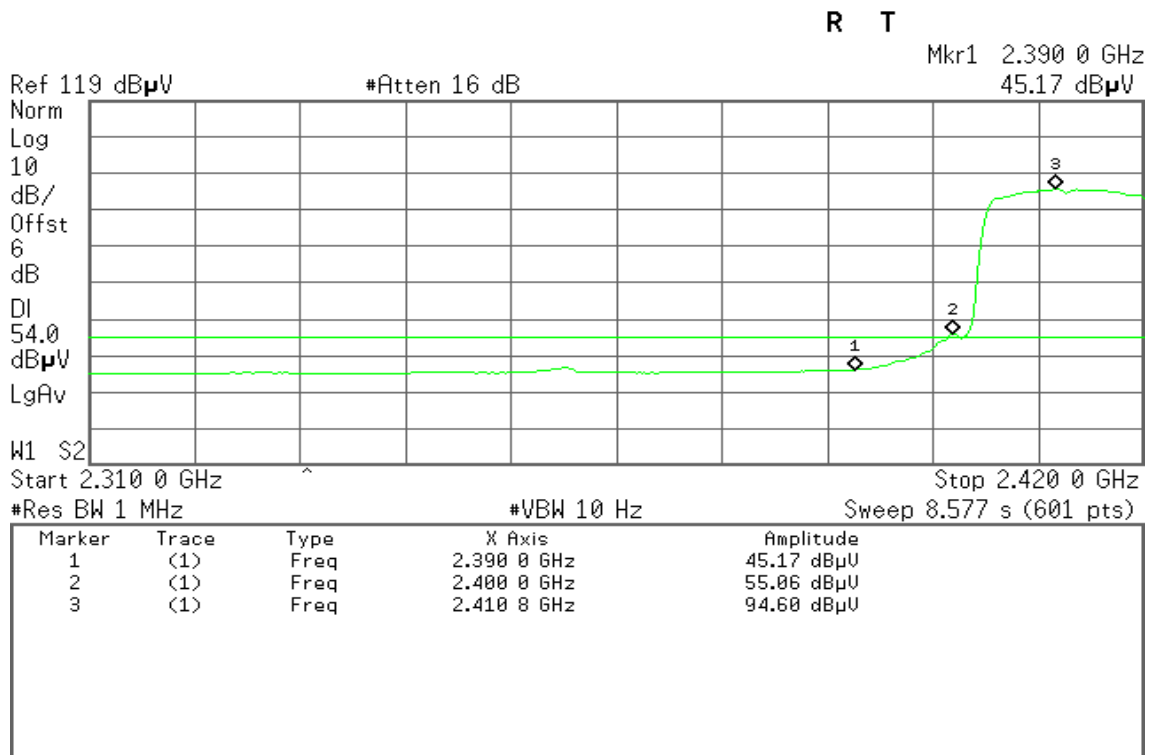



Band Edges (IEEE 802.11g mode / CH High)

Detector mode: Peak

Polarity: Vertical

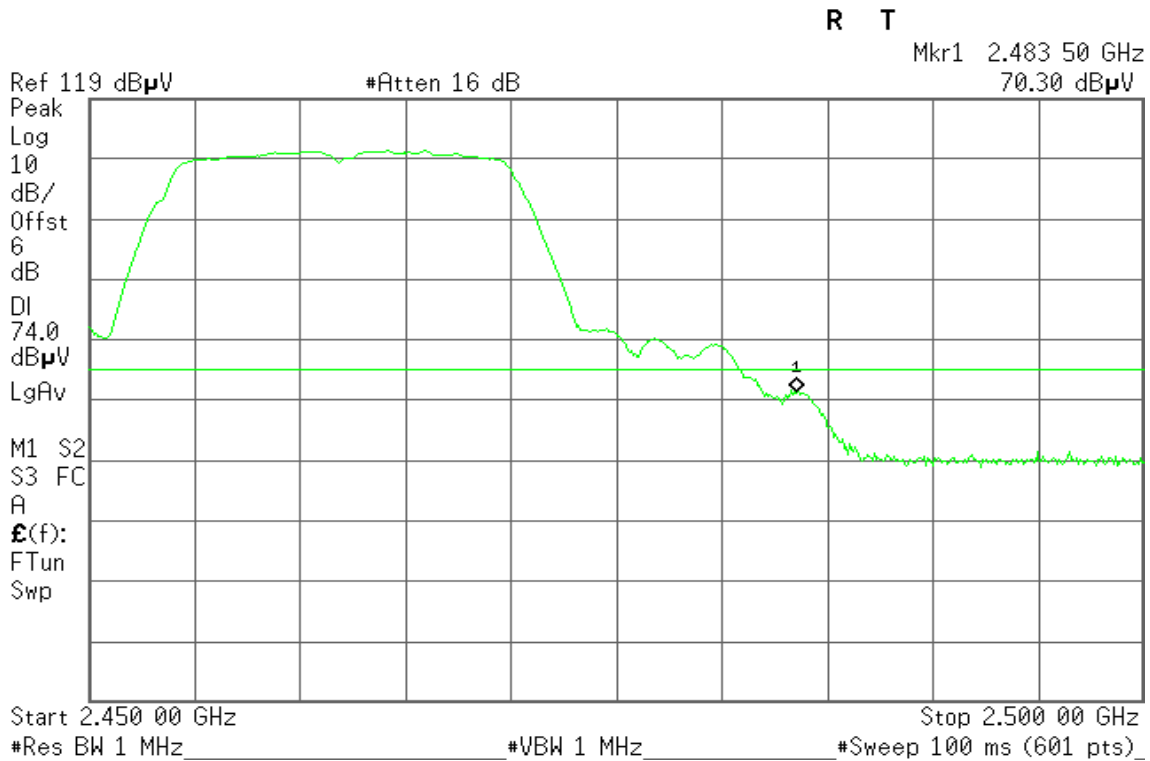

Detector mode: Average

Polarity: Vertical

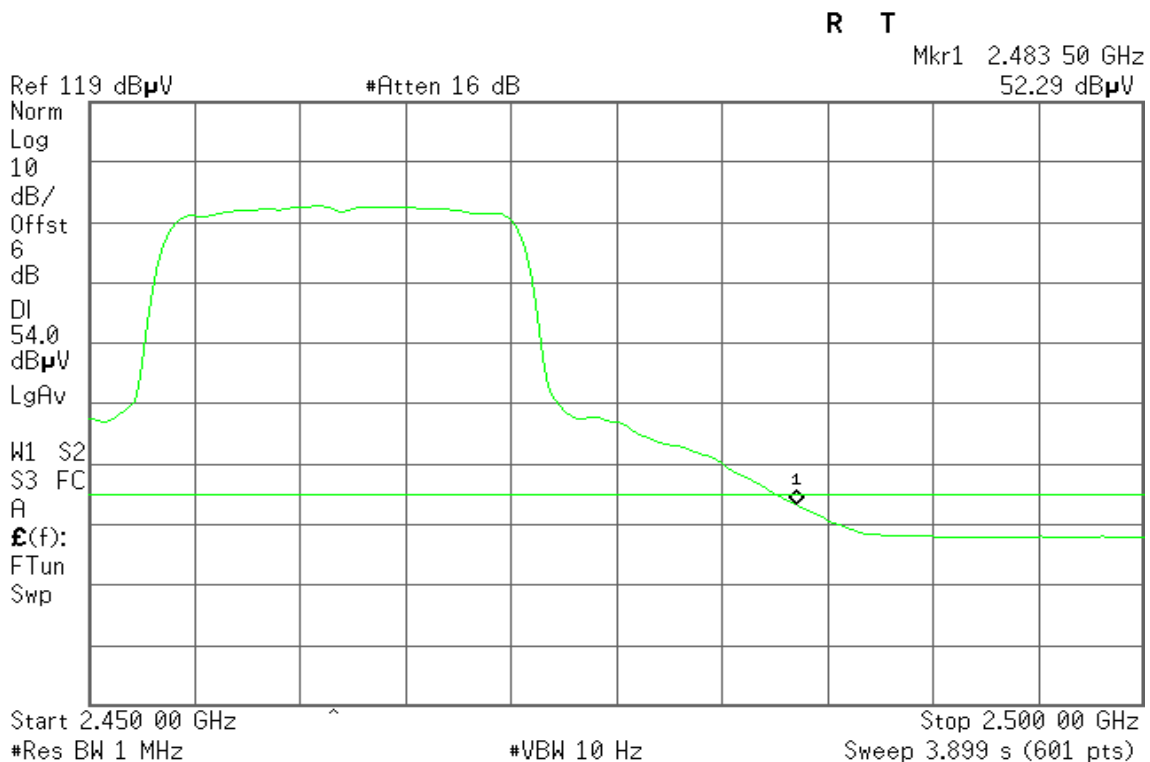



Detector mode: Peak

Polarity: Horizontal

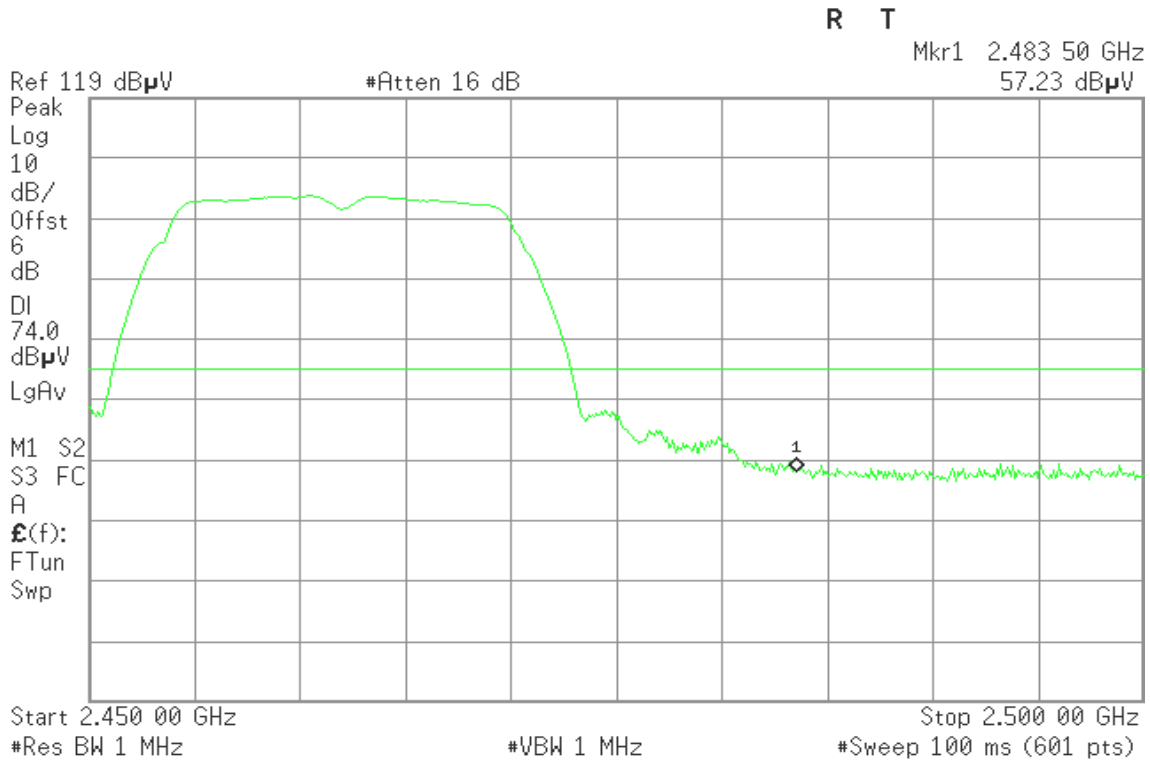

Detector mode: Average

Polarity: Horizontal

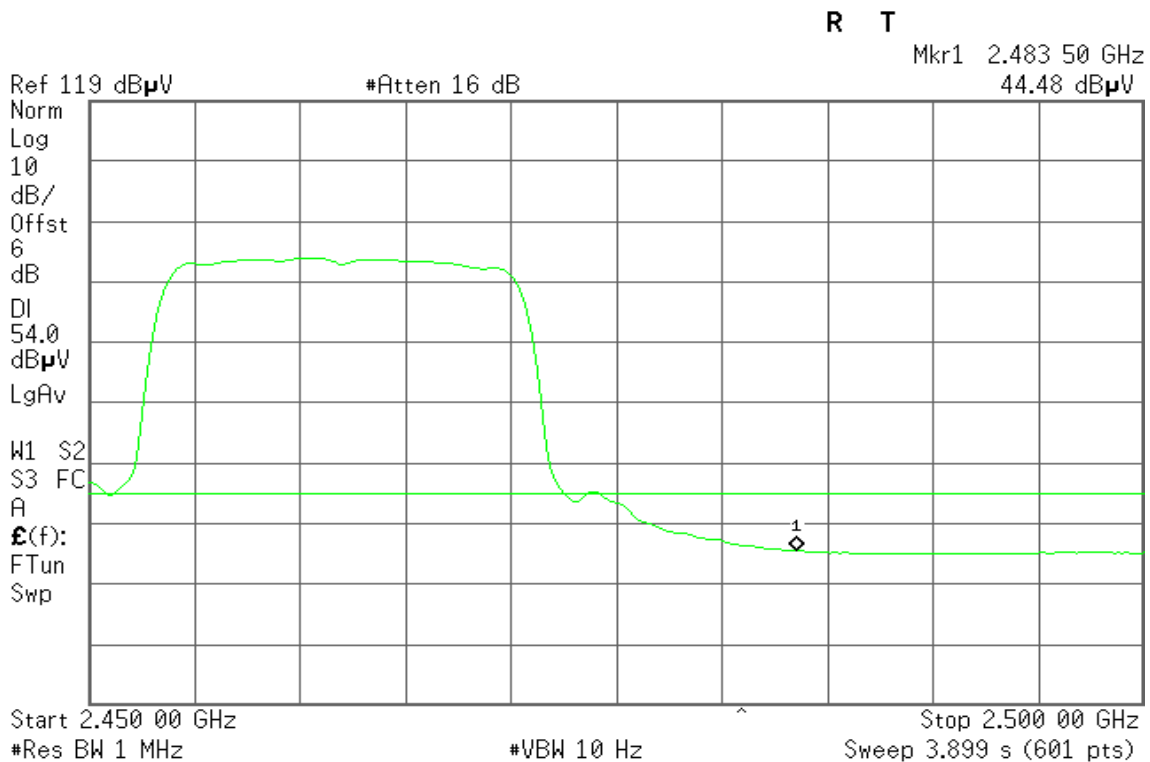



Band Edges (Standard 802.11n 20 MHz mode / CH Low)

Detector mode: Peak

Polarity: Vertical

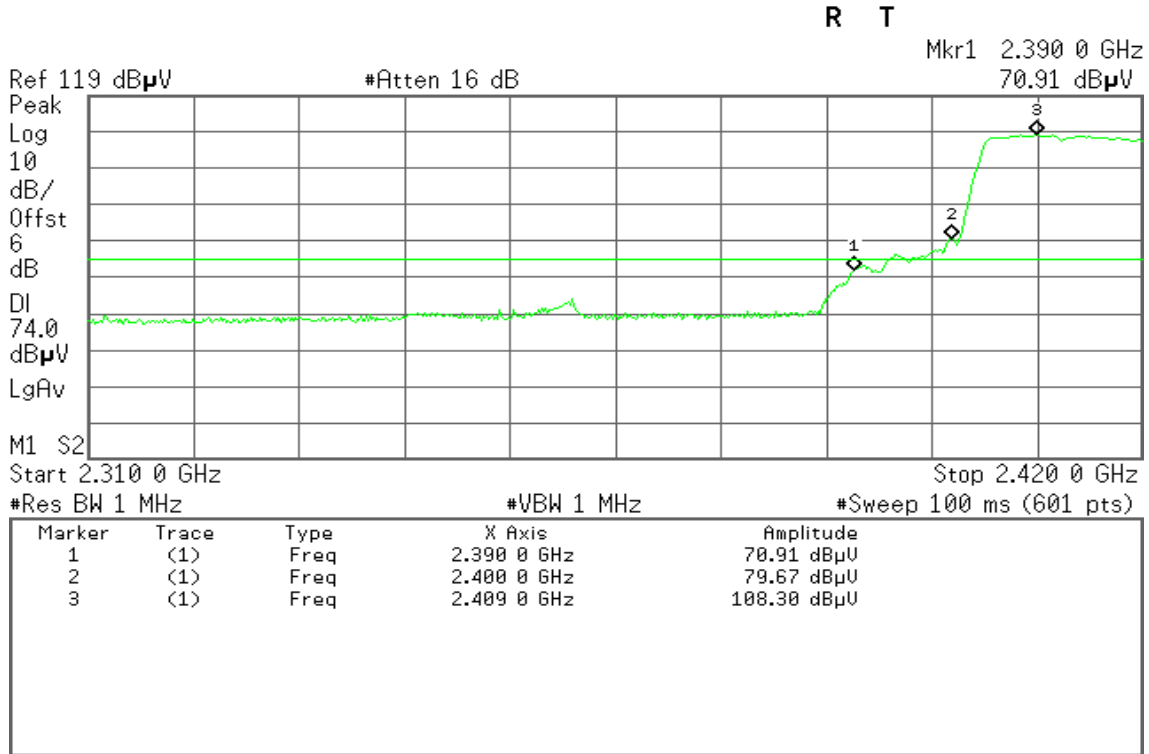

Detector mode: Average

Polarity: Vertical

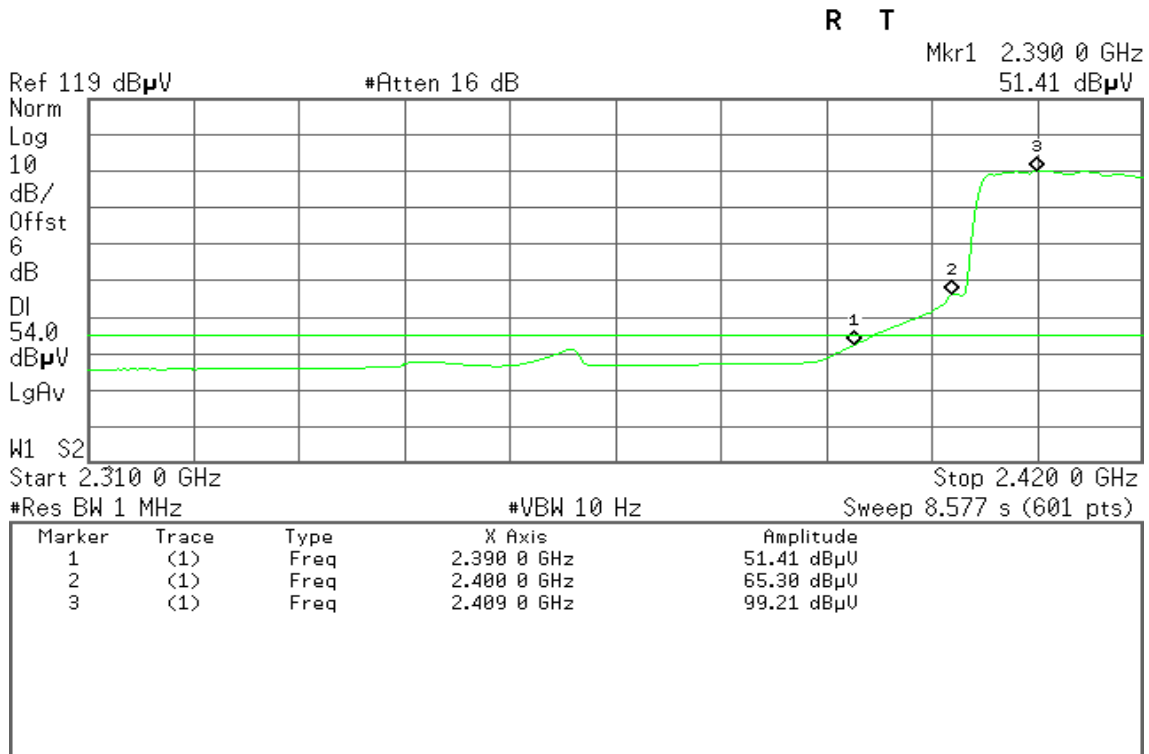



Detector mode: Peak

Polarity: Horizontal

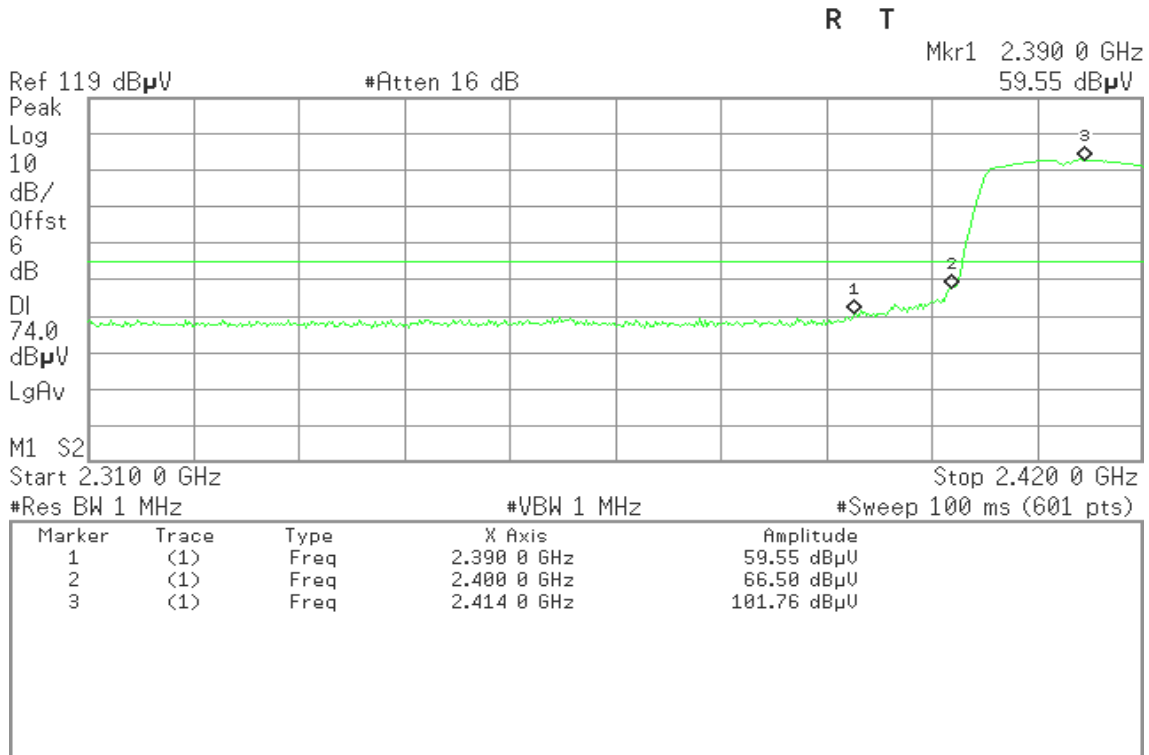

Detector mode: Average

Polarity: Horizontal

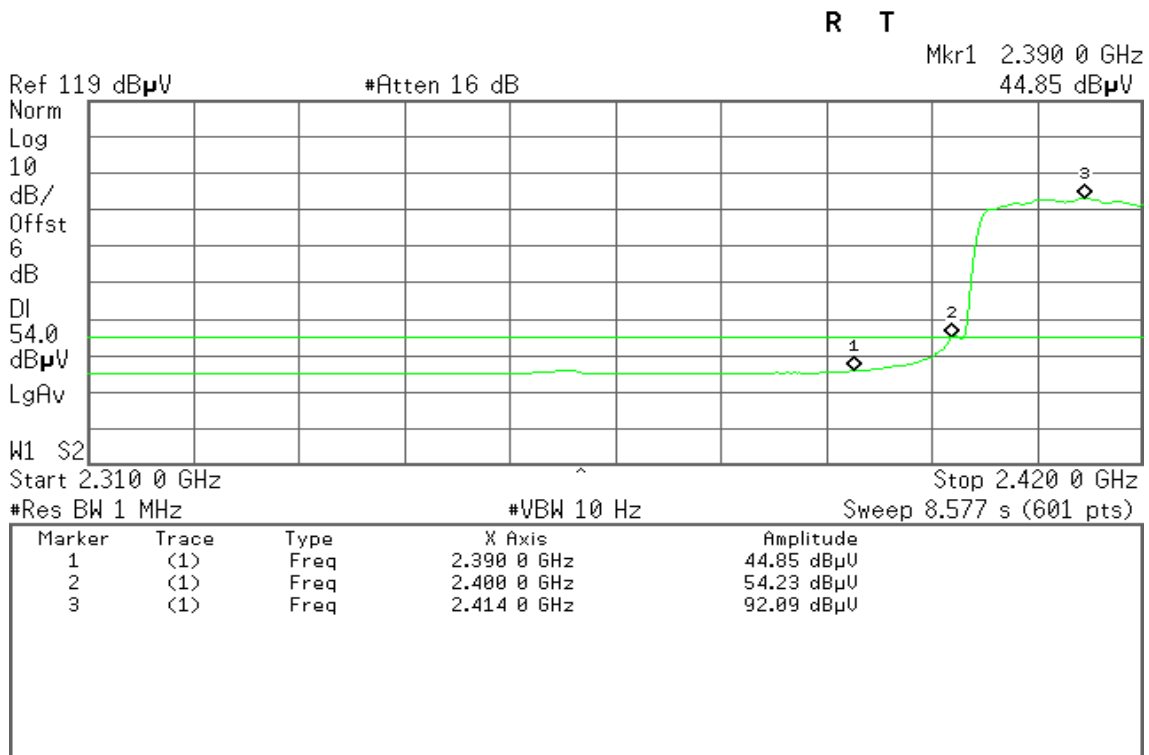



Band Edges (Standard 802.11n 20 MHz mode / CH High)

Detector mode: Peak

Polarity: Vertical

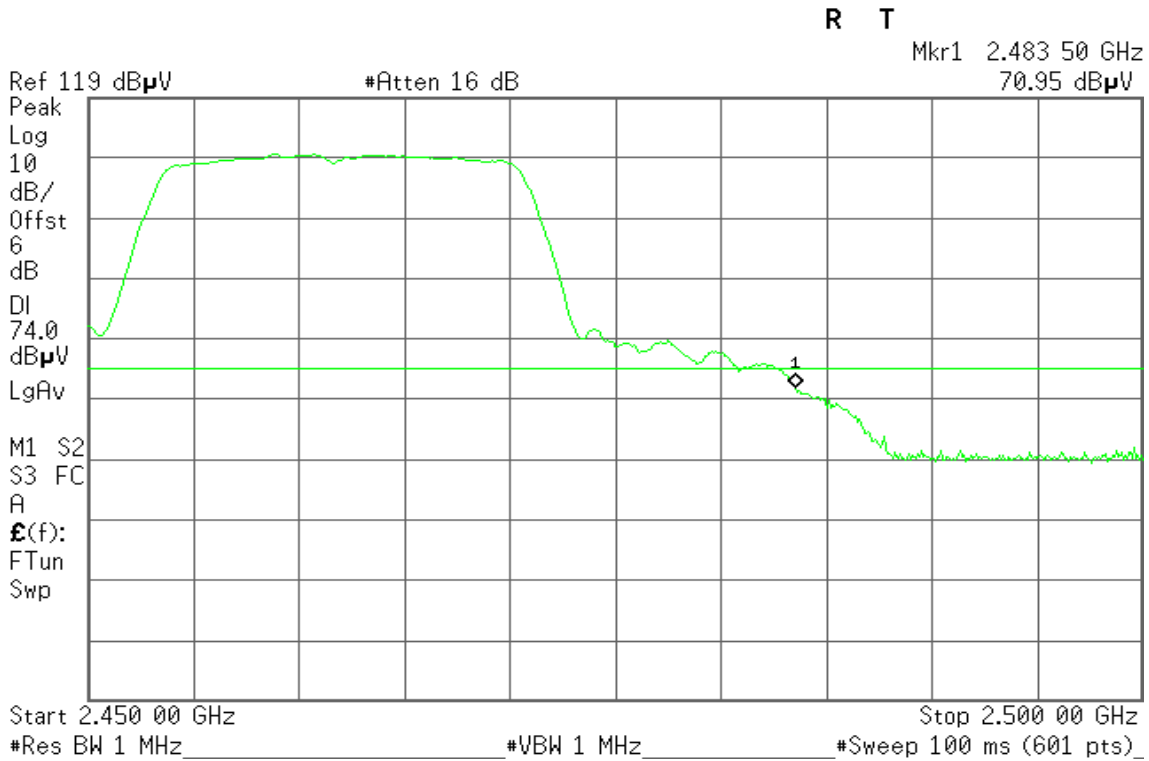

Detector mode: Average

Polarity: Vertical

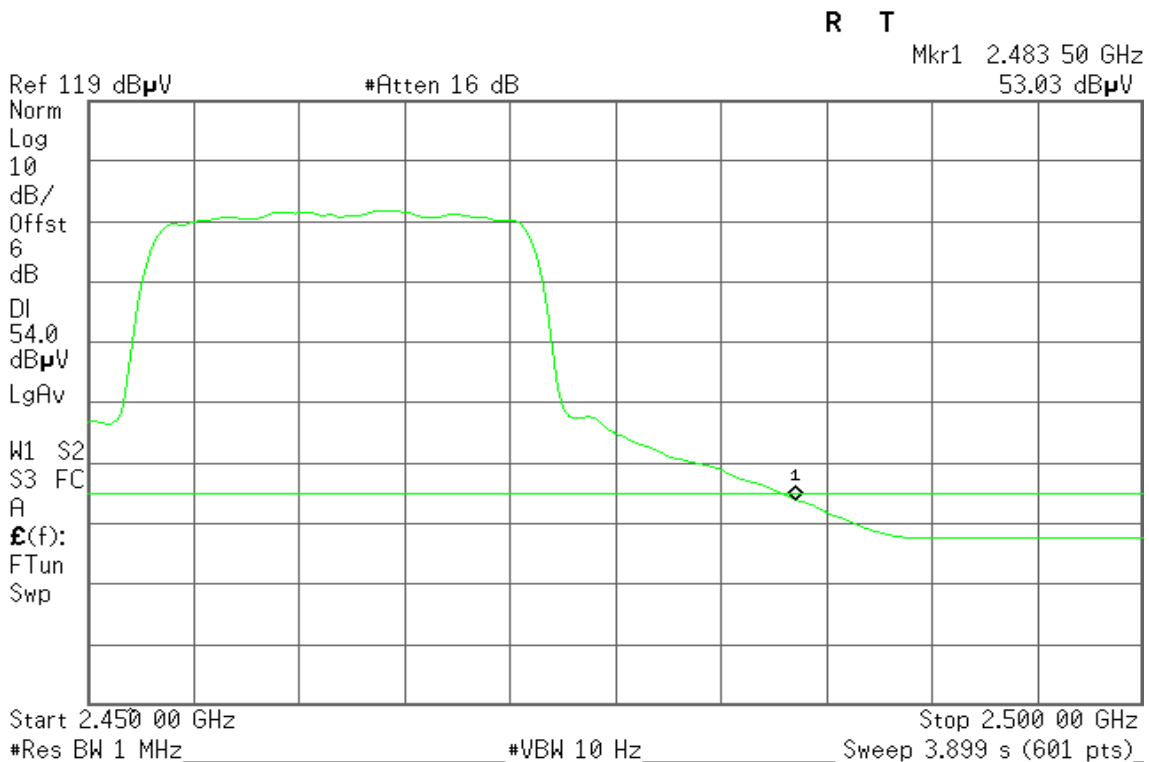



Detector mode: Peak

Polarity: Horizontal

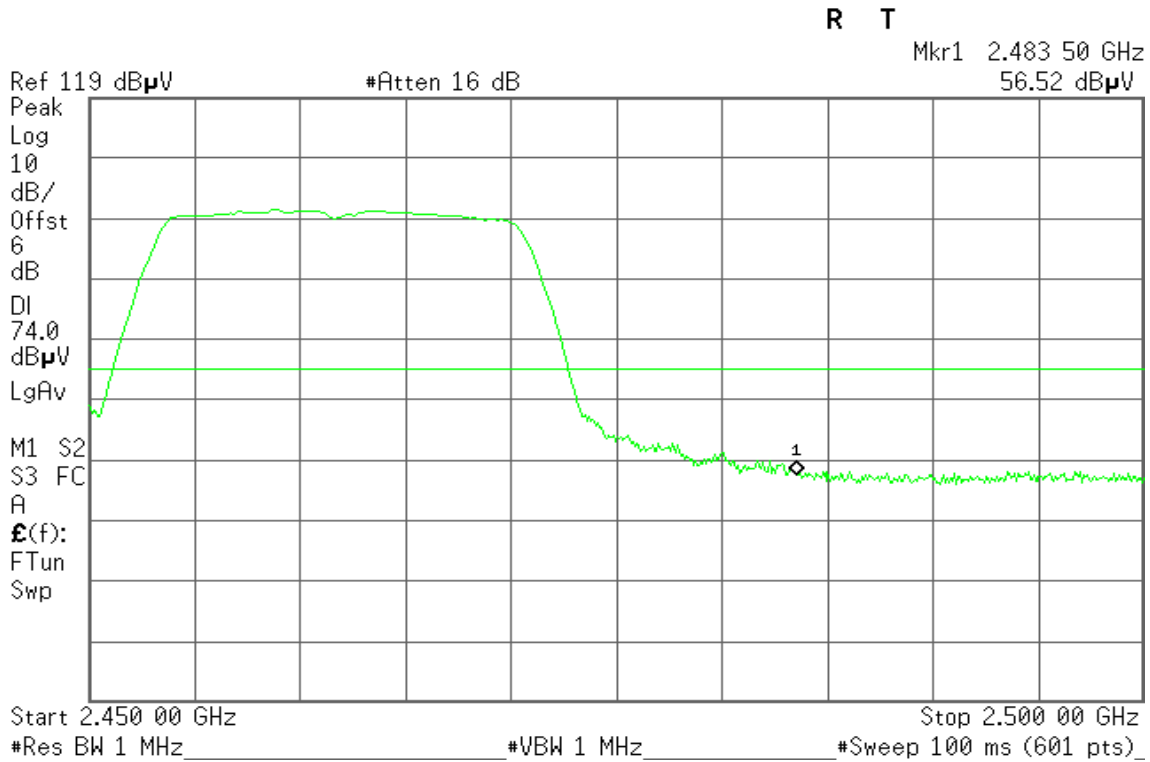

Detector mode: Average

Polarity: Horizontal

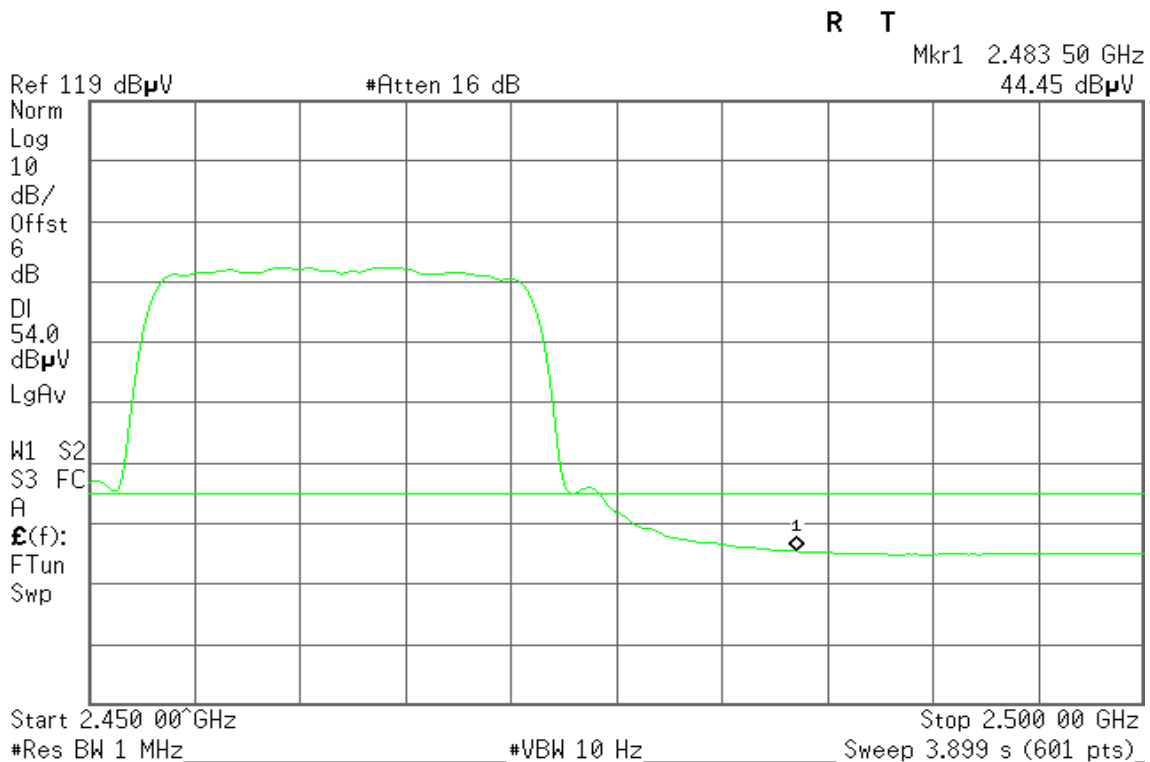



Band Edges (Standard 802.11n wide 40 MHz mode / CH Low)

Detector mode: Peak

Polarity: Vertical

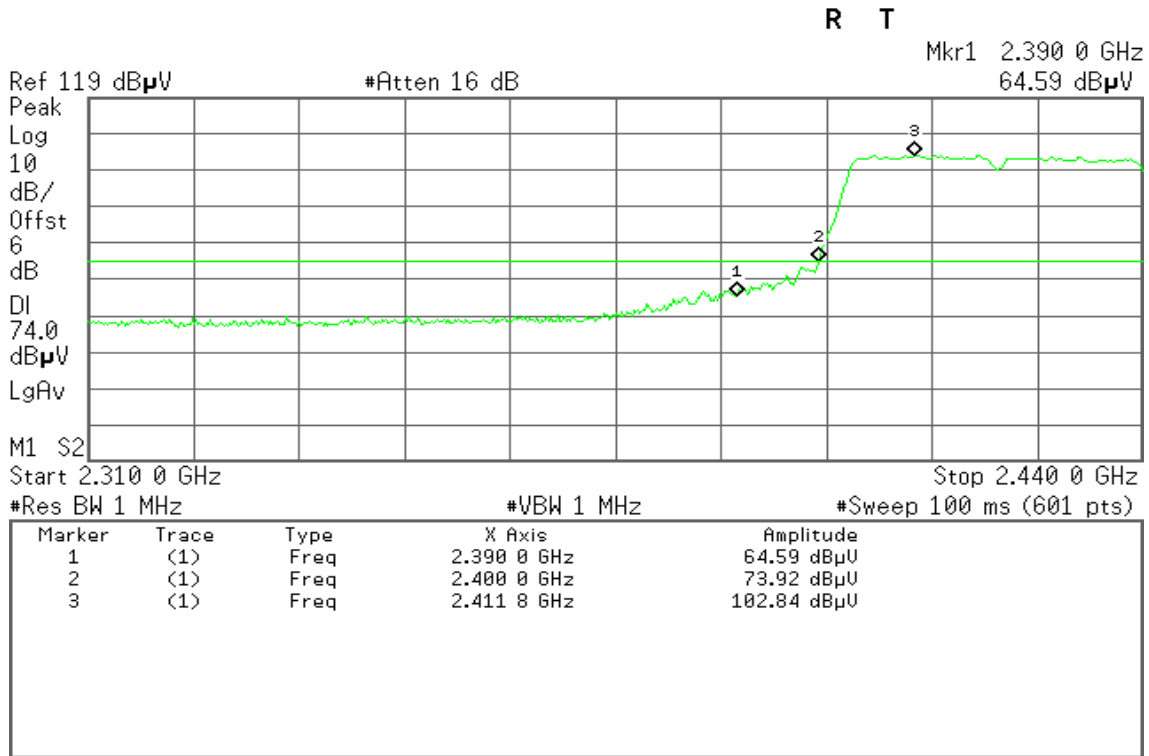

Detector mode: Average

Polarity: Vertical

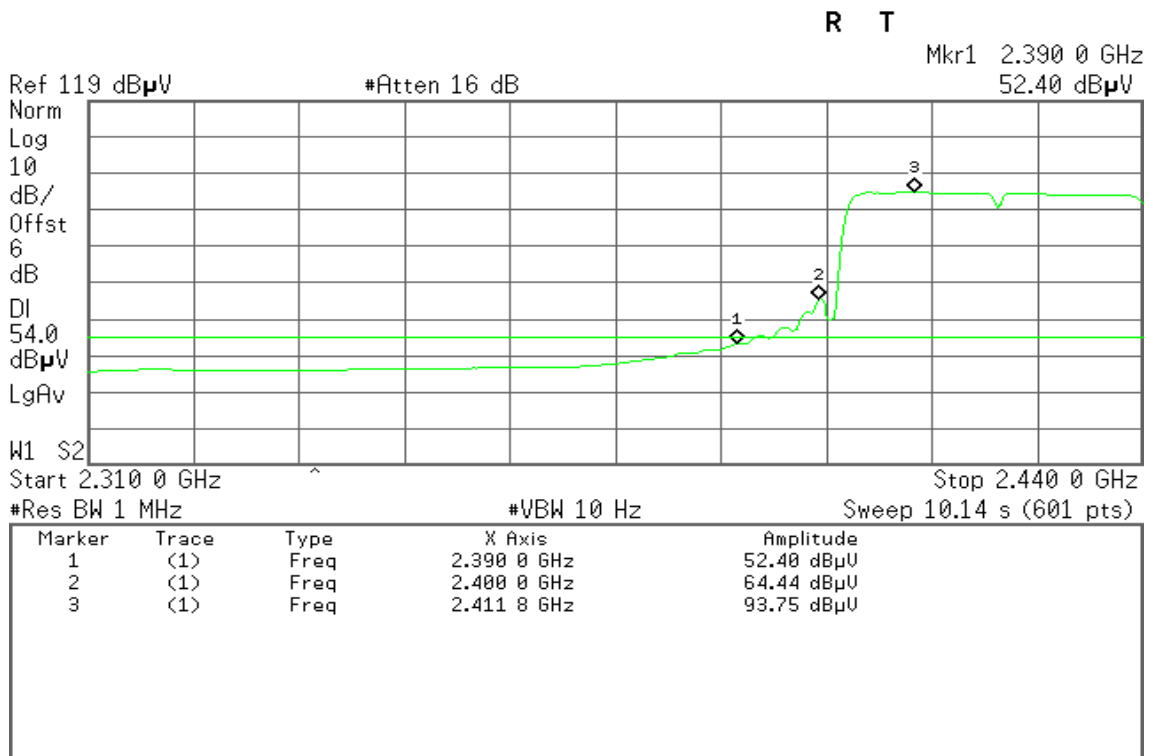



Detector mode: Peak

Polarity: Horizontal

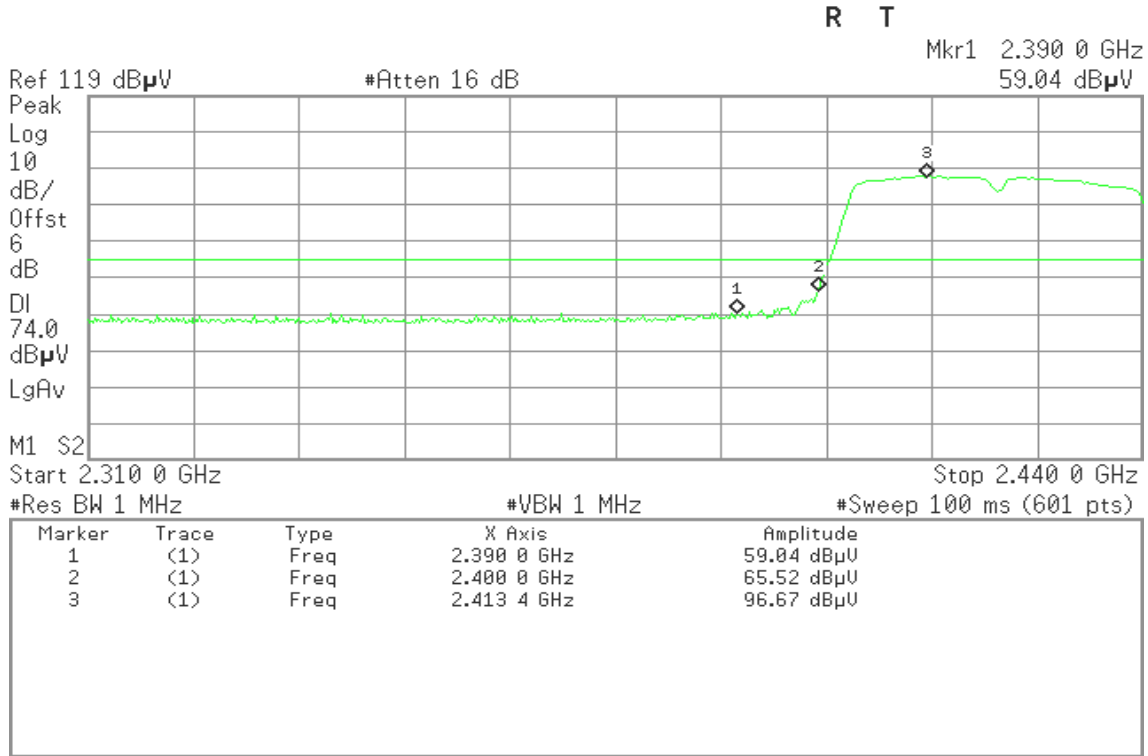

Detector mode: Average

Polarity: Horizontal

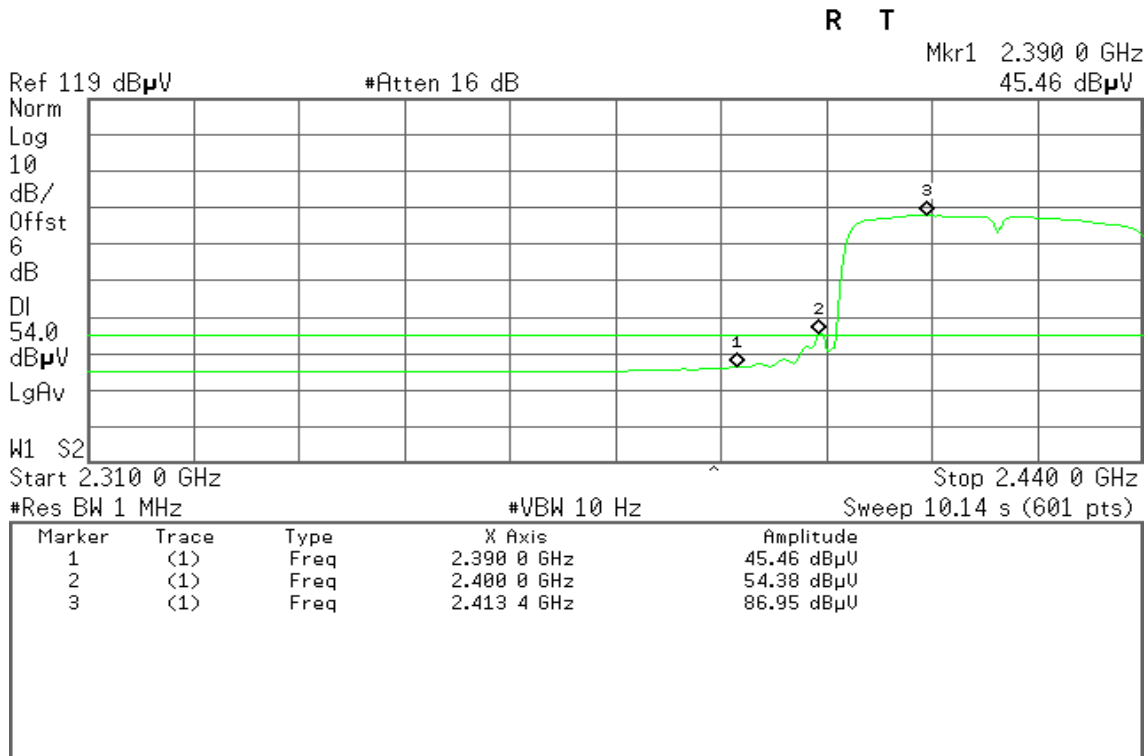



Band Edges (Standard 802.11n wide 40 MHz mode / CH High)

Detector mode: Peak

Polarity: Vertical

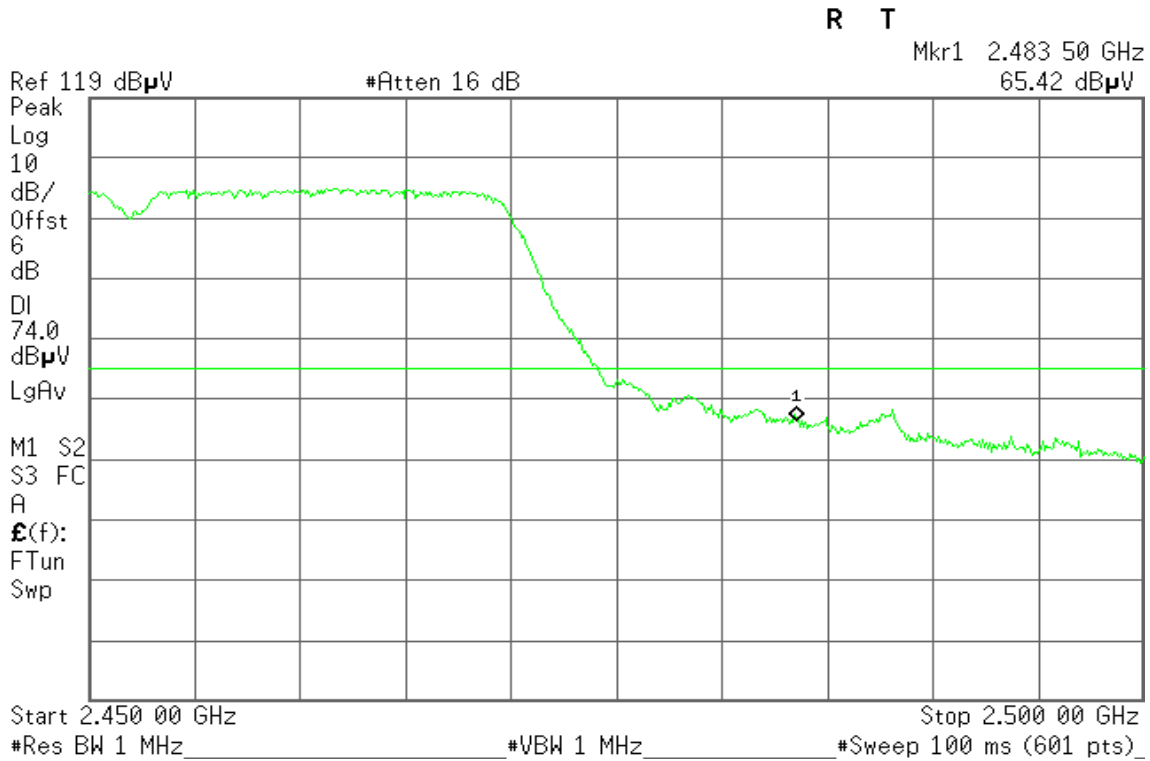

Detector mode: Average

Polarity: Vertical

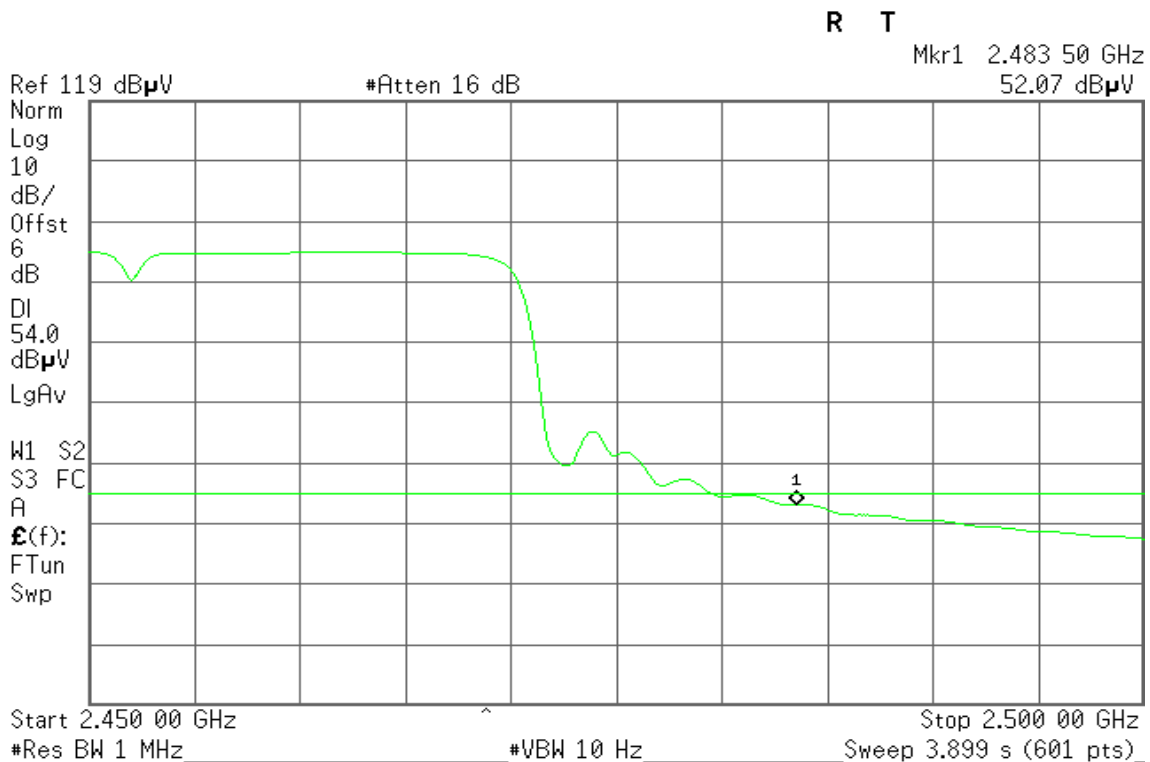



Detector mode: Peak

Polarity: Horizontal

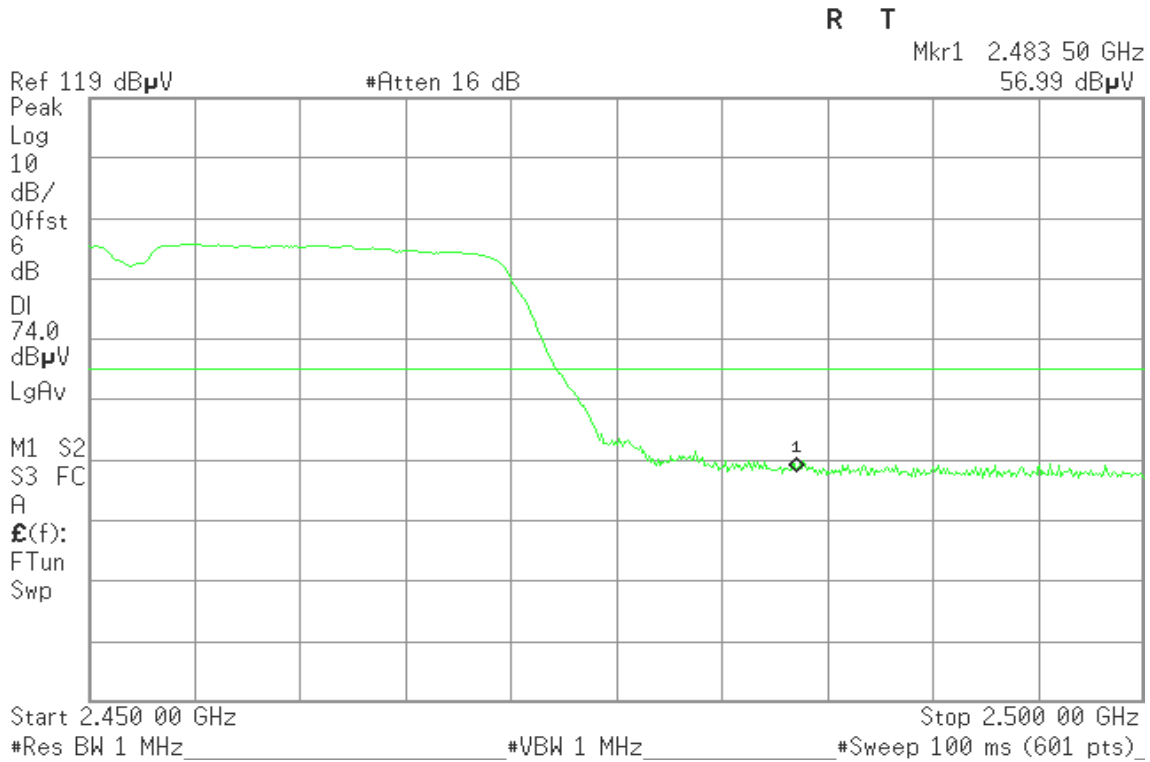

Detector mode: Average

Polarity: Horizontal

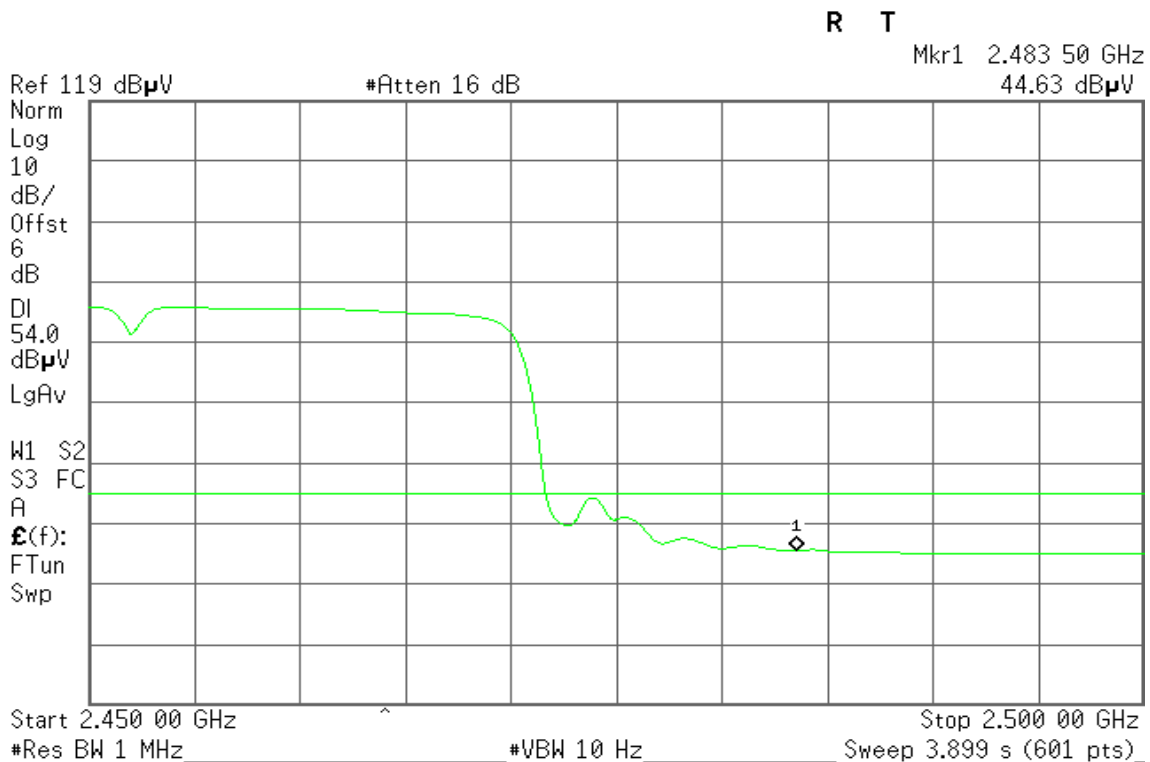



7.4 RADIATED EMISSIONS

LIMIT

1. According to §15.209(a), except as provided elsewhere in this Subpart, the emissions from an intentional radiator shall not exceed the field strength levels specified in the following table:

Frequency (MHz)	Field Strength ($\mu\text{V}/\text{m}$)	Measurement Distance (m)
30-88	100*	3
88-216	150*	3
216-960	200*	3
Above 960	500	3

Remark: Except as provided in paragraph (g), fundamental emissions from intentional radiators operating under this Section shall not be located in the frequency bands 54-72 MHz, 76-88 MHz, 174-216 MHz or 470-806 MHz. However, operation within these frequency bands is permitted under other sections of this Part, e.g., Sections 15.231 and 15.241.

2. In the emission table above, the tighter limit applies at the band edges.

Frequency (MHz)	Field Strength ($\mu\text{V}/\text{m}$ at 3-meter)	Field Strength (dB $\mu\text{V}/\text{m}$ at 3-meter)
30-88	100	40
88-216	150	43.5
216-960	200	46
Above 960	500	54



Test Configuration

9kHz ~ 30MHz

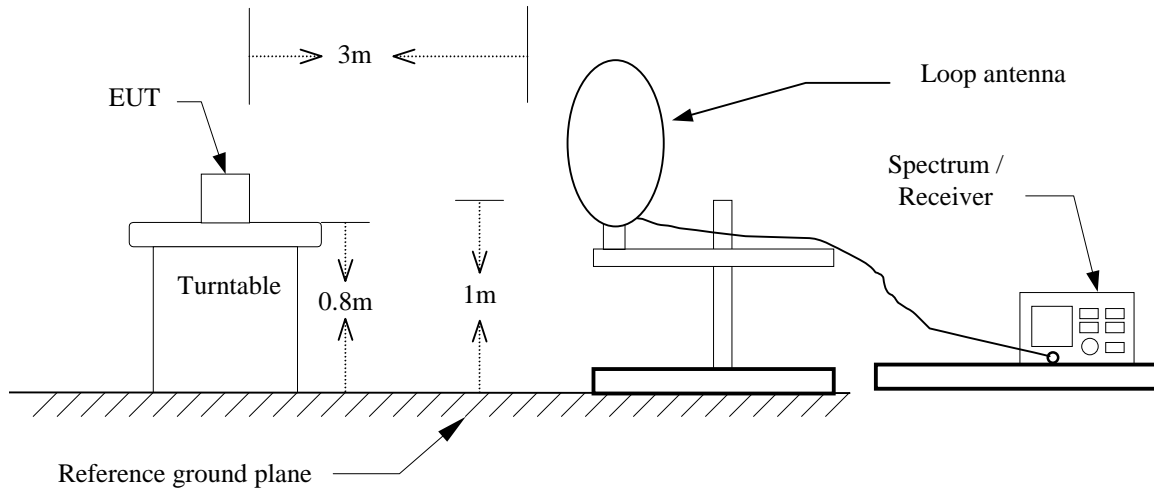

30MHz ~ 1GHz

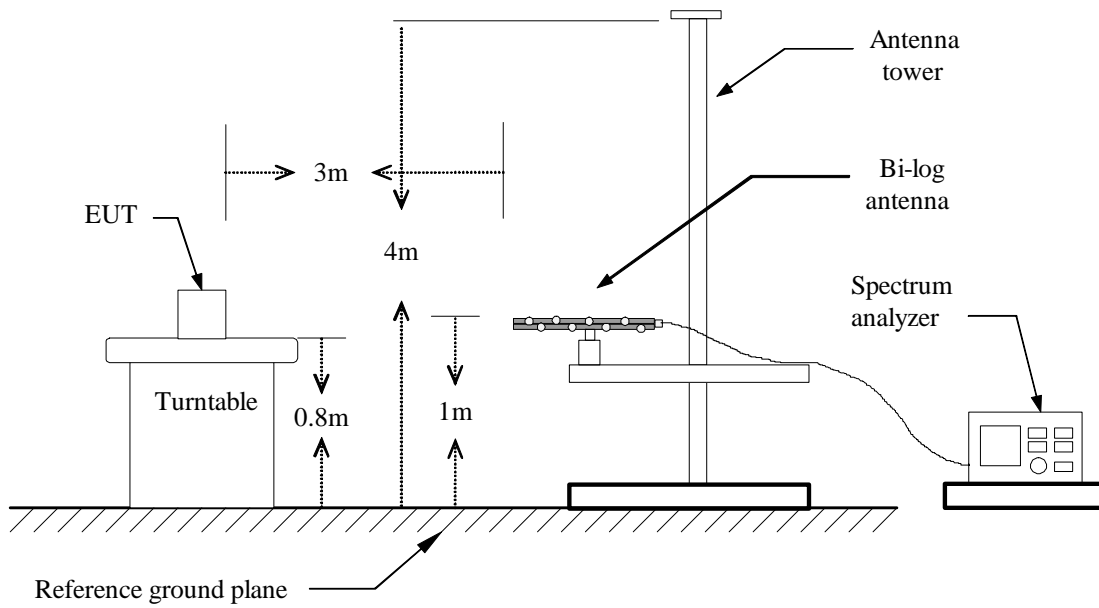



Above 1 GHz

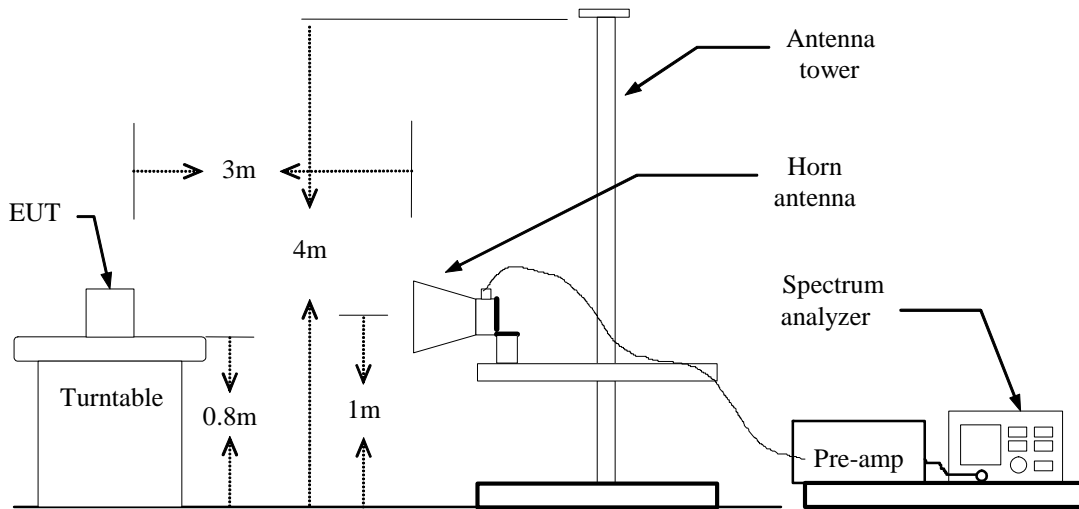



TEST PROCEDURE

1. The EUT is placed on a turntable, which is 0.8m above ground plane.
2. The turntable shall be rotated for 360 degrees to determine the position of maximum emission level.
3. EUT is set 3m away from the receiving antenna, which is varied from 1m to 4m to find out the highest emissions.
4. Maximum procedure was performed on the six highest emissions to ensure EUT compliance.
5. And also, each emission was to be maximized by changing the polarization of receiving antenna both horizontal and vertical.
6. Set the spectrum analyzer in the following setting as:
Below 1GHz:
RBW=100kHz / VBW=300kHz / Sweep=AUTO
Above 1GHz:
(a) PEAK: RBW=VBW=1MHz / Sweep=AUTO
(b) AVERAGE: RBW=1MHz / VBW=10Hz / Sweep=AUTO
7. Repeat above procedures until the measurements for all frequencies are complete.



TEST RESULTS

Below 1GHz

Operation Mode: Normal Link

Test Date: October 21, 2010

Temperature: 23°C

Tested by: Tom Jen

Humidity: 40% RH

Polarity: Ver. / Hor.

Frequency (MHz)	Ant. Pol. (H/V)	Reading (dBuV)	Correction Factor (dB/m)	Result (dBuV/m)	Limit (dBuV/m)	Margin (dB)	Remark
94.67	V	44.65	-14.35	30.30	43.50	-13.20	Peak
201.37	V	38.42	-10.03	28.40	43.50	-15.10	Peak
432.55	V	40.30	-6.29	34.02	46.00	-11.98	Peak
497.22	V	38.82	-5.19	33.63	46.00	-12.37	Peak
563.50	V	36.29	-4.36	31.93	46.00	-14.07	Peak
663.73	V	38.83	-2.79	36.04	46.00	-9.96	Peak
191.67	H	42.05	-10.63	31.42	43.50	-12.08	Peak
332.32	H	40.62	-8.47	32.15	46.00	-13.85	Peak
400.22	H	38.26	-7.08	31.18	46.00	-14.82	Peak
432.55	H	36.82	-6.29	30.54	46.00	-15.46	Peak
500.45	H	36.77	-5.14	31.62	46.00	-14.38	Peak
663.73	H	42.33	-2.79	39.53	46.00	-6.47	Peak

Remark:

1. No emission found between lowest internal used/generated frequency to 30MHz (9kHz~30MHz)
2. Radiated emissions measured in frequency range from 30 MHz to 1000MHz were made with an instrument using peak/quasi-peak detector mode.
3. Quasi-peak test would be performed if the peak result were greater than the quasi-peak limit or as required by the applicant.
4. Measurements above show only up to 6 maximum emissions noted, or would be lesser, with " N/A " remark, if no specific emissions from the EUT are recorded (ie: margin>20dB from the applicable limit) and considered that's already beyond the background noise floor.
5. Margin (dB) = Result (dBuV/m) – Limit (dBuV/m).



Above 1 GHz

Operation Mode: TX / IEEE 802.11b / CH Low

Test Date: October 21, 2010

Temperature: 23°C

Tested by: Tom Jen

Humidity: 40 % RH

Polarity: Ver. / Hor.

Frequency (MHz)	Ant. Pol. (H/V)	Reading (Peak) (dBuV)	Reading (Average) (dBuV)	Correction Factor (dB/m)	Result (Peak) (dBuV/m)	Result (Average) (dBuV/m)	Limit (Peak) (dBuV/m)	Limit (Average) (dBuV/m)	Margin (dB)	Remark
1450.00	V	59.44	---	-8.84	50.59	---	74.00	54.00	-3.41	Peak
4825.00	V	52.24	50.22	1.18	53.42	51.40	74.00	54.00	-0.58	Peak
7233.33	V	49.25	42.22	5.24	54.49	47.46	74.00	54.00	-6.54	AVG
N/A										
1650.00	H	58.12	---	-7.38	50.74	---	74.00	54.00	-3.26	Peak
4825.00	H	52.64	49.16	1.18	53.81	50.34	74.00	54.00	-0.19	Peak
N/A										

Remark:

1. Measuring frequencies from 1 GHz to the 10th harmonic of highest fundamental frequency.
2. Radiated emissions measured in frequency above 1000MHz were made with an instrument using peak/average detector mode.
3. Average test would be performed if the peak result were greater than the average limit or as required by the applicant.
4. Data of measurement within this frequency range shown " --- " in the table above means the reading of emissions are attenuated more than 20dB below the permissible limits or the field strength is too small to be measured.
5. Measurements above show only up to 6 maximum emissions noted, or would be lesser; with " N/A " remark, if no specific emissions from the EUT are recorded (ie: margin>20dB from the applicable limit) and considered that's already beyond the background noise floor.
6. Margin (dB) = Remark result (dBuV/m) – Average limit (dBuV/m).



Operation Mode: TX / IEEE 802.11b / CH Mid

Test Date: October 21, 2010

Temperature: 23°C

Tested by: Tom Jen

Humidity: 40 % RH

Polarity: Ver. / Hor.

Frequency (MHz)	Ant. Pol. (H/V)	Reading (Peak) (dBuV)	Reading (Average) (dBuV)	Correction Factor (dB/m)	Result (Peak) (dBuV/m)	Result (Average) (dBuV/m)	Limit (Peak) (dBuV/m)	Limit (Average) (dBuV/m)	Margin (dB)	Remark
1306.67	V	58.51	---	-9.08	49.43	---	74.00	54.00	-4.57	Peak
4875.00	V	51.98	50.72	1.16	53.14	51.88	74.00	54.00	-0.86	Peak
7308.33	V	47.69	40.49	5.29	52.98	45.78	74.00	54.00	-1.02	Peak
N/A										
1326.67	H	58.99	---	-9.05	49.94	---	74.00	54.00	-4.06	Peak
1376.67	H	59.14	---	-8.96	50.18	---	74.00	54.00	-3.82	Peak
4875.00	H	52.23	49.53	1.16	53.39	50.69	74.00	54.00	-0.61	Peak
N/A										

Remark:

1. Measuring frequencies from 1 GHz to the 10th harmonic of highest fundamental frequency.
2. Radiated emissions measured in frequency above 1000MHz were made with an instrument using peak/average detector mode.
3. Average test would be performed if the peak result were greater than the average limit or as required by the applicant.
4. Data of measurement within this frequency range shown " --- " in the table above means the reading of emissions are attenuated more than 20dB below the permissible limits or the field strength is too small to be measured.
5. Measurements above show only up to 6 maximum emissions noted, or would be lesser, with " N/A " remark, if no specific emissions from the EUT are recorded (ie: margin > 20dB from the applicable limit) and considered that's already beyond the background noise floor.
6. Margin (dB) = Remark result (dBuV/m) – Average limit (dBuV/m).



Operation Mode: TX / IEEE 802.11b / CH High

Test Date: October 21, 2010

Temperature: 23°C

Tested by: Tom Jen

Humidity: 40 % RH

Polarity: Ver. / Hor.

Frequency (MHz)	Ant. Pol. (H/V)	Reading (Peak) (dBuV)	Reading (Average) (dBuV)	Correction Factor (dB/m)	Result (Peak) (dBuV/m)	Result (Average) (dBuV/m)	Limit (Peak) (dBuV/m)	Limit (Average) (dBuV/m)	Margin (dB)	Remark
1333.33	V	58.13	---	-9.04	49.09	---	74.00	54.00	-4.91	Peak
4925.00	V	53.71	50.74	1.14	54.85	51.88	74.00	54.00	-2.12	AVG
7383.33	V	49.73	40.30	5.34	55.07	45.64	74.00	54.00	-8.36	AVG
N/A										
1446.67	H	59.79	---	-8.85	50.94	---	74.00	54.00	-3.06	Peak
4925.00	H	53.34	50.21	1.14	54.49	51.35	74.00	54.00	-2.65	AVG
N/A										

Remark:

1. Measuring frequencies from 1 GHz to the 10th harmonic of highest fundamental frequency.
2. Radiated emissions measured in frequency above 1000MHz were made with an instrument using peak/average detector mode.
3. Average test would be performed if the peak result were greater than the average limit or as required by the applicant.
4. Data of measurement within this frequency range shown " --- " in the table above means the reading of emissions are attenuated more than 20dB below the permissible limits or the field strength is too small to be measured.
5. Measurements above show only up to 6 maximum emissions noted, or would be lesser, with " N/A " remark, if no specific emissions from the EUT are recorded (ie: margin>20dB from the applicable limit) and considered that's already beyond the background noise floor.
6. Margin (dB) = Remark result (dBuV/m) – Average limit (dBuV/m).



Operation Mode: TX / IEEE 802.11g / CH Low

Test Date: October 21, 2010

Temperature: 23°C

Tested by: Tom Jen

Humidity: 40 % RH

Polarity: Ver. / Hor.

Frequency (MHz)	Ant. Pol. (H/V)	Reading (Peak) (dBuV)	Reading (Average) (dBuV)	Correction Factor (dB/m)	Result (Peak) (dBuV/m)	Result (Average) (dBuV/m)	Limit (Peak) (dBuV/m)	Limit (Average) (dBuV/m)	Margin (dB)	Remark
1283.33	V	60.21	---	-9.12	51.09	---	74.00	54.00	-2.91	Peak
4825.00	V	55.16	44.72	1.18	56.34	45.90	74.00	54.00	-8.10	AVG
7233.33	V	54.71	45.20	5.24	59.95	50.44	74.00	54.00	-3.56	AVG
N/A										
1330.00	H	58.84	---	-9.04	49.79	---	74.00	54.00	-4.21	Peak
4825.00	H	54.61	43.23	1.18	55.79	44.41	74.00	54.00	-9.59	AVG
7233.33	H	52.24	41.40	5.24	57.49	46.64	74.00	54.00	-7.36	AVG
N/A										

Remark:

1. Measuring frequencies from 1 GHz to the 10th harmonic of highest fundamental frequency.
2. Radiated emissions measured in frequency above 1000MHz were made with an instrument using peak/average detector mode.
3. Average test would be performed if the peak result were greater than the average limit or as required by the applicant.
4. Data of measurement within this frequency range shown " --- " in the table above means the reading of emissions are attenuated more than 20dB below the permissible limits or the field strength is too small to be measured.
5. Measurements above show only up to 6 maximum emissions noted, or would be lesser, with " N/A " remark, if no specific emissions from the EUT are recorded (ie: margin > 20dB from the applicable limit) and considered that's already beyond the background noise floor.
6. Margin (dB) = Remark result (dBuV/m) – Average limit (dBuV/m).



Operation Mode: TX / IEEE 802.11g / CH Mid

Test Date: October 21, 2010

Temperature: 23°C

Tested by: Tom Jen

Humidity: 40 % RH

Polarity: Ver. / Hor.

Frequency (MHz)	Ant. Pol. (H/V)	Reading (Peak) (dBuV)	Reading (Average) (dBuV)	Correction Factor (dB/m)	Result (Peak) (dBuV/m)	Result (Average) (dBuV/m)	Limit (Peak) (dBuV/m)	Limit (Average) (dBuV/m)	Margin (dB)	Remark
1416.67	V	58.78	---	-8.90	49.89	---	74.00	54.00	-4.11	Peak
4866.67	V	59.27	51.35	1.16	60.43	52.51	74.00	54.00	-1.49	AVG
7308.33	V	58.95	46.11	5.29	64.25	51.40	74.00	54.00	-2.60	AVG
N/A										
1326.67	H	58.57	---	-9.05	49.52	---	74.00	54.00	-4.48	Peak
4875.00	H	57.68	47.14	1.16	58.84	48.30	74.00	54.00	-5.70	AVG
7316.67	H	50.10	38.75	5.30	55.40	44.05	74.00	54.00	-9.95	AVG
N/A										

Remark:

1. Measuring frequencies from 1 GHz to the 10th harmonic of highest fundamental frequency.
2. Radiated emissions measured in frequency above 1000MHz were made with an instrument using peak/average detector mode.
3. Average test would be performed if the peak result were greater than the average limit or as required by the applicant.
4. Data of measurement within this frequency range shown " --- " in the table above means the reading of emissions are attenuated more than 20dB below the permissible limits or the field strength is too small to be measured.
5. Measurements above show only up to 6 maximum emissions noted, or would be lesser, with " N/A " remark, if no specific emissions from the EUT are recorded (ie: margin > 20dB from the applicable limit) and considered that's already beyond the background noise floor.
6. Margin (dB) = Remark result (dBuV/m) – Average limit (dBuV/m).



Operation Mode: TX / IEEE 802.11g / CH High

Test Date: October 21, 2010

Temperature: 23°C

Tested by: Tom Jen

Humidity: 40 % RH

Polarity: Ver. / Hor.

Frequency (MHz)	Ant. Pol. (H/V)	Reading (Peak) (dBuV)	Reading (Average) (dBuV)	Correction Factor (dB/m)	Result (Peak) (dBuV/m)	Result (Average) (dBuV/m)	Limit (Peak) (dBuV/m)	Limit (Average) (dBuV/m)	Margin (dB)	Remark
1070.00	V	60.48	---	-9.47	51.01	---	74.00	54.00	-2.99	Peak
1326.67	V	58.82	---	-9.05	49.78	---	74.00	54.00	-4.22	Peak
4925.00	V	55.90	46.95	1.14	57.04	48.09	74.00	54.00	-5.91	AVG
7383.33	V	55.76	45.88	5.34	61.10	51.22	74.00	54.00	-2.78	AVG
N/A										
1476.67	H	60.91	---	-8.80	52.11	---	74.00	54.00	-1.89	Peak
4916.67	H	58.73	44.80	1.15	59.87	45.95	74.00	54.00	-8.05	AVG
7391.67	H	49.97	39.00	5.35	55.32	44.35	74.00	54.00	-9.65	AVG
N/A										

Remark:

1. Measuring frequencies from 1 GHz to the 10th harmonic of highest fundamental frequency.
2. Radiated emissions measured in frequency above 1000MHz were made with an instrument using peak/average detector mode.
3. Average test would be performed if the peak result were greater than the average limit or as required by the applicant.
4. Data of measurement within this frequency range shown " --- " in the table above means the reading of emissions are attenuated more than 20dB below the permissible limits or the field strength is too small to be measured.
5. Measurements above show only up to 6 maximum emissions noted, or would be lesser, with " N/A " remark, if no specific emissions from the EUT are recorded (ie: margin > 20dB from the applicable limit) and considered that's already beyond the background noise floor.
6. Margin (dB) = Remark result (dBuV/m) – Average limit (dBuV/m).



Operation Mode: TX / Standard 802.11n 20 MHz mode / CH Low Test Date: October 21, 2010

Temperature: 24°C Tested by: Tom Jen

Humidity: 40 % RH Polarity: Ver. / Hor.

Frequency (MHz)	Ant. Pol. (H/V)	Reading (Peak) (dBuV)	Reading (Average) (dBuV)	Correction Factor (dB/m)	Result (Peak) (dBuV/m)	Result (Average) (dBuV/m)	Limit (Peak) (dBuV/m)	Limit (Average) (dBuV/m)	Margin (dB)	Remark
1066.67	V	60.31	---	-9.48	50.84	---	74.00	54.00	-3.16	Peak
4816.67	V	54.63	43.06	1.18	55.81	44.24	74.00	54.00	-9.76	AVG
7250.00	V	49.78	38.95	5.26	55.03	44.21	74.00	54.00	-9.79	AVG
N/A										
1286.67	H	58.63	---	-9.11	49.51	---	74.00	54.00	-4.49	Peak
4816.67	H	50.75	---	1.18	51.93	---	74.00	54.00	-2.07	Peak
N/A										

Remark:

1. Measuring frequencies from 1 GHz to the 10th harmonic of highest fundamental frequency.
2. Radiated emissions measured in frequency above 1000MHz were made with an instrument using peak/average detector mode.
3. Average test would be performed if the peak result were greater than the average limit or as required by the applicant.
4. Data of measurement within this frequency range shown " --- " in the table above means the reading of emissions are attenuated more than 20dB below the permissible limits or the field strength is too small to be measured.
5. Measurements above show only up to 6 maximum emissions noted, or would be lesser, with " N/A " remark, if no specific emissions from the EUT are recorded (ie: margin > 20dB from the applicable limit) and considered that's already beyond the background noise floor.
6. Margin (dB) = Remark result (dBuV/m) – Average limit (dBuV/m).



Operation Mode: TX / Standard 802.11n 20 MHz mode / CH Mid Test Date: October 21, 2010

Temperature: 23°C Tested by: Tom Jen

Humidity: 40 % RH Polarity: Ver. / Hor.

Frequency (MHz)	Ant. Pol. (H/V)	Reading (Peak) (dBuV)	Reading (Average) (dBuV)	Correction Factor (dB/m)	Result (Peak) (dBuV/m)	Result (Average) (dBuV/m)	Limit (Peak) (dBuV/m)	Limit (Average) (dBuV/m)	Margin (dB)	Remark
1283.33	V	58.70	---	-9.12	49.58	---	74.00	54.00	-4.42	Peak
4875.00	V	57.44	51.77	1.16	58.60	52.93	74.00	54.00	-1.07	AVG
7308.33	V	55.93	42.85	5.29	61.23	48.14	74.00	54.00	-5.86	AVG
N/A										
1330.00	H	58.81	---	-9.04	49.77	---	74.00	54.00	-4.23	Peak
4875.00	H	57.41	45.41	1.16	58.57	46.57	74.00	54.00	-7.43	AVG
7308.33	H	50.03	39.03	5.29	55.33	44.32	74.00	54.00	-9.68	AVG
N/A										

Remark:

1. Measuring frequencies from 1 GHz to the 10th harmonic of highest fundamental frequency.
2. Radiated emissions measured in frequency above 1000MHz were made with an instrument using peak/average detector mode.
3. Average test would be performed if the peak result were greater than the average limit or as required by the applicant.
4. Data of measurement within this frequency range shown " --- " in the table above means the reading of emissions are attenuated more than 20dB below the permissible limits or the field strength is too small to be measured.
5. Measurements above show only up to 6 maximum emissions noted, or would be lesser, with " N/A " remark, if no specific emissions from the EUT are recorded (ie: margin > 20dB from the applicable limit) and considered that's already beyond the background noise floor.
6. Margin (dB) = Remark result (dBuV/m) – Average limit (dBuV/m).



Operation Mode: TX / Standard 802.11n 20 MHz mode / CH High Test Date: October 21, 2010

Temperature: 23°C

Tested by: Tom Jen

Humidity: 40 % RH

Polarity: Ver. / Hor.

Frequency (MHz)	Ant. Pol. (H/V)	Reading (Peak) (dBuV)	Reading (Average) (dBuV)	Correction Factor (dB/m)	Result (Peak) (dBuV/m)	Result (Average) (dBuV/m)	Limit (Peak) (dBuV/m)	Limit (Average) (dBuV/m)	Margin (dB)	Remark
1283.33	V	58.85	---	-9.12	49.73	---	74.00	54.00	-4.27	Peak
4916.67	V	54.45	42.94	1.15	55.60	44.09	74.00	54.00	-9.91	AVG
7383.33	V	55.07	41.33	5.34	60.41	46.67	74.00	54.00	-7.33	AVG
N/A										
1613.33	H	58.20	---	-7.72	50.48	---	74.00	54.00	-3.52	Peak
4916.67	H	56.00	43.33	1.15	57.14	44.48	74.00	54.00	-9.52	AVG
7391.67	H	49.53	38.10	5.35	54.88	43.45	74.00	54.00	-10.55	AVG
N/A										

Remark:

1. Measuring frequencies from 1 GHz to the 10th harmonic of highest fundamental frequency.
2. Radiated emissions measured in frequency above 1000MHz were made with an instrument using peak/average detector mode.
3. Average test would be performed if the peak result were greater than the average limit or as required by the applicant.
4. Data of measurement within this frequency range shown " --- " in the table above means the reading of emissions are attenuated more than 20dB below the permissible limits or the field strength is too small to be measured.
5. Measurements above show only up to 6 maximum emissions noted, or would be lesser, with " N/A " remark, if no specific emissions from the EUT are recorded (ie: margin > 20dB from the applicable limit) and considered that's already beyond the background noise floor.
6. Margin (dB) = Remark result (dBuV/m) – Average limit (dBuV/m).



Operation Mode: TX / Standard 802.11n wide 40 MHz mode / CH Low
Temperature: 23°C
Humidity: 40 % RH

Test Date: October 21, 2010
Tested by: Tom Jen
Polarity: Ver. / Hor.

Table with 11 columns: Frequency (MHz), Ant. Pol. (H/V), Reading (Peak) (dBuV), Reading (Average) (dBuV), Correction Factor (dB/m), Result (Peak) (dBuV/m), Result (Average) (dBuV/m), Limit (Peak) (dBuV/m), Limit (Average) (dBuV/m), Margin (dB), Remark. Rows include data for frequencies 1116.67, 1186.67, and 1446.67 MHz.

Remark:

- 1. Measuring frequencies from 1 GHz to the 10th harmonic of highest fundamental frequency.
2. Radiated emissions measured in frequency above 1000MHz were made with an instrument using peak/average detector mode.
3. Average test would be performed if the peak result were greater than the average limit or as required by the applicant.
4. Data of measurement within this frequency range shown " --- " in the table above means the reading of emissions are attenuated more than 20dB below the permissible limits or the field strength is too small to be measured.
5. Measurements above show only up to 6 maximum emissions noted, or would be lesser, with " N/A " remark, if no specific emissions from the EUT are recorded (ie: margin > 20dB from the applicable limit) and considered that's already beyond the background noise floor.
6. Margin (dB) = Remark result (dBuV/m) - Average limit (dBuV/m).



Operation Mode: TX / Standard 802.11n wide 40 MHz mode / CH Mid

Test Date: October 21, 2010

Temperature: 23°C

Tested by: Tom Jen

Humidity: 40 % RH

Polarity: Ver. / Hor.

Frequency (MHz)	Ant. Pol. (H/V)	Reading (Peak) (dBuV)	Reading (Average) (dBuV)	Correction Factor (dB/m)	Result (Peak) (dBuV/m)	Result (Average) (dBuV/m)	Limit (Peak) (dBuV/m)	Limit (Average) (dBuV/m)	Margin (dB)	Remark
1230.00	V	58.79	---	-9.21	49.58	---	74.00	54.00	-4.42	Peak
1283.33	V	61.13	---	-9.12	52.01	---	74.00	54.00	-1.99	Peak
1333.33	V	59.61	---	-9.04	50.57	---	74.00	54.00	-3.43	Peak
N/A										
1226.67	H	58.94	---	-9.21	49.72	---	74.00	54.00	-4.28	Peak
1326.67	H	59.34	---	-9.05	50.29	---	74.00	54.00	-3.71	Peak
N/A										

Remark:

1. Measuring frequencies from 1 GHz to the 10th harmonic of highest fundamental frequency.
2. Radiated emissions measured in frequency above 1000MHz were made with an instrument using peak/average detector mode.
3. Average test would be performed if the peak result were greater than the average limit or as required by the applicant.
4. Data of measurement within this frequency range shown " --- " in the table above means the reading of emissions are attenuated more than 20dB below the permissible limits or the field strength is too small to be measured.
5. Measurements above show only up to 6 maximum emissions noted, or would be lesser, with " N/A " remark, if no specific emissions from the EUT are recorded (ie: margin > 20dB from the applicable limit) and considered that's already beyond the background noise floor.
6. Margin (dB) = Remark result (dBuV/m) – Average limit (dBuV/m).



Operation Mode: TX / Standard 802.11n wide 40 MHz mode / CH High

Test Date: October 21, 2010

Temperature: 23°C

Tested by: Tom Jen

Humidity: 40 % RH

Polarity: Ver. / Hor.

Frequency (MHz)	Ant. Pol. (H/V)	Reading (Peak) (dBuV)	Reading (Average) (dBuV)	Correction Factor (dB/m)	Result (Peak) (dBuV/m)	Result (Average) (dBuV/m)	Limit (Peak) (dBuV/m)	Limit (Average) (dBuV/m)	Margin (dB)	Remark
1286.67	V	59.89	---	-9.11	50.78	---	74.00	54.00	-3.22	Peak
1310.00	V	60.42	---	-9.08	51.34	---	74.00	54.00	-2.66	Peak
N/A										
1446.67	H	60.30	---	-8.85	51.45	---	74.00	54.00	-2.55	Peak
4908.33	H	49.82	---	1.15	50.97	---	74.00	54.00	-3.03	Peak
N/A										

Remark:

1. Measuring frequencies from 1 GHz to the 10th harmonic of highest fundamental frequency.
2. Radiated emissions measured in frequency above 1000MHz were made with an instrument using peak/average detector mode.
3. Average test would be performed if the peak result were greater than the average limit or as required by the applicant.
4. Data of measurement within this frequency range shown " --- " in the table above means the reading of emissions are attenuated more than 20dB below the permissible limits or the field strength is too small to be measured.
5. Measurements above show only up to 6 maximum emissions noted, or would be lesser, with " N/A " remark, if no specific emissions from the EUT are recorded (ie: margin > 20dB from the applicable limit) and considered that's already beyond the background noise floor.
6. Margin (dB) = Remark result (dBuV/m) – Average limit (dBuV/m).