

Data Sheet

(Mechanical Use)

Product Type	WLAN Antenna
Notebook Model Number	ASUS / UX20
Part No. / Yageo / Aux	CAN4313 820 022701B
Part No. / ASUS / Aux	

Yageo (Taiwan) Ltd.

16, west 3rd Street, N.E.P.Z Kaohsiung, 811 Taiwan, R.O.C

Yageo Electronics (China) Co, Ltd

No. 10, Zhu Yuan Road, Suzhou New District, Suzhou, PRC

Multiple Bands Antenna for WLAN Applications	Yageo Corporation SPD		R01	Sep. 25, 08
	Datasheet Current Revision:			
	R01			
	BY / Candy Lin	DATE / Sep. 25, 2008		

Table of Contents

- 1. Specifications**
 - 1.1 Specifications**
 - 1.2 Antenna Dimension / Cable Length**
 - 1.3 Packing Spec.**
 - 1.4 Antenna Pictures**

- 2. Test Methodology**
 - 2.1 Test Equipment**
 - 2.2 Test Setup**
 - 2.2.1 Frequency Range**
 - 2.2.2 Antenna Configuration**
 - 2.2.3 VSWR**
 - 2.2.4 Radiation Pattern and Gain**

- 3. Performance Data**
 - 3.1 VSWR in the Fixture (Aux Antenna)**
 - 3.2 Radiation Pattern and Gain**
 - 3.2.1 Low Frequency (2.40GHz~2.50GHz) (Aux)**
 - 3.2.2 Middle Frequency (5.15GHz~5.35GHz)**
 - 3.2.3 High Frequency (5.47GHz~5.85GHz)**
 - 3.2.4 Average Gain Summary (Aux Antenna)**

- 4. Antenna Drawing**

- 5. Reliability Data for Antenna Patch**

- 6. Ordering Information: Yageo Ordering P/N Code**

- 7. Revision Control**

- 8. UL Card**

1. Specifications

1.1 Specifications for Antennas

Frequency Range (GHz)	2.40 ~ 2.50 / 5.15 ~ 5.85
VSWR	2.5 : 1 max
Peak Gain	-0.23 dBi for 2.4~2.5GHz band 1.36 dBi for 5.15~5.85GHz band
Radio Connector	Hirose U.FL or IPex MHF
Impedance	50Ω Nominal.
Antenna Type	PIFA Antenna
Cable Diameter	1.37 mm
Cable Color	White for Aux WLAN
Operating Temperature	-40~90°C
Maximum Power	1W
Polarization	Linear
Radiation Pattern	Omni-directional

1.2 Antenna Dimension / Cable Length

Product	ASUS / UX20
Aux Antenna (LCD)	40*8*0.4 mm / 520.0 mm, Color White

1.3 Packing Spec.

Product	For Example
Inner Tray	60
Carton Box	265*100



Note: Real packing will base on current project type and samples quantity to definition.

1.4 Antenna Pictures

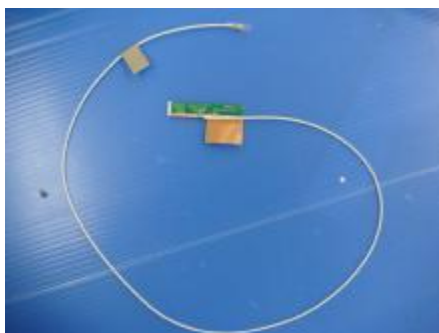

2. Test Methodology

2.1 Test Equipment

The equipment for the antenna measurement we used is as follows:

- A. Network Analyzer, support up to 8GHz, to measure the VSWR and input impedance of antenna.
- B. Three-dimensional anechoic chamber to measure antenna gain and radiation pattern (Standard horn antenna was used to calibrate the chamber)
- C. Digital caliper to measure the dimensions.
- D. Climatic chamber for mechanical tests.

2.2 Test Setup

2.2.1 Frequency Range

2.40~2.70GHz, 5.15 ~ 5.85GHz for WLAN / Wimax application.

2400~2484MHz for Bluetooth application.

3168~4752MHz , 6336~7920MHz for Ultra-Wide Band application.

824~960MHz, 1710~2170MHz for WWAN application

1575MHz for GPS application

2.2.2 Antenna Configuration

The antenna basically has two parts; the stamping and the cable assembly with the connector on one side. The detailed drawing is attached.

2.2.3 VSWR

The VSWR is measured with network analyzer that support up to 8GHz. All the measurements are performed with the customer provided fixture. Figure 1 shows the typical schematic diagram for measuring VSWR.

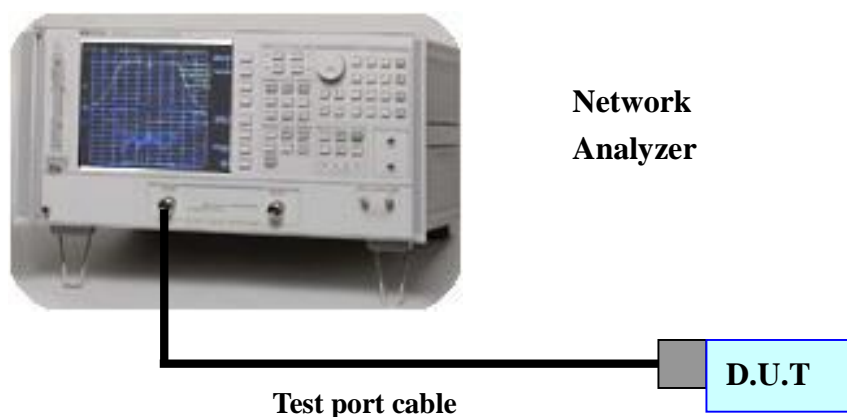

Figure 1. The schematic diagram for measuring VSWR

2.2.4 Radiation Pattern and Gain

The radiation pattern of antenna is measured in both horizontal polarization and vertical polarization. The radiation pattern measurements are performed in the three-dimensional anechoic chamber. The chamber provides less than -30dB reflectivity from 800MHz through 8GHz . The chamber is calibrated using both standard dipole antenna and horn antenna. The Gain here is expressed as dBi that standardizes the isotropic antenna. The Gain measurements and antenna radiation pattern are also performed in the same chamber described previously. Figure 2 shows the schematic diagram for measuring radiation pattern and Gain.

3D Anechoic Chamber

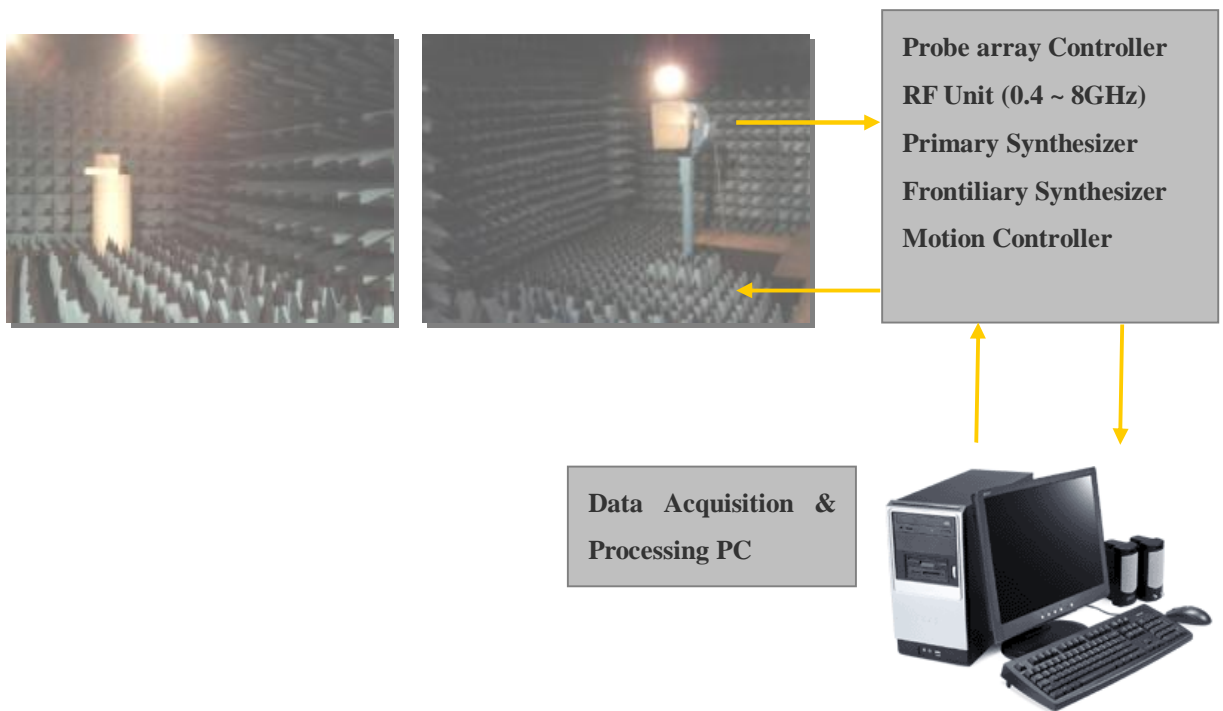

Figure 2. The schematic diagram for measuring radiation pattern and Gain

3. Performance Data

3.1 VSWR in the Fixture of Aux Antenna



3.2 Radiation Pattern and Gain

3.2.1 Low Frequency (2.40GHz~2.50GHz) / Aux Antenna

WL Aux @ 2.40GHz

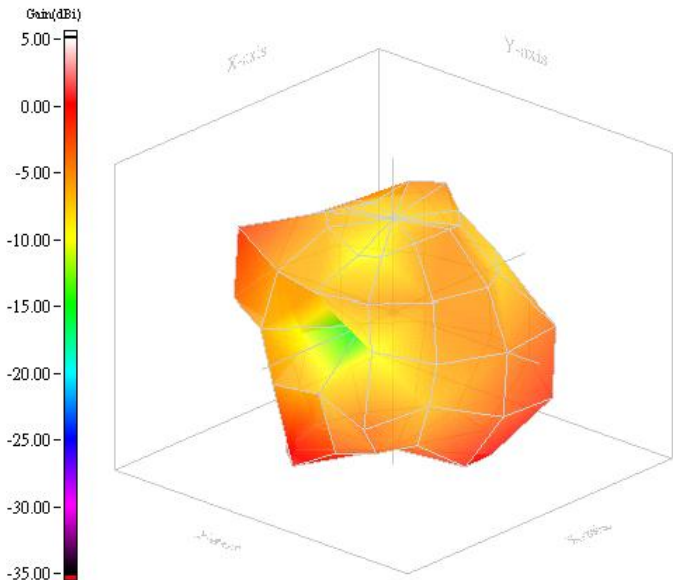

WL Aux @ 2.45GHz

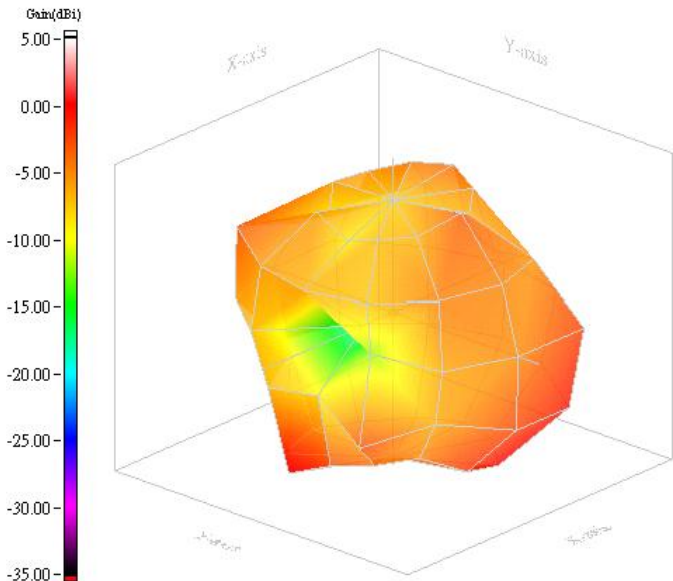

WL Aux @ 2.50GHz

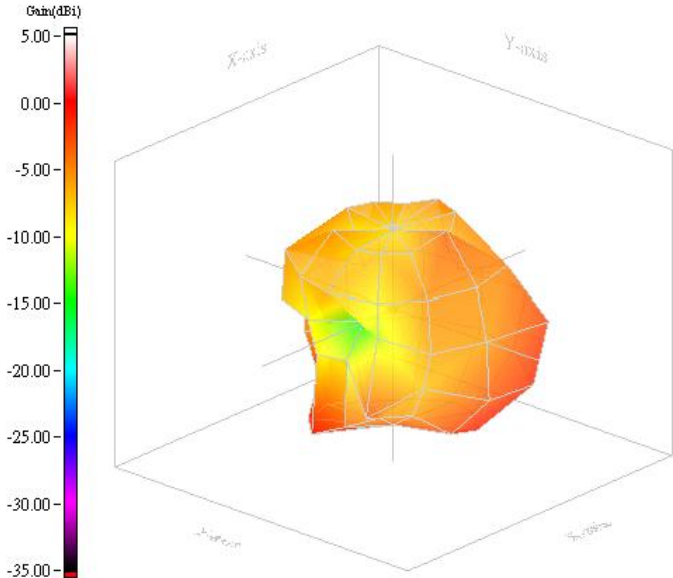

- Horizontal
- Vertical
- H+V

3.2.2 Middle Frequency (5.15GHz~5.35GHz) / Aux Antenna

WL Aux @ 5.15GHz

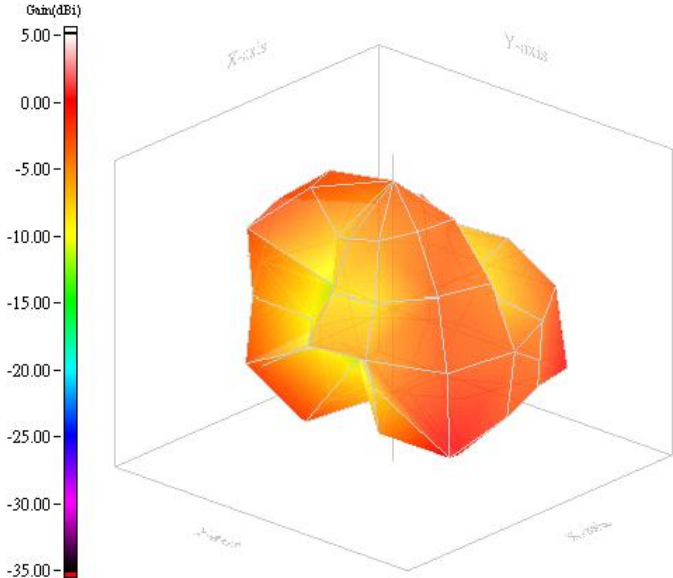

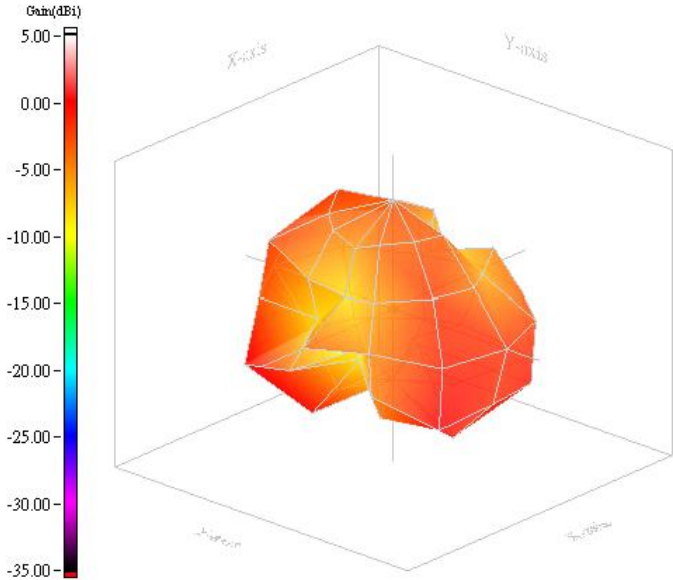

WL Aux @ 5.25GHz

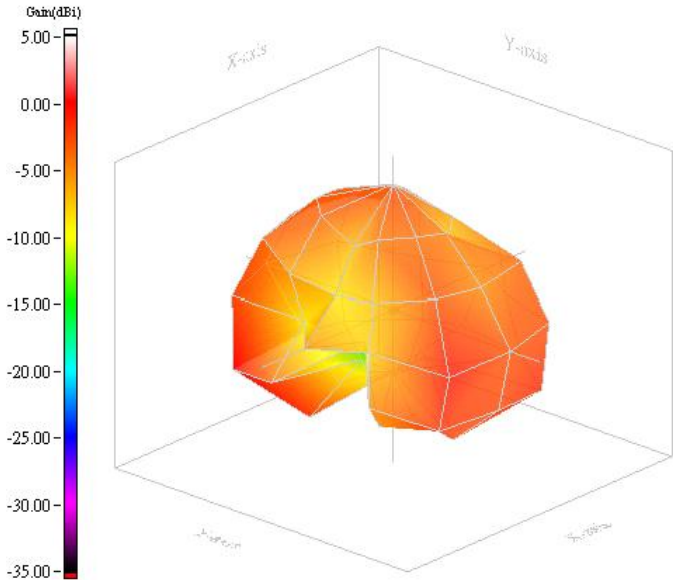

WL Aux @ 5.35GHz



-  **Horizontal**
-  **Vertical**
-  **H+V**

3.2.3 High Frequency (5.47GHz~5.85GHz) / Aux Antenna

WL Aux @ 5.47GHz

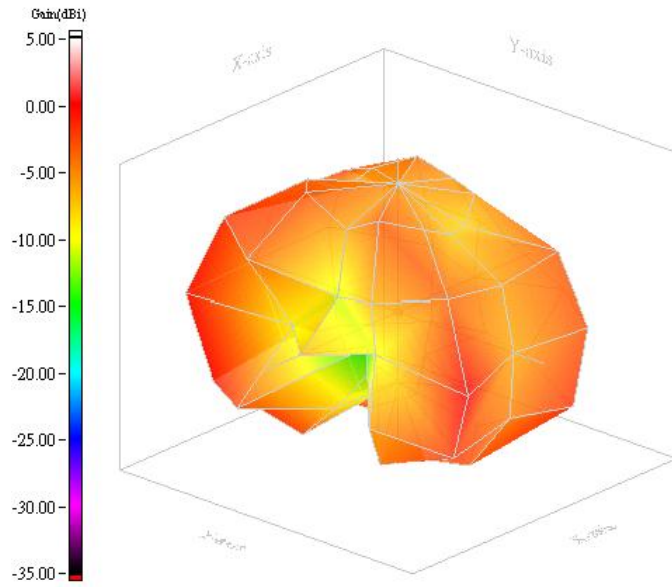

WL Aux @ 5.60GHz

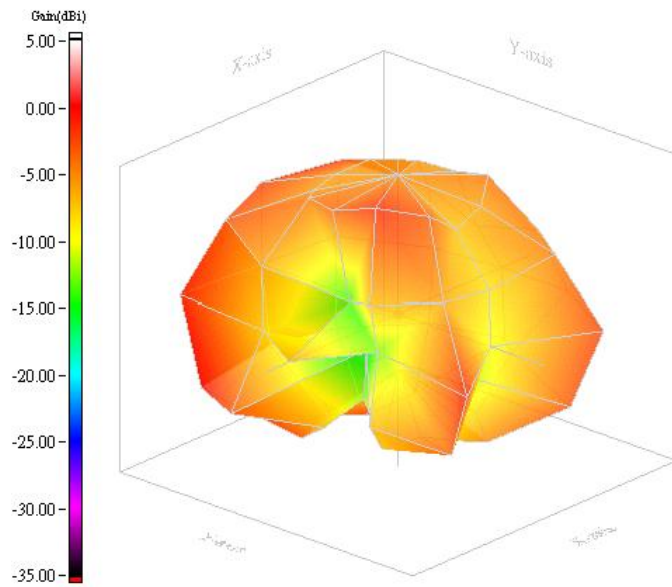

WL Aux @ 5.725GHz

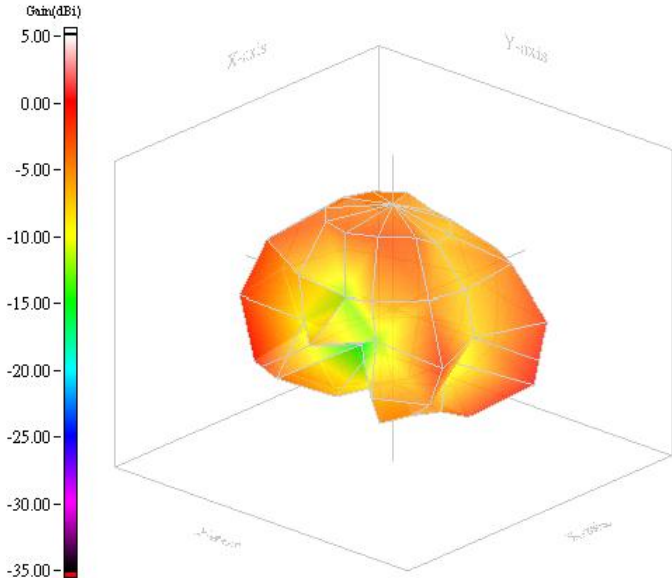

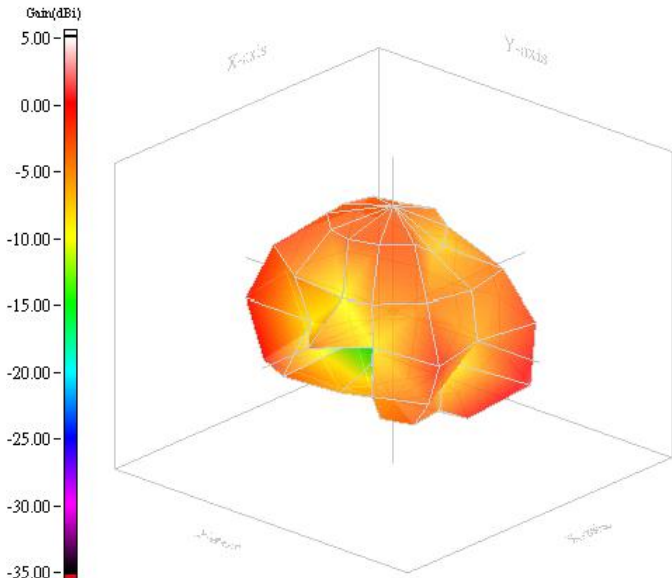

WL Aux @ 5.785GHz

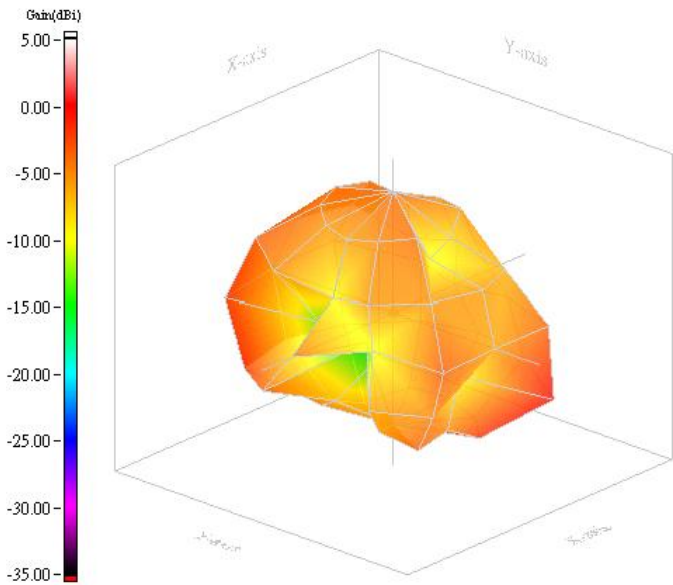

WL Aux @ 5.85GHz



-  **Horizontal**
-  **Vertical**
-  **H+V**

3.2.4 Average Gain (dBi) Summary

WLAN Aux Antenna Gain								
Frequency	Peak(dBi)			Average(dBi)				
	H-pol	V-pol	Total	H-pol	V-pol	Total	3D Gain	Efficiency%
2400 MHz	-2.06	-6.77	-1.01	-5.51	-12.19	-4.67	-4.12	38.71
2450 MHz	-1.39	-6.52	-0.23	-5.51	-12.23	-4.67	-4.24	37.64
2500 MHz	-1.40	-6.90	-0.34	-5.62	-12.43	-4.80	-4.65	34.25
5150 MHz	-3.18	-2.46	-1.26	-6.97	-7.20	-4.07	-4.50	35.44
5250 MHz	-3.09	-0.84	0.09	-5.87	-5.79	-2.82	-3.36	46.08
5350 MHz	-2.69	-1.96	-0.46	-6.53	-6.81	-3.66	-4.22	37.88
5470 MHz	-1.63	-1.60	0.82	-6.27	-7.00	-3.61	-4.25	37.54
5600 MHz	-2.30	-2.29	0.02	-6.92	-7.65	-4.26	-4.93	32.14
5725 MHz	-2.07	-1.77	0.04	-7.04	-7.21	-4.12	-4.61	34.56
5785 MHz	-1.25	0.14	1.36	-6.14	-5.94	-3.03	-3.69	42.79
5850 MHz	0.40	0.40	1.16	-7.52	-6.00	-3.68	-4.77	33.32

4. Antenna Drawing

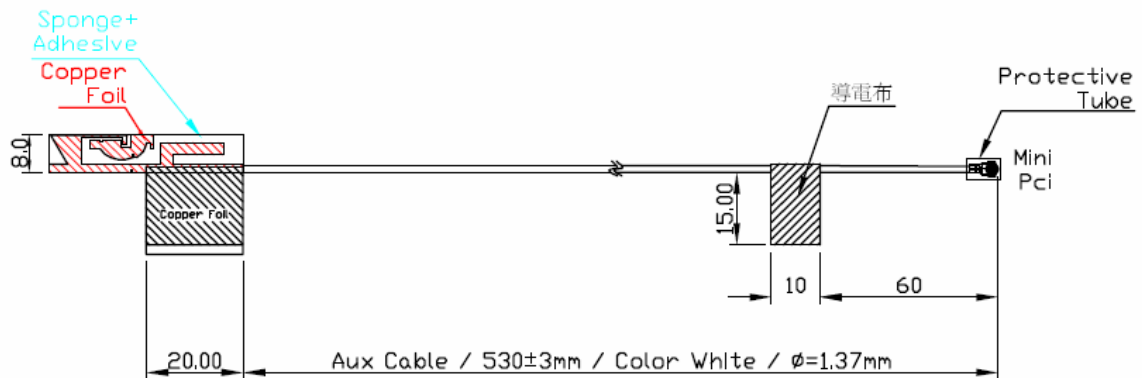

5. Reliability Data For Antenna Patch (Reference To IEC)

IEC 384-10/ CECC 32 100 CLAUSE	IEC 60068-2 TEST METHOD	TEST	PROCEDURE	REQUIREMENTS
4.12	4(Na)	Rapid change of temperature	-40 °C (30 minutes) to +90 °C (30 minutes); 5 cycles	No visible damage Central Freq. Change ± 6%
4.14	3(Ca)	Damp heat	500 ± 12 hours at 40 °C; 90 to 95 % RH	No visible damage 2 hours recovery Central Freq. Change ± 6%
4.15		Endurance	500 ± 12 hours at 90 °C;	No visible damage 2 hours recovery Central Freq. Change ± 6%

6. Ordering Information: Yageo Ordering P/N Code

The antennas may be ordered by using the Yageo P/N ordering code. These code numbers can be determined by the following rules:

CAN4313 8 20 02 270 1B
F C M S T A P

F. Family Code

CAN43 = Antenna

C. Packing Type Code

13 = Carton

M. Materials Code

8 = Coaxial Cable

S. Size/Series Code

20 = UX20

T. Left Antenna/Right Antenna

02 = WL Aux Right Top Antenna

A. Working Frequency

270 = WLAN

P. Packing

1B = 1000 pcs packing

7. Revision Control

Revision	Date	Content	Remark
R01	Sep. 25, 2008	New Issued, PCB Antenna	N/A.

8. UL Card

I-Pex Connector

No.06027-1
Feb / 26/08

材料証明書
MATERIAL CERTIFICATE

当社製品には下記の材料が使われている事を証明致します。
WE HEREBY CERTIFY THAT THE FOLLOWING MATERIALS ARE USED IN OUR PRODUCT.

PRODUCT NAME : MHF series micro coaxial connector PLUG & RECEPTACLE VERTICAL

Plug, Non halogen free type

Part No.	Contents	Housing	Contact	Ground contact
20278-101R-08	材質名/ Material	PBT	Phosphor bronze	Phosphor bronze
20278-111R-08				
20278-101R-13	型名/ Cat No.	DURANEX 3116	C5210R-H	C5191R-1/2H
20278-111R-13				
20278-101R-32	材料メーカー	WINTECH POLYMER LTD.	Nippon Mining & Metals Co.,Ltd.	HARADA METAL INDUSTRY Co.,Ltd.
20278-111R-32	Manufacturer			
20278-101R-18				
20278-111R-18	UL94難燃性	V-0	-----	-----
20308-101R-13	UL94 flame			
20308-111R-13	class			
20308-101R-32				
20308-111R-32	UL file No.	E213445	-----	-----
20351-101R-37				
20351-111R-37				

※添付資料 : ULカード写し/UL CARD COPY

Plug, Halogen free type

Part No.	Contents	Housing	Contact	Ground contact
20278-102R-08	材質名/ Material	PBT	Phosphor bronze	Phosphor bronze
20278-112R-08	型名/ Cat No.	XFR4840 GF10	C5210R-H	C5191R-1/2H
20278-102R-13	材料メーカー	WINTECH POLYMER LTD.	Nippon Mining & Metals Co.,Ltd.	HARADA METAL INDUSTRY Co.,Ltd.
20278-112R-13	Manufacturer			
20278-102R-32	UL94難燃性	V-0	-----	-----
20278-112R-32	UL94 flame			
20278-102R-18	class			
20278-112R-18	UL file No.	E213445	-----	-----
20351-102R-37				
20351-112R-37				

※添付資料 : ULカード写し/UL CARD COPY

QMFZ2 Component - Plastics		Friday, October 24, 2003				E213445			
WINTECH POLYMER LTD									
18-1 KONAN 2-CHOME MINATO-KU TOKYO 108-8280 JP									
Material Designation: 3118(a)									
Product Description: Polybutylene Terephthalate (PBT), designated "Duranex" furnished as pellets.									
Color	Min. Thick. (mm)	Flame Class	HWI	HAI	RTI Elec	RTI Imp	RTI Str	IEC GWIT	IEC GWFI
ALL	0.75	V-0	4	0	130	-	130	-	-
	1.5	V-0	3	0	130	120	130	-	-
NC, BK	3	5VA	2	0	130	120	130	-	-
CTI: 2	IEC CTI (V): -	HVTR: 3			D495: 6			IEC Ball Pressure (°C): -	
Dielectric Strength (kV/mm): 23			Volume Resistivity (10 ⁹ ohm-cm): 16				Dimensional Stability(%):0.0		
ISO Tensile Strength (MPa): -			ISO Flexural Strength (MPa): -				ISO Heat Deflection (C): -		
ISO Tensile Impact (kJ/m ²): -			ISO Izod Impact (kJ/m ²): -				ISO Charpy Impact(kJ/m ²): -		
(e) Virgin and regrind from 1 to 50 by weight incl. have the same basic material characteristics (at a minimum thickness of 0.75 mm), except for 310EP which has a lower as received Tensile Impact value from 26 to 50 percent regrind.									
Report Date: 11/15/2000					Underwriters Laboratories IncR				
UL94 small-scale test data does not pertain to building materials, furnishings and related contents. UL 94 small-scale test data is intended solely for determining the flammability of plastic materials used in components and parts of end-product devices and appliances, where the acceptability of the combination is determined by ULL									

Component - Plastics

E213445

WINTECH POLYMER LTD

18-1 KONAN 2-CHOME, MINATO-KU, TOKYO 108-8280 JP

XFR 4840 GF10

Polybutylene Terephthalate (PBT), "Duranex", furnished as pellets

Color	Min Thk (mm)	Flame Class	HWI	HAI	RTI Elec	RTI Imp	RTI Str
ALL	0.75	V-0	1	0	75	75	75
	1.5	V-0	1	0	75	75	75
	3.0	V-0	1	0	75	75	75

Comparative Tracking Index (CTI): 1

Dimensional Stability (%): -

High-Voltage Arc Tracking Rate (HVTR): 0

High Volt, Low Current Arc Resis (D495): 5

Dielectric Strength (kV/mm): 24

Volume Resistivity (10⁹ohm-cm): 14

UL94 small-scale test data does not pertain to building materials, furnishings and related contents. UL94 small-scale test data is intended solely for determining the flammability of plastic materials used in the components and parts of end-product devices and appliances, where the acceptability of the combination is determined by ULL.

Report Date: 2006-07-24
Last Revised: 2006-07-25

Underwriters Laboratories Inc®



IEC and ISO Test Methods

Test Name	Test Method	Units	Thickness Tested (mm)	Value
IEC Flammability	IEC 60695-11-10	Class (color)	0.75	V-0 (ALL)
			1.5	V-0 (ALL)
			3.0	V-0 (ALL)
Glow-Wire Flammability (GWFI)	IEC 60695-2-12	C	-	-
Glow-Wire Ignition (GWIT)	IEC 60695-2-13	C	-	-
IEC Comparative Tracking Index	IEC 60112	Volts (Max)	-	-
IEC Ball Pressure	IEC 60695-10-2	C	-	-
ISO Heat Deflection (1.80 MPa)	ISO 75-2	C	-	-
ISO Tensile Strength	ISO 527-2	MPa	-	-
ISO Flexural Strength	ISO 178	MPa	-	-
ISO Tensile Impact	ISO 8256	kJ/m2	-	-
ISO Izod Impact	ISO 180	kJ/m2	-	-
ISO Charpy Impact	ISO 179-2	kJ/m2	-	-

Underwriters Laboratories Inc®

Nissei Cable

04-12-20:14:18 :NISSEI ELECTRIC GOLDEN TACT :053 485 8908 # 1 / 1

AVLV2 July 24, 2004
 Appliance Wiring Material - Component
NISSEI ELECTRIC CO LTD E56198
 RYUYO FACTORY 206-1 AZA-OHNISHI, MATSUMOTO IWATA-
 GUN, RYUYO-CHO, SHIZUOKA 438-0206 JAPAN

Table of Recognized Styles

Single-conductor, thermoplastic insulation.							
1164	1331	1516	1609	1727	1907	10504	10653
1180	1332	1517	1610	1827	19109	10508	10654
1198	1333	1528	1637	1828	19231	10509	10655
1199	1334	1538	1671	1829	19248	10510	10656
1212	1358	1577	1664	1847	19315	10516	10657
1213	1371	1584	1709	1943	19344	10599	10730
1226	1398	1586	1710	1948	19386	10607	10734
1227	1512	1591	1723	1959	19443	10608	10735
1330	1543	1592	1726	1986	19485	10617	10736
Multiple-conductor, thermoplastic insulation.							
2095	2384	2516	2598	2669	2843	2995	21087
2096	2385	2517	2614	2764	2854	2994	21111



8/10/2004 Underwriters Laboratories Inc. Card 1 of 3

AVLV2 July 24, 2004
 Appliance Wiring Material - Component
NISSEI ELECTRIC CO LTD E56198

Table of Recognized Styles							
2097	2386	2502	2626	2709	2876	30002	21112
2098	2387	2519	2630	2725	2934	30007	21113
2099	2388	2520	2631	2726	2935	30278	21242
2100	2448	2570	2677	2778	2936	30399	21243
2101	2462	2571	2683	2780	2937	30535	21256
2102	2463	2574	2684	2786	2938	30708	
2103	2464	2576	2685	2787	2961	30897	
2343	2490	2584	2656	2789	2969	30898	
2344	2495	2586	2660	2805	2990	30899	
2345	2501	2587	2661	2841	2991	30900	
2346	2502	2589	2662	2842	2992	30901	
Single-conductor, thermoplastic insulation.							
3068	3074	3126	3138	3243	3329	3503	3507
3069	3075	3132	3139	3301	3367	3543	3723
3070	3122	3133	3172	3305	3422	3570	3724
3071	3125	3135	3259	3318	3488	3579	3725
Single and multiple-conductor specialty items.							
5145	5187	5228	5226	5228	5230	5233	

8/10/2004 Underwriters Laboratories Inc. Card 2 of 3

AVLV2 July 24, 2004
 Appliance Wiring Material - Component
NISSEI ELECTRIC CO LTD E56198

Table of Recognized Styles						
5140	5223	5225	5227	5229	5231	5237

Marking: Company name, voltage rating, temperature rating, conductor size, conductor material if other than copper, and use.
LOOK FOR THE RECOGNITION MARK See General Information Preceding These Recognitions
 For use only with equipment where the acceptability of the combination is determined by Underwriters Laboratories Inc.

8/10/2004 Underwriters Laboratories Inc. Card 3 of 3

Marking: Company name or trademark "SC" in a square and laminating adhesive designation on packaging, roll core or release liner.

[Page Top](#)

[Notice of Disclaimer](#)

[Questions?](#)

Previous Page

[UL Listed and Classified Products](#)

[UL Recognized Components](#)

[Products Certified for Canada](#)

This page and all contents are Copyright © 2004 by Underwriters Laboratories Inc. ®

The appearance of a company's name or product in this database does not in itself assure that products so identified have been manufactured under UL's Follow-Up Service. Only those products bearing the UL Mark should be considered to be Listed and covered under UL's Follow-Up Service. Always look for the Mark on the product.

UL permits the reproduction of the material contained in the Online Certification Directory subject to the following conditions: 1. The Guide Information, Designs and/or Listings (files) must be presented in their entirety and in a non-misleading manner, without any manipulation of the data (or drawings). 2. The statement "Reprinted from the Online Certifications Directory with permission from Underwriters Laboratories Inc." must appear adjacent to the extracted material. In addition, the reprinted material must include a copyright notice in the following format: "Copyright © 2004 Underwriters Laboratories Inc. ®"

Protective Tube

YDPU2.E203950 - Tubing, Extruded Insulating - Component

[OCD Home](#) [Quick Guide](#) [Contact Us](#) [UL.com](#)



YDPU2.E203950 Tubing, Extruded Insulating - Component

[Page Bottom](#)

Tubing, Extruded Insulating - Component

[See General Information for Tubing, Extruded Insulating - Component](#)

SHENZHEN WOER HEAT-SHRINKABLE MATERIAL CO LTD

E203950

XINWEI INDUSTRIAL PARK, WOER MANSION
NANSHAN DISTRICT, XILI
SHENZHEN, GUANGDONG 518052 CHINA

Cat. No.	Max V	Max Temp C	Col Recognized	Max Temp Rated Oil Resistance C	VW-1 Rated #
Heat-Shrinkable Polyolefin Tubing					
RSFR-x	600	125	Black	None	Yes
RSFR-x	600	125	White	None	Yes
WKZM-x-yz	600	125	White	None	No
RSFR-H\$	600	125	All except Clear	None	No
RSFR(CB)	300	125	All except Clear	None	Yes
Not Heat-Shrinkable PTFE Tubing					
WF	600	200	Natural	None	Yes
Heat-Shrinkable Polyolefin Tubing with Meltable Liner					
SBRS	600	105	All except Clear	None	Yes
Not Heat-Shrinkable Standard Wall Silicone Tubing					
WST-600	600	150	White	None	No

x - Designated tubing expanded ID. For Black color tubing, x represents expanded ID of 2 mm - 8 mm. For White color tubing, x represents expanded ID of 1mm - 50 mm.

yz - Represents any alpha and/or numeric combination for internal client code.

- Tubing is considered to comply with the optional VW-1 flammability requirements only if it is so marked.

@ - Tubing limited to 0.7 to 15 mm internal diameters only. VW-1 rated for internal diameter sizes 6.50 - 15.00 mm only.

\$ - 125C rating restricted to 2.36 to 75.0 mm recovered ID only.

Marking: Company name or file number "E203950", catalog number, voltage rating, temperature rating in degrees C,

http://database.ul.com/cgi-bin/XYV/template...versionless&parent_id=1073806658&sequence=1 第 1 頁 / 共 2 [2007/9/26 下午 02:12:20]

YDPU2.E203950 - Tubing, Extruded Insulating - Component

inside diameter (before and after recovery), and date of manufacture shall be marked on tags attached to both ends of the tubing, on the shipping spool label or on the smallest unit container.

[Last Updated](#) on 2007-08-21

[Questions?](#)

[Notice of Disclaimer](#)

[Page Top](#)

[Copyright © 2007 Underwriters Laboratories Inc.®](#)

The appearance of a company's name or product in this database does not in itself assure that products so identified have been manufactured under UL's Follow-Up Service. Only those products bearing the UL Mark should be considered to be Listed and covered under UL's Follow-Up Service. Always look for the Mark on the product.

UL permits the reproduction of the material contained in the Online Certification Directory subject to the following conditions:
1. The Guide Information, Designs and/or Listings (files) must be presented in their entirety and in a non-misleading manner, without any manipulation of the data (or drawings). 2. The statement "Reprinted from the Online Certifications Directory with permission from Underwriters Laboratories Inc." must appear adjacent to the extracted material. In addition, the reprinted material must include a copyright notice in the following format: "Copyright © 2007 Underwriters Laboratories Inc.®"