



FCC TEST REPORT

REPORT NO.: RF121029E10A

MODEL NO.: AW-NM383

FCC ID: TLZ-NM383

RECEIVED: Oct. 09, 2013

TESTED: Oct. 11 to 31, 2013

ISSUED: Nov. 19, 2013

APPLICANT: AzureWave Technologies, Inc.

ADDRESS: 8 F., No. 94, Baozhong Rd., Xindian, Taipei,
Taiwan 231

ISSUED BY: Bureau Veritas Consumer Products Services
(H.K.) Ltd., Taoyuan Branch Hsin Chu Laboratory

LAB ADDRESS : No. 81-1, Lu Liao Keng, 9th Ling, Wu Lung Tsuen,
Chiung Lin Hsiang, Hsin Chu Hsien 307, Taiwan,
R.O.C.

TEST LOCATION (1): No. 81-1, Lu Liao Keng, 9th Ling, Wu Lung Tsuen,
Chiung Lin Hsiang, Hsin Chu Hsien 307, Taiwan,
R.O.C.

TEST LOCATION (2): No. 49, Ln. 206, Wende Rd., Shangshan Tsuen,
Chiung Lin Hsiang, Hsin Chu Hsien 307, Taiwan,
R.O.C.

This report should not be used by the client to claim product certification, approval, or endorsement by TAF or any government agencies.



This report is for your exclusive use. Any copying or replication of this report to or for any other person or entity, or use of our name or trademark, is permitted only with our prior written permission. This report sets forth our findings solely with respect to the test samples identified herein. The results set forth in this report are not indicative or representative of the quality or characteristics of the lot from which a test sample was taken or any similar or identical product unless specifically and expressly noted. Our report includes all of the tests requested by you and the results thereof based upon the information that you provided to us. You have 60 days from date of issuance of this report to notify us of any material error or omission caused by our negligence, provided, however, that such notice shall be in writing and shall specifically address the issue you wish to raise. A failure to raise such issue within the prescribed time shall constitute your unqualified acceptance of the completeness of this report, the tests conducted and the correctness of the report contents. Unless specific mention, the uncertainty of measurement has been explicitly taken into account to declare the compliance or non-compliance to the specification



A D T

Table of Contents

RELEASE CONTROL RECORD	4
1. CERTIFICATION	5
2. SUMMARY OF TEST RESULTS	6
2.1 MEASUREMENT UNCERTAINTY	7
3. GENERAL INFORMATION	8
3.1 GENERAL DESCRIPTION OF EUT	8
3.2 DESCRIPTION OF TEST MODES	10
3.2.1 TEST MODE APPLICABILITY AND TESTED CHANNEL DETAIL	11
3.3 GENERAL DESCRIPTION OF APPLIED STANDARDS	14
3.4 DUTY CYCLE OF TEST SIGNAL	15
3.5 DESCRIPTION OF SUPPORT UNITS	16
3.6 CONFIGURATION OF SYSTEM UNDER TEST	17
4. TEST TYPES AND RESULTS	18
4.1 CONDUCTED EMISSION MEASUREMENT	18
4.1.1 LIMITS OF CONDUCTED EMISSION MEASUREMENT	18
4.1.2 TEST INSTRUMENTS	18
4.1.3 TEST PROCEDURES	19
4.1.4 DEVIATION FROM TEST STANDARD	19
4.1.5 TEST SETUP	19
4.1.6 EUT OPERATING CONDITIONS	20
4.1.7 TEST RESULTS	21
4.2 RADIATED EMISSION AND BANDEDGE MEASUREMENT	23
4.2.1 LIMITS OF RADIATED EMISSION AND BANDEDGE MEASUREMENT	23
4.2.2 TEST INSTRUMENTS	24
4.2.3 TEST PROCEDURES	25
4.2.4 DEVIATION FROM TEST STANDARD	25
4.2.5 TEST SETUP	26
4.2.6 EUT OPERATING CONDITIONS	26
4.2.7 TEST RESULTS	27
4.3 6dB BANDWIDTH MEASUREMENT	40
4.3.1 LIMITS OF 6DB BANDWIDTH MEASUREMENT	40
4.3.2 TEST INSTRUMENTS	40
4.3.3 TEST PROCEDURE	40
4.3.4 DEVIATION FROM TEST STANDARD	40
4.3.5 TEST SETUP	40
4.3.6 EUT OPERATING CONDITIONS	40
4.3.7 TEST RESULTS	41
4.4 CONDUCTED OUTPUT POWER MEASUREMENT	43
4.4.1 LIMITS OF MAXIMUM PEAK OUTPUT POWER MEASUREMENT	43
4.4.2 INSTRUMENTS	43
4.4.3 TEST PROCEDURES	43
4.4.4 DEVIATION FROM TEST STANDARD	44
4.4.5 TEST SETUP	44
4.4.6 EUT OPERATING CONDITIONS	44
4.4.7 TEST RESULTS	45
4.5 AVERAGE OUTPUT POWER	46
4.5.1 FOR REFERENCE	46
4.5.2 TEST INSTRUMENTS	46
4.5.3 TEST PROCEDURES	46
4.5.4 TEST SETUP	46



A D T

4.5.5	EUT OPERATING CONDITIONS	46
4.5.6	TEST RESULTS	47
4.6	POWER SPECTRAL DENSITY MEASUREMENT	48
4.6.1	LIMITS OF POWER SPECTRAL DENSITY MEASUREMENT	48
4.6.2	TEST INSTRUMENTS.....	48
4.6.3	TEST PROCEDURE.....	48
4.6.4	DEVIATION FROM TEST STANDARD.....	48
4.6.5	TEST SETUP	48
4.6.6	EUT OPERATING CONDITION.....	48
4.6.7	TEST RESULTS	49
4.7	CONDUCTED OUT-BAND EMISSION MEASUREMENT.....	51
4.7.1	LIMITS OF CONDUCTED OUT-BAND EMISSION MEASUREMENT.....	51
4.7.2	TEST INSTRUMENTS.....	51
4.7.3	TEST PROCEDURE.....	51
4.7.4	DEVIATION FROM TEST STANDARD.....	52
4.7.5	TEST SETUP	52
4.7.6	EUT OPERATING CONDITION.....	52
4.7.7	TEST RESULTS	52
5.	PHOTOGRAPHS OF THE TEST CONFIGURATION.....	57
6.	INFORMATION ON THE TESTING LABORATORIES	58
7.	APPENDIX A - MODIFICATIONS RECORDERS FOR ENGINEERING CHANGES TO THE EUT BY THE LAB.....	59



A D T

RELEASE CONTROL RECORD

ISSUE NO.	REASON FOR CHANGE	DATE ISSUED
RF121029E10A	Original release	Nov. 19, 2013

1. CERTIFICATION

PRODUCT: IEEE 802.11 b/g/n Wireless LAN Module
BRAND NAME: AzureWave
MODEL NO.: AW-NM383
TEST SAMPLE: ENGINEERING SAMPLE
APPLICANT: AzureWave Technologies, Inc.
TESTED: Oct. 11 to 31, 2013
STANDARDS: **FCC Part 15, Subpart C (Section 15.247)**
ANSI C63.10-2009

The above equipment (Model: AW-NM383) has been tested by **Bureau Veritas Consumer Products Services (H.K.) Ltd., Taoyuan Branch**, and found compliance with the requirement of the above standards. The test record, data evaluation & Equipment Under Test (EUT) configurations represented herein are true and accurate accounts of the measurements of the sample's EMC characteristics under the conditions specified in this report.

PREPARED BY :  , **DATE:** Nov. 19, 2013
(Midoli Peng, Specialist)

APPROVED BY :  , **DATE:** Nov. 19, 2013
(May Chen, Manager)



A D T

2. SUMMARY OF TEST RESULTS

The EUT has been tested according to the following specifications:

APPLIED STANDARD: FCC PART 15, SUBPART C (SECTION 15.247)			
STANDARD SECTION	TEST TYPE	RESULT	REMARK
15.207	AC Power Conducted Emission	PASS	Meet the requirement of limit. Minimum passing margin is -10.53dB at 4.80469MHz
15.247(d) 15.209	Radiated Emissions	PASS	Meet the requirement of limit. Minimum passing margin is -1.0dB at 120.02MHz
15.247(d)	Band Edge Measurement	PASS	Meet the requirement of limit.
15.247(a)(2)	6dB bandwidth	PASS	Meet the requirement of limit.
15.247(b)	Conducted output power	PASS	Meet the requirement of limit.
15.247(e)	Power Spectral Density	PASS	Meet the requirement of limit.
15.203	Antenna Requirement	PASS	Antenna connector is I-PEX not a standard connector.



A D T

2.1 MEASUREMENT UNCERTAINTY

Where relevant, the following measurement uncertainty levels have been estimated for tests performed on the EUT as specified in CISPR 16-4-2:

This uncertainty represents an expanded uncertainty expressed at approximately the 95% confidence level using a coverage factor of $k=2$.

Measurement	Value
Conducted emissions	2.98 dB
Radiated emissions (30MHz-1GHz)	5.46 dB
Radiated emissions (1GHz -6GHz)	3.54 dB
Radiated emissions (6GHz -18GHz)	4.08 dB
Radiated emissions (18GHz -40GHz)	4.11 dB



A D T

3. GENERAL INFORMATION

3.1 GENERAL DESCRIPTION OF EUT

PRODUCT	IEEE 802.11 b/g/n Wireless LAN Module
MODEL NO.	AW-NM383
POWER SUPPLY	DC 3.3V±10% from host equipment or DC 1.8V±10% from host equipment
MODULATION TYPE	CCK, DQPSK, DBPSK for DSSS 64QAM, 16QAM, QPSK, BPSK for OFDM
MODULATION TECHNOLOGY	DSSS,OFDM
TRANSFER RATE	802.11b: up to 11Mbps 802.11g: up to 54Mbps 802.11n: up to 150Mbps
OPERATING FREQUENCY	2.412 ~ 2.462GHz
NUMBER OF CHANNEL	11 for 802.11b, 802.11g, 802.11n (HT20) 7 for 802.11n (HT40)
MAXIMUM OUTPUT POWER	802.11b: 39.084mW 802.11g: 69.502mW 802.11n (HT20): 47.863mW 802.11n (HT40): 54.954mW
ANTENNA TYPE	Please see NOTE
DATA CABLE	NA
I/O PORTS	Refer to user's manual
ASSOCIATED DEVICES	NA

NOTE:

1. The antenna provided to the EUT, please refer to the following table:

Brand	Model	Antenna Type	Gain (dBi) (Include cable loss)	Connector Type	Frequency range (MHz to MHz)
NA	NA	Printed	1.48	I-PEX	2400~2483.5

2. The EUT incorporates a SISO function.

MODULATION MODE	Tx/Rx FUNCTION
802.11b	1Tx/1Rx
802.11g	1Tx/1Rx
802.11n (HT20)	1Tx/1Rx
802.11n (HT40)	1Tx/1Rx



A D T

3. When the EUT operating in 802.11n, the software operation, which is defined by manufacturer, MCS (Modulation and Coding Schemes) from 0 to 7.
4. The above EUT information was declared by the manufacturer and for more detailed features description, please refer to the manufacturer's specifications or User's Manual.



A D T

3.2 DESCRIPTION OF TEST MODES

11 channels are provided for 802.11b, 802.11g, 802.11n (HT20):

CHANNEL	FREQUENCY	CHANNEL	FREQUENCY
1	2412MHz	7	2442MHz
2	2417MHz	8	2447MHz
3	2422MHz	9	2452MHz
4	2427MHz	10	2457MHz
5	2432MHz	11	2462MHz
6	2437MHz		

7 channels are provided for 802.11n (HT40):

CHANNEL	FREQUENCY	CHANNEL	FREQUENCY
3	2422MHz	7	2442MHz
4	2427MHz	8	2447MHz
5	2432MHz	9	2452MHz
6	2437MHz		



A D T

3.2.1 TEST MODE APPLICABILITY AND TESTED CHANNEL DETAIL

EUT CONFIGURE MODE	APPLICABLE TO					DESCRIPTION
	PLC	RE < 1G	RE ≥ 1G	APCM	OB	
-	√	√	√	√	√	-

Where **PLC**: Power Line Conducted Emission **RE < 1G**: Radiated Emission below 1GHz
RE ≥ 1G: Radiated Emission above 1GHz **APCM**: Antenna Port Conducted Measurement
OB: Conducted Out-Band Emission Measurement

NOTE: 1. "-" means no effect.
2. The EUT's antenna had been pre-tested on the positioned of each 3 axis. The worst case was found when positioned on X-plane (for below 1GHz) and Z-plane (for above 1GHz).

POWER LINE CONDUCTED EMISSION TEST:

- Pre-Scan has been conducted to determine the worst-case mode from all possible combinations between available modulations, data rates and antenna ports (if EUT with antenna diversity architecture).
- Following channel(s) was (were) selected for the final test as listed below.

MODE	AVAILABLE CHANNEL	TESTED CHANNEL	MODULATION TECHNOLOGY	MODULATION TYPE	DATA RATE (Mbps)
802.11g	1 to 11	11	OFDM	BPSK	6

RADIATED EMISSION TEST (BELOW 1 GHz):

- Pre-Scan has been conducted to determine the worst-case mode from all possible combinations between available modulations, data rates and antenna ports (if EUT with antenna diversity architecture).
- Following channel(s) was (were) selected for the final test as listed below.

MODE	AVAILABLE CHANNEL	TESTED CHANNEL	MODULATION TECHNOLOGY	MODULATION TYPE	DATA RATE (Mbps)
802.11g	1 to 11	11	OFDM	BPSK	6



A D T

RADIATED EMISSION TEST (ABOVE 1 GHz):

- Pre-Scan has been conducted to determine the worst-case mode from all possible combinations between available modulations, data rates and antenna ports (if EUT with antenna diversity architecture).
- Following channel(s) was (were) selected for the final test as listed below.

MODE	AVAILABLE CHANNEL	TESTED CHANNEL	MODULATION TECHNOLOGY	MODULATION TYPE	DATA RATE (Mbps)
802.11b	1 to 11	1, 6, 11	DSSS	DBPSK	1
802.11g	1 to 11	1, 6, 11	OFDM	BPSK	6
802.11n (HT20)	1 to 11	1, 6, 11	OFDM	BPSK	6.5
802.11n (HT40)	3 to 9	3, 6, 9	OFDM	BPSK	13.5

ANTENNA PORT CONDUCTED MEASUREMENT:

- Pre-Scan has been conducted to determine the worst-case mode from all possible combinations between available modulations, data rates and antenna ports (if EUT with antenna diversity architecture).
- Following channel(s) was (were) selected for the final test as listed below.

MODE	AVAILABLE CHANNEL	TESTED CHANNEL	MODULATION TECHNOLOGY	MODULATION TYPE	DATA RATE (Mbps)
802.11b	1 to 11	1, 6, 11	DSSS	DBPSK	1
802.11g	1 to 11	1, 6, 11	OFDM	BPSK	6
802.11n (HT20)	1 to 11	1, 6, 11	OFDM	BPSK	6.5
802.11n (HT40)	3 to 9	3, 6, 9	OFDM	BPSK	13.5

CONDUCTED OUT-BAND EMISSION MEASUREMENT:

- Pre-Scan has been conducted to determine the worst-case mode from all possible combinations between available modulations, data rates and antenna ports (if EUT with antenna diversity architecture).
- Following channel(s) was (were) selected for the final test as listed below.

MODE	AVAILABLE CHANNEL	TESTED CHANNEL	MODULATION TECHNOLOGY	MODULATION TYPE	DATA RATE (Mbps)
802.11b	1 to 11	1, 6, 11	DSSS	DBPSK	1
802.11g	1 to 11	1, 6, 11	OFDM	BPSK	6
802.11n (HT20)	1 to 11	1, 6, 11	OFDM	BPSK	6.5
802.11n (HT40)	3 to 9	3, 6, 9	OFDM	BPSK	13.5



A D T

TEST CONDITION:

APPLICABLE TO	ENVIRONMENTAL CONDITIONS	INPUT POWER (SYSTEM)	TESTED BY
PLC	27deg. C, 62%RH	120Vac, 60Hz	Sean Huang
RE<1G	22deg. C, 68%RH	120Vac, 60Hz	Andy Ho
RE ³ 1G	24deg. C, 70%RH	120Vac, 60Hz	Andy Ho
APCM	25deg. C, 60%RH	120Vac, 60Hz	Chilin Lee
OB	25deg. C, 60%RH	120Vac, 60Hz	Chilin Lee

3.3 GENERAL DESCRIPTION OF APPLIED STANDARDS

The EUT is a RF product. According to the specifications of the manufacturer, it must comply with the requirements of the following standards:

FCC Part 15, Subpart C (15.247)

558074 D01 DTS Meas Guidance v03r01

ANSI C63.10-2009

All test items have been performed and recorded as per the above standards.

Note: The EUT has been verified to comply with the requirements of FCC Part 15, Subpart B, Class B (DoC). The test report has been issued separately.

3.4 DUTY CYCLE OF TEST SIGNAL

Duty cycle of test signal is < 98%, duty factor shall be considered.

802.11b: Duty cycle = 12.725 ms/26.775 ms = 0.475, Duty factor = 10 * log(1/0.475) = 3.2

802.11g: Duty cycle = 2.1 ms/5.23 ms = 0.402, Duty factor = 10 * log(1/0.402) = 4

802.11n (HT20): Duty cycle = 3.86 ms/9.515 ms = 0.406, Duty factor = 10 * log(1/0.406) = 3.9

802.11n (HT40): Duty cycle = 1.865 ms/9.32 ms = 0.20, Duty factor = 10 * log(1/0.20) = 7

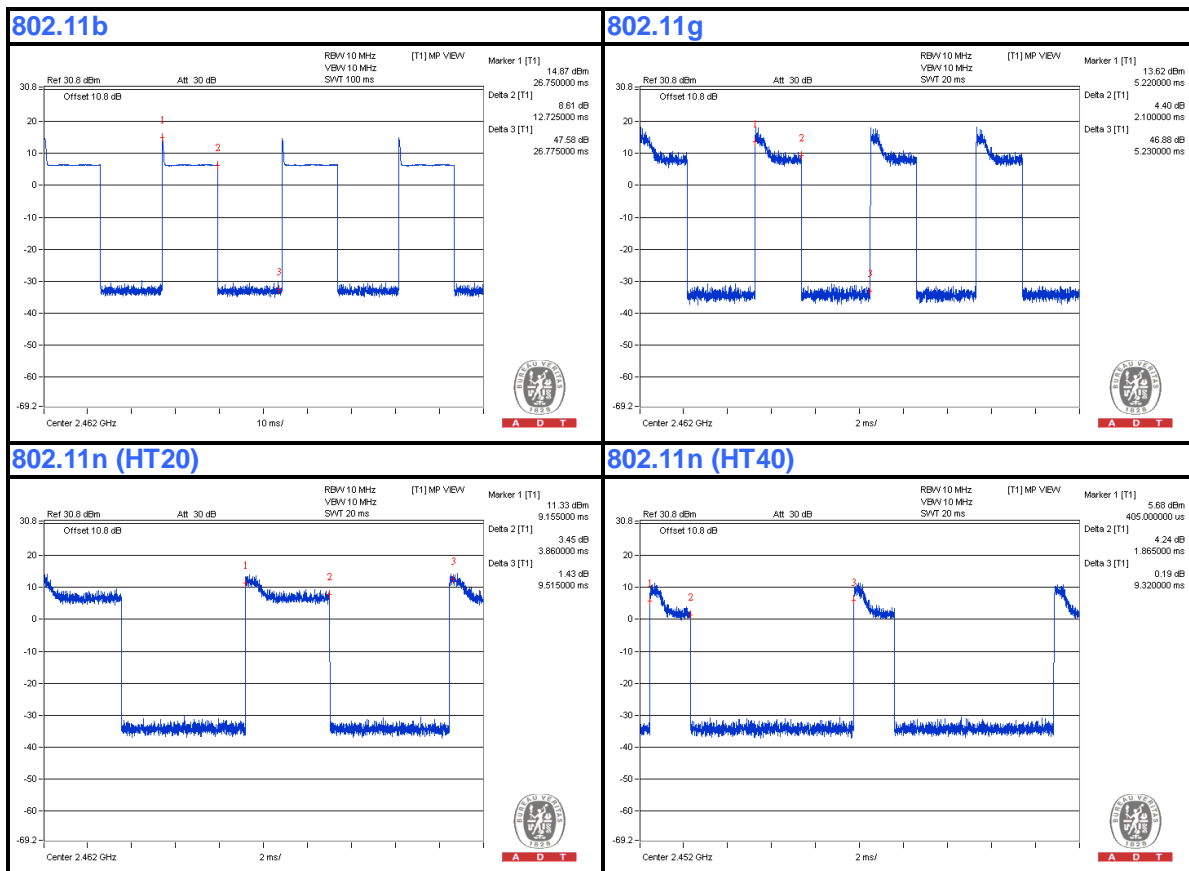



A D T

3.5 DESCRIPTION OF SUPPORT UNITS

The EUT has been tested as an independent unit together with other necessary accessories or support units. The following support units or accessories were used to form a representative test configuration during the tests.

NO.	PRODUCT	BRAND	MODEL NO.	SERIAL NO.	FCC ID
1	NOTEBOOK COMPUTER	DELL	PP32LA	FSLB32S	FCC DoC
2	NOTEBOOK COMPUTER	ASUS	U5F	NA	NA
3	TEST TOOL	AzureWave	NA	NA	NA
4	SDIO TEST TOOL	AzureWave	NA	NA	NA
5	USB to SDIO TEST TOOL	AzureWave	NA	NA	NA

NO.	SIGNAL CABLE DESCRIPTION OF THE ABOVE SUPPORT UNITS
1	NA
2	UTP cable(10m)
3	Data cable (0.08m)
4	Data cable (0.1m)
5	USB cable(1.3m)

NOTE: All power cords of the above support units are non shielded (1.8m).

3.6 CONFIGURATION OF SYSTEM UNDER TEST

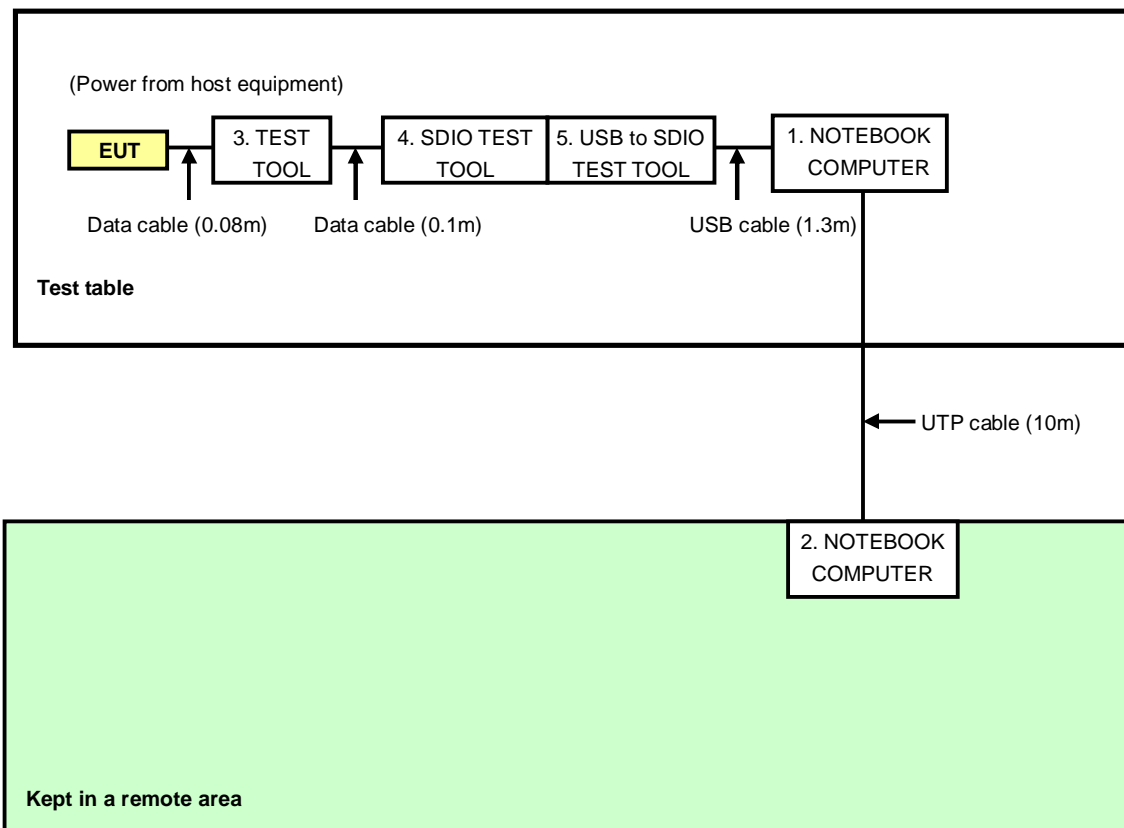



A D T

4. TEST TYPES AND RESULTS

4.1 CONDUCTED EMISSION MEASUREMENT

4.1.1 LIMITS OF CONDUCTED EMISSION MEASUREMENT

FREQUENCY OF EMISSION (MHz)	CONDUCTED LIMIT (dB μ V)	
	Quasi-peak	Average
0.15-0.5	66 to 56	56 to 46
0.5-5	56	46
5-30	60	50

- NOTE:**
1. The lower limit shall apply at the transition frequencies.
 2. The limit decreases in line with the logarithm of the frequency in the range of 0.15 to 0.50 MHz.

4.1.2 TEST INSTRUMENTS

DESCRIPTION & MANUFACTURER	MODEL NO.	SERIAL NO.	CALIBRATED DATE	CALIBRATED UNTIL
Test Receiver ROHDE & SCHWARZ	ESCS 30	100375	Mar. 08, 2013	Mar. 07, 2014
Line-Impedance Stabilization Network (for EUT) SCHWARZBECK	NSLK8127	8127-522	Sep. 05, 2013	Sep. 04, 2014
Line-Impedance Stabilization Network (for Peripheral)	ENV216	100072	June 06, 2013	June 05, 2014
RF Cable (JYEBAO)	5DFB	COCCAB-001	Mar. 11, 2013	Mar. 10, 2014
50 ohms Terminator	50	EMC-03	Sep. 24, 2013	Sep. 23, 2014
Software ADT	BV ADT_Cond_V7.3.7. 3	NA	NA	NA

Note:

1. The calibration interval of the above test instruments is 12 months and the calibrations are traceable to NML/ROC and NIST/USA.
2. The test was performed in Shielded Room No. C.
3. The VCCI Con C Registration No. is C-3611.
4. Tested Date: Oct. 11, 2013

4.1.3 TEST PROCEDURES

- a. The EUT was placed 0.4 meters from the conducting wall of the shielded room with EUT being connected to the power mains through a line impedance stabilization network (LISN). Other support units were connected to the power mains through another LISN.
- b. The two LISNs provide 50 ohm/ 50uH of coupling impedance for the measuring instrument.
- c. Both lines of the power mains connected to the EUT were checked for maximum conducted interference.
- d. The frequency range from 150kHz to 30MHz was searched. Emission levels under (Limit - 20dB) were not recorded.

NOTE:

1. The resolution bandwidth of test receiver is 9kHz for Quasi-peak detection (QP) & Average detection (AV).

4.1.4 DEVIATION FROM TEST STANDARD

No deviation

4.1.5 TEST SETUP

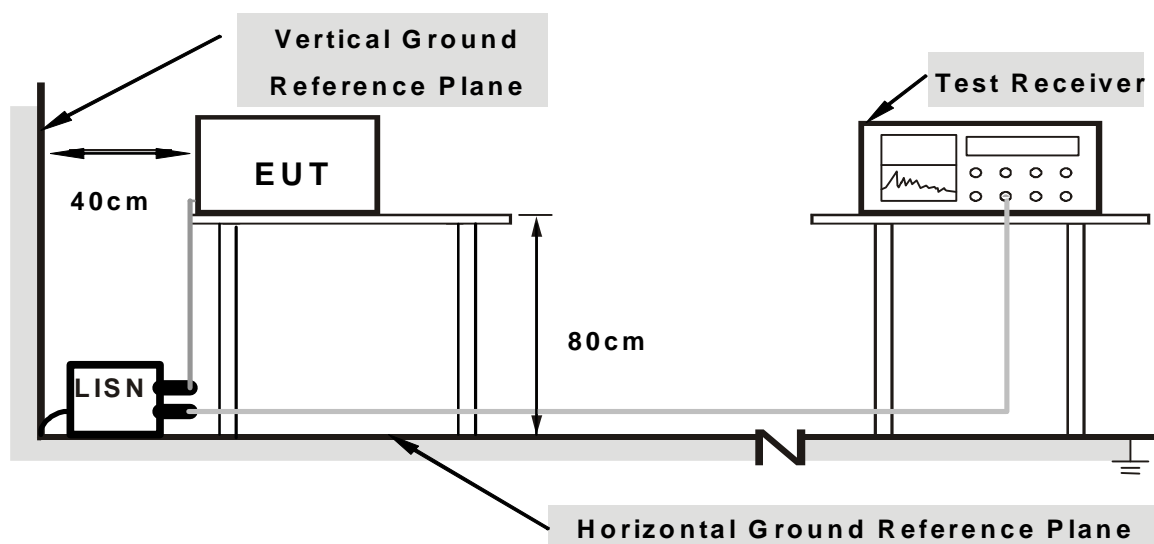

Note: 1. Support units were connected to second LISN.

For the actual test configuration, please refer to the related item – Photographs of the Test Configuration.

4.1.6 EUT OPERATING CONDITIONS

1. Connect the EUT with the support unit 1 (Notebook Computer) which is placed on a testing table.
2. The communication partner run test program “DutApiBRIDGEETH8782.exe” to enable EUT under transmission/receiving condition continuously at specific channel frequency.

4.1.7 TEST RESULTS

PHASE	Line (L)	DETECTOR FUNCTION	Quasi-Peak (QP) / Average (AV)
--------------	----------	--------------------------	--------------------------------

No	Freq. [MHz]	Corr. Factor [dB]	Reading Value [dB (uV)]		Emission Level [dB (uV)]		Limit [dB (uV)]		Margin (dB)	
			Q.P.	AV.	Q.P.	AV.	Q.P.	AV.	Q.P.	AV.
1	0.16172	0.08	39.18	11.58	39.26	11.66	65.38	55.38	-26.11	-43.71
2	0.20078	0.10	48.40	38.34	48.50	38.44	63.58	53.58	-15.08	-15.14
3	0.26719	0.11	40.12	31.85	40.23	31.96	61.20	51.20	-20.97	-19.24
4	0.33359	0.13	37.18	29.36	37.31	29.49	59.36	49.36	-22.05	-19.87
5	4.94141	0.31	36.65	33.08	36.96	33.39	56.00	46.00	-19.04	-12.61
6	5.21484	0.32	33.64	21.00	33.96	21.32	60.00	50.00	-26.04	-28.68

REMARKS:

1. Q.P. and AV. are abbreviations of quasi-peak and average individually.
2. The emission levels of other frequencies were very low against the limit.
3. Margin value = Emission Level – Limit value
4. Correction Factor = Insertion loss + Cable loss
5. Emission Level = Correction Factor + Reading Value

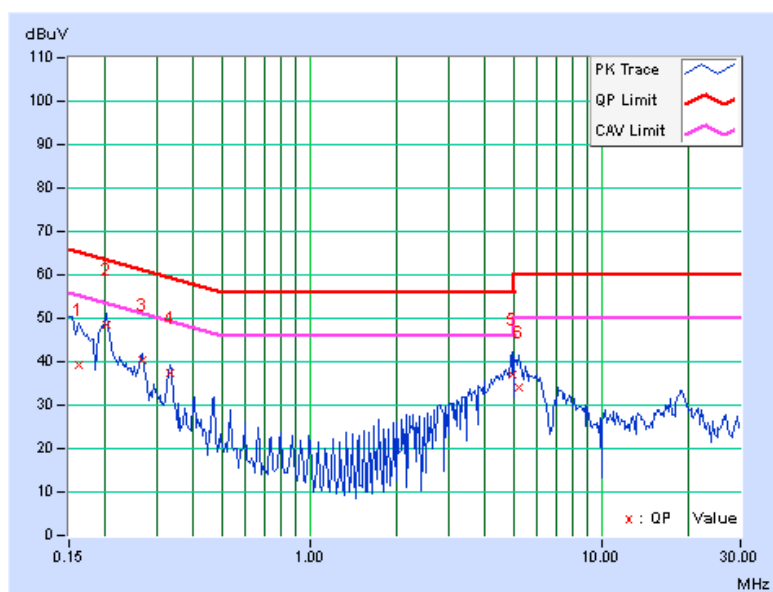

PHASE	Neutral (N)	DETECTOR FUNCTION	Quasi-Peak (QP) / Average (AV)
--------------	-------------	--------------------------	--------------------------------

No	Freq.	Corr.	Reading Value		Emission Level		Limit		Margin	
	[MHz]	(dB)	Q.P.	AV.	Q.P.	AV.	Q.P.	AV.	Q.P.	AV.
1	0.15781	0.09	39.96	11.90	40.05	11.99	65.58	55.58	-25.53	-43.59
2	0.20078	0.10	48.95	38.65	49.05	38.75	63.58	53.58	-14.53	-14.83
3	0.26719	0.11	39.84	31.91	39.95	32.02	61.20	51.20	-21.25	-19.18
4	0.33359	0.13	37.26	29.63	37.39	29.76	59.36	49.36	-21.97	-19.60
5	4.80469	0.31	37.60	35.16	37.91	35.47	56.00	46.00	-18.09	-10.53
6	5.20703	0.32	36.62	33.81	36.94	34.13	60.00	50.00	-23.06	-15.87

REMARKS:

1. Q.P. and AV. are abbreviations of quasi-peak and average individually.
2. The emission levels of other frequencies were very low against the limit.
3. Margin value = Emission Level – Limit value
4. Correction Factor = Insertion loss + Cable loss
5. Emission Level = Correction Factor + Reading Value

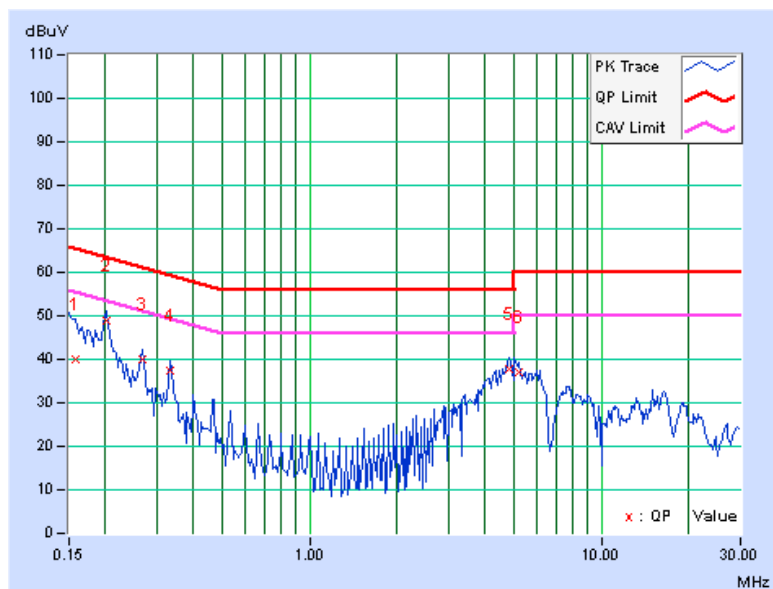

4.2 RADIATED EMISSION AND BANDEGE MEASUREMENT

4.2.1 LIMITS OF RADIATED EMISSION AND BANDEGE MEASUREMENT

Radiated emissions which fall in the restricted bands must comply with the radiated emission limits specified as below table. Other emissions shall be at least 20dB below the highest level of the desired power:

Frequencies (MHz)	Field strength (microvolts/meter)	Measurement distance (meters)
0.009-0.490	2400/F(kHz)	300
0.490-1.705	24000/F(kHz)	30
1.705-30.0	30	30
30-88	100	3
88-216	150	3
216-960	200	3
Above 960	500	3

NOTE:

1. The lower limit shall apply at the transition frequencies.
2. Emission level (dBuV/m) = 20 log Emission level (uV/m).
3. For frequencies above 1000MHz, the field strength limits are based on average detector, however, the peak field strength of any emission shall not exceed the maximum permitted average limits, specified above by more than 20dB.



A D T

4.2.2 TEST INSTRUMENTS

DESCRIPTION & MANUFACTURER	MODEL NO.	SERIAL NO.	CALIBRATED DATE	CALIBRATED UNTIL
MXE EMI Receiver Agilent	N9038A	MY50010156	Jan. 16, 2013	Jan. 15, 2014
Pre-Amplifier Mini-Circuits	ZFL-1000VH2 B	AMP-ZFL-04	Nov. 14, 2012	Nov. 13, 2013
Trilog Broadband Antenna SCHWARZBECK	VULB 9168	9168-361	Mar. 25, 2013	Mar. 24, 2014
RF Cable	NA	CHHCAB_001	Oct. 06, 2013	Oct. 05, 2014
Horn_Antenna AISI	AIH.8018	0000220091110	Nov. 27, 2012	Nov. 26, 2013
Pre-Amplifier Agilent	8449B	3008A02578	June 25, 2013	June 24, 2014
RF Cable	NA	RF104-205 RF104-207 RF104-202	Dec. 26, 2012	Dec. 25, 2013
Spectrum Analyzer Agilent	E4446A	MY48250253	Aug. 28, 2013	Aug. 27, 2014
Pre-Amplifier SPACEK LABS	SLKKa-48-6	9K16	Nov. 14, 2012	Nov. 13, 2013
Horn_Antenna SCHWARZBECK	BBHA 9170	9170-424	Oct. 08, 2013	Oct. 07, 2014
Software	ADT_Radiated _V8.7.07	NA	NA	NA
Antenna Tower & Turn Table CT	NA	NA	NA	NA

Note:

1. The calibration interval of the above test instruments is 12 months and the calibrations are traceable to NML/ROC and NIST/USA.
2. The horn antenna, preamplifier (model: 8449B) are used only for the measurement of emission frequency above 1GHz if tested.
- 3 The test was performed in 966 Chamber No. H.
4. The FCC Site Registration No. is 797305.
- 5 The CANADA Site Registration No. is IC 7450H-3.
- 6 Tested Date: Oct. 31, 2013

4.2.3 TEST PROCEDURES

- a. The EUT was placed on the top of a rotating table 0.8 meters above the ground at 3 meter chamber room for test. The table was rotated 360 degrees to determine the position of the highest radiation.
- b. The EUT was set 3 meters away from the interference-receiving antenna, which was mounted on the top of a variable-height antenna tower.
- c. The height of antenna is varied from one meter to four meters above the ground to determine the maximum value of the field strength. Both horizontal and vertical polarizations of the antenna are set to make the measurement.
- d. For each suspected emission, the EUT was arranged to its worst case and then the antenna was tuned to heights from 1 meter to 4 meters and the rotatable table was turned from 0 degrees to 360 degrees to find the maximum reading.
- e. The test-receiver system was set to quasi-peak detect function and specified bandwidth with maximum hold mode when the test frequency is below 1 GHz.
- f. The test-receiver system was set to peak and average detect function and specified bandwidth with maximum hold mode when the test frequency is above 1 GHz. If the peak reading value also meets average limit, measurement with the average detector is unnecessary.

NOTE:

1. The resolution bandwidth and video bandwidth of test receiver/spectrum analyzer is 120kHz for Quasi-peak detection (QP) at frequency below 1GHz.
2. The resolution bandwidth of test receiver/spectrum analyzer is 1 MHz and the video bandwidth is 3 MHz for Peak detection (PK) at frequency above 1GHz.
3. The resolution bandwidth of test receiver/spectrum analyzer is 1MHz and the video bandwidth is $\geq 1/T$ (Duty cycle < 98%) or 10Hz (Duty cycle $\geq 98\%$) for Average detection (AV) at frequency above 1GHz.
4. All modes of operation were investigated and the worst-case emissions are reported.

4.2.4 DEVIATION FROM TEST STANDARD

No deviation

4.2.5 TEST SETUP

<Frequency Range below 1GHz>

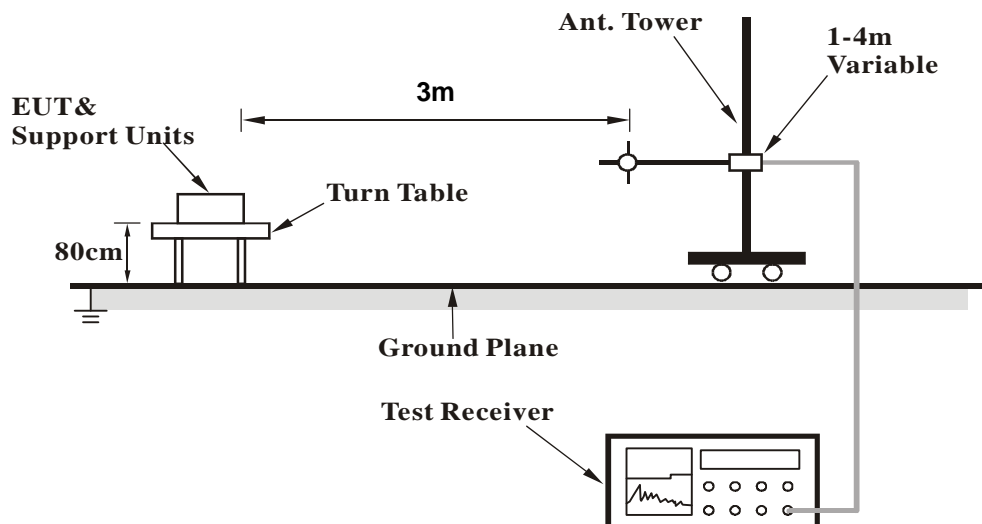

<Frequency Range above 1GHz>

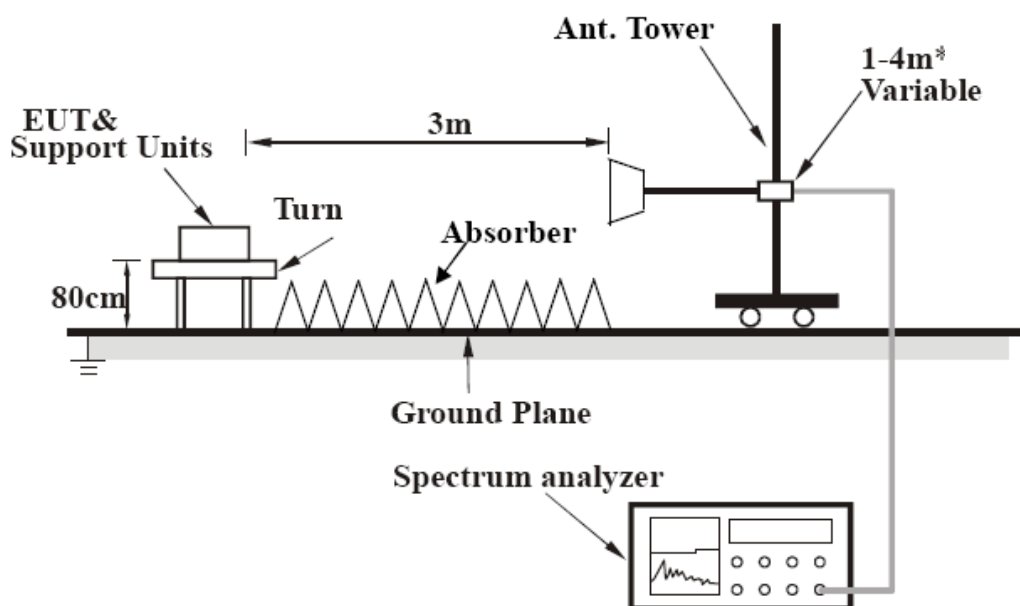

For the actual test configuration, please refer to the related item – Photographs of the Test Configuration.

4.2.6 EUT OPERATING CONDITIONS

Same as 4.1.6

4.2.7 TEST RESULTS

BELOW 1GHz WORST-CASE DATA

802.11g

CHANNEL	TX Channel 11	DETECTOR FUNCTION	Quasi-Peak (QP)
FREQUENCY RANGE	Below 1GHz		

ANTENNA POLARITY & TEST DISTANCE: HORIZONTAL AT 3 M								
NO.	FREQ. (MHz)	EMISSION LEVEL (dBuV/m)	LIMIT (dBuV/m)	MARGIN (dB)	ANTENNA HEIGHT (m)	TABLE ANGLE (Degree)	RAW VALUE (dBuV)	CORRECTION FACTOR (dB/m)
1	58.03	31.5 QP	40.0	-8.5	2.00 H	142	45.07	-13.59
2	120.02	42.5 QP	43.5	-1.0	1.50 H	95	57.13	-14.66
3	432.55	41.6 QP	46.0	-4.4	2.00 H	274	49.87	-8.23
4	456.02	41.9 QP	46.0	-4.1	2.00 H	276	49.79	-7.92
5	531.00	41.0 QP	46.0	-5.0	1.50 H	231	47.62	-6.64
6	720.01	39.5 QP	46.0	-6.6	1.00 H	264	42.56	-3.11
7	840.00	39.0 QP	46.0	-7.0	1.00 H	26	39.56	-0.57
ANTENNA POLARITY & TEST DISTANCE: VERTICAL AT 3 M								
NO.	FREQ. (MHz)	EMISSION LEVEL (dBuV/m)	LIMIT (dBuV/m)	MARGIN (dB)	ANTENNA HEIGHT (m)	TABLE ANGLE (Degree)	RAW VALUE (dBuV)	CORRECTION FACTOR (dB/m)
1	33.15	32.8 QP	40.0	-7.2	1.50 V	71	47.47	-14.64
2	57.45	35.7 QP	40.0	-4.3	1.00 V	42	49.12	-13.43
3	299.81	36.8 QP	46.0	-9.3	1.50 V	144	48.52	-11.77
4	305.24	32.2 QP	46.0	-13.8	2.00 V	158	43.72	-11.49
5	332.98	35.9 QP	46.0	-10.1	1.00 V	143	46.51	-10.63
6	429.01	35.0 QP	46.0	-11.0	1.00 V	107	43.30	-8.33
7	566.31	35.6 QP	46.0	-10.4	1.00 V	166	41.63	-6.01
8	840.00	36.3 QP	46.0	-9.7	2.00 V	0	36.83	-0.57

REMARKS:

1. Emission Level(dBuV/m) = Raw Value(dBuV) + Correction Factor(dB/m)
2. Correction Factor(dB/m) = Antenna Factor(dB/m) + Cable Factor(dB) – Pre-Amplifier Factor(dB)
3. The other emission levels were very low against the limit.
4. Margin value = Emission Level – Limit value



ABOVE 1GHz DATA

802.11b

CHANNEL	TX Channel 1	DETECTOR FUNCTION	Peak (PK)
FREQUENCY RANGE	1GHz ~ 25GHz		Average (AV)

ANTENNA POLARITY & TEST DISTANCE: HORIZONTAL AT 3 M								
NO.	FREQ. (MHz)	EMISSION LEVEL (dBuV/m)	LIMIT (dBuV/m)	MARGIN (dB)	ANTENNA HEIGHT (m)	TABLE ANGLE (Degree)	RAW VALUE (dBuV)	CORRECTION FACTOR (dB/m)
1	2390.00	52.4 PK	74.0	-21.6	1.06 H	151	18.76	33.64
2	2390.00	34.6 AV	54.0	-19.4	1.06 H	151	0.96	33.64
3	*2412.00	104.3 PK			1.06 H	151	70.58	33.72
4	*2412.00	92.0 AV			1.06 H	151	58.28	33.72
5	4824.00	49.1 PK	74.0	-24.9	1.00 H	255	7.42	41.68
6	4824.00	36.8 AV	54.0	-17.2	1.00 H	255	-4.88	41.68

ANTENNA POLARITY & TEST DISTANCE: VERTICAL AT 3 M								
NO.	FREQ. (MHz)	EMISSION LEVEL (dBuV/m)	LIMIT (dBuV/m)	MARGIN (dB)	ANTENNA HEIGHT (m)	TABLE ANGLE (Degree)	RAW VALUE (dBuV)	CORRECTION FACTOR (dB/m)
1	2390.00	51.5 PK	74.0	-22.5	1.24 V	154	17.86	33.64
2	2390.00	34.4 AV	54.0	-19.6	1.24 V	154	0.76	33.64
3	*2412.00	98.8 PK			1.24 V	154	65.08	33.72
4	*2412.00	86.5 AV			1.24 V	154	52.78	33.72
5	4824.00	49.0 PK	74.0	-25.0	1.00 V	203	7.32	41.68
6	4824.00	37.0 AV	54.0	-17.0	1.00 V	203	-4.68	41.68

REMARKS:

1. Emission Level(dBuV/m) = Raw Value(dBuV) + Correction Factor(dB/m)
2. Correction Factor(dB/m) = Antenna Factor(dB/m) + Cable Factor(dB) – Pre-Amplifier Factor(dB)
3. The other emission levels were very low against the limit.
4. Margin value = Emission Level – Limit value
5. " * ": Fundamental frequency.



A D T

CHANNEL	TX Channel 6	DETECTOR FUNCTION	Peak (PK)
FREQUENCY RANGE	1GHz ~ 25GHz		Average (AV)

ANTENNA POLARITY & TEST DISTANCE: HORIZONTAL AT 3 M

NO.	FREQ. (MHz)	EMISSION LEVEL (dBuV/m)	LIMIT (dBuV/m)	MARGIN (dB)	ANTENNA HEIGHT (m)	TABLE ANGLE (Degree)	RAW VALUE (dBuV)	CORRECTION FACTOR (dB/m)
1	*2437.00	99.3 PK			1.01 H	25	65.48	33.82
2	*2437.00	89.6 AV			1.01 H	25	55.78	33.82
3	4874.00	45.9 PK	74.0	-28.1	1.01 H	236	4.02	41.88
4	4874.00	33.7 AV	54.0	-20.3	1.01 H	236	-8.18	41.88
5	7311.00	53.7 PK	74.0	-20.3	1.05 H	88	3.72	49.98
6	7311.00	41.7 AV	54.0	-12.3	1.05 H	88	-8.28	49.98

ANTENNA POLARITY & TEST DISTANCE: VERTICAL AT 3 M

NO.	FREQ. (MHz)	EMISSION LEVEL (dBuV/m)	LIMIT (dBuV/m)	MARGIN (dB)	ANTENNA HEIGHT (m)	TABLE ANGLE (Degree)	RAW VALUE (dBuV)	CORRECTION FACTOR (dB/m)
1	*2437.00	99.7 PK			1.43 V	15	65.88	33.82
2	*2437.00	87.6 AV			1.43 V	15	53.78	33.82
3	4874.00	49.7 PK	74.0	-24.3	1.00 V	214	7.82	41.88
4	4874.00	36.8 AV	54.0	-17.2	1.00 V	214	-5.08	41.88
5	7311.00	54.2 PK	74.0	-19.8	1.00 V	220	4.22	49.98
6	7311.00	41.7 AV	54.0	-12.3	1.00 V	220	-8.28	49.98

REMARKS:

1. Emission Level(dBuV/m) = Raw Value(dBuV) + Correction Factor(dB/m)
2. Correction Factor(dB/m) = Antenna Factor(dB/m) + Cable Factor(dB) – Pre-Amplifier Factor(dB)
3. The other emission levels were very low against the limit.
4. Margin value = Emission Level – Limit value
5. " * ": Fundamental frequency.

CHANNEL	TX Channel 11	DETECTOR FUNCTION	Peak (PK)
FREQUENCY RANGE	1GHz ~ 25GHz		Average (AV)

ANTENNA POLARITY & TEST DISTANCE: HORIZONTAL AT 3 M								
NO.	FREQ. (MHz)	EMISSION LEVEL (dBuV/m)	LIMIT (dBuV/m)	MARGIN (dB)	ANTENNA HEIGHT (m)	TABLE ANGLE (Degree)	RAW VALUE (dBuV)	CORRECTION FACTOR (dB/m)
1	*2462.00	99.6 PK			1.00 H	28	65.69	33.91
2	*2462.00	89.0 AV			1.00 H	28	55.09	33.91
3	2483.50	56.9 PK	74.0	-17.1	1.00 H	28	22.91	33.99
4	2483.50	35.1 AV	54.0	-18.9	1.00 H	28	1.11	33.99
5	4924.00	46.3 PK	74.0	-27.7	1.00 H	243	4.25	42.05
6	4924.00	34.1 AV	54.0	-19.9	1.00 H	243	-7.95	42.05
7	7386.00	54.1 PK	74.0	-19.9	1.00 H	100	4.04	50.06
8	7386.00	42.0 AV	54.0	-12.0	1.00 H	100	-8.06	50.06

ANTENNA POLARITY & TEST DISTANCE: VERTICAL AT 3 M								
NO.	FREQ. (MHz)	EMISSION LEVEL (dBuV/m)	LIMIT (dBuV/m)	MARGIN (dB)	ANTENNA HEIGHT (m)	TABLE ANGLE (Degree)	RAW VALUE (dBuV)	CORRECTION FACTOR (dB/m)
1	*2462.00	99.8 PK			1.45 V	12	65.89	33.91
2	*2462.00	88.4 AV			1.45 V	12	54.49	33.91
3	2483.50	55.7 PK	74.0	-18.3	1.45 V	12	21.71	33.99
4	2483.50	35.1 AV	54.0	-18.9	1.45 V	12	1.11	33.99
5	4924.00	49.8 PK	74.0	-24.2	1.00 V	205	7.75	42.05
6	4924.00	36.7 AV	54.0	-17.3	1.00 V	205	-5.35	42.05
7	7386.00	55.1 PK	74.0	-18.9	1.00 V	211	5.04	50.06
8	7386.00	42.2 AV	54.0	-11.8	1.00 V	211	-7.86	50.06

REMARKS:

1. Emission Level(dBuV/m) = Raw Value(dBuV) + Correction Factor(dB/m)
2. Correction Factor(dB/m) = Antenna Factor(dB/m) + Cable Factor(dB) – Pre-Amplifier Factor(dB)
3. The other emission levels were very low against the limit.
4. Margin value = Emission Level – Limit value
5. " * ": Fundamental frequency.



A D T

802.11g

CHANNEL	TX Channel 1	DETECTOR FUNCTION	Peak (PK)
FREQUENCY RANGE	1GHz ~ 25GHz		Average (AV)

ANTENNA POLARITY & TEST DISTANCE: HORIZONTAL AT 3 M								
NO.	FREQ. (MHz)	EMISSION LEVEL (dBuV/m)	LIMIT (dBuV/m)	MARGIN (dB)	ANTENNA HEIGHT (m)	TABLE ANGLE (Degree)	RAW VALUE (dBuV)	CORRECTION FACTOR (dB/m)
1	2390.00	59.3 PK	74.0	-14.7	1.08 H	153	25.66	33.64
2	2390.00	43.8 AV	54.0	-10.2	1.08 H	153	10.16	33.64
3	*2412.00	103.1 PK			1.08 H	153	69.38	33.72
4	*2412.00	84.7 AV			1.08 H	153	50.98	33.72
5	4824.00	47.0 PK	74.0	-27.0	1.01 H	188	5.32	41.68
6	4824.00	34.2 AV	54.0	-19.8	1.01 H	188	-7.48	41.68
ANTENNA POLARITY & TEST DISTANCE: VERTICAL AT 3 M								
NO.	FREQ. (MHz)	EMISSION LEVEL (dBuV/m)	LIMIT (dBuV/m)	MARGIN (dB)	ANTENNA HEIGHT (m)	TABLE ANGLE (Degree)	RAW VALUE (dBuV)	CORRECTION FACTOR (dB/m)
1	2390.00	56.8 PK	74.0	-17.2	1.17 V	165	23.16	33.64
2	2390.00	42.7 AV	54.0	-11.3	1.17 V	165	9.06	33.64
3	*2412.00	100.6 PK			1.17 V	165	66.88	33.72
4	*2412.00	80.0 AV			1.17 V	165	46.28	33.72
5	4824.00	49.1 PK	74.0	-24.9	1.00 V	186	7.42	41.68
6	4824.00	36.7 AV	54.0	-17.3	1.00 V	186	-4.98	41.68

REMARKS:

1. Emission Level(dBuV/m) = Raw Value(dBuV) + Correction Factor(dB/m)
2. Correction Factor(dB/m) = Antenna Factor(dB/m) + Cable Factor(dB) – Pre-Amplifier Factor(dB)
3. The other emission levels were very low against the limit.
4. Margin value = Emission Level – Limit value
5. " * " : Fundamental frequency.



A D T

CHANNEL	TX Channel 6	DETECTOR FUNCTION	Peak (PK)
FREQUENCY RANGE	1GHz ~ 25GHz		Average (AV)

ANTENNA POLARITY & TEST DISTANCE: HORIZONTAL AT 3 M

NO.	FREQ. (MHz)	EMISSION LEVEL (dBuV/m)	LIMIT (dBuV/m)	MARGIN (dB)	ANTENNA HEIGHT (m)	TABLE ANGLE (Degree)	RAW VALUE (dBuV)	CORRECTION FACTOR (dB/m)
1	*2437.00	103.0 PK			1.04 H	148	69.18	33.82
2	*2437.00	85.5 AV			1.04 H	148	51.68	33.82
3	4874.00	46.8 PK	74.0	-27.2	1.00 H	195	4.92	41.88
4	4874.00	34.0 AV	54.0	-20.0	1.00 H	195	-7.88	41.88
5	7311.00	54.4 PK	74.0	-19.6	1.00 H	110	4.42	49.98
6	7311.00	41.9 AV	54.0	-12.1	1.00 H	110	-8.08	49.98

ANTENNA POLARITY & TEST DISTANCE: VERTICAL AT 3 M

NO.	FREQ. (MHz)	EMISSION LEVEL (dBuV/m)	LIMIT (dBuV/m)	MARGIN (dB)	ANTENNA HEIGHT (m)	TABLE ANGLE (Degree)	RAW VALUE (dBuV)	CORRECTION FACTOR (dB/m)
1	*2437.00	100.6 PK			1.23 V	161	66.78	33.82
2	*2437.00	81.0 AV			1.23 V	161	47.18	33.82
3	4874.00	48.7 PK	74.0	-25.3	1.00 V	196	6.82	41.88
4	4874.00	36.5 AV	54.0	-17.5	1.00 V	196	-5.38	41.88
5	7311.00	55.5 PK	74.0	-18.5	1.05 V	212	5.52	49.98
6	7311.00	42.7 AV	54.0	-11.3	1.05 V	212	-7.28	49.98

REMARKS:

1. Emission Level(dBuV/m) = Raw Value(dBuV) + Correction Factor(dB/m)
2. Correction Factor(dB/m) = Antenna Factor(dB/m) + Cable Factor(dB) – Pre-Amplifier Factor(dB)
3. The other emission levels were very low against the limit.
4. Margin value = Emission Level – Limit value
5. " * ": Fundamental frequency.



CHANNEL	TX Channel 11	DETECTOR FUNCTION	Peak (PK)
FREQUENCY RANGE	1GHz ~ 25GHz		Average (AV)

ANTENNA POLARITY & TEST DISTANCE: HORIZONTAL AT 3 M								
NO.	FREQ. (MHz)	EMISSION LEVEL (dBuV/m)	LIMIT (dBuV/m)	MARGIN (dB)	ANTENNA HEIGHT (m)	TABLE ANGLE (Degree)	RAW VALUE (dBuV)	CORRECTION FACTOR (dB/m)
1	*2462.00	105.7 PK			1.02 H	149	71.79	33.91
2	*2462.00	87.1 AV			1.02 H	149	53.19	33.91
3	2483.50	70.7 PK	74.0	-3.3	1.02 H	149	36.71	33.99
4	2483.50	49.2 AV	54.0	-4.8	1.02 H	149	15.21	33.99
5	4924.00	46.6 PK	74.0	-27.4	1.00 H	200	4.55	42.05
6	4924.00	33.9 AV	54.0	-20.1	1.00 H	200	-8.15	42.05
7	7386.00	54.2 PK	74.0	-19.8	1.00 H	105	4.14	50.06
8	7386.00	42.0 AV	54.0	-12.0	1.00 H	105	-8.06	50.06

ANTENNA POLARITY & TEST DISTANCE: VERTICAL AT 3 M								
NO.	FREQ. (MHz)	EMISSION LEVEL (dBuV/m)	LIMIT (dBuV/m)	MARGIN (dB)	ANTENNA HEIGHT (m)	TABLE ANGLE (Degree)	RAW VALUE (dBuV)	CORRECTION FACTOR (dB/m)
1	*2462.00	100.8 PK			1.20 V	157	66.89	33.91
2	*2462.00	83.3 AV			1.20 V	157	49.39	33.91
3	2483.50	65.1 PK	74.0	-8.9	1.20 V	157	31.11	33.99
4	2483.50	45.1 AV	54.0	-8.9	1.20 V	157	11.11	33.99
5	4924.00	49.3 PK	74.0	-24.7	1.00 V	211	7.25	42.05
6	4924.00	36.8 AV	54.0	-17.2	1.00 V	211	-5.25	42.05
7	7386.00	55.1 PK	74.0	-18.9	1.00 V	205	5.04	50.06
8	7386.00	42.2 AV	54.0	-11.8	1.00 V	205	-7.86	50.06

REMARKS:

1. Emission Level(dBuV/m) = Raw Value(dBuV) + Correction Factor(dB/m)
2. Correction Factor(dB/m) = Antenna Factor(dB/m) + Cable Factor(dB) – Pre-Amplifier Factor(dB)
3. The other emission levels were very low against the limit.
4. Margin value = Emission Level – Limit value
5. " * ": Fundamental frequency.



A D T

802.11n (HT20)

CHANNEL	TX Channel 1	DETECTOR FUNCTION	Peak (PK)
FREQUENCY RANGE	1GHz ~ 25GHz		Average (AV)

ANTENNA POLARITY & TEST DISTANCE: HORIZONTAL AT 3 M								
NO.	FREQ. (MHz)	EMISSION LEVEL (dBuV/m)	LIMIT (dBuV/m)	MARGIN (dB)	ANTENNA HEIGHT (m)	TABLE ANGLE (Degree)	RAW VALUE (dBuV)	CORRECTION FACTOR (dB/m)
1	2390.00	61.5 PK	74.0	-12.5	1.05 H	145	27.86	33.64
2	2390.00	42.2 AV	54.0	-11.8	1.05 H	145	8.56	33.64
3	*2412.00	100.8 PK			1.05 H	145	67.08	33.72
4	*2412.00	83.1 AV			1.05 H	145	49.38	33.72
5	4824.00	46.6 PK	74.0	-27.4	1.00 H	98	4.92	41.68
6	4824.00	34.4 AV	54.0	-19.6	1.00 H	98	-7.28	41.68
ANTENNA POLARITY & TEST DISTANCE: VERTICAL AT 3 M								
NO.	FREQ. (MHz)	EMISSION LEVEL (dBuV/m)	LIMIT (dBuV/m)	MARGIN (dB)	ANTENNA HEIGHT (m)	TABLE ANGLE (Degree)	RAW VALUE (dBuV)	CORRECTION FACTOR (dB/m)
1	2390.00	54.6 PK	74.0	-19.4	1.07 V	82	20.96	33.64
2	2390.00	39.5 AV	54.0	-14.5	1.07 V	82	5.86	33.64
3	*2412.00	94.5 PK			1.07 V	82	60.78	33.72
4	*2412.00	78.3 AV			1.07 V	82	44.58	33.72
5	4824.00	46.7 PK	74.0	-27.3	1.05 V	218	5.02	41.68
6	4824.00	33.5 AV	54.0	-20.5	1.05 V	218	-8.18	41.68

REMARKS:

1. Emission Level(dBuV/m) = Raw Value(dBuV) + Correction Factor(dB/m)
2. Correction Factor(dB/m) = Antenna Factor(dB/m) + Cable Factor(dB) – Pre-Amplifier Factor(dB)
3. The other emission levels were very low against the limit.
4. Margin value = Emission Level – Limit value
5. " * ": Fundamental frequency.



A D T

CHANNEL	TX Channel 6	DETECTOR FUNCTION	Peak (PK)
FREQUENCY RANGE	1GHz ~ 25GHz		Average (AV)

ANTENNA POLARITY & TEST DISTANCE: HORIZONTAL AT 3 M

NO.	FREQ. (MHz)	EMISSION LEVEL (dBuV/m)	LIMIT (dBuV/m)	MARGIN (dB)	ANTENNA HEIGHT (m)	TABLE ANGLE (Degree)	RAW VALUE (dBuV)	CORRECTION FACTOR (dB/m)
1	*2437.00	101.7 PK			1.07 H	145	67.88	33.82
2	*2437.00	84.3 AV			1.07 H	145	50.48	33.82
3	4874.00	46.5 PK	74.0	-27.5	1.00 H	99	4.62	41.88
4	4874.00	34.4 AV	54.0	-19.6	1.00 H	99	-7.48	41.88
5	7311.00	54.5 PK	74.0	-19.5	1.00 H	100	4.52	49.98
6	7311.00	42.1 AV	54.0	-11.9	1.00 H	100	-7.88	49.98

ANTENNA POLARITY & TEST DISTANCE: VERTICAL AT 3 M

NO.	FREQ. (MHz)	EMISSION LEVEL (dBuV/m)	LIMIT (dBuV/m)	MARGIN (dB)	ANTENNA HEIGHT (m)	TABLE ANGLE (Degree)	RAW VALUE (dBuV)	CORRECTION FACTOR (dB/m)
1	*2437.00	95.0 PK			1.04 V	77	61.18	33.82
2	*2437.00	79.7 AV			1.04 V	77	45.88	33.82
3	4874.00	47.2 PK	74.0	-26.8	1.05 V	203	5.32	41.88
4	4874.00	34.0 AV	54.0	-20.0	1.05 V	203	-7.88	41.88
5	7311.00	55.2 PK	74.0	-18.8	1.02 V	130	5.22	49.98
6	7311.00	42.6 AV	54.0	-11.4	1.02 V	130	-7.38	49.98

REMARKS:

1. Emission Level(dBuV/m) = Raw Value(dBuV) + Correction Factor(dB/m)
2. Correction Factor(dB/m) = Antenna Factor(dB/m) + Cable Factor(dB) – Pre-Amplifier Factor(dB)
3. The other emission levels were very low against the limit.
4. Margin value = Emission Level – Limit value
5. " * ": Fundamental frequency.

CHANNEL	TX Channel 11	DETECTOR FUNCTION	Peak (PK)
FREQUENCY RANGE	1GHz ~ 25GHz		Average (AV)

ANTENNA POLARITY & TEST DISTANCE: HORIZONTAL AT 3 M								
NO.	FREQ. (MHz)	EMISSION LEVEL (dBuV/m)	LIMIT (dBuV/m)	MARGIN (dB)	ANTENNA HEIGHT (m)	TABLE ANGLE (Degree)	RAW VALUE (dBuV)	CORRECTION FACTOR (dB/m)
1	*2462.00	102.3 PK			1.03 H	145	68.39	33.91
2	*2462.00	85.2 AV			1.03 H	145	51.29	33.91
3	2483.50	68.2 PK	74.0	-5.8	1.03 H	145	34.21	33.99
4	2483.50	46.3 AV	54.0	-7.7	1.03 H	145	12.31	33.99
5	4924.00	46.3 PK	74.0	-27.7	1.00 H	102	4.25	42.05
6	4924.00	34.1 AV	54.0	-19.9	1.00 H	102	-7.95	42.05
7	7386.00	54.4 PK	74.0	-19.6	1.00 H	112	4.34	50.06
8	7386.00	42.0 AV	54.0	-12.0	1.00 H	112	-8.06	50.06

ANTENNA POLARITY & TEST DISTANCE: VERTICAL AT 3 M								
NO.	FREQ. (MHz)	EMISSION LEVEL (dBuV/m)	LIMIT (dBuV/m)	MARGIN (dB)	ANTENNA HEIGHT (m)	TABLE ANGLE (Degree)	RAW VALUE (dBuV)	CORRECTION FACTOR (dB/m)
1	*2462.00	96.1 PK			1.00 V	91	62.19	33.91
2	*2462.00	80.0 AV			1.00 V	91	46.09	33.91
3	2483.50	59.6 PK	74.0	-14.4	1.00 V	91	25.61	33.99
4	2483.50	40.5 AV	54.0	-13.5	1.00 V	91	6.51	33.99
5	4924.00	47.2 PK	74.0	-26.8	1.00 V	203	5.15	42.05
6	4924.00	34.0 AV	54.0	-20.0	1.00 V	203	-8.05	42.05
7	7386.00	54.6 PK	74.0	-19.4	1.00 V	118	4.54	50.06
8	7386.00	42.2 AV	54.0	-11.8	1.00 V	118	-7.86	50.06

REMARKS:

1. Emission Level(dBuV/m) = Raw Value(dBuV) + Correction Factor(dB/m)
2. Correction Factor(dB/m) = Antenna Factor(dB/m) + Cable Factor(dB) – Pre-Amplifier Factor(dB)
3. The other emission levels were very low against the limit.
4. Margin value = Emission Level – Limit value
5. " * ": Fundamental frequency.



A D T

802.11n (HT40)

CHANNEL	TX Channel 3	DETECTOR FUNCTION	Peak (PK)
FREQUENCY RANGE	1GHz ~ 25GHz		Average (AV)

ANTENNA POLARITY & TEST DISTANCE: HORIZONTAL AT 3 M								
NO.	FREQ. (MHz)	EMISSION LEVEL (dBuV/m)	LIMIT (dBuV/m)	MARGIN (dB)	ANTENNA HEIGHT (m)	TABLE ANGLE (Degree)	RAW VALUE (dBuV)	CORRECTION FACTOR (dB/m)
1	2390.00	67.6 PK	74.0	-6.4	1.07 H	146	33.96	33.64
2	2390.00	44.5 AV	54.0	-9.5	1.07 H	146	10.86	33.64
3	*2422.00	97.5 PK			1.07 H	146	63.74	33.76
4	*2422.00	71.5 AV			1.07 H	146	37.74	33.76
5	4844.00	45.7 PK	74.0	-28.3	1.03 H	241	3.94	41.76
6	4844.00	33.5 AV	54.0	-20.5	1.03 H	241	-8.26	41.76
7	7266.00	54.5 PK	74.0	-19.5	1.00 H	207	4.55	49.95
8	7266.00	41.4 AV	54.0	-12.6	1.00 H	207	-8.55	49.95

ANTENNA POLARITY & TEST DISTANCE: VERTICAL AT 3 M								
NO.	FREQ. (MHz)	EMISSION LEVEL (dBuV/m)	LIMIT (dBuV/m)	MARGIN (dB)	ANTENNA HEIGHT (m)	TABLE ANGLE (Degree)	RAW VALUE (dBuV)	CORRECTION FACTOR (dB/m)
1	2390.00	59.4 PK	74.0	-14.6	1.00 V	75	25.76	33.64
2	2390.00	39.6 AV	54.0	-14.4	1.00 V	75	5.96	33.64
3	*2422.00	92.0 PK			1.01 V	68	58.24	33.76
4	*2422.00	69.4 AV			1.01 V	68	35.64	33.76
5	4844.00	45.7 PK	74.0	-28.3	1.00 V	214	3.94	41.76
6	4844.00	34.0 AV	54.0	-20.0	1.00 V	214	-7.76	41.76
7	7266.00	53.8 PK	74.0	-20.2	1.01 V	104	3.85	49.95
8	7266.00	41.0 AV	54.0	-13.0	1.01 V	104	-8.95	49.95

REMARKS:

1. Emission Level(dBuV/m) = Raw Value(dBuV) + Correction Factor(dB/m)
2. Correction Factor(dB/m) = Antenna Factor(dB/m) + Cable Factor(dB) – Pre-Amplifier Factor(dB)
3. The other emission levels were very low against the limit.
4. Margin value = Emission Level – Limit value
5. " * ": Fundamental frequency.



A D T

CHANNEL	TX Channel 6	DETECTOR FUNCTION	Peak (PK)
FREQUENCY RANGE	1GHz ~ 25GHz		Average (AV)

ANTENNA POLARITY & TEST DISTANCE: HORIZONTAL AT 3 M

NO.	FREQ. (MHz)	EMISSION LEVEL (dBuV/m)	LIMIT (dBuV/m)	MARGIN (dB)	ANTENNA HEIGHT (m)	TABLE ANGLE (Degree)	RAW VALUE (dBuV)	CORRECTION FACTOR (dB/m)
1	*2437.00	98.7 PK			1.03 H	148	64.88	33.82
2	*2437.00	72.5 AV			1.03 H	148	38.68	33.82
3	4874.00	45.5 PK	74.0	-28.5	1.00 H	234	3.62	41.88
4	4874.00	33.4 AV	54.0	-20.6	1.00 H	234	-8.48	41.88
5	7311.00	54.6 PK	74.0	-19.4	1.00 H	214	4.62	49.98
6	7311.00	41.5 AV	54.0	-12.5	1.00 H	214	-8.48	49.98

ANTENNA POLARITY & TEST DISTANCE: VERTICAL AT 3 M

NO.	FREQ. (MHz)	EMISSION LEVEL (dBuV/m)	LIMIT (dBuV/m)	MARGIN (dB)	ANTENNA HEIGHT (m)	TABLE ANGLE (Degree)	RAW VALUE (dBuV)	CORRECTION FACTOR (dB/m)
1	*2437.00	93.6 PK			1.01 V	79	59.78	33.82
2	*2437.00	70.1 AV			1.01 V	79	36.28	33.82
3	4874.00	45.4 PK	74.0	-28.6	1.00 V	212	3.52	41.88
4	4874.00	33.7 AV	54.0	-20.3	1.00 V	212	-8.18	41.88
5	7311.00	54.2 PK	74.0	-19.8	1.00 V	95	4.22	49.98
6	7311.00	41.5 AV	54.0	-12.5	1.00 V	95	-8.48	49.98

REMARKS:

1. Emission Level(dBuV/m) = Raw Value(dBuV) + Correction Factor(dB/m)
2. Correction Factor(dB/m) = Antenna Factor(dB/m) + Cable Factor(dB) – Pre-Amplifier Factor(dB)
3. The other emission levels were very low against the limit.
4. Margin value = Emission Level – Limit value
5. " * ": Fundamental frequency.



A D T

CHANNEL	TX Channel 9	DETECTOR FUNCTION	Peak (PK)
FREQUENCY RANGE	1GHz ~ 25GHz		Average (AV)

ANTENNA POLARITY & TEST DISTANCE: HORIZONTAL AT 3 M

NO.	FREQ. (MHz)	EMISSION LEVEL (dBuV/m)	LIMIT (dBuV/m)	MARGIN (dB)	ANTENNA HEIGHT (m)	TABLE ANGLE (Degree)	RAW VALUE (dBuV)	CORRECTION FACTOR (dB/m)
1	*2452.00	99.0 PK			1.03 H	152	65.12	33.88
2	*2452.00	74.0 AV			1.03 H	152	40.12	33.88
3	2483.50	66.2 PK	74.0	-7.8	1.03 H	152	32.21	33.99
4	2483.50	44.1 AV	54.0	-9.9	1.03 H	152	10.11	33.99
5	4904.00	45.7 PK	74.0	-28.3	1.00 H	220	3.70	42.00
6	4904.00	33.8 AV	54.0	-20.2	1.00 H	220	-8.20	42.00
7	7356.00	54.6 PK	74.0	-19.4	1.00 H	214	4.57	50.03
8	7356.00	41.4 AV	54.0	-12.6	1.00 H	214	-8.63	50.03

ANTENNA POLARITY & TEST DISTANCE: VERTICAL AT 3 M

NO.	FREQ. (MHz)	EMISSION LEVEL (dBuV/m)	LIMIT (dBuV/m)	MARGIN (dB)	ANTENNA HEIGHT (m)	TABLE ANGLE (Degree)	RAW VALUE (dBuV)	CORRECTION FACTOR (dB/m)
1	*2452.00	93.7 PK			1.00 V	88	59.82	33.88
2	*2452.00	72.1 AV			1.00 V	88	38.22	33.88
3	2483.50	59.2 PK	74.0	-14.8	1.00 V	88	25.21	33.99
4	2483.50	39.6 AV	54.0	-14.4	1.00 V	88	5.61	33.99
5	4904.00	45.6 PK	74.0	-28.4	1.00 V	205	3.60	42.00
6	4904.00	33.9 AV	54.0	-20.1	1.00 V	205	-8.10	42.00
7	7356.00	54.2 PK	74.0	-19.8	1.00 V	106	4.17	50.03
8	7356.00	41.5 AV	54.0	-12.5	1.00 V	106	-8.53	50.03

REMARKS:

1. Emission Level(dBuV/m) = Raw Value(dBuV) + Correction Factor(dB/m)
2. Correction Factor(dB/m) = Antenna Factor(dB/m) + Cable Factor(dB) – Pre-Amplifier Factor(dB)
3. The other emission levels were very low against the limit.
4. Margin value = Emission Level – Limit value
5. " * ": Fundamental frequency.

4.3 6dB BANDWIDTH MEASUREMENT

4.3.1 LIMITS OF 6dB BANDWIDTH MEASUREMENT

The minimum of 6dB Bandwidth Measurement is 0.5 MHz.

4.3.2 TEST INSTRUMENTS

DESCRIPTION & MANUFACTURER	MODEL NO.	SERIAL NO.	CALIBRATED DATE	CALIBRATED UNTIL
R&S SPECTRUM ANALYZER	FSP40	100036	Jan. 21, 2013	Jan. 20, 2014

Note:

1. The calibration interval of the above test instruments is 12 months and the calibrations are traceable to NML/ROC and NIST/USA.
2. Tested date : Oct. 30, 2013

4.3.3 TEST PROCEDURE

1. Set resolution bandwidth (RBW) = 100kHz
2. Set the video bandwidth (VBW) $\geq 3 \times$ RBW, Detector = Peak.
3. Trace mode = max hold.
4. Sweep = auto couple.
5. Measure the maximum width of the emission that is constrained by the frequencies associated with the two amplitude points (upper and lower) that are attenuated by 6 dB relative to the maximum level measured in the fundamental emission

4.3.4 DEVIATION FROM TEST STANDARD

No deviation

4.3.5 TEST SETUP

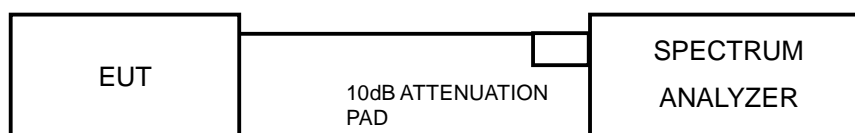

4.3.6 EUT OPERATING CONDITIONS

The software provided by client to enable the EUT under transmission condition continuously at lowest, middle and highest channel frequencies individually.



A D T

4.3.7 TEST RESULTS

802.11b

CHANNEL	FREQUENCY (MHz)	6dB BANDWIDTH (MHz)	MINIMUM LIMIT (MHz)	PASS / FAIL
1	2412	10.04	0.5	PASS
6	2437	9.99	0.5	PASS
11	2462	9.68	0.5	PASS

802.11g

CHANNEL	FREQUENCY (MHz)	6dB BANDWIDTH (MHz)	MINIMUM LIMIT (MHz)	PASS / FAIL
1	2412	16.38	0.5	PASS
6	2437	16.41	0.5	PASS
11	2462	16.45	0.5	PASS

802.11n (HT20)

CHANNEL	FREQUENCY (MHz)	6dB BANDWIDTH (MHz)	MINIMUM LIMIT (MHz)	PASS / FAIL
1	2412	17.65	0.5	PASS
6	2437	17.64	0.5	PASS
11	2462	17.71	0.5	PASS

802.11n (HT40)

CHANNEL	FREQUENCY (MHz)	6dB BANDWIDTH (MHz)	MINIMUM LIMIT (MHz)	PASS / FAIL
3	2422	36.42	0.5	PASS
6	2437	36.43	0.5	PASS
9	2452	36.44	0.5	PASS



A D T

SPECTRUM PLOT OF WORST VALUE

802.11b / CH11

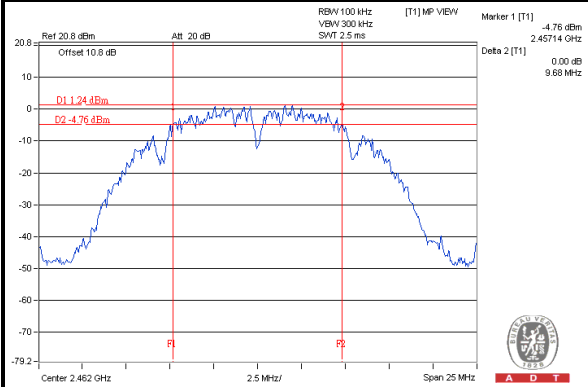

802.11g / CH1

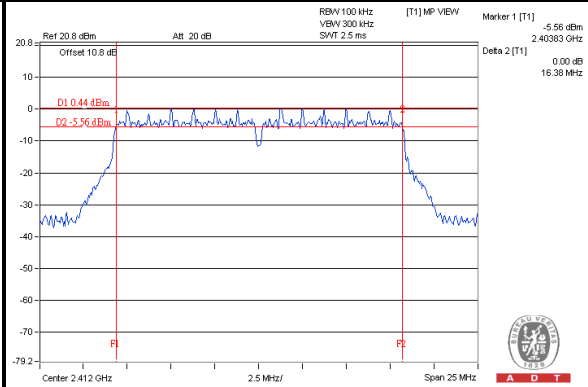

802.11n (HT20) / CH6

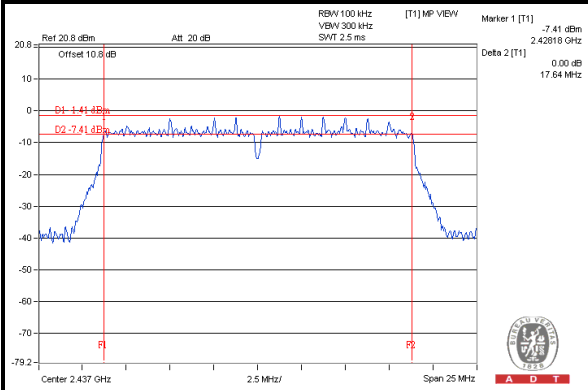

802.11n (HT40) / CH3

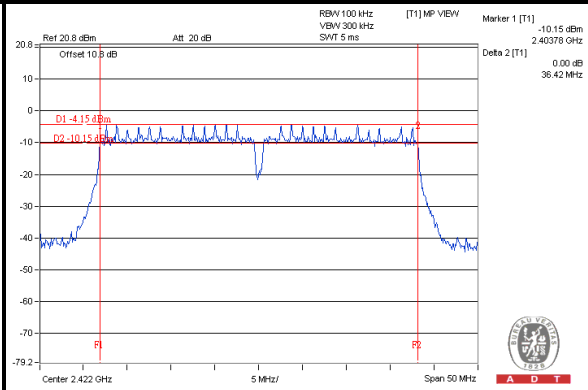

4.4 CONDUCTED OUTPUT POWER MEASUREMENT

4.4.1 LIMITS OF MAXIMUM PEAK OUTPUT POWER MEASUREMENT

For systems using digital modulation in the 2400–2483.5 MHz bands: 1 Watt (30dBm)

4.4.2 INSTRUMENTS

DESCRIPTION & MANUFACTURER	MODEL NO.	SERIAL NO.	CALIBRATED DATE	CALIBRATED UNTIL
Power Meter	ML2495A	1014008	Apr. 23, 2013	Apr. 22, 2014
Power Sensor	MA2411B	0917122	Apr. 23, 2013	Apr. 22, 2014

Note:

1. The calibration interval of the above test instruments is 12 months and the calibrations are traceable to NML/ROC and NIST/USA.
2. Tested date : Oct. 30, 2013

4.4.3 TEST PROCEDURES

The peak power sensor was used on the output port of the EUT. A power meter was used to read the response of the peak power sensor. Record the peak power level.

4.4.4 DEVIATION FROM TEST STANDARD

No deviation.

4.4.5 TEST SETUP

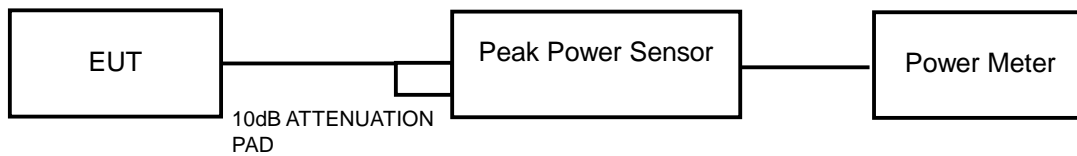

4.4.6 EUT OPERATING CONDITIONS

Same as Item 4.3.6



A D T

4.4.7 TEST RESULTS

802.11b

CHANNEL	FREQUENCY (MHz)	PEAK POWER (mW)	PEAK POWER (dBm)	LIMIT (dBm)	PASS/FAIL
1	2412	39.084	15.92	30	PASS
6	2437	34.277	15.35	30	PASS
11	2462	34.754	15.41	30	PASS

802.11g

CHANNEL	FREQUENCY (MHz)	PEAK POWER (mW)	PEAK POWER (dBm)	LIMIT (dBm)	PASS/FAIL
1	2412	63.241	18.01	30	PASS
6	2437	53.951	17.32	30	PASS
11	2462	69.502	18.42	30	PASS

802.11n (HT20)

CHANNEL	FREQUENCY (MHz)	PEAK POWER (mW)	PEAK POWER (dBm)	LIMIT (dBm)	PASS/FAIL
1	2412	30.339	14.82	30	PASS
6	2437	33.884	15.30	30	PASS
11	2462	47.863	16.80	30	PASS

802.11n (HT40)

CHANNEL	FREQUENCY (MHz)	PEAK POWER (mW)	PEAK POWER (dBm)	LIMIT (dBm)	PASS/FAIL
3	2422	54.954	17.40	30	PASS
6	2437	51.050	17.08	30	PASS
9	2452	54.075	17.33	30	PASS

4.5 AVERAGE OUTPUT POWER

4.5.1 FOR REFERENCE.

4.5.2 TEST INSTRUMENTS

DESCRIPTION & MANUFACTURER	MODEL NO.	SERIAL NO.	CALIBRATED DATE	CALIBRATED UNTIL
Power Meter	ML2495A	1014008	Apr. 23, 2013	Apr. 22, 2014
Power Sensor	MA2411B	0917122	Apr. 23, 2013	Apr. 22, 2014

Note:

1. The calibration interval of the above test instruments is 12 months and the calibrations are traceable to NML/ROC and NIST/USA.
2. Tested date : Oct. 30, 2013

4.5.3 TEST PROCEDURES

Method PM is used to perform output power measurement, trigger and gating function of wide band power meter is enabled to measure max output power of TX on burst. Duty factor is not added to measured value.

4.5.4 TEST SETUP

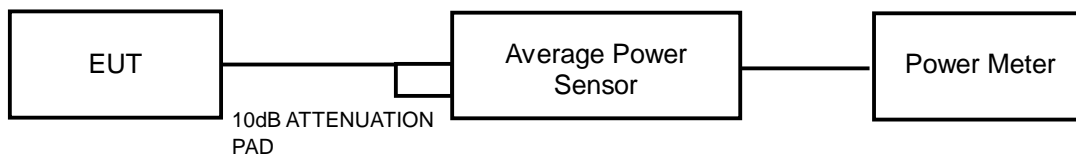

4.5.5 EUT OPERATING CONDITIONS

Same as Item 4.3.6



A D T

4.5.6 TEST RESULTS

802.11b

CHANNEL	FREQUENCY (MHz)	AVERAGE POWER (mW)	AVERAGE POWER (dBm)
1	2412	22.646	13.55
6	2437	19.953	13.00
11	2462	20.230	13.06

802.11g

CHANNEL	FREQUENCY (MHz)	AVERAGE POWER (mW)	AVERAGE POWER (dBm)
1	2412	16.827	12.26
6	2437	15.849	12.00
11	2462	18.408	12.65

802.11n (HT20)

CHANNEL	FREQUENCY (MHz)	AVERAGE POWER (mW)	AVERAGE POWER (dBm)
1	2412	10.691	10.29
6	2437	11.858	10.74
11	2462	10.000	10.00

802.11n (HT40)

CHANNEL	FREQUENCY (MHz)	AVERAGE POWER (mW)	AVERAGE POWER (dBm)
3	2422	10.046	10.02
6	2437	10.965	10.40
9	2452	10.000	10.00

4.6 POWER SPECTRAL DENSITY MEASUREMENT

4.6.1 LIMITS OF POWER SPECTRAL DENSITY MEASUREMENT

The Maximum of Power Spectral Density Measurement is 8dBm.

4.6.2 TEST INSTRUMENTS

DESCRIPTION & MANUFACTURER	MODEL NO.	SERIAL NO.	CALIBRATED DATE	CALIBRATED UNTIL
R&S Spectrum Analyzer	FSP40	100036	Jan. 21, 2013	Jan. 20, 2014

Note:

1. The calibration interval of the above test instruments is 12 months and the calibrations are traceable to NML/ROC and NIST/USA.
2. Tested date : Oct. 30, 2013

4.6.3 TEST PROCEDURE

1. Set the RBW = 3 kHz, VBW =10 kHz, Detector = peak.
2. Sweep time = auto couple, Trace mode = max hold, allow trace to fully stabilize.
3. Use the peak marker function to determine the maximum amplitude level.

4.6.4 DEVIATION FROM TEST STANDARD

No deviation

4.6.5 TEST SETUP

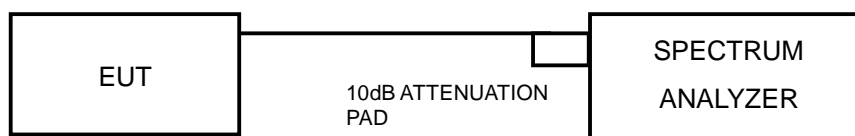

4.6.6 EUT OPERATING CONDITION

Same as Item 4.3.6



A D T

4.6.7 TEST RESULTS

802.11b

Channel	FREQUENCY (MHz)	PSD (dBm)	Limit (dBm)	PASS /FAIL
1	2412	-13.58	8	PASS
6	2437	-15.30	8	PASS
11	2462	-14.63	8	PASS

802.11g

Channel	FREQUENCY (MHz)	PSD (dBm)	Limit (dBm)	PASS /FAIL
1	2412	-15.94	8	PASS
6	2437	-15.92	8	PASS
11	2462	-15.56	8	PASS

802.11n (HT20)

Channel	FREQUENCY (MHz)	PSD (dBm)	Limit (dBm)	PASS /FAIL
1	2412	-18.17	8	PASS
6	2437	-18.27	8	PASS
11	2462	-18.42	8	PASS

802.11n (HT40)

Channel	FREQUENCY (MHz)	PSD (dBm)	Limit (dBm)	PASS /FAIL
3	2422	-20.24	8	PASS
6	2437	-19.75	8	PASS
9	2452	-21.19	8	PASS



A D T

SPECTRUM PLOT OF WORST VALUE

802.11b / CH1

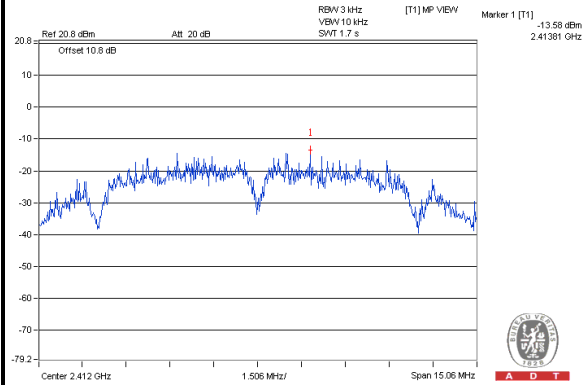

802.11g / CH11

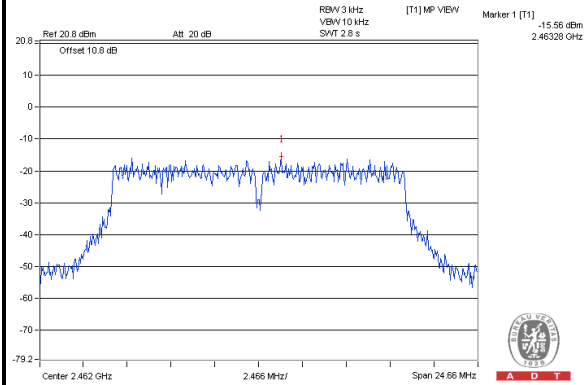

802.11n (HT20) / CH1

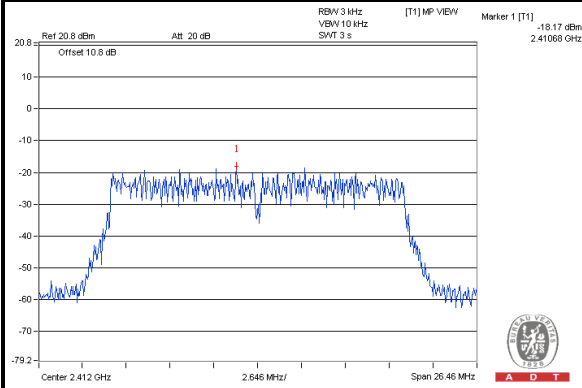

802.11n (HT40) / CH6

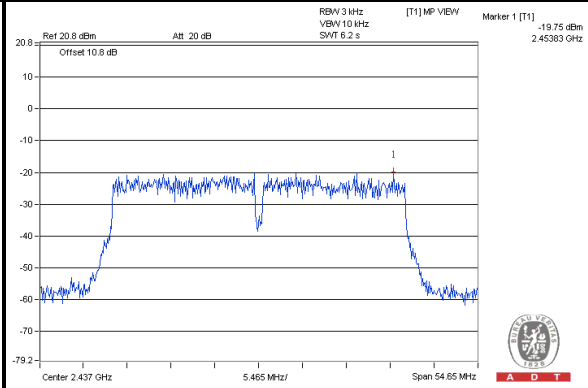



A D T

4.7 CONDUCTED OUT-BAND EMISSION MEASUREMENT

4.7.1 LIMITS OF CONDUCTED OUT-BAND EMISSION MEASUREMENT

Below 20dB of the highest emission level of operating band (in 100kHz Resolution Bandwidth).

4.7.2 TEST INSTRUMENTS

DESCRIPTION & MANUFACTURER	MODEL NO.	SERIAL NO.	CALIBRATED DATE	CALIBRATED UNTIL
R&S Spectrum Analyzer	FSP40	100036	Jan. 21, 2013	Jan. 20, 2014

Note:

1. The calibration interval of the above test instruments is 12 months and the calibrations are traceable to NML/ROC and NIST/USA.
2. Tested date : Oct. 30, 2013

4.7.3 TEST PROCEDURE

Measurement Procedure - Reference Level

1. Set the RBW = 100 kHz.
2. Set the VBW \geq 300 kHz.
3. Detector = peak.
4. Sweep time = auto couple.
5. Trace mode = max hold.
6. Allow trace to fully stabilize.
7. Use the peak marker function to determine the maximum power level in any 100 kHz band segment within the fundamental EBW.

Measurement Procedure –Unwanted Emission Level

1. Set RBW = 100 kHz.
2. Set VBW \geq 300 kHz.
3. Set span to encompass the spectrum to be examined
4. Detector = peak.
5. Trace Mode = max hold.
6. Sweep = auto couple.

4.7.4 DEVIATION FROM TEST STANDARD

No deviation

4.7.5 TEST SETUP

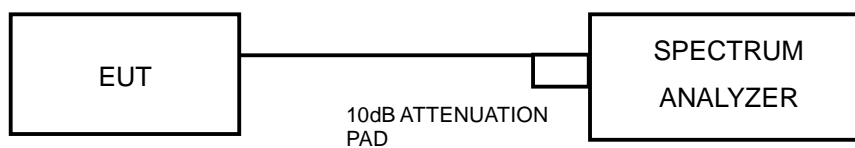

4.7.6 EUT OPERATING CONDITION

Same as Item 4.3.6

4.7.7 TEST RESULTS

The spectrum plots are attached on the following pages. D1 line indicates the highest level, and D2 line indicates the 20dB offset below D1. It shows compliance with the requirement.



A D T

802.11b:

CH 1

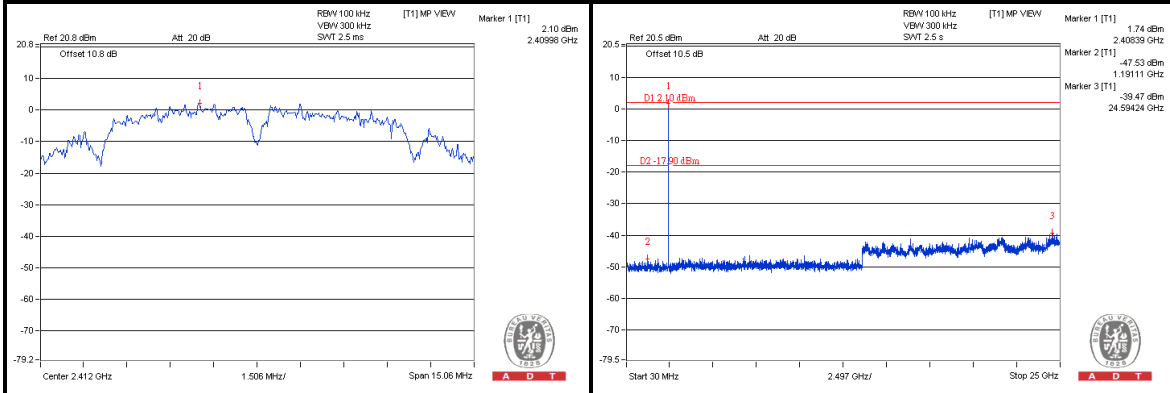

CH 6

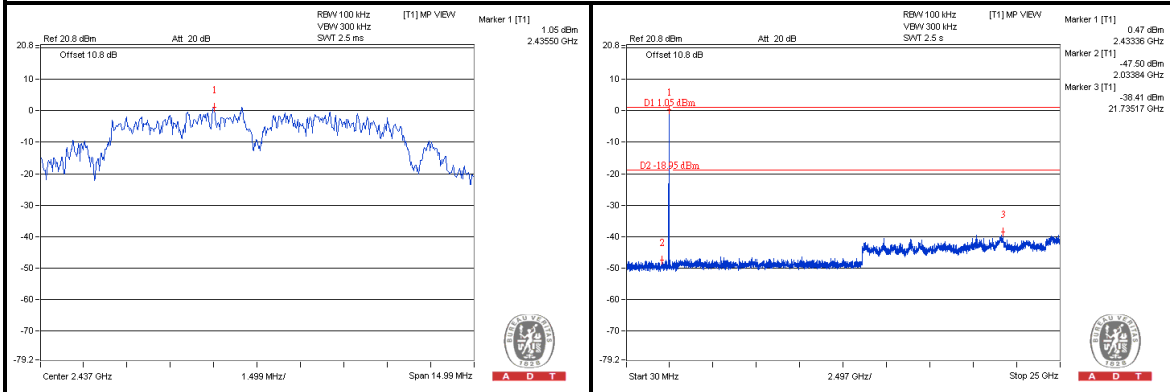

CH 11

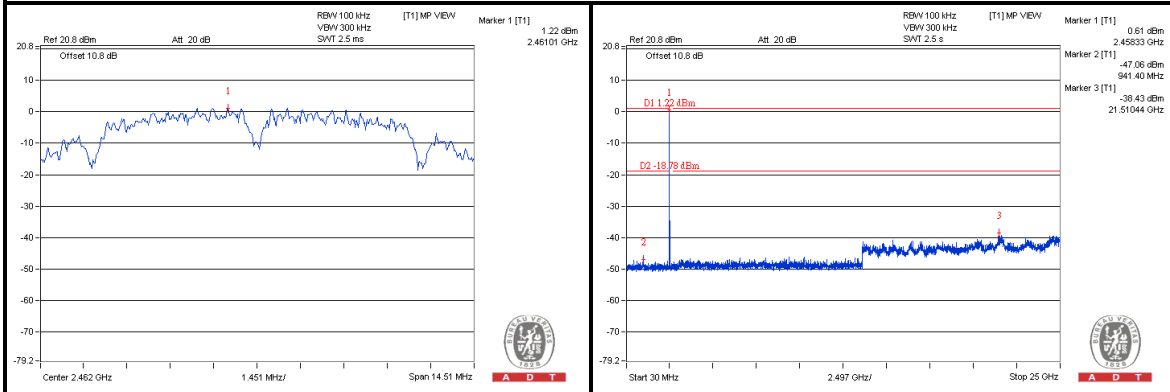

CH 1 Band edge

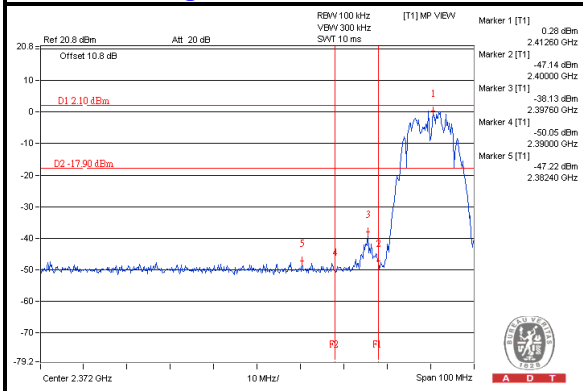

CH 11 Band edge

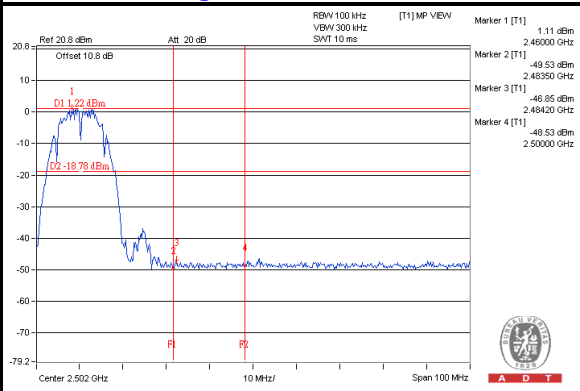



A D T

802.11g:

CH 1

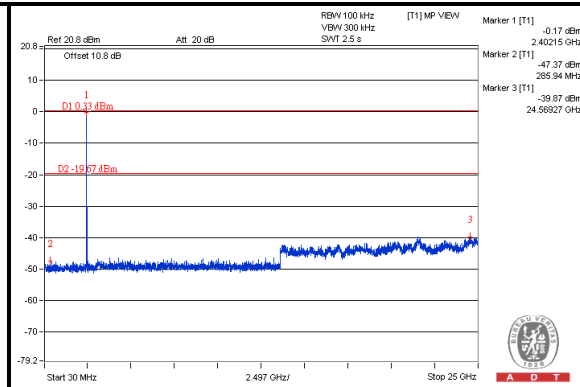
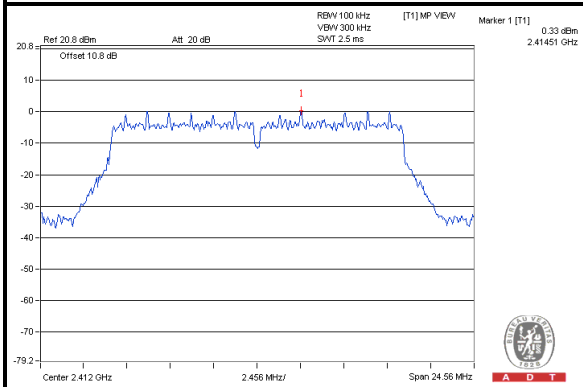

CH 6

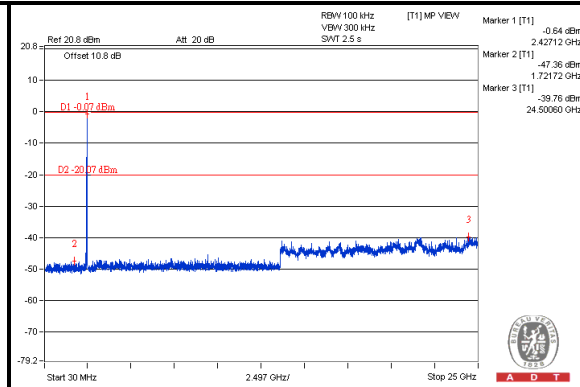
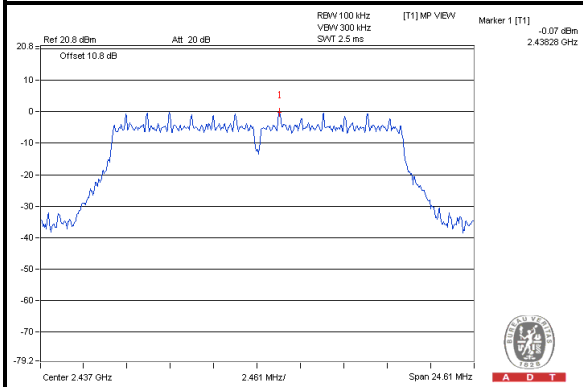

CH 11

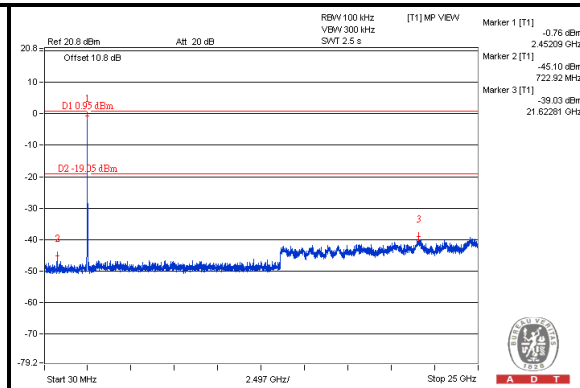
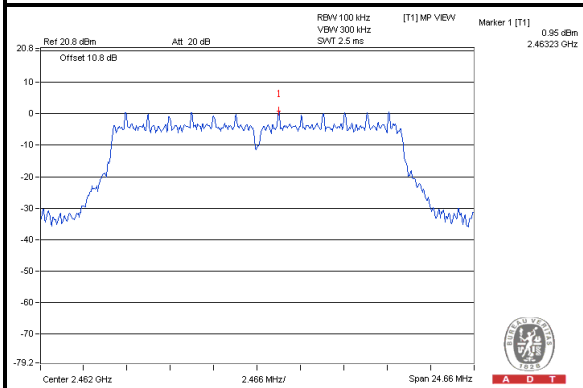

CH 1 Band edge

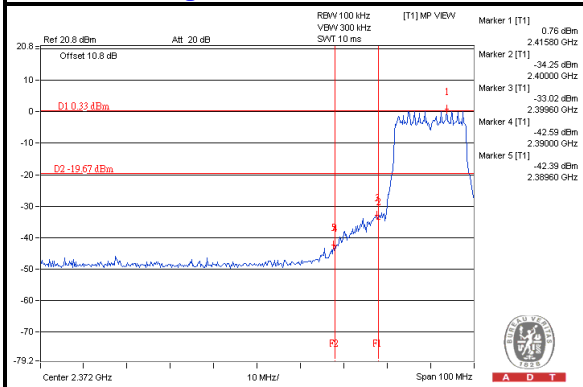

CH 11 Band edge

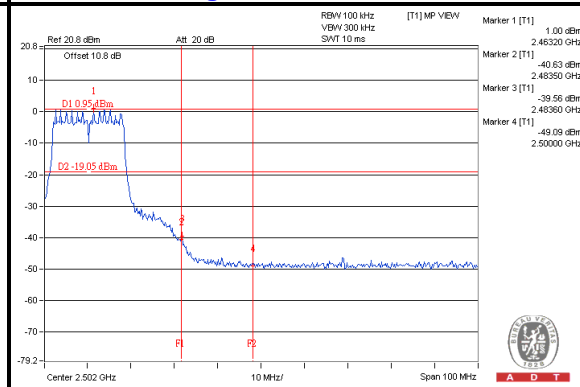



A D T

802.11n (HT20):

CH 1

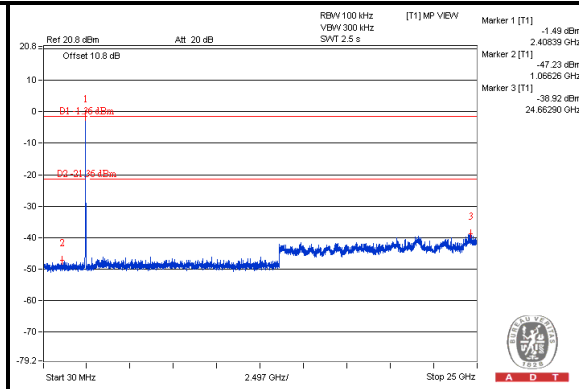
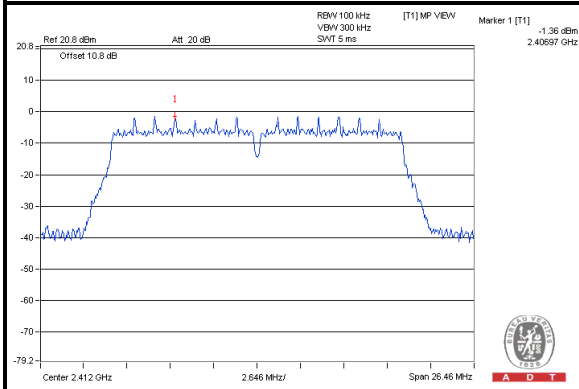

CH 6

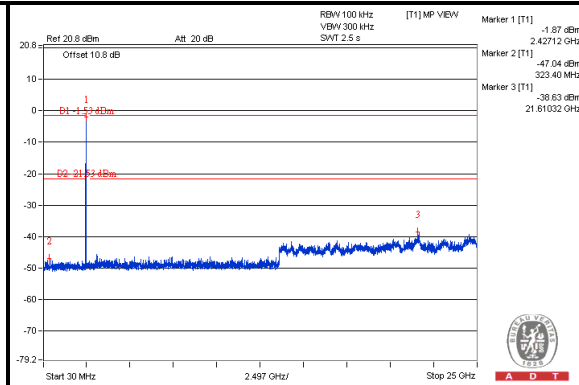
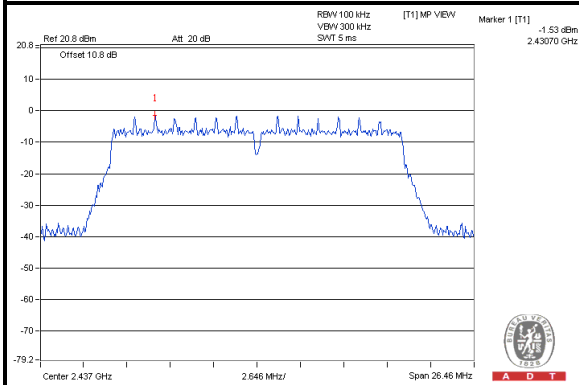

CH 11

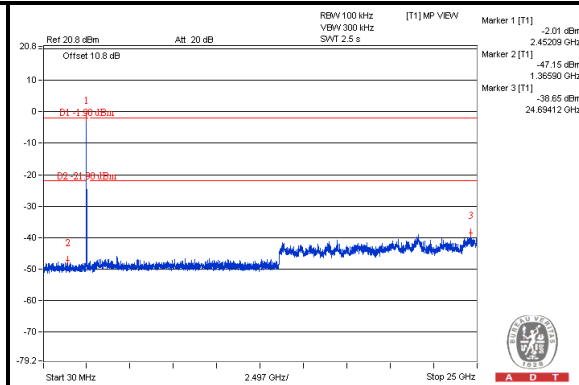
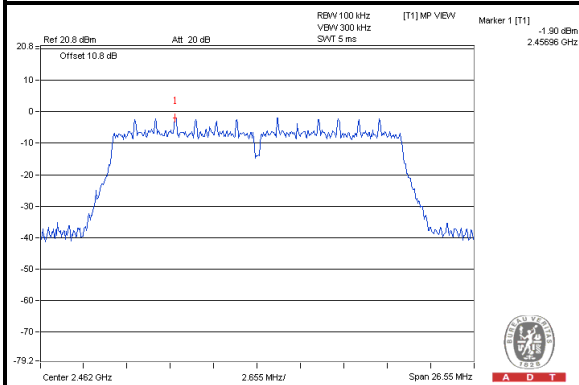

CH 1 Band edge

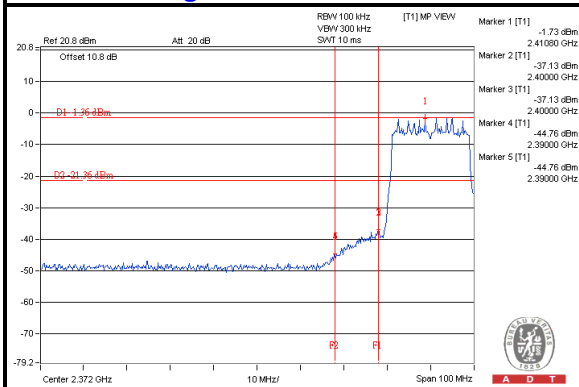

CH 11 Band edge

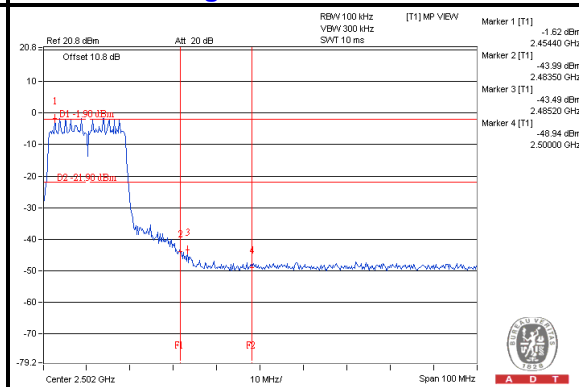



A D T

802.11n (HT40):

CH 3

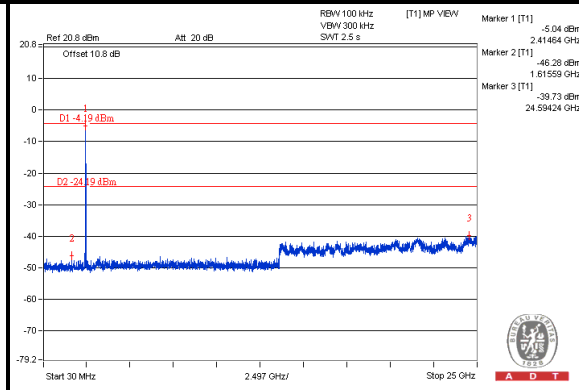
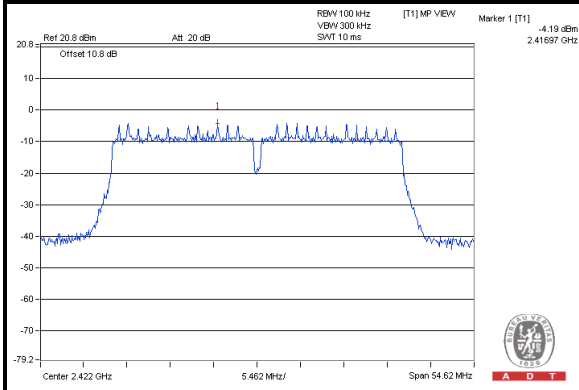

CH 6

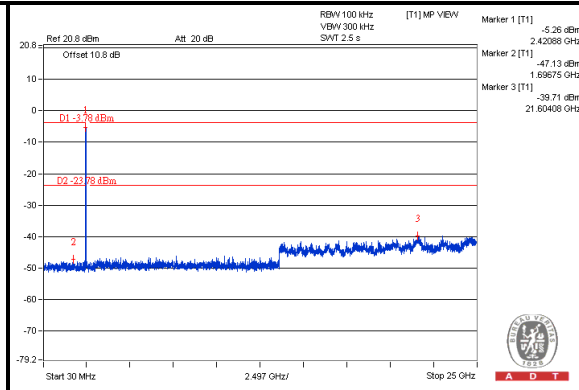
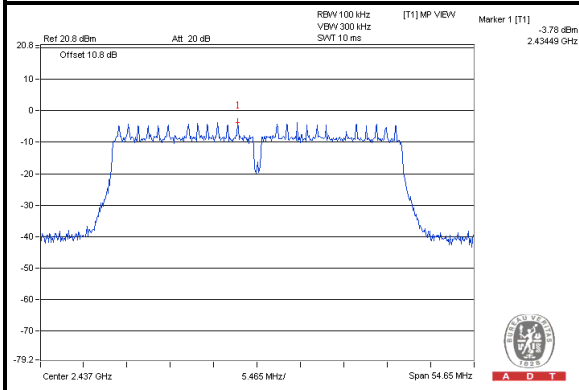

CH 9

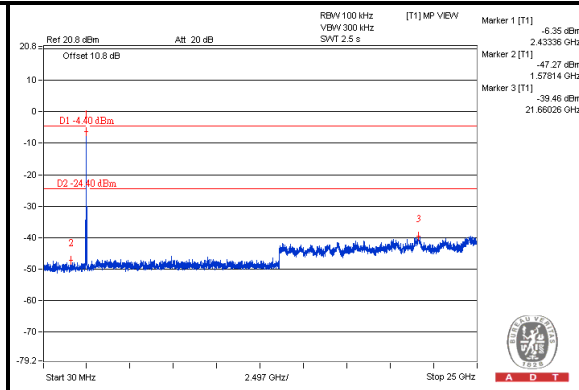
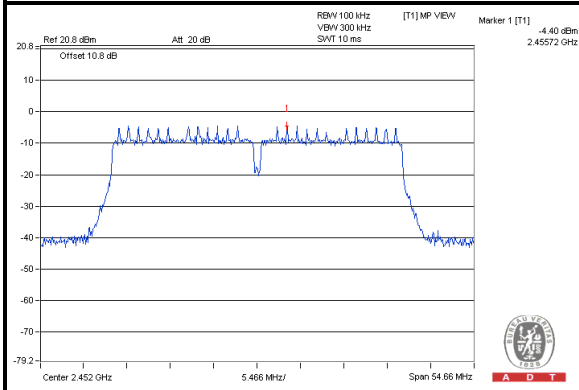

CH 3 Band edge

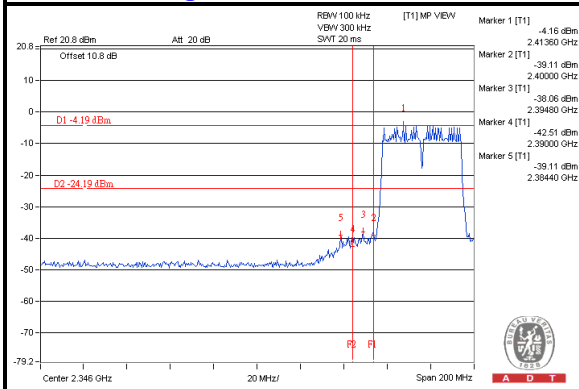

CH 9 Band edge

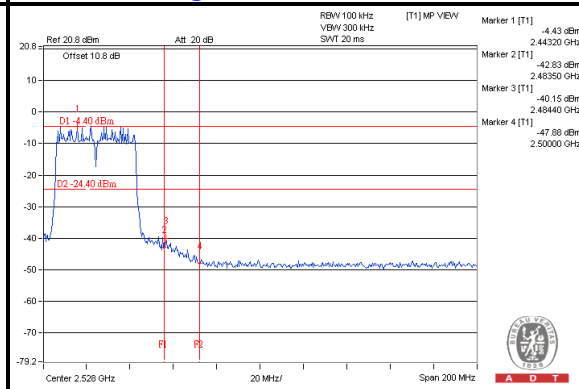



A D T

5. PHOTOGRAPHS OF THE TEST CONFIGURATION

Please refer to the attached file (Test Setup Photo).



6. INFORMATION ON THE TESTING LABORATORIES

We, Bureau Veritas Consumer Products Services (H.K.) Ltd., Taoyuan Branch, were founded in 1988 to provide our best service in EMC, Radio, Telecom and Safety consultation. Our laboratories are accredited and approved according to ISO/IEC 17025.

If you have any comments, please feel free to contact us at the following:

Linko EMC/RF Lab:

Tel: 886-2-26052180

Fax: 886-2-26052943

Hsin Chu EMC/RF Lab:

Tel: 886-3-5935343

Fax: 886-3-5935342

Hwa Ya EMC/RF/Safety/Telecom Lab:

Tel: 886-3-3183232

Fax: 886-3-3270892

Email: service.adt@tw.bureauveritas.com

Web Site: www.bureauveritas-adt.com

The address and road map of all our labs can be found in our web site also.



A D T

7. APPENDIX A - MODIFICATIONS RECORDERS FOR ENGINEERING CHANGES TO THE EUT BY THE LAB

No modifications were made to the EUT by the lab during the test.

--- END ---