

FCC Test Report

FCC ID : TLZ-NM372SM
Equipment : IEEE 802.11 b/g/n Wireless LAN and Bluetooth Module
Model No. : AW-NM372SM
Brand Name : AzureWave
Applicant : AzureWave Technologies, Inc.
Address : 8F., No.94, Baozhong Rd., Xindian Dist. New Taipei City, Taiwan 231
Standard : 47 CFR FCC Part 15.247
Received Date : Oct. 06, 2020
Tested Date : Nov. 27 ~ Dec. 03, 2020

We, International Certification Corp., would like to declare that the tested sample has been evaluated and in compliance with the requirement of the above standards. The test results contained in this report refer exclusively to the product. It may be duplicated completely for legal use with the approval of the applicant. It shall not be reproduced except in full without the written approval of our laboratory.

Reviewed by:

Approved by:

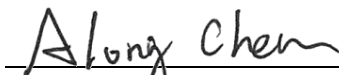

Along Chen / Assistant Manager



Gary Chang / Manager



Table of Contents

1	GENERAL DESCRIPTION	5
1.1	Information.....	5
1.2	Local Support Equipment List	8
1.3	Test Setup Chart	8
1.4	The Equipment List	9
1.5	Test Standards	10
1.6	Reference Guidance	10
1.7	Deviation from Test Standard and Measurement Procedure.....	10
1.8	Measurement Uncertainty	10
2	TEST CONFIGURATION.....	11
2.1	Testing Facility	11
2.2	The Worst Test Modes and Channel Details	11
3	TRANSMITTER TEST RESULTS	12
3.1	Conducted Emissions.....	12
3.2	Unwanted Emissions into Restricted Frequency Bands	15
3.3	Unwanted Emissions into Non-Restricted Frequency Bands	32
3.4	Conducted Output Power	40
3.5	Number of Hopping Frequency	43
3.6	20dB and Occupied Bandwidth.....	47
3.7	Channel Separation.....	54
3.8	Number of Dwell Time.....	61
4	TEST LABORATORY INFORMATION	67

Release Record

Report No.	Version	Description	Issued Date
FR000601AD	Rev. 01	Initial issue	Jan. 26, 2021

Summary of Test Results

FCC Rules	Test Items	Measured	Result
15.207	Conducted Emissions	[dBuV]:0.151MHz 59.93 (Margin -6.03dB) - QP	Pass
15.247(d) 15.209	Radiated Emissions	[dBuV/m at 3m]: 4804.00MHz 49.26 (Margin -4.74dB) - AV	Pass
15.247(d)	Band Edge	Meet the requirement of limit	Pass
15.247(b)(1)	Conducted Output Power	Power [dBm]: 9.29	Pass
15.247(a)(1)(iii)	Number of Hopping Channels	Meet the requirement of limit	Pass
15.247(a)(1)	Hopping Channel Separation	Meet the requirement of limit	Pass
15.247(a)(1)(iii)	Dwell Time	Meet the requirement of limit	Pass
15.203	Antenna Requirement	Meet the requirement of limit	Pass

Declaration of Conformity:

The test results with all measurement uncertainty excluded are presented in accordance with the regulation limits or requirements declared by manufacturers.

Comments and Explanations:

The declared of product specification for EUT presented in the report are provided by the manufacturer, and the manufacturer takes all the responsibilities for the accuracy of product specification.

1 General Description

1.1 Information

1.1.1 Specification of the Equipment under Test (EUT)

RF General Information				
Frequency Range (MHz)	Bluetooth Mode	Ch. Frequency (MHz)	Channel Number	Data Rate
2400-2483.5	BR V5.0	2402-2480	0-78 [79]	1 Mbps
2400-2483.5	EDR V5.0	2402-2480	0-78 [79]	2 Mbps
2400-2483.5	EDR V5.0	2402-2480	0-78 [79]	3 Mbps

Note 1: RF output power specifies that Maximum Peak Conducted Output Power.
 Note 2: Bluetooth BR uses a GFSK.
 Note 3: Bluetooth EDR uses a combination of $\pi/4$ -DQPSK and 8DPSK.

1.1.2 Antenna Details

Ant. No.	Type	Gain (dBi)	Connector
1	PIFA	3	UFL

1.1.3 Power Supply Type of Equipment under Test (EUT)

Power Supply Type	3.3Vdc from host
--------------------------	------------------

1.1.4 Accessories

N/A

1.1.5 Channel List

Frequency band (MHz)				2400~2483.5			
Channel	Frequency (MHz)	Channel	Frequency (MHz)	Channel	Frequency (MHz)	Channel	Frequency (MHz)
0	2402	20	2422	40	2442	60	2462
1	2403	21	2423	41	2443	61	2463
2	2404	22	2424	42	2444	62	2464
3	2405	23	2425	43	2445	63	2465
4	2406	24	2426	44	2446	64	2466
5	2407	25	2427	45	2447	65	2467
6	2408	26	2428	46	2448	66	2468
7	2409	27	2429	47	2449	67	2469
8	2410	28	2430	48	2450	68	2470
9	2411	29	2431	49	2451	69	2471
10	2412	30	2432	50	2452	70	2472
11	2413	31	2433	51	2453	71	2473
12	2414	32	2434	52	2454	72	2474
13	2415	33	2435	53	2455	73	2475
14	2416	34	2436	54	2456	74	2476
15	2417	35	2437	55	2457	75	2477
16	2418	36	2438	56	2458	76	2478
17	2419	37	2439	57	2459	77	2479
18	2420	38	2440	58	2460	78	2480
19	2421	39	2441	59	2461	---	---

1.1.6 Test Tool and Duty Cycle

Test Tool	GNOME Terminal, 3.28.2 / Bluetooth tester	
Modulation Mode	Duty Cycle Of Test Signal (%)	Duty Factor (dB)
DH5	78.76%	1.04
2DH5	78.46%	1.05
3DH5	79.38%	1.00

1.1.7 Power Index of Test Tool

Modulation Mode	Test Frequency (MHz)		
	2402	2441	2480
GFSK/1Mbps	Default	Default	Default
$\pi/4$ -DQPSK /2Mbps	Default	Default	Default
8DPSK/3Mbps	Default	Default	Default

1.2 Local Support Equipment List

Support Equipment List					
No.	Equipment	Brand	Model	FCC ID	Remarks
1	Notebook	DELL	Latitude E5470	BJ5JVF2	---
2	USB 3.0 Flash	SiliconPower	BLAZE B05	0000010	---
3	SDIO Fixture	---	---	---	Provided by applicant.
4	Fixture board	---	---	---	Provided by applicant.
5	Fixture board	---	---	---	Provided by applicant.

1.3 Test Setup Chart

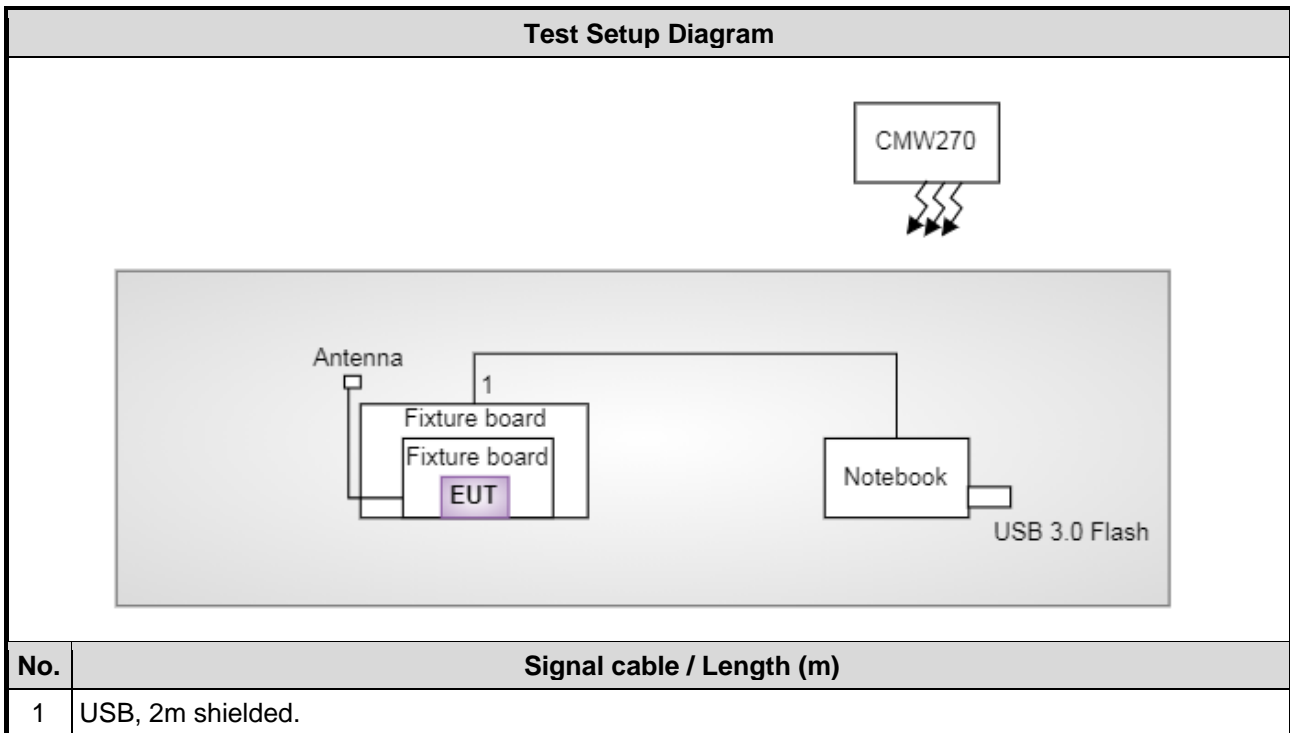

Note: The SDIO fixture is disconnected from EUT and removed from test table when EUT is set to transmit continuously

1.4 The Equipment List

Test Item	Conducted Emission				
Test Site	Conduction room 1 / (CO01-WS)				
Tested Date	Nov. 30, 2020				
Instrument	Brand	Model No.	Serial No.	Calibration Date	Calibration Until
Receiver	R&S	ESR3	101658	Dec. 12, 2019	Dec. 11, 2020
LISN	R&S	ENV216	101579	Mar. 12, 2020	Mar. 11, 2021
RF Cable-CON	Woken	CFD200-NL	CFD200-NL-001	Oct. 21, 2020	Oct. 20, 2021
Measurement Software	AUDIX	e3	6.120210k	NA	NA
Wireless connectivity tester	ROHDE&SCHWARZ	CMW270	100856	Nov. 02, 2020	Nov. 01, 2021
Note: Calibration Interval of instruments listed above is one year.					

Test Item	Radiated Emission				
Test Site	966 chamber 3 / (03CH03-WS)				
Tested Date	Nov. 27, 2020				
Instrument	Brand	Model No.	Serial No.	Calibration Date	Calibration Until
Spectrum Analyzer	R&S	FSV40	101499	Jan. 09, 2020	Jan. 08, 2021
Receiver	R&S	ESR3	101657	Feb. 14, 2020	Feb. 13, 2021
Bilog Antenna	SCHWARZBECK	VULB9168	VULB9168-685	Apr. 29, 2020	Apr. 28, 2021
Horn Antenna 1G-18G	SCHWARZBECK	BBHA 9120 D	BBHA 9120 D 1206	Dec. 27, 2019	Dec. 26, 2020
Horn Antenna 18G-40G	SCHWARZBECK	BBHA 9170	BBHA 9170517	Nov. 06, 2020	Nov. 05, 2021
Loop Antenna	R&S	HFH2-Z2	100330	Nov. 17, 2020	Nov. 16, 2021
Loop Antenna Cable	KOAX KABEL	101354-BW	101354-BW	Oct. 06, 2020	Oct. 05, 2021
Preamplifier	EMC	EMC02325	980187	Aug. 05, 2020	Aug. 04, 2021
Preamplifier	Agilent	83017A	MY39501309	Sep. 02, 2020	Sep. 01, 2021
Preamplifier	EMC	EMC184045B	980192	Jul. 21, 2020	Jul. 20, 2021
RF cable-3M	HUBER+SUHNER	SUCOFLEX104	MY22620/4	Sep. 26, 2020	Sep. 25, 2021
RF cable-8M	EMC	EMC104-SM-SM-8000	181107	Sep. 26, 2020	Sep. 25, 2021
RF cable-1M	HUBER+SUHNER	SUCOFLEX104	MY22624/4	Sep. 26, 2020	Sep. 25, 2021
LF cable-0.8M	EMC	EMC8D-NM-NM-800	EMC8D-NM-NM-800-001	Sep. 26, 2020	Sep. 25, 2021
LF cable-3M	EMC	EMC8D-NM-NM-3000	131103	Sep. 26, 2020	Sep. 25, 2021
LF cable-13M	EMC	EMC8D-NM-NM-13000	131104	Sep. 26, 2020	Sep. 25, 2021
Measurement Software	AUDIX	e3	6.120210g	NA	NA
Wireless connectivity tester	ROHDE&SCHWARZ	CMW270	100856	Nov. 02, 2020	Nov. 01, 2021
Note: Calibration Interval of instruments listed above is one year.					

Test Item	RF Conducted				
Test Site	(TH01-WS)				
Tested Date	Dec. 03, 2020				
Instrument	Brand	Model No.	Serial No.	Calibration Date	Calibration Until
Spectrum Analyzer	R&S	FSV40	101063	Apr. 30, 2020	Apr. 29, 2021
Power Meter	Anritsu	ML2495A	1241002	Nov. 04, 2020	Nov. 03, 2021
Power Sensor	Anritsu	MA2411B	1207366	Nov. 04, 2020	Nov. 03, 2021
DC POWER SOURCE	GW INSTRON	GPC-6030D	GES855395	Nov. 09, 2020	Nov. 08, 2021
Measurement Software	Sporton	Sporton_1	1.3.30	NA	NA
Wireless connectivity tester	ROHDE&SCHWARZ	CMW270	100856	Nov. 02, 2020	Nov. 01, 2021
Note: Calibration Interval of instruments listed above is one year.					

1.5 Test Standards

47 CFR FCC Part 15.247
ANSI C63.10-2013

1.6 Reference Guidance

FCC KDB 558074 D01 15.247 Meas Guidance v05r02

1.7 Deviation from Test Standard and Measurement Procedure

None

1.8 Measurement Uncertainty

The measurement uncertainties given below are based on a 95% confidence level (based on a coverage factor (k=2)).

Measurement Uncertainty	
Parameters	Uncertainty
Bandwidth	±34.130 Hz
Conducted power	±0.808 dB
Power density	±0.583 dB
Conducted emission	±2.715 dB
AC conducted emission	±2.92 dB
Radiated emission ≤ 1GHz	±3.96 dB
Radiated emission > 1GHz	±4.51 dB
Time	±0.1%

2 Test Configuration

2.1 Testing Facility

Test Laboratory	International Certification Corp.
Test Site	CO01-WS, TH01-WS
Address of Test Site	No. 3-1, Lane 6, Wen San 3rd St., Kwei Shan District, Tao Yuan City 333, Taiwan, R.O.C.
Test Site	03CH03-WS
Address of Test Site	No. 14-1, Lane 19, Wen San 3rd St., Kwei Shan District, Tao Yuan City 333, Taiwan, R.O.C.

- FCC Designation No.: TW0009
- FCC site registration No.: 207696
- ISED#: 10807A
- CAB identifier: TW2732

2.2 The Worst Test Modes and Channel Details

Test item	Mode	Test Frequency (MHz)	Data Rate (Mbps)	Test Configuration
Conducted Emissions Radiated Emissions ≤ 1GHz	GFSK	2441	1Mbps	---
Radiated Emissions > 1GHz	GFSK 8DPSK	2402, 2441, 2480 2402, 2441, 2480	1Mbps 3Mbps	---
Conducted Output Power	GFSK π/4 DQPSK 8DPSK	2402, 2441, 2480 2402, 2441, 2480 2402, 2441, 2480	1Mbps 2Mbps 3Mbps	---
Number of Hopping Channels	GFSK π/4 DQPSK 8DPSK	2402~2480 2402~2480 2402~2480	1Mbps 2Mbps 3Mbps	---
Hopping Channel Separation 20dB and Occupied bandwidth	GFSK π/4 DQPSK 8DPSK	2402, 2441, 2480 2402, 2441, 2480 2402, 2441, 2480	1Mbps 2Mbps 3Mbps	---
Dwell Time	GFSK π/4 DQPSK 8DPSK	2402 2402 2402	1Mbps 2Mbps 3Mbps	---

NOTE:

1. The EUT was pretested with 3 orientations placed on the table for the radiated emission measurement – X, Y, and Z-plane. The **Y-plane** results were found as the worst case and were shown in this report.

3 Transmitter Test Results

3.1 Conducted Emissions

3.1.1 Limit of Conducted Emissions

Conducted Emissions Limit		
Frequency Emission (MHz)	Quasi-Peak	Average
0.15-0.5	66 - 56 *	56 - 46 *
0.5-5	56	46
5-30	60	50

Note 1: * Decreases with the logarithm of the frequency.

3.1.2 Test Procedures

1. The device is placed on a test table, raised 80 cm above the reference ground plane. The vertical conducting plane is located 40 cm to the rear of the device.
2. The device is connected to line impedance stabilization network (LISN) and other accessories are connected to other LISN. Measured levels of AC power line conducted emission are across the 50 Ω LISN port.
3. AC conducted emission measurements is made over frequency range from 150 kHz to 30 MHz.
4. This measurement was performed with AC 120V/60Hz

3.1.3 Test Setup



- Note: 1. Support units were connected to second LISN.
 2. Both of LISNs (AMN) are 80 cm from EUT and at least 80 cm from other units and other metal planes

3.1.4 Test Result of Conducted Emissions

Modulation Mode	GFSK	Test Freq. (MHz)	2441
Power Phase	Line		

Test by : Alex Tsai Temperature: 25°C Humidity: 61%

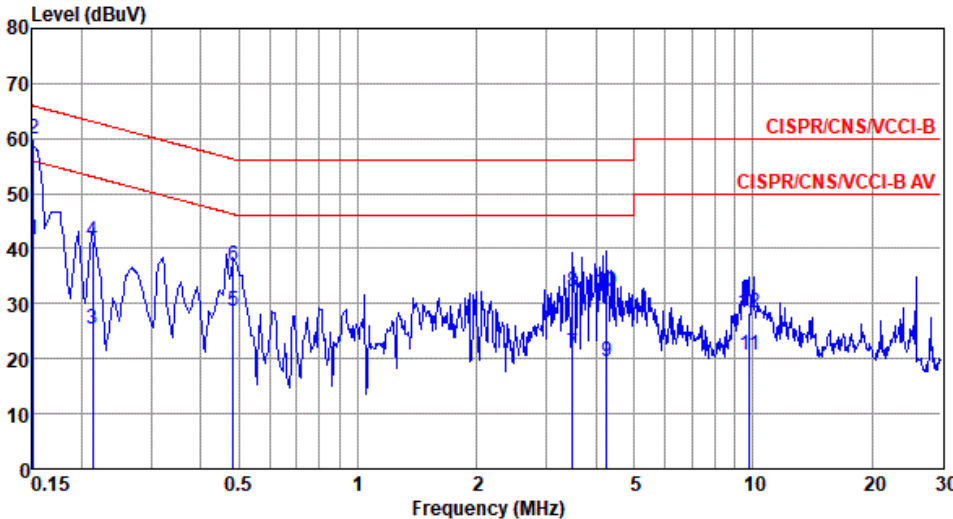

The graph displays the conducted emission level in dBuV on the y-axis (0 to 80) against frequency in MHz on the x-axis (0.15 to 30). Two red lines represent the limits: CISPR/CNS/VCCI-B (upper) and CISPR/CNS/VCCI-B AV (lower). A blue line shows the measured emission level with several peaks. A table below the graph provides detailed data for these peaks.

	Freq MHz	Level dBuV	Limit Line dBuV	Over Limit dB	Read Level dBuV	LISN factor dB	cable loss dB	Remark
1	0.151	41.49	55.96	-14.47	31.80	9.64	0.05	Average
2*	0.151	59.93	65.96	-6.03	50.24	9.64	0.05	QP
3	0.213	25.27	53.10	-27.83	15.58	9.63	0.06	Average
4	0.213	41.41	63.10	-21.69	31.72	9.63	0.06	QP
5	0.484	28.58	46.27	-17.69	18.86	9.63	0.09	Average
6	0.484	37.04	56.27	-19.23	27.32	9.63	0.09	QP
7	3.491	20.94	46.00	-25.06	11.02	9.65	0.27	Average
8	3.491	32.14	56.00	-23.86	22.22	9.65	0.27	QP
9	4.269	19.54	46.00	-26.46	9.59	9.65	0.30	Average
10	4.269	32.13	56.00	-23.87	22.18	9.65	0.30	QP
11	9.809	20.61	50.00	-29.39	10.53	9.69	0.39	Average
12	9.809	28.39	60.00	-31.61	18.31	9.69	0.39	QP

Note 1: Level (dBuV) = Read Level (dBuV) + LISN Factor (dB) + Cable Loss (dB).
 Note 2: Over Limit (dB) = Level (dBuV) – Limit Line (dBuV).

Modulation Mode	GFSK	Test Freq. (MHz)	2441
Power Phase	Neutral		

Test by : Alex Tsai Temperature: 25°C Humidity: 61%

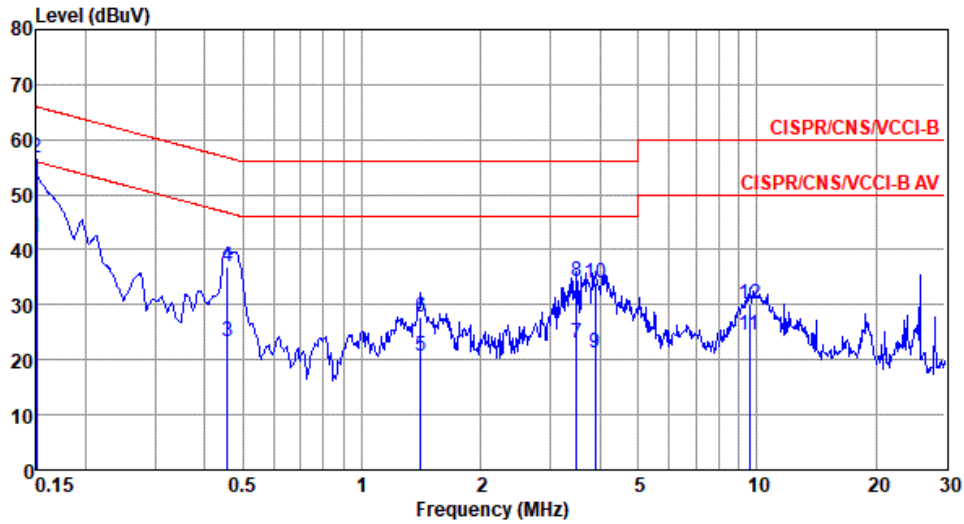

	Freq MHz	Level dBuV	Limit Line dBuV	Over Limit dB	Read Level dBuV	LISN factor dB	cable loss dB	Remark
1	0.150	42.18	56.00	-13.82	32.47	9.66	0.05	Average
2*	0.150	56.65	66.00	-9.35	46.94	9.66	0.05	QP
3	0.456	23.41	46.76	-23.35	13.67	9.65	0.09	Average
4	0.456	36.79	56.76	-19.97	27.05	9.65	0.09	QP
5	1.411	20.55	46.00	-25.45	10.75	9.65	0.15	Average
6	1.411	27.77	56.00	-28.23	17.97	9.65	0.15	QP
7	3.491	23.13	46.00	-22.87	13.19	9.67	0.27	Average
8	3.491	34.13	56.00	-21.87	24.19	9.67	0.27	QP
9	3.901	21.13	46.00	-24.87	11.17	9.67	0.29	Average
10	3.901	34.03	56.00	-21.97	24.07	9.67	0.29	QP
11	9.552	24.38	50.00	-25.62	14.27	9.73	0.38	Average
12	9.552	30.11	60.00	-29.89	20.00	9.73	0.38	QP

Note 1: Level (dBuV) = Read Level (dBuV) + LISN Factor (dB) + Cable Loss (dB).
 2: Over Limit (dB) = Level (dBuV) – Limit Line (dBuV).

3.2 Unwanted Emissions into Restricted Frequency Bands

3.2.1 Limit of Unwanted Emissions into Restricted Frequency Bands

Restricted Band Emissions Limit			
Frequency Range (MHz)	Field Strength (uV/m)	Field Strength (dBuV/m)	Measure Distance (m)
0.009~0.490	2400/F(kHz)	48.5 - 13.8	300
0.490~1.705	24000/F(kHz)	33.8 - 23	30
1.705~30.0	30	29	30
30~88	100	40	3
88~216	150	43.5	3
216~960	200	46	3
Above 960	500	54	3

Note 1:
Qusai-Peak value is measured for frequency below 1GHz except for 9–90 kHz, 110–490 kHz frequency band. Peak and average value are measured for frequency above 1GHz. The limit on average radio frequency emission is as above table. The limit on peak radio frequency emissions is 20 dB above the maximum permitted average emission limit

Note 2:
Measurements may be performed at a distance other than what is specified provided. When performing measurements at a distance other than that specified, the results shall be extrapolated to the specified distance using an extrapolation factor as below, Frequency at or above 30 MHz: 20 dB/decade Frequency below 30 MHz: 40 dB/decade.

3.2.2 Test Procedures

1. Measurement is made at a semi-anechoic chamber that incorporates a turntable allowing a EUT rotation of 360°. A continuously-rotating, remotely-controlled turntable is installed at the test site to support the EUT and facilitate determination of the direction of maximum radiation for each EUT emission frequency. The EUT is placed at test table. For emissions testing at or below 1 GHz, the table height is 80 cm above the reference ground plane. For emission measurements above 1 GHz, the table height is 1.5 m
2. Measurement is made with the antenna positioned in both the horizontal and vertical planes of polarization. The measurement antenna is varied in height (1m ~ 4m) above the reference ground plane to obtain the maximum signal strength. Distance between EUT and antenna is 3 m.
3. This investigation is performed with the EUT rotated 360°, the antenna height scanned between 1 m and 4 m, and the antenna rotated to repeat the measurements for both the horizontal and vertical antenna polarizations.

Note:

1. 120kHz measurement bandwidth of test receiver and Quasi-peak detector is for radiated emission below 1GHz.
2. Radiated emission above 1GHz / Peak value
RBW=1MHz, VBW=3MHz and Peak detector
Radiated emission above 1GHz / Average value for harmonics
The average value is: Average = Peak value + 20log(Duty cycle) Where the duty factor is calculated from following formula for DH5 packet type which has worst duty factor:
3.
$$20\log(\text{Duty cycle}) = 20\log \frac{1\text{s} / 1600 * 5}{100\text{ ms}} = -30.1\text{dB}$$
4. Radiated emission above 1GHz / Average value for other emissions
RBW=1MHz, VBW=1/T and Peak detector

3.2.3 Test Setup

Radiated Emissions below 1 GHz

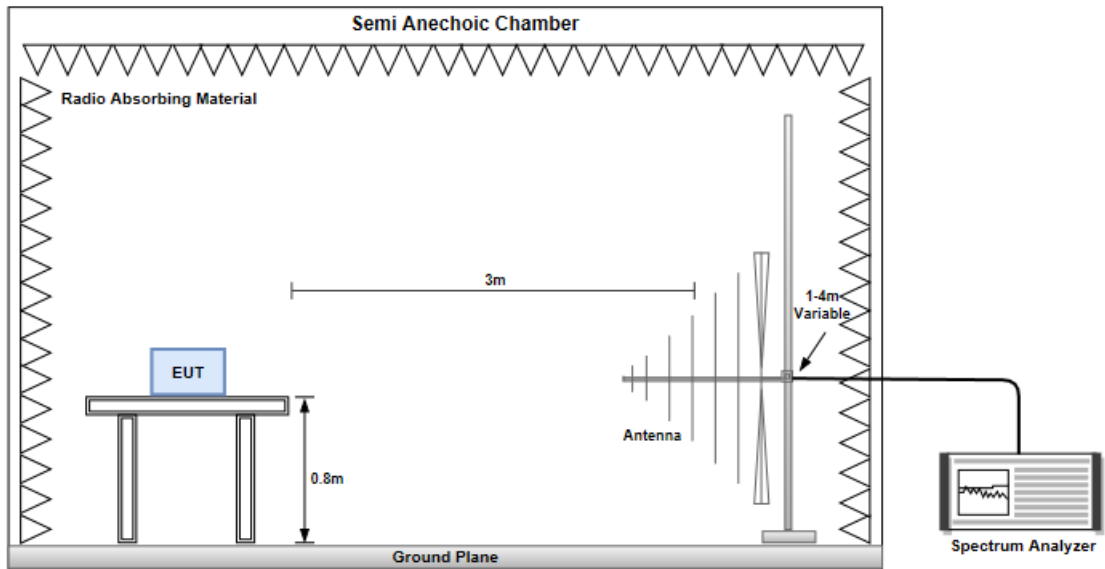

Radiated Emissions above 1 GHz

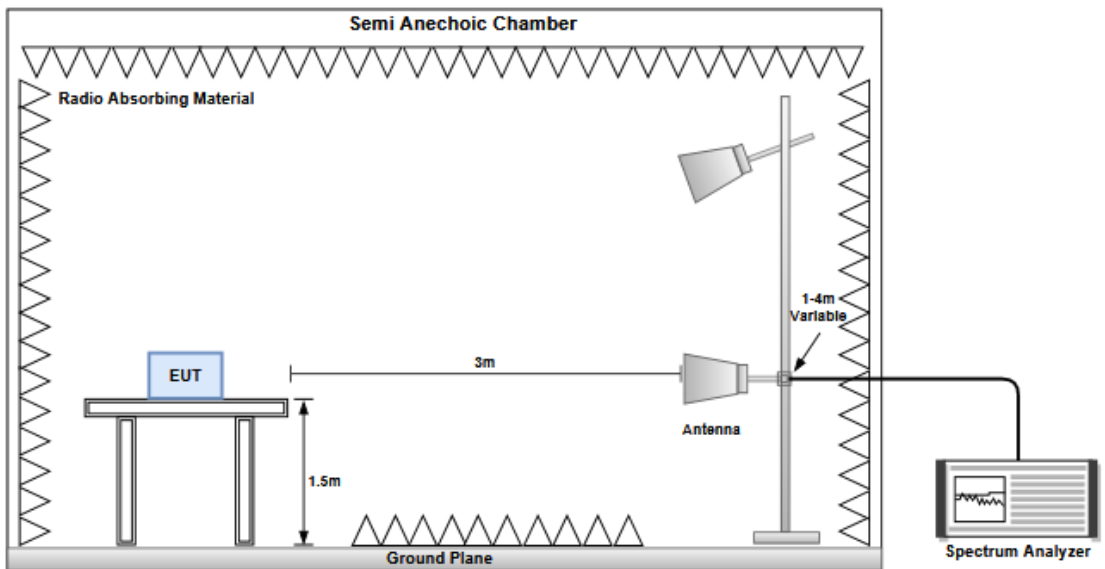

3.2.4 Transmitter Radiated Unwanted Emissions (Below 1GHz)

Modulation	GFSK	Test Freq. (MHz)	2441
Polarization	Horizontal		
Test By : Roger Lu		Temperature(°C): 25	Humidity(%): 61

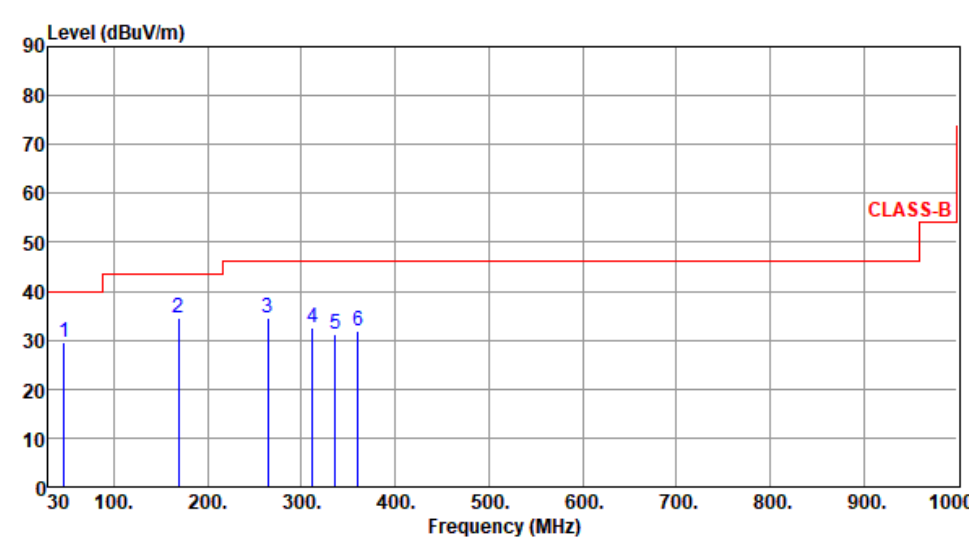

	Freq. MHz	Emission level dBuV/m	Limit dBuV/m	Margin dB	SA reading dBuV	Factor dB	Remark	ANT High cm	Turn Table deg
1	46.52	29.54	40.00	-10.46	38.29	-8.75	Peak	---	---
2	168.59	34.45	43.50	-9.05	43.61	-9.16	Peak	---	---
3	263.81	34.58	46.00	-11.42	44.38	-9.80	Peak	---	---
4	311.56	32.61	46.00	-13.39	40.86	-8.25	Peak	---	---
5	336.29	31.24	46.00	-14.76	38.54	-7.30	Peak	---	---
6	360.52	31.86	46.00	-14.14	38.88	-7.02	Peak	---	---

Note 1: Emission Level (dBuV/m) = SA Reading (dBuV/m) + Factor* (dB)
 *Factor includes antenna factor , cable loss and amplifier gain
 Note 2: Margin (dB) = Emission level (dBuV/m) – Limit (dBuV/m).
 Note 3: All spurious emissions below 30MHz are more than 20 dB below the limit.

Modulation	GFSK	Test Freq. (MHz)	2441
Polarization	Vertical		

Test By :Roger Lu Temperature(°C):25 Humidity(%):61

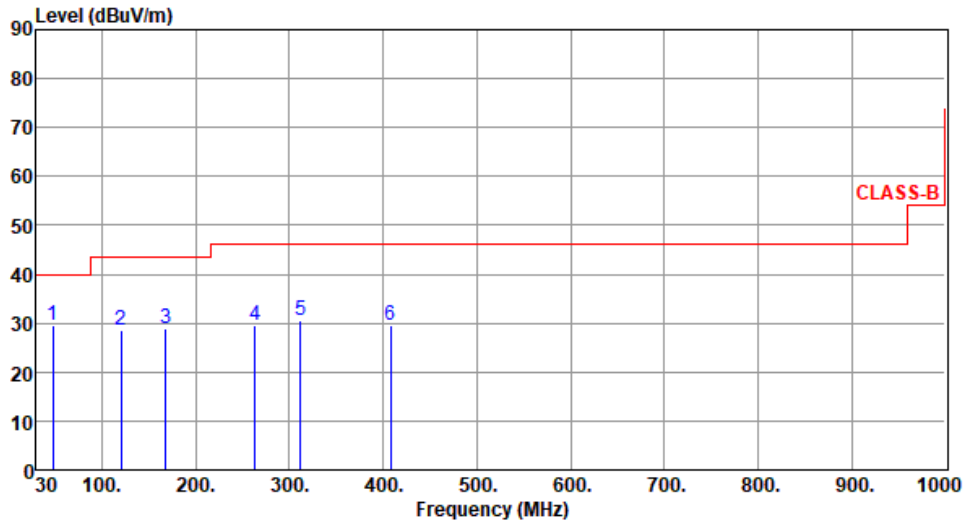

	Freq. MHz	Emission level dBuV/m	Limit dBuV/m	Margin dB	SA reading dBuV	Factor dB	Remark	ANT High cm	Turn Table deg
1	47.59	29.68	40.00	-10.32	38.57	-8.89	Peak	---	---
2	120.49	28.56	43.50	-14.94	39.70	-11.14	Peak	---	---
3	167.81	28.75	43.50	-14.75	37.85	-9.10	Peak	---	---
4	263.61	29.44	46.00	-16.56	39.25	-9.81	Peak	---	---
5	311.45	30.53	46.00	-15.47	38.78	-8.25	Peak	---	---
6	408.44	29.64	46.00	-16.36	35.24	-5.60	Peak	---	---

Note 1: Emission Level (dBuV/m) = SA Reading (dBuV/m) + Factor* (dB)

*Factor includes antenna factor , cable loss and amplifier gain

Note 2: Margin (dB) = Emission level (dBuV/m) – Limit (dBuV/m).

Note 3: All spurious emissions below 30MHz are more than 20 dB below the limit.

3.2.5 Transmitter Radiated Unwanted Emissions (Above 1GHz) for GFSK

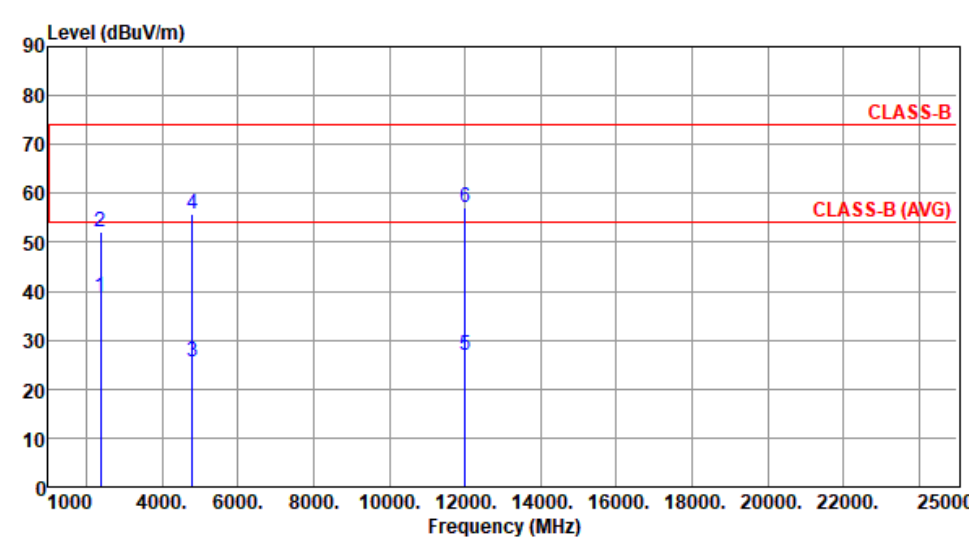
Modulation	GFSK	Test Freq. (MHz)	2402						
Polarization	Horizontal								
Test By : Roger Lu Temperature(°C):25 Humidity(%):61									
 <p>The graph plots Level (dBuV/m) on the y-axis (0 to 90) against Frequency (MHz) on the x-axis (1000 to 25000). Two horizontal red lines represent limits: CLASS-B at approximately 74 dBuV/m and CLASS-B (AVG) at approximately 54 dBuV/m. Six data points are shown as vertical blue lines with labels 1 through 6. Point 1 is at 2390 MHz (level ~38.69), point 2 at 2390 MHz (level ~52.21), point 3 at 4804 MHz (level ~25.53), point 4 at 4804 MHz (level ~55.63), point 5 at 12010 MHz (level ~26.93), and point 6 at 12010 MHz (level ~57.03).</p>									
	Freq.	Emission level	Limit	Margin	SA reading	Factor	Remark	ANT High	Turn Table
	MHz	dBuV/m	dBuV/m	dB	dBuV	dB		cm	deg
1	2390.00	38.69	54.00	-15.31	40.53	-1.84	Average	102	179
2	2390.00	52.21	74.00	-21.79	54.05	-1.84	Peak	102	179
3	4804.00	25.53	54.00	-28.47	20.52	5.01	Average	216	357
4	4804.00	55.63	74.00	-18.37	50.62	5.01	Peak	216	357
5	12010.00	26.93	54.00	-27.07	12.43	14.50	Average	100	80
6	12010.00	57.03	74.00	-16.97	42.53	14.50	Peak	100	80

Note 1: Emission Level (dBuV/m) = SA Reading (dBuV/m) + Factor* (dB)
*Factor includes antenna factor , cable loss and amplifier gain
Note 2: Margin (dB) = Emission level (dBuV/m) – Limit (dBuV/m).

Modulation	GFSK	Test Freq. (MHz)	2402
Polarization	Vertical		

Test By :Roger Lu Temperature(°C):25 Humidity(%):61

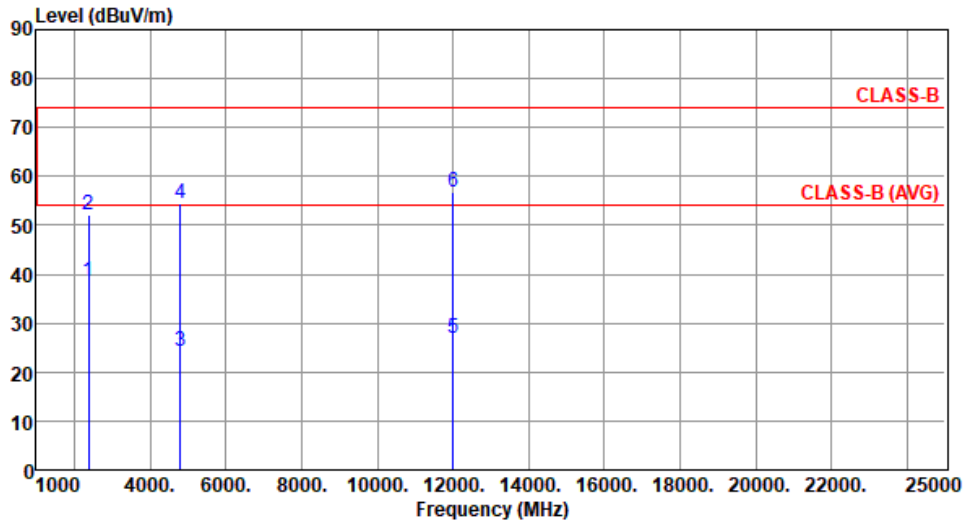

	Freq. MHz	Emission level dBuV/m	Limit dBuV/m	Margin dB	SA reading dBuV	Factor dB	Remark	ANT High cm	Turn Table deg
1	2390.00	38.39	54.00	-15.61	40.23	-1.84	Average	100	42
2	2390.00	52.09	74.00	-21.91	53.93	-1.84	Peak	100	42
3	4804.00	24.36	54.00	-29.64	19.35	5.01	Average	287	216
4	4804.00	54.46	74.00	-19.54	49.45	5.01	Peak	287	216
5	12010.00	26.74	54.00	-27.26	12.24	14.50	Average	100	50
6	12010.00	56.84	74.00	-17.16	42.34	14.50	Peak	100	50

Note 1: Emission Level (dBuV/m) = SA Reading (dBuV/m) + Factor* (dB)

*Factor includes antenna factor , cable loss and amplifier gain

Note 2: Margin (dB) = Emission level (dBuV/m) – Limit (dBuV/m).

Modulation	GFSK	Test Freq. (MHz)	2441
Polarization	Horizontal		

Test By :Roger Lu Temperature(°C):25 Humidity(%):61

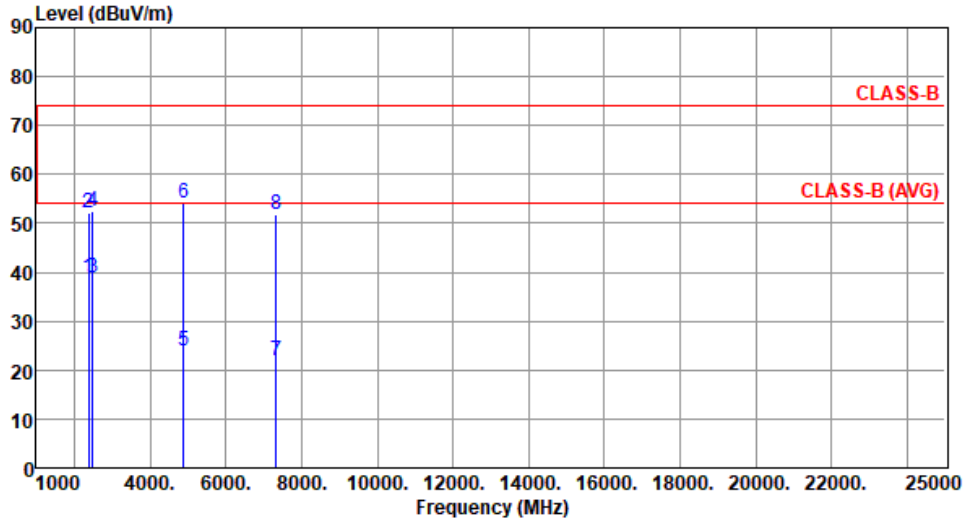

	Freq. MHz	Emission level dBuV/m	Limit dBuV/m	Margin dB	SA reading dBuV	Factor dB	Remark	ANT High cm	Turn Table deg
1	2390.00	38.74	54.00	-15.26	40.58	-1.84	Average	102	178
2	2390.00	52.20	74.00	-21.80	54.04	-1.84	Peak	102	178
3	2483.50	38.88	54.00	-15.12	40.68	-1.80	Average	102	178
4	2483.50	52.54	74.00	-21.46	54.34	-1.80	Peak	102	178
5	4882.00	24.04	54.00	-29.96	19.00	5.04	Average	205	359
6	4882.00	54.14	74.00	-19.86	49.10	5.04	Peak	205	359
7	7323.00	21.76	54.00	-32.24	11.46	10.30	Average	100	30
8	7323.00	51.86	74.00	-22.14	41.56	10.30	Peak	100	30

Note 1: Emission Level (dBuV/m) = SA Reading (dBuV/m) + Factor* (dB)

*Factor includes antenna factor , cable loss and amplifier gain

Note 2: Margin (dB) = Emission level (dBuV/m) – Limit (dBuV/m).

Modulation	GFSK	Test Freq. (MHz)	2441
Polarization	Vertical		

Test By :Roger Lu Temperature(°C):25 Humidity(%):61

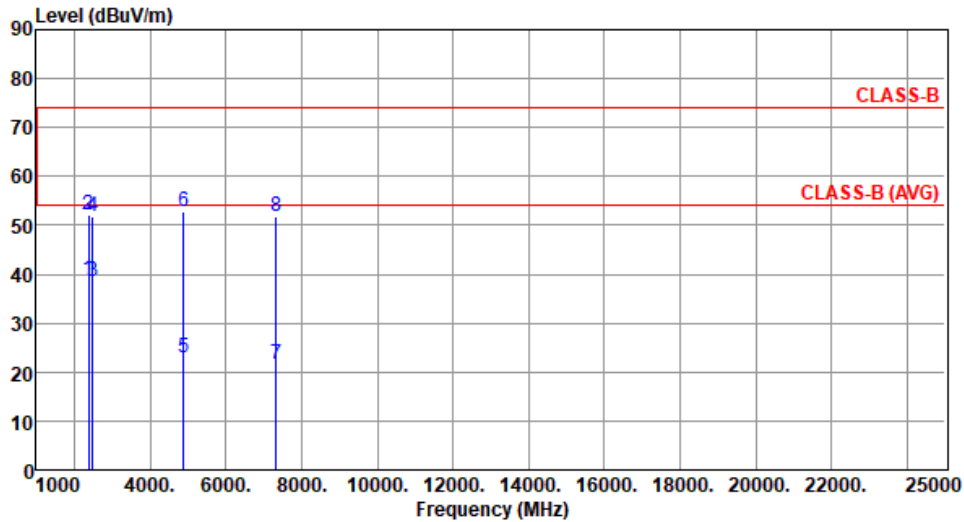

	Freq. MHz	Emission level dBuV/m	Limit dBuV/m	Margin dB	SA reading dBuV	Factor dB	Remark	ANT High cm	Turn Table deg
1	2390.00	38.71	54.00	-15.29	40.55	-1.84	Average	100	38
2	2390.00	52.01	74.00	-21.99	53.85	-1.84	Peak	100	38
3	2483.50	38.58	54.00	-15.42	40.38	-1.80	Average	100	38
4	2483.50	51.87	74.00	-22.13	53.67	-1.80	Peak	100	38
5	4882.00	22.81	54.00	-31.19	17.77	5.04	Average	292	122
6	4882.00	52.91	74.00	-21.09	47.87	5.04	Peak	292	122
7	7323.00	21.58	54.00	-32.42	11.28	10.30	Average	100	60
8	7323.00	51.68	74.00	-22.32	41.38	10.30	Peak	100	60

Note 1: Emission Level (dBuV/m) = SA Reading (dBuV/m) + Factor* (dB)

*Factor includes antenna factor , cable loss and amplifier gain

Note 2: Margin (dB) = Emission level (dBuV/m) – Limit (dBuV/m).

Modulation	GFSK	Test Freq. (MHz)	2480
Polarization	Horizontal		

Test By :Roger Lu Temperature(°C):25 Humidity(%):61

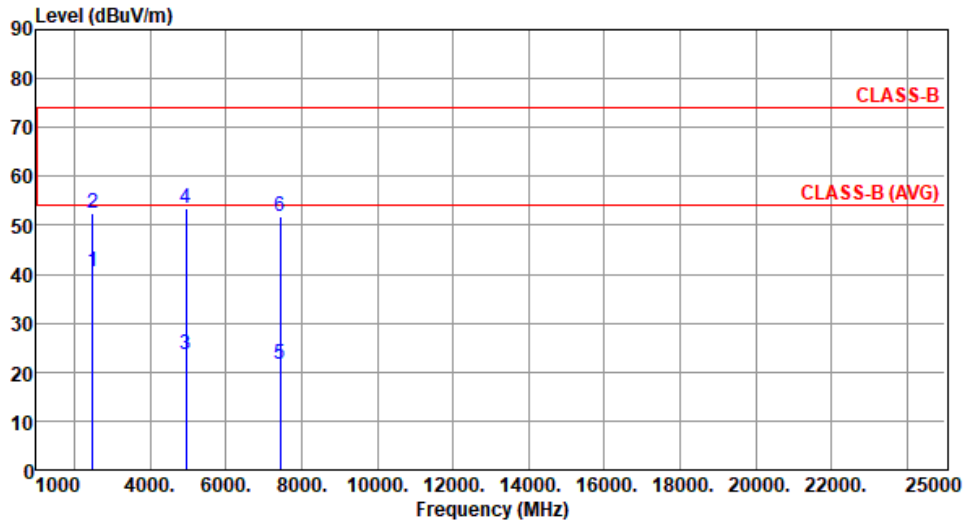

	Freq. MHz	Emission level dBuV/m	Limit dBuV/m	Margin dB	SA reading dBuV	Factor dB	Remark	ANT High cm	Turn Table deg
1	2483.50	40.52	54.00	-13.48	42.32	-1.80	Average	102	177
2	2483.50	52.58	74.00	-21.42	54.38	-1.80	Peak	102	177
3	4960.00	23.53	54.00	-30.47	18.23	5.30	Average	215	357
4	4960.00	53.63	74.00	-20.37	48.33	5.30	Peak	215	357
5	7440.00	21.59	54.00	-32.41	11.38	10.21	Average	100	30
6	7440.00	51.69	74.00	-22.31	41.48	10.21	Peak	100	30

Note 1: Emission Level (dBuV/m) = SA Reading (dBuV/m) + Factor* (dB)

*Factor includes antenna factor , cable loss and amplifier gain

Note 2: Margin (dB) = Emission level (dBuV/m) – Limit (dBuV/m).

Modulation	GFSK	Test Freq. (MHz)	2480
Polarization	Vertical		

Test By :Roger Lu Temperature(°C):25 Humidity(%):61

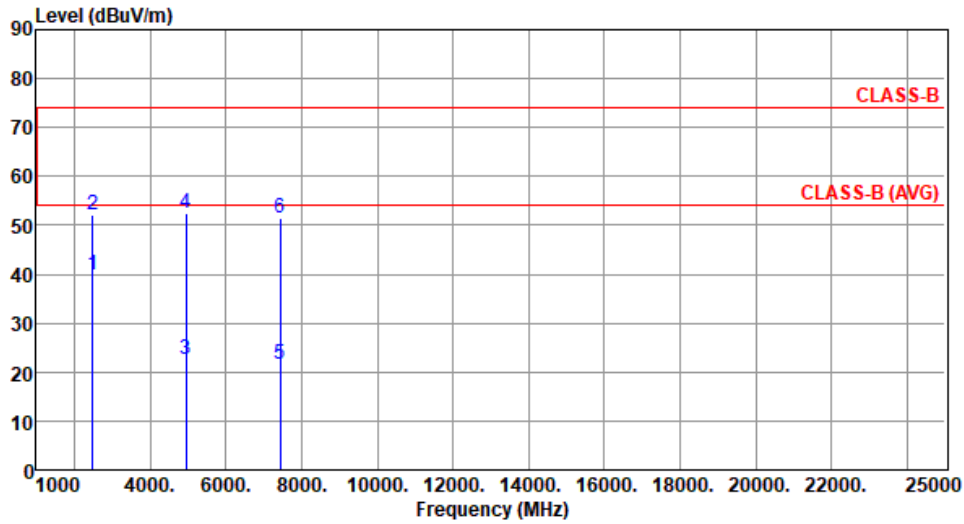

	Freq. MHz	Emission level dBuV/m	Limit dBuV/m	Margin dB	SA reading dBuV	Factor dB	Remark	ANT High cm	Turn Table deg
1	2483.50	39.79	54.00	-14.21	41.59	-1.80	Average	100	40
2	2483.50	52.09	74.00	-21.91	53.89	-1.80	Peak	100	40
3	4960.00	22.44	54.00	-31.56	17.14	5.30	Average	286	215
4	4960.00	52.54	74.00	-21.46	47.24	5.30	Peak	286	215
5	7440.00	21.49	54.00	-32.51	11.28	10.21	Average	100	70
6	7440.00	51.59	74.00	-22.41	41.38	10.21	Peak	100	70

Note 1: Emission Level (dBuV/m) = SA Reading (dBuV/m) + Factor* (dB)

*Factor includes antenna factor , cable loss and amplifier gain

Note 2: Margin (dB) = Emission level (dBuV/m) – Limit (dBuV/m).

3.2.6 Transmitter Radiated Unwanted Emissions (Above 1GHz) for 8DPSK

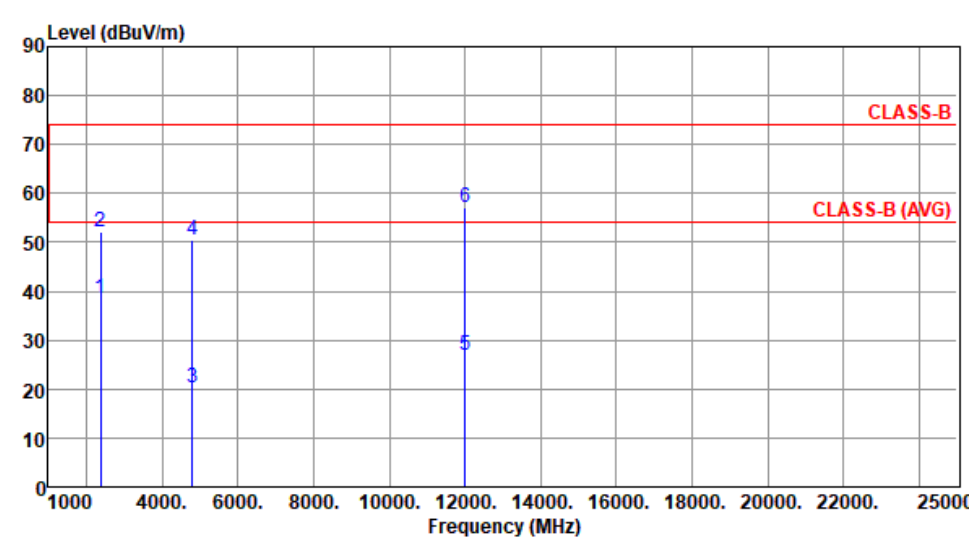
Modulation	8DPSK	Test Freq. (MHz)	2402						
Polarization	Horizontal								
Test By : Roger Lu Temperature(°C):25 Humidity(%):61									
 <p>The graph plots Level (dBuV/m) on the y-axis (0 to 90) against Frequency (MHz) on the x-axis (1000 to 25000). Two horizontal red lines represent limits: CLASS-B at approximately 74 dBuV/m and CLASS-B (AVG) at approximately 54 dBuV/m. Six data points are shown as vertical blue lines with numbers 1-6 at their tops. Point 1 is at ~2390 MHz (level ~38.66), point 2 at ~2390 MHz (level ~52.14), point 3 at ~4804 MHz (level ~20.25), point 4 at ~4804 MHz (level ~50.35), point 5 at ~12010 MHz (level ~26.87), and point 6 at ~12010 MHz (level ~56.97).</p>									
	Freq.	Emission level	Limit	Margin	SA reading	Factor	Remark	ANT High	Turn Table
	MHz	dBuV/m	dBuV/m	dB	dBuV	dB		cm	deg
1	2390.00	38.66	54.00	-15.34	40.50	-1.84	Average	101	181
2	2390.00	52.14	74.00	-21.86	53.98	-1.84	Peak	101	181
3	4804.00	20.25	54.00	-33.75	15.24	5.01	Average	199	357
4	4804.00	50.35	74.00	-23.65	45.34	5.01	Peak	199	357
5	12010.00	26.87	54.00	-27.13	12.37	14.50	Average	100	20
6	12010.00	56.97	74.00	-17.03	42.47	14.50	Peak	100	20

Note 1: Emission Level (dBuV/m) = SA Reading (dBuV/m) + Factor* (dB)
*Factor includes antenna factor , cable loss and amplifier gain
Note 2: Margin (dB) = Emission level (dBuV/m) – Limit (dBuV/m).

Modulation	8DPSK	Test Freq. (MHz)	2402
Polarization	Vertical		

Test By :Roger Lu Temperature(°C):25 Humidity(%):61

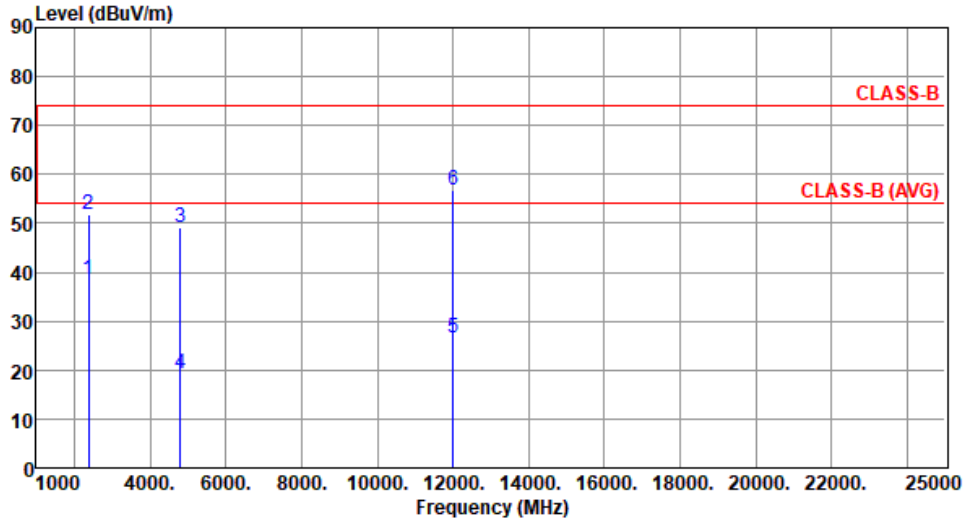

	Freq. MHz	Emission level dBuV/m	Limit dBuV/m	Margin dB	SA reading dBuV	Factor dB	Remark	ANT High cm	Turn Table deg
1	2390.00	38.39	54.00	-15.61	40.23	-1.84	Average	100	35
2	2390.00	51.79	74.00	-22.21	53.63	-1.84	Peak	100	35
3	4804.00	49.26	54.00	-4.74	44.25	5.01	Average	282	214
4	4804.00	19.16	54.00	-34.84	14.15	5.01	Average	282	214
5	12010.00	26.58	54.00	-27.42	12.08	14.50	Average	100	50
6	12010.00	56.68	74.00	-17.32	42.18	14.50	Peak	100	50

Note 1: Emission Level (dBuV/m) = SA Reading (dBuV/m) + Factor* (dB)

*Factor includes antenna factor , cable loss and amplifier gain

Note 2: Margin (dB) = Emission level (dBuV/m) – Limit (dBuV/m).

Modulation	8DPSK	Test Freq. (MHz)	2441
Polarization	Horizontal		

Test By :Roger Lu Temperature(°C):25 Humidity(%):61

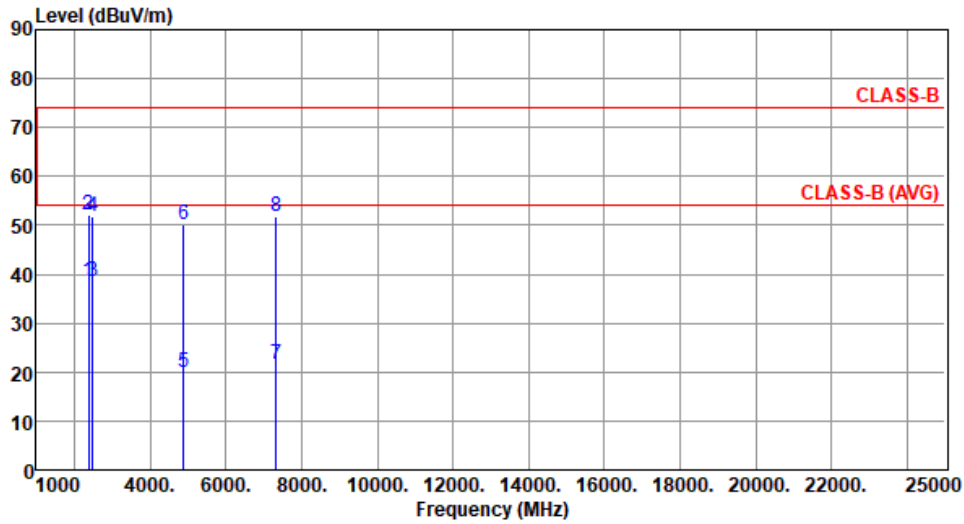

	Freq. MHz	Emission level dBuV/m	Limit dBuV/m	Margin dB	SA reading dBuV	Factor dB	Remark	ANT High cm	Turn Table deg
1	2390.00	38.63	54.00	-15.37	40.47	-1.84	Average	100	179
2	2390.00	52.02	74.00	-21.98	53.86	-1.84	Peak	100	179
3	2483.50	38.52	54.00	-15.48	40.32	-1.80	Average	100	179
4	2483.50	51.97	74.00	-22.03	53.77	-1.80	Peak	100	179
5	4882.00	19.89	54.00	-34.11	14.85	5.04	Average	207	358
6	4882.00	49.99	74.00	-24.01	44.95	5.04	Peak	207	358
7	7323.00	21.66	54.00	-32.34	11.36	10.30	Average	100	40
8	7323.00	51.76	74.00	-22.24	41.46	10.30	Peak	100	40

Note 1: Emission Level (dBuV/m) = SA Reading (dBuV/m) + Factor* (dB)

*Factor includes antenna factor , cable loss and amplifier gain

Note 2: Margin (dB) = Emission level (dBuV/m) – Limit (dBuV/m).

Modulation	8DPSK	Test Freq. (MHz)	2441
Polarization	Vertical		

Test By :Roger Lu Temperature(°C):25 Humidity(%):61

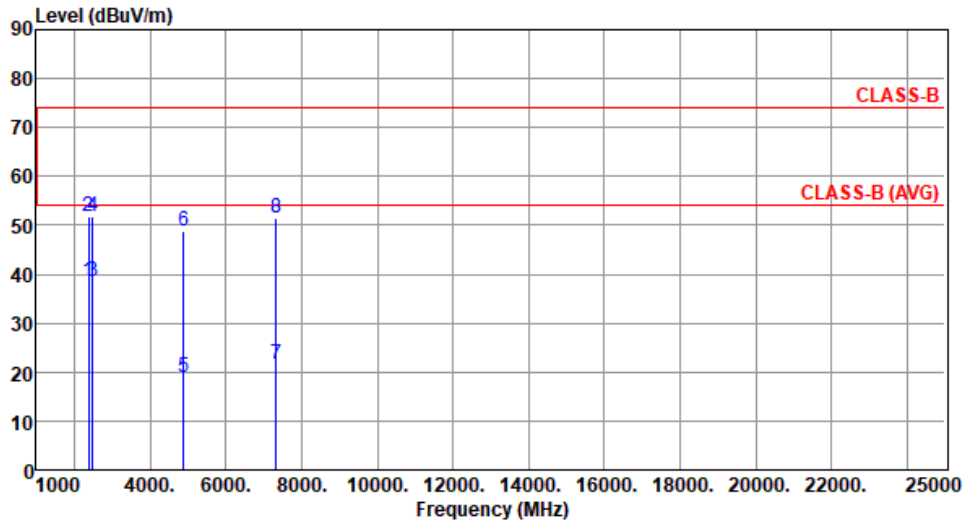

	Freq. MHz	Emission level dBuV/m	Limit dBuV/m	Margin dB	SA reading dBuV	Factor dB	Remark	ANT High cm	Turn Table deg
1	2390.00	38.46	54.00	-15.54	40.30	-1.84	Average	100	40
2	2390.00	51.82	74.00	-22.18	53.66	-1.84	Peak	100	40
3	2483.50	38.41	54.00	-15.59	40.21	-1.80	Average	100	40
4	2483.50	51.84	74.00	-22.16	53.64	-1.80	Peak	100	40
5	4882.00	18.82	54.00	-35.18	13.78	5.04	Average	288	213
6	4882.00	48.92	74.00	-25.08	43.88	5.04	Peak	288	213
7	7323.00	21.45	54.00	-32.55	11.15	10.30	Average	100	70
8	7323.00	51.55	74.00	-22.45	41.25	10.30	Peak	100	70

Note 1: Emission Level (dBuV/m) = SA Reading (dBuV/m) + Factor* (dB)

*Factor includes antenna factor , cable loss and amplifier gain

Note 2: Margin (dB) = Emission level (dBuV/m) – Limit (dBuV/m).

Modulation	8DPSK	Test Freq. (MHz)	2480
Polarization	Horizontal		

Test By :Roger Lu Temperature(°C):25 Humidity(%):61

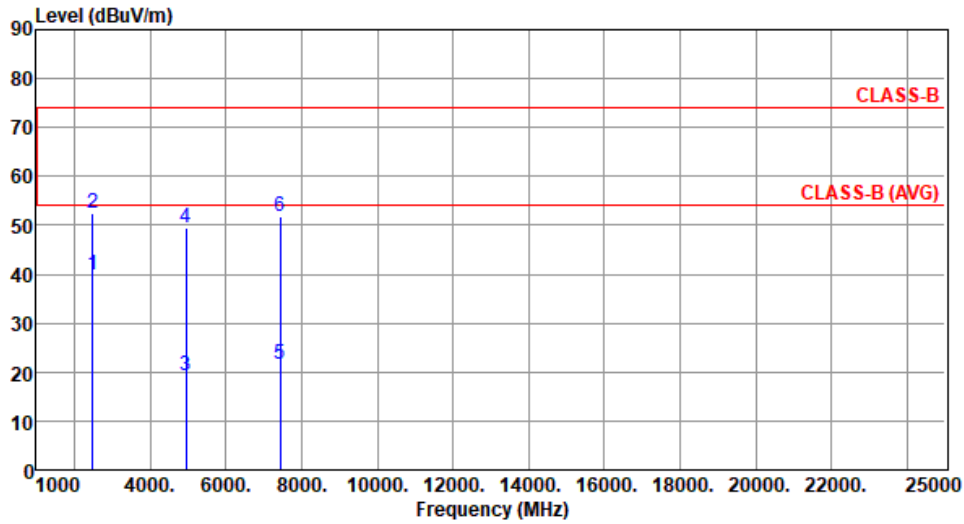

	Freq. MHz	Emission level dBuV/m	Limit dBuV/m	Margin dB	SA reading dBuV	Factor dB	Remark	ANT High cm	Turn Table deg
1	2483.50	39.97	54.00	-14.03	41.77	-1.80	Average	100	178
2	2483.50	52.46	74.00	-21.54	54.26	-1.80	Peak	100	178
3	4960.00	19.30	54.00	-34.70	14.00	5.30	Average	206	355
4	4960.00	49.40	74.00	-24.60	44.10	5.30	Peak	206	355
5	7440.00	21.58	54.00	-32.42	11.37	10.21	Average	100	50
6	7440.00	51.68	74.00	-22.32	41.47	10.21	Peak	100	50

Note 1: Emission Level (dBuV/m) = SA Reading (dBuV/m) + Factor* (dB)

*Factor includes antenna factor , cable loss and amplifier gain

Note 2: Margin (dB) = Emission level (dBuV/m) – Limit (dBuV/m).

Modulation	8DPSK	Test Freq. (MHz)	2480
Polarization	Vertical		

Test By :Roger Lu Temperature(°C):25 Humidity(%):61

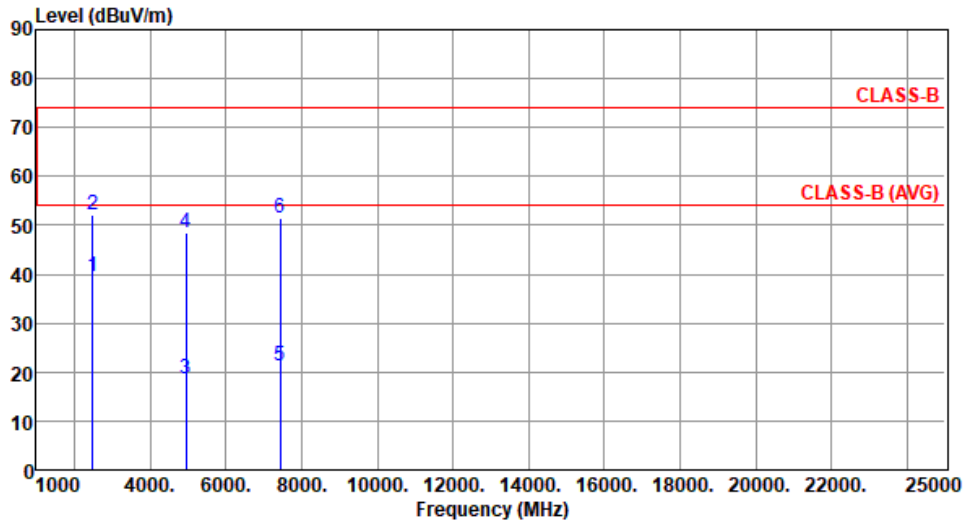

	Freq. MHz	Emission level dBuV/m	Limit dBuV/m	Margin dB	SA reading dBuV	Factor dB	Remark	ANT High cm	Turn Table deg
1	2483.50	39.45	54.00	-14.55	41.25	-1.80	Average	100	41
2	2483.50	51.98	74.00	-22.02	53.78	-1.80	Peak	100	41
3	4960.00	18.44	54.00	-35.56	13.14	5.30	Average	289	214
4	4960.00	48.54	74.00	-25.46	43.24	5.30	Peak	289	214
5	7440.00	21.36	54.00	-32.64	11.15	10.21	Average	100	40
6	7440.00	51.46	74.00	-22.54	41.25	10.21	Peak	100	40

Note 1: Emission Level (dBuV/m) = SA Reading (dBuV/m) + Factor* (dB)

*Factor includes antenna factor , cable loss and amplifier gain

Note 2: Margin (dB) = Emission level (dBuV/m) – Limit (dBuV/m).

3.3 Unwanted Emissions into Non-Restricted Frequency Bands

3.3.1 Limit of Unwanted Emissions into Non-Restricted Frequency Bands

Peak power in any 100 kHz bandwidth outside of the authorized frequency band shall be attenuated by at least 20 dB relative to the maximum in-band peak PSD level in 100 kHz.

3.3.2 Test Procedures

Reference level measurement

1. Set RBW=100kHz, VBW = 300kHz , Detector = Peak, Sweep time = Auto
2. Trace = max hold , Allow Trace to fully stabilize
3. Use the peak marker function to determine the maximum PSD level

Emission level measurement

1. Set RBW=100kHz, VBW = 300kHz , Detector = Peak, Sweep time = Auto
2. Trace = max hold , Allow Trace to fully stabilize
3. Scan Frequency range is up to 25GHz
4. Use the peak marker function to determine the maximum amplitude level

3.3.3 Test Setup

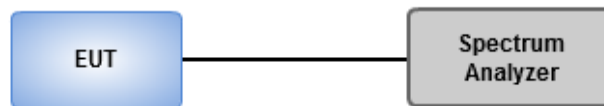

3.3.4 Unwanted Emissions into Non-Restricted Frequency Bands

Ambient Condition	22°C / 66%	Tested By	Brad Wu
-------------------	------------	-----------	---------

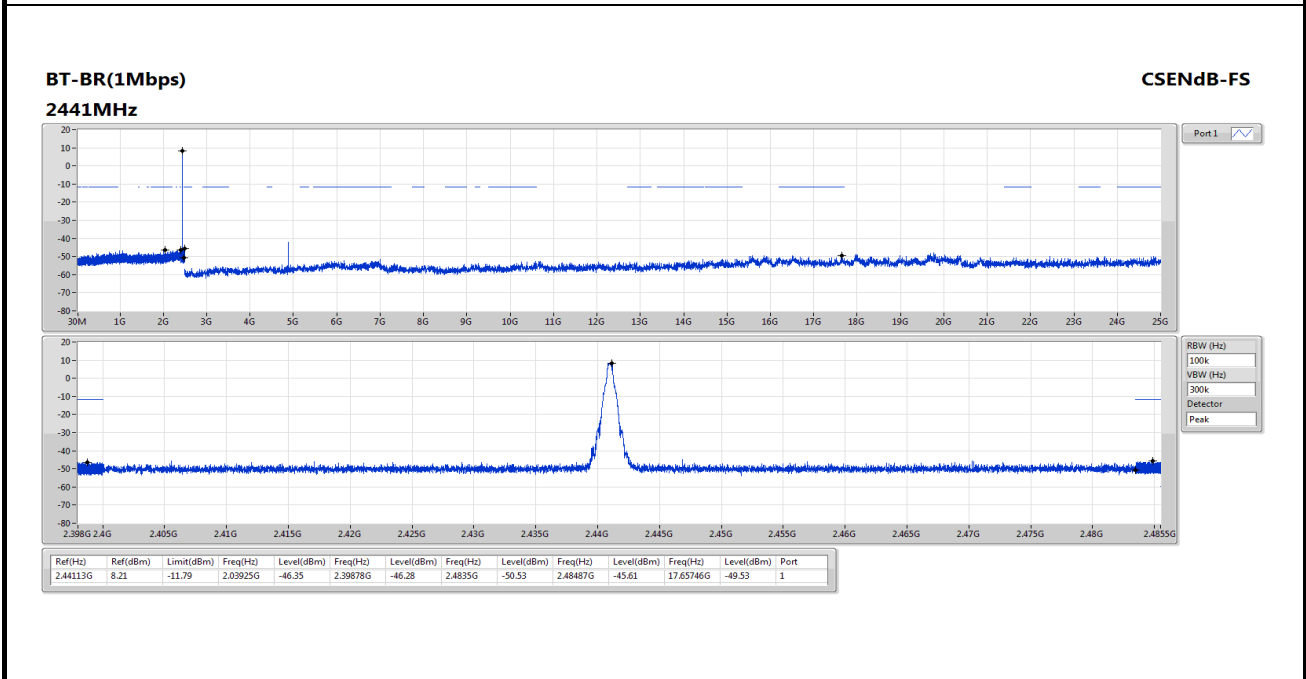
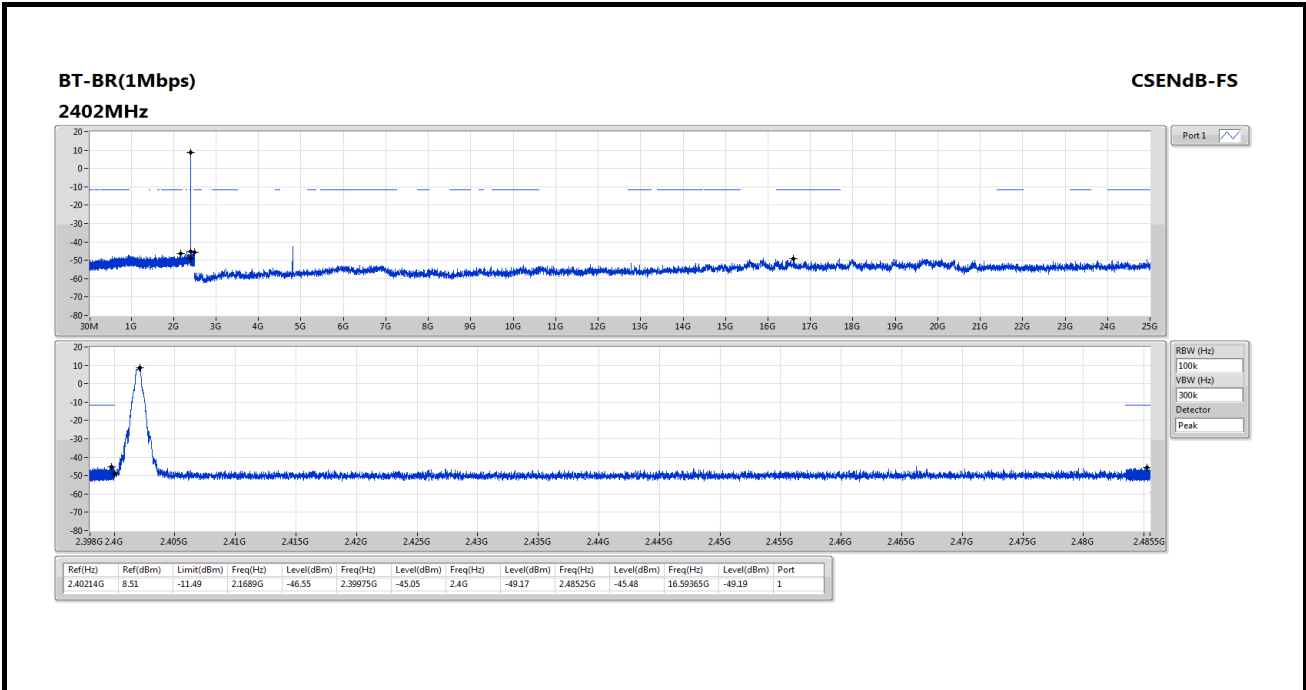

BT-BR(1Mbps)

CSENdB-FS

2480MHz

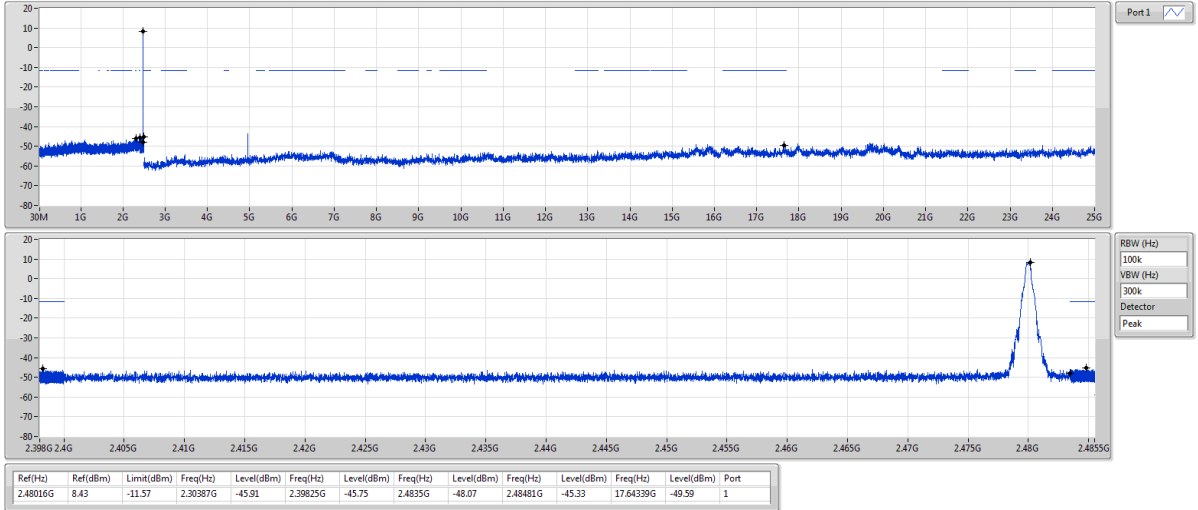

BT-EDR(2Mbps)

CSENdB-FS

2402MHz

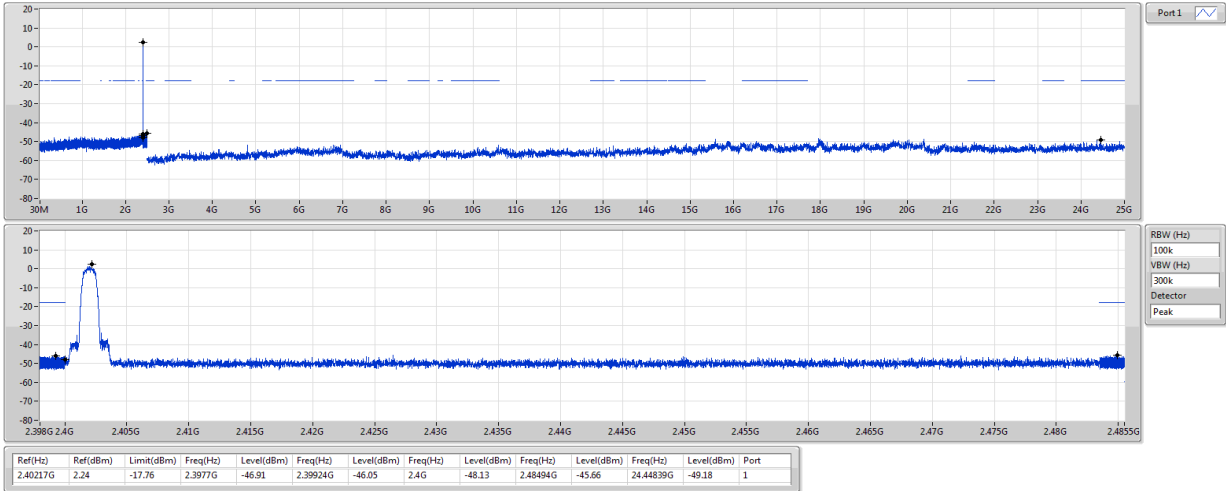

BT-EDR(2Mbps)

CSEndB-FS

2441MHz

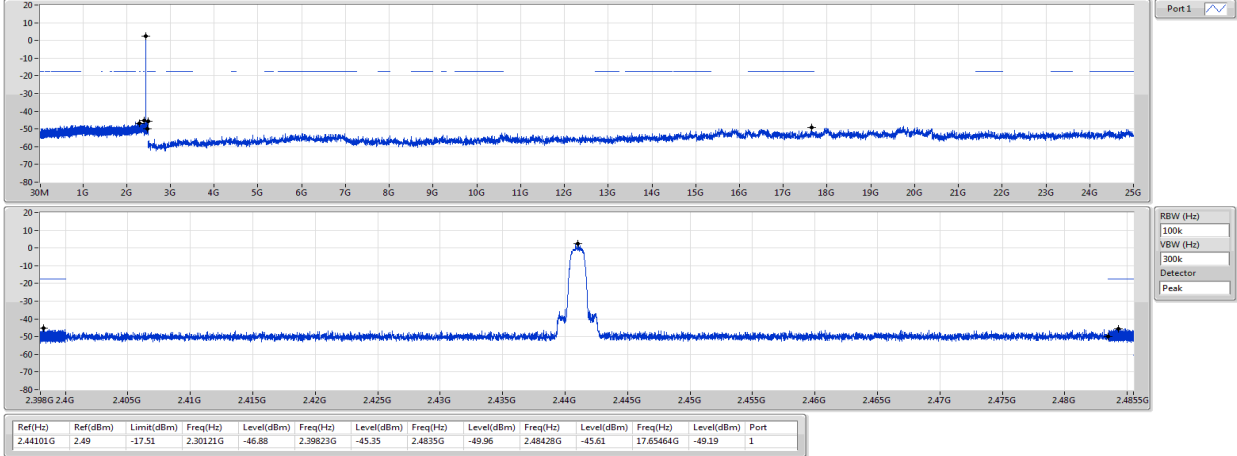

BT-EDR(2Mbps)

CSEndB-FS

2480MHz

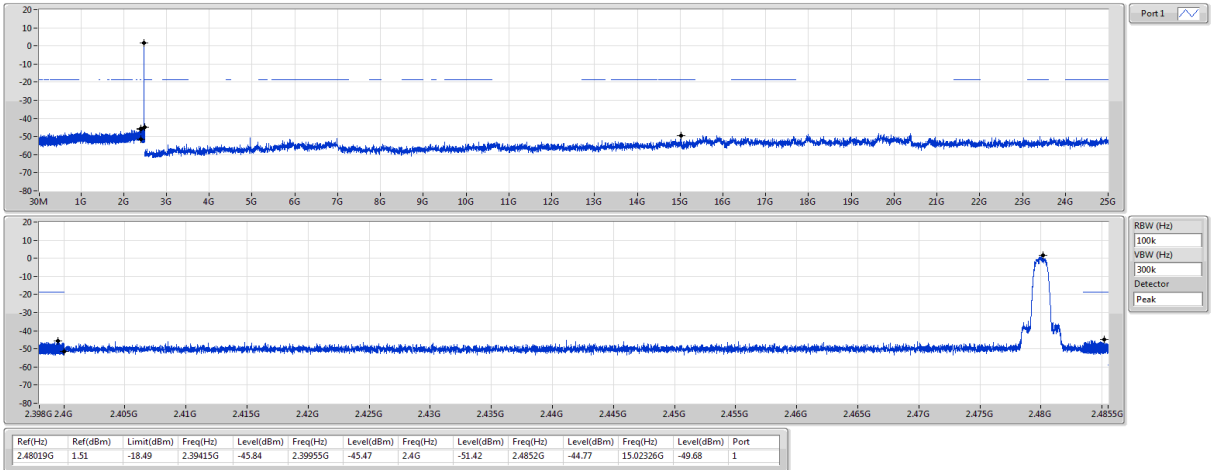

BT-EDR(3Mbps)

CSENdB-FS

2402MHz

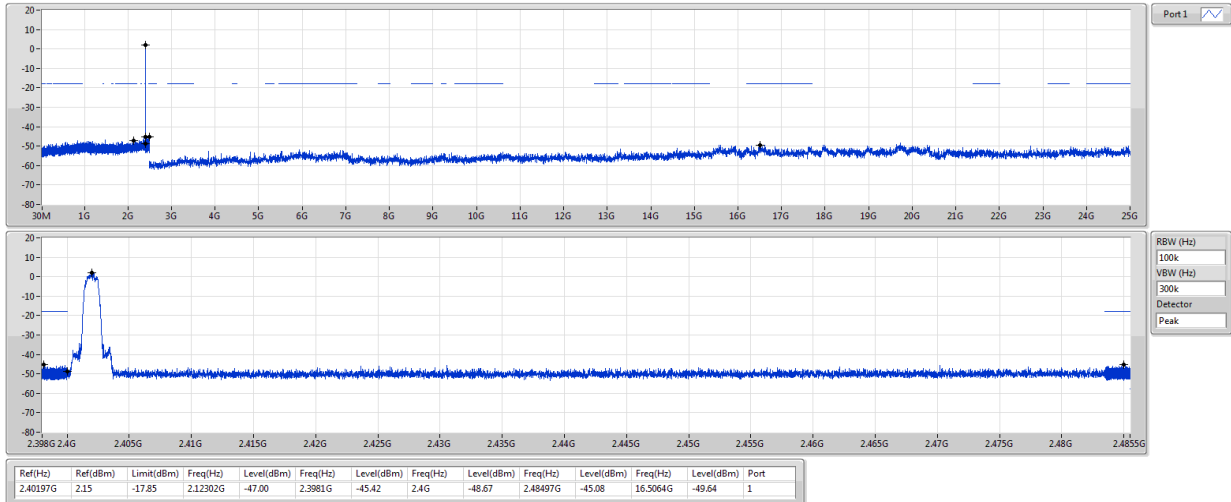

BT-EDR(3Mbps)

CSENdB-FS

2441MHz

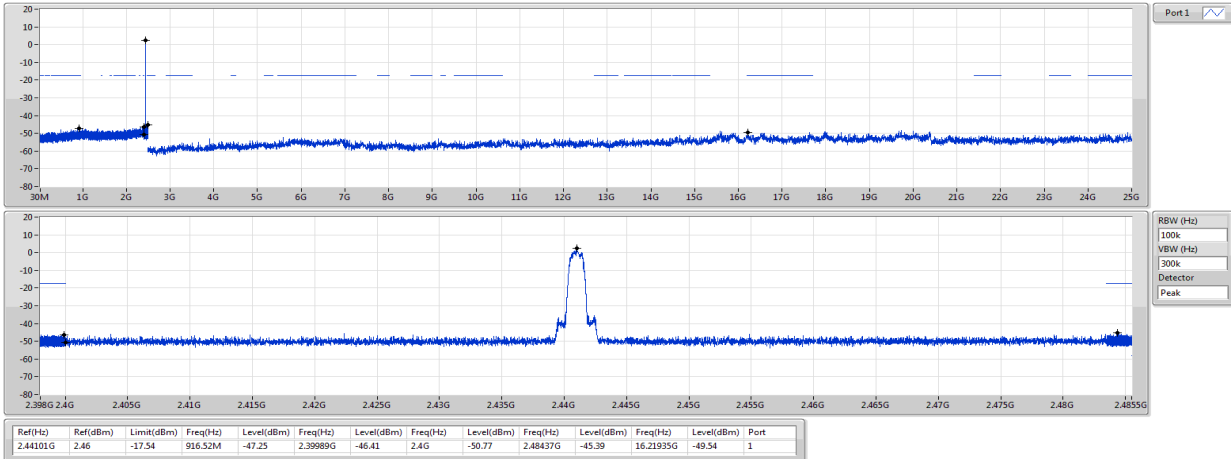

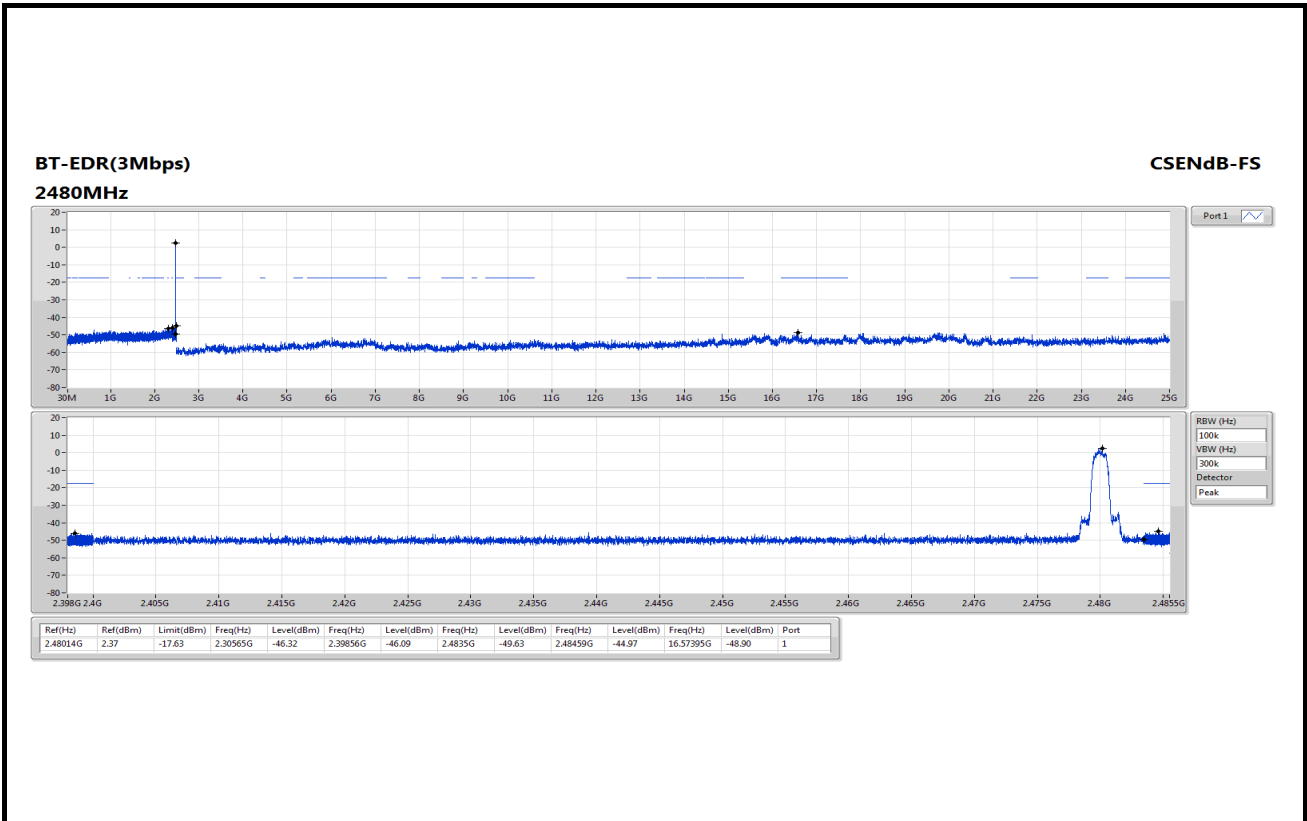

BT-BR(1Mbps)

2402MHz

Hopping Ch Bandedge (Non-restricted Band)

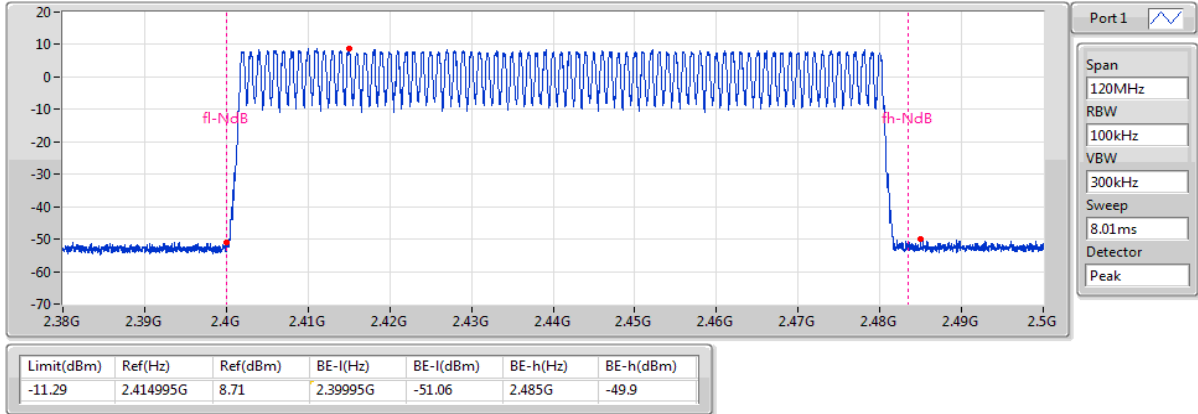

BT-EDR(2Mbps)

2402MHz

Hopping Ch Bandedge (Non-restricted Band)

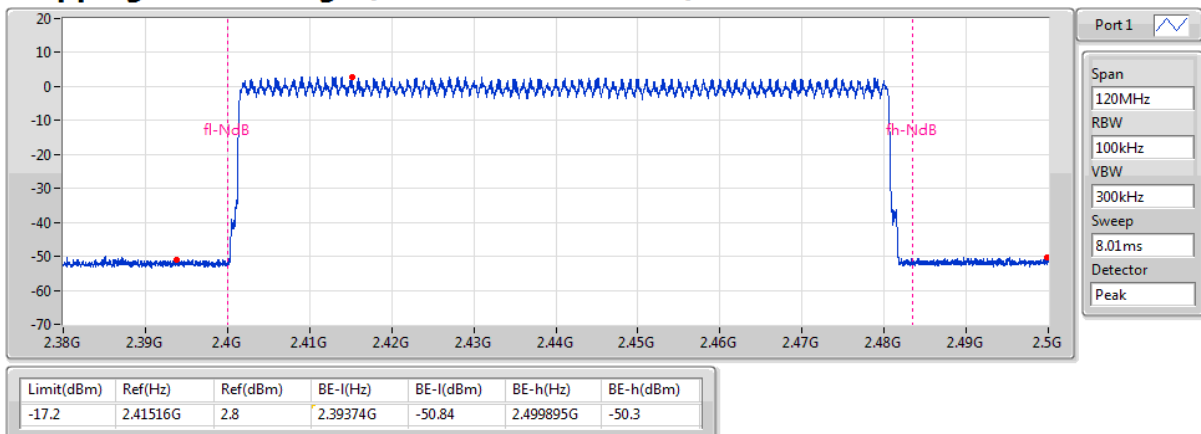

BT-EDR(3Mbps)

2402MHz

Hopping Ch Bandedge (Non-restricted Band)

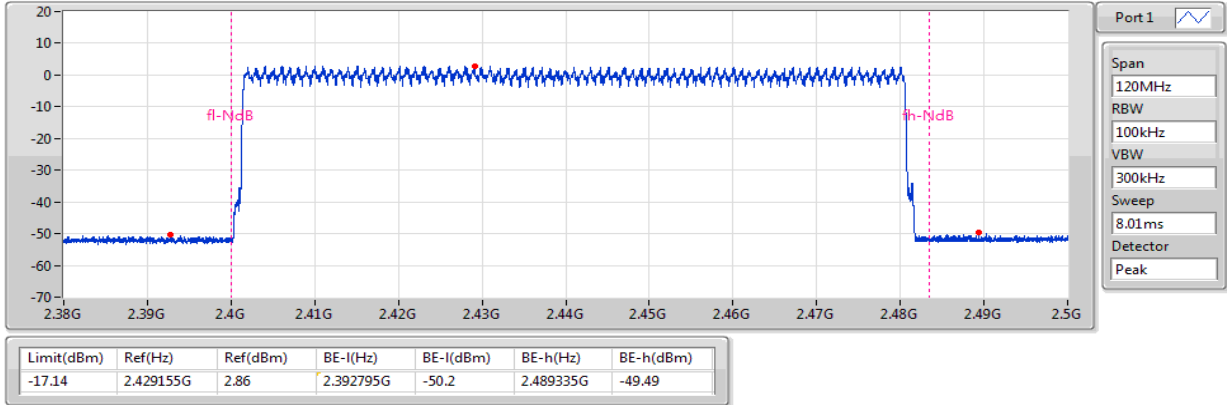

3.4 Conducted Output Power

3.4.1 Limit of Conducted Output Power

- 1 Watt
For frequency hopping systems operating in the 2400–2483.5 MHz band employing at least 75 non overlapping hopping channels, and all frequency hopping systems in the 5725–5850 MHz band.
- 0.125 Watt
For all other frequency hopping systems in the 2400–2483.5 MHz band.
- 0.125 Watt
For Frequency hopping systems operating in the 2400–2483.5 MHz band have hopping channel carrier frequencies that are separated by two-thirds of the 20 dB bandwidth of the hopping channel.

3.4.2 Test Procedures

1. A wideband power meter is used for power measurement. Bandwidth of power sensor and meter is 50MHz
2. If duty cycle of test signal is not 100 %, trigger and gating function of power meter will be enabled to capture transmission burst for measuring output power

3.4.3 Test Setup

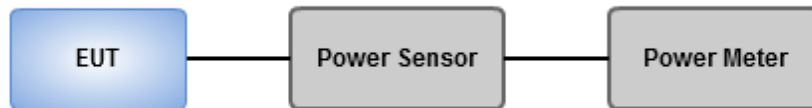

3.4.4 Test Result of Conducted Output Power

Ambient Condition	22°C / 66%	Tested By	Brad Wu
--------------------------	------------	------------------	---------

Summary of Peak Conducted Output Power

Mode	Power (dBm)	Power (W)
2.4-2.4835GHz	-	-
BT-BR(1Mbps)	9.29	0.00849
BT-EDR(2Mbps)	6.34	0.00431
BT-EDR(3Mbps)	6.56	0.00453

Result

Mode	Result	Gain (dBi)	Power (dBm)	Power Limit (dBm)
BT-BR(1Mbps)	-	-	-	-
2402MHz	Pass	3.00	9.18	21.00
2441MHz	Pass	3.00	9.29	21.00
2480MHz	Pass	3.00	9.17	21.00
BT-EDR(2Mbps)	-	-	-	-
2402MHz	Pass	3.00	6.34	21.00
2441MHz	Pass	3.00	6.12	21.00
2480MHz	Pass	3.00	6.07	21.00
BT-EDR(3Mbps)	-	-	-	-
2402MHz	Pass	3.00	6.56	21.00
2441MHz	Pass	3.00	6.42	21.00
2480MHz	Pass	3.00	6.33	21.00

DG = Directional Gain; Port X = Port X output power

Summary of Conducted (Average) Output Power

Mode	Power (dBm)	Power (W)
2.4-2.4835GHz	-	-
BT-BR(1Mbps)	9.20	0.00832
BT-EDR(2Mbps)	3.78	0.00239
BT-EDR(3Mbps)	3.79	0.00239

Result

Mode	Result	Gain (dBi)	Power (dBm)	Power Limit (dBm)
BT-BR(1Mbps)	-	-	-	-
2402MHz	Pass	3.00	9.10	-
2441MHz	Pass	3.00	9.20	-
2480MHz	Pass	3.00	9.08	-
BT-EDR(2Mbps)	-	-	-	-
2402MHz	Pass	3.00	3.78	-
2441MHz	Pass	3.00	3.60	-
2480MHz	Pass	3.00	3.57	-
BT-EDR(3Mbps)	-	-	-	-
2402MHz	Pass	3.00	3.79	-
2441MHz	Pass	3.00	3.61	-
2480MHz	Pass	3.00	3.58	-

Note: Average power is for reference only.

3.5 Number of Hopping Frequency

3.5.1 Limit of Number of Hopping Frequency

Frequency hopping systems in the 2400–2483.5 MHz band shall use at least 15 channels.

3.5.2 Test Procedures

1. Set RBW = 100kHz, VBW = 300kHz, Sweep time = Auto, Detector = Peak Trace max hold.
2. Allow trace to stabilize.

3.5.3 Test Setup

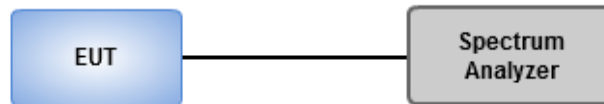

3.5.4 Test Result of Number of Hopping Frequency

Ambient Condition	22°C / 66%	Tested By	Brad Wu
--------------------------	------------	------------------	---------

Summary

Mode	Max-Hop No
2.4-2.4835GHz	-
BT-BR(1Mbps)	79
BT-EDR(2Mbps)	79
BT-EDR(3Mbps)	79

Result

Mode	Result	Hopping No	Limit
BT-BR(1Mbps)	-	-	-
2402MHz	Pass	79	15
BT-EDR(2Mbps)	-	-	-
2402MHz	Pass	79	15
BT-EDR(3Mbps)	-	-	-
2402MHz	Pass	79	15

BT-BR(1Mbps)
2402MHz

Hopping-FS

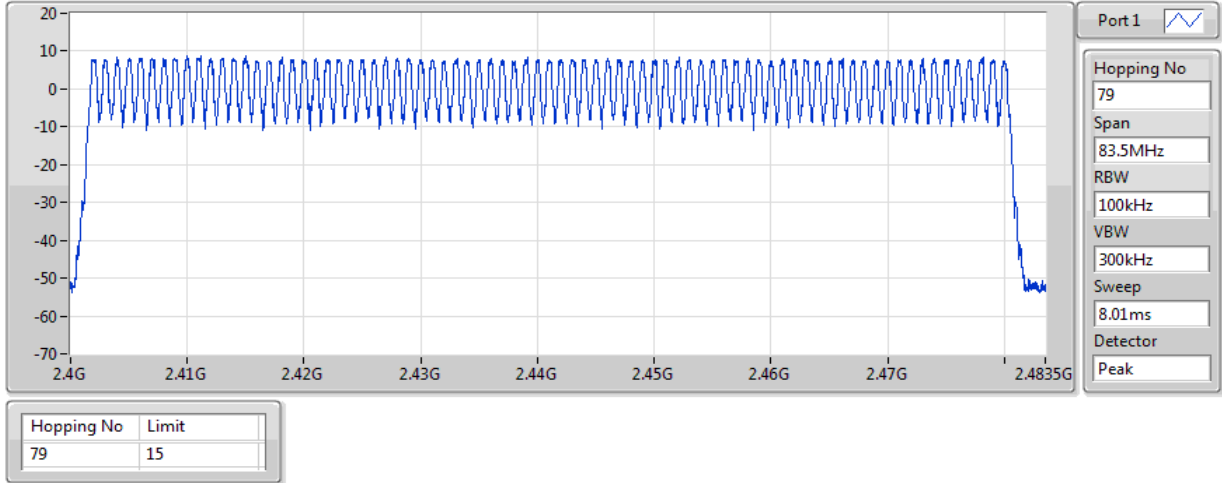

BT-EDR(2Mbps)
2402MHz

Hopping-FS

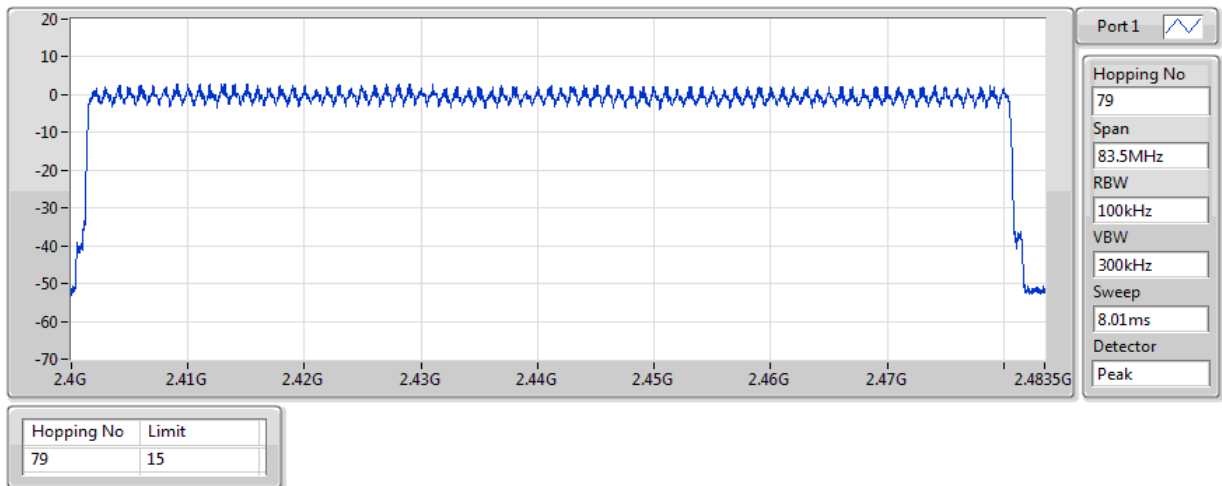

**BT-EDR(3Mbps)
2402MHz**

Hopping-FS

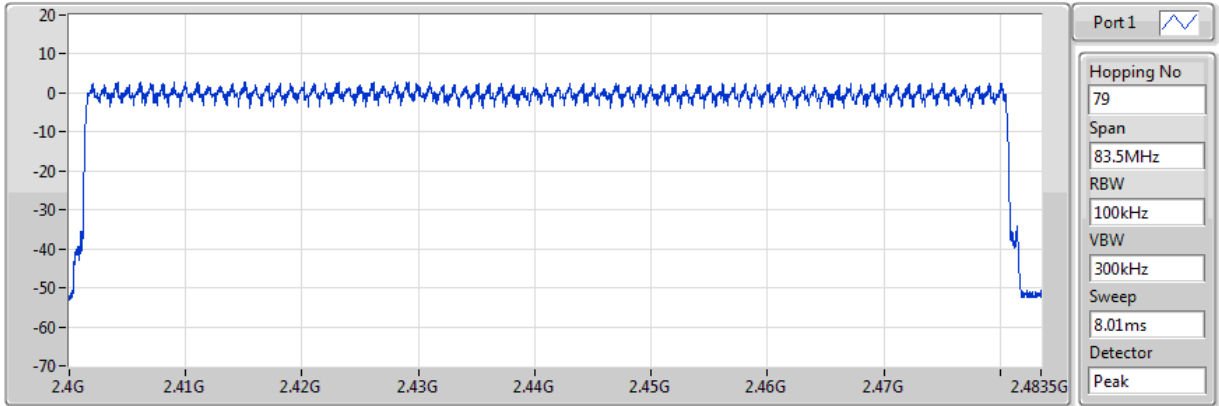

Hopping No	Limit
79	15

3.6 20dB and Occupied Bandwidth

3.6.1 Test Procedures

20dB Bandwidth

1. Set RBW=20kHz, VBW=100kHz, Sweep time = Auto, Detector=Peak, Trace max hold
2. Allow trace to stabilize
3. Measure the maximum width of the emission that is constrained by the frequencies associated with the two outermost amplitude points (upper and lower) that are attenuated by 20 dB relative to the maximum level measured in the fundamental emission.

Occupied Bandwidth

1. Set RBW=20kHz, VBW=100kHz, Sweep time = Auto, Detector=Sample, Trace max hold
2. Allow trace to stabilize
3. Use Occupied bandwidth function of spectrum analyzer to measuring 99% occupied bandwidth

3.6.2 Test Setup

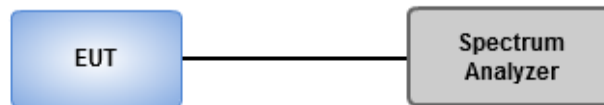

3.6.3 Test result of 20dB and Occupied Bandwidth

Ambient Condition	22°C / 66%	Tested By	Brad Wu
--------------------------	------------	------------------	---------

Summary

Mode	Max-N dB (Hz)	Max-OBW (Hz)	ITU-Code	Min-N dB (Hz)	Min-OBW (Hz)
2.4-2.4835GHz	-	-	-	-	-
BT-BR(1Mbps)	938.406k	897.25k	897KF1D	927.536k	893.632k
BT-EDR(2Mbps)	1.348M	1.219M	1M22G1D	1.341M	1.216M
BT-EDR(3Mbps)	1.362M	1.223M	1M22G1D	1.337M	1.212M

Max-N dB = Maximum 20dB down bandwidth; Max-OBW = Maximum 99% occupied bandwidth;
Min-N dB = Minimum 20dB down bandwidth; Min-OBW = Minimum 99% occupied bandwidth

Result

Mode	Result	Limit (Hz)	Port 1-N dB (Hz)	Port 1-OBW (Hz)
BT-BR(1Mbps)	-	-	-	-
2402MHz	Pass	Inf	938.406k	897.25k
2441MHz	Pass	Inf	934.783k	897.25k
2480MHz	Pass	Inf	927.536k	893.632k
BT-EDR(2Mbps)	-	-	-	-
2402MHz	Pass	Inf	1.341M	1.216M
2441MHz	Pass	Inf	1.344M	1.219M
2480MHz	Pass	Inf	1.348M	1.216M
BT-EDR(3Mbps)	-	-	-	-
2402MHz	Pass	Inf	1.337M	1.212M
2441MHz	Pass	Inf	1.344M	1.219M
2480MHz	Pass	Inf	1.362M	1.223M

Port X-N dB = Port X 20dB down bandwidth;
Port X-OBW = Port X 99% occupied bandwidth

BT-BR(1Mbps)

EBW-FS

2402MHz

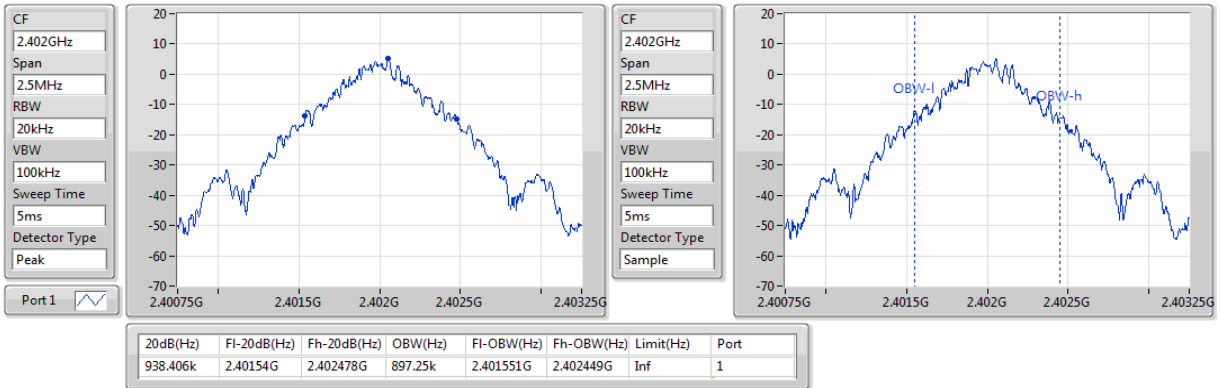

BT-BR(1Mbps)

EBW-FS

2441MHz

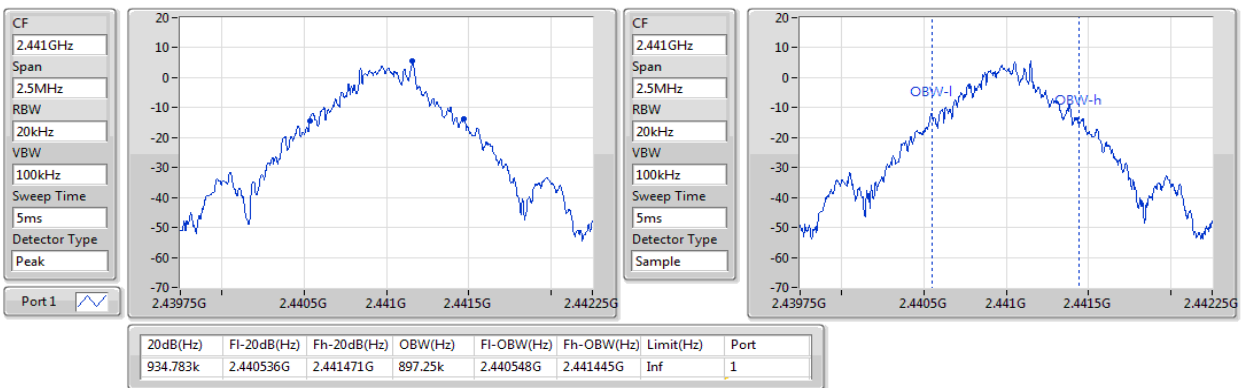

BT-BR(1Mbps)

EBW-FS

2480MHz

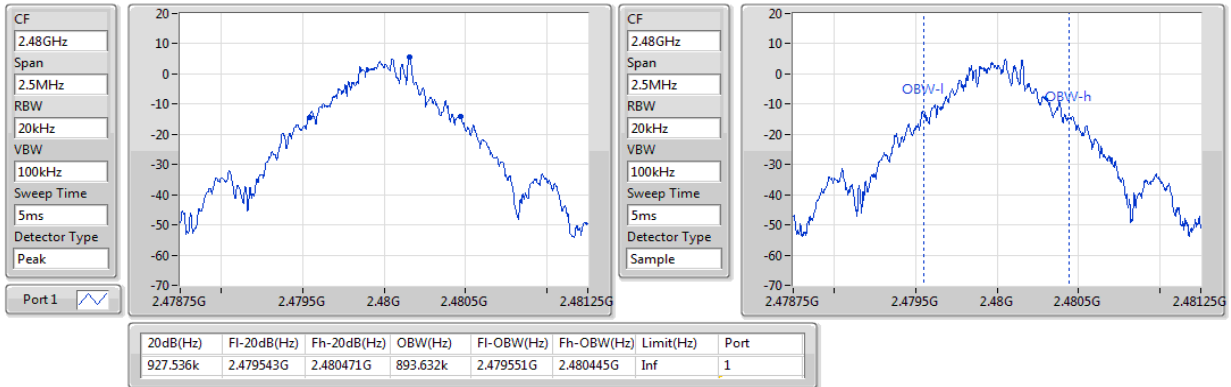

BT-EDR(2Mbps)

EBW-FS

2402MHz

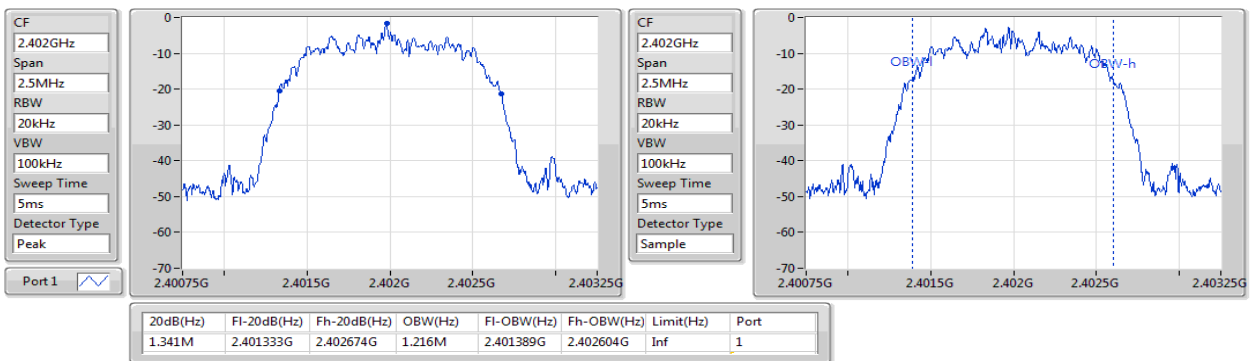

BT-EDR(2Mbps)

EBW-FS

2441MHz

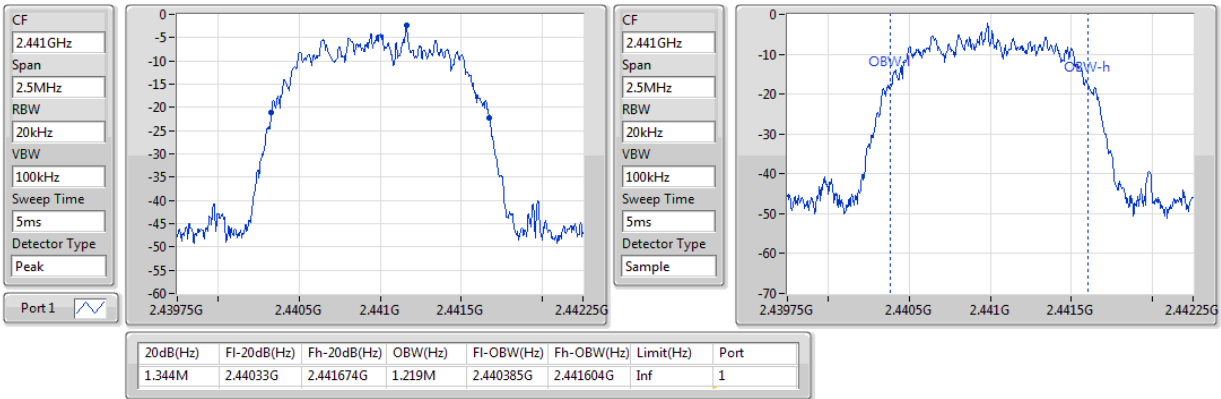

BT-EDR(2Mbps)

EBW-FS

2480MHz

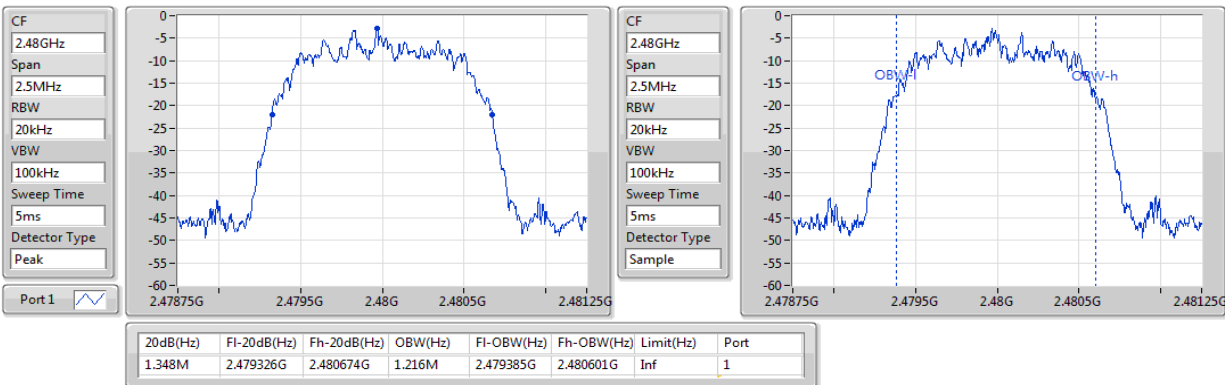

BT-EDR(3Mbps)

EBW-FS

2402MHz

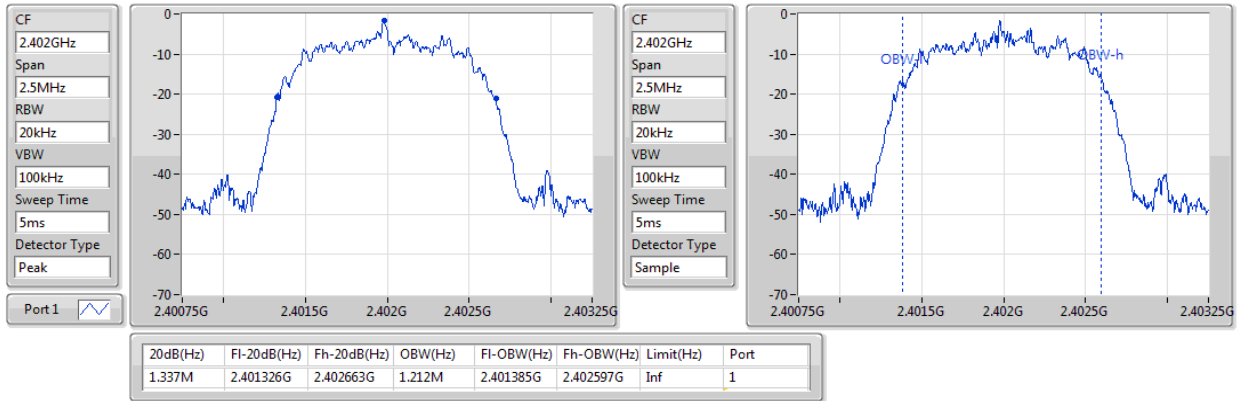

BT-EDR(3Mbps)

EBW-FS

2441MHz

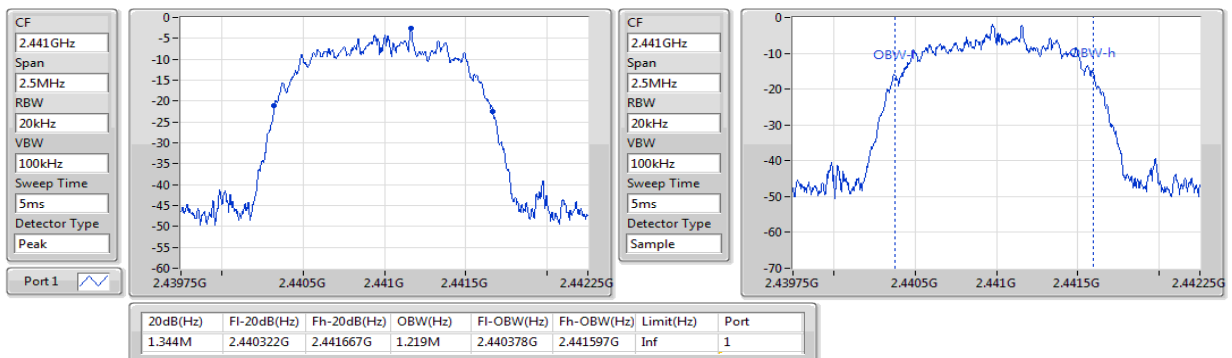

BT-EDR(3Mbps)

EBW-FS

2480MHz

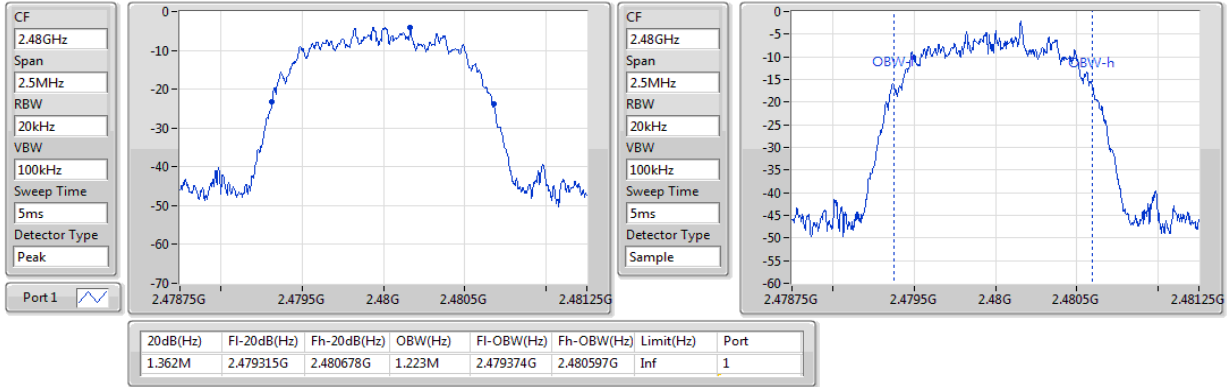

3.7 Channel Separation

3.7.1 Limit of Channel Separation

- Frequency hopping systems shall have hopping channel carrier frequencies separated by a minimum of 25 kHz or the 20 dB bandwidth of the hopping channel, whichever is greater.
- Frequency hopping systems operating in the 2400–2483.5 MHz band may have hopping channel carrier frequencies that are separated by 25 kHz or two-thirds of the 20 dB bandwidth of the hopping channel, whichever is greater.

3.7.2 Test Procedures

1. Set RBW=30kHz, VBW=100kHz, Sweep time = Auto, Detector=Peak Trace max hold
2. Allow trace to stabilize
3. Use the marker-delta function to determine the separation between the peaks of the adjacent channels. The EUT shall show compliance with the appropriate regulatory limit

3.7.3 Test Setup

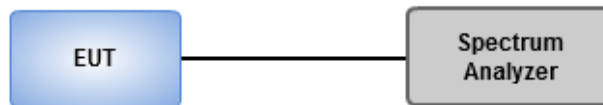

3.7.4 Test result of Channel Separation

Ambient Condition	22°C / 66%	Tested By	Brad Wu
--------------------------	------------	------------------	---------

Summary

Mode	Max-Space (Hz)	Min-Space (Hz)
2.4-2.4835GHz	-	-
BT-BR(1Mbps)	1M	1M
BT-EDR(2Mbps)	1M	995.652174k
BT-EDR(3Mbps)	1.004348M	1M

Result

Mode	Result	Fl (Hz)	Fh (Hz)	Ch.Space (Hz)	Limit (Hz)
BT-BR(1Mbps)	-	-	-	-	-
2402MHz	Pass	2.402157G	2.403157G	1M	624.978396k
2441MHz	Pass	2.441052G	2.442052G	1M	622.565478k
2480MHz	Pass	2.478983G	2.479983G	1M	617.738976k
BT-EDR(2Mbps)	-	-	-	-	-
2402MHz	Pass	2.401987G	2.402987G	1M	893.106k
2441MHz	Pass	2.440987G	2.441983G	995.652174k	895.104k
2480MHz	Pass	2.478983G	2.479983G	1M	897.768k
BT-EDR(3Mbps)	-	-	-	-	-
2402MHz	Pass	2.401987G	2.402987G	1M	890.442k
2441MHz	Pass	2.440983G	2.441987G	1.004348M	895.104k
2480MHz	Pass	2.478983G	2.479987G	1.004348M	907.092k

BT-BR(1Mbps)

Channel Separation-FS

2.402G/2.403GHz



BT-BR(1Mbps)

Channel Separation-FS

2.441G/2.442GHz

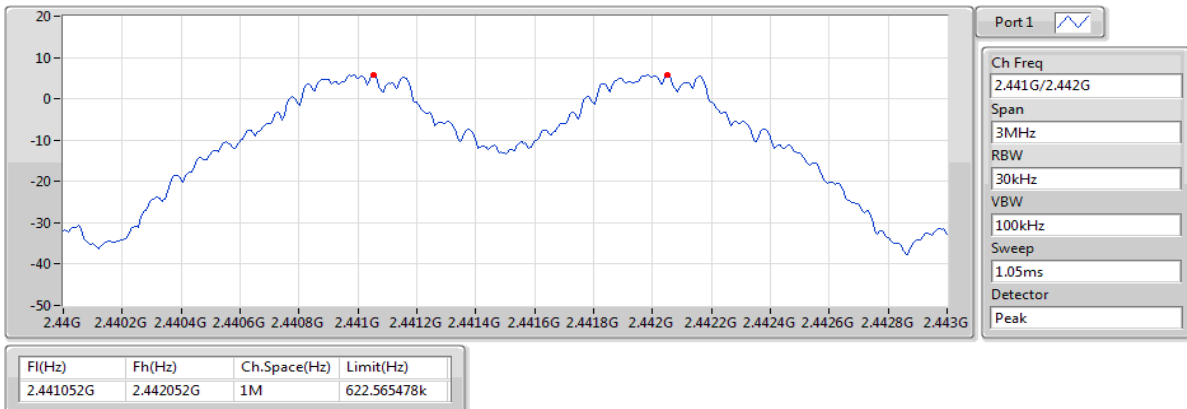

BT-BR(1Mbps)

Channel Separation-FS

2.48G/2.479GHz



BT-EDR(2Mbps)

Channel Separation-FS

2.402G/2.403GHz

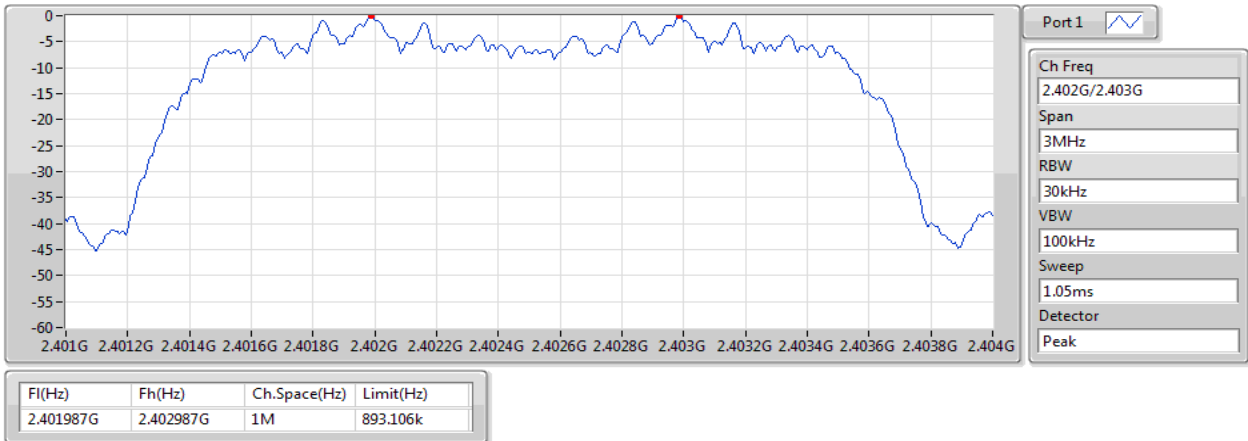

BT-EDR(2Mbps)

Channel Separation-FS

2.441G/2.442GHz

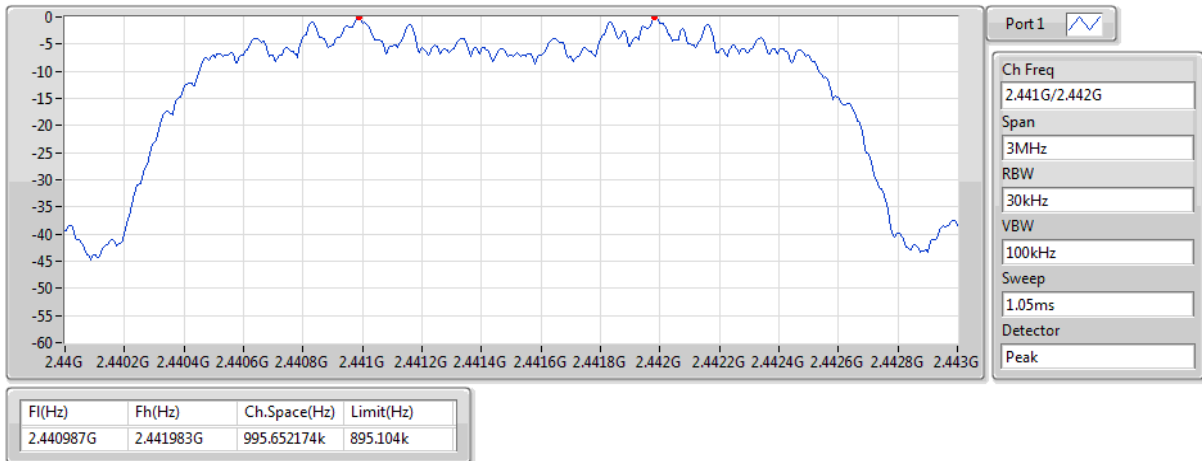

BT-EDR(2Mbps)

Channel Separation-FS

2.48G/2.479GHz

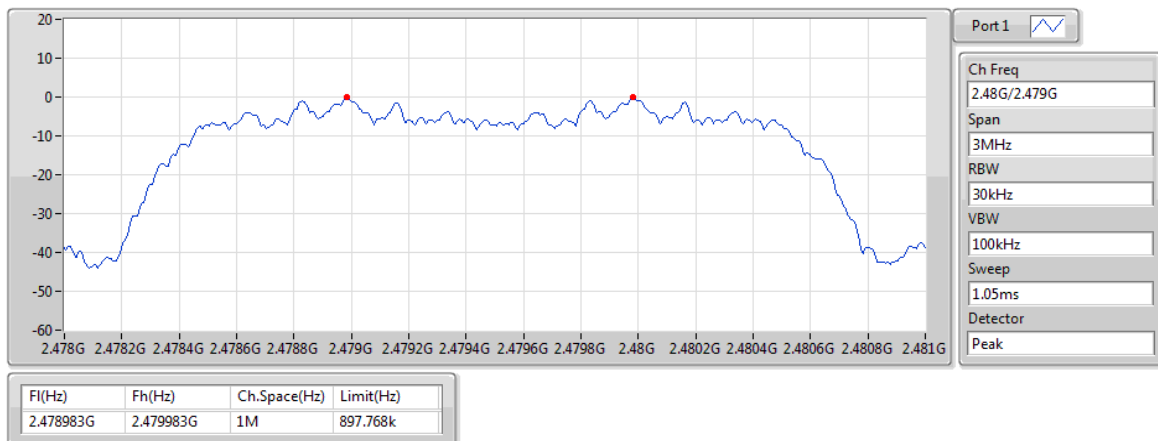

BT-EDR(3Mbps)

Channel Separation-FS

2.402G/2.403GHz

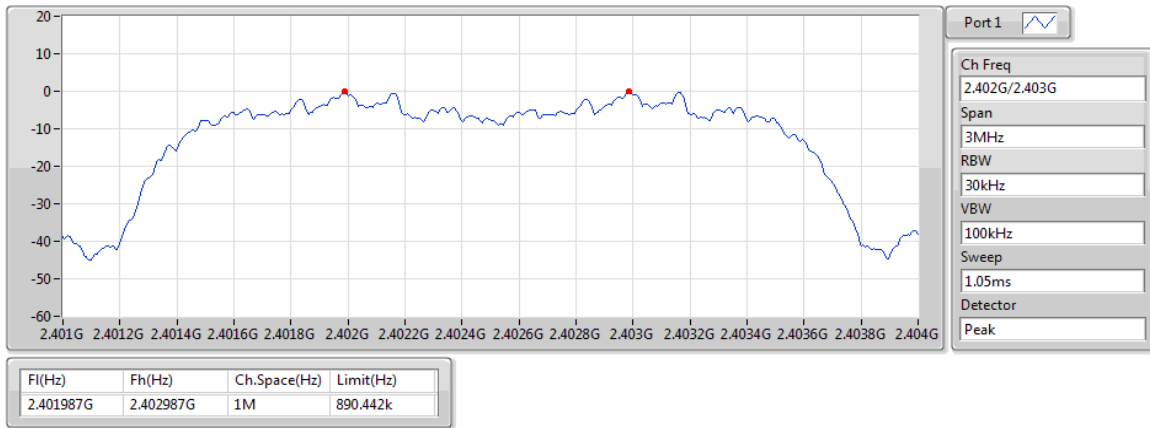

BT-EDR(3Mbps)

Channel Separation-FS

2.441G/2.442GHz

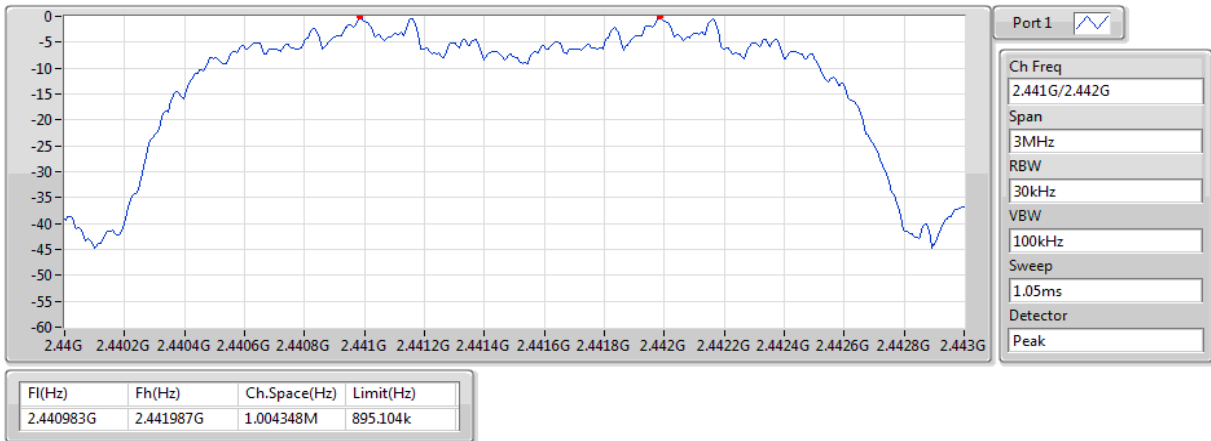

BT-EDR(3Mbps)
2.48G/2.479GHz

Channel Separation-FS

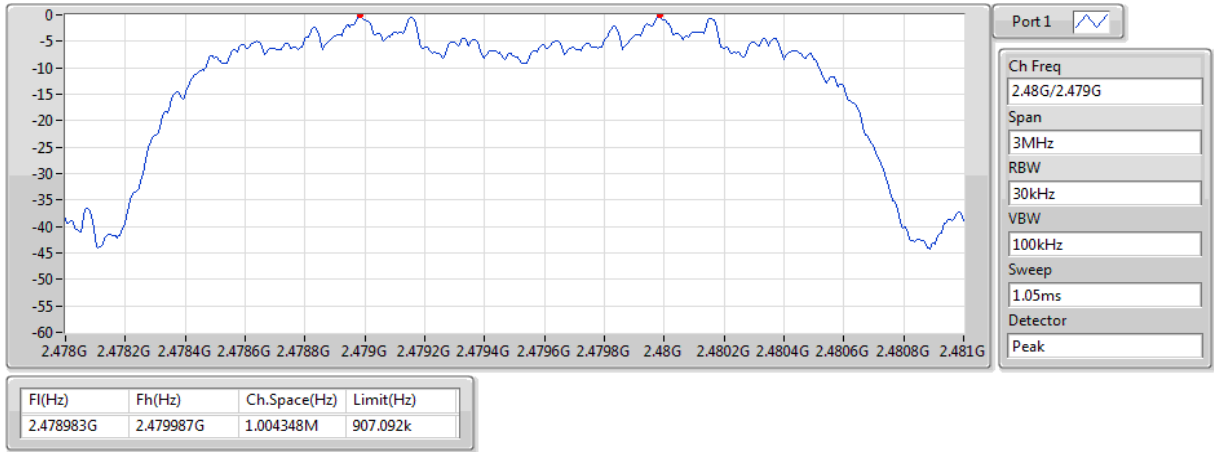

3.8 Number of Dwell Time

3.8.1 Limit of Dwell time

The average time of occupancy on any channel shall not be greater than 0.4 seconds within a period of 0.4 seconds multiplied by the number of hopping channels employed.

3.8.2 Test Procedures

1. Set RBW=300 kHz, VBW=1 MHz, Sweep time=8 ms, Detector=Peak, Span=0 Hz, Trace max hold.
2. Enable gating and trigger function of spectrum analyzer to measure burst on time.
3. Set RBW=300 kHz, VBW=1 MHz, Sweep time=5 s / 2 s, Detector=Peak, Span=0 Hz, Trace max hold.
4. Enable gating and trigger function of spectrum analyzer to measure burst on number of transmission.
5. Set RBW=300 kHz, VBW=1 MHz, Sweep time=31.6 s / 8 s, Detector=Peak, Span=0 Hz, Trace max hold.
6. Enable gating and trigger function of spectrum analyzer to measure burst on number of transmission of entire time cycle.

3.8.3 Test Setup

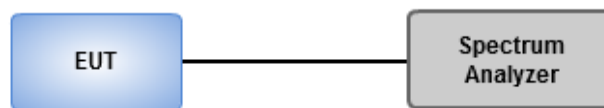

3.8.4 Test Result of Dwell Time

Ambient Condition	22°C / 66%	Tested By	Brad Wu
--------------------------	------------	------------------	---------

Summary

Mode	Max-Dwell (s)
2.4-2.4835GHz	-
BT-BR(1Mbps)	329.02236m_DH5
BT-EDR(2Mbps)	351.26402m_DH5
BT-EDR(3Mbps)	351.59424m_DH5
BT-BR-AFH(1Mbps)	315.522m_DH5-AFH
BT-EDR-AFH(2Mbps)	292.375m_DH5-AFH
BT-EDR-AFH(3Mbps)	292.8m_DH5-AFH

Result/ Non AFH mode

Mode	Result	Period (s)	Dwell (s)	Limit (s)	Tx On (ms)	Number of transmission in a 5 s
BT-BR(1Mbps)	-	-	-	-	-	-
2402MHz_DH5	PASS	31.6	0.32902	0.4	2.89225	18
BT-EDR(2Mbps)	-	-	-	-	-	-
2402MHz_DH5	PASS	31.6	0.35126	0.4	2.92525	19
BT-EDR(3Mbps)	-	-	-	-	-	-
2402MHz_DH5	PASS	31.6	0.35159	0.4	2.92800	19

Note 1: Dwell time =Number of transmission in a 5 second x Tx On Time x 6.32

Note 2: DH5 was the worst mode.

Result/ AFH mode

Mode	Result	Period (s)	Dwell (s)	Limit (s)	Tx On (ms)	Number of transmission in a 2 s
BT-BR-AFH(1Mbps)	-	-	-	-	-	-
2402MHz_DH5	PASS	8	0.31552	0.4	2.92150	27
BT-EDR-AFH(2Mbps)	-	-	-	-	-	-
2402MHz_DH5	PASS	8	0.29238	0.4	2.92375	25
BT-EDR-AFH(3Mbps)	-	-	-	-	-	-
2402MHz_DH5	PASS	8	0.29280	0.4	2.92800	25

Note 1: Dwell time =Number of transmission in a 2 second x Tx On Time x 4

Note 2: DH5 was the worst mode.

BT-BR(1Mbps)
2402MHz

Dwell-FS

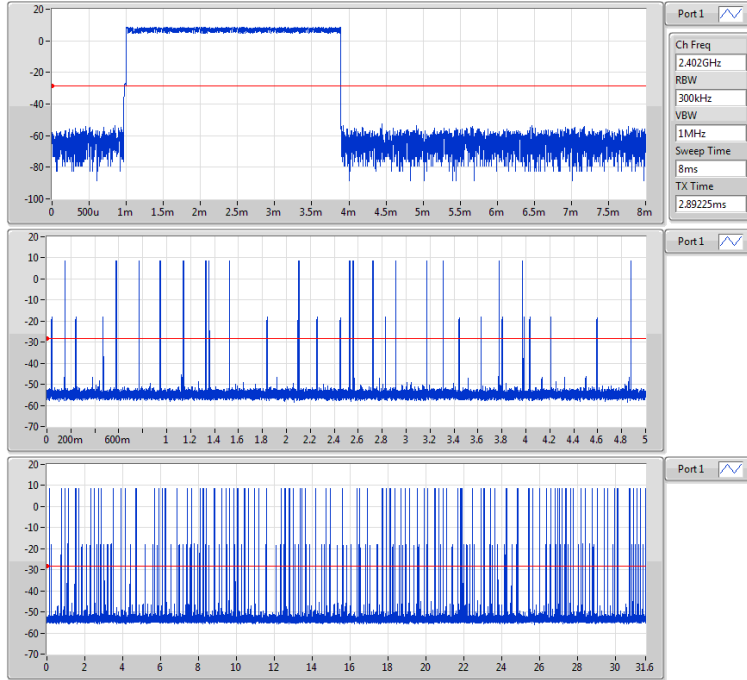

BT-EDR(2Mbps)
2402MHz

Dwell-FS

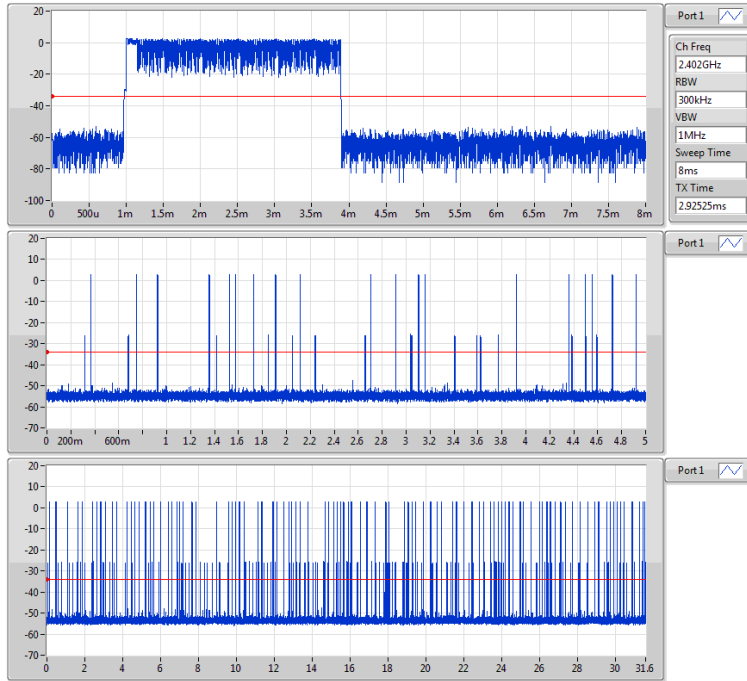

BT-EDR(3Mbps)
2402MHz

Dwell-FS



BT-BR-AFH(1Mbps)
2402MHz

Dwell-FS

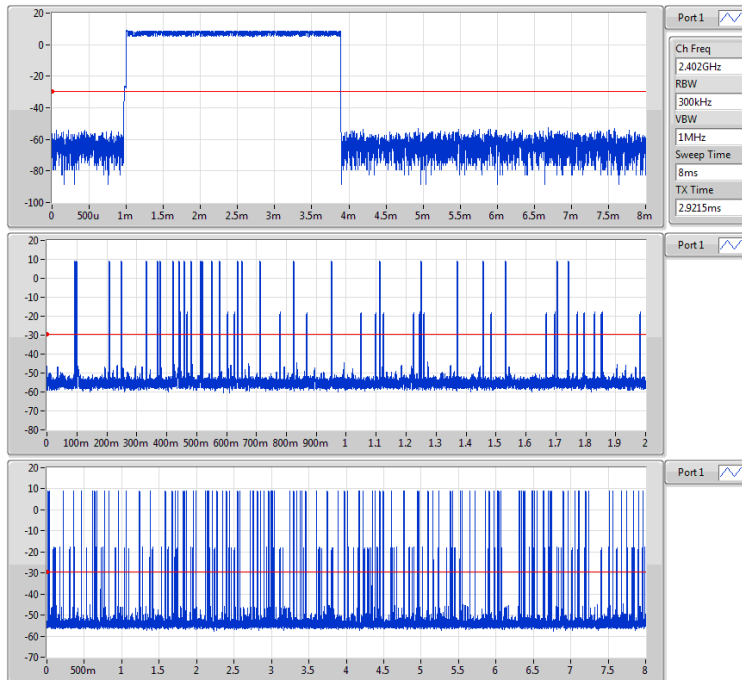

BT-EDR-AFH(2Mbps)
2402MHz

Dwell-FS



BT-EDR-AFH(3Mbps)
2402MHz

Dwell-FS

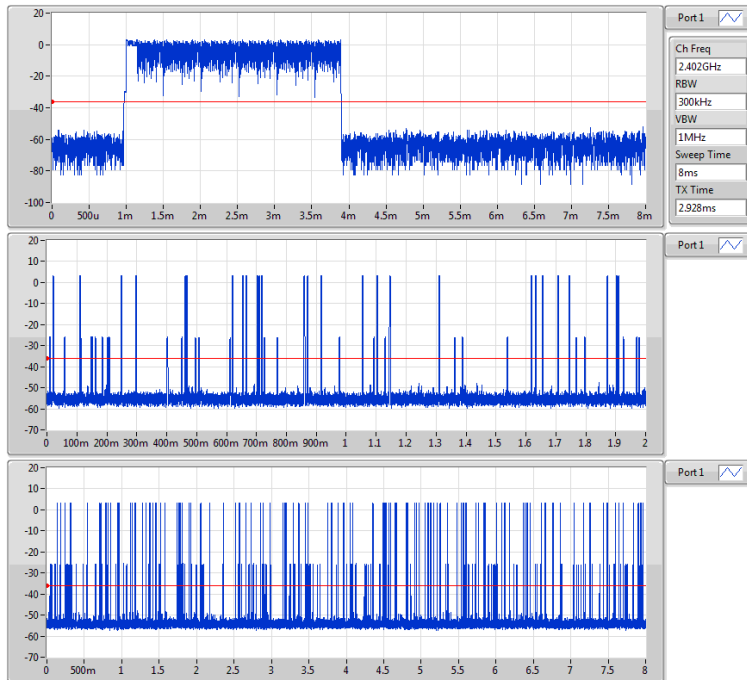

4 Test laboratory information

Established in 2012, ICC provides foremost EMC & RF Testing and advisory consultation services by our skilled engineers and technicians. Our services employ a wide variety of advanced edge test equipment and one of the widest certification extents in the business.

International Certification Corp (EMC and Wireless Communication Laboratory), it is our definitive objective is to institute long term, trust-based associations with our clients. The expectation we set up with our clients is based on outstanding service, practical expertise and devotion to a certified value structure. Our passion is to grant our clients with best EMC / RF services by oriented knowledgeable and accommodating staff.

Our Test sites are located at Linkou District and Kwei Shan District. Location map can be found on our website <http://www.icertifi.com.tw>.

Linkou

Tel: 886-2-2601-1640

No. 30-2, Ding Fwu Tsuen, Lin
Kou District, New Taipei City,
Taiwan, R.O.C.

Kwei Shan

Tel: 886-3-271-8666

No. 3-1, Lane 6, Wen San 3rd St.,
Kwei Shan District, Tao Yuan City
333, Taiwan, R.O.C.

Kwei Shan Site II

Tel: 886-3-271-8640

No. 14-1, Lane 19, Wen San 3rd
St., Kwei Shan District, Tao Yuan
City 333, Taiwan, R.O.C.

If you have any suggestion, please feel free to contact us as below information.

Tel: 886-3-271-8666

Fax: 886-3-318-0155

Email: ICC_Service@icertifi.com.tw

==END==