

# AW-NM333

## IEEE 802.11 1X1 b/g/n Wireless LAN Module

### Datasheet

Rev. 07

B01

CUSTOMER APPROVED SIGNATURE			
AZUREWAVE APPROVED SIGNATURE			
Confirm		Approve	

## Revision History

<i>Revision</i>	<i>Date</i>	<i>Description</i>	<i>Initials</i>	<i>Approved</i>
Ver 0.1	2017/11/16	Draft version	Grace Liu	Daniel Lee
Ver 0.2	2017/11/22	1. Modify 1.4 Specifications Table 2. Modify 2.2 Pin Table	Grace Liu	Daniel Lee
Ver 0.3	2018/01/19	Update RF spec	Grace Liu	Daniel Lee
Ver 0.4	2018/01/25	Add description under 2.2 Pin Table	Grace Liu	Daniel Lee
Ver 0.5	2018/01/29	1. Remove WLAN VID/PID, WLAN SVID/SPID 2. Add Weight	Rita Lu	Josh Lin
Ver 0.6	2018/02/23	Add shipping information	Rita Lu	Josh Lin
Ver 0.7	2018/04/23	Update RF spec(target output power)	Renton Tao	N.C Chen
		Add label and Silkscreen information	Rita Lu	Josh Lin

## Table of Contents

<b>Revision History .....</b>	<b>2</b>
<b>Table of Contents .....</b>	<b>3</b>
<b>1.Introduction.....</b>	<b>4</b>
1.1 Product Overview .....	4
1.2 Features.....	5
1.2.1 WLAN.....	5
1.4 Specifications Table.....	6
1.4.1 General .....	7
1.4.2 WLAN.....	7
1.4.3 Operating Conditions .....	8
<b>2. Pin Definition .....</b>	<b>8</b>
2.2 Pin Table.....	8
<b>3. Electrical Characteristics .....</b>	<b>9</b>
3.1 Absolute Maximum Ratings .....	9
3.2 Recommended Operating Conditions .....	9
3.3 Digital IO Pin DC Characteristics.....	9
3.3.1 1.8V Operation (VIO).....	9
3.3.2 3.3V Operation (VIO).....	9
<b>4. Mechanical Information .....</b>	<b>10</b>
4.1 Mechanical Drawing.....	10
<b>5. Shipping information.....</b>	<b>11</b>
5.1 Tray information.....	12
5.2 Package information.....	12
5.3 The carton label.....	13
<b>6.Installation guide. ....</b>	<b>14</b>
<b>7. Statement .....</b>	<b>18</b>



## 1. Introduction

### 1.1 Product Overview

**AzureWave Technologies, Inc.** introduces the IEEE 802.11b/g/n 1X1 WLAN & Bluetooth module --- **AW-NM333**. The module is targeted to mobile devices including **Printers, Notebook, TV, Tablet and Gaming Device** which need small package module, low power consumption and OS support. By using AW-NM333, the customers can easily enable the Wi-Fi embedded applications with the benefits of **high design flexibility, short development cycle, and quick time-to-market.**

Compliance with the IEEE 802.11b/g/n standard, the AW-NM333 uses Direct Sequence Spread Spectrum (**DSSS**), Orthogonal Frequency Division Multiplexing (**OFDM**), **DBPSK, DQPSK, CCK** and **QAM** baseband modulation technologies. A high level of integration and full implementation of the power management functions specified in the IEEE 802.11 standard minimize the system power requirements by using AW-NM333. In addition to the support of **WPA/WPA2** and **WEP** 64-bit and 128-bit encryption, the AW-NM333 also supports the **IEEE 802.11i** security standard through the implementation of **Advanced Encryption Standard (AES)/Counter Mode CBC-MAC Protocol (CCMP)**, Wired Equivalent Privacy (**WEP**) with Temporal Key Integrity Protocol (**TKIP**), Advanced Encryption Standard (**AES**)/Cipher-Based Message Authentication Code (**CMAC**), and WLAN Authentication and Privacy Infrastructure (**WAPI**) security mechanisms.

AW-NM333 supports **SDIO** for WLAN to the host processor.

## 1.2 Features

### 1.2.1 WLAN

- Support 802.11n 1x1 SISO and HT20 operation
- IEEE 802.11n compliant with maximum data rates up to 72.2 Mbps (20 MHz channel)
- SDIO 2.0 device interface (1-bit SDIO, 4-bit SDIO transfer modes at full clock range up to 50 MHz)
- SDIO 2.0 interface for connecting WLAN technologies to the host processor
- Multiple power saving modes for low power consumption
- Antenna can be switched by RF switch connector

## 1.4 Specifications Table

### 1.4.1 General

Features	Description
Product Description	1x1 Wireless LAN Module
Major Chipset	88W8801
Host Interface	Wi-Fi : SDIO
Dimension	35mm x 30mm x 3.25mm(max)
Package	Module card with FFC I/F connector
Antenna	On board PCB antenna/(RF switch connector)
Weight	4 g

### 1.4.2 WLAN

Features	Description
WLAN Standard	IEEE 802.11 b/g/n
Frequency Range	2.4 GHz : 2.412 ~ 2.472 GHz
Modulation	DSSS, OFDM, DBPSK, DQPSK, CCK, 16-QAM, 64-QAM
	<b>2.4GHz</b>
Number of Channels	<ul style="list-style-type: none"> <li>■ USA, NORTH AMERICA, Canada and Taiwan – 1 ~ 11</li> <li>■ China, Australia, Most European Countries – 1 ~ 13</li> </ul>
Output Power (Board Level Limit)*	FCC:381.944mW
Receiver Sensitivity	
Data Rate	802.11b : 1, 2, 5.5, 11Mbps 802.11g : 6, 9, 12, 18, 24, 36, 48, 54Mbps 802.11n : up to 72.2Mbps-single
Security	<ul style="list-style-type: none"> <li>■ WAPI</li> <li>■ WEP 64-bit and 128-bit encryption with H/W TKIP processing</li> <li>■ WPA/WPA2 (Wi-Fi Protected Access)</li> <li>■ AES-CCMP hardware implementation as part of 802.11i security standard</li> </ul>

\* If you have any certification questions about output power please contact FAE directly.

### 1.4.3 Operating Conditions

Features	Description
Operating Conditions	
Voltage	3.3V
Operating Temperature	-40~85 °C
Operating Humidity	TBD
Storage Temperature	-55~125 °C
Storage Humidity	20%RH~70%RH

## 2. Pin Definition

### 2.2 Pin Table

Pin No	Definition	Basic Description	Voltage	Type
<b>Full Power-Down</b>				
1	PDn*	0 = full power-down mode 1 = normal mode	I	1.8V/3.3V
2	VIO	1.8V/3.3V SD_VIO Power Supply	I	1.8V/3.3V
3	GND3	Ground	-	-
4	SD_CLK	SDIO Clock Input	I/O	VIO
5	GND5	Ground	-	-
6	SD_DAT[3]	SDIO Data line Bit[3]	I/O	VIO
7	SD_DAT[2]	SDIO Data line Bit[2]	I/O	VIO
8	SD_DAT[1]	SDIO Data line Bit[1]	I/O	VIO
9	SD_DAT[0]	SDIO Data line Bit[0]	I/O	VIO
10	SD_CMD	SDIO Command	I/O	VIO
11	GND	Ground	-	-
12	VCC_33	3.3V Power Supply	I	3.3V
13	HOST_WKUP	Host Wakeup	O	3.3V

\*Without internal pull-up resistor



### 3. Electrical Characteristics

#### 3.1 Absolute Maximum Ratings

Symbol	Parameter	Minimum	Typical	Maximum	Unit
VCC_33	3.3V input	-	3.3	4.0	V
VIO	Host I/O power supply	-	1.8	2.2	
		-	3.3	4.0	

#### 3.2 Recommended Operating Conditions

Symbol	Parameter	Minimum	Typical	Maximum	Unit
VCC_33	3.3V power supply	2.97	3.3	3.63	V
VIO	1.8V/3.3V digital I/O power supply	1.62	1.8	1.98	
		2.97	3.3	3.63	

#### 3.3 Digital IO Pin DC Characteristics

##### 3.3.1 1.8V Operation (VIO)

Symbol	Parameter	Minimum	Typical	Maximum	Unit
V <sub>IH</sub>	Input high voltage	0.7*V <sub>18</sub>	-	V <sub>18</sub> +0.4	V
V <sub>IL</sub>	Input low voltage	-0.4	-	0.3*V <sub>18</sub>	
V <sub>OH</sub>	Output high voltage	V <sub>18</sub> -0.4	-	-	
V <sub>OL</sub>	Output low voltage	-	-	0.4	

##### 3.3.2 3.3V Operation (VIO)

Symbol	Parameter	Minimum	Typical	Maximum	Unit
V <sub>IH</sub>	Input high voltage	0.7*V <sub>33</sub>	-	V <sub>33</sub> +0.4	V
V <sub>IL</sub>	Input low voltage	-0.4	-	0.3*V <sub>33</sub>	
V <sub>OH</sub>	Output high voltage	V <sub>33</sub> -0.4	-	-	
V <sub>OL</sub>	Output low voltage	-	-	0.4	

## 4. Mechanical Information

### 4.1 Mechanical Drawing

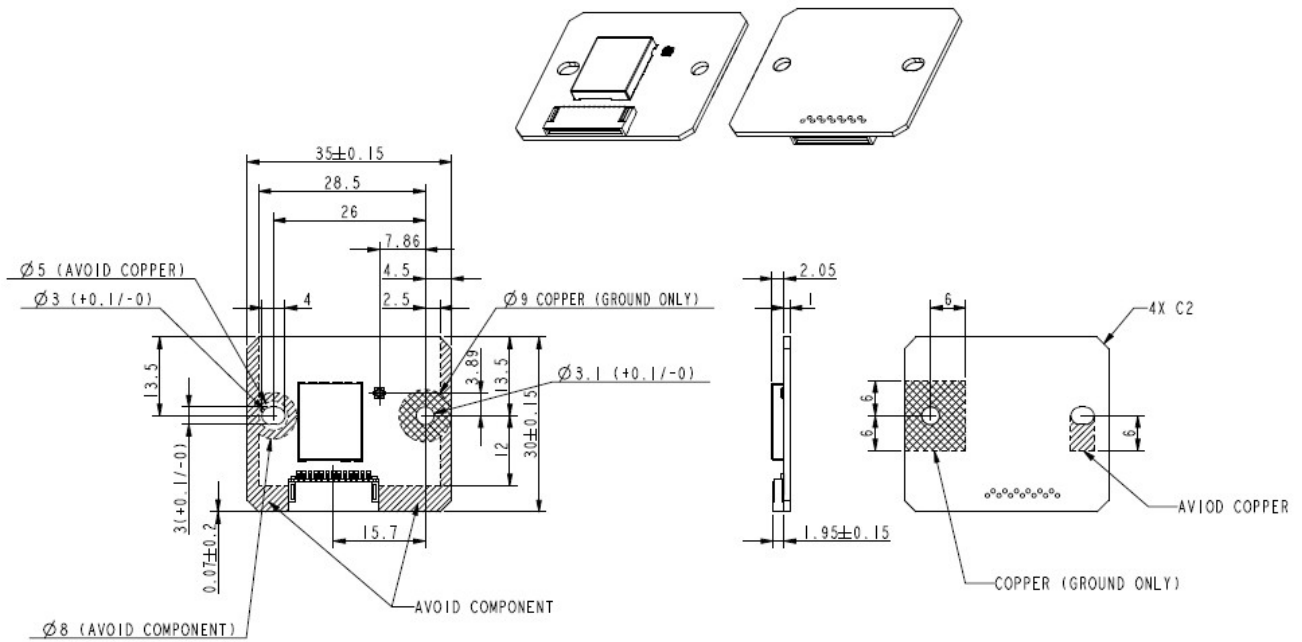

TOLERANCES UNLESS OTHERWISE SPECIFIED:  $\pm 0.1\text{mm}$

## 5. Shipping information

### 5.1 Tray information

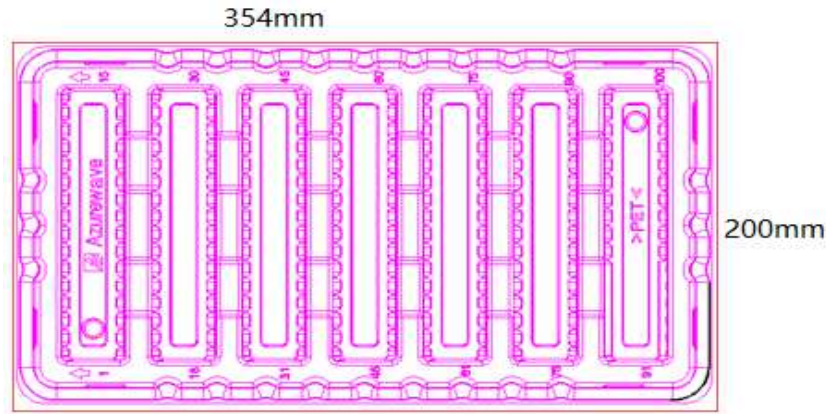

**100pcs/Tray**

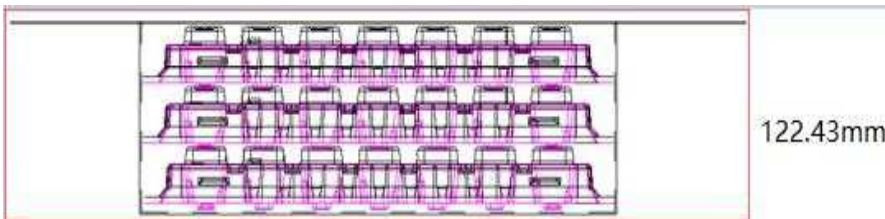

**3 trays/Inner box, total 300pcs**

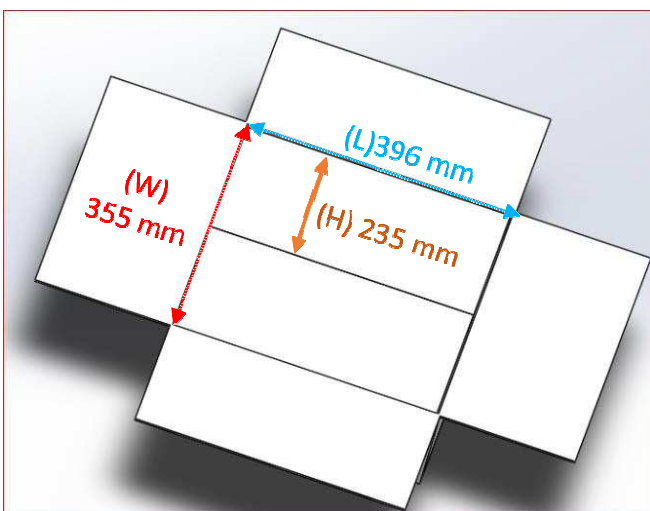

**2 inner boxes/Carton, total 600pcs**

## 5.2 Package Information



Rubber Band

Desiccant



Dry pack Bag

◆ Vacuum packing





AZ P/N: 2-23330-XXX  
Q'ty: 300pcs

1 vacuum package contains 3 trays, totally 300pcs of module.

1 carton contains 2 vacuum packages, totally 600pcs of module.



5.3 The carton label as below.

 AzureWave Technologies, Inc.		100 mm
AzureWave P/N	2-23330-XXX	
Customer		
Custmer P/N		
Descrption	AW-NM333	
Q'ty	600 pcs	
C/N		
N.W.	G.W.	
		

## Installation guide

1. Please use NB & 1 pcs 2.4G AP
2. Test Configuration

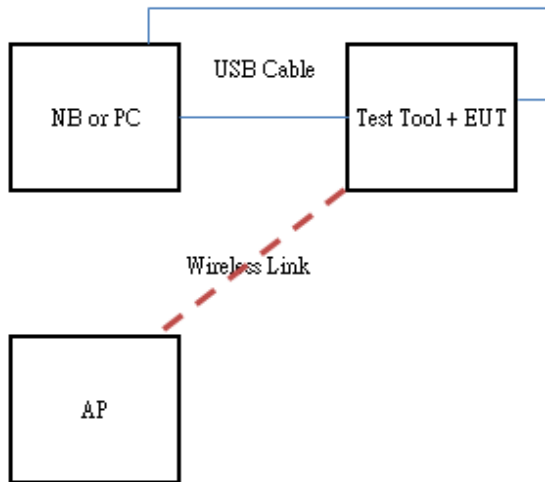

3. Open the Terminal after the system is turned on

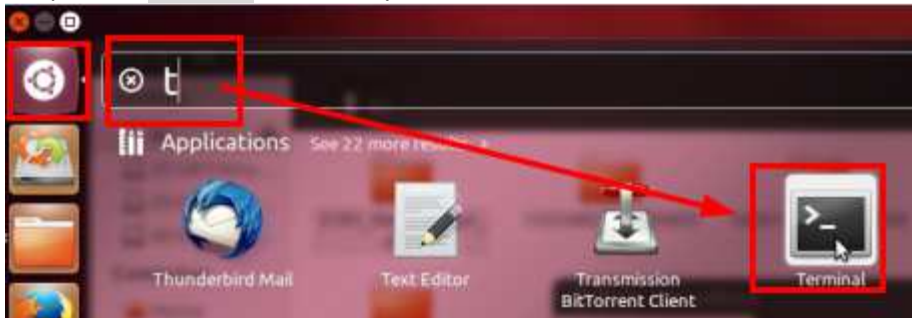

※※ The next steps are important: ※※

4. select Wi-Fi icon → Click Edit → and delete wired

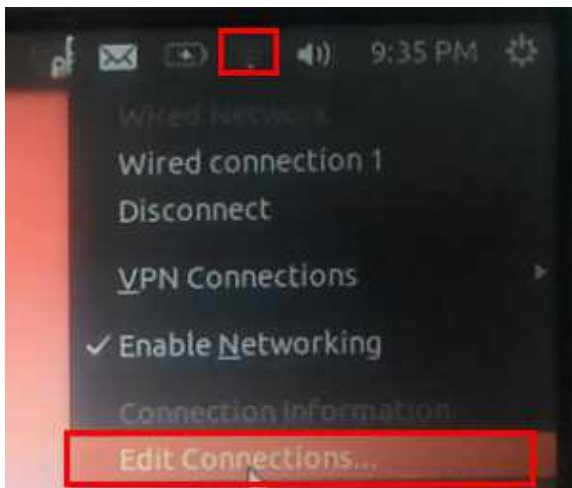



※※ The next steps are important: ※※

(1) Test Tool (A) connection USB Cable with PC/NB

(2) Test Tool (B) connection USB Cable with PC/NB

(3) Test Tool (A) & Test Tool (B) connection

6. Open Ubuntu, press Ctrl+Alt+T → open Terminal

Key in command

7. command

`sudo su`

password: `azwave`

`chmod 777 * -R`

`cd /home/azwave/2333/driver/bin_sd8801`

`./normal_enable.sh`

//paste command ;LED is flash "blue" color

`iwconfig`

//Check mlan0 Enable , if not please

follow step 8 restart again

```

root@azwave-Latitude-E6430: /home/azwave/2333/driver/bin_sd8801
azwave@azwave-Latitude-E6430:~$ sudo su
[sudo] password for azwave:
root@azwave-Latitude-E6430:/home/azwave# cd 2333/driver/bin_sd8801/
root@azwave-Latitude-E6430:/home/azwave/2333/driver/bin_sd8801# ./normal_enable.
sh
root@azwave-Latitude-E6430:/home/azwave/2333/driver/bin_sd8801# iwconfig
mlan0 IEEE 802.11-DS ESSID:""
Mode:Managed Access Point: Not-Associated Bit Rate:1 Mb/s
Tx-Power=18 dBm
Retry limit:9 RTS thr=2347 B Fragment thr=2346 B
Encryption key:off
Power Management:on
Link Quality=0/5 Signal level=0 dBm Noise level=0 dBm
Rx invalid nwid:0 Rx invalid crypt:0 Rx invalid frag:126
Tx excessive retries:0 Invalid misc:0 Missed beacon:0

lo no wireless extensions.

wlan0 IEEE 802.11abgn ESSID:off/any
Mode:Managed Access Point: Not-Associated Tx-Power=0 dBm
Retry long limit:7 RTS thr:off Fragment thr:off
Encryption key:off
Power Management:off

eth0 no wireless extensions.

root@azwave-Latitude-E6430:/home/azwave/2333/driver/bin_sd8801#

```

`iwlist mlan0 scan` //scan AP ,check have scan TEST2

`iwconfig mlan0 essid Cisco2` //join AP

`ifconfig mlan0 192.168.0.100` //set Wireless IP

`ping 192.168.0.1` //ping AP IP ◦

- ❌❌ Important: During testing or when testing is completed to turn off the EUT, follow these steps:

Step 1: please NB (2)" Terminal" Close .

Step 2: Will be USB B-type disconnect

Step 3: Key in `./dsable.sh` command

```

De-Initialize drvwrapper for BT....
De-Initialize drvwrapper ....
^Croot@ubuntu:/home/ubuntu/2333/driver/bin_sd8801# ./disable.sh
ERROR: Module sd8xxx is in use
ERROR: Module mlan is in use by sd8xxx

```

## 9. OS Shutdown step

Test ok, please choice icon → shot down



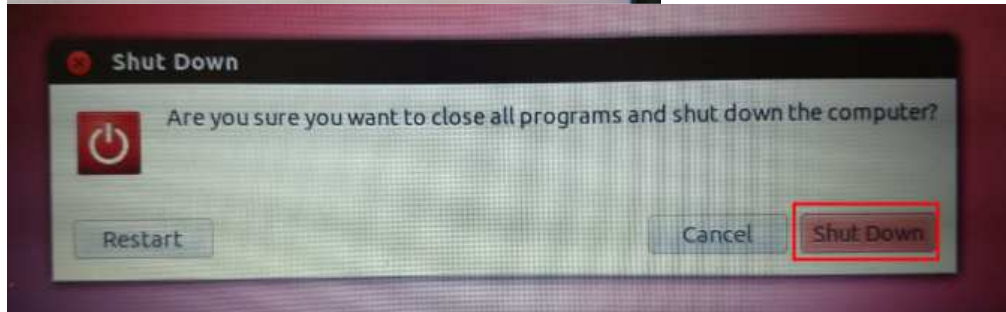
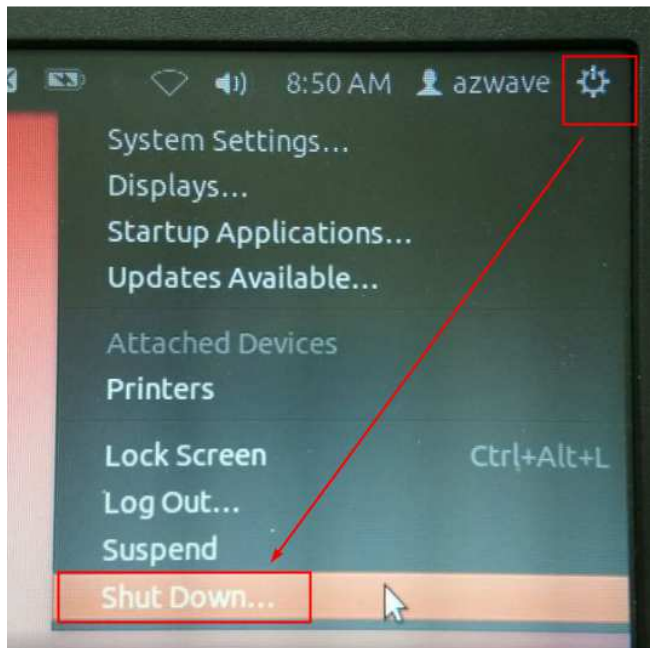

## Federal Communication Commission Interference Statement

This device complies with Part 15 of the FCC Rules. Operation is subject to the following two conditions: (1) This device may not cause harmful interference, and (2) this device must accept any interference received, including interference that may cause undesired operation.

This equipment has been tested and found to comply with the limits for a Class B digital device, pursuant to Part 15 of the FCC Rules. These limits are designed to provide reasonable protection against harmful interference in a residential installation. This equipment generates, uses and can radiate radio frequency energy and, if not installed and used in accordance with the instructions, may cause harmful interference to radio communications. However, there is no guarantee that interference will not occur in a particular installation. If this equipment does cause harmful interference to radio or television reception, which can be determined by turning the equipment off and on, the user is encouraged to try to correct the interference by one of the following measures:

- Reorient or relocate the receiving antenna.
- Increase the separation between the equipment and receiver.
- Connect the equipment into an outlet on a circuit different from that to which the receiver is connected.
- Consult the dealer or an experienced radio/TV technician for help.

FCC Caution: Any changes or modifications not expressly approved by the party responsible for compliance could void the user's authority to operate this equipment.

This transmitter must not be co-located or operating in conjunction with any other antenna or transmitter.

#### Radiation Exposure Statement:

This equipment complies with FCC radiation exposure limits set forth for an uncontrolled environment. This equipment should be installed and operated with minimum distance 20cm between the radiator & your body.

#### **This device is intended only for OEM integrators under the following conditions:**

The antenna must be installed such that 20 cm is maintained between the antenna and users, and

The transmitter module may not be co-located with any other transmitter or antenna.

As long as 2 conditions above are met, further transmitter test will not be required.

However, the OEM integrator is still responsible for testing their end-product for any additional compliance requirements required with this module installed

**IMPORTANT NOTE:** In the event that these conditions can not be met (for example certain laptop configurations or co-location with another transmitter), then the FCC authorization is no longer considered valid and the FCC ID can not be used on the final product. In these circumstances, the OEM integrator will be responsible for re-evaluating the end product (including the transmitter) and obtaining a separate FCC authorization.

#### **End Product Labeling**

This transmitter module is authorized only for use in device where the antenna may be installed such that 20 cm may be maintained between the antenna and users. The final end product must be labeled in a visible area with the following: “Contains FCC ID: **TLZ-NM333**”. The grantee's FCC ID can be used only when all FCC compliance requirements are met.

#### **Manual Information To the End User**

The OEM integrator has to be aware not to provide information to the end user regarding how to install or remove this RF module in the user's manual of the end product which integrates this module.

The end user manual shall include all required regulatory information/warning as show in this manual.

### **Industry Canada statement:**

This device complies with ISED's licence-exempt RSSs. Operation is subject to the following two conditions: (1) This device may not cause harmful interference, and (2) this device must accept any interference received, including interference that may cause undesired operation.

Le présent appareil est conforme aux CNR d'ISED applicables aux appareils radio exempts de licence. L'exploitation est autorisée aux deux conditions suivantes : (1) le dispositif ne doit pas produire de brouillage préjudiciable, et (2) ce dispositif doit accepter tout brouillage reçu, y compris un brouillage susceptible de provoquer un fonctionnement indésirable.

### **Radiation Exposure Statement:**

This equipment complies with ISED radiation exposure limits set forth for an uncontrolled environment. This equipment should be installed and operated with minimum distance 20cm between the radiator & your body.

### **Déclaration d'exposition aux radiations:**

Cet équipement est conforme aux limites d'exposition aux rayonnements ISED établies pour un environnement non contrôlé. Cet équipement doit être installé et utilisé avec un minimum de 20 cm de distance entre la source de rayonnement et votre corps.

### **This device is intended only for OEM integrators under the following conditions: (For module device use)**

- 1) The antenna must be installed such that 20 cm is maintained between the antenna and users, and
- 2) The transmitter module may not be co-located with any other transmitter or antenna.

As long as 2 conditions above are met, further transmitter test will not be required. However, the OEM integrator is still responsible for testing their end-product for any additional compliance requirements required with this module installed.

### **Cet appareil est conçu uniquement pour les intégrateurs OEM dans les conditions suivantes: (Pour utilisation de dispositif module)**

- 1) L'antenne doit être installée de telle sorte qu'une distance de 20 cm est respectée entre l'antenne et les utilisateurs,
- 2) Le module émetteur peut ne pas être coïmplanté avec un autre émetteur ou antenne.

Tant que les 2 conditions ci-dessus sont remplies, des essais supplémentaires sur l'émetteur ne seront pas nécessaires. Toutefois, l'intégrateur OEM est toujours responsable des essais sur son produit final pour toutes exigences de conformité supplémentaires requis pour ce module installé.

**IMPORTANT NOTE:**

In the event that these conditions can not be met (for example certain laptop configurations or co-location with another transmitter), then the Canada authorization is no longer considered valid and the IC ID can not be used on the final product. In these circumstances, the OEM integrator will be responsible for re-evaluating the end product (including the transmitter) and obtaining a separate Canada authorization.

**NOTE IMPORTANTE:**

Dans le cas où ces conditions ne peuvent être satisfaites (par exemple pour certaines configurations d'ordinateur portable ou de certaines co-localisation avec un autre émetteur), l'autorisation du Canada n'est plus considéré comme valide et l'ID IC ne peut pas être utilisé sur le produit final. Dans ces circonstances, l'intégrateur OEM sera chargé de réévaluer le produit final (y compris l'émetteur) et l'obtention d'une autorisation distincte au Canada.

**End Product Labeling**

This transmitter module is authorized only for use in device where the antenna may be installed such that 20 cm may be maintained between the antenna and users. The final end product must be labeled in a visible area with the following: "Contains IC: **6100A-NM333**".

**Plaque signalétique du produit final**

Ce module émetteur est autorisé uniquement pour une utilisation dans un dispositif où l'antenne peut être installée de telle sorte qu'une distance de 20cm peut être maintenue entre l'antenne et les utilisateurs. Le produit final doit être étiqueté dans un endroit visible avec l'inscription suivante: "Contient des IC: 6100A-NM333".

**Manual Information To the End User**

The OEM integrator has to be aware not to provide information to the end user regarding how to install or remove this RF module in the user's manual of the end product which integrates this module.

The end user manual shall include all required regulatory information/warning as show in this manual.

**Manuel d'information à l'utilisateur final**

L'intégrateur OEM doit être conscient de ne pas fournir des informations à l'utilisateur final quant à la façon d'installer ou de supprimer ce module RF dans le manuel de l'utilisateur du produit final qui intègre ce module.

Le manuel de l'utilisateur final doit inclure toutes les informations réglementaires requises et avertissements comme indiqué dans ce manuel.

## 低功率電波輻射性電機管理辦法

第十二條 經型式認證合格之低功率射頻電機，非經許可，公司、商號或使用者均不得擅自變更頻率、加大功率或變更原設計之特性及功能。

第十四條 低功率射頻電機之使用不得影響飛航安全及干擾合法通信；經發現有干擾現象時，應立即停用，並改善至無干擾時方得繼續使用。

前項合法通信，指依電信法規定作業之無線電通信。低功率射頻電機須忍受合法通信或工業、科學及醫療用電波輻射性電機設備之干擾。

1. 本模組於取得認證後將依規定於模組本體標示審驗合格標籤。
2. 系統廠商應於平台上標示「本產品內含射頻模組：

XXXyyyLPDzzzz-x」字樣。