

FCC TEST REPORT (WLAN)

REPORT NO.: RF120220C10
MODEL NO.: AW-NB101
FCC ID: TLZ-NB101
RECEIVED: Feb. 20, 2012
TESTED: Mar. 01 ~ Mar. 20, 2012
ISSUED: Mar. 22, 2012

APPLICANT: AzureWave Technologies, Inc.

ADDRESS: 8F., No.94, Baozhong Rd., Xindian Dist., New Taipei City 231, Taiwan

ISSUED BY: Bureau Veritas Consumer Products Services (H.K.) Ltd., Taoyuan Branch

LAB ADDRESS: No. 47, 14th Ling, Chia Pau Vil., Lin Kou Dist., New Taipei City, Taiwan (R.O.C.)

TEST LOCATION: No. 19, Hwa Ya 2nd Rd, Wen Hwa Tsuen, Kwei Shan Hsiang, Taoyuan Hsien 333, Taiwan, R.O.C.

This test report consists of 48 pages in total. It may be duplicated completely for legal use with the approval of the applicant. It should not be reproduced except in full, without the written approval of our laboratory. The client should not use it to claim product certification, approval or endorsement by TAF or any government agency. The test results in the report only apply to the tested sample.



TABLE OF CONTENTS

RELEASE CONTROL RECORD.....	4
1. CERTIFICATION	5
2. SUMMARY OF TEST RESULTS	6
2.1 MEASUREMENT UNCERTAINTY.....	6
3. GENERAL INFORMATION.....	7
3.1 GENERAL DESCRIPTION OF EUT	7
3.2 DESCRIPTION OF TEST MODES	8
3.2.1 TEST MODE APPLICABILITY AND TESTED CHANNEL DETAIL	9
3.3 DESCRIPTION OF SUPPORT UNITS	11
3.3.1 CONFIGURATION OF SYSTEM UNDER TEST	11
3.4 GENERAL DESCRIPTION OF APPLIED STANDARDS	12
4. TEST TYPES AND RESULTS	13
4.1 RADIATED EMISSION AND BANDEDGE MEASUREMENT.....	13
4.1.1 LIMITS OF RADIATED EMISSION AND BANDEDGE MEASUREMENT	13
4.1.2 TEST INSTRUMENTS.....	14
4.1.3 TEST PROCEDURES	15
4.1.4 DEVIATION FROM TEST STANDARD	15
4.1.5 TEST SETUP.....	16
4.1.6 EUT OPERATING CONDITIONS	16
4.1.7 TEST RESULTS	17
4.2 CONDUCTED EMISSION MEASUREMENT	30
4.2.1 LIMITS OF CONDUCTED EMISSION MEASUREMENT.....	30
4.2.2 TEST INSTRUMENTS.....	30
4.2.3 TEST PROCEDURES	31
4.2.4 DEVIATION FROM TEST STANDARD	31
4.2.5 TEST SETUP.....	31
4.2.6 EUT OPERATING CONDITIONS	31
4.2.7 TEST RESULTS	32
4.3 6dB BANDWIDTH MEASUREMENT.....	34
4.3.1 LIMITS OF 6dB BANDWIDTH MEASUREMENT	34
4.3.2 TEST SETUP.....	34
4.3.3 TEST INSTRUMENTS.....	34
4.3.4 TEST PROCEDURE.....	34
4.3.5 DEVIATION FROM TEST STANDARD	34
4.3.6 EUT OPERATING CONDITIONS	34
4.3.7 TEST RESULTS	35
4.4 CONDUCTED OUTPUT POWER	36
4.4.1 LIMITS OF CONDUCTED OUTPUT POWER MEASUREMENT	36
4.4.2 TEST SETUP.....	36
4.4.3 TEST INSTRUMENTS.....	36
4.4.4 TEST PROCEDURES	36
4.4.5 DEVIATION FROM TEST STANDARD	36
4.4.6 EUT OPERATING CONDITIONS	36
4.4.7 TEST RESULTS	37
4.5 POWER SPECTRAL DENSITY MEASUREMENT.....	38
4.5.1 LIMITS OF POWER SPECTRAL DENSITY MEASUREMENT	38
4.5.2 TEST SETUP.....	38
4.5.3 TEST INSTRUMENTS.....	38



A D T

4.5.4	TEST PROCEDURE.....	38
4.5.5	DEVIATION FROM TEST STANDARD	38
4.5.6	EUT OPERATING CONDITION	38
4.5.7	TEST RESULTS	39
4.6	CONDUCTED OUT OF BAND EMISSION MEASUREMENT.....	40
4.6.1	LIMITS OF CONDUCTED OUT OF BAND EMISSION MEASUREMENT	40
4.6.2	TEST SETUP.....	40
4.6.3	TEST INSTRUMENTS.....	40
4.6.4	TEST PROCEDURE.....	40
4.6.5	DEVIATION FROM TEST STANDARD	41
4.6.6	EUT OPERATING CONDITION	41
4.6.7	TEST RESULTS	41
5.	PHOTOGRAPHS OF THE TEST CONFIGURATION.....	46
6.	INFORMATION ON THE TESTING LABORATORIES	47
7.	APPENDIX A - MODIFICATIONS RECORDERS FOR ENGINEERING CHANGES TO THE EUT BY THE LAB	48



RELEASE CONTROL RECORD

ISSUE NO.	REASON FOR CHANGE	DATE ISSUED
RF120220C10	Original release	Mar. 22, 2012



1. CERTIFICATION

PRODUCT: IEEE 802.11b/g/n/ BT Combo Slim Module
MODEL NO.: AW-NB101
BRAND: AzureWave
APPLICANT: AzureWave Technologies, Inc.
TESTED: Mar. 01 ~ Mar. 20, 2012
TEST SAMPLE: ENGINEERING SAMPLE
STANDARDS: **FCC Part 15, Subpart C (Section 15.247)**
ANSI C63.10-2009

The above equipment (model: AW-NB101) has been tested by **Bureau Veritas Consumer Products Services (H.K.) Ltd., Taoyuan Branch**, and found compliance with the requirement of the above standards. The test record, data evaluation & Equipment Under Test (EUT) configurations represented herein are true and accurate accounts of the measurements of the sample's EMC characteristics under the conditions specified in this report.

PREPARED BY : Andrea Hsia , DATE : Mar. 22, 2012
Andrea Hsia / Specialist

APPROVED BY : Gary Chang , DATE : Mar. 22, 2012
Gary Chang / Technical Manager

2. SUMMARY OF TEST RESULTS

The EUT has been tested according to the following specifications:

APPLIED STANDARD: FCC PART 15, SUBPART C (SECTION 15.247)			
STANDARD SECTION	TEST TYPE	RESULT	REMARK
15.207	AC Power Conducted Emission	PASS	Meet the requirement of limit. Minimum passing margin is -14.58dB at 1.03516MHz.
15.247(d) 15.209	Radiated Emissions	PASS	Meet the requirement of limit. Minimum passing margin is -1.0dB at 3282.50MHz.
15.247(d)	Band Edge Measurement	PASS	Meet the requirement of limit.
15.247(a)(2)	6dB bandwidth	PASS	Meet the requirement of limit.
15.247(b)	Conducted power	PASS	Meet the requirement of limit.
15.247(e)	Power Spectral Density	PASS	Meet the requirement of limit.
15.203	Antenna Requirement	PASS	Antenna connector is IPEX not a standard connector.

2.1 MEASUREMENT UNCERTAINTY

Where relevant, the following measurement uncertainty levels have been estimated for tests performed on the EUT as specified in CISPR 16-4-2:

MEASUREMENT	FREQUENCY	UNCERTAINTY
Conducted emissions	9kHz~30MHz	2.44 dB
Radiated emissions	30MHz ~ 200MHz	3.34 dB
	200MHz ~1000MHz	3.35 dB
	1GHz ~ 18GHz	2.26 dB
	18GHz ~ 40GHz	1.94 dB

This uncertainty represents an expanded uncertainty expressed at approximately the 95% confidence level using a coverage factor of $k = 2$.

3. GENERAL INFORMATION

3.1 GENERAL DESCRIPTION OF EUT

EUT	IEEE 802.11b/g/n/ BT Combo Slim Module
MODEL NO.	AW-NB101
POWER SUPPLY	3.3Vdc
MODULATION TYPE	CCK, DQPSK, DBPSK for DSSS 64QAM, 16QAM, QPSK, BPSK for OFDM
MODULATION TECHNOLOGY	DSSS, OFDM
TRANSFER RATE	802.11b:11.0/ 5.5/ 2.0/ 1.0Mbps 802.11g: 54.0/ 48.0/ 36.0/ 24.0/ 18.0/ 12.0/ 9.0/ 6.0Mbps 802.11n: up to 150.0Mbps
OPERATING FREQUENCY	2412 ~ 2462MHz
NUMBER OF CHANNEL	11 for 802.11b, 802.11g, 802.11n (20MHz) 7 for 802.11n (40MHz)
OUTPUT POWER	209.4mW
ANTENNA TYPE	PIFAntenna with 2.54dBi gain
ANTENNA CONNECTOR	IPEX
DATA CABLE	NA
I/O PORTS	Refer to user's manual
ACCESSORY DEVICES	NA

NOTE:

1. The EUT provides one completed transmitter and one receiver.

MODULATION MODE	TX FUNCTION
802.11b	1TX
802.11g	1TX
802.11n (20MHz)	1TX
802.11n (40MHz)	1TX

2. The above EUT information is declared by manufacturer and for more detailed features description, please refer to the manufacturer's specifications or user's manual.

3.2 DESCRIPTION OF TEST MODES

11 channels are provided for 802.11b, 802.11g and 802.11n (20MHz):

CHANNEL	FREQUENCY	CHANNEL	FREQUENCY
1	2412MHz	7	2442MHz
2	2417MHz	8	2447MHz
3	2422MHz	9	2452MHz
4	2427MHz	10	2457MHz
5	2432MHz	11	2462MHz
6	2437MHz		

7 channels are provided for 802.11n (40MHz):

CHANNEL	FREQUENCY	CHANNEL	FREQUENCY
1	2422MHz	5	2442MHz
2	2427MHz	6	2447MHz
3	2432MHz	7	2452MHz
4	2437MHz		

3.2.1 TEST MODE APPLICABILITY AND TESTED CHANNEL DETAIL

EUT CONFIGURE MODE	APPLICABLE TO				DESCRIPTION
	RE≥1G	RE<1G	PLC	APCM	
-	√	√	√	√	-

Where **RE≥1G**: Radiated Emission above 1GHz **RE<1G**: Radiated Emission below 1GHz
PLC: Power Line Conducted Emission **APCM**: Antenna Port Conducted Measurement

NOTE: The EUT antenna had been pre-tested on the positioned of each 3 axis. The worst case was found when positioned on **X-plane**.

RADIATED EMISSION TEST (ABOVE 1GHz):

- Pre-Scan has been conducted to determine the worst-case mode from all possible combinations between available modulations, data rates and antenna ports (if EUT with antenna diversity architecture).
- Following channel(s) was (were) selected for the final test as listed below.

MODE	AVAILABLE CHANNEL	TESTED CHANNEL	MODULATION TECHNOLOGY	MODULATION TYPE	DATA RATE (Mbps)
802.11b	1 to 11	1, 6, 11	DSSS	DBPSK	1.0
802.11g	1 to 11	1, 6, 11	OFDM	BPSK	6.0
802.11n (20MHz)	1 to 11	1, 6, 11	OFDM	BPSK	6.5
802.11n (40MHz)	1 to 7	1, 4, 7	OFDM	BPSK	13.5

RADIATED EMISSION TEST (BELOW 1GHz):

- Pre-Scan has been conducted to determine the worst-case mode from all possible combinations between available modulations, data rates and antenna ports (if EUT with antenna diversity architecture).
- Following channel(s) was (were) selected for the final test as listed below.

MODE	AVAILABLE CHANNEL	TESTED CHANNEL	MODULATION TECHNOLOGY	MODULATION TYPE	DATA RATE (Mbps)
802.11g	1 to 11	6	OFDM	BPSK	6.0

POWER LINE CONDUCTED EMISSION TEST:

- Pre-Scan has been conducted to determine the worst-case mode from all possible combinations between available modulations, data rates and antenna ports (if EUT with antenna diversity architecture).
- Following channel(s) was (were) selected for the final test as listed below.

MODE	AVAILABLE CHANNEL	TESTED CHANNEL	MODULATION TECHNOLOGY	MODULATION TYPE	DATA RATE (Mbps)
802.11g	1 to 11	6	OFDM	BPSK	6.0



BANDEDGE MEASUREMENT:

- Pre-Scan has been conducted to determine the worst-case mode from all possible combinations between available modulations, data rates and antenna ports (if EUT with antenna diversity architecture).
- Following channel(s) was (were) selected for the final test as listed below.

MODE	AVAILABLE CHANNEL	TESTED CHANNEL	MODULATION TECHNOLOGY	MODULATION TYPE	DATA RATE (Mbps)
802.11b	1 to 11	1, 11	DSSS	DBPSK	1.0
802.11g	1 to 11	1, 11	OFDM	BPSK	6.0
802.11n (20MHz)	1 to 11	1, 11	OFDM	BPSK	6.5
802.11n (40MHz)	1 to 7	1, 7	OFDM	BPSK	13.5

ANTENNA PORT CONDUCTED MEASUREMENT:

- This item includes all test value of each mode, but only includes spectrum plot of worst value of each mode.
- Pre-Scan has been conducted to determine the worst-case mode from all possible combinations between available modulations, data rates and antenna ports (if EUT with antenna diversity architecture).
- Following channel(s) was (were) selected for the final test as listed below.

MODE	AVAILABLE CHANNEL	TESTED CHANNEL	MODULATION TECHNOLOGY	MODULATION TYPE	DATA RATE (Mbps)
802.11b	1 to 11	1, 6, 11	DSSS	DBPSK	1.0
802.11g	1 to 11	1, 6, 11	OFDM	BPSK	6.0
802.11n (20MHz)	1 to 11	1, 6, 11	OFDM	BPSK	6.5
802.11n (40MHz)	1 to 7	1, 4, 7	OFDM	BPSK	13.5

TEST CONDITION:

APPLICABLE TO	ENVIRONMENTAL CONDITIONS	INPUT POWER (SYSTEM)	TESTED BY
RE≥1G	25deg. C, 65%RH	120Vac, 60Hz	Haru Yang
RE<1G	25deg. C, 65%RH	120Vac, 60Hz	Haru Yang
PLC	25deg. C, 68%RH	120Vac, 60Hz	Sun Lin
APCM	23deg. C, 63%RH	120Vac, 60Hz	Brad Wu

3.3 DESCRIPTION OF SUPPORT UNITS

The EUT has been tested as an independent unit together with other necessary accessories or support units. The following support units or accessories were used to form a representative test configuration during the tests.

NO.	PRODUCT	BRAND	MODEL NO.	SERIAL NO.	FCC ID
1	NOTEBOOK	DELL	E5410	1HC2XM1	NA
2	EXTERNAL BOARD	NA	NA	NA	NA

NO.	SIGNAL CABLE DESCRIPTION OF THE ABOVE SUPPORT UNITS
1	NA
2	NA

NOTE:

1. All power cords of the above support units are non shielded (1.8m).
2. Item 2 was supplied from client.

3.3.1 CONFIGURATION OF SYSTEM UNDER TEST

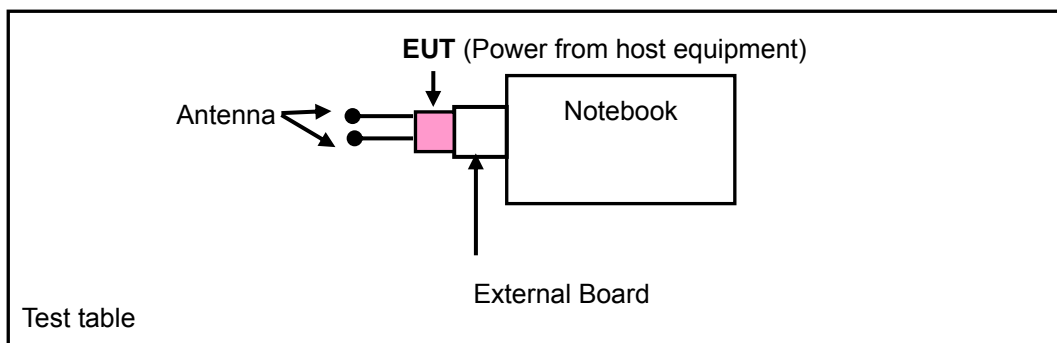

3.4 GENERAL DESCRIPTION OF APPLIED STANDARDS

The EUT is a RF Product. According to the specifications of the manufacturer, it must comply with the requirements of the following standards:

FCC Part 15, Subpart C (15.247)

ANSI C63.10-2009

All test items have been performed and recorded as per the above standards.

NOTE: The EUT is also considered as a kind of computer peripheral, because the connection to computer is necessary for typical use. It has been verified to comply with the requirements of FCC Part 15, Subpart B, Class B (DoC). The test report has been issued separately.

4. TEST TYPES AND RESULTS

4.1 RADIATED EMISSION AND BANDEDGE MEASUREMENT

4.1.1 LIMITS OF RADIATED EMISSION AND BANDEDGE MEASUREMENT

Radiated emissions which fall in the restricted bands must comply with the radiated emission limits specified as below table. Other emissions shall be at least 20dB below the highest level of the desired power:

FREQUENCIES (MHz)	FIELD STRENGTH (microvolts/meter)	MEASUREMENT DISTANCE (meters)
0.009 ~ 0.490	2400/F(kHz)	300
0.490 ~ 1.705	24000/F(kHz)	30
1.705 ~ 30.0	30	30
30 ~ 88	100	3
88 ~ 216	150	3
216 ~ 960	200	3
Above 960	500	3

NOTE:

1. The lower limit shall apply at the transition frequencies.
2. Emission level (dBuV/m) = 20 log Emission level (uV/m).
3. For frequencies above 1000MHz, the field strength limits are based on average detector, however, the peak field strength of any emission shall not exceed the maximum permitted average limits, specified above by more than 20dB under any condition of modulation.



A D T

4.1.2 TEST INSTRUMENTS

DESCRIPTION & MANUFACTURER	MODEL NO.	SERIAL NO.	DATE OF CALIBRATION	DUE DATE OF CALIBRATION
Test Receiver ROHDE & SCHWARZ	ESIB7	100212	Aug. 02, 2011	Aug. 01, 2012
Spectrum Analyzer ROHDE & SCHWARZ	FSP40	100041	Jul. 21, 2011	Jul. 20, 2012
BILOG Antenna SCHWARZBECK	VULB9168	9168-160	Apr. 13, 2011	Apr. 12, 2012
HORN Antenna SCHWARZBECK	9120D	209	Aug. 25, 2011	Aug. 24, 2012
HORN Antenna SCHWARZBECK	BBHA 9170	148	Jul. 20, 2011	Jul. 19, 2012
Preamplifier Agilent	8447D	2944A10633	Oct. 29, 2011	Oct. 28, 2012
Preamplifier Agilent	8449B	3008A01964	Oct. 29, 2011	Oct. 28, 2012
RF signal cable HUBER+SUHNNER	SUCOFLEX 104	250723/4	Aug. 30, 2011	Aug. 29, 2012
RF signal cable HUBER+SUHNNER	SUCOFLEX 106	12738/6+309224/ 4	Aug. 30, 2011	Aug. 29, 2012
Software ADT.	ADT_Radiated_ V7.6.15.9.2	NA	NA	NA
Antenna Tower inn-co GmbH	MA 4000	013303	NA	NA
Antenna Tower Controller inn-co GmbH	CO2000	017303	NA	NA
Turn Table ADT.	TT100	TT93021703	NA	NA
Turn Table Controller ADT.	SC100	SC93021703	NA	NA
High Speed Peak Power Meter	ML2495A	0842014	Apr. 26, 2011	Apr. 25, 2012
Power Sensor	MA2411B	0738404	Apr. 26, 2011	Apr. 25, 2012

- NOTE:**
1. The calibration interval of the above test instruments is 12 months and the calibrations are traceable to NML/ROC and NIST/USA.
 2. The test was performed in HwaYa Chamber 3.
 3. The horn antenna and HP preamplifier (model: 8449B) are used only for the measurement of emission frequency above 1GHz if tested.
 4. The FCC Site Registration No. is 988962.
 5. The IC Site Registration No. is IC 7450F-3.

4.1.3 TEST PROCEDURES

- a. The EUT was placed on the top of a rotating table 0.8 meters above the ground at a 3 meters semi-anechoic chamber. The table was rotated 360 degrees to determine the position of the highest radiation.
- b. The EUT was set 3 meters away from the interference-receiving antenna, which was mounted on the top of a variable-height antenna tower.
- c. Height of receiving antenna is varied from one meter to four meters above the ground to determine the maximum value of the field strength. Both horizontal and vertical polarizations of the antenna are set to make the measurement.
- d. For each suspected emission, the EUT was arranged to its worst case and then the antenna was tuned to heights from 1 meter to 4 meters and the rotatable table was turned from 0 degrees to 360 degrees to find the maximum reading.
- e. The test-receiver system was set to Peak Detect Function and Specified Bandwidth with Maximum Hold Mode.
- f. If the emission level of the EUT in peak mode was lower than the limit specified, then testing could be stopped and the peak values of the EUT would be reported. Otherwise the emissions would be re-tested one by one using peak, quasi-peak or average method as specified and then reported in a data sheet.

NOTE:

1. The resolution bandwidth and video bandwidth of test receiver/spectrum analyzer is 120kHz for Quasi-peak detection at frequency below 1GHz.
2. The resolution bandwidth of test receiver/spectrum analyzer is 1MHz and video bandwidth is 3MHz for Peak detection at frequency above 1GHz.
3. The resolution bandwidth of test receiver/spectrum analyzer is 1MHz and the video bandwidth is 10Hz for Average detection (AV) at frequency above 1GHz.
4. All modes of operation were investigated and the worst-case emissions are reported.

4.1.4 DEVIATION FROM TEST STANDARD

No deviation.

4.1.5 TEST SETUP

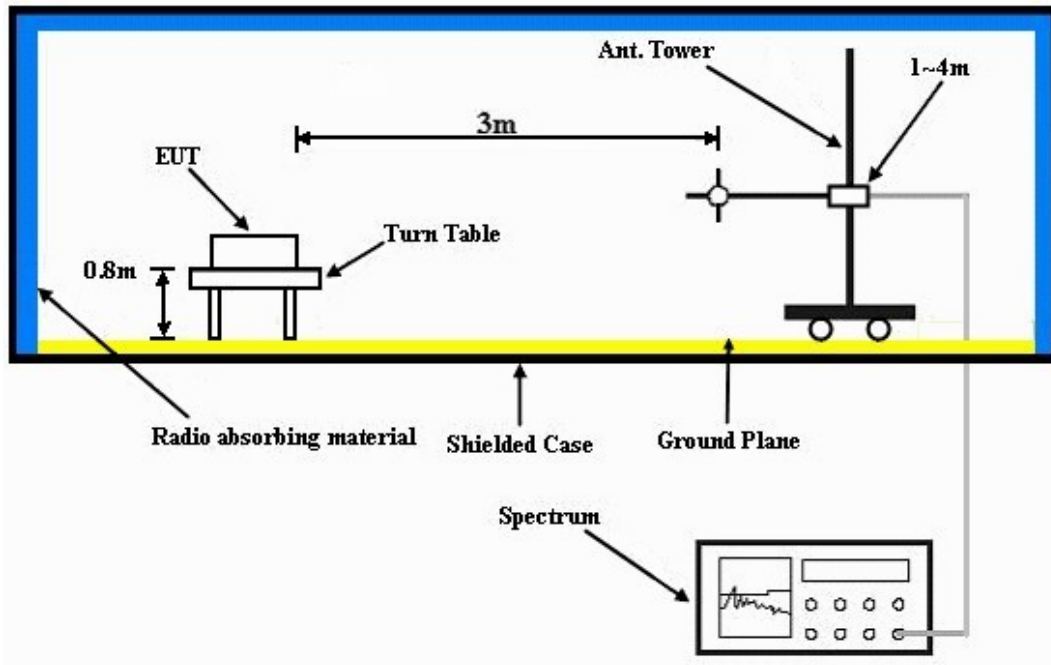

For the actual test configuration, please refer to the attached file (Test Setup Photo).

4.1.6 EUT OPERATING CONDITIONS

- a. Plugged the EUT into notebook via external board and placed them on the testing table.
- b. The notebook system ran a test program (provided by manufacturer) to enable EUT under transmission condition continuously at specific channel frequency.
- c. The necessary accessories enable the system in full functions.



A D T

4.1.7 TEST RESULTS

ABOVE 1GHz DATA : 802.11b

EUT TEST CONDITION		MEASUREMENT DETAIL	
CHANNEL	Channel 1	FREQUENCY RANGE	1 ~ 25GHz
INPUT POWER (SYSTEM)	120Vac, 60 Hz	DETECTOR FUNCTION	Peak (PK) Average (AV)
ENVIRONMENTAL CONDITIONS	25deg. C, 65%RH	TESTED BY	Haru Yang

ANTENNA POLARITY & TEST DISTANCE: HORIZONTAL AT 3 M								
NO.	FREQ. (MHz)	EMISSION LEVEL (dBuV/m)	LIMIT (dBuV/m)	MARGIN (dB)	ANTENNA HEIGHT (m)	TABLE ANGLE (Degree)	RAW VALUE (dBuV)	CORRECTION FACTOR (dB/m)
1	2390.00	56.1 PK	74.0	-17.9	1.06 H	14	24.70	31.40
2	2390.00	45.8 AV	54.0	-8.2	1.06 H	14	14.40	31.40
3	*2412.00	108.3 PK			1.06 H	14	76.90	31.40
4	*2412.00	103.2 AV			1.06 H	14	71.80	31.40
5	3216.00	50.6 PK	74.0	-23.4	1.00 H	178	17.20	33.40
6	3216.00	46.7 AV	54.0	-7.3	1.00 H	178	13.30	33.40
7	4824.00	51.5 PK	74.0	-22.5	1.72 H	345	14.20	37.30
8	4824.00	44.9 AV	54.0	-9.1	1.72 H	345	7.60	37.30
ANTENNA POLARITY & TEST DISTANCE: VERTICAL AT 3 M								
NO.	FREQ. (MHz)	EMISSION LEVEL (dBuV/m)	LIMIT (dBuV/m)	MARGIN (dB)	ANTENNA HEIGHT (m)	TABLE ANGLE (Degree)	RAW VALUE (dBuV)	CORRECTION FACTOR (dB/m)
1	2390.00	55.1 PK	74.0	-18.9	1.01 V	304	23.70	31.40
2	2390.00	44.3 AV	54.0	-9.7	1.01 V	304	12.90	31.40
3	*2412.00	102.3 PK			1.01 V	304	70.90	31.40
4	*2412.00	97.6 AV			1.01 V	304	66.20	31.40
5	3216.00	46.2 PK	74.0	-27.8	1.38 V	19	12.80	33.40
6	3216.00	39.5 AV	54.0	-14.5	1.38 V	19	6.10	33.40
7	4824.00	55.6 PK	74.0	-18.4	1.53 V	74	18.30	37.30
8	4824.00	52.9 AV	54.0	-1.1	1.53 V	74	15.60	37.30

- REMARKS:**
1. Emission level (dBuV/m) = Raw Value (dBuV) + Correction Factor (dB/m).
 2. Correction Factor (dB/m) = Antenna Factor (dB/m) + Cable Factor (dB).
 3. The other emission levels were very low against the limit.
 4. Margin value = Emission level – Limit value.
 5. “ * “: Fundamental frequency.



EUT TEST CONDITION		MEASUREMENT DETAIL	
CHANNEL	Channel 6	FREQUENCY RANGE	1 ~ 25GHz
INPUT POWER (SYSTEM)	120Vac, 60 Hz	DETECTOR FUNCTION	Peak (PK) Average (AV)
ENVIRONMENTAL CONDITIONS	25deg. C, 65%RH	TESTED BY	Haru Yang

ANTENNA POLARITY & TEST DISTANCE: HORIZONTAL AT 3 M								
NO.	FREQ. (MHz)	EMISSION LEVEL (dBuV/m)	LIMIT (dBuV/m)	MARGIN (dB)	ANTENNA HEIGHT (m)	TABLE ANGLE (Degree)	RAW VALUE (dBuV)	CORRECTION FACTOR (dB/m)
1	2390.00	56.8 PK	74.0	-17.2	1.06 H	2	25.40	31.40
2	2390.00	45.0 AV	54.0	-9.0	1.06 H	2	13.60	31.40
3	*2437.00	106.8 PK			1.06 H	2	75.30	31.50
4	*2437.00	102.0 AV			1.06 H	2	70.50	31.50
5	3249.00	51.3 PK	74.0	-22.7	1.00 H	327	17.80	33.50
6	3249.00	47.7 AV	54.0	-6.3	1.00 H	327	14.20	33.50
7	4874.00	51.5 PK	74.0	-22.5	1.76 H	350	14.10	37.40
8	4874.00	46.0 AV	54.0	-8.0	1.76 H	350	8.60	37.40
ANTENNA POLARITY & TEST DISTANCE: VERTICAL AT 3 M								
NO.	FREQ. (MHz)	EMISSION LEVEL (dBuV/m)	LIMIT (dBuV/m)	MARGIN (dB)	ANTENNA HEIGHT (m)	TABLE ANGLE (Degree)	RAW VALUE (dBuV)	CORRECTION FACTOR (dB/m)
1	2390.00	55.3 PK	74.0	-18.7	1.00 V	278	23.90	31.40
2	2390.00	43.8 AV	54.0	-10.2	1.00 V	278	12.40	31.40
3	*2437.00	100.3 PK			1.00 V	278	68.80	31.50
4	*2437.00	96.9 AV			1.00 V	278	65.40	31.50
5	3249.00	49.1 PK	74.0	-24.9	1.42 V	73	15.60	33.50
6	3249.00	43.8 AV	54.0	-10.2	1.42 V	73	10.30	33.50
7	4874.00	55.3 PK	74.0	-18.7	1.48 V	42	17.90	37.40
8	4874.00	52.7 AV	54.0	-1.3	1.48 V	42	15.30	37.40

- REMARKS:**
1. Emission level (dBuV/m) = Raw Value (dBuV) + Correction Factor (dB/m).
 2. Correction Factor (dB/m) = Antenna Factor (dB/m) + Cable Factor (dB).
 3. The other emission levels were very low against the limit.
 4. Margin value = Emission level – Limit value.
 5. “ * “: Fundamental frequency.



A D T

EUT TEST CONDITION		MEASUREMENT DETAIL	
CHANNEL	Channel 11	FREQUENCY RANGE	1 ~ 25GHz
INPUT POWER (SYSTEM)	120Vac, 60 Hz	DETECTOR FUNCTION	Peak (PK) Average (AV)
ENVIRONMENTAL CONDITIONS	25deg. C, 65%RH	TESTED BY	Haru Yang

ANTENNA POLARITY & TEST DISTANCE: HORIZONTAL AT 3 M								
NO.	FREQ. (MHz)	EMISSION LEVEL (dBuV/m)	LIMIT (dBuV/m)	MARGIN (dB)	ANTENNA HEIGHT (m)	TABLE ANGLE (Degree)	RAW VALUE (dBuV)	CORRECTION FACTOR (dB/m)
1	*2462.00	107.3 PK			1.05 H	10	75.70	31.60
2	*2462.00	102.5 AV			1.05 H	10	70.90	31.60
3	2483.50	56.3 PK	74.0	-17.7	1.05 H	10	24.60	31.70
4	2483.50	45.2 AV	54.0	-8.8	1.05 H	10	13.50	31.70
5	3282.50	50.7 PK	74.0	-23.3	1.00 H	21	17.20	33.50
6	3282.50	47.4 AV	54.0	-6.6	1.00 H	21	13.90	33.50
7	4924.00	52.5 PK	74.0	-21.5	1.00 H	37	15.00	37.50
8	4924.00	48.0 AV	54.0	-6.0	1.00 H	37	10.50	37.50
ANTENNA POLARITY & TEST DISTANCE: VERTICAL AT 3 M								
NO.	FREQ. (MHz)	EMISSION LEVEL (dBuV/m)	LIMIT (dBuV/m)	MARGIN (dB)	ANTENNA HEIGHT (m)	TABLE ANGLE (Degree)	RAW VALUE (dBuV)	CORRECTION FACTOR (dB/m)
1	*2462.00	99.8 PK			1.63 V	277	68.20	31.60
2	*2462.00	94.9 AV			1.63 V	277	63.30	31.60
3	2483.50	56.0 PK	74.0	-18.0	1.63 V	277	24.30	31.70
4	2483.50	43.9 AV	54.0	-10.1	1.63 V	277	12.20	31.70
5	3282.50	48.6 PK	74.0	-25.4	1.06 V	356	15.10	33.50
6	3282.50	43.8 AV	54.0	-10.2	1.06 V	356	10.30	33.50
7	4924.00	55.4 PK	74.0	-18.6	1.48 V	42	17.90	37.50
8	4924.00	52.8 AV	54.0	-1.2	1.48 V	42	15.30	37.50

- REMARKS:**
1. Emission level (dBuV/m) = Raw Value (dBuV) + Correction Factor (dB/m).
 2. Correction Factor (dB/m) = Antenna Factor (dB/m) + Cable Factor (dB).
 3. The other emission levels were very low against the limit.
 4. Margin value = Emission level – Limit value.
 5. “ * “: Fundamental frequency.



A D T

802.11g

EUT TEST CONDITION		MEASUREMENT DETAIL	
CHANNEL	Channel 1	FREQUENCY RANGE	1 ~ 25GHz
INPUT POWER (SYSTEM)	120Vac, 60 Hz	DETECTOR FUNCTION	Peak (PK) Average (AV)
ENVIRONMENTAL CONDITIONS	25deg. C, 65%RH	TESTED BY	Haru Yang

ANTENNA POLARITY & TEST DISTANCE: HORIZONTAL AT 3 M								
NO.	FREQ. (MHz)	EMISSION LEVEL (dBuV/m)	LIMIT (dBuV/m)	MARGIN (dB)	ANTENNA HEIGHT (m)	TABLE ANGLE (Degree)	RAW VALUE (dBuV)	CORRECTION FACTOR (dB/m)
1	2390.00	60.8 PK	74.0	-13.2	1.03 H	9	29.40	31.40
2	2390.00	47.0 AV	54.0	-7.0	1.03 H	9	15.60	31.40
3	*2412.00	107.1 PK			1.03 H	9	75.70	31.40
4	*2412.00	97.5 AV			1.03 H	9	66.10	31.40
5	3216.00	51.1 PK	74.0	-22.9	1.17 H	25	17.70	33.40
6	3216.00	48.1 AV	54.0	-5.9	1.17 H	25	14.70	33.40
7	4824.00	47.7 PK	74.0	-26.3	1.72 H	311	10.40	37.30
8	4824.00	34.2 AV	54.0	-19.8	1.72 H	311	-3.10	37.30
ANTENNA POLARITY & TEST DISTANCE: VERTICAL AT 3 M								
NO.	FREQ. (MHz)	EMISSION LEVEL (dBuV/m)	LIMIT (dBuV/m)	MARGIN (dB)	ANTENNA HEIGHT (m)	TABLE ANGLE (Degree)	RAW VALUE (dBuV)	CORRECTION FACTOR (dB/m)
1	2390.00	57.0 PK	74.0	-17.0	1.68 V	279	25.60	31.40
2	2390.00	43.7 AV	54.0	-10.3	1.68 V	279	12.30	31.40
3	*2412.00	100.8 PK			1.68 V	279	69.40	31.40
4	*2412.00	91.1 AV			1.68 V	279	59.70	31.40
5	3216.00	47.0 PK	74.0	-27.0	1.43 V	74	13.60	33.40
6	3216.00	41.7 AV	54.0	-12.3	1.43 V	74	8.30	33.40
7	4824.00	47.1 PK	74.0	-26.9	1.55 V	70	9.80	37.30
8	4824.00	35.0 AV	54.0	-19.0	1.55 V	70	-2.30	37.30

- REMARKS:**
1. Emission level (dBuV/m) = Raw Value (dBuV) + Correction Factor (dB/m).
 2. Correction Factor (dB/m) = Antenna Factor (dB/m) + Cable Factor (dB).
 3. The other emission levels were very low against the limit.
 4. Margin value = Emission level – Limit value.
 5. “ * “: Fundamental frequency.



A D T

EUT TEST CONDITION		MEASUREMENT DETAIL	
CHANNEL	Channel 6	FREQUENCY RANGE	1 ~ 25GHz
INPUT POWER (SYSTEM)	120Vac, 60 Hz	DETECTOR FUNCTION	Peak (PK) Average (AV)
ENVIRONMENTAL CONDITIONS	25deg. C, 65%RH	TESTED BY	Haru Yang

ANTENNA POLARITY & TEST DISTANCE: HORIZONTAL AT 3 M								
NO.	FREQ. (MHz)	EMISSION LEVEL (dBuV/m)	LIMIT (dBuV/m)	MARGIN (dB)	ANTENNA HEIGHT (m)	TABLE ANGLE (Degree)	RAW VALUE (dBuV)	CORRECTION FACTOR (dB/m)
1	2390.00	56.6 PK	74.0	-17.4	1.05 H	11	25.20	31.40
2	2390.00	46.3 AV	54.0	-7.7	1.05 H	11	14.90	31.40
3	*2437.00	107.3 PK			1.05 H	11	75.80	31.50
4	*2437.00	96.3 AV			1.05 H	11	64.80	31.50
5	3294.00	54.6 PK	74.0	-19.4	1.36 H	23	21.10	33.50
6	3294.00	52.4 AV	54.0	-1.6	1.36 H	23	18.90	33.50
7	4874.00	45.7 PK	74.0	-28.3	1.73 H	327	8.30	37.40
8	4874.00	33.4 AV	54.0	-20.6	1.73 H	327	-4.00	37.40
ANTENNA POLARITY & TEST DISTANCE: VERTICAL AT 3 M								
NO.	FREQ. (MHz)	EMISSION LEVEL (dBuV/m)	LIMIT (dBuV/m)	MARGIN (dB)	ANTENNA HEIGHT (m)	TABLE ANGLE (Degree)	RAW VALUE (dBuV)	CORRECTION FACTOR (dB/m)
1	2390.00	54.4 PK	74.0	-19.6	1.00 V	279	23.00	31.40
2	2390.00	43.3 AV	54.0	-10.7	1.00 V	279	11.90	31.40
3	*2437.00	101.3 PK			1.00 V	279	69.80	31.50
4	*2437.00	90.6 AV			1.00 V	279	59.10	31.50
5	3249.00	50.2 PK	74.0	-23.8	1.42 V	75	16.70	33.50
6	3249.00	46.7 AV	54.0	-7.3	1.42 V	75	13.20	33.50
7	4874.00	48.6 PK	74.0	-25.4	1.48 V	64	11.20	37.40
8	4874.00	35.5 AV	54.0	-18.5	1.48 V	64	-1.90	37.40

- REMARKS:**
1. Emission level (dBuV/m) = Raw Value (dBuV) + Correction Factor (dB/m).
 2. Correction Factor (dB/m) = Antenna Factor (dB/m) + Cable Factor (dB).
 3. The other emission levels were very low against the limit.
 4. Margin value = Emission level – Limit value.
 5. “ * “: Fundamental frequency.



A D T

EUT TEST CONDITION		MEASUREMENT DETAIL	
CHANNEL	Channel 11	FREQUENCY RANGE	1 ~ 25GHz
INPUT POWER (SYSTEM)	120Vac, 60 Hz	DETECTOR FUNCTION	Peak (PK) Average (AV)
ENVIRONMENTAL CONDITIONS	25deg. C, 65%RH	TESTED BY	Haru Yang

ANTENNA POLARITY & TEST DISTANCE: HORIZONTAL AT 3 M								
NO.	FREQ. (MHz)	EMISSION LEVEL (dBuV/m)	LIMIT (dBuV/m)	MARGIN (dB)	ANTENNA HEIGHT (m)	TABLE ANGLE (Degree)	RAW VALUE (dBuV)	CORRECTION FACTOR (dB/m)
1	*2462.00	108.0 PK			1.05 H	7	76.40	31.60
2	*2462.00	96.7 AV			1.05 H	7	65.10	31.60
3	2483.50	62.8 PK	74.0	-11.2	1.05 H	7	31.10	31.70
4	2483.50	48.4 AV	54.0	-5.6	1.05 H	7	16.70	31.70
5	3282.50	55.1 PK	74.0	-18.9	1.00 H	0	21.60	33.50
6	3282.50	53.0 AV	54.0	-1.0	1.00 H	0	19.50	33.50
7	4924.00	46.0 PK	74.0	-28.0	1.69 H	299	8.50	37.50
8	4924.00	33.4 AV	54.0	-20.6	1.69 H	299	-4.10	37.50
ANTENNA POLARITY & TEST DISTANCE: VERTICAL AT 3 M								
NO.	FREQ. (MHz)	EMISSION LEVEL (dBuV/m)	LIMIT (dBuV/m)	MARGIN (dB)	ANTENNA HEIGHT (m)	TABLE ANGLE (Degree)	RAW VALUE (dBuV)	CORRECTION FACTOR (dB/m)
1	*2462.00	99.4 PK			1.00 V	286	67.80	31.60
2	*2462.00	88.6 AV			1.00 V	286	57.00	31.60
3	2483.50	54.9 PK	74.0	-19.1	1.00 V	286	23.20	31.70
4	2483.50	44.2 AV	54.0	-9.8	1.00 V	286	12.50	31.70
5	3282.50	50.3 PK	74.0	-23.7	1.35 V	75	16.80	33.50
6	3282.50	47.0 AV	54.0	-7.0	1.35 V	75	13.50	33.50
7	4924.00	47.5 PK	74.0	-26.5	1.52 V	48	10.00	37.50
8	4924.00	34.4 AV	54.0	-19.6	1.52 V	48	-3.10	37.50

- REMARKS:**
1. Emission level (dBuV/m) = Raw Value (dBuV) + Correction Factor (dB/m).
 2. Correction Factor (dB/m) = Antenna Factor (dB/m) + Cable Factor (dB).
 3. The other emission levels were very low against the limit.
 4. Margin value = Emission level – Limit value.
 5. “ * “: Fundamental frequency.



A D T

802.11n (20MHz)

EUT TEST CONDITION		MEASUREMENT DETAIL	
CHANNEL	Channel 1	FREQUENCY RANGE	1 ~ 25GHz
INPUT POWER (SYSTEM)	120Vac, 60 Hz	DETECTOR FUNCTION	Peak (PK) Average (AV)
ENVIRONMENTAL CONDITIONS	25deg. C, 65%RH	TESTED BY	Haru Yang

ANTENNA POLARITY & TEST DISTANCE: HORIZONTAL AT 3 M								
NO.	FREQ. (MHz)	EMISSION LEVEL (dBuV/m)	LIMIT (dBuV/m)	MARGIN (dB)	ANTENNA HEIGHT (m)	TABLE ANGLE (Degree)	RAW VALUE (dBuV)	CORRECTION FACTOR (dB/m)
1	2390.00	56.4 PK	74.0	-17.6	1.06 H	10	25.00	31.40
2	2390.00	45.8 AV	54.0	-8.2	1.06 H	10	14.40	31.40
3	*2412.00	103.6 PK			1.06 H	10	72.20	31.40
4	*2412.00	94.1 AV			1.06 H	10	62.70	31.40
5	3216.00	51.2 PK	74.0	-22.8	1.15 H	26	17.80	33.40
6	3216.00	48.1 AV	54.0	-5.9	1.15 H	26	14.70	33.40
7	4824.00	46.8 PK	74.0	-27.2	1.72 H	322	9.50	37.30
8	4824.00	32.9 AV	54.0	-21.1	1.72 H	322	-4.40	37.30
ANTENNA POLARITY & TEST DISTANCE: VERTICAL AT 3 M								
NO.	FREQ. (MHz)	EMISSION LEVEL (dBuV/m)	LIMIT (dBuV/m)	MARGIN (dB)	ANTENNA HEIGHT (m)	TABLE ANGLE (Degree)	RAW VALUE (dBuV)	CORRECTION FACTOR (dB/m)
1	2390.00	54.8 PK	74.0	-19.2	1.67 V	287	23.40	31.40
2	2390.00	43.8 AV	54.0	-10.2	1.67 V	287	12.40	31.40
3	*2412.00	98.1 PK			1.67 V	287	66.70	31.40
4	*2412.00	88.8 AV			1.67 V	287	57.40	31.40
5	3216.00	47.3 PK	74.0	-26.7	1.44 V	74	13.90	33.40
6	3216.00	41.8 AV	54.0	-12.2	1.44 V	74	8.40	33.40
7	4824.00	47.8 PK	74.0	-26.2	1.51 V	73	10.50	37.30
8	4824.00	34.1 AV	54.0	-19.9	1.51 V	73	-3.20	37.30

- REMARKS:**
1. Emission level (dBuV/m) = Raw Value (dBuV) + Correction Factor (dB/m).
 2. Correction Factor (dB/m) = Antenna Factor (dB/m) + Cable Factor (dB).
 3. The other emission levels were very low against the limit.
 4. Margin value = Emission level – Limit value.
 5. “ * “: Fundamental frequency.



A D T

EUT TEST CONDITION		MEASUREMENT DETAIL	
CHANNEL	Channel 6	FREQUENCY RANGE	1 ~ 25GHz
INPUT POWER (SYSTEM)	120Vac, 60 Hz	DETECTOR FUNCTION	Peak (PK) Average (AV)
ENVIRONMENTAL CONDITIONS	25deg. C, 65%RH	TESTED BY	Haru Yang

ANTENNA POLARITY & TEST DISTANCE: HORIZONTAL AT 3 M								
NO.	FREQ. (MHz)	EMISSION LEVEL (dBuV/m)	LIMIT (dBuV/m)	MARGIN (dB)	ANTENNA HEIGHT (m)	TABLE ANGLE (Degree)	RAW VALUE (dBuV)	CORRECTION FACTOR (dB/m)
1	2390.00	54.8 PK	74.0	-19.2	1.06 H	10	23.40	31.40
2	2390.00	44.5 AV	54.0	-9.5	1.06 H	10	13.10	31.40
3	*2437.00	103.6 PK			1.06 H	10	72.10	31.50
4	*2437.00	93.8 AV			1.06 H	10	62.30	31.50
5	3249.00	54.4 PK	74.0	-19.6	1.37 H	26	20.90	33.50
6	3249.00	52.2 AV	54.0	-1.8	1.37 H	26	18.70	33.50
7	4874.00	46.9 PK	74.0	-27.1	1.75 H	331	9.50	37.40
8	4874.00	32.4 AV	54.0	-21.6	1.75 H	331	-5.00	37.40
ANTENNA POLARITY & TEST DISTANCE: VERTICAL AT 3 M								
NO.	FREQ. (MHz)	EMISSION LEVEL (dBuV/m)	LIMIT (dBuV/m)	MARGIN (dB)	ANTENNA HEIGHT (m)	TABLE ANGLE (Degree)	RAW VALUE (dBuV)	CORRECTION FACTOR (dB/m)
1	2390.00	53.5 PK	74.0	-20.5	1.69 V	264	22.10	31.40
2	2390.00	43.3 AV	54.0	-10.7	1.69 V	264	11.90	31.40
3	*2437.00	97.7 PK			1.69 V	264	66.20	31.50
4	*2437.00	88.5 AV			1.69 V	264	57.00	31.50
5	3249.00	50.6 PK	74.0	-23.4	1.43 V	72	17.10	33.50
6	3249.00	47.0 AV	54.0	-7.0	1.43 V	72	13.50	33.50
7	4874.00	47.1 PK	74.0	-26.9	1.55 V	66	9.70	37.40
8	4874.00	33.2 AV	54.0	-20.8	1.55 V	66	-4.20	37.40

- REMARKS:**
1. Emission level (dBuV/m) = Raw Value (dBuV) + Correction Factor (dB/m).
 2. Correction Factor (dB/m) = Antenna Factor (dB/m) + Cable Factor (dB).
 3. The other emission levels were very low against the limit.
 4. Margin value = Emission level – Limit value.
 5. “ * “: Fundamental frequency.



A D T

EUT TEST CONDITION		MEASUREMENT DETAIL	
CHANNEL	Channel 11	FREQUENCY RANGE	1 ~ 25GHz
INPUT POWER (SYSTEM)	120Vac, 60 Hz	DETECTOR FUNCTION	Peak (PK) Average (AV)
ENVIRONMENTAL CONDITIONS	25deg. C, 65%RH	TESTED BY	Haru Yang

ANTENNA POLARITY & TEST DISTANCE: HORIZONTAL AT 3 M								
NO.	FREQ. (MHz)	EMISSION LEVEL (dBuV/m)	LIMIT (dBuV/m)	MARGIN (dB)	ANTENNA HEIGHT (m)	TABLE ANGLE (Degree)	RAW VALUE (dBuV)	CORRECTION FACTOR (dB/m)
1	*2462.00	104.2 PK			1.04 H	12	72.60	31.60
2	*2462.00	94.1 AV			1.04 H	12	62.50	31.60
3	2483.50	60.7 PK	74.0	-13.3	1.04 H	12	29.00	31.70
4	2483.50	46.5 AV	54.0	-7.5	1.04 H	12	14.80	31.70
5	3282.50	54.8 PK	74.0	-19.2	1.00 H	1	21.30	33.50
6	3282.50	52.7 AV	54.0	-1.3	1.00 H	1	19.20	33.50
7	4924.00	44.6 PK	74.0	-29.4	1.70 H	302	7.10	37.50
8	4924.00	32.4 AV	54.0	-21.6	1.70 H	302	-5.10	37.50
ANTENNA POLARITY & TEST DISTANCE: VERTICAL AT 3 M								
NO.	FREQ. (MHz)	EMISSION LEVEL (dBuV/m)	LIMIT (dBuV/m)	MARGIN (dB)	ANTENNA HEIGHT (m)	TABLE ANGLE (Degree)	RAW VALUE (dBuV)	CORRECTION FACTOR (dB/m)
1	*2462.00	95.7 PK			1.00 V	285	64.10	31.60
2	*2462.00	85.9 AV			1.00 V	285	54.30	31.60
3	2483.50	55.7 PK	74.0	-18.3	1.00 V	285	24.00	31.70
4	2483.50	43.9 AV	54.0	-10.1	1.00 V	285	12.20	31.70
5	3282.50	50.5 PK	74.0	-23.5	1.39 V	75	17.00	33.50
6	3282.50	47.5 AV	54.0	-6.5	1.39 V	75	14.00	33.50
7	4924.00	46.9 PK	74.0	-27.1	1.50 V	44	9.40	37.50
8	4924.00	33.4 AV	54.0	-20.6	1.50 V	44	-4.10	37.50

- REMARKS:**
1. Emission level (dBuV/m) = Raw Value (dBuV) + Correction Factor (dB/m).
 2. Correction Factor (dB/m) = Antenna Factor (dB/m) + Cable Factor (dB).
 3. The other emission levels were very low against the limit.
 4. Margin value = Emission level – Limit value.
 5. “ * “: Fundamental frequency.



A D T

802.11n (40MHz)

EUT TEST CONDITION		MEASUREMENT DETAIL	
CHANNEL	Channel 1	FREQUENCY RANGE	1 ~ 25GHz
INPUT POWER (SYSTEM)	120Vac, 60 Hz	DETECTOR FUNCTION	Peak (PK) Average (AV)
ENVIRONMENTAL CONDITIONS	25deg. C, 65%RH	TESTED BY	Haru Yang

ANTENNA POLARITY & TEST DISTANCE: HORIZONTAL AT 3 M

NO.	FREQ. (MHz)	EMISSION LEVEL (dBuV/m)	LIMIT (dBuV/m)	MARGIN (dB)	ANTENNA HEIGHT (m)	TABLE ANGLE (Degree)	RAW VALUE (dBuV)	CORRECTION FACTOR (dB/m)
1	2390.00	67.4 PK	74.0	-6.6	1.04 H	7	36.00	31.40
2	2390.00	50.8 AV	54.0	-3.2	1.04 H	7	19.40	31.40
3	*2422.00	100.6 PK			1.04 H	7	69.10	31.50
4	*2422.00	92.8 AV			1.04 H	7	61.30	31.50
5	3229.30	52.2 PK	74.0	-21.8	1.00 H	26	18.80	33.40
6	3229.30	50.0 AV	54.0	-4.0	1.00 H	26	16.60	33.40
7	4844.00	45.1 PK	74.0	-28.9	1.75 H	323	7.80	37.30
8	4844.00	33.4 AV	54.0	-20.6	1.75 H	323	-3.90	37.30

ANTENNA POLARITY & TEST DISTANCE: VERTICAL AT 3 M

NO.	FREQ. (MHz)	EMISSION LEVEL (dBuV/m)	LIMIT (dBuV/m)	MARGIN (dB)	ANTENNA HEIGHT (m)	TABLE ANGLE (Degree)	RAW VALUE (dBuV)	CORRECTION FACTOR (dB/m)
1	2390.00	58.4 PK	74.0	-15.6	1.66 V	278	27.00	31.40
2	2390.00	45.7 AV	54.0	-8.3	1.66 V	278	14.30	31.40
3	*2422.00	93.9 PK			1.66 V	278	62.40	31.50
4	*2422.00	86.6 AV			1.66 V	278	55.10	31.50
5	3229.30	48.1 PK	74.0	-25.9	1.44 V	75	14.70	33.40
6	3229.30	43.9 AV	54.0	-10.1	1.44 V	75	10.50	33.40
7	4844.00	45.6 PK	74.0	-28.4	1.53 V	65	8.30	37.30
8	4844.00	33.6 AV	54.0	-20.4	1.53 V	65	-3.70	37.30

- REMARKS:**
1. Emission level (dBuV/m) = Raw Value (dBuV) + Correction Factor (dB/m).
 2. Correction Factor (dB/m) = Antenna Factor (dB/m) + Cable Factor (dB).
 3. The other emission levels were very low against the limit.
 4. Margin value = Emission level – Limit value.
 5. “ * “: Fundamental frequency.



A D T

EUT TEST CONDITION		MEASUREMENT DETAIL	
CHANNEL	Channel 4	FREQUENCY RANGE	1 ~ 25GHz
INPUT POWER (SYSTEM)	120Vac, 60 Hz	DETECTOR FUNCTION	Peak (PK) Average (AV)
ENVIRONMENTAL CONDITIONS	25deg. C, 65%RH	TESTED BY	Haru Yang

ANTENNA POLARITY & TEST DISTANCE: HORIZONTAL AT 3 M								
NO.	FREQ. (MHz)	EMISSION LEVEL (dBuV/m)	LIMIT (dBuV/m)	MARGIN (dB)	ANTENNA HEIGHT (m)	TABLE ANGLE (Degree)	RAW VALUE (dBuV)	CORRECTION FACTOR (dB/m)
1	2390.00	56.3 PK	74.0	-17.7	1.05 H	10	24.90	31.40
2	2390.00	45.6 AV	54.0	-8.4	1.05 H	10	14.20	31.40
3	*2437.00	101.1 PK			1.05 H	10	69.60	31.50
4	*2437.00	92.4 AV			1.05 H	10	60.90	31.50
5	3249.00	54.2 PK	74.0	-19.8	1.35 H	27	20.70	33.50
6	3249.00	52.3 AV	54.0	-1.7	1.35 H	27	18.80	33.50
7	4874.00	46.6 PK	74.0	-27.4	1.70 H	314	9.20	37.40
8	4874.00	33.5 AV	54.0	-20.5	1.70 H	314	-3.90	37.40
ANTENNA POLARITY & TEST DISTANCE: VERTICAL AT 3 M								
NO.	FREQ. (MHz)	EMISSION LEVEL (dBuV/m)	LIMIT (dBuV/m)	MARGIN (dB)	ANTENNA HEIGHT (m)	TABLE ANGLE (Degree)	RAW VALUE (dBuV)	CORRECTION FACTOR (dB/m)
1	2390.00	55.8 PK	74.0	-18.2	1.68 V	261	24.40	31.40
2	2390.00	44.2 AV	54.0	-9.8	1.68 V	261	12.80	31.40
3	*2437.00	94.9 PK			1.68 V	261	63.40	31.50
4	*2437.00	86.1 AV			1.68 V	261	54.60	31.50
5	3249.00	50.5 PK	74.0	-23.5	1.43 V	74	17.00	33.50
6	3249.00	47.1 AV	54.0	-6.9	1.43 V	74	13.60	33.50
7	4874.00	46.3 PK	74.0	-27.7	1.59 V	67	8.90	37.40
8	4874.00	33.4 AV	54.0	-20.6	1.59 V	67	-4.00	37.40

- REMARKS:**
1. Emission level (dBuV/m) = Raw Value (dBuV) + Correction Factor (dB/m).
 2. Correction Factor (dB/m) = Antenna Factor (dB/m) + Cable Factor (dB).
 3. The other emission levels were very low against the limit.
 4. Margin value = Emission level – Limit value.
 5. “ * “: Fundamental frequency.



A D T

EUT TEST CONDITION		MEASUREMENT DETAIL	
CHANNEL	Channel 7	FREQUENCY RANGE	1 ~ 25GHz
INPUT POWER (SYSTEM)	120Vac, 60 Hz	DETECTOR FUNCTION	Peak (PK) Average (AV)
ENVIRONMENTAL CONDITIONS	25deg. C, 65%RH	TESTED BY	Haru Yang

ANTENNA POLARITY & TEST DISTANCE: HORIZONTAL AT 3 M								
NO.	FREQ. (MHz)	EMISSION LEVEL (dBuV/m)	LIMIT (dBuV/m)	MARGIN (dB)	ANTENNA HEIGHT (m)	TABLE ANGLE (Degree)	RAW VALUE (dBuV)	CORRECTION FACTOR (dB/m)
1	*2452.00	100.8 PK			1.04 H	11	69.20	31.60
2	*2452.00	92.3 AV			1.04 H	11	60.70	31.60
3	2483.50	68.4 PK	74.0	-5.6	1.04 H	11	36.70	31.70
4	2483.50	51.8 AV	54.0	-2.2	1.04 H	11	20.10	31.70
5	3269.30	55.5 PK	74.0	-18.5	1.14 H	9	22.00	33.50
6	3269.30	51.4 AV	54.0	-2.6	1.14 H	9	17.90	33.50
7	4904.00	45.6 PK	74.0	-28.4	1.73 H	334	8.20	37.40
8	4904.00	33.4 AV	54.0	-20.6	1.73 H	334	-4.00	37.40
ANTENNA POLARITY & TEST DISTANCE: VERTICAL AT 3 M								
NO.	FREQ. (MHz)	EMISSION LEVEL (dBuV/m)	LIMIT (dBuV/m)	MARGIN (dB)	ANTENNA HEIGHT (m)	TABLE ANGLE (Degree)	RAW VALUE (dBuV)	CORRECTION FACTOR (dB/m)
1	*2452.00	94.9 PK			1.69 V	260	63.30	31.60
2	*2452.00	86.1 AV			1.69 V	260	54.50	31.60
3	2483.50	60.3 PK	74.0	-13.7	1.69 V	260	28.60	31.70
4	2483.50	46.6 AV	54.0	-7.4	1.69 V	260	14.90	31.70
5	3269.30	50.7 PK	74.0	-23.3	1.39 V	74	17.20	33.50
6	3269.30	47.6 AV	54.0	-6.4	1.39 V	74	14.10	33.50
7	4904.00	45.7 PK	74.0	-28.3	1.56 V	48	8.30	37.40
8	4904.00	33.4 AV	54.0	-20.6	1.56 V	48	-4.00	37.40

- REMARKS:**
1. Emission level (dBuV/m) = Raw Value (dBuV) + Correction Factor (dB/m).
 2. Correction Factor (dB/m) = Antenna Factor (dB/m) + Cable Factor (dB).
 3. The other emission levels were very low against the limit.
 4. Margin value = Emission level – Limit value.
 5. “ * “: Fundamental frequency.



A D T

BELOW 1GHz WORST-CASE DATA : 802.11g

EUT TEST CONDITION		MEASUREMENT DETAIL	
CHANNEL	Channel 6	FREQUENCY RANGE	Below 1000MHz
INPUT POWER (SYSTEM)	120Vac, 60 Hz	DETECTOR FUNCTION	Quasi-Peak
ENVIRONMENTAL CONDITIONS	25deg. C, 65%RH	TESTED BY	Haru Yang

ANTENNA POLARITY & TEST DISTANCE: HORIZONTAL AT 3 M								
NO.	FREQ. (MHz)	EMISSION LEVEL (dBuV/m)	LIMIT (dBuV/m)	MARGIN (dB)	ANTENNA HEIGHT (m)	TABLE ANGLE (Degree)	RAW VALUE (dBuV)	CORRECTION FACTOR (dB/m)
1	99.89	29.1 QP	43.5	-14.4	2.00 H	310	19.60	9.50
2	216.00	37.3 QP	43.5	-6.2	1.50 H	10	25.60	11.70
3	300.16	38.8 QP	46.0	-7.2	1.00 H	10	23.80	15.00
4	500.42	34.1 QP	46.0	-11.9	1.75 H	337	14.10	20.00
5	667.63	34.1 QP	46.0	-11.9	1.25 H	232	11.30	22.80
6	696.79	37.3 QP	46.0	-8.7	1.00 H	232	14.30	23.00
ANTENNA POLARITY & TEST DISTANCE: VERTICAL AT 3 M								
NO.	FREQ. (MHz)	EMISSION LEVEL (dBuV/m)	LIMIT (dBuV/m)	MARGIN (dB)	ANTENNA HEIGHT (m)	TABLE ANGLE (Degree)	RAW VALUE (dBuV)	CORRECTION FACTOR (dB/m)
1	31.84	32.5 QP	40.0	-7.5	1.00 V	223	19.90	12.60
2	99.89	30.9 QP	43.5	-12.6	1.00 V	265	21.40	9.50
3	300.16	28.1 QP	46.0	-17.9	1.25 V	307	13.10	15.00
4	432.37	30.7 QP	46.0	-15.3	1.00 V	358	12.30	18.40
5	500.42	30.7 QP	46.0	-15.3	1.75 V	280	10.70	20.00
6	696.79	33.7 QP	46.0	-12.3	2.00 V	286	10.70	23.00

- REMARKS:**
1. Emission level (dBuV/m) = Raw Value (dBuV) + Correction Factor (dB/m).
 2. Correction Factor (dB/m) = Antenna Factor (dB/m) + Cable Factor (dB).
 3. The other emission levels were very low against the limit.
 4. Margin value = Emission level – Limit value.

4.2 CONDUCTED EMISSION MEASUREMENT

4.2.1 LIMITS OF CONDUCTED EMISSION MEASUREMENT

FREQUENCY OF EMISSION (MHz)	CONDUCTED LIMIT (dB μ V)	
	Quasi-peak	Average
0.15 ~ 0.5	66 to 56	56 to 46
0.5 ~ 5	56	46
5 ~ 30	60	50

- NOTE:**
1. The lower limit shall apply at the transition frequencies.
 2. The limit decreases in line with the logarithm of the frequency in the range of 0.15 to 0.50MHz.
 3. All emanations from a class A/B digital device or system, including any network of conductors and apparatus connected thereto, shall not exceed the level of field strengths specified above.

4.2.2 TEST INSTRUMENTS

DESCRIPTION & MANUFACTURER	MODEL NO.	SERIAL NO.	DATE OF CALIBRATION	DUE DATE OF CALIBRATION
Test Receiver ROHDE & SCHWARZ	ESCS30	100289	Nov. 19, 2011	Nov. 18, 2012
RF signal cable Woken	5D-FB	Cable-HYCO2-01	Dec. 22, 2011	Dec. 21, 2012
LISN ROHDE & SCHWARZ	ESH2-Z5	100100	Dec. 30, 2011	Dec. 29, 2012
LISN ROHDE & SCHWARZ	ESH3-Z5	100312	Jul. 07, 2011	Jul. 06, 2012
V-LISN SCHWARZBECK	NNBL 8226-2	8226-142	Jun. 30, 2011	Jun. 29, 2012
LISN ROHDE & SCHWARZ	ENV216	100072	Jun. 10, 2011	Jun. 09, 2012
Software ADT	ADT_Cond_ V7.3.7	NA	NA	NA

- NOTE:**
1. The calibration interval of the above test instruments is 12 months and the calibrations are traceable to NML/ROC and NIST/USA.
 2. The test was performed in HwaYa Shielded Room 2.
 3. The VCCI Site Registration No. is C-2047.

4.2.3 TEST PROCEDURES

- a. The EUT was placed 0.4 meters from the conducting wall of the shielded room with EUT being connected to the power mains through a line impedance stabilization network (LISN). Other support units were connected to the power mains through another LISN. The two LISNs provide 50 ohm/ 50uH of coupling impedance for the measuring instrument.
- b. Both lines of the power mains connected to the EUT were checked for maximum conducted interference.
- c. The frequency range from 150kHz to 30MHz was searched. Emission levels under (Limit - 20dB) was not recorded.

NOTE: All modes of operation were investigated and the worst-case emissions are reported.

4.2.4 DEVIATION FROM TEST STANDARD

No deviation.

4.2.5 TEST SETUP

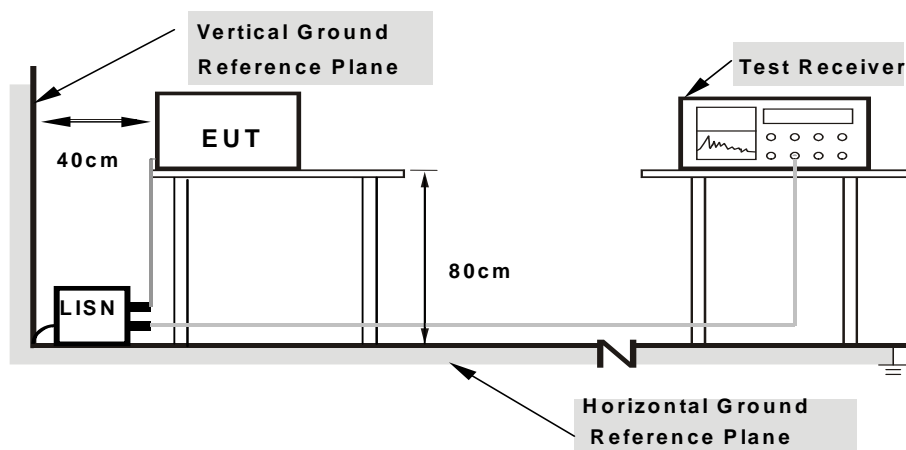

- Note:**
1. Support units were connected to second LISN.
 2. Both of LISNs (AMN) are 80 cm from EUT and at least 80 cm from other units and other metal planes

For the actual test configuration, please refer to the attached file (Test Setup Photo).

4.2.6 EUT OPERATING CONDITIONS

Same as 4.1.6.

4.2.7 TEST RESULTS

CONDUCTED WORST-CASE DATA : 802.11g

PHASE	Line 1	6dB BANDWIDTH	9kHz
-------	--------	---------------	------

No	Freq. [MHz]	Corr. Factor (dB)	Reading Value		Emission Level		Limit		Margin	
			[dB (uV)]		[dB (uV)]		[dB (uV)]		(dB)	
			Q.P.	AV.	Q.P.	AV.	Q.P.	AV.	Q.P.	AV.
1	0.15391	0.15	37.09	26.65	37.24	26.80	65.79	55.79	-28.55	-28.99
2	0.62266	0.18	30.27	23.78	30.45	23.96	56.00	46.00	-25.55	-22.04
3	0.89609	0.19	37.32	28.98	37.51	29.17	56.00	46.00	-18.49	-16.83
4	1.03516	0.19	38.91	31.23	39.10	31.42	56.00	46.00	-16.90	-14.58
5	5.16016	0.36	40.37	32.67	40.73	33.03	60.00	50.00	-19.27	-16.97
6	17.33594	0.58	40.22	32.71	40.80	33.29	60.00	50.00	-19.20	-16.71

- REMARKS:**
1. Q.P. and AV. are abbreviations of quasi-peak and average individually.
 2. "-": The Quasi-peak reading value also meets average limit and measurement with the average detector is unnecessary.
 3. The emission levels of other frequencies were very low against the limit.
 4. Margin value = Emission level - Limit value
 5. Correction factor = Insertion loss + Cable loss
 6. Emission Level = Correction Factor + Reading Value.

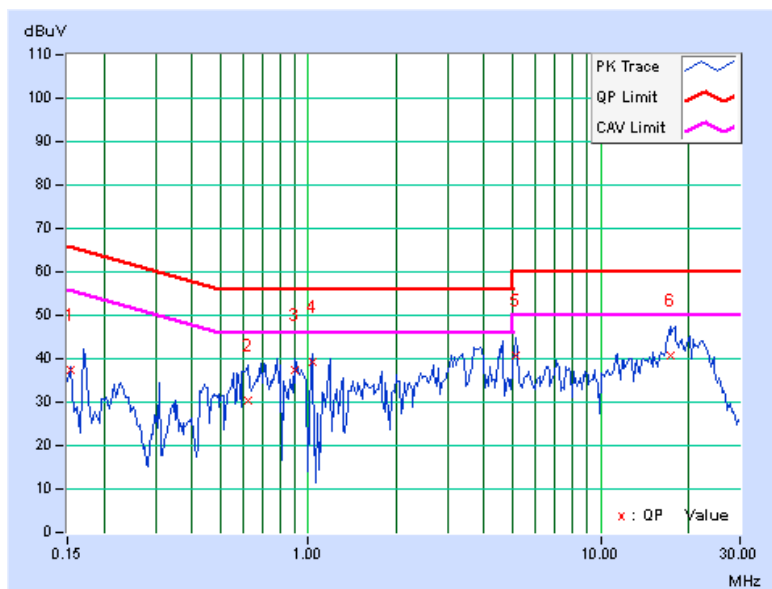



A D T

PHASE	Line 2	6dB BANDWIDTH	9kHz
-------	--------	---------------	------

No	Freq. [MHz]	Corr. Factor (dB)	Reading Value		Emission Level		Limit		Margin	
			[dB (uV)]		[dB (uV)]		[dB (uV)]		(dB)	
			Q.P.	AV.	Q.P.	AV.	Q.P.	AV.	Q.P.	AV.
1	0.15000	0.13	31.32	22.65	31.45	22.78	66.00	56.00	-34.55	-33.22
2	0.51328	0.17	35.32	22.78	35.49	22.95	56.00	46.00	-20.51	-23.05
3	0.88828	0.18	32.62	18.98	32.80	19.16	56.00	46.00	-23.20	-26.84
4	0.98594	0.19	34.65	25.93	34.84	26.12	56.00	46.00	-21.16	-19.88
5	4.60156	0.36	37.95	30.89	38.31	31.25	56.00	46.00	-17.69	-14.75
6	17.53516	0.66	42.32	32.47	42.98	33.13	60.00	50.00	-17.02	-16.87

- REMARKS:**
1. Q.P. and AV. are abbreviations of quasi-peak and average individually.
 2. "-": The Quasi-peak reading value also meets average limit and measurement with the average detector is unnecessary.
 3. The emission levels of other frequencies were very low against the limit.
 4. Margin value = Emission level - Limit value
 5. Correction factor = Insertion loss + Cable loss
 6. Emission Level = Correction Factor + Reading Value.

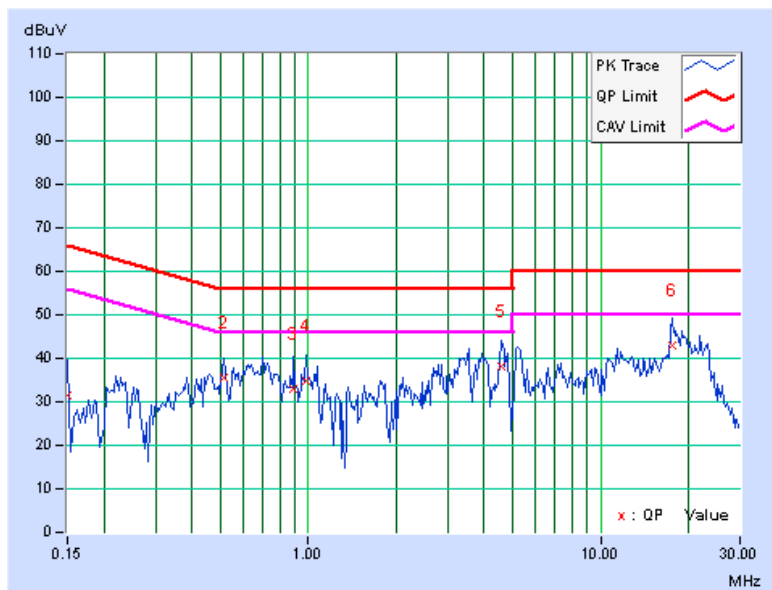

4.3 6dB BANDWIDTH MEASUREMENT

4.3.1 LIMITS OF 6dB BANDWIDTH MEASUREMENT

The minimum of 6dB Bandwidth Measurement is 0.5 MHz.

4.3.2 TEST SETUP

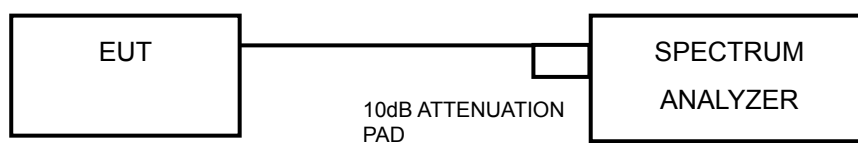

4.3.3 TEST INSTRUMENTS

Refer to section 4.1.2 to get information of above instrument.

4.3.4 TEST PROCEDURE

- a. Set resolution bandwidth (RBW) = approximately 1% of the emission bandwidth
- b. Set the video bandwidth (VBW) $\geq 3 \times$ RBW, Detector = Peak.
- c. Trace mode = max hold.
- d. Sweep = auto couple.
- e. Measure the maximum width of the emission that is constrained by the frequencies associated with the two amplitude points (upper and lower) that are attenuated by 6 dB relative to the maximum level measured in the fundamental emission

4.3.5 DEVIATION FROM TEST STANDARD

No deviation.

4.3.6 EUT OPERATING CONDITIONS

The software provided by client to enable the EUT under transmission condition continuously at lowest, middle and highest channel frequencies individually.

4.3.7 TEST RESULTS

802.11b

CHANNEL	FREQUENCY (MHz)	6dB BANDWIDTH (MHz)	MINIMUM LIMIT (MHz)	PASS / FAIL
1	2412	10.42	0.5	PASS
6	2437	10.41	0.5	PASS
11	2462	10.41	0.5	PASS

802.11g

CHANNEL	FREQUENCY (MHz)	6dB BANDWIDTH (MHz)	MINIMUM LIMIT (MHz)	PASS / FAIL
1	2412	16.16	0.5	PASS
6	2437	16.20	0.5	PASS
11	2462	16.18	0.5	PASS

802.11n (20MHz)

CHANNEL	FREQUENCY (MHz)	6dB BANDWIDTH (MHz)	MINIMUM LIMIT (MHz)	PASS / FAIL
1	2412	17.14	0.5	PASS
6	2437	17.18	0.5	PASS
11	2462	17.22	0.5	PASS

802.11n (40MHz)

CHANNEL	FREQUENCY (MHz)	6dB BANDWIDTH (MHz)	MINIMUM LIMIT (MHz)	PASS / FAIL
1	2422	34.42	0.5	PASS
4	2437	34.43	0.5	PASS
7	2452	34.63	0.5	PASS

4.4 CONDUCTED OUTPUT POWER

4.4.1 LIMITS OF CONDUCTED OUTPUT POWER MEASUREMENT

For systems using digital modulation in the 2400–2483.5 MHz bands: 1 Watt (30dBm)

4.4.2 TEST SETUP

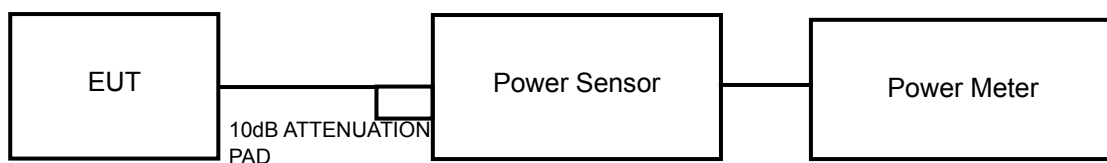

4.4.3 TEST INSTRUMENTS

Refer to section 4.1.2 to get information of above instrument.

4.4.4 TEST PROCEDURES

A peak power sensor was used on the output port of the EUT. A power meter was used to read the response of the peak power sensor. Record the peak power level.

4.4.5 DEVIATION FROM TEST STANDARD

No deviation.

4.4.6 EUT OPERATING CONDITIONS

Same as Item 4.3.6.



4.4.7 TEST RESULTS

802.11b

CHANNEL	FREQUENCY (MHz)	PEAK POWER (mW)	PEAK POWER (dBm)	LIMIT (dBm)	PASS/FAIL
1	2412	116.7	20.67	30	PASS
6	2437	110.9	20.45	30	PASS
11	2462	113.2	20.54	30	PASS

802.11g

CHANNEL	FREQUENCY (MHz)	PEAK POWER (mW)	PEAK POWER (dBm)	LIMIT (dBm)	PASS/FAIL
1	2412	205.1	23.12	30	PASS
6	2437	209.4	23.21	30	PASS
11	2462	201.4	23.04	30	PASS

802.11n (20MHz)

CHANNEL	FREQUENCY (MHz)	PEAK POWER (mW)	PEAK POWER (dBm)	LIMIT (dBm)	PASS/FAIL
1	2412	128.8	21.10	30	PASS
6	2437	132.7	21.23	30	PASS
11	2462	133.7	21.26	30	PASS

802.11n (40MHz)

CHANNEL	FREQUENCY (MHz)	PEAK POWER (mW)	PEAK POWER (dBm)	LIMIT (dBm)	PASS/FAIL
1	2422	122.5	20.88	30	PASS
4	2437	124.2	20.94	30	PASS
7	2452	119.9	20.79	30	PASS

4.5 POWER SPECTRAL DENSITY MEASUREMENT

4.5.1 LIMITS OF POWER SPECTRAL DENSITY MEASUREMENT

The Maximum of Power Spectral Density Measurement is 8dBm.

4.5.2 TEST SETUP

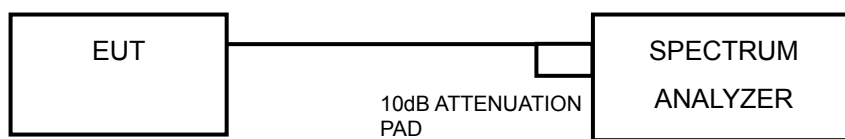

4.5.3 TEST INSTRUMENTS

Refer to section 4.1.2 to get information of above instrument.

4.5.4 TEST PROCEDURE

- a. Set the RBW = 100 kHz, VBW = 300 kHz, Detector = peak.
- b. Sweep time = auto couple, Trace mode = max hold, allow trace to fully stabilize.
- c. Use the peak marker function to determine the maximum power level in any 100 kHz band segment within the fundamental EBW.
- d. Scale the observed power level to an equivalent value in 3 kHz by adjusting (reducing) the measured power by a bandwidth correction factor (BWCF) where $BWCF = 10\log(3\text{ kHz}/100\text{kHz})$

4.5.5 DEVIATION FROM TEST STANDARD

No deviation.

4.5.6 EUT OPERATING CONDITION

Same as Item 4.3.6

4.5.7 TEST RESULTS

802.11b

Channel	FREQ. (MHz)	PSD (dBm/100kHz)	PSD (dBm/3kHz)	Limit (dBm/3kHz)	PASS /FAIL
1	2412	6.16	-9.07	8	PASS
6	2437	5.89	-9.34	8	PASS
11	2462	5.96	-9.27	8	PASS

802.11g

Channel	FREQ. (MHz)	PSD (dBm/100kHz)	PSD (dBm/3kHz)	Limit (dBm/3kHz)	PASS /FAIL
1	2412	2.87	-12.36	8	PASS
6	2437	3.16	-12.07	8	PASS
11	2462	2.73	-12.50	8	PASS

802.11n (20MHz)

Channel	FREQ. (MHz)	PSD (dBm/100kHz)	PSD (dBm/3kHz)	Limit (dBm/3kHz)	PASS /FAIL
1	2412	1.25	-13.98	8	PASS
6	2437	1.34	-13.89	8	PASS
11	2462	1.43	-13.80	8	PASS

802.11n (40MHz)

Channel	FREQ. (MHz)	PSD (dBm/100kHz)	PSD (dBm/3kHz)	Limit (dBm/3kHz)	PASS /FAIL
1	2422	-1.73	-16.96	8	PASS
4	2437	-1.80	-17.03	8	PASS
7	2452	-1.82	-17.05	8	PASS

4.6 CONDUCTED OUT OF BAND EMISSION MEASUREMENT

4.6.1 LIMITS OF CONDUCTED OUT OF BAND EMISSION MEASUREMENT

Below -20dB of the highest emission level of operating band (in 100kHz Resolution Bandwidth).

4.6.2 TEST SETUP

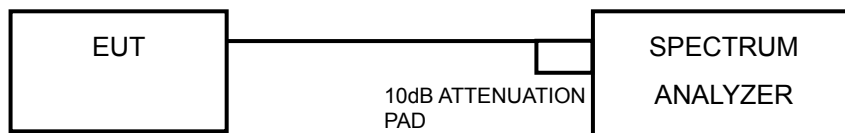

4.6.3 TEST INSTRUMENTS

Refer to section 4.1.2 to get information of above instrument.

4.6.4 TEST PROCEDURE

MEASUREMENT PROCEDURE REF

1. Set the RBW = 100 kHz.
2. Set the VBW \geq 300 kHz.
3. Detector = peak.
4. Sweep time = auto couple.
5. Trace mode = max hold.
6. Allow trace to fully stabilize.
7. Use the peak marker function to determine the maximum power level in any 100 kHz band segment within the fundamental EBW.

MEASUREMENT PROCEDURE OOB

1. Set RBW = 100 kHz.
2. Set VBW \geq 300 kHz.
3. Set span to encompass the spectrum to be examined.
4. Detector = peak.
5. Trace Mode = max hold.
6. Sweep = auto couple.

4.6.5 DEVIATION FROM TEST STANDARD

No deviation.

4.6.6 EUT OPERATING CONDITION

Same as Item 4.3.6

4.6.7 TEST RESULTS

The spectrum plots are attached on the following pages. D1 line indicates the highest level, and D2 line indicates the 20dB offset below D1. It shows compliance with the requirement.

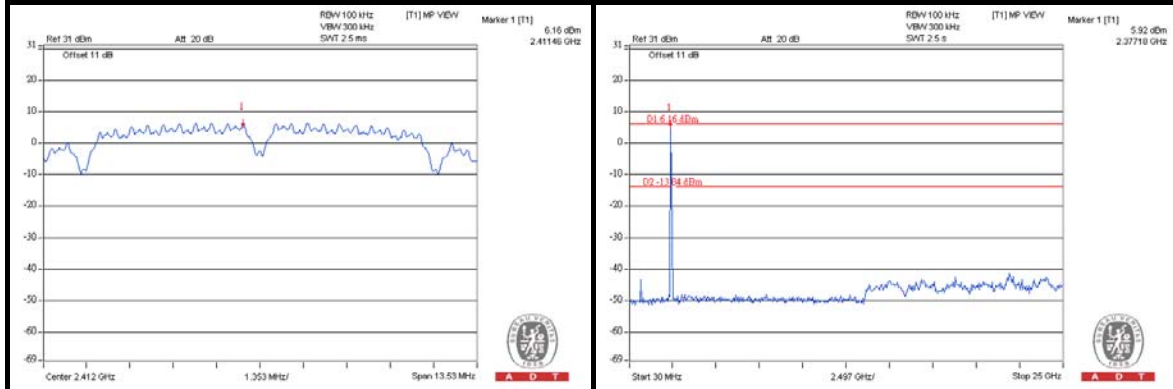
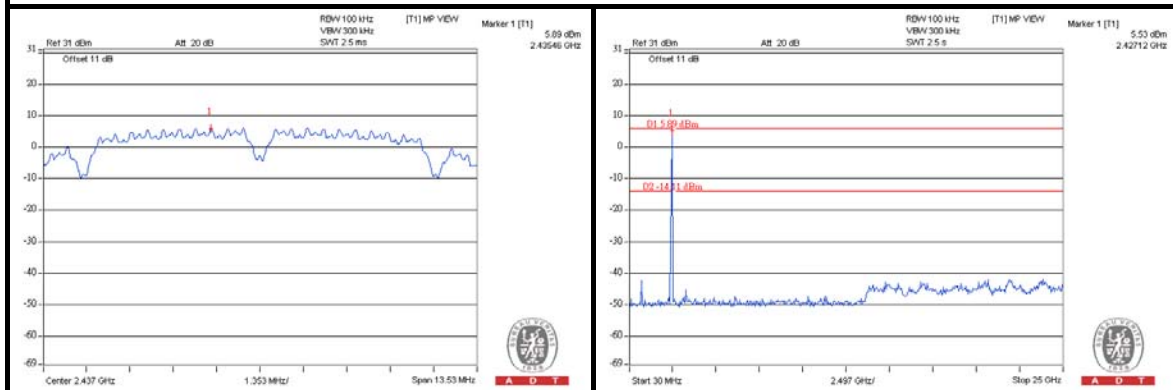
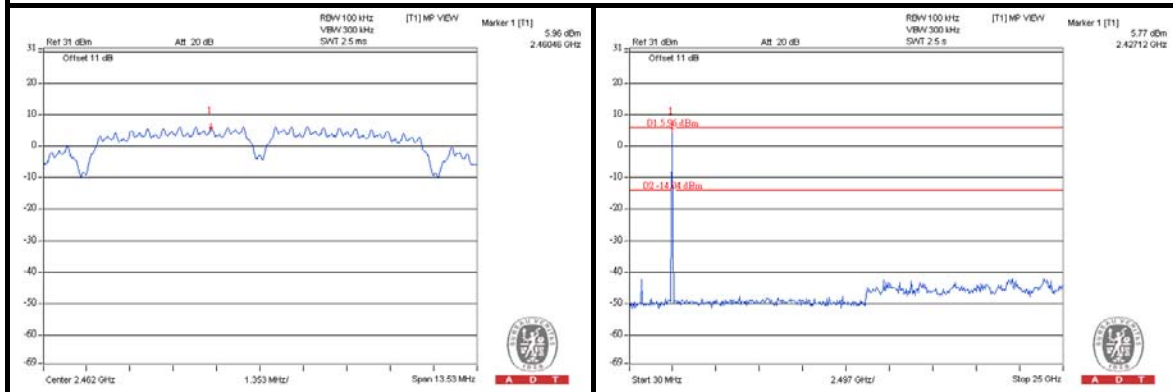
802.11b**CH 1****CH 6****CH 11**

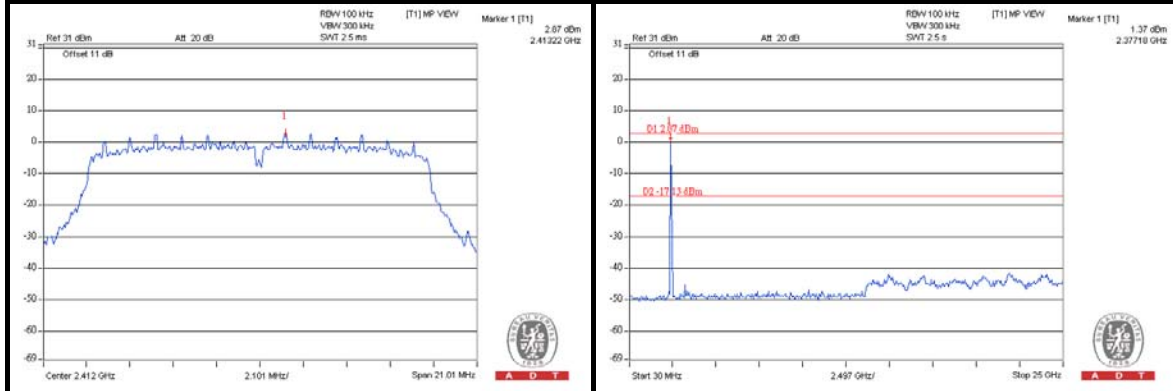
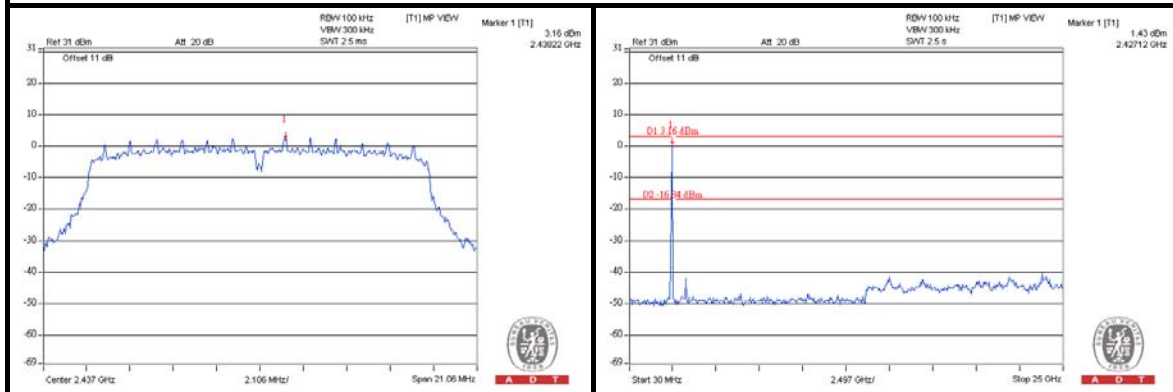
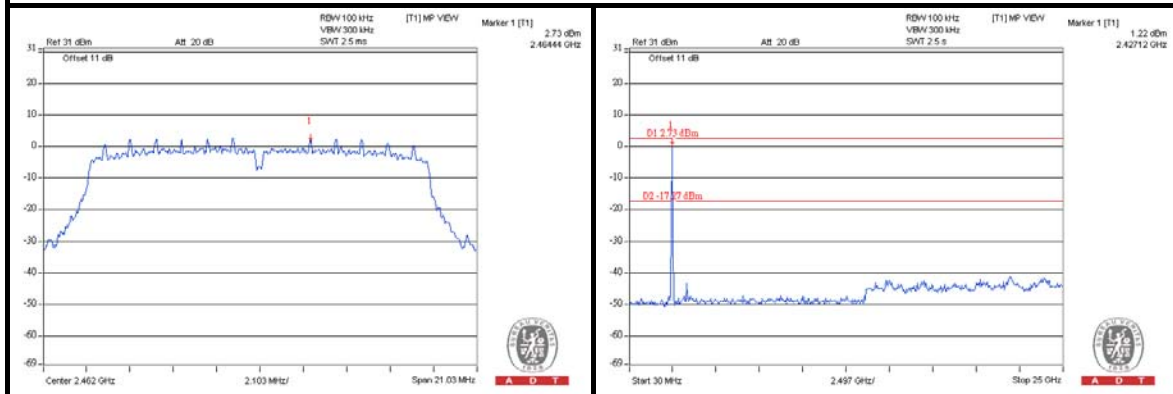
802.11g**CH 1****CH 6****CH 11**

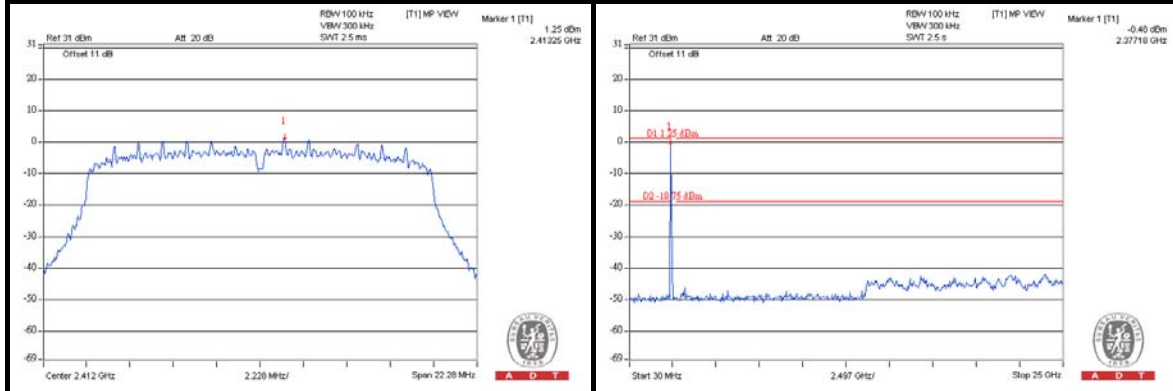
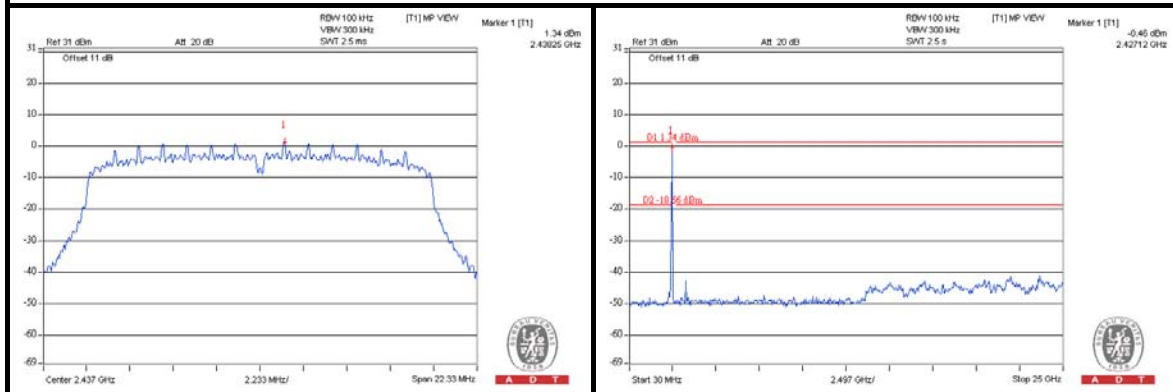
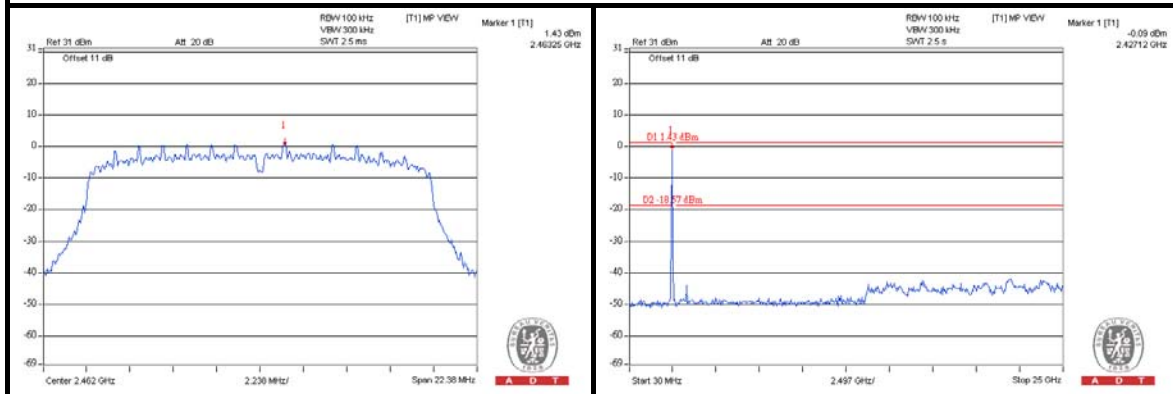
802.11n (20MHz)**CH 1****CH 6****CH 11**

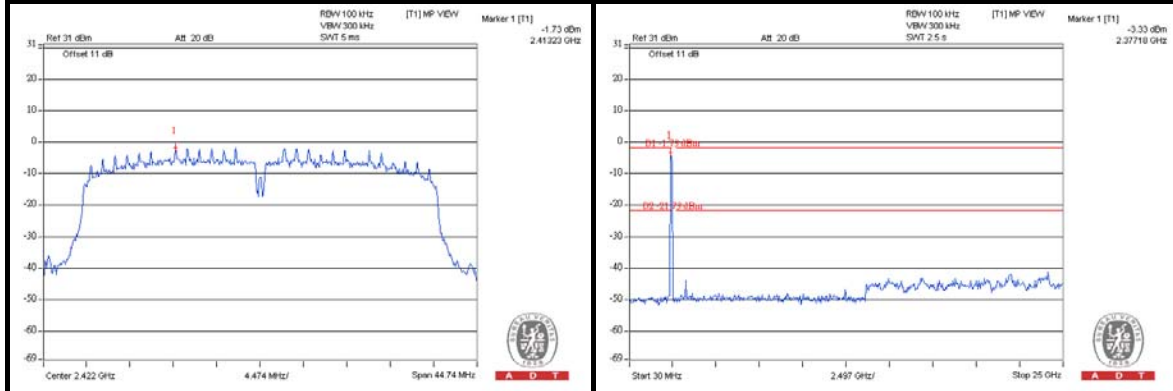
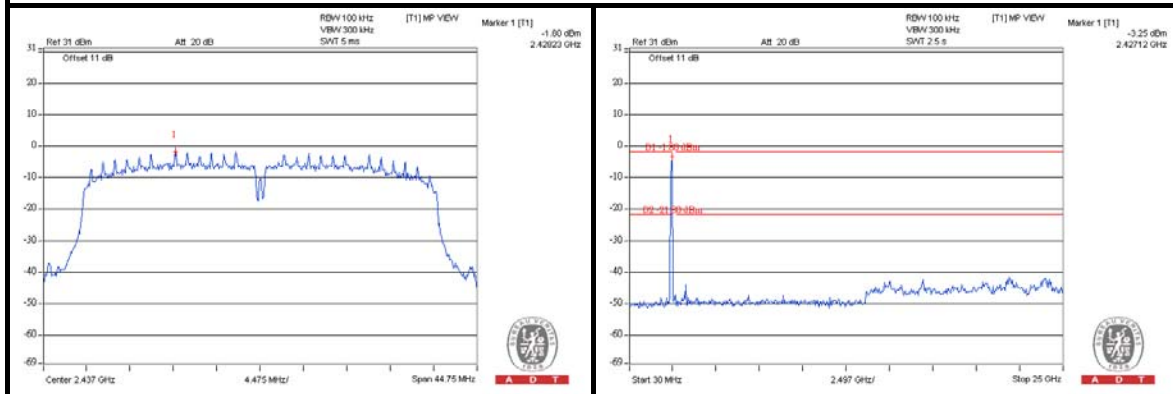
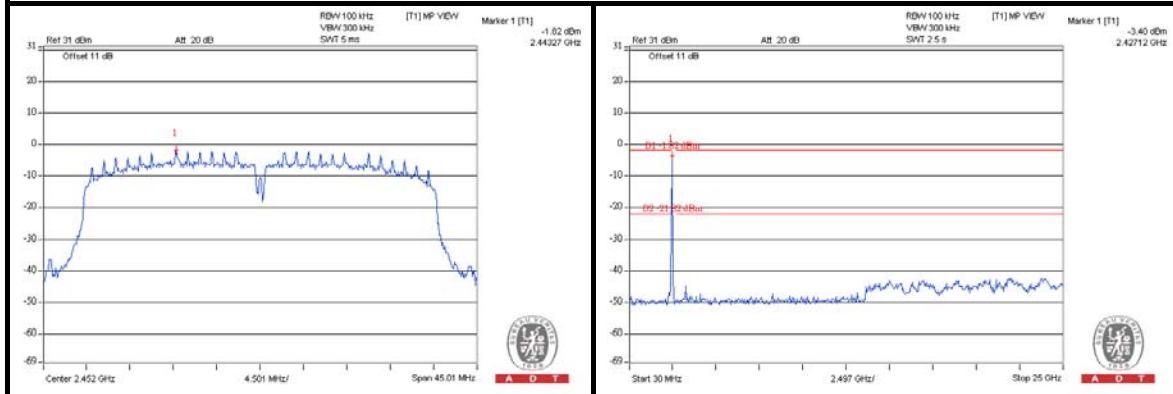
802.11n (40MHz)**CH 1****CH 4****CH 7**



A D T

5. PHOTOGRAPHS OF THE TEST CONFIGURATION

Please refer to the attached file (Test Setup Photo).



6. INFORMATION ON THE TESTING LABORATORIES

We, Bureau Veritas Consumer Products Services (H.K.) Ltd., Taoyuan Branch, were founded in 1988 to provide our best service in EMC, Radio, Telecom and Safety consultation. Our laboratories are accredited and approved according to ISO/IEC 17025.

Copies of accreditation and authorization certificates of our laboratories obtained from approval agencies can be downloaded from our web site: www.adt.com.tw/index.5.phtml. If you have any comments, please feel free to contact us at the following:

Linko EMC/RF Lab:

Tel: 886-2-26052180

Fax: 886-2-26051924

Hsin Chu EMC/RF Lab:

Tel: 886-3-5935343

Fax: 886-3-5935342

Hwa Ya EMC/RF/Safety Telecom Lab:

Tel: 886-3-3183232

Fax: 886-3-3185050

Email: service.adt@tw.bureauveritas.com

Web Site: www.adt.com.tw

The address and road map of all our labs can be found in our web site also.



A D T

7. APPENDIX A - MODIFICATIONS RECORDERS FOR ENGINEERING CHANGES TO THE EUT BY THE LAB

No any modifications are made to the EUT by the lab during the test.

---END---