



FCC TEST REPORT (BLUETOOTH)

REPORT NO.: RF120220C10-1
MODEL NO.: AW-NB101
FCC ID: TLZ-NB101
RECEIVED: Feb. 20, 2012
TESTED: Feb. 29 ~ Mar. 20, 2012
ISSUED: Mar. 22, 2012

APPLICANT: AzureWave Technologies, Inc.

ADDRESS: 8F., No.94, Baozhong Rd., Xindian Dist., New Taipei City 231, Taiwan

ISSUED BY: Bureau Veritas Consumer Products Services (H.K.) Ltd., Taoyuan Branch

LAB ADDRESS: No. 47, 14th Ling, Chia Pau Vil., Lin Kou Dist., New Taipei City, Taiwan (R.O.C.)

TEST LOCATION: No. 19, Hwa Ya 2nd Rd, Wen Hwa Tsuen, Kwei Shan Hsiang, Taoyuan Hsien 333, Taiwan, R.O.C.

This test report consists of 47 pages in total. It may be duplicated completely for legal use with the approval of the applicant. It should not be reproduced except in full, without the written approval of our laboratory. The client should not use it to claim product, certification, approval or endorsement by TAF or any government agency. The test results in the report only apply to the tested sample.





Table of Contents

RELEASE CONTROL RECORD.....	4
1. CERTIFICATION.....	5
1. SUMMARY OF TEST RESULTS	6
2.1 MEASUREMENT UNCERTAINTY.....	6
2. GENERAL INFORMATION.....	7
3.1 GENERAL DESCRIPTION OF EUT	7
3.2 DESCRIPTION OF TEST MODES	8
3.2.1 TEST MODE APPLICABILITY AND TESTED CHANNEL DETAIL	9
3.3 DESCRIPTION OF SUPPORT UNITS	11
3.3.1 CONFIGURATION OF SYSTEM UNDER TEST	11
3.4 GENERAL DESCRIPTION OF APPLIED STANDARDS	12
4. TEST TYPES AND RESULTS	13
4.1 RADIATED EMISSION AND BANDEDGE MEASUREMENT	13
4.1.1 LIMITS OF RADIATED EMISSION AND BANDEDGE MEASUREMENT	13
4.1.2 TEST INSTRUMENTS.....	14
4.1.3 TEST PROCEDURES	15
4.1.4 DEVIATION FROM TEST STANDARD.....	15
4.1.5 TEST SETUP.....	16
4.1.6 EUT OPERATING CONDITIONS	16
4.1.7 TEST RESULTS	17
4.2 CONDUCTED EMISSION MEASUREMENT	24
4.2.1 LIMITS OF CONDUCTED EMISSION MEASUREMENT	24
4.2.2 TEST INSTRUMENTS.....	24
4.2.3 TEST PROCEDURES	25
4.2.4 DEVIATION FROM TEST STANDARD.....	25
4.2.5 TEST SETUP.....	26
4.2.6 EUT OPERATING CONDITIONS	26
4.2.7 TEST RESULTS	27
4.3 NUMBER OF HOPPING FREQUENCY USED	29
4.3.1 LIMIT OF HOPPING FREQUENCY USED.....	29
4.3.2 TEST SETUP.....	29
4.3.3 TEST INSTRUMENTS.....	29
4.3.4 TEST PROCEDURES	29
4.3.5 DEVIATION FROM TEST STANDARD.....	29
4.3.6 TEST RESULTS	29
4.4 DWELL TIME ON EACH CHANNEL	31
4.4.1 LIMIT OF DWELL TIME USED.....	31
4.4.2 TEST SETUP.....	31
4.4.3 TEST INSTRUMENTS.....	31
4.4.4 TEST PROCEDURES	31
4.4.5 DEVIATION FROM TEST STANDARD.....	31
4.4.6 TEST RESULTS	32
4.5 CHANNEL BANDWIDTH.....	36
4.5.1 LIMITS OF CHANNEL BANDWIDTH	36
4.5.2 TEST SETUP.....	36
4.5.3 TEST INSTRUMENTS.....	36
4.5.4 TEST PROCEDURE.....	36



A D T

4.5.5	DEVIATION FROM TEST STANDARD.....	36
4.5.6	EUT OPERATING CONDITION.....	36
4.5.7	TEST RESULTS	37
4.6	HOPPING CHANNEL SEPARATION.....	38
4.6.1	LIMIT OF HOPPING CHANNEL SEPARATION	38
4.6.2	TEST SETUP	38
4.6.3	TEST INSTRUMENTS.....	38
4.6.4	TEST PROCEDURES	38
4.6.5	DEVIATION FROM TEST STANDARD.....	38
4.6.6	TEST RESULTS	39
4.7	MAXIMUM OUTPUT POWER	40
4.7.1	LIMITS OF MAXIMUM OUTPUT POWER MEASUREMENT.....	40
4.7.2	TEST SETUP	40
4.7.3	TEST INSTRUMENTS.....	40
4.7.4	TEST PROCEDURES	40
4.7.5	DEVIATION FROM TEST STANDARD.....	40
4.7.6	EUT OPERATING CONDITION.....	40
4.7.7	TEST RESULTS	41
4.8	CONDUCTED OUT OF BAND EMISSION MEASUREMENT.....	42
4.8.1	LIMITS OF CONDUCTED OUT OF BAND EMISSION MEASUREMENT	42
4.8.2	TEST INSTRUMENTS.....	42
4.8.3	TEST PROCEDURE.....	42
4.8.4	DEVIATION FROM TEST STANDARD.....	42
4.8.5	EUT OPERATING CONDITION.....	42
4.8.6	TEST RESULTS	42
5.	PHOTOGRAPHS OF THE TEST CONFIGURATION.....	45
6.	INFORMATION ON THE TESTING LABORATORIES	46
7.	APPENDIX A - MODIFICATIONS RECORDERS FOR ENGINEERING CHANGES TO THE EUT BY THE LAB	47



RELEASE CONTROL RECORD

ISSUE NO.	REASON FOR CHANGE	DATE ISSUED
RF120220C10-1	Original release	Mar. 22, 2012



1. CERTIFICATION

PRODUCT: IEEE 802.11b/g/n/ BT Combo Slim Module
MODEL NO.: AW-NB101
BRAND: AzureWave
APPLICANT: AzureWave Technologies, Inc.
TESTED: Feb. 29 ~ Mar. 20, 2012
TEST SAMPLE: ENGINEERING SAMPLE
STANDARDS: **FCC Part 15, Subpart C (Section 15.247)**
ANSI C63.10-2009

The above equipment (model: AW-NB101) has been tested by **Bureau Veritas Consumer Products Services (H.K.) Ltd., Taoyuan Branch**, and found compliance with the requirement of the above standards. The test record, data evaluation & Equipment Under Test (EUT) configurations represented herein are true and accurate accounts of the measurements of the sample's EMC characteristics under the conditions specified in this report.

PREPARED BY : Andrea Hsia , DATE : Mar. 22, 2012
Andrea Hsia / Specialist

APPROVED BY : Gary Chang , DATE : Mar. 22, 2012
Gary Chang / Technical Manager

2. SUMMARY OF TEST RESULTS

The EUT has been tested according to the following specifications:

APPLIED STANDARD: FCC Part 15, Subpart C			
STANDARD SECTION	TEST TYPE AND LIMIT	RESULT	REMARK
15.207	AC Power Conducted Emission	PASS	Meet the requirement of limit. Minimum passing margin is -16.60dB at 19.80469MHz.
15.247(a)(1) (iii)	Number of Hopping Frequency Used	PASS	Meet the requirement of limit.
15.247(a)(1) (iii)	Dwell Time on Each Channel	PASS	Meet the requirement of limit.
15.247(a)(1)	1. Hopping Channel Separation 2. Spectrum Bandwidth of a Frequency Hopping Sequence Spread Spectrum System	PASS	Meet the requirement of limit.
15.247(b)	Maximum Peak Output Power	PASS	Meet the requirement of limit.
15.247(d)	Transmitter Radiated Emissions	PASS	Meet the requirement of limit. Minimum passing margin is -1.9dB at 300.16MHz.
15.247(d)	Band Edge Measurement	PASS	Meet the requirement of limit.
15.203	Antenna Requirement	PASS	Antenna connector is IPEX not a standard connector.

NOTE: If The Frequency Hopping System operating in 2400-2483.5MHz band and the output power less than 125mW. The hopping channel carrier frequencies separated by a minimum of 25kHz or two-thirds of the 20dB bandwidth of hopping channel whichever is greater.

2.1 MEASUREMENT UNCERTAINTY

Where relevant, the following measurement uncertainty levels have been estimated for tests performed on the EUT as specified in CISPR 16-4-2:

MEASUREMENT	FREQUENCY	UNCERTAINTY
Conducted emissions	9kHz~30MHz	2.44 dB
Radiated emissions	30MHz ~ 200MHz	3.34 dB
	200MHz ~1000MHz	3.35 dB
	1GHz ~ 18GHz	2.26 dB
	18GHz ~ 40GHz	1.94 dB

This uncertainty represents an expanded uncertainty expressed at approximately the 95% confidence level using a coverage factor of k=2.



A D T

3. GENERAL INFORMATION

3.1 GENERAL DESCRIPTION OF EUT

EUT	IEEE 802.11b/g/n/ BT Combo Slim Module
MODEL NO.	AW-NB101
POWER SUPPLY	3.3Vdc
MODULATION TYPE	GFSK, $\pi/4$ -DQPSK, 8DPSK
MODULATION TECHNOLOGY	FHSS
TRANSFER RATE	1/2/3Mbps
OPERATING FREQUENCY	2402 ~ 2480MHz
NUMBER OF CHANNEL	79
MAX. OUTPUT POWER	7.4mW
ANTENNA TYPE	PIFA antenna with 2.54dBi gain
ANTENNA CONNECTOR	IPEX
DATA CABLE	NA
I/O PORTS	Refer to user's manual
ACCESSORY DEVICES	NA

NOTE:

The above EUT information is declared by manufacturer and for more detailed features description, please refer to the manufacturer's specifications or User's Manual.



3.2 DESCRIPTION OF TEST MODES

79 channels are provided to this EUT:

CHANNEL	FREQ. (MHz)	CHANNEL	FREQ. (MHz)	CHANNEL	FREQ. (MHz)	CHANNEL	FREQ. (MHz)
0	2402	20	2422	40	2442	60	2462
1	2403	21	2423	41	2443	61	2463
2	2404	22	2424	42	2444	62	2464
3	2405	23	2425	43	2445	63	2465
4	2406	24	2426	44	2446	64	2466
5	2407	25	2427	45	2447	65	2467
6	2408	26	2428	46	2448	66	2468
7	2409	27	2429	47	2449	67	2469
8	2410	28	2430	48	2450	68	2470
9	2411	29	2431	49	2451	69	2471
10	2412	30	2432	50	2452	70	2472
11	2413	31	2433	51	2453	71	2473
12	2414	32	2434	52	2454	72	2474
13	2415	33	2435	53	2455	73	2475
14	2416	34	2436	54	2456	74	2476
15	2417	35	2437	55	2457	75	2477
16	2418	36	2438	56	2458	76	2478
17	2419	37	2439	57	2459	77	2479
18	2420	38	2440	58	2460	78	2480
19	2421	39	2441	59	2461		



3.2.1 TEST MODE APPLICABILITY AND TESTED CHANNEL DETAIL

EUT CONFIGURE MODE	APPLICABLE TO				DESCRIPTION
	RE \geq 1G	RE<1G	PLC	APCM	
-	√	√	√	√	-

Where **RE \geq 1G:** Radiated Emission above 1GHz

RE<1G: Radiated Emission below 1GHz

PLC: Power Line Conducted Emission

APCM: Antenna Port Conducted Measurement

NOTE: The EUT antenna had been pre-tested on the positioned of each 3 axis. The worst case was found when positioned on **X-plane**.

RADIATED EMISSION TEST (ABOVE 1 GHz):

- Pre-Scan has been conducted to determine the worst-case mode from all possible combinations between available modulations, antenna ports (if EUT with antenna diversity architecture) and packet type.

- Following channel(s) was (were) selected for the final test as listed below.

AVAILABLE CHANNEL	TESTED CHANNEL	MODULATION TECHNOLOGY	MODULATION TYPE	PACKET TYPE
0 to 78	0,39,78	FHSS	GFSK	DH5
0 to 78	0,39,78	FHSS	8DPSK	DH5

RADIATED EMISSION TEST (BELOW 1 GHz):

- Pre-Scan has been conducted to determine the worst-case mode from all possible combinations between available modulations, antenna ports (if EUT with antenna diversity architecture) and packet type.

- Following channel(s) was (were) selected for the final test as listed below.

AVAILABLE CHANNEL	TESTED CHANNEL	MODULATION TECHNOLOGY	MODULATION TYPE	PACKET TYPE
0 to 78	0	FHSS	8DPSK	DH5

POWER LINE CONDUCTED EMISSION TEST:

- Pre-Scan has been conducted to determine the worst-case mode from all possible combinations between available modulations, data rates and antenna ports (if EUT with antenna diversity architecture).

- Following channel(s) was (were) selected for the final test as listed below.

AVAILABLE CHANNEL	TESTED CHANNEL	MODULATION TECHNOLOGY	MODULATION TYPE	PACKET TYPE
0 to 78	0	FHSS	8DPSK	DH5



BANDEDGE MEASUREMENT:

- Pre-Scan has been conducted to determine the worst-case mode from all possible combinations between available modulations, antenna ports (if EUT with antenna diversity architecture), and packet types.
- Following channel(s) was (were) selected for the final test as listed below.

AVAILABLE CHANNEL	TESTED CHANNEL	MODULATION TECHNOLOGY	MODULATION TYPE	PACKET TYPE
0 to 78	0, 78	FHSS	GFSK	DH5
0 to 78	0, 78	FHSS	8DPSK	DH5

ANTENNA PORT CONDUCTED MEASUREMENT:

- This item includes all test value of each mode, but only includes spectrum plot of worst value of each mode.
- Pre-Scan has been conducted to determine the worst-case mode from all possible combinations between available modulations, antenna ports (if EUT with antenna diversity architecture), and packet types.
- Following channel(s) was (were) selected for the final test as listed below.

AVAILABLE CHANNEL	TESTED CHANNEL	MODULATION TECHNOLOGY	MODULATION TYPE	PACKET TYPE
0 to 78	0, 39, 78	FHSS	GFSK	DH5
0 to 78	0, 39, 78	FHSS	8DPSK	DH5

TEST CONDITION:

APPLICABLE TO	ENVIRONMENTAL CONDITIONS	INPUT POWER (SYSTEM)	TESTED BY
RE≥1G	25deg. C, 65%RH	120Vac, 60Hz	Aska Huang
RE<1G	25deg. C, 65%RH	120Vac, 60Hz	Aska Huang
PLC	25deg. C, 68%RH	120Vac, 60Hz	Sun Lin
APCM	23deg. C, 63%RH	120Vac, 60Hz	Brad Wu

3.3 DESCRIPTION OF SUPPORT UNITS

The EUT has been tested as an independent unit together with other necessary accessories or support units. The following support units or accessories were used to form a representative test configuration during the tests.

NO.	PRODUCT	BRAND	MODEL NO.	SERIAL NO.	FCC ID
1	NOTEBOOK	DELL	E5410	1HC2XM1	NA
2	EXTERNAL BOARD	NA	NA	NA	NA

NO.	SIGNAL CABLE DESCRIPTION OF THE ABOVE SUPPORT UNITS
1	NA
2	NA

NOTE:

1. All power cords of the above support units are non shielded (1.8m).
2. Item 2 was supplied from client.

3.3.1 CONFIGURATION OF SYSTEM UNDER TEST

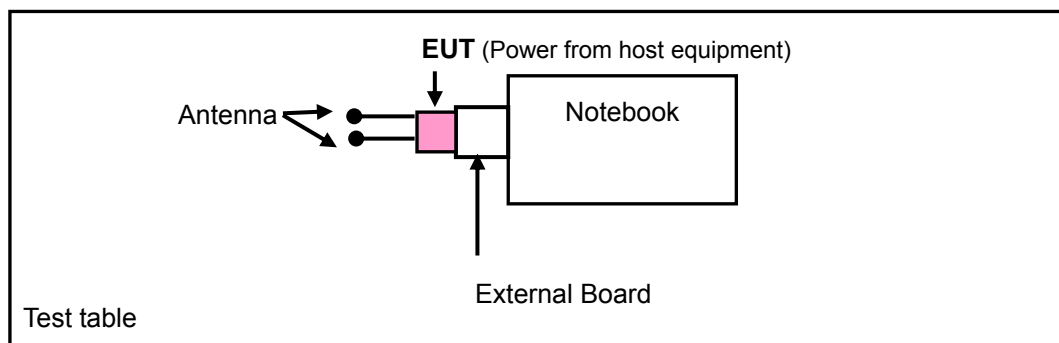



3.4 GENERAL DESCRIPTION OF APPLIED STANDARDS

The EUT is a RF Product. According to the specifications of the manufacturer, it must comply with the requirements of the following standards:

FCC Part 15, Subpart C. (15.247)

ANSI C63.10-2009

All test items have been performed and recorded as per the above standards.

NOTE: The EUT is also considered as a kind of computer peripheral, because the connection to computer is necessary for typical use. It has been verified to comply with the requirements of FCC Part 15, Subpart B, Class B (DoC). The test report has been issued separately.

4. TEST TYPES AND RESULTS

4.1 RADIATED EMISSION AND BANDEGE MEASUREMENT

4.1.1 LIMITS OF RADIATED EMISSION AND BANDEGE MEASUREMENT

Radiated emissions which fall in the restricted bands must comply with the radiated emission limits specified as below table. Other emissions shall be at least 20dB below the highest level of the desired power:

FREQUENCIES (MHz)	FIELD STRENGTH (microvolts/meter)	MEASUREMENT DISTANCE (meters)
0.009 ~ 0.490	2400/F(kHz)	300
0.490 ~ 1.705	24000/F(kHz)	30
1.705 ~ 30.0	30	30
30 ~ 88	100	3
88 ~ 216	150	3
216 ~ 960	200	3
Above 960	500	3

NOTE:

1. The lower limit shall apply at the transition frequencies.
2. Emission level (dBuV/m) = 20 log Emission level (uV/m).
3. For frequencies above 1000MHz, the field strength limits are based on average detector, however, the peak field strength of any emission shall not exceed the maximum permitted average limits, specified above by more than 20dB under any condition of modulation.



4.1.2 TEST INSTRUMENTS

DESCRIPTION & MANUFACTURER	MODEL NO.	SERIAL NO.	DATE OF CALIBRATION	DUE DATE OF CALIBRATION
Test Receiver ROHDE & SCHWARZ	ESIB7	100212	Aug. 02, 2011	Aug. 01, 2012
Spectrum Analyzer ROHDE & SCHWARZ	FSP40	100041	Jul. 21, 2011	Jul. 20, 2012
BILOG Antenna SCHWARZBECK	VULB9168	9168-160	Apr. 13, 2011	Apr. 12, 2012
HORN Antenna SCHWARZBECK	9120D	209	Aug. 25, 2011	Aug. 24, 2012
HORN Antenna SCHWARZBECK	BBHA 9170	148	Jul. 20, 2011	Jul. 19, 2012
Preamplifier Agilent	8447D	2944A10633	Oct. 29, 2011	Oct. 28, 2012
Preamplifier Agilent	8449B	3008A01964	Oct. 29, 2011	Oct. 28, 2012
RF signal cable HUBER+SUHNNER	SUCOFLEX 104	250723/4	Aug. 30, 2011	Aug. 29, 2012
RF signal cable HUBER+SUHNNER	SUCOFLEX 106	12738/6+309224/ 4	Aug. 30, 2011	Aug. 29, 2012
Software ADT.	ADT_Radiated_ V7.6.15.9.2	NA	NA	NA
Antenna Tower inn-co GmbH	MA 4000	013303	NA	NA
Antenna Tower Controller inn-co GmbH	CO2000	017303	NA	NA
Turn Table ADT.	TT100	TT93021703	NA	NA
Turn Table Controller ADT.	SC100	SC93021703	NA	NA
High Speed Peak Power Meter	ML2495A	0842014	Apr. 26, 2011	Apr. 25, 2012
Power Sensor	MA2411B	0738404	Apr. 26, 2011	Apr. 25, 2012

- NOTE:** 1. The calibration interval of the above test instruments is 12 months and the calibrations are traceable to NML/ROC and NIST/USA.
2. The test was performed in HwaYa Chamber 3.
3. The horn antenna and HP preamplifier (model: 8449B) are used only for the measurement of emission frequency above 1GHz if tested.
4. The FCC Site Registration No. is 988962.
5. The IC Site Registration No. is IC 7450F-3.

4.1.3 TEST PROCEDURES

- a. The EUT was placed on the top of a rotating table 0.8 meters above the ground at a 3 meter semi-anechoic chamber. The table was rotated 360 degrees to determine the position of the highest radiation.
- b. The EUT was set 3 meters away from the interference-receiving antenna, which was mounted on the top of a variable-height antenna tower.
- c. The antenna is a broadband antenna, and its height is varied from one meter to four meters above the ground to determine the maximum value of the field strength. Both horizontal and vertical polarizations of the antenna are set to make the measurement.
- d. For each suspected emission, the EUT was arranged to its worst case and then the antenna was tuned to heights from 1 meter to 4 meters and the rotatable table was turned from 0 degrees to 360 degrees to find the maximum reading.
- e. The test-receiver system was set to Peak Detect Function and Specified Bandwidth with Maximum Hold Mode.
- f. If the emission level of the EUT in peak mode was lower than the limit specified, then testing could be stopped and the peak values of the EUT would be reported. Otherwise the emissions would be re-tested one by one using peak, quasi-peak or average method as specified and then reported in a data sheet.

NOTE:

1. The resolution bandwidth and video bandwidth of test receiver/spectrum analyzer is 120kHz for Quasi-peak detection at frequency below 1GHz.
2. The resolution bandwidth of test receiver/spectrum analyzer is 1 MHz and video bandwidth is 3MHz for Peak detection at frequency above 1GHz.
3. All modes of operation were investigated and the worst-case emissions are reported.

4.1.4 DEVIATION FROM TEST STANDARD

No deviation.

4.1.5 TEST SETUP

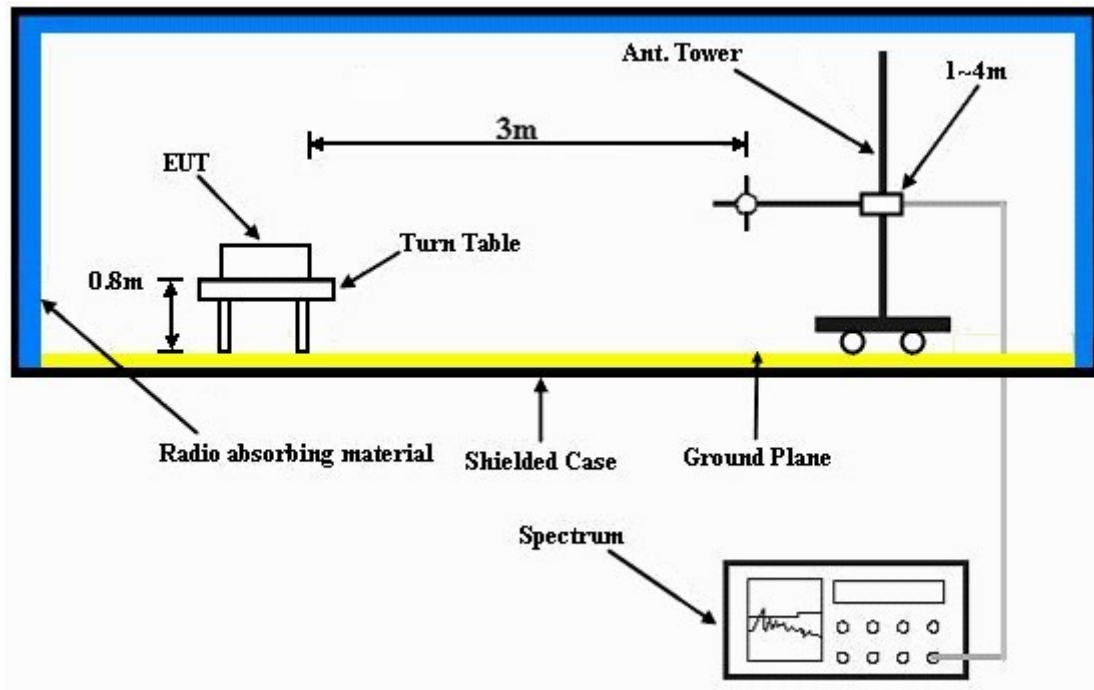

For the actual test configuration, please refer to the attached file (Test Setup Photo).

4.1.6 EUT OPERATING CONDITIONS

- a. Plugged the EUT into notebook via external board and placed them on the testing table.
- b. The notebook system ran a test program (provided by manufacturer) to enable EUT under transmission condition continuously at specific channel frequency.
- c. The necessary accessories enable the system in full functions.



A D T

4.1.7 TEST RESULTS

ABOVE 1GHz DATA : GFSK

EUT TEST CONDITION		MEASUREMENT DETAIL	
CHANNEL	Channel 0	FREQUENCY RANGE	1 ~ 25GHz
INPUT POWER (SYSTEM)	120Vac, 60 Hz	DETECTOR FUNCTION	Peak (PK) Average (AV)
ENVIRONMENTAL CONDITIONS	25deg. C, 65%RH	TESTED BY	Aska Huang

ANTENNA POLARITY & TEST DISTANCE: HORIZONTAL AT 3 M								
NO.	FREQ. (MHz)	EMISSION LEVEL (dBuV/m)	LIMIT (dBuV/m)	MARGIN (dB)	ANTENNA HEIGHT (m)	TABLE ANGLE (Degree)	RAW VALUE (dBuV)	CORRECTION FACTOR (dB/m)
1	2390.00	47.5 PK	74.0	-26.5	1.09 H	187	16.20	31.30
2	2390.00	38.0 AV	54.0	-16.0	1.09 H	187	6.70	31.30
3	2398.00	55.4 PK	74.0	-18.6	1.09 H	187	24.10	31.30
4	2398.00	41.8 AV	54.0	-12.2	1.09 H	187	10.50	31.30
5	2400.00	45.6 PK	74.0	-28.4	1.09 H	187	14.30	31.30
6	2400.00	15.5 AV	54.0	-38.5	1.09 H	187	-15.80	31.30
7	*2402.00	102.3 PK			1.09 H	187	71.00	31.30
8	*2402.00	72.2 AV			1.09 H	187	40.90	31.30
9	4804.00	46.4 PK	74.0	-27.6	1.00 H	255	9.20	37.20
10	4804.00	16.3 AV	54.0	-37.7	1.00 H	255	-20.90	37.20
ANTENNA POLARITY & TEST DISTANCE: VERTICAL AT 3 M								
NO.	FREQ. (MHz)	EMISSION LEVEL (dBuV/m)	LIMIT (dBuV/m)	MARGIN (dB)	ANTENNA HEIGHT (m)	TABLE ANGLE (Degree)	RAW VALUE (dBuV)	CORRECTION FACTOR (dB/m)
1	2390.00	42.4 PK	74.0	-31.6	1.05 V	78	11.10	31.30
2	2390.00	31.7 AV	54.0	-22.3	1.05 V	78	0.40	31.30
3	2398.00	47.8 PK	74.0	-26.2	1.05 V	78	16.50	31.30
4	2398.00	36.1 AV	54.0	-17.9	1.05 V	78	4.80	31.30
5	2400.00	41.1 PK	74.0	-32.9	1.05 V	78	9.80	31.30
6	2400.00	11.0 AV	54.0	-43.0	1.05 V	78	-20.30	31.30
7	*2402.00	97.1 PK			1.05 V	78	65.80	31.30
8	*2402.00	67.0 AV			1.05 V	78	35.70	31.30
9	4804.00	46.5 PK	74.0	-27.5	1.00 V	83	9.30	37.20
10	4804.00	16.4 AV	54.0	-37.6	1.00 V	83	-20.80	37.20

REMARKS: 1. Emission level (dBuV/m) = Raw Value (dBuV) + Correction Factor (dB/m).

2. Correction Factor (dB/m) = Antenna Factor (dB/m) + Cable Factor (dB).

3. The other emission levels were very low against the limit.

4. Margin value = Emission level – Limit value.

5. “ * “: Fundamental frequency.

6. The DH5 packet was the worse case duty cycle for a transmit dwell time on a channel, based upon bluetooth theory the transmitter is on $0.625 * 5$ per 296.25 ms per channel. Therefore, the duty cycle correlation factor be equal to: $20\log(3.125 / 100) = -30.1$ dB.

7. Average value = peak reading + $20\log(\text{duty cycle})$.



A D T

EUT TEST CONDITION		MEASUREMENT DETAIL	
CHANNEL	Channel 39	FREQUENCY RANGE	1 ~ 25GHz
INPUT POWER (SYSTEM)	120Vac, 60 Hz	DETECTOR FUNCTION	Peak (PK) Average (AV)
ENVIRONMENTAL CONDITIONS	25deg. C, 65%RH	TESTED BY	Aska Huang

ANTENNA POLARITY & TEST DISTANCE: HORIZONTAL AT 3 M								
NO.	FREQ. (MHz)	EMISSION LEVEL (dBuV/m)	LIMIT (dBuV/m)	MARGIN (dB)	ANTENNA HEIGHT (m)	TABLE ANGLE (Degree)	RAW VALUE (dBuV)	CORRECTION FACTOR (dB/m)
1	*2441.00	102.3 PK			1.09 H	191	70.80	31.50
2	*2441.00	72.2 AV			1.09 H	191	40.70	31.50
3	4882.00	45.4 PK	74.0	-28.6	1.00 H	151	8.10	37.30
4	4882.00	15.3 AV	54.0	-38.7	1.00 H	151	-22.00	37.30
5	7323.00	51.8 PK	74.0	-22.2	1.00 H	241	8.20	43.60
6	7323.00	21.7 AV	54.0	-32.3	1.00 H	241	-21.90	43.60
ANTENNA POLARITY & TEST DISTANCE: VERTICAL AT 3 M								
NO.	FREQ. (MHz)	EMISSION LEVEL (dBuV/m)	LIMIT (dBuV/m)	MARGIN (dB)	ANTENNA HEIGHT (m)	TABLE ANGLE (Degree)	RAW VALUE (dBuV)	CORRECTION FACTOR (dB/m)
1	*2441.00	97.4 PK			1.04 V	77	65.90	31.50
2	*2441.00	67.3 AV			1.04 V	77	35.80	31.50
3	4882.00	47.2 PK	74.0	-26.8	1.00 V	91	9.90	37.30
4	4882.00	17.1 AV	54.0	-36.9	1.00 V	91	-20.20	37.30
5	7323.00	50.7 PK	74.0	-23.3	1.00 V	59	7.10	43.60
6	7323.00	20.6 AV	54.0	-33.4	1.00 V	59	-23.00	43.60

- REMARKS:**
1. Emission level (dBuV/m) = Raw Value (dBuV) + Correction Factor (dB/m).
 2. Correction Factor (dB/m) = Antenna Factor (dB/m) + Cable Factor (dB).
 3. The other emission levels were very low against the limit.
 4. Margin value = Emission level – Limit value.
 5. “ * “: Fundamental frequency.
 6. The DH5 packet was the worse case duty cycle for a transmit dwell time on a channel, based upon bluetooth theory the transmitter is on 0.625 * 5 per 296.25 ms per channel. Therefore, the duty cycle correlation factor be equal to: $20\log(3.125 / 100) = -30.1$ dB.
 7. Average value = peak reading + $20\log(\text{duty cycle})$.



A D T

EUT TEST CONDITION		MEASUREMENT DETAIL	
CHANNEL	Channel 78	FREQUENCY RANGE	1 ~ 25GHz
INPUT POWER (SYSTEM)	120Vac, 60 Hz	DETECTOR FUNCTION	Peak (PK) Average (AV)
ENVIRONMENTAL CONDITIONS	25deg. C, 65%RH	TESTED BY	Aska Huang

ANTENNA POLARITY & TEST DISTANCE: HORIZONTAL AT 3 M

NO.	FREQ. (MHz)	EMISSION LEVEL (dBuV/m)	LIMIT (dBuV/m)	MARGIN (dB)	ANTENNA HEIGHT (m)	TABLE ANGLE (Degree)	RAW VALUE (dBuV)	CORRECTION FACTOR (dB/m)
1	*2480.00	101.2 PK			1.31 H	195	69.60	31.60
2	*2480.00	71.1 AV			1.31 H	195	39.50	31.60
3	2483.50	44.3 PK	74.0	-29.7	1.31 H	195	12.70	31.60
4	2483.50	14.2 AV	54.0	-39.8	1.31 H	195	-17.40	31.60
5	2485.50	50.6 PK	74.0	-23.4	1.31 H	195	19.00	31.60
6	2485.50	38.4 AV	54.0	-15.6	1.31 H	195	6.80	31.60
7	4960.00	46.5 PK	74.0	-27.5	1.00 H	139	9.00	37.50
8	4960.00	16.4 AV	54.0	-37.6	1.00 H	139	-21.10	37.50

ANTENNA POLARITY & TEST DISTANCE: VERTICAL AT 3 M

NO.	FREQ. (MHz)	EMISSION LEVEL (dBuV/m)	LIMIT (dBuV/m)	MARGIN (dB)	ANTENNA HEIGHT (m)	TABLE ANGLE (Degree)	RAW VALUE (dBuV)	CORRECTION FACTOR (dB/m)
1	*2480.00	96.8 PK			1.05 V	71	65.20	31.60
2	*2480.00	66.7 AV			1.05 V	71	35.10	31.60
3	2483.50	40.8 PK	74.0	-33.2	1.05 V	76	9.20	31.60
4	2483.50	10.7 AV	54.0	-43.3	1.05 V	76	-20.90	31.60
5	2485.50	47.2 PK	74.0	-26.8	1.05 V	71	15.60	31.60
6	2485.50	34.9 AV	54.0	-19.1	1.05 V	71	3.30	31.60
7	4960.00	45.4 PK	74.0	-28.6	1.00 V	95	7.90	37.50
8	4960.00	15.3 AV	54.0	-38.7	1.00 V	95	-22.20	37.50

- REMARKS:**
1. Emission level (dBuV/m) = Raw Value (dBuV) + Correction Factor (dB/m).
 2. Correction Factor (dB/m) = Antenna Factor (dB/m) + Cable Factor (dB).
 3. The other emission levels were very low against the limit.
 4. Margin value = Emission level – Limit value.
 5. “ * “: Fundamental frequency.
 6. The DH5 packet was the worse case duty cycle for a transmit dwell time on a channel, based upon bluetooth theory the transmitter is on 0.625 * 5 per 296.25 ms per channel. Therefore, the duty cycle correlation factor be equal to: $20\log(3.125 / 100) = -30.1$ dB.
 7. Average value = peak reading + $20\log(\text{duty cycle})$.



A D T

8DPSK

EUT TEST CONDITION		MEASUREMENT DETAIL	
CHANNEL	Channel 0	FREQUENCY RANGE	1 ~ 25GHz
INPUT POWER (SYSTEM)	120Vac, 60 Hz	DETECTOR FUNCTION	Peak (PK) Average (AV)
ENVIRONMENTAL CONDITIONS	25deg. C, 65%RH	TESTED BY	Aska Huang

ANTENNA POLARITY & TEST DISTANCE: HORIZONTAL AT 3 M								
NO.	FREQ. (MHz)	EMISSION LEVEL (dBuV/m)	LIMIT (dBuV/m)	MARGIN (dB)	ANTENNA HEIGHT (m)	TABLE ANGLE (Degree)	RAW VALUE (dBuV)	CORRECTION FACTOR (dB/m)
1	2390.00	48.4 PK	74.0	-25.6	1.09 H	193	17.10	31.30
2	2390.00	36.2 AV	54.0	-17.8	1.09 H	193	4.90	31.30
3	2398.00	52.6 PK	74.0	-21.4	1.09 H	193	21.30	31.30
4	2398.00	42.1 AV	54.0	-11.9	1.09 H	193	10.80	31.30
5	2400.00	45.9 PK	74.0	-28.1	1.09 H	193	14.60	31.30
6	2400.00	15.8 AV	54.0	-38.2	1.09 H	193	-15.50	31.30
7	*2402.00	103.9 PK			1.09 H	193	72.60	31.30
8	*2402.00	73.8 AV			1.09 H	193	42.50	31.30
9	4804.00	48.3 PK	74.0	-25.7	1.04 H	192	11.10	37.20
10	4804.00	18.2 AV	54.0	-35.8	1.04 H	192	-19.00	37.20
ANTENNA POLARITY & TEST DISTANCE: VERTICAL AT 3 M								
NO.	FREQ. (MHz)	EMISSION LEVEL (dBuV/m)	LIMIT (dBuV/m)	MARGIN (dB)	ANTENNA HEIGHT (m)	TABLE ANGLE (Degree)	RAW VALUE (dBuV)	CORRECTION FACTOR (dB/m)
1	2390.00	42.0 PK	74.0	-32.0	1.05 V	78	10.70	31.30
2	2390.00	30.2 AV	54.0	-23.8	1.05 V	78	-1.10	31.30
3	2398.00	46.4 PK	74.0	-27.6	1.05 V	78	15.10	31.30
4	2398.00	36.0 AV	54.0	-18.0	1.05 V	78	4.70	31.30
5	2400.00	48.2 PK	74.0	-25.8	1.05 V	78	16.90	31.30
6	2400.00	18.1 AV	54.0	-35.9	1.05 V	78	-13.20	31.30
7	*2402.00	98.2 PK			1.05 V	78	66.90	31.30
8	*2402.00	68.1 AV			1.05 V	78	36.80	31.30
9	4804.00	46.0 PK	74.0	-28.0	1.00 V	305	8.80	37.20
10	4804.00	15.9 AV	54.0	-38.1	1.00 V	305	-21.30	37.20

- REMARKS:**
- Emission level (dBuV/m) = Raw Value (dBuV) + Correction Factor (dB/m).
 - Correction Factor (dB/m) = Antenna Factor (dB/m) + Cable Factor (dB).
 - The other emission levels were very low against the limit.
 - Margin value = Emission level – Limit value.
 - * * *: Fundamental frequency.
 - The DH5 packet was the worse case duty cycle for a transmit dwell time on a channel, based upon bluetooth theory the transmitter is on $0.625 * 5$ per 296.25 ms per channel. Therefore, the duty cycle correlation factor be equal to: $20\log(3.125 / 100) = -30.1$ dB.
 - Average value = peak reading + $20\log(\text{duty cycle})$.



A D T

EUT TEST CONDITION		MEASUREMENT DETAIL	
CHANNEL	Channel 39	FREQUENCY RANGE	1 ~ 25GHz
INPUT POWER (SYSTEM)	120Vac, 60 Hz	DETECTOR FUNCTION	Peak (PK) Average (AV)
ENVIRONMENTAL CONDITIONS	25deg. C, 65%RH	TESTED BY	Aska Huang

ANTENNA POLARITY & TEST DISTANCE: HORIZONTAL AT 3 M								
NO.	FREQ. (MHz)	EMISSION LEVEL (dBuV/m)	LIMIT (dBuV/m)	MARGIN (dB)	ANTENNA HEIGHT (m)	TABLE ANGLE (Degree)	RAW VALUE (dBuV)	CORRECTION FACTOR (dB/m)
1	*2441.00	103.9 PK			1.08 H	189	72.40	31.50
2	*2441.00	73.8 AV			1.08 H	189	42.30	31.50
3	4882.00	46.2 PK	74.0	-27.8	1.00 H	155	8.90	37.30
4	4882.00	16.1 AV	54.0	-37.9	1.00 H	155	-21.20	37.30
5	7323.00	51.7 PK	74.0	-22.3	1.00 H	126	8.10	43.60
6	7323.00	21.6 AV	54.0	-32.4	1.00 H	126	-22.00	43.60
ANTENNA POLARITY & TEST DISTANCE: VERTICAL AT 3 M								
NO.	FREQ. (MHz)	EMISSION LEVEL (dBuV/m)	LIMIT (dBuV/m)	MARGIN (dB)	ANTENNA HEIGHT (m)	TABLE ANGLE (Degree)	RAW VALUE (dBuV)	CORRECTION FACTOR (dB/m)
1	*2441.00	99.6 PK			1.03 V	77	68.10	31.50
2	*2441.00	69.5 AV			1.03 V	77	38.00	31.50
3	4882.00	45.7 PK	74.0	-28.3	1.00 V	85	8.40	37.30
4	4882.00	15.6 AV	54.0	-38.4	1.00 V	85	-21.70	37.30
5	7323.00	51.9 PK	74.0	-22.1	1.00 V	242	8.30	43.60
6	7323.00	21.8 AV	54.0	-32.2	1.00 V	242	-21.80	43.60

- REMARKS:**
1. Emission level (dBuV/m) = Raw Value (dBuV) + Correction Factor (dB/m).
 2. Correction Factor (dB/m) = Antenna Factor (dB/m) + Cable Factor (dB).
 3. The other emission levels were very low against the limit.
 4. Margin value = Emission level – Limit value.
 5. “ * “: Fundamental frequency.
 6. The DH5 packet was the worse case duty cycle for a transmit dwell time on a channel, based upon bluetooth theory the transmitter is on 0.625 * 5 per 296.25 ms per channel. Therefore, the duty cycle correlation factor be equal to: $20\log(3.125 / 100) = -30.1$ dB.
 7. Average value = peak reading + $20\log(\text{duty cycle})$.



A D T

EUT TEST CONDITION		MEASUREMENT DETAIL	
CHANNEL	Channel 78	FREQUENCY RANGE	1 ~ 25GHz
INPUT POWER (SYSTEM)	120Vac, 60 Hz	DETECTOR FUNCTION	Peak (PK) Average (AV)
ENVIRONMENTAL CONDITIONS	25deg. C, 65%RH	TESTED BY	Aska Huang

ANTENNA POLARITY & TEST DISTANCE: HORIZONTAL AT 3 M

NO.	FREQ. (MHz)	EMISSION LEVEL (dBuV/m)	LIMIT (dBuV/m)	MARGIN (dB)	ANTENNA HEIGHT (m)	TABLE ANGLE (Degree)	RAW VALUE (dBuV)	CORRECTION FACTOR (dB/m)
1	*2480.00	102.5 PK			1.30 H	197	70.90	31.60
2	*2480.00	72.4 AV			1.30 H	197	40.80	31.60
3	2483.50	43.4 PK	74.0	-30.6	1.30 H	197	11.80	31.60
4	2483.50	13.3 AV	54.0	-40.7	1.30 H	197	-18.30	31.60
5	2485.50	53.0 PK	74.0	-21.0	1.30 H	197	21.40	31.60
6	2485.50	39.7 AV	54.0	-14.3	1.30 H	197	8.10	31.60
7	4960.00	46.6 PK	74.0	-27.4	1.00 H	218	9.10	37.50
8	4960.00	16.5 AV	54.0	-37.5	1.00 H	218	-21.00	37.50

ANTENNA POLARITY & TEST DISTANCE: VERTICAL AT 3 M

NO.	FREQ. (MHz)	EMISSION LEVEL (dBuV/m)	LIMIT (dBuV/m)	MARGIN (dB)	ANTENNA HEIGHT (m)	TABLE ANGLE (Degree)	RAW VALUE (dBuV)	CORRECTION FACTOR (dB/m)
1	*2480.00	98.9 PK			1.05 V	79	67.30	31.60
2	*2480.00	68.8 AV			1.05 V	79	37.20	31.60
3	2483.50	40.2 PK	74.0	-33.8	1.05 V	79	8.60	31.60
4	2483.50	10.1 AV	54.0	-43.9	1.05 V	79	-21.50	31.60
5	2485.50	48.1 PK	74.0	-25.9	1.05 V	79	16.50	31.60
6	2485.50	36.1 AV	54.0	-17.9	1.05 V	79	4.50	31.60
7	4960.00	45.7 PK	74.0	-28.3	1.00 V	95	8.20	37.50
8	4960.00	15.6 AV	54.0	-38.4	1.00 V	95	-21.90	37.50

- REMARKS:**
- Emission level (dBuV/m) = Raw Value (dBuV) + Correction Factor (dB/m).
 - Correction Factor (dB/m) = Antenna Factor (dB/m) + Cable Factor (dB).
 - The other emission levels were very low against the limit.
 - Margin value = Emission level – Limit value.
 - * *: Fundamental frequency.
 - The DH5 packet was the worse case duty cycle for a transmit dwell time on a channel, based upon bluetooth theory the transmitter is on 0.625 * 5 per 296.25 ms per channel. Therefore, the duty cycle correlation factor be equal to: $20\log(3.125 / 100) = -30.1$ dB.
 - Average value = peak reading + $20\log(\text{duty cycle})$.



A D T

BELOW 1GHz WORST-CASE DATA : 8DPSK

EUT TEST CONDITION		MEASUREMENT DETAIL	
CHANNEL	Channel 0	FREQUENCY RANGE	Below 1000MHz
INPUT POWER (SYSTEM)	120Vac, 60 Hz	DETECTOR FUNCTION	Quasi-Peak
ENVIRONMENTAL CONDITIONS	25deg. C, 65%RH	TESTED BY	Aska Huang

ANTENNA POLARITY & TEST DISTANCE: HORIZONTAL AT 3 M								
NO.	FREQ. (MHz)	EMISSION LEVEL (dBuV/m)	LIMIT (dBuV/m)	MARGIN (dB)	ANTENNA HEIGHT (m)	TABLE ANGLE (Degree)	RAW VALUE (dBuV)	CORRECTION FACTOR (dB/m)
1	99.89	30.3 QP	43.5	-13.2	2.00 H	73	20.80	9.50
2	166.00	34.4 QP	43.5	-9.1	1.50 H	16	20.60	13.80
3	239.88	34.2 QP	46.0	-11.8	1.50 H	202	21.50	12.70
4	300.16	44.1 QP	46.0	-1.9	1.00 H	202	29.10	15.00
5	498.47	32.6 QP	46.0	-13.4	1.75 H	247	12.60	20.00
6	799.84	33.1 QP	46.0	-12.9	1.00 H	268	7.40	25.70
ANTENNA POLARITY & TEST DISTANCE: VERTICAL AT 3 M								
NO.	FREQ. (MHz)	EMISSION LEVEL (dBuV/m)	LIMIT (dBuV/m)	MARGIN (dB)	ANTENNA HEIGHT (m)	TABLE ANGLE (Degree)	RAW VALUE (dBuV)	CORRECTION FACTOR (dB/m)
1	97.95	31.4 QP	43.5	-12.1	1.00 V	217	22.20	9.20
2	166.00	32.7 QP	43.5	-10.8	1.00 V	7	18.90	13.80
3	239.88	28.9 QP	46.0	-17.1	1.25 V	307	16.20	12.70
4	300.16	34.7 QP	46.0	-11.3	1.25 V	310	19.70	15.00
5	500.42	30.2 QP	46.0	-15.8	1.00 V	325	10.20	20.00
6	799.84	30.1 QP	46.0	-15.9	1.50 V	286	4.40	25.70

- REMARKS:**
1. Emission level (dBuV/m) = Raw Value (dBuV) + Correction Factor (dB/m).
 2. Correction Factor (dB/m) = Antenna Factor (dB/m) + Cable Factor (dB).
 3. The other emission levels were very low against the limit.
 4. Margin value = Emission level – Limit value.

4.2 CONDUCTED EMISSION MEASUREMENT

4.2.1 LIMITS OF CONDUCTED EMISSION MEASUREMENT

FREQUENCY OF EMISSION (MHz)	CONDUCTED LIMIT (dB μ V)	
	Quasi-peak	Average
0.15 ~ 0.5	66 to 56	56 to 46
0.5 ~ 5	56	46
5 ~ 30	60	50

- NOTE:** 1. The lower limit shall apply at the transition frequencies.
2. The limit decreases in line with the logarithm of the frequency in the range of 0.15 to 0.50MHz.
3. All emanations from a class A/B digital device or system, including any network of conductors and apparatus connected thereto, shall not exceed the level of field strengths specified above.

4.2.2 TEST INSTRUMENTS

DESCRIPTION & MANUFACTURER	MODEL NO.	SERIAL NO.	DATE OF CALIBRATION	DUE DATE OF CALIBRATION
Test Receiver ROHDE & SCHWARZ	ESCS30	100289	Nov. 19, 2011	Nov. 18, 2012
RF signal cable Woken	5D-FB	Cable-HYCO2-01	Dec. 22, 2011	Dec. 21, 2012
LISN ROHDE & SCHWARZ	ESH2-Z5	100100	Dec. 30, 2011	Dec. 29, 2012
LISN ROHDE & SCHWARZ	ESH3-Z5	100312	Jul. 07, 2011	Jul. 06, 2012
V-LISN SCHWARZBECK	NNBL 8226-2	8226-142	Jun. 30, 2011	Jun. 29, 2012
LISN ROHDE & SCHWARZ	ENV216	100072	Jun. 10, 2011	Jun. 09, 2012
Software ADT	ADT_Cond_ V7.3.7	NA	NA	NA

- NOTE:** 1. The calibration interval of the above test instruments is 12 months and the calibrations are traceable to NML/ROC and NIST/USA.
2. The test was performed in HwaYa Shielded Room 2.
3. The VCCI Site Registration No. is C-2047.

4.2.3 TEST PROCEDURES

- a. The EUT was placed 0.4 meters from the conducting wall of the shielded room with EUT being connected to the power mains through a line impedance stabilization network (LISN). Other support units were connected to the power mains through another LISN. The two LISNs provide 50 ohm/ 50uH of coupling impedance for the measuring instrument.
- b. Both lines of the power mains connected to the EUT were checked for maximum conducted interference.
- c. The frequency range from 150kHz to 30MHz was searched. Emission levels under (Limit - 20dB) was not recorded.

NOTE: All modes of operation were investigated and the worst-case emissions are reported.

4.2.4 DEVIATION FROM TEST STANDARD

No deviation.

4.2.5 TEST SETUP

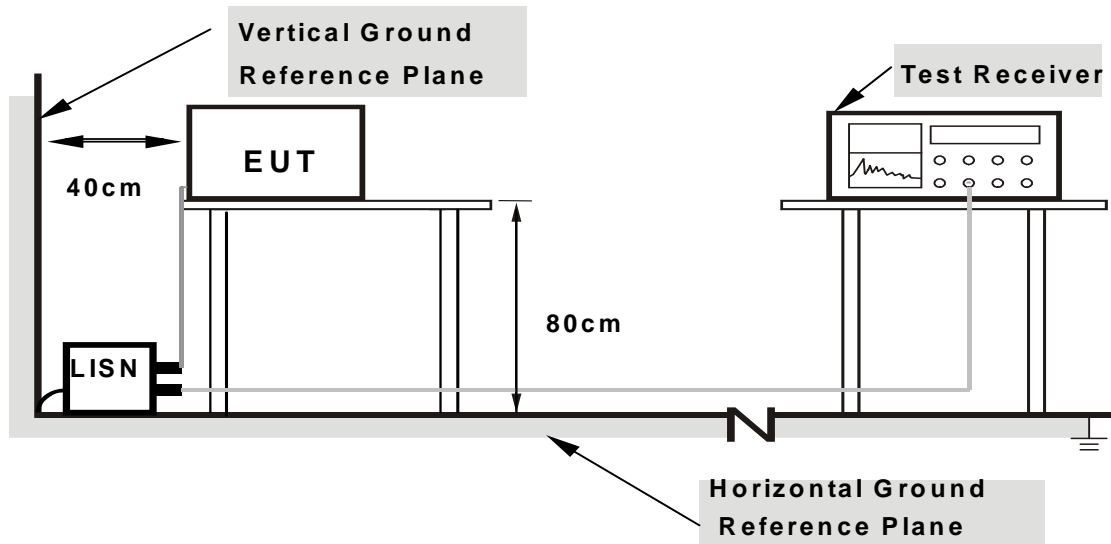

- Note:**
1. Support units were connected to second LISN.
 2. Both of LISNs (AMN) are 80 cm from EUT and at least 80 from other units and other metal planes

For the actual test configuration, please refer to the attached file (Test Setup Photo).

4.2.6 EUT OPERATING CONDITIONS

Same as 4.1.6.

4.2.7 TEST RESULTS

CONDUCTED WORST-CASE DATA : 8DPSK

PHASE	Line 1	6dB BANDWIDTH	9kHz
-------	--------	---------------	------

No	Freq. [MHz]	Corr. Factor (dB)	Reading Value		Emission Level		Limit		Margin	
			[dB (uV)]		[dB (uV)]		[dB (uV)]		(dB)	
			Q.P.	AV.	Q.P.	AV.	Q.P.	AV.	Q.P.	AV.
1	0.19297	0.15	28.34	20.72	28.49	20.87	63.91	53.91	-35.42	-33.04
2	0.70469	0.18	35.35	25.82	35.53	26.00	56.00	46.00	-20.47	-20.00
3	0.99375	0.19	35.69	25.12	35.88	25.31	56.00	46.00	-20.12	-20.69
4	3.52734	0.32	34.12	25.93	34.44	26.25	56.00	46.00	-21.56	-19.75
5	6.84766	0.38	34.32	25.89	34.70	26.27	60.00	50.00	-25.30	-23.73
6	19.02344	0.61	42.57	34.99	43.18	35.60	60.00	50.00	-16.82	-14.40

- REMARKS:**
1. Q.P. and AV. are abbreviations of quasi-peak and average individually.
 2. "-": The Quasi-peak reading value also meets average limit and measurement with the average detector is unnecessary.
 3. The emission levels of other frequencies were very low against the limit.
 4. Margin value = Emission level - Limit value
 5. Correction factor = Insertion loss + Cable loss
 6. Emission Level = Correction Factor + Reading Value.

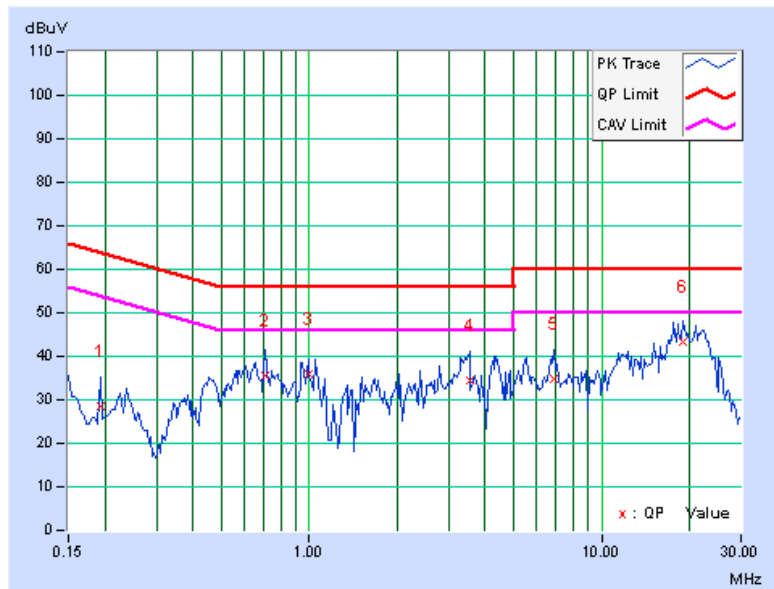



A D T

PHASE	Line 2	6dB BANDWIDTH	9kHz
-------	--------	---------------	------

No	Freq. [MHz]	Corr. Factor (dB)	Reading Value		Emission Level		Limit		Margin	
			[dB (uV)]		[dB (uV)]		[dB (uV)]		(dB)	
			Q.P.	AV.	Q.P.	AV.	Q.P.	AV.	Q.P.	AV.
1	0.57969	0.17	32.13	24.35	32.30	24.52	56.00	46.00	-23.70	-21.48
2	0.67344	0.17	35.82	21.95	35.99	22.12	56.00	46.00	-20.01	-23.88
3	3.86328	0.34	37.22	28.79	37.56	29.13	56.00	46.00	-18.44	-16.87
4	5.18750	0.38	36.98	30.48	37.36	30.86	60.00	50.00	-22.64	-19.14
5	11.36328	0.51	36.89	30.21	37.40	30.72	60.00	50.00	-22.60	-19.28
6	19.80469	0.72	40.51	32.68	41.23	33.40	60.00	50.00	-18.77	-16.60

- REMARKS:**
1. Q.P. and AV. are abbreviations of quasi-peak and average individually.
 2. "-": The Quasi-peak reading value also meets average limit and measurement with the average detector is unnecessary.
 3. The emission levels of other frequencies were very low against the limit.
 4. Margin value = Emission level - Limit value
 5. Correction factor = Insertion loss + Cable loss
 6. Emission Level = Correction Factor + Reading Value.

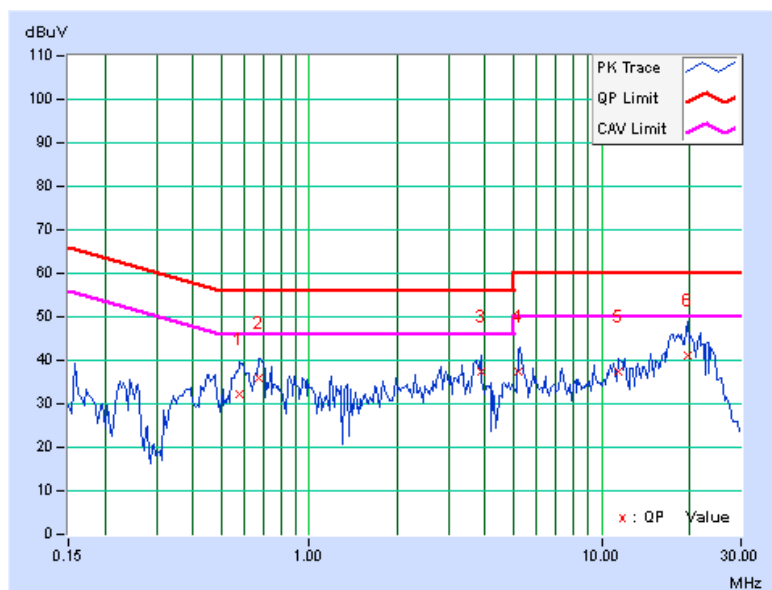

4.3 NUMBER OF HOPPING FREQUENCY USED

4.3.1 LIMIT OF HOPPING FREQUENCY USED

At least 15 channels frequencies, and should be equally spaced.

4.3.2 TEST SETUP

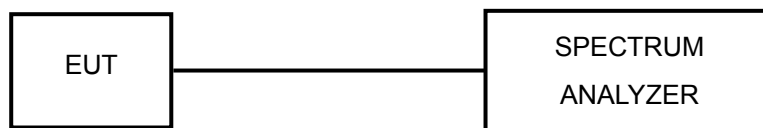

4.3.3 TEST INSTRUMENTS

Refer to section 4.1.2 to get information of above instrument.

4.3.4 TEST PROCEDURES

- a. Check the calibration of the measuring instrument (SA) using either an internal calibrator or a known signal from an external generator.
- b. Turn on the EUT and connect its antenna terminal to measurement via a low loss cable. Then set it to any one measured frequency within its operating range and make sure the instrument is operated in its linear range.
- c. Set the SA on MaxHold Mode, and then keep the EUT in hopping mode. Record all the signals from each channel until each one has been recorded.
- d. Set the SA on View mode and then plot the result on SA screen.
- e. Repeat above procedures until all frequencies measured were complete.

4.3.5 DEVIATION FROM TEST STANDARD

No deviation.

4.3.6 TEST RESULTS

There are 79 hopping frequencies in the hopping mode. Please refer to next two pages for the test result. On the plots, it shows that the hopping frequencies are equally spaced.



A D T

GFSK

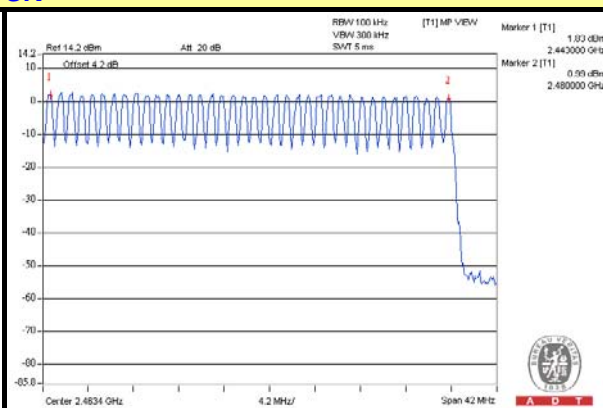
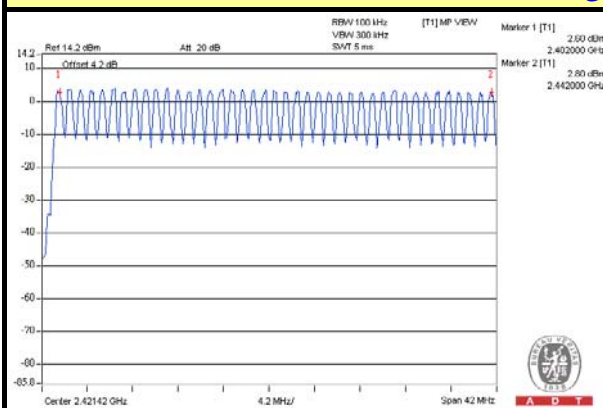

8DPSK

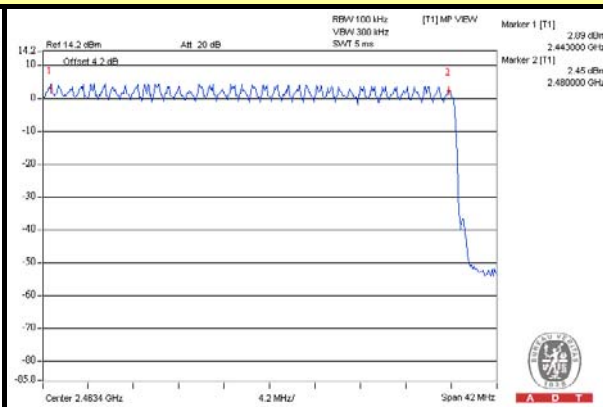
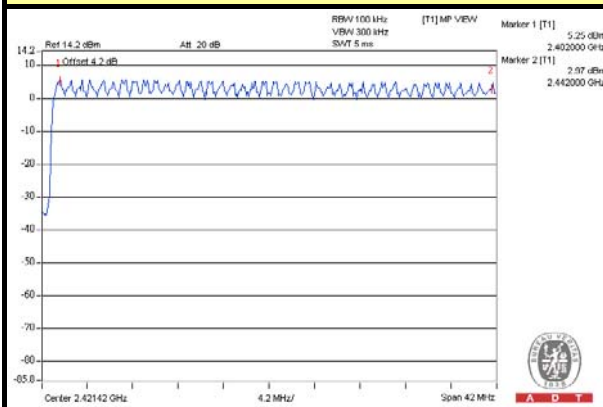

4.4 DWELL TIME ON EACH CHANNEL

4.4.1 LIMIT OF DWELL TIME USED

The average time of occupancy on any channel shall not be greater than 0.4 seconds within a period of 0.4 seconds multiplied by the number of hopping channels employed.

4.4.2 TEST SETUP

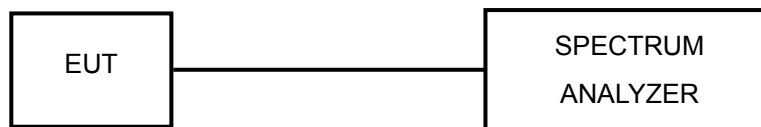

4.4.3 TEST INSTRUMENTS

Refer to section 4.1.2 to get information of above instrument.

4.4.4 TEST PROCEDURES

- a. Check the calibration of the measuring instrument (SA) using either an internal calibrator or a known signal from an external generator.
- b. Turn on the EUT and connect its antenna terminal to measurement via a low loss cable. Then set it to any one measured frequency within its operating range and make sure the instrument is operated in its linear range.
- c. Adjust the center frequency of SA on any frequency be measured and set SA to zero span mode. And then, set RBW and VBW of spectrum analyzer to proper value.
- d. Measure the time duration of one transmission on the measured frequency. And then plot the result with time difference of this time duration.
- e. Repeat above procedures until all different time-slot modes have been completed.

4.4.5 DEVIATION FROM TEST STANDARD

No deviation.

4.4.6 TEST RESULTS

GFSK

Mode	Number of transmission in a 31.6 (79Hopping*0.4)	Length of transmission time (msec)	Result (msec)	Limit (msec)
DH1	50 (times / 5 sec) * 6.32 = 316.00 times	0.438	138.408	400
DH3	25 (times / 5 sec) * 6.32 = 158.00 times	1.692	267.336	400
DH5	18 (times / 5 sec) * 6.32 = 113.76 times	3.000	341.280	400

NOTE: Test plots of the transmitting time slot are shown on next pages.



A D T

DH1

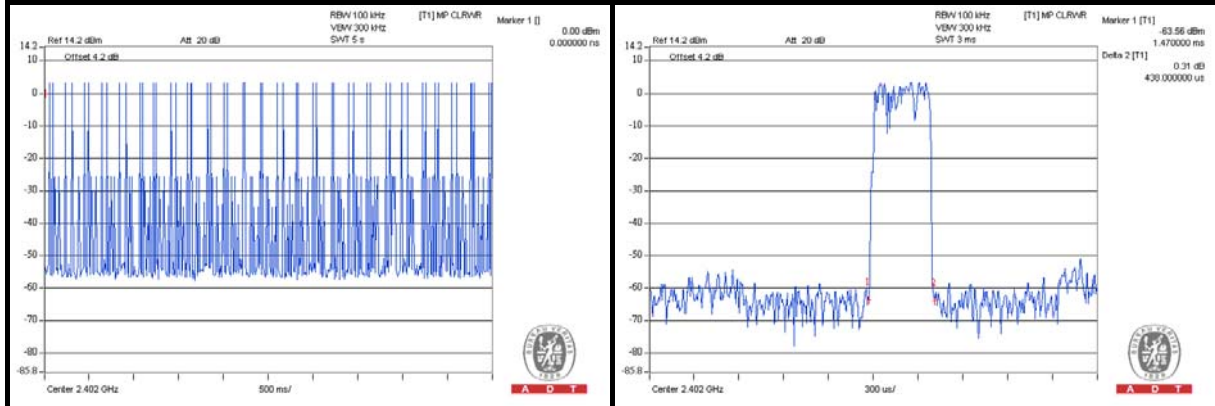

DH3

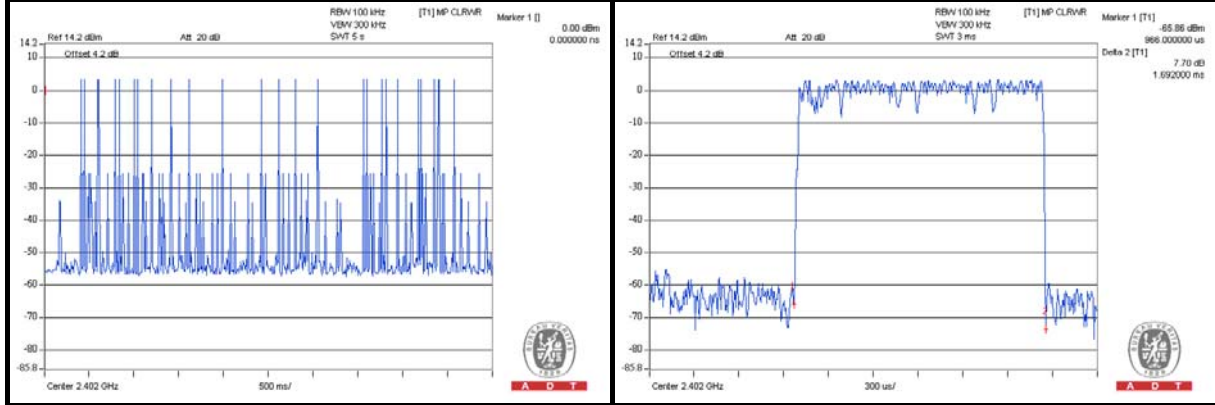

DH5

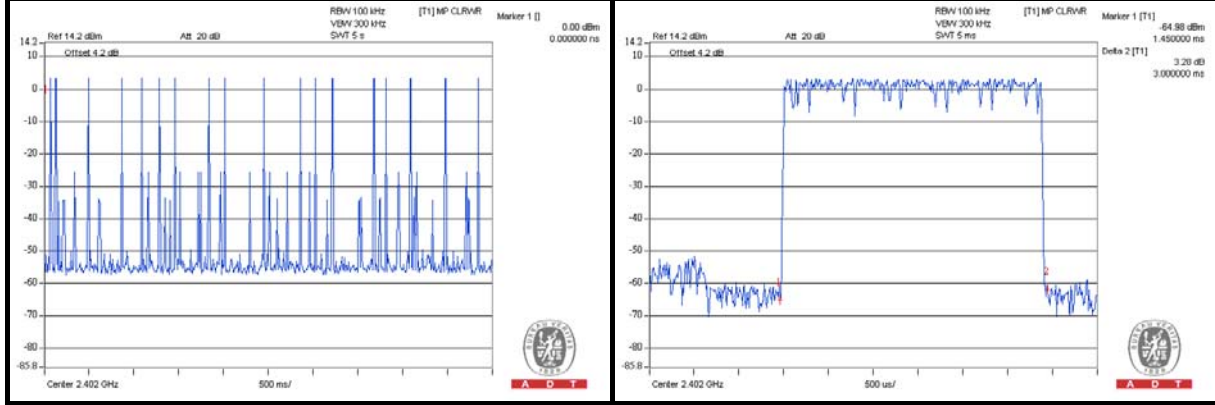

8DPSK

Mode	Number of transmission in a 31.6 (79Hopping*0.4)	Length of transmission time (msec)	Result (msec)	Limit (msec)
DH1	50 (times / 5 sec) * 6.32 = 316.00 times	0.504	159.264	400
DH3	27 (times / 5 sec) * 6.32 = 170.64 times	1.692	288.723	400
DH5	17 (times / 5 sec) * 6.32 = 107.44 times	2.940	315.874	400

NOTE: Test plots of the transmitting time slot are shown on next pages.



A D T

DH1

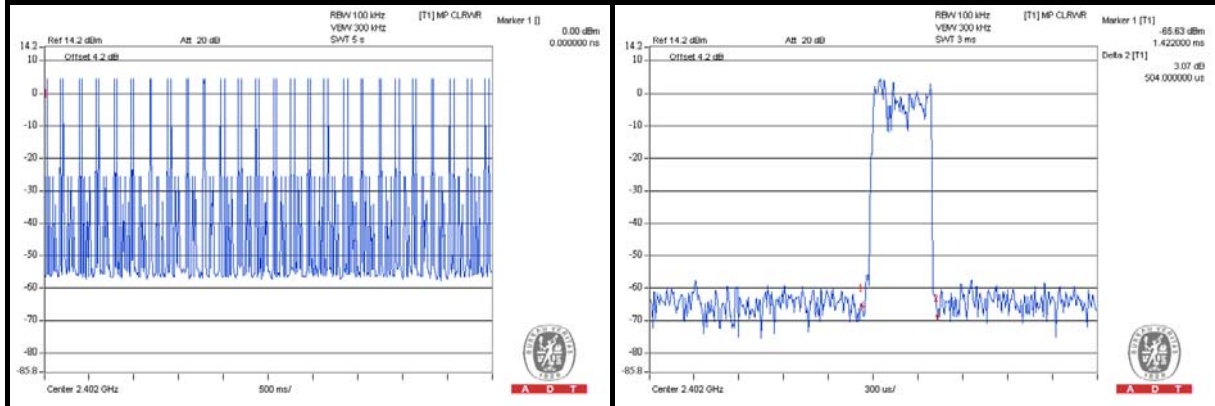

DH3

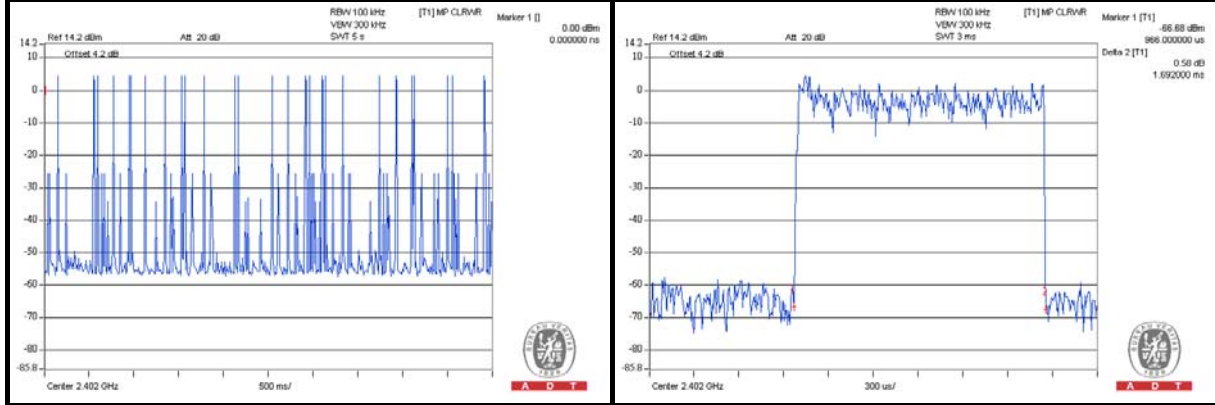

DH5

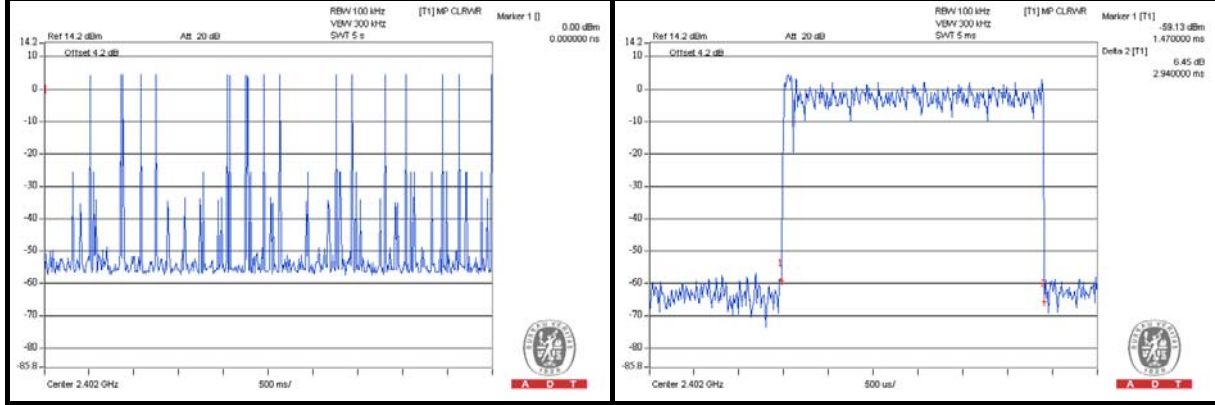

4.5 CHANNEL BANDWIDTH

4.5.1 LIMITS OF CHANNEL BANDWIDTH

For frequency hopping system operating in the 2400-2483.5MHz, If the 20dB bandwidth of hopping channel is greater than 25kHz, two-thirds 20dB bandwidth of hopping channel shall be a minimum limit for the hopping channel separation.

4.5.2 TEST SETUP

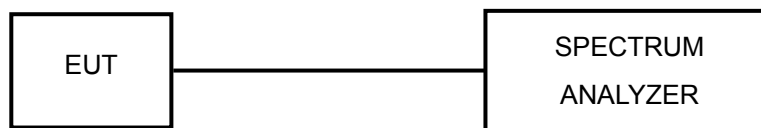

4.5.3 TEST INSTRUMENTS

Refer to section 4.1.2 to get information of above instrument.

4.5.4 TEST PROCEDURE

- a. Check the calibration of the measuring instrument using either an internal calibrator or a known signal from an external generator.
- b. Turn on the EUT and connect it to measurement instrument. Then set it to any one convenient frequency within its operating range. Set a reference level on the measuring instrument equal to the highest peak value.
- c. Measure the frequency difference of two frequencies that were attenuated 20dB from the reference level. Record the frequency difference as the emission bandwidth.
- d. Repeat above procedures until all frequencies measured were complete.

4.5.5 DEVIATION FROM TEST STANDARD

No deviation.

4.5.6 EUT OPERATING CONDITION

The software provided by client enabled the EUT to transmit and receive data at lowest, middle and highest channel frequencies individually.



A D T

4.5.7 TEST RESULTS

CHANNEL	FREQUENCY (MHz)	20dB BANDWIDTH (MHz)	
		GFSK	8DPSK
0	2402	0.960	1.360
39	2441	0.946	1.360
78	2480	0.956	1.360

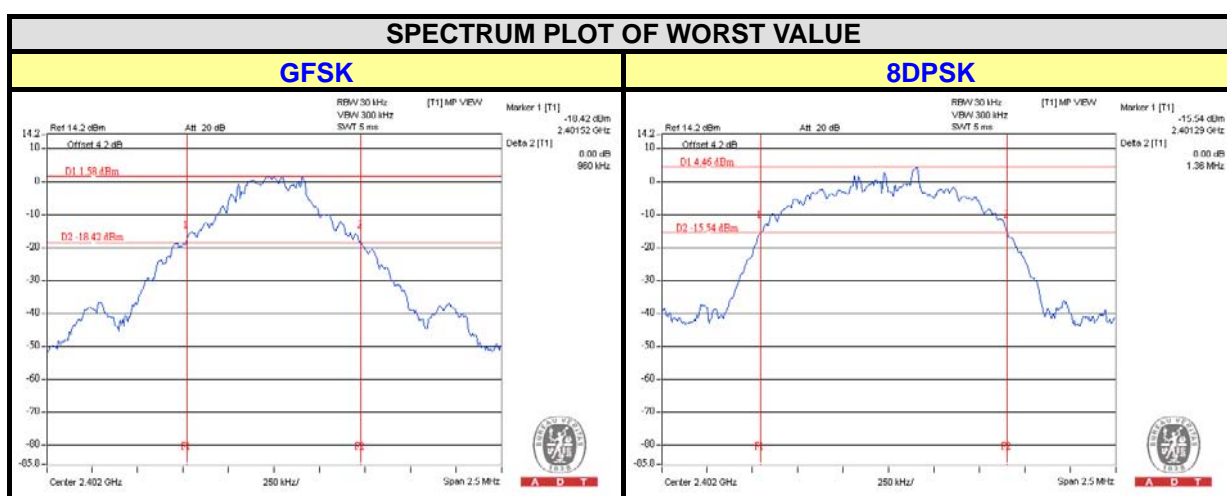

4.6 HOPPING CHANNEL SEPARATION

4.6.1 LIMIT OF HOPPING CHANNEL SEPARATION

At least 25kHz or two-third of 20dB hopping channel bandwidth (whichever is greater).

4.6.2 TEST SETUP

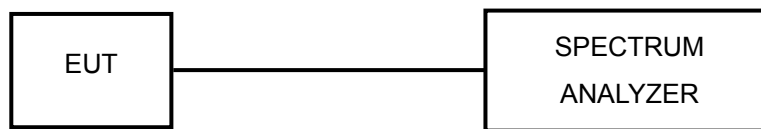

4.6.3 TEST INSTRUMENTS

Refer to section 4.1.2 to get information of above instrument.

4.6.4 TEST PROCEDURES

- a. Check the calibration of the measuring instrument using either an internal calibrator or a known signal from an external generator.
- b. Turn on the EUT and connect it to measurement instrument. Then set it to any one convenient frequency within its operating range.
- c. By using the MaxHold function record the separation of two adjacent channels.
- d. Measure the frequency difference of these two adjacent channels by SA MARK function. And then plot the result on SA screen.
- e. Repeat above procedures until all frequencies measured were complete.

4.6.5 DEVIATION FROM TEST STANDARD

No deviation.

4.6.6 TEST RESULTS

CHANNEL	FREQUENCY (MHz)	ADJACENT CHANNEL SEPARATION (MHz)		20dB BANDWIDTH (MHz)		MINIMUM LIMIT (MHz)		PASS / FAIL
		GFSK	8DPSK	GFSK	8DPSK	GFSK	8DPSK	
0	2402	1.010	1.010	0.960	1.360	0.640	0.907	PASS
39	2441	1.000	1.000	0.946	1.360	0.631	0.907	PASS
78	2480	1.000	1.000	0.956	1.360	0.637	0.907	PASS

NOTE: The minimum limit is two-third 20dB bandwidth.

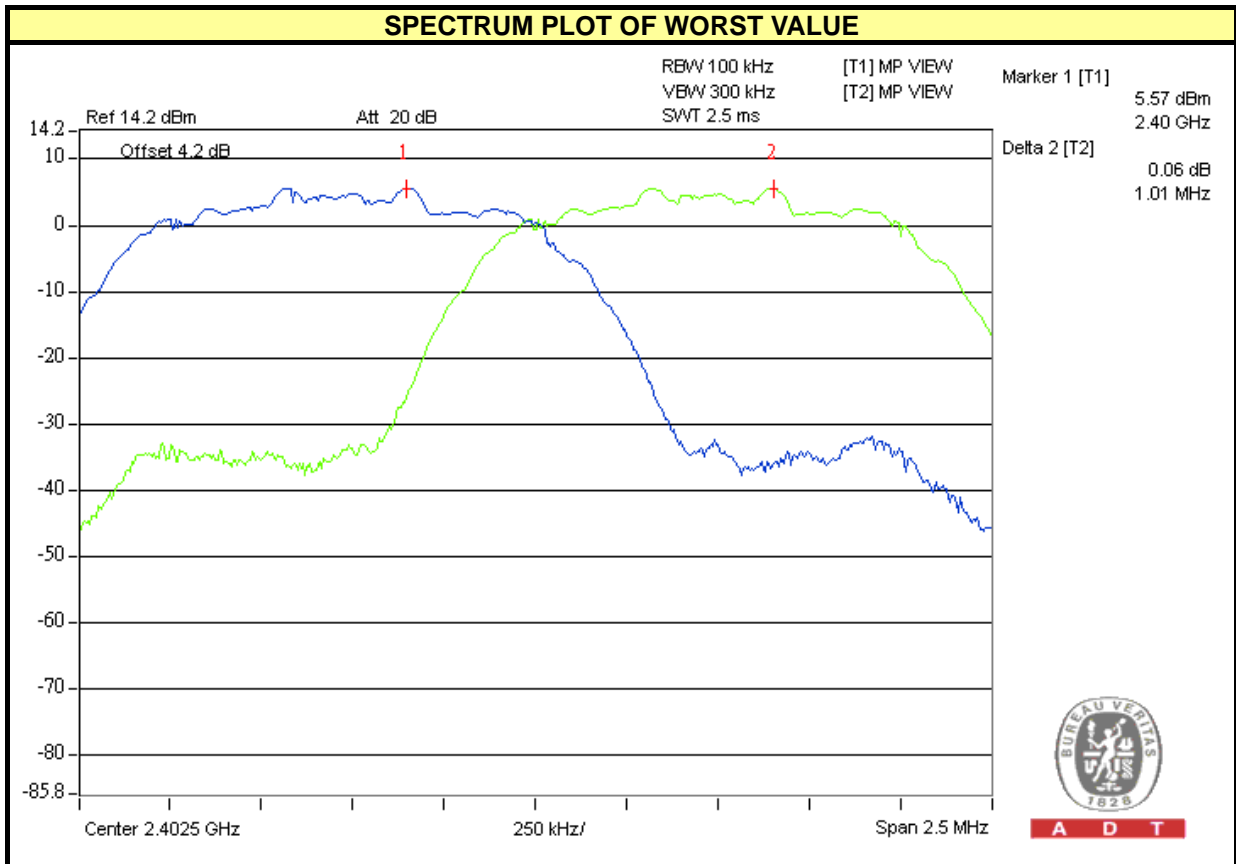

4.7 MAXIMUM OUTPUT POWER

4.7.1 LIMITS OF MAXIMUM OUTPUT POWER MEASUREMENT

The Maximum Output Power Measurement is 125mW.

4.7.2 TEST SETUP

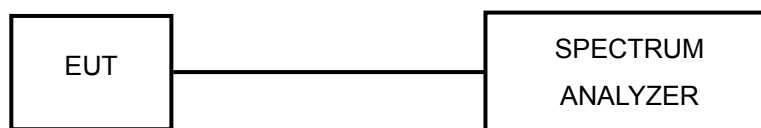

4.7.3 TEST INSTRUMENTS

Refer to section 4.1.2 to get information of above instrument.

4.7.4 TEST PROCEDURES

- a. Check the calibration of the measuring instrument using either an internal calibrator or a known signal from an external generator.
- b. Turn on the EUT and connect it to measurement instrument. Then set it to any one convenient frequency within its operating range. Set a reference level on the measuring instrument equal to the highest peak value.
- c. The center frequency of the spectrum analyzer is set to the fundamental frequency and using 3MHz RBW and 10 MHz VBW.
- d. Measure the captured power within the band and recording the plot.
- e. Repeat above procedures until all frequencies required were complete.

4.7.5 DEVIATION FROM TEST STANDARD

No deviation.

4.7.6 EUT OPERATING CONDITION

The software provided by client enabled the EUT to transmit and receive data at lowest, middle and highest channel frequencies individually.



A D T

4.7.7 TEST RESULTS

CHANNEL	FREQUENCY (MHz)	OUTPUT POWER (mW)		OUTPUT POWER (dBm)		POWER LIMIT (mW)	PASS / FAIL
		GFSK	8DPSK	GFSK	8DPSK		
0	2402	3.4	7.4	5.26	8.71	125	PASS
39	2441	2.7	6.2	4.25	7.94	125	PASS
78	2480	2.0	4.8	3.03	6.84	125	PASS

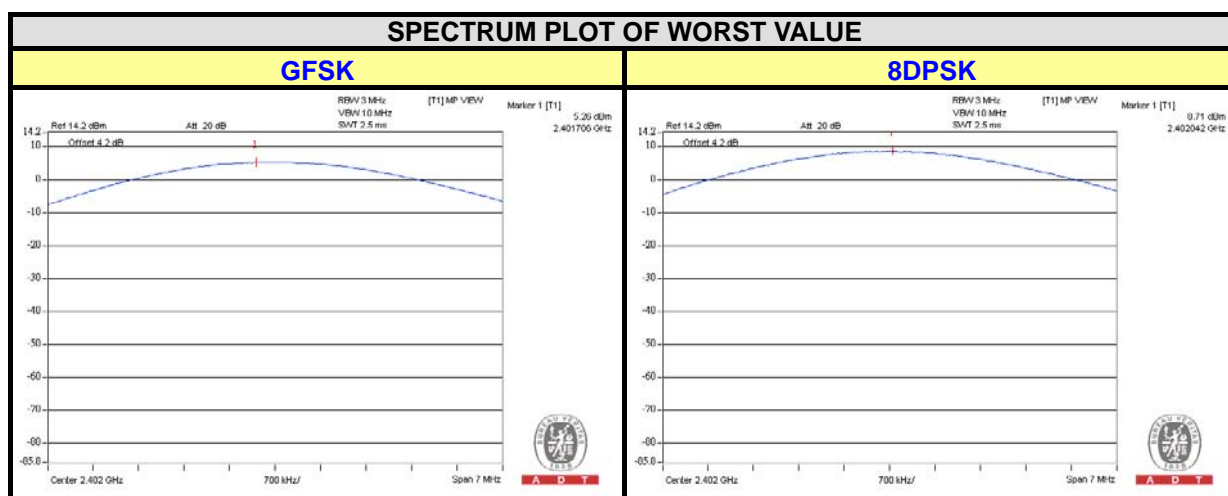

4.8 CONDUCTED OUT OF BAND EMISSION MEASUREMENT

4.8.1 LIMITS OF CONDUCTED OUT OF BAND EMISSION MEASUREMENT

Below -20dB of the highest emission level of operating band (in 100KHz RBW).

4.8.2 TEST INSTRUMENTS

Refer to section 4.1.2 to get information of above instrument.

4.8.3 TEST PROCEDURE

The transmitter output was connected to the spectrum analyzer via a low loss cable. Set both RBW and VBW of spectrum analyzer to 100 kHz with suitable frequency span including 100 MHz bandwidth from band edge. The band edges was measured and recorded.

4.8.4 DEVIATION FROM TEST STANDARD

No deviation.

4.8.5 EUT OPERATING CONDITION

The software provided by client enabled the EUT to transmit and receive data at lowest, middle and highest channel frequencies individually.

4.8.6 TEST RESULTS

The spectrum plots are attached on the following images. D1 line indicates the highest level, D2 line indicates the 20dB offset below D1. It shows compliance with the requirement.

GFSK

Hopping disabled_ Low Channel

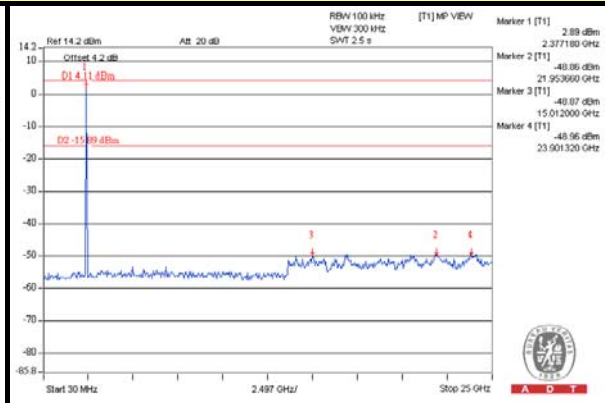
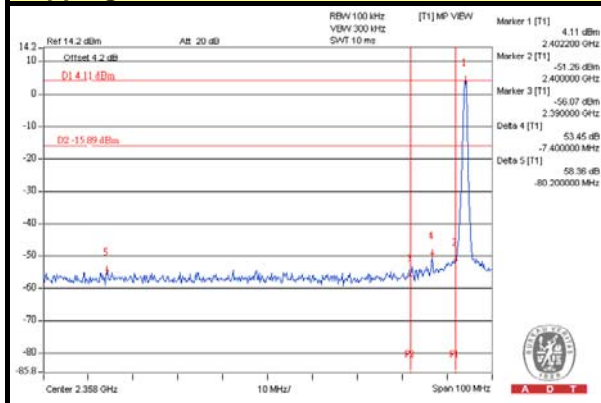

Hopping disabled_ High Channel

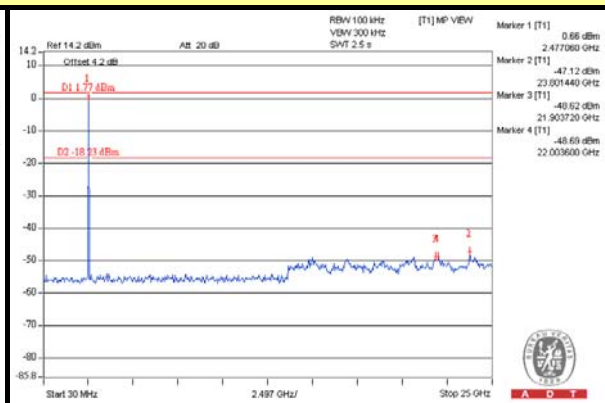
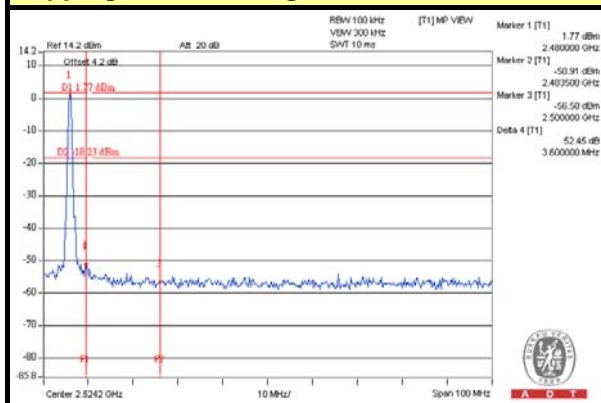

Hopping enabled_ Low Channel

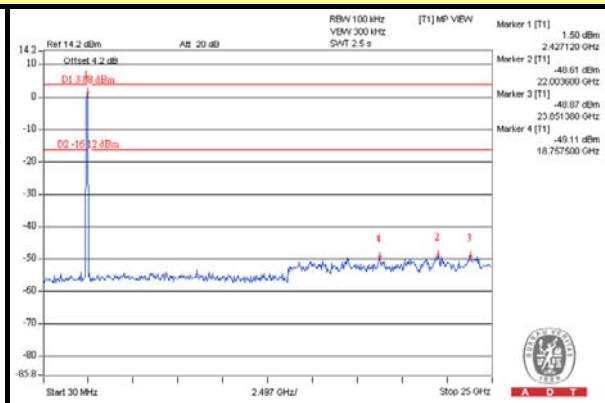
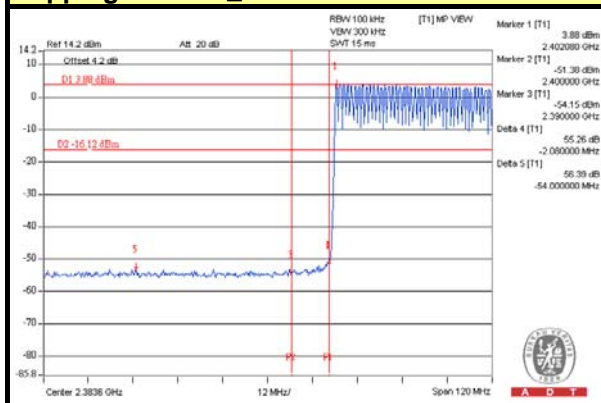

Hopping enabled_ High Channel

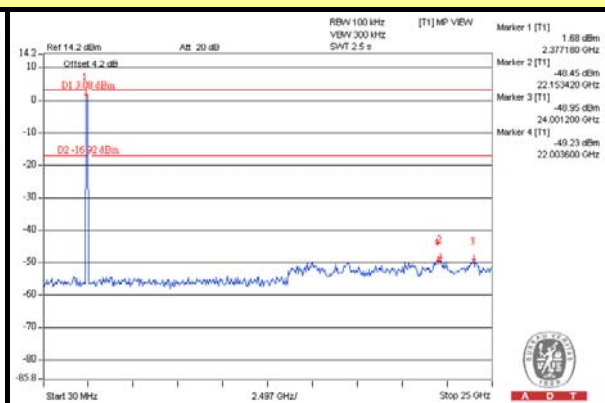
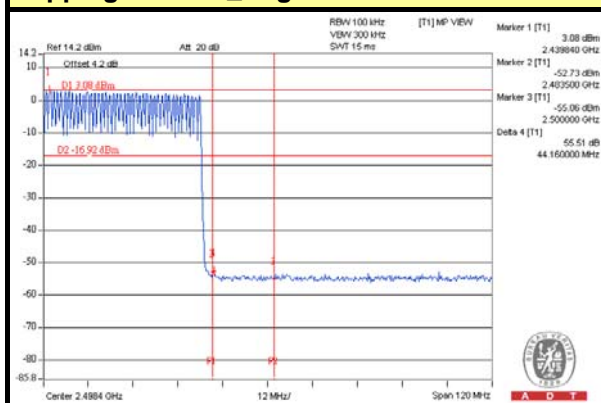



A D T

8DPSK

Hopping disabled_ Low Channel

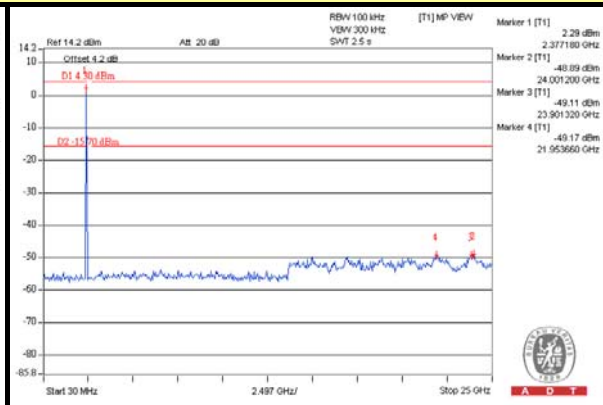
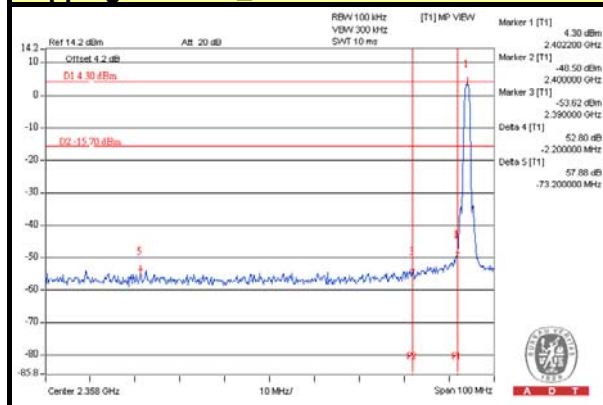

Hopping disabled_ High Channel

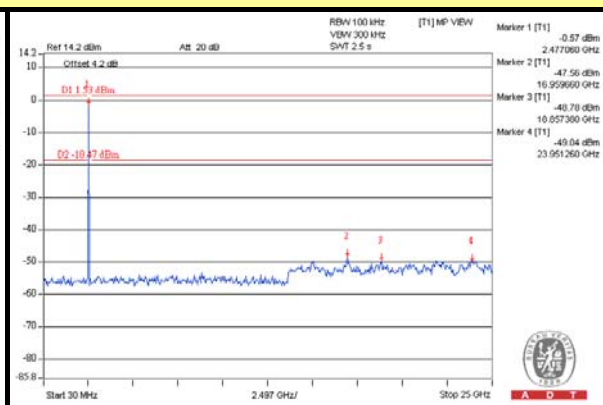
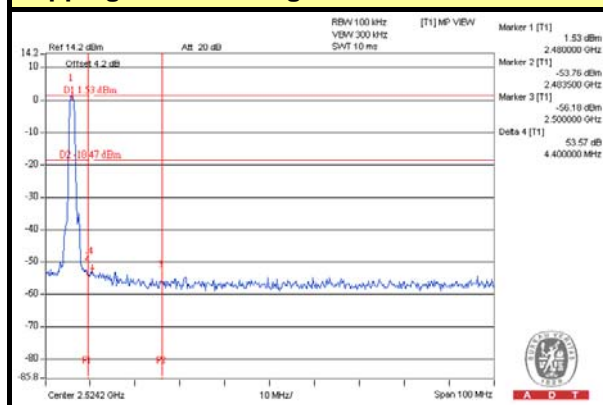

Hopping enabled_ Low Channel

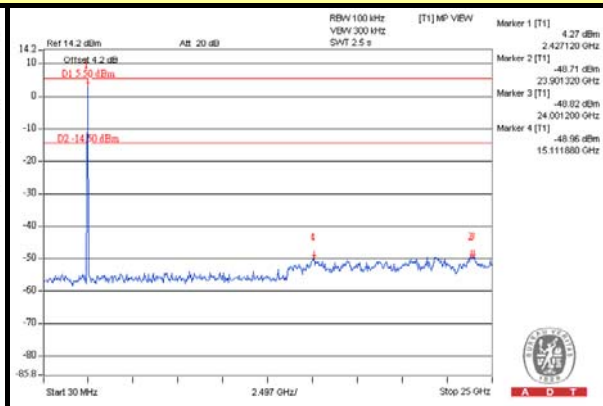
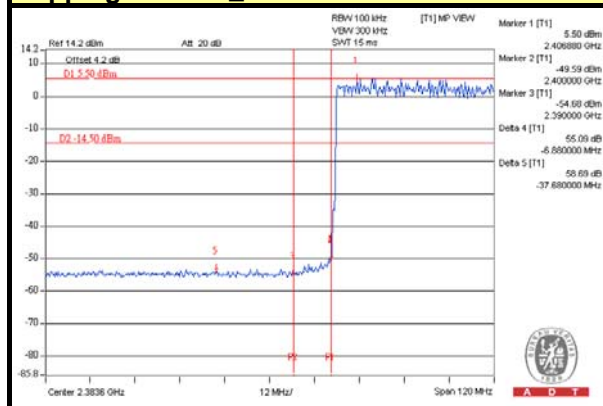

Hopping enabled_ High Channel

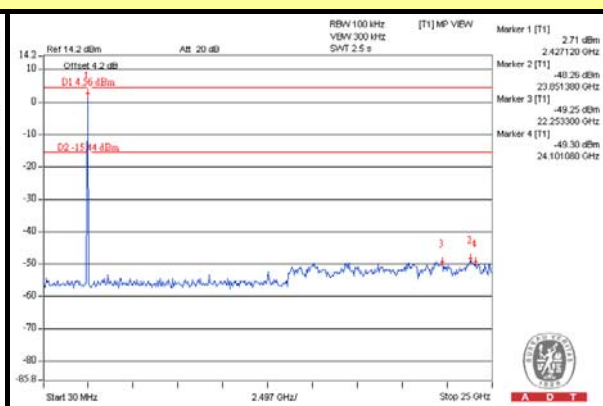
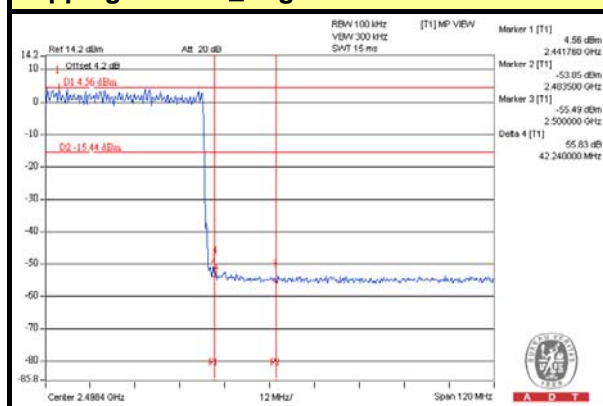

5. PHOTOGRAPHS OF THE TEST CONFIGURATION

Please refer to the attached file (Test Setup Photo).



6. INFORMATION ON THE TESTING LABORATORIES

We, Bureau Veritas Consumer Products Services (H.K.) Ltd., Taoyuan Branch, were founded in 1988 to provide our best service in EMC, Radio, Telecom and Safety consultation. Our laboratories are accredited and approved according to ISO/IEC 17025.

Copies of accreditation and authorization certificates of our laboratories obtained from approval agencies can be downloaded from our web site:

www.adt.com.tw/index.5.phtml. If you have any comments, please feel free to contact us at the following:

Linko EMC/RF Lab:

Tel: 886-2-26052180

Fax: 886-2-26051924

Hsin Chu EMC/RF Lab:

Tel: 886-3-5935343

Fax: 886-3-5935342

Hwa Ya EMC/RF/Safety Telecom Lab:

Tel: 886-3-3183232

Fax: 886-3-3185050

Email: service.adt@tw.bureauveritas.com

Web Site: www.adt.com.tw

The address and road map of all our labs can be found in our web site also.

7. APPENDIX A - MODIFICATIONS RECORDERS FOR ENGINEERING CHANGES TO THE EUT BY THE LAB

No any modifications are made to the EUT by the lab during the test.

--- END ---