

# ELECTROMAGNETIC EMISSIONS COMPLIANCE REPORT

## INTENTIONAL RADIATOR CERTIFICATION TO FCC PART 27 SUBPART C

OF

**Product Name:** WWAN M.2 LTE Module

**Brand Name:** AzureWave

**Model No.:** WW-MF070

**Model Difference:** N/A

**FCC ID:** TLZ-MF070

**Report No.:** ER/2014/70029

**Issue Date:** Jul. 15, 2014

**FCC Rule Part:** 2 & 27

**Prepared for:** Azurewave Technologies, Inc  
8F., No.94, Baozhong Rd., Xindian, New Taipei  
City, Taiwan 231

**Prepared by:** SGS Taiwan Ltd.  
Electronics & Communication Laboratory  
No.134, Wu Kung Road, New Taipei Industrial  
Park, Wuku District, New Taipei City, Taiwan  
24803

*Note: This report shall not be reproduced except in full, without the written approval of SGS Lionwan Ltd. This document may be altered or revised by SGS Lionwan Ltd. personnel only, and shall be noted in the revision section of the document.*

Unless otherwise stated the results shown in this test report refer only to the sample(s) tested and such sample(s) are retained for 90 days only.

除非另有說明，此報告結果僅對測試之樣品負責，同時此樣品僅保留90天。本報告未經本公司書面許可，不可部份複製。

This document is issued by the Company subject to its General Conditions of Service printed overleaf, available on request or accessible at [www.sgs.com/terms\\_and\\_conditions.htm](http://www.sgs.com/terms_and_conditions.htm) and, for electronic format documents, subject to Terms and Conditions for Electronic Documents at [www.sgs.com/terms\\_e-document.htm](http://www.sgs.com/terms_e-document.htm). Attention is drawn to the limitation of liability, indemnification and jurisdiction issues defined therein. Any holder of this document is advised that information contained hereon reflects the Company's findings at the time of its intervention only and within the limits of Client's instructions, if any. The Company's sole responsibility is to its Client and this document does not exonerate parties to a transaction from exercising all their rights and obligations under the transaction documents. This document cannot be reproduced except in full, without prior written approval of the Company. Any unauthorized alteration, forgery or falsification of the content or appearance of this document is unlawful and offenders may be prosecuted to the fullest extent of the law.

SGS Taiwan Ltd.

No.134,WuKungRoad,NewTaipeiIndustrialPark,WukuDistrict,NewTaipeiCity,Taiwan24803/新北市五股區新北產業園區五工路134號

台灣檢驗科技股份有限公司

t (886-2) 2299-3279

f (886-2) 2298-0488

[www.tw.sgs.com](http://www.tw.sgs.com)

Member of SGS Group

## VERIFICATION OF COMPLIANCE

**Applicant:** Azurewave Technologies, Inc  
 8F., No.94, Baozhong Rd., Xindian, New Taipei City , Taiwan 231

**Product Name:** WWAN M.2 LTE Module

**Brand Name:** AzureWave

**Model No.:** WW-MF070

**Model Difference:** N/A

**FCC ID:** TLZ-MF070

**File Number:** ER/2014/70029

**Date of test:** Jul. 08, 2014 ~ Jul. 11, 2014

**Date of EUT Received:** Jul. 08, 2014

**We hereby certify that:**

The above equipment was tested by SGS Lionwan Ltd. Electronics & Communication Laboratory. The test data, data evaluation, test procedures, and equipment configurations shown in this report were made in accordance with the procedures given in TIA/EIA-603-C-2004 and the energy emitted by the sample EUT tested as described in this report is in compliance with conducted and radiated emission limits of FCC Rule PART 27.

The test results of this report relate only to the tested sample identified in this report.

**Test By:** Marcus Tseng **Date:** Jul. 15, 2014

*Marcus Tseng / Engineer*

**Prepared By:** Tiffany Kao **Date:** Jul. 15, 2014

*Tiffany Kao / Clerk*

**Approved By:** Jim Chang **Date:** Jul. 15, 2014

*Jim Chang / Supervisor*

Unless otherwise stated the results shown in this test report refer only to the sample(s) tested and such sample(s) are retained for 90 days only.

除非另有說明，此報告結果僅對測試之樣品負責，同時此樣品僅保留90天。本報告未經本公司書面許可，不可部份複製。

This document is issued by the Company subject to its General Conditions of Service printed overleaf, available on request or accessible at [www.sgs.com/terms\\_and\\_conditions.htm](http://www.sgs.com/terms_and_conditions.htm) and, for electronic format documents, subject to Terms and Conditions for Electronic Documents at [www.sgs.com/terms\\_e-document.htm](http://www.sgs.com/terms_e-document.htm). Attention is drawn to the limitation of liability, indemnification and jurisdiction issues defined therein. Any holder of this document is advised that information contained hereon reflects the Company's findings at the time of its intervention only and within the limits of Client's instructions, if any. The Company's sole responsibility is to its Client and this document does not exonerate parties to a transaction from exercising all their rights and obligations under the transaction documents. This document cannot be reproduced except in full, without prior written approval of the Company. Any unauthorized alteration, forgery or falsification of the content or appearance of this document is unlawful and offenders may be prosecuted to the fullest extent of the law.

## Version

Version No.	Date	Description
00	Jul. 15, 2014	Initial creation of document

Unless otherwise stated the results shown in this test report refer only to the sample(s) tested and such sample(s) are retained for 90 days only.

除非另有說明，此報告結果僅對測試之樣品負責，同時此樣品僅保留90天。本報告未經本公司書面許可，不可部份複製。

This document is issued by the Company subject to its General Conditions of Service printed overleaf, available on request or accessible at [www.sgs.com/terms\\_and\\_conditions.htm](http://www.sgs.com/terms_and_conditions.htm) and, for electronic format documents, subject to Terms and Conditions for Electronic Documents at [www.sgs.com/terms\\_e-document.htm](http://www.sgs.com/terms_e-document.htm). Attention is drawn to the limitation of liability, indemnification and jurisdiction issues defined therein. Any holder of this document is advised that information contained hereon reflects the Company's findings at the time of its intervention only and within the limits of Client's instructions, if any. The Company's sole responsibility is to its Client and this document does not exonerate parties to a transaction from exercising all their rights and obligations under the transaction documents. This document cannot be reproduced except in full, without prior written approval of the Company. Any unauthorized alteration, forgery or falsification of the content or appearance of this document is unlawful and offenders may be prosecuted to the fullest extent of the law.

SGS Taiwan Ltd.

No.134,WuKungRoad,NewTaipeiIndustrialPark,WukuDistrict,NewTaipeiCity,Taiwan24803/新北市五股區新北產業園區五工路 134 號

台灣檢驗科技股份有限公司

t (886-2) 2299-3279

f (886-2) 2298-0488

[www.tw.sgs.com](http://www.tw.sgs.com)

Member of SGS Group

## Table of Contents

<b>1. GENERAL PRODUCT INFORMATION</b>	<b>7</b>
1.1. Related Submittal(s) / Grant (s)	9
1.2. Test Methodology	9
1.3. Test Facility	9
1.4. Special Accessories	9
1.5. Equipment Modifications	9
<b>2. SYSTEM TEST CONFIGURATION</b>	<b>10</b>
2.1. EUT Configuration	10
2.2. EUT Exercise	10
2.3. Test Procedure	10
2.4. Measurement Equipment Used:	11
2.5. Configuration of Tested System	13
<b>3. SUMMARY OF TEST RESULTS</b>	<b>14</b>
<b>4. DESCRIPTION OF TEST MODES</b>	<b>16</b>
<b>5. MEASUREMENT UNCERLIONNTY</b>	<b>18</b>
<b>6. RF POWER OUTPUT MEASUREMENT</b>	<b>19</b>
6.1. Standard Applicable:	19
6.2. Test Set-up:	19
6.3. Measurement Procedure:	19
6.4. Measurement Equipment Used:	19
6.5. Measurement Result:	20
<b>7. PEAK TO AVERAGE RATIO</b>	<b>28</b>
7.1. Standard Applicable:	28
7.2. Test SET-UP (Block Diagram of Configuration):	28
7.3. Measurement Procedure:	28
7.4. Measurement Equipment Used:	28
7.5. Measurement Result:	28
<b>8. ERP, EIRP MEASUREMENT</b>	<b>40</b>
8.1. Standard Applicable:	40
8.2. Test SET-UP (Block Diagram of Configuration):	40
8.3. Measurement Procedure:	42
8.4. Measurement Equipment Used:	42
8.5. Measurement Result:	43
<b>9. 99% OCCUPIED BANDWIDTH MEASUREMENT</b>	<b>59</b>

Unless otherwise stated the results shown in this test report refer only to the sample(s) tested and such sample(s) are retained for 90 days only.

除非另有說明，此報告結果僅對測試之樣品負責，同時此樣品僅保留90天。本報告未經本公司書面許可，不可部份複製。

This document is issued by the Company subject to its General Conditions of Service printed overleaf, available on request or accessible at [www.sgs.com/terms\\_and\\_conditions.htm](http://www.sgs.com/terms_and_conditions.htm) and, for electronic format documents, subject to Terms and Conditions for Electronic Documents at [www.sgs.com/terms\\_e-document.htm](http://www.sgs.com/terms_e-document.htm). Attention is drawn to the limitation of liability, indemnification and jurisdiction issues defined therein. Any holder of this document is advised that information contained hereon reflects the Company's findings at the time of its intervention only and within the limits of Client's instructions, if any. The Company's sole responsibility is to its Client and this document does not exonerate parties to a transaction from exercising all their rights and obligations under the transaction documents. This document cannot be reproduced except in full, without prior written approval of the Company. Any unauthorized alteration, forgery or falsification of the content or appearance of this document is unlawful and offenders may be prosecuted to the fullest extent of the law.

9.1.	Standard Applicable: .....	59
9.2.	Test Set-up:.....	59
9.3.	Measurement Procedure:.....	59
9.4.	Measurement Equipment Used: .....	59
9.5.	Measurement Result:.....	60
<b>10.</b>	<b>OUT OF BAND EMISSION AT ANTENNA TERMINALS .....</b>	<b>86</b>
10.1.	Standard Applicable: .....	86
10.2.	Test SET-UP:.....	87
10.3.	Measurement Procedure:.....	88
10.4.	Measurement Equipment Used: .....	88
10.5.	Measurement Result:.....	89
<b>11.</b>	<b>FIELD STRENGTH OF SPURIOUS RADIATION MEASUREMENT.....</b>	<b>119</b>
11.1.	Standard Applicable: .....	119
11.2.	EUT Setup (Block Diagram of Configuration):.....	120
11.3.	Measurement Procedure:.....	121
11.4.	Measurement Equipment Used: .....	121
11.5.	Measurement Result:.....	122
<b>12.</b>	<b>FREQUENCY STABILITY V.S. TEMPERATURE MEASUREMENT .....</b>	<b>130</b>
12.1.	Standard Applicable: .....	130
12.2.	Test Set-up:.....	130
12.3.	Measurement Procedure:.....	131
12.4.	Measurement Equipment Used: .....	131
12.5.	Measurement Result:.....	132
<b>13.</b>	<b>FREQUENCY STABILITY V.S. VOLTAGE MEASUREMENT .....</b>	<b>140</b>
13.1.	Standard Applicable: .....	140
13.2.	Test Set-up:.....	140
13.3.	Measurement Procedure:.....	140
13.4.	Measurement Equipment Used: .....	140
13.5.	Measurement Result:.....	141
<b>14.</b>	<b>Maximum Permissible Exposure (MPE).....</b>	<b>149</b>
14.1.	Related Submittal(s) / Grant (s) .....	149
14.2.	Special Accessories .....	149
14.3.	Equipment Modifications .....	149
14.4.	Limitation.....	149

Unless otherwise stated the results shown in this test report refer only to the sample(s) tested and such sample(s) are retained for 90 days only.

除非另有說明，此報告結果僅對測試之樣品負責，同時此樣品僅保留90天。本報告未經本公司書面許可，不可部份複製。

This document is issued by the Company subject to its General Conditions of Service printed overleaf, available on request or accessible at [www.sgs.com/terms\\_and\\_conditions.htm](http://www.sgs.com/terms_and_conditions.htm) and, for electronic format documents, subject to Terms and Conditions for Electronic Documents at [www.sgs.com/terms\\_e-document.htm](http://www.sgs.com/terms_e-document.htm). Attention is drawn to the limitation of liability, indemnification and jurisdiction issues defined therein. Any holder of this document is advised that information contained hereon reflects the Company's findings at the time of its intervention only and within the limits of Client's instructions, if any. The Company's sole responsibility is to its Client and this document does not exonerate parties to a transaction from exercising all their rights and obligations under the transaction documents. This document cannot be reproduced except in full, without prior written approval of the Company. Any unauthorized alteration, forgery or falsification of the content or appearance of this document is unlawful and offenders may be prosecuted to the fullest extent of the law.

14.5. Maximum Permissible Exposure (MPE) Evaluation .....	150
<b>15. The Derivation of Maximum Allowable Gain.....</b>	<b>153</b>
15.1. The Justification How Gain is Derived:.....	153
15.2. Maximum Linear Gain Determination using MPE .....	154
15.3. The Computation of Maximum Allowable Linear Gain using MPE limit.....	155
15.4. The Computation of Maximum Allowable Linear Gain using ERP/EIRP limit .....	155

Unless otherwise stated the results shown in this test report refer only to the sample(s) tested and such sample(s) are retained for 90 days only.

除非另有說明，此報告結果僅對測試之樣品負責，同時此樣品僅保留90天。本報告未經本公司書面許可，不可部份複製。

This document is issued by the Company subject to its General Conditions of Service printed overleaf, available on request or accessible at [www.sgs.com/terms\\_and\\_conditions.htm](http://www.sgs.com/terms_and_conditions.htm) and, for electronic format documents, subject to Terms and Conditions for Electronic Documents at [www.sgs.com/terms\\_e-document.htm](http://www.sgs.com/terms_e-document.htm). Attention is drawn to the limitation of liability, indemnification and jurisdiction issues defined therein. Any holder of this document is advised that information contained hereon reflects the Company's findings at the time of its intervention only and within the limits of Client's instructions, if any. The Company's sole responsibility is to its Client and this document does not exonerate parties to a transaction from exercising all their rights and obligations under the transaction documents. This document cannot be reproduced except in full, without prior written approval of the Company. Any unauthorized alteration, forgery or falsification of the content or appearance of this document is unlawful and offenders may be prosecuted to the fullest extent of the law.

SGS Taiwan Ltd.

No.134,WuKungRoad,NewTaipeiIndustrialPark,WukuDistrict,NewTaipeiCity,Taiwan24803/新北市五股區新北產業園區五工路 134 號

台灣檢驗科技股份有限公司

t (886-2) 2299-3279

f (886-2) 2298-0488

[www.tw.sgs.com](http://www.tw.sgs.com)

Member of SGS Group

## 1. GENERAL PRODUCT INFORMATION

General:

Product Name:	WWAN M.2 LTE Module
Brand Name:	AzureWave
Model No.:	WW-MF070
Model difference:	N/A
Power Supply:	3.3Vdc from power supply.

LTE:

Cellular Phone Standards Frequency Range:	Operating Frequency		Rated Power
	1.4MHz BW LTE Band 4	1710.7MHz – 1754.3MHz	23 dBm
	3MHz BW LTE Band 4	1711.5MHz – 1753.5MHz	23 dBm
	5MHz BW LTE-Band 4	1712.5MHz – 1752.5MHz	23 dBm
	10MHz BW LTE-Band 4	1715MHz – 1750MHz	23 dBm
	15MHz BW LTE-Band 4	1717.5MHz – 1747.5MHz	23 dBm
	20MHz BW LTE-Band 4	1720MHz – 1745MHz	23 dBm
	5MHz BW LTE-Band 13	779.5MHz – 784.5MHz	23 dBm
	10MHz BW LTE-Band 13	782MHz - 782MHz	23 dBm
IMEI:	356000040333916		
Hardware Version:	v03		
Software Version:	v14.5		

This test report applies for LTE Band 4 and Band 13.

Unless otherwise stated the results shown in this test report refer only to the sample(s) tested and such sample(s) are retained for 90 days only.

除非另有說明，此報告結果僅對測試之樣品負責，同時此樣品僅保留90天。本報告未經本公司書面許可，不可部份複製。

This document is issued by the Company subject to its General Conditions of Service printed overleaf, available on request or accessible at [www.sgs.com/terms\\_and\\_conditions.htm](http://www.sgs.com/terms_and_conditions.htm) and, for electronic format documents, subject to Terms and Conditions for Electronic Documents at [www.sgs.com/terms\\_e-document.htm](http://www.sgs.com/terms_e-document.htm). Attention is drawn to the limitation of liability, indemnification and jurisdiction issues defined therein. Any holder of this document is advised that information contained hereon reflects the Company's findings at the time of its intervention only and within the limits of Client's instructions, if any. The Company's sole responsibility is to its Client and this document does not exonerate parties to a transaction from exercising all their rights and obligations under the transaction documents. This document cannot be reproduced except in full, without prior written approval of the Company. Any unauthorized alteration, forgery or falsification of the content or appearance of this document is unlawful and offenders may be prosecuted to the fullest extent of the law.

Final Amplifier Voltage and Current Information:

Test Mode	DC voltage (V)	DC current (mA)
LTE B4 1.4M QPSK	3.3	779
LTE B4 3M 16QAM	3.3	752
LTE B4 5M QPSK	3.3	769
LTE B4 5M 16QAM	3.3	754
LTE B4 10M QPSK	3.3	817
LTE B4 10M 16QAM	3.3	792
LTE B4 15M QPSK	3.3	807
LTE B4 15M 16QAM	3.3	779
LTE B4 20M QPSK	3.3	876
LTE B4 20M 16QAM	3.3	854
LTE B13 5M QPSK	3.3	754
LTE B13 5M 16QAM	3.3	709
LTE B13 10M QPSK	3.3	768
LTE B13 10M 16QAM	3.3	712

Unless otherwise stated the results shown in this test report refer only to the sample(s) tested and such sample(s) are retained for 90 days only.

除非另有說明，此報告結果僅對測試之樣品負責，同時此樣品僅保留90天。本報告未經本公司書面許可，不可部份複製。

This document is issued by the Company subject to its General Conditions of Service printed overleaf, available on request or accessible at [www.sgs.com/terms\\_and\\_conditions.htm](http://www.sgs.com/terms_and_conditions.htm) and, for electronic format documents, subject to Terms and Conditions for Electronic Documents at [www.sgs.com/terms\\_e-document.htm](http://www.sgs.com/terms_e-document.htm). Attention is drawn to the limitation of liability, indemnification and jurisdiction issues defined therein. Any holder of this document is advised that information contained hereon reflects the Company's findings at the time of its intervention only and within the limits of Client's instructions, if any. The Company's sole responsibility is to its Client and this document does not exonerate parties to a transaction from exercising all their rights and obligations under the transaction documents. This document cannot be reproduced except in full, without prior written approval of the Company. Any unauthorized alteration, forgery or falsification of the content or appearance of this document is unlawful and offenders may be prosecuted to the fullest extent of the law.



### 1.1. Related Submittal(s) / Grant (s)

This submittal(s) (test report) is intended for **FCC ID: TLZ-MF070** filing to comply with Section Part 27 subpart C of the FCC CFR 47 Rules.

### 1.2. Test Methodology

Both conducted and radiated testing were performed according to the procedures document of TIA/EIA 603C and FCC CFR 47.1046, 2.1047, 2.1049, 2.1051, 2.1053, 2.1055 and 2.1057.

The Output power Procedure of KDB941225 (SAR Measurement Procedures for 3G devices, WCDMA / HSPA / LTE) was used for EUT and Base station setting.

KDB971168 D01 Power Meas license Digital System v01 as the supplemental guideline to conduct the measurement, including Peak to Power Average Ratio, Average Power over the fundamental signal BW (EIRP/ERP) and Signal Bandwidth.

### 1.3. Test Facility

The measurement facilities used to collect the 3m/10m Radiated Emission and AC power line conducted data are located on the address of SGS Taiwan Ltd. Electronics & Communication Laboratory No.134, Wu Kung Road, New Taipei Industrial Park, Wuku District, New Taipei City, Taiwan 24803 which are constructed and calibrated to meet the FCC requirements in documents ANSI C63.4: 2009. FCC Registration Number (2.948 listed) is: 990257

All equipment is calibrated externally and traceable to SI (International System of Unit).

### 1.4. Special Accessories

Not available for this EUT intended for grant.

### 1.5. Equipment Modifications

Not available for this EUT intended for grant.

Unless otherwise stated the results shown in this test report refer only to the sample(s) tested and such sample(s) are retained for 90 days only.

除非另有說明，此報告結果僅對測試之樣品負責，同時此樣品僅保留90天。本報告未經本公司書面許可，不可部份複製。

This document is issued by the Company subject to its General Conditions of Service printed overleaf, available on request or accessible at [www.sgs.com/terms\\_and\\_conditions.htm](http://www.sgs.com/terms_and_conditions.htm) and, for electronic format documents, subject to Terms and Conditions for Electronic Documents at [www.sgs.com/terms\\_e-document.htm](http://www.sgs.com/terms_e-document.htm). Attention is drawn to the limitation of liability, indemnification and jurisdiction issues defined therein. Any holder of this document is advised that information contained hereon reflects the Company's findings at the time of its intervention only and within the limits of Client's instructions, if any. The Company's sole responsibility is to its Client and this document does not exonerate parties to a transaction from exercising all their rights and obligations under the transaction documents. This document cannot be reproduced except in full, without prior written approval of the Company. Any unauthorized alteration, forgery or falsification of the content or appearance of this document is unlawful and offenders may be prosecuted to the fullest extent of the law.

## 2. SYSTEM TEST CONFIGURATION

### 2.1. EUT Configuration

The EUT configuration for testing is installed on RF field strength measurement to meet the Commissions requirement and operating in a manner which intends to maximize its emission characteristics in a continuous normal application.

### 2.2. EUT Exercise

The EUT (Transmitter) was operated in the engineering mode to fix the Tx frequency which was for the purpose of the measurements.

### 2.3. Test Procedure

#### 2.3.1 AC Power Line Conducted Emissions

The EUT is placed on a turn table which is 0.8 m above ground plane. According to the requirements in Section 7 and 13 of ANSI C63.4: 2009. Conducted emissions from the EUT measured in the frequency range between 0.15 MHz and 30MHz using CISPR Quasi-Peak and Average detector mode.

N/A, for the given application

#### 2.3.2 Conducted Measurement at Antenna Port:

According to measurement procured TIA/EIA 603C, the EUT is placed on a turn table which is 0.8 m above ground plane. A low loss of RF cable was used to connect the antenna port of EUT to measurement equipment.

#### 2.3.3 Radiated Emissions (ERP/EIRP):

According to measurement procured TIA/EIA 603C, The EUT is a placed on as turn table which is 0.8 m above ground plane. The turn table shall rotate 360 degrees to determine the position of maximum emission level. EUT is set 3m away from the receiving antenna which varied from 1m to 4m to find out the highest emission. And also, each emission was to be maximized by changing the polarization of receiving antenna both Horizontal and Vertical. In order to find out the max. emission, the relative positions of this hand-held transmitter (EUT) was rotated through three orthogonal axes and measurement procedures for electric field radiated emissions above 1 GHz the EUT measurement is to be made “while keeping the antenna in the ‘cone of radiation’ from that area and pointed at the area both in azimuth and elevation, with polarization oriented for maximum response.” is still within the 3dB illumination BW of the measurement antenna according to the requirements in Section 8 and 13 of ANSI C63.4:2009.

Unless otherwise stated the results shown in this test report refer only to the sample(s) tested and such sample(s) are retained for 90 days only.

除非另有說明，此報告結果僅對測試之樣品負責，同時此樣品僅保留90天。本報告未經本公司書面許可，不可部份複製。

This document is issued by the Company subject to its General Conditions of Service printed overleaf, available on request or accessible at [www.sgs.com/terms\\_and\\_conditions.htm](http://www.sgs.com/terms_and_conditions.htm) and, for electronic format documents, subject to Terms and Conditions for Electronic Documents at [www.sgs.com/terms\\_e-document.htm](http://www.sgs.com/terms_e-document.htm). Attention is drawn to the limitation of liability, indemnification and jurisdiction issues defined therein. Any holder of this document is advised that information contained hereon reflects the Company's findings at the time of its intervention only and within the limits of Client's instructions, if any. The Company's sole responsibility is to its Client and this document does not exonerate parties to a transaction from exercising all their rights and obligations under the transaction documents. This document cannot be reproduced except in full, without prior written approval of the Company. Any unauthorized alteration, forgery or falsification of the content or appearance of this document is unlawful and offenders may be prosecuted to the fullest extent of the law.

**2.4. Measurement Equipment Used:**

Conducted Emission (measured at antenna port) Test Site					
EQUIPMENT TYPE	MFR	MODEL NUMBER	SERIAL NUMBER	LAST CAL.	CAL DUE.
Spectrum Analyzer	Agilent	E4446A	MY51100003	05/19/2014	05/18/2015
Spectrum Analyzer	Agilent	E4440A	US41160416	03/08/2014	03/07/2015
Radio Communication Analyzer	R & S	CMU200	116097	03/11/2014	03/10/2015
Radio Communication Analyzer	Anritsu	MT8820C	6200995019	10/21/2013	10/20/2014
Temperature Chamber	TERCHY	MHG-120LF	911009	05/07/2014	05/06/2015
DC Block	Mini-Circuits	BLK-18-S+	1	02/27/2014	02/26/2015
Attenuator	Mini-Circuit	BW-S10W2+	002	02/27/2014	02/26/2015
Splitter	Agilent	11636B	N/A	02/27/2014	02/26/2015
DC Power Supply	Agilent	E3640A	KR93300208	07/24/2013	07/23/2014

Unless otherwise stated the results shown in this test report refer only to the sample(s) tested and such sample(s) are retained for 90 days only.

除非另有說明，此報告結果僅對測試之樣品負責，同時此樣品僅保留90天。本報告未經本公司書面許可，不可部份複製。

This document is issued by the Company subject to its General Conditions of Service printed overleaf, available on request or accessible at [www.sgs.com/terms\\_and\\_conditions.htm](http://www.sgs.com/terms_and_conditions.htm) and, for electronic format documents, subject to Terms and Conditions for Electronic Documents at [www.sgs.com/terms\\_e-document.htm](http://www.sgs.com/terms_e-document.htm). Attention is drawn to the limitation of liability, indemnification and jurisdiction issues defined therein. Any holder of this document is advised that information contained hereon reflects the Company's findings at the time of its intervention only and within the limits of Client's instructions, if any. The Company's sole responsibility is to its Client and this document does not exonerate parties to a transaction from exercising all their rights and obligations under the transaction documents. This document cannot be reproduced except in full, without prior written approval of the Company. Any unauthorized alteration, forgery or falsification of the content or appearance of this document is unlawful and offenders may be prosecuted to the fullest extent of the law.

SGS Taiwan Ltd.

No.134,WuKungRoad,NewTaipeiIndustrialPark,WukuDistrict,NewTaipeiCity,Taiwan24803/新北市五股區新北產業園區五工路 134 號

台灣檢驗科技股份有限公司

t (886-2) 2299-3279

f (886-2) 2298-0488

[www.tw.sgs.com](http://www.tw.sgs.com)

Member of SGS Group

ERP, EIRP MEASUREMENT EQUIPMENT List 966 Chamber					
EQUIPMENT TYPE	MFR	MODEL NUMBER	SERIAL NUMBER	LAST CAL.	CAL DUE.
Spectrum Analyzer	Agilent	E4446A	MY51100003	05/19/2014	05/18/2015
EXA Spectrum Analyzer	Agilent	N9010A	MY50420195	01/20/2014	01/19/2015
Spectrum Analyzer	R&S	FSV-30	101398	10/22/2013	10/21/2014
Bilog Antenna	SCHWAZBECK	VULB9168	378	01/02/2014	01/01/2015
Bilog Antenna	SCHWAZBECK	VULB9160	3158	11/27/2013	11/26/2014
Horn antenna	ETS.LINDGREN	3117	123995	05/19/2014	05/18/2015
Horn antenna	ETS.LINDGREN	3117	123991	01/20/2014	01/19/2015
Horn Antenna	Schwarzbeck	BBHA9170	184	01/23/2014	01/22/2015
Horn Antenna	Schwarzbeck	BBHA9170	185	07/19/2013	07/18/2014
Network Analyze	Anritsu	MS4644A	1216312	05/24/2014	05/23/2015
Signal Generator	Agilent	E4438C	MY45093613	07/30/2013	07/29/2014
Pre-Amplifier	Agilent	8447D	1937A02834	01/03/2014	01/02/2015
Pre-Amplifier	Agilent	8449B	3008A00578	01/03/2014	01/02/2015
Pre-Amplifier	EMC Instruments Corp.	EMC184045	980135	01/24/2014	01/23/2015
Attenuator	Mini-Circuit	BW-S10W2+	004	02/27/2014	02/26/2015
Radio Communication Analyzer	R & S	CMU200	116097	03/11/2014	03/10/2015
Radio Communication Analyzer	Anritsu	MT8820C	6200995019	10/21/2013	10/20/2014
Turn Table	HD	DT420	N/A	N.C.R	N.C.R
Antenna Tower	HD	MA240-N	240/657	N.C.R	N.C.R
Controller	HD	HD100	N/A	N.C.R	N.C.R
Low Loss Cable	HUBER+SUHNER	966_Tx	10m	01/03/2014	01/02/2015
Low Loss Cable	HUBER+SUHNER	966_Rx	3m	01/03/2014	01/02/2015
Filter 800-1000	Micro-Tronics	EWT	M2	02/27/2014	02/26/2015
Filter 1800-2000	Micro-Tronics	EWT	M2	02/27/2014	02/26/2015
Filter 1700-1800	Micro-Tronics	BRC15751	001	02/27/2014	02/26/2015
1GHz High Pass Filter	Micro-Tronics	HPM50108	32	02/27/2014	02/26/2015
2GHz High Pass Filter	Micro-Tronics	HPM50110	36	02/27/2014	02/26/2015
3m Site NSA	SGS	966 chamber	N/A	07/15/2013	07/14/2014

**N.C.R denotes non-calibrated require.**

Unless otherwise stated the results shown in this test report refer only to the sample(s) tested and such sample(s) are retained for 90 days only.

除非另有說明，此報告結果僅對測試之樣品負責，同時此樣品僅保留90天。本報告未經本公司書面許可，不可部份複製。

This document is issued by the Company subject to its General Conditions of Service printed overleaf, available on request or accessible at [www.sgs.com/terms\\_and\\_conditions.htm](http://www.sgs.com/terms_and_conditions.htm) and, for electronic format documents, subject to Terms and Conditions for Electronic Documents at [www.sgs.com/terms\\_e-document.htm](http://www.sgs.com/terms_e-document.htm). Attention is drawn to the limitation of liability, indemnification and jurisdiction issues defined therein. Any holder of this document is advised that information contained hereon reflects the Company's findings at the time of its intervention only and within the limits of Client's instructions, if any. The Company's sole responsibility is to its Client and this document does not exonerate parties to a transaction from exercising all their rights and obligations under the transaction documents. This document cannot be reproduced except in full, without prior written approval of the Company. Any unauthorized alteration, forgery or falsification of the content or appearance of this document is unlawful and offenders may be prosecuted to the fullest extent of the law.

## 2.5. Configuration of Tested System

**Fig. 2-1 Configuration of Tested System (Fixed Channel)**



### Remote Side

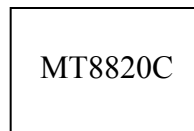

**Table 2-1 Equipment Used in Tested System**

Item	Equipment	Mfr/Brand	Model/ Type No.	Series No.	Data Cable	Power Cord
1.	DC Power Supply	HP	E3640A	KR93300208	shielded	Un-shielded
2.	Universal Radio Communication Tester	Anritsu	MT8820C	6200307563	shielded	Un-shielded

Unless otherwise stated the results shown in this test report refer only to the sample(s) tested and such sample(s) are retained for 90 days only.

除非另有說明，此報告結果僅對測試之樣品負責，同時此樣品僅保留90天。本報告未經本公司書面許可，不可部份複製。

This document is issued by the Company subject to its General Conditions of Service printed overleaf, available on request or accessible at [www.sgs.com/terms\\_and\\_conditions.htm](http://www.sgs.com/terms_and_conditions.htm) and, for electronic format documents, subject to Terms and Conditions for Electronic Documents at [www.sgs.com/terms\\_e-document.htm](http://www.sgs.com/terms_e-document.htm). Attention is drawn to the limitation of liability, indemnification and jurisdiction issues defined therein. Any holder of this document is advised that information contained hereon reflects the Company's findings at the time of its intervention only and within the limits of Client's instructions, if any. The Company's sole responsibility is to its Client and this document does not exonerate parties to a transaction from exercising all their rights and obligations under the transaction documents. This document cannot be reproduced except in full, without prior written approval of the Company. Any unauthorized alteration, forgery or falsification of the content or appearance of this document is unlawful and offenders may be prosecuted to the fullest extent of the law.

### 3. SUMMARY OF TEST RESULTS

FCC Rules	Description Of Test	Result
§2.1046(a)	RF Power Output	Compliant
§2.1046(a) §27.50(c)(9) §27.50(d)(4)	ERP/ EIRP measurement	Compliant
§2.1049(h)	99% Occupied Bandwidth	Compliant
§2.1051 §27.53(g) §27.53(c)(2) §27.50(c)(5) §27.53(h)	Out of Band Emissions at Antenna Terminals and Band Edge	Compliant
§2.1053 §27.53(c)(2) §27.50(c)(5) §27.53(g) §27.53(h)	Field Strength of Spurious Radiation	Compliant
§27.50(i) (B)	Peak to Average Ratio	Compliant
§27.53(f)	Spurious emission in 1559 -1610MHz Band	Compliant
§2.1055(a)(1) §27.54	Frequency Stability vs. Temperature	Compliant
§2.1055(d)(1) §27.54	Frequency Stability vs. Voltage	Compliant

Unless otherwise stated the results shown in this test report refer only to the sample(s) tested and such sample(s) are retained for 90 days only.

除非另有說明，此報告結果僅對測試之樣品負責，同時此樣品僅保留90天。本報告未經本公司書面許可，不可部份複製。

This document is issued by the Company subject to its General Conditions of Service printed overleaf, available on request or accessible at [www.sgs.com/terms\\_and\\_conditions.htm](http://www.sgs.com/terms_and_conditions.htm) and, for electronic format documents, subject to Terms and Conditions for Electronic Documents at [www.sgs.com/terms\\_e-document.htm](http://www.sgs.com/terms_e-document.htm). Attention is drawn to the limitation of liability, indemnification and jurisdiction issues defined therein. Any holder of this document is advised that information contained hereon reflects the Company's findings at the time of its intervention only and within the limits of Client's instructions, if any. The Company's sole responsibility is to its Client and this document does not exonerate parties to a transaction from exercising all their rights and obligations under the transaction documents. This document cannot be reproduced except in full, without prior written approval of the Company. Any unauthorized alteration, forgery or falsification of the content or appearance of this document is unlawful and offenders may be prosecuted to the fullest extent of the law.

Max ERP/EIRP measurement result:

	dBm		W
LTE Band 4/1.4MMz/QPSK RB 1 Offset 0	26.49	EIRP	0.446
LTE Band 4/1.4MMz/16QAM RB 1 Offset 0	26.65	EIRP	0.462
LTE Band 4/1.4MMz/QPSK RB 1 Offset 5	26.54	EIRP	0.451
LTE Band 4/1.4MMz/16QAM RB 1 Offset 5	26.73	EIRP	0.471
LTE Band 4/3MMz/QPSK RB 1 Offset 0	26.64	EIRP	0.461
LTE Band 4/3MMz/16QAM RB 1 Offset 0	26.82	EIRP	0.481
LTE Band 4/3MMz/QPSK RB 1 Offset 14	26.46	EIRP	0.443
LTE Band 4/3MMz/16QAM RB 1 Offset 14	26.70	EIRP	0.468
LTE Band 4/5MMz/QPSK RB 1 Offset 0	27.38	EIRP	0.547
LTE Band 4/5MMz/16QAM RB 1 Offset 0	27.39	EIRP	0.548
LTE Band 4/5MMz/QPSK RB 1 Offset 24	26.30	EIRP	0.427
LTE Band 4/5MMz/16QAM RB 1 Offset 24	26.48	EIRP	0.445
LTE Band 4/10MMz/QPSK RB 1 Offset 0	27.58	EIRP	0.573
LTE Band 4/10MMz/16QAM RB 1 Offset 0	27.75	EIRP	0.596
LTE Band 4/10MMz/QPSK RB 1 Offset 49	25.94	EIRP	0.393
LTE Band 4/10MMz/16QAM RB 1 Offset 49	26.17	EIRP	0.414
LTE Band 4/15MMz/QPSK RB 1 Offset 0	27.67	EIRP	0.585
LTE Band 4/15MMz/16QAM RB 1 Offset 0	27.75	EIRP	0.596
LTE Band 4/15MMz/QPSK RB 1 Offset 74	26.06	EIRP	0.404
LTE Band 4/15MMz/16QAM RB 1 Offset 74	26.29	EIRP	0.426
LTE Band 4/20MMz/QPSK RB 1 Offset 0	27.88	EIRP	0.614
LTE Band 4/20MMz/16QAM RB 1 Offset 0	28.02	EIRP	0.634
LTE Band 4/20MMz/QPSK RB 1 Offset 99	28.27	EIRP	0.671
LTE Band 4/20MMz/16QAM RB 1 Offset 99	28.15	EIRP	0.653
LTE Band 13/5MMz/QPSK RB 1 Offset 0	22.20	ERP	0.166
LTE Band 13/5MMz/16QAM RB 1 Offset 0	23.36	ERP	0.217
LTE Band 13/5MMz/QPSK RB 1 Offset 24	22.90	ERP	0.195
LTE Band 13/5MMz/16QAM RB 1 Offset 24	23.46	ERP	0.222
LTE Band 13/10MMz/QPSK RB 1 Offset 0	21.88	ERP	0.154
LTE Band 13/10MMz/16QAM RB 1 Offset 0	23.01	ERP	0.200
LTE Band 13/10MMz/QPSK RB 1 Offset 49	22.44	ERP	0.175
LTE Band 13/10MMz/16QAM RB 1 Offset 49	23.33	ERP	0.215

Unless otherwise stated the results shown in this test report refer only to the sample(s) tested and such sample(s) are retained for 90 days only.

除非另有說明，此報告結果僅對測試之樣品負責，同時此樣品僅保留90天。本報告未經本公司書面許可，不可部份複製。

This document is issued by the Company subject to its General Conditions of Service printed overleaf, available on request or accessible at [www.sgs.com/terms\\_and\\_conditions.htm](http://www.sgs.com/terms_and_conditions.htm) and, for electronic format documents, subject to Terms and Conditions for Electronic Documents at [www.sgs.com/terms\\_e-document.htm](http://www.sgs.com/terms_e-document.htm). Attention is drawn to the limitation of liability, indemnification and jurisdiction issues defined therein. Any holder of this document is advised that information contained hereon reflects the Company's findings at the time of its intervention only and within the limits of Client's instructions, if any. The Company's sole responsibility is to its Client and this document does not exonerate parties to a transaction from exercising all their rights and obligations under the transaction documents. This document cannot be reproduced except in full, without prior written approval of the Company. Any unauthorized alteration, forgery or falsification of the content or appearance of this document is unlawful and offenders may be prosecuted to the fullest extent of the law.

#### 4. DESCRIPTION OF TEST MODES

The EUT has been tested under operating condition with continuous transmitting mode, linking to simulator.

Channel Low, Mid and High is set to test against each supported band with rated data rate that yields the highest emission.

The field strength of spurious radiation emission was measured as stand-up position (E2 mode as defined in Lab) and lie down position with 90 degrees angle apart (H, E1 mode as defines in Lab) for LTE Band 4 and 13. The worst-case position in E2 is placed to conduct all applicable measurement test cases for all supported modulation, transmission bandwidth, and frequency band.

##### **The evaluation of Test Mode as configured in UE presented on the Test Report:**

The Measurement Data of field strength of spurious emission with respect to supported configuration of given application (Transmission Band, Modulation Scheme, Resource Block) have been pre-scanned, and the result that yields in the highest emission close to the limit are presented on the test report.

In comparison among all Out of Band Emission at Antenna Terminal and Bandedge in the variety of combination on LTE band 4 & 13, respectively, It's revealed to generate the highest emission at 1.4M, 3M, 5M, 10M, 15MHz and 20M Transmission Bandwidth for band LTE 4 while RB size = 1 with 0 offset and RB size = 1 with 99 offset for 20MHz of LTE band 4. The highest emission at 5MHz and 10MHz transmission Bandwidth for LTE band 13 with RB size =1 with 24 offset and RB size = 1 with 0 offset. Be aware of that only data measurement that yields the worst measurement with supported modulation scheme (QPSK, 16QAM), QPSK- the worst are shown on the corresponding section.

Unless otherwise stated the results shown in this test report refer only to the sample(s) tested and such sample(s) are retained for 90 days only.

除非另有說明，此報告結果僅對測試之樣品負責，同時此樣品僅保留90天。本報告未經本公司書面許可，不可部份複製。

This document is issued by the Company subject to its General Conditions of Service printed overleaf, available on request or accessible at [www.sgs.com/terms\\_and\\_conditions.htm](http://www.sgs.com/terms_and_conditions.htm) and, for electronic format documents, subject to Terms and Conditions for Electronic Documents at [www.sgs.com/terms\\_e-document.htm](http://www.sgs.com/terms_e-document.htm). Attention is drawn to the limitation of liability, indemnification and jurisdiction issues defined therein. Any holder of this document is advised that information contained hereon reflects the Company's findings at the time of its intervention only and within the limits of Client's instructions, if any. The Company's sole responsibility is to its Client and this document does not exonerate parties to a transaction from exercising all their rights and obligations under the transaction documents. This document cannot be reproduced except in full, without prior written approval of the Company. Any unauthorized alteration, forgery or falsification of the content or appearance of this document is unlawful and offenders may be prosecuted to the fullest extent of the law.



<b>Band 4</b>		
<b>QPSK</b>		
	Low Channel	High Channel
1.4MHz	RB Size = 1 ; Offset = 0	RB Size = 1 ; Offset = 5
3MHz	RB Size = 1 ; Offset = 0	RB Size = 1 ; Offset = 14
5MHz	RB Size = 1 ; Offset = 0	RB Size = 1 ; Offset = 24
10MHz	RB Size = 1 ; Offset = 0	RB Size = 1 ; Offset = 49
15MHz	RB Size = 1 ; Offset = 0	RB Size = 1 ; Offset = 74
20MHz	RB Size = 1 ; Offset = 0	RB Size = 1 ; Offset = 99

<b>Band 13</b>		
<b>QPSK</b>		
	Low Channel	High Channel
5MHz	RB Size = 1 ; Offset = 0	RB Size = 1 ; Offset = 24
10MHz	RB Size = 1 ; Offset = 0	

For Peak to Average Ratio test, all combination (RB arrangement with different modulation scheme) has been evaluated, the data with the following setting: RB number = 6; Offset = 0 for 1.4MHz with 16QAM, RB number = 15; Offset = 0 for 3MHz with 16QAM RB number = 25; Offset = 0 for 5MHz with 16QAM, RB number = 50; Offset = 0 for 10MHz with 16QAM, RB number = 75; Offset = 0 for 15MHz with 16QAM, and RB number = 100; Offset = 0 for 20MHz with 16QAM are shown as representative plot on the report for LTE Band 4.

For Peak to Average Ratio test, all combination (RB arrangement with different modulation scheme) has been evaluated, the data with the following setting: RB number = 25; Offset = 0 for 5MHz with 16QAM, RB number = 50; Offset = 0 for 10MHz with 16QAM are shown as representative plot on the report for LTE Band 13.

Unless otherwise stated the results shown in this test report refer only to the sample(s) tested and such sample(s) are retained for 90 days only.

除非另有說明，此報告結果僅對測試之樣品負責，同時此樣品僅保留90天。本報告未經本公司書面許可，不可部份複製。

This document is issued by the Company subject to its General Conditions of Service printed overleaf, available on request or accessible at [www.sgs.com/terms\\_and\\_conditions.htm](http://www.sgs.com/terms_and_conditions.htm) and, for electronic format documents, subject to Terms and Conditions for Electronic Documents at [www.sgs.com/terms\\_e-document.htm](http://www.sgs.com/terms_e-document.htm). Attention is drawn to the limitation of liability, indemnification and jurisdiction issues defined therein. Any holder of this document is advised that information contained hereon reflects the Company's findings at the time of its intervention only and within the limits of Client's instructions, if any. The Company's sole responsibility is to its Client and this document does not exonerate parties to a transaction from exercising all their rights and obligations under the transaction documents. This document cannot be reproduced except in full, without prior written approval of the Company. Any unauthorized alteration, forgery or falsification of the content or appearance of this document is unlawful and offenders may be prosecuted to the fullest extent of the law.

**5. MEASUREMENT UNCERLIONNTY**

Test Items	Uncertainty
RF Power Output	+/- 1.42 dB
ERP/ EIRP measurement	Vertical Polarization = +/- 4.74dB Horizontal Polarization = +/- 4.62dB
99% Occupied Bandwidth	+/- 123.36 Hz
Out of Band Emissions at Antenna Terminals and Band Edge	+/- 1.55 dB
Peak to Average Ratio	+/- 1.55 dB
Frequency Stability vs. Temperature	+/- 123.36 Hz
Frequency Stability vs. Voltage	+/- 123.36 Hz
Temperature	+/- 0.8 °C
Humidity	+/- 4.7 %
DC / AC Power Source	DC= +/- 1%, AC= +/- 0.2%

**Radiated Spurious Emission:**

Measurement uncertainty (Polarization : <b>Vertical</b> )	30MHz - 180MHz: +/- 3.37dB
	180MHz -417MHz: +/- 3.19dB
	0.417GHz-1GHz: +/- 3.19dB
	1GHz - 18GHz: +/- 4.04dB
	18GHz - 40GHz: +/- 4.04dB

Measurement uncertainty (Polarization : <b>Horizontal</b> )	30MHz - 167MHz: +/- 4.22dB
	167MHz -500MHz: +/- 3.44dB
	0.5GHz-1GHz: +/- 3.39dB
	1GHz - 18GHz: +/- 4.08dB
	18GHz - 40GHz: +/- 4.08dB

This uncertainty represents an expanded uncertainty expressed at approximately the 95% confidence level using a coverage factor of k=2

Unless otherwise stated the results shown in this test report refer only to the sample(s) tested and such sample(s) are retained for 90 days only.

除非另有說明，此報告結果僅對測試之樣品負責，同時此樣品僅保留90天。本報告未經本公司書面許可，不可部份複製。

This document is issued by the Company subject to its General Conditions of Service printed overleaf, available on request or accessible at [www.sgs.com/terms\\_and\\_conditions.htm](http://www.sgs.com/terms_and_conditions.htm) and, for electronic format documents, subject to Terms and Conditions for Electronic Documents at [www.sgs.com/terms\\_e-document.htm](http://www.sgs.com/terms_e-document.htm). Attention is drawn to the limitation of liability, indemnification and jurisdiction issues defined therein. Any holder of this document is advised that information contained hereon reflects the Company's findings at the time of its intervention only and within the limits of Client's instructions, if any. The Company's sole responsibility is to its Client and this document does not exonerate parties to a transaction from exercising all their rights and obligations under the transaction documents. This document cannot be reproduced except in full, without prior written approval of the Company. Any unauthorized alteration, forgery or falsification of the content or appearance of this document is unlawful and offenders may be prosecuted to the fullest extent of the law.

## 6. RF POWER OUTPUT MEASUREMENT

### 6.1. Standard Applicable:

According to FCC §2.1046.

### 6.2. Test Set-up:

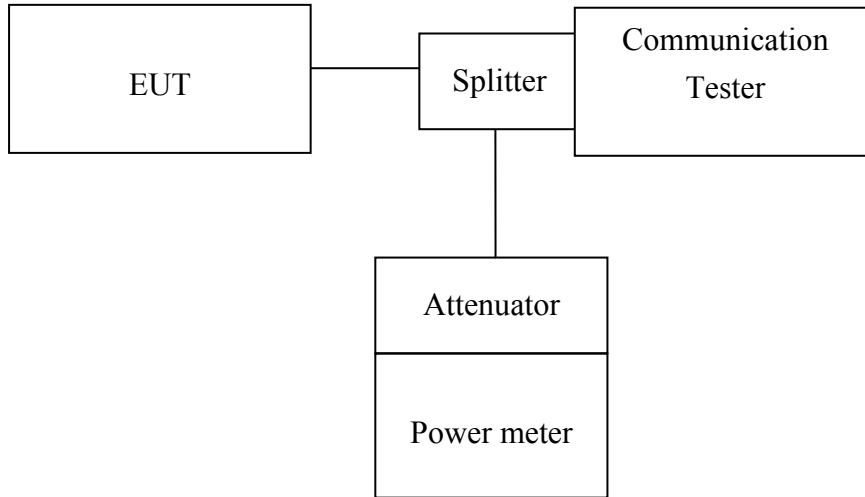

*Note: Measurement setup for testing on Antenna connector*

### 6.3. Measurement Procedure:

The transmitter output was connected to a calibrated attenuator, the other end of which was connected to a power meter. Transmitter output was read off the power meter in dBm. The power output at the transmitter antenna port was determined by adding the value of the attenuator to the power meter reading. The Procedure of KDB941225 (SAR Measurement Procedures for 3G devices, LTE) was used for EUT and Base station setting. RMC 12.2kps is used for this testing

### 6.4. Measurement Equipment Used:

Refer to section 2.4 in this report

Unless otherwise stated the results shown in this test report refer only to the sample(s) tested and such sample(s) are retained for 90 days only.

除非另有說明，此報告結果僅對測試之樣品負責，同時此樣品僅保留90天。本報告未經本公司書面許可，不可部份複製。

This document is issued by the Company subject to its General Conditions of Service printed overleaf, available on request or accessible at [www.sgs.com/terms\\_and\\_conditions.htm](http://www.sgs.com/terms_and_conditions.htm) and, for electronic format documents, subject to Terms and Conditions for Electronic Documents at [www.sgs.com/terms\\_e-document.htm](http://www.sgs.com/terms_e-document.htm). Attention is drawn to the limitation of liability, indemnification and jurisdiction issues defined therein. Any holder of this document is advised that information contained hereon reflects the Company's findings at the time of its intervention only and within the limits of Client's instructions, if any. The Company's sole responsibility is to its Client and this document does not exonerate parties to a transaction from exercising all their rights and obligations under the transaction documents. This document cannot be reproduced except in full, without prior written approval of the Company. Any unauthorized alteration, forgery or falsification of the content or appearance of this document is unlawful and offenders may be prosecuted to the fullest extent of the law.

6.5. Measurement Result:

6.5.1.1.: MPR Table

LTE Band 4 \_1.4 MHz

BW (MHz)	Modulation	Channel	Frequency (MHz)	RB Size	RB Offset	Conducted power(dBm)
1.4	QPSK	19957	1710.7	1	0	22.76
				1	5	22.70
				3	2	22.76
				6	0	21.86
		20175	1732.5	1	0	23.67
				1	5	23.70
				3	2	23.68
				6	0	22.74
		20393	1754.3	1	0	<b>24.09</b>
				1	5	23.99
				3	2	24.00
				6	0	23.23
1.4	16 QAM	19957	1710.7	1	0	21.88
				1	5	21.78
				3	2	21.81
				6	0	21.82
		20175	1732.5	1	0	22.96
				1	5	23.11
				3	2	22.64
				6	0	21.81
		20393	1754.3	1	0	23.60
				1	5	23.19
				3	2	23.15
				6	0	22.24

Unless otherwise stated the results shown in this test report refer only to the sample(s) tested and such sample(s) are retained for 90 days only.

除非另有說明，此報告結果僅對測試之樣品負責，同時此樣品僅保留90天。本報告未經本公司書面許可，不可部份複製。

This document is issued by the Company subject to its General Conditions of Service printed overleaf, available on request or accessible at [www.sgs.com/terms\\_and\\_conditions.htm](http://www.sgs.com/terms_and_conditions.htm) and, for electronic format documents, subject to Terms and Conditions for Electronic Documents at [www.sgs.com/terms\\_e-document.htm](http://www.sgs.com/terms_e-document.htm). Attention is drawn to the limitation of liability, indemnification and jurisdiction issues defined therein. Any holder of this document is advised that information contained hereon reflects the Company's findings at the time of its intervention only and within the limits of Client's instructions, if any. The Company's sole responsibility is to its Client and this document does not exonerate parties to a transaction from exercising all their rights and obligations under the transaction documents. This document cannot be reproduced except in full, without prior written approval of the Company. Any unauthorized alteration, forgery or falsification of the content or appearance of this document is unlawful and offenders may be prosecuted to the fullest extent of the law.

**LTE Band 4\_3 MHz**

BW (MHz)	Modulation	Channel	Frequency (MHz)	RB Size	RB Offset	Conducted power(dBm)
3	QPSK	19965	1711.5	1	0	22.84
				1	14	22.97
				8	4	21.96
				15	0	21.94
		20175	1732.5	1	0	23.51
				1	14	23.72
				8	4	22.81
				15	0	22.75
		20385	1753.5	1	0	<b>24.06</b>
				1	14	23.96
				8	4	23.33
				15	0	23.26
3	16 QAM	19965	1711.5	1	0	21.90
				1	14	21.97
				8	4	21.33
				15	0	21.25
		20175	1732.5	1	0	22.57
				1	14	22.66
				8	4	21.92
				15	0	21.80
		20385	1753.5	1	0	23.02
				1	14	22.93
				8	4	22.37
				15	0	22.17

Unless otherwise stated the results shown in this test report refer only to the sample(s) tested and such sample(s) are retained for 90 days only.

除非另有說明，此報告結果僅對測試之樣品負責，同時此樣品僅保留90天。本報告未經本公司書面許可，不可部份複製。

This document is issued by the Company subject to its General Conditions of Service printed overleaf, available on request or accessible at [www.sgs.com/terms\\_and\\_conditions.htm](http://www.sgs.com/terms_and_conditions.htm) and, for electronic format documents, subject to Terms and Conditions for Electronic Documents at [www.sgs.com/terms\\_e-document.htm](http://www.sgs.com/terms_e-document.htm). Attention is drawn to the limitation of liability, indemnification and jurisdiction issues defined therein. Any holder of this document is advised that information contained hereon reflects the Company's findings at the time of its intervention only and within the limits of Client's instructions, if any. The Company's sole responsibility is to its Client and this document does not exonerate parties to a transaction from exercising all their rights and obligations under the transaction documents. This document cannot be reproduced except in full, without prior written approval of the Company. Any unauthorized alteration, forgery or falsification of the content or appearance of this document is unlawful and offenders may be prosecuted to the fullest extent of the law.

**LTE Band 4\_5 MHz**

BW (MHz)	Modulation	Channel	Frequency (MHz)	RB Size	RB Offset	Conducted power(dBm)	
5	QPSK	19975	1712.5	1	0	23.17	
				1	24	23.13	
				12	6	22.11	
				25	0	22.16	
		20175	1732.5	1732.5	1	0	23.71
					1	24	23.77
					12	6	22.81
					25	0	22.79
		20375	1752.5	1752.5	1	0	<b>24.11</b>
					1	24	23.94
					12	6	23.26
					25	0	23.25
5	16 QAM	19975	1712.5	1	0	22.51	
				1	24	22.31	
				12	6	21.34	
				25	0	21.41	
		20175	1732.5	1732.5	1	0	23.16
					1	24	23.29
					12	6	21.75
					25	0	21.84
		20375	1752.5	1752.5	1	0	23.61
					1	24	23.46
					12	6	22.21
					25	0	22.28

Unless otherwise stated the results shown in this test report refer only to the sample(s) tested and such sample(s) are retained for 90 days only.

除非另有說明，此報告結果僅對測試之樣品負責，同時此樣品僅保留90天。本報告未經本公司書面許可，不可部份複製。

This document is issued by the Company subject to its General Conditions of Service printed overleaf, available on request or accessible at [www.sgs.com/terms\\_and\\_conditions.htm](http://www.sgs.com/terms_and_conditions.htm) and, for electronic format documents, subject to Terms and Conditions for Electronic Documents at [www.sgs.com/terms\\_e-document.htm](http://www.sgs.com/terms_e-document.htm). Attention is drawn to the limitation of liability, indemnification and jurisdiction issues defined therein. Any holder of this document is advised that information contained hereon reflects the Company's findings at the time of its intervention only and within the limits of Client's instructions, if any. The Company's sole responsibility is to its Client and this document does not exonerate parties to a transaction from exercising all their rights and obligations under the transaction documents. This document cannot be reproduced except in full, without prior written approval of the Company. Any unauthorized alteration, forgery or falsification of the content or appearance of this document is unlawful and offenders may be prosecuted to the fullest extent of the law.

**LTE Band 4 \_10 MHz**

BW (MHz)	Modulation	Channel	Frequency (MHz)	RB Size	RB Offset	Conducted power(dBm)
10	QPSK	20000	1715.0	1	0	23.28
				1	49	23.59
				25	12	22.51
				50	0	22.56
		20175	1732.5	1	0	23.82
				1	49	23.87
				25	12	22.91
				50	0	22.99
		20350	1750.0	1	0	<b>24.07</b>
				1	49	23.88
				25	12	23.19
				50	0	23.20
10	16 QAM	20000	1715	1	0	22.54
				1	49	22.68
				25	12	21.51
				50	0	21.54
		20175	1732.5	1	0	22.81
				1	49	22.94
				25	12	21.90
				50	0	21.96
		20350	1750.0	1	0	23.24
				1	49	22.94
				25	12	22.30
				50	0	22.27

Unless otherwise stated the results shown in this test report refer only to the sample(s) tested and such sample(s) are retained for 90 days only.

除非另有說明，此報告結果僅對測試之樣品負責，同時此樣品僅保留90天。本報告未經本公司書面許可，不可部份複製。

This document is issued by the Company subject to its General Conditions of Service printed overleaf, available on request or accessible at [www.sgs.com/terms\\_and\\_conditions.htm](http://www.sgs.com/terms_and_conditions.htm) and, for electronic format documents, subject to Terms and Conditions for Electronic Documents at [www.sgs.com/terms\\_e-document.htm](http://www.sgs.com/terms_e-document.htm). Attention is drawn to the limitation of liability, indemnification and jurisdiction issues defined therein. Any holder of this document is advised that information contained hereon reflects the Company's findings at the time of its intervention only and within the limits of Client's instructions, if any. The Company's sole responsibility is to its Client and this document does not exonerate parties to a transaction from exercising all their rights and obligations under the transaction documents. This document cannot be reproduced except in full, without prior written approval of the Company. Any unauthorized alteration, forgery or falsification of the content or appearance of this document is unlawful and offenders may be prosecuted to the fullest extent of the law.

LTE Band 4 \_15 MHz

BW (MHz)	Modulation	Channel	Frequency (MHz)	RB Size	RB Offset	Conducted power(dBm)
15	QPSK	20025	1717.5	1	0	23.19
				1	74	23.76
				36	19	22.50
				75	0	22.58
		20175	1732.5	1	0	23.46
				1	74	23.67
				36	19	22.80
				75	0	22.77
		20325	1747.5	1	0	<b>23.82</b>
				1	74	23.31
				36	19	22.78
				75	0	22.81
15	16 QAM	20025	1717.5	1	0	22.51
				1	74	23.18
				36	19	21.41
				75	0	21.50
		20175	1732.5	1	0	22.79
				1	74	23.06
				36	19	21.76
				75	0	21.74
		20325	1747.5	1	0	23.17
				1	74	22.72
				36	19	21.79
				75	0	21.82

Unless otherwise stated the results shown in this test report refer only to the sample(s) tested and such sample(s) are retained for 90 days only.

除非另有說明，此報告結果僅對測試之樣品負責，同時此樣品僅保留90天。本報告未經本公司書面許可，不可部份複製。

This document is issued by the Company subject to its General Conditions of Service printed overleaf, available on request or accessible at [www.sgs.com/terms\\_and\\_conditions.htm](http://www.sgs.com/terms_and_conditions.htm) and, for electronic format documents, subject to Terms and Conditions for Electronic Documents at [www.sgs.com/terms\\_e-document.htm](http://www.sgs.com/terms_e-document.htm). Attention is drawn to the limitation of liability, indemnification and jurisdiction issues defined therein. Any holder of this document is advised that information contained hereon reflects the Company's findings at the time of its intervention only and within the limits of Client's instructions, if any. The Company's sole responsibility is to its Client and this document does not exonerate parties to a transaction from exercising all their rights and obligations under the transaction documents. This document cannot be reproduced except in full, without prior written approval of the Company. Any unauthorized alteration, forgery or falsification of the content or appearance of this document is unlawful and offenders may be prosecuted to the fullest extent of the law.



LTE Band 4 \_20 MHz

BW (MHz)	Modulation	Channel	Frequency (MHz)	RB Size	RB Offset	Conducted power(dBm)
20	QPSK	20050	1720.0	1	0	23.71
				1	99	<b>24.58</b>
				50	25	22.91
				100	0	23.02
		20175	1732.5	1	0	23.94
				1	99	24.10
				50	25	23.17
				100	0	23.20
		20300	1745.0	1	0	24.06
				1	99	23.67
				50	25	23.06
				100	0	23.15
20	16 QAM	20050	1720	1	0	22.71
				1	99	23.69
				50	25	21.94
				100	0	22.05
		20175	1732.5	1	0	22.89
				1	99	23.23
				50	25	22.11
				100	0	22.15
		20300	1745	1	0	23.45
				1	99	23.06
				50	25	22.07
				100	0	22.14

Unless otherwise stated the results shown in this test report refer only to the sample(s) tested and such sample(s) are retained for 90 days only.

除非另有說明，此報告結果僅對測試之樣品負責，同時此樣品僅保留90天。本報告未經本公司書面許可，不可部份複製。

This document is issued by the Company subject to its General Conditions of Service printed overleaf, available on request or accessible at [www.sgs.com/terms\\_and\\_conditions.htm](http://www.sgs.com/terms_and_conditions.htm) and, for electronic format documents, subject to Terms and Conditions for Electronic Documents at [www.sgs.com/terms\\_e-document.htm](http://www.sgs.com/terms_e-document.htm). Attention is drawn to the limitation of liability, indemnification and jurisdiction issues defined therein. Any holder of this document is advised that information contained hereon reflects the Company's findings at the time of its intervention only and within the limits of Client's instructions, if any. The Company's sole responsibility is to its Client and this document does not exonerate parties to a transaction from exercising all their rights and obligations under the transaction documents. This document cannot be reproduced except in full, without prior written approval of the Company. Any unauthorized alteration, forgery or falsification of the content or appearance of this document is unlawful and offenders may be prosecuted to the fullest extent of the law.

LTE Band 13 \_5 MHz

BW (MHz)	Modulation	Channel	Frequency (MHz)	RB Size	RB Offset	Conducted power(dBm)		
5	QPSK	23205	779.5	1	0	<b>23.27</b>		
				1	24	22.94		
				12	6	21.96		
				25	0	22.09		
		23230	782.0	23230	782.0	1	0	23.06
						1	24	23.16
						12	6	22.19
						25	0	22.18
		23255	784.5	23255	784.5	1	0	23.18
						1	24	23.15
						12	6	22.21
						25	0	22.28
5	16 QAM	23205	779.5	1	0	22.35		
				1	24	22.17		
				12	6	21.02		
				25	0	21.11		
		23230	782.0	23230	782.0	1	0	22.24
						1	24	22.37
						12	6	21.24
						25	0	21.22
		23255	784.5	23255	784.5	1	0	22.43
						1	24	22.43
						12	6	21.25
						25	0	21.26

Unless otherwise stated the results shown in this test report refer only to the sample(s) tested and such sample(s) are retained for 90 days only.

除非另有說明，此報告結果僅對測試之樣品負責，同時此樣品僅保留90天。本報告未經本公司書面許可，不可部份複製。

This document is issued by the Company subject to its General Conditions of Service printed overleaf, available on request or accessible at [www.sgs.com/terms\\_and\\_conditions.htm](http://www.sgs.com/terms_and_conditions.htm) and, for electronic format documents, subject to Terms and Conditions for Electronic Documents at [www.sgs.com/terms\\_e-document.htm](http://www.sgs.com/terms_e-document.htm). Attention is drawn to the limitation of liability, indemnification and jurisdiction issues defined therein. Any holder of this document is advised that information contained hereon reflects the Company's findings at the time of its intervention only and within the limits of Client's instructions, if any. The Company's sole responsibility is to its Client and this document does not exonerate parties to a transaction from exercising all their rights and obligations under the transaction documents. This document cannot be reproduced except in full, without prior written approval of the Company. Any unauthorized alteration, forgery or falsification of the content or appearance of this document is unlawful and offenders may be prosecuted to the fullest extent of the law.

**LTE Band 13 \_10 MHz**

BW (MHz)	Modulation	Channel	Frequency (MHz)	RB Size	RB Offset	Conducted power(dBm)
10	QPSK	23230	782.0	1	0	<b>23.43</b>
				1	49	23.24
				25	12	22.14
				50	0	22.27
10	16 QAM	23230	782.0	1	0	22.44
				1	49	22.27
				25	12	21.15
				50	0	21.16

Unless otherwise stated the results shown in this test report refer only to the sample(s) tested and such sample(s) are retained for 90 days only.

除非另有說明，此報告結果僅對測試之樣品負責，同時此樣品僅保留90天。本報告未經本公司書面許可，不可部份複製。

This document is issued by the Company subject to its General Conditions of Service printed overleaf, available on request or accessible at [www.sgs.com/terms\\_and\\_conditions.htm](http://www.sgs.com/terms_and_conditions.htm) and, for electronic format documents, subject to Terms and Conditions for Electronic Documents at [www.sgs.com/terms\\_e-document.htm](http://www.sgs.com/terms_e-document.htm). Attention is drawn to the limitation of liability, indemnification and jurisdiction issues defined therein. Any holder of this document is advised that information contained hereon reflects the Company's findings at the time of its intervention only and within the limits of Client's instructions, if any. The Company's sole responsibility is to its Client and this document does not exonerate parties to a transaction from exercising all their rights and obligations under the transaction documents. This document cannot be reproduced except in full, without prior written approval of the Company. Any unauthorized alteration, forgery or falsification of the content or appearance of this document is unlawful and offenders may be prosecuted to the fullest extent of the law.

SGS Taiwan Ltd.

No.134,WuKungRoad,NewTaipeiIndustrialPark,WukuDistrict,NewTaipeiCity,Taiwan24803/新北市五股區新北產業園區五工路 134 號

台灣檢驗科技股份有限公司

t (886-2) 2299-3279

f (886-2) 2298-0488

[www.tw.sgs.com](http://www.tw.sgs.com)

Member of SGS Group

## 7. PEAK TO AVERAGE RATIO

### 7.1. Standard Applicable:

FCC 27.50(i) (B)

Peak transmit power shall be measured over any interval of continuous transmission using instrumentation calibrated in terms of rms-equivalent voltage.

The measurement results shall be properly adjusted for any instrument limitations, such as detector response times, limited resolution bandwidth capability when compared to the emission bandwidth, etc., so as to obtain a true peak measurement for the emission in question over the full bandwidth of the channel.

To measure transmissions in this band using an average power technique, the peak to-average ratio (PAR) of the transmission shall not exceed 13 dB.

### 7.2. Test SET-UP (Block Diagram of Configuration):

Refer to section 6.2 in this report

### 7.3. Measurement Procedure:

Set resolution/measurement bandwidth  $\geq$  signal's occupied bandwidth;

Set the number of counts to a value that stabilizes the measured CCDF curve;

### 7.4. Measurement Equipment Used:

Refer to section 2.4 in this report.

### 7.5. Measurement Result:

Refer to next page for plot.

Unless otherwise stated the results shown in this test report refer only to the sample(s) tested and such sample(s) are retained for 90 days only.

除非另有說明，此報告結果僅對測試之樣品負責，同時此樣品僅保留90天。本報告未經本公司書面許可，不可部份複製。

This document is issued by the Company subject to its General Conditions of Service printed overleaf, available on request or accessible at [www.sgs.com/terms\\_and\\_conditions.htm](http://www.sgs.com/terms_and_conditions.htm) and, for electronic format documents, subject to Terms and Conditions for Electronic Documents at [www.sgs.com/terms\\_e-document.htm](http://www.sgs.com/terms_e-document.htm). Attention is drawn to the limitation of liability, indemnification and jurisdiction issues defined therein. Any holder of this document is advised that information contained hereon reflects the Company's findings at the time of its intervention only and within the limits of Client's instructions, if any. The Company's sole responsibility is to its Client and this document does not exonerate parties to a transaction from exercising all their rights and obligations under the transaction documents. This document cannot be reproduced except in full, without prior written approval of the Company. Any unauthorized alteration, forgery or falsification of the content or appearance of this document is unlawful and offenders may be prosecuted to the fullest extent of the law.

Figure 7-1: 1.4MHz BW LTE-Band 4(16QAM Number: 6 Offset: 0) Channel Low

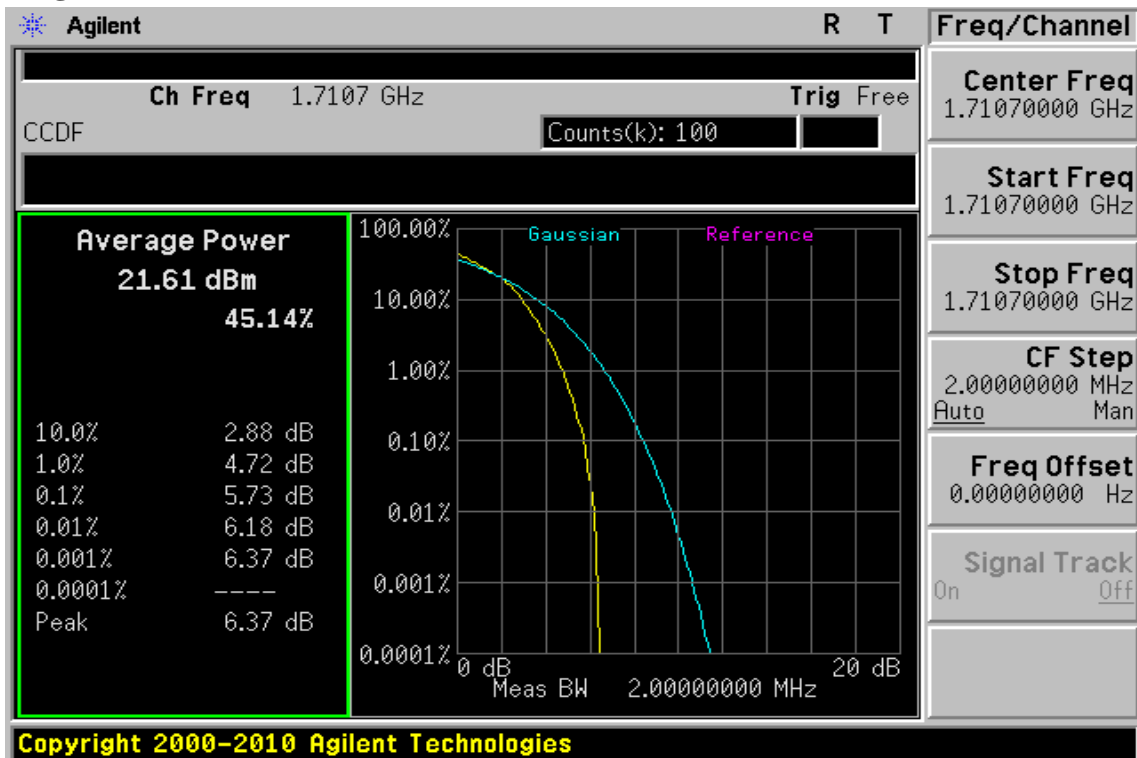
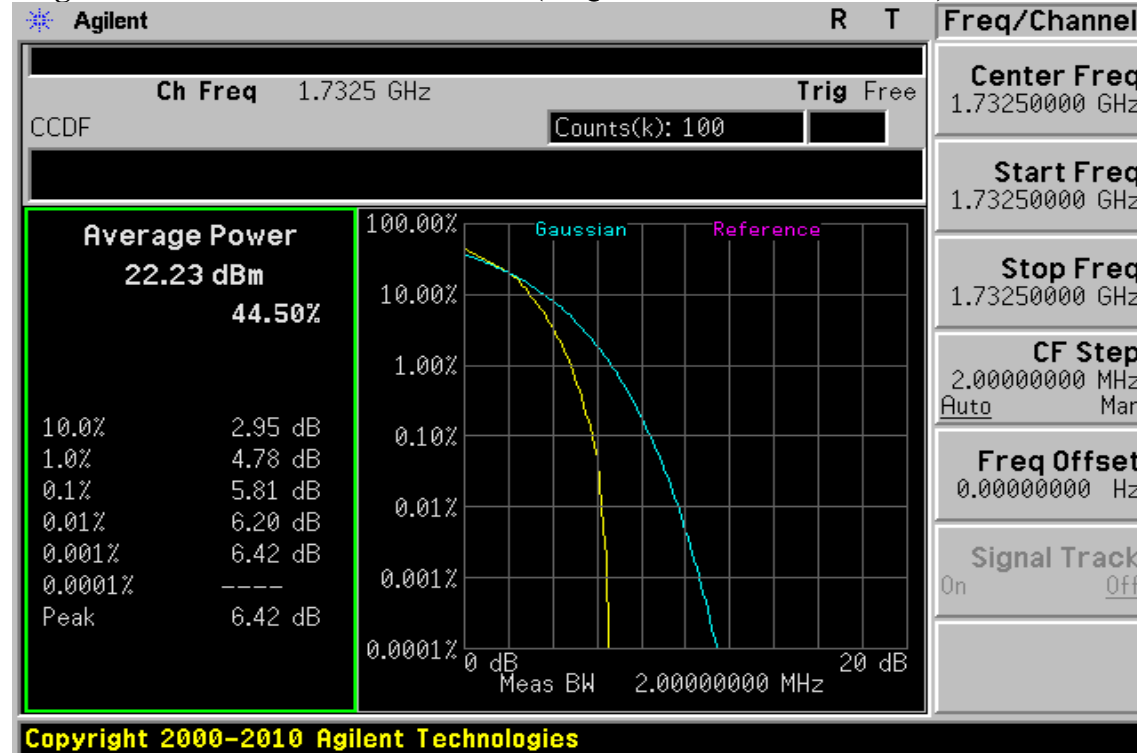

Figure 7-2: 1.4MHz BW LTE-Band 4(16QAM Number: 6 Offset: 0) Channel Mid



Unless otherwise stated the results shown in this test report refer only to the sample(s) tested and such sample(s) are retained for 90 days only.

除非另有說明，此報告結果僅對測試之樣品負責，同時此樣品僅保留90天。本報告未經本公司書面許可，不可部份複製。

This document is issued by the Company subject to its General Conditions of Service printed overleaf, available on request or accessible at [www.sgs.com/terms\\_and\\_conditions.htm](http://www.sgs.com/terms_and_conditions.htm) and, for electronic format documents, subject to Terms and Conditions for Electronic Documents at [www.sgs.com/terms\\_e-document.htm](http://www.sgs.com/terms_e-document.htm). Attention is drawn to the limitation of liability, indemnification and jurisdiction issues defined therein. Any holder of this document is advised that information contained hereon reflects the Company's findings at the time of its intervention only and within the limits of Client's instructions, if any. The Company's sole responsibility is to its Client and this document does not exonerate parties to a transaction from exercising all their rights and obligations under the transaction documents. This document cannot be reproduced except in full, without prior written approval of the Company. Any unauthorized alteration, forgery or falsification of the content or appearance of this document is unlawful and offenders may be prosecuted to the fullest extent of the law.

Figure 7-3: 1.4MHz BW LTE-Band 4(16QAM Number: 6 Offset: 0) Channel High

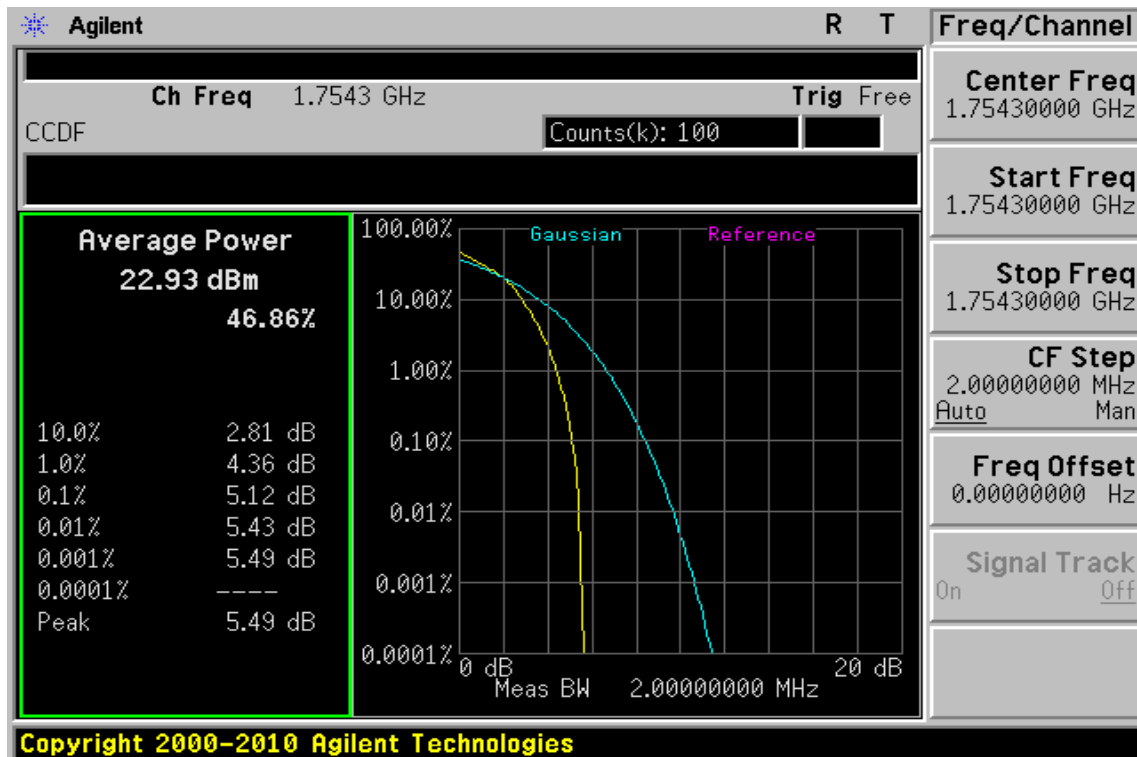
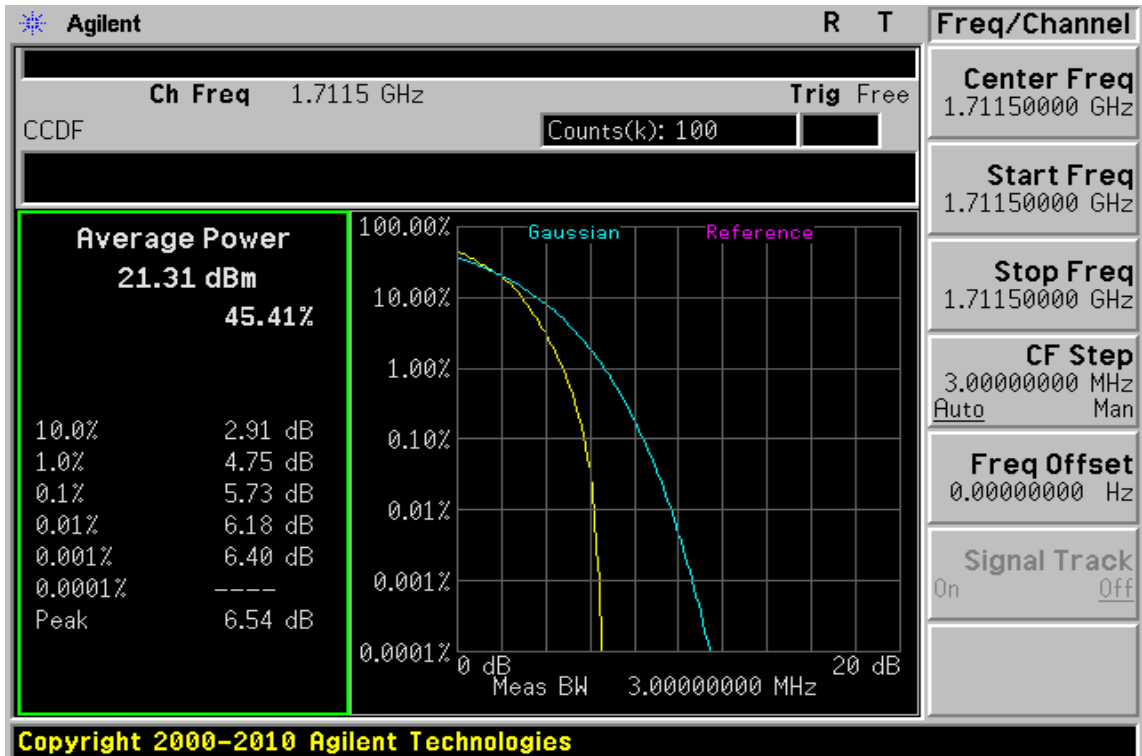

Figure 7-4: 3MHz BW LTE-Band 4(16QAM Number: 15 Offset: 0) Channel Low



Unless otherwise stated the results shown in this test report refer only to the sample(s) tested and such sample(s) are retained for 90 days only.

除非另有說明，此報告結果僅對測試之樣品負責，同時此樣品僅保留90天。本報告未經本公司書面許可，不可部份複製。

This document is issued by the Company subject to its General Conditions of Service printed overleaf, available on request or accessible at [www.sgs.com/terms\\_and\\_conditions.htm](http://www.sgs.com/terms_and_conditions.htm) and, for electronic format documents, subject to Terms and Conditions for Electronic Documents at [www.sgs.com/terms\\_e-document.htm](http://www.sgs.com/terms_e-document.htm). Attention is drawn to the limitation of liability, indemnification and jurisdiction issues defined therein. Any holder of this document is advised that information contained hereon reflects the Company's findings at the time of its intervention only and within the limits of Client's instructions, if any. The Company's sole responsibility is to its Client and this document does not exonerate parties to a transaction from exercising all their rights and obligations under the transaction documents. This document cannot be reproduced except in full, without prior written approval of the Company. Any unauthorized alteration, forgery or falsification of the content or appearance of this document is unlawful and offenders may be prosecuted to the fullest extent of the law.

**Figure 7-5: 3MHz BW LTE-Band 4(16QAM Number: 15 Offset: 0) Channel Mid**

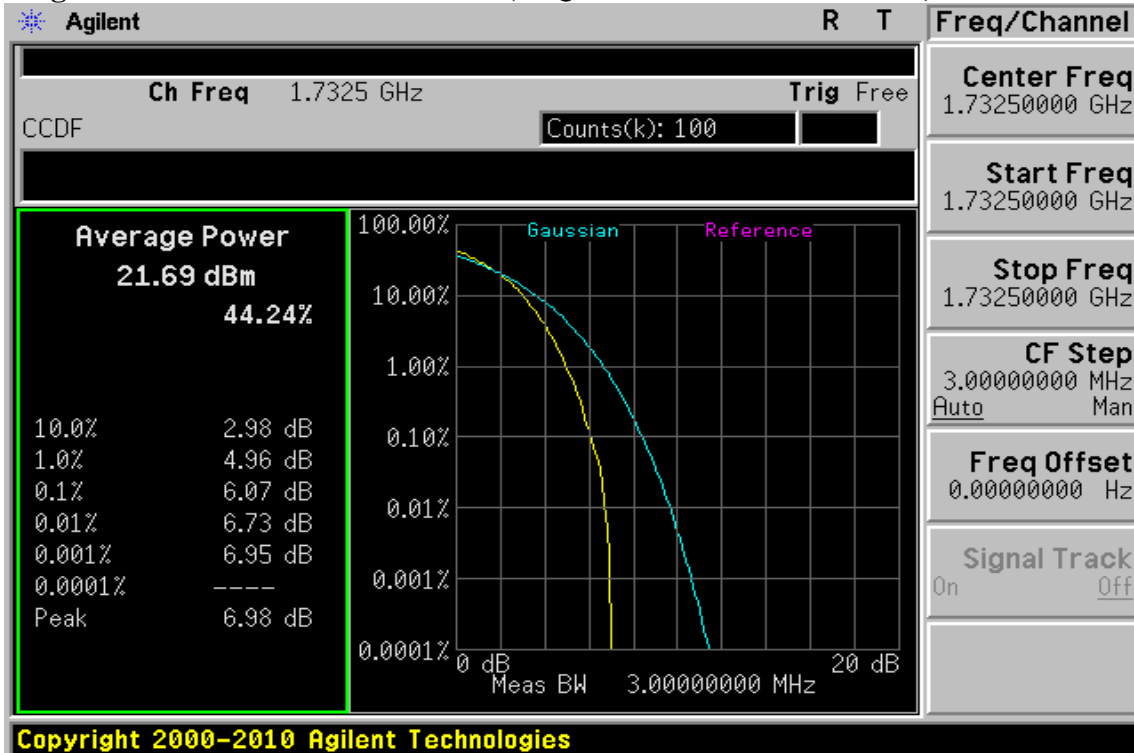

**Figure 7-6: 3MHz BW LTE-Band 4(16QAM Number: 15 Offset: 0) Channel High**

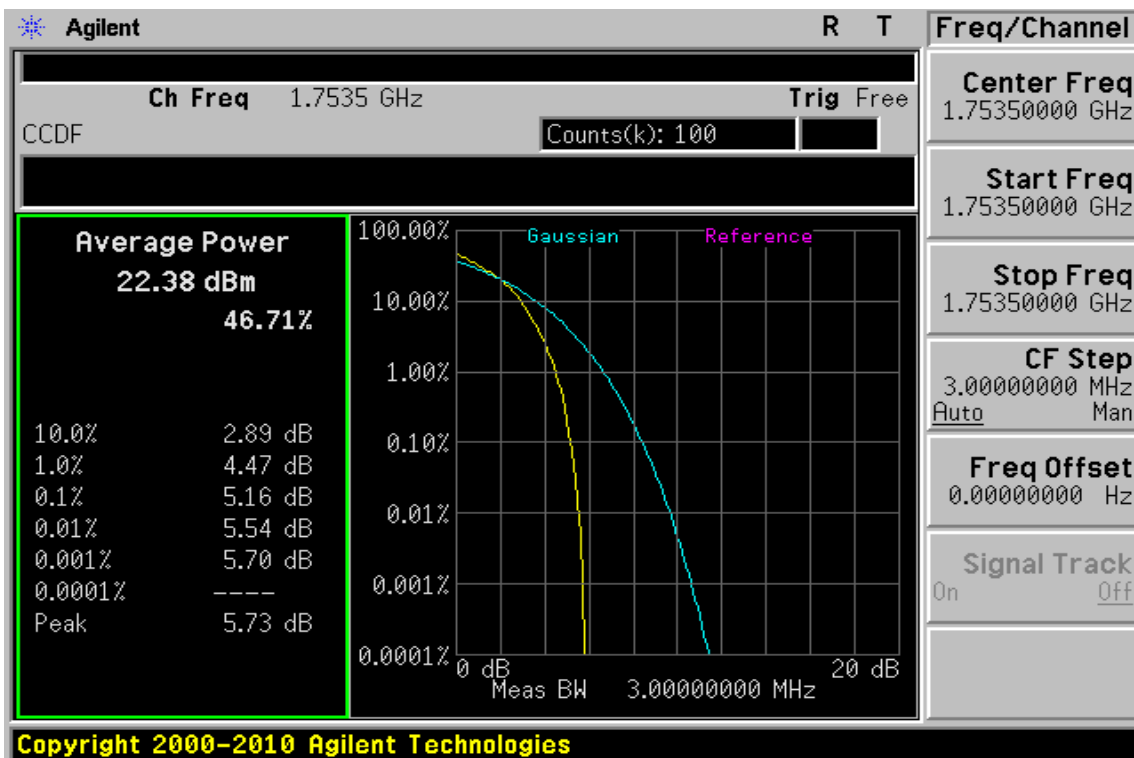

Unless otherwise stated the results shown in this test report refer only to the sample(s) tested and such sample(s) are retained for 90 days only.

除非另有說明，此報告結果僅對測試之樣品負責，同時此樣品僅保留90天。本報告未經本公司書面許可，不可部份複製。

This document is issued by the Company subject to its General Conditions of Service printed overleaf, available on request or accessible at [www.sgs.com/terms\\_and\\_conditions.htm](http://www.sgs.com/terms_and_conditions.htm) and, for electronic format documents, subject to Terms and Conditions for Electronic Documents at [www.sgs.com/terms\\_e-document.htm](http://www.sgs.com/terms_e-document.htm). Attention is drawn to the limitation of liability, indemnification and jurisdiction issues defined therein. Any holder of this document is advised that information contained hereon reflects the Company's findings at the time of its intervention only and within the limits of Client's instructions, if any. The Company's sole responsibility is to its Client and this document does not exonerate parties to a transaction from exercising all their rights and obligations under the transaction documents. This document cannot be reproduced except in full, without prior written approval of the Company. Any unauthorized alteration, forgery or falsification of the content or appearance of this document is unlawful and offenders may be prosecuted to the fullest extent of the law.

Figure 7-7: 5MHz BW LTE-Band 4(16QAM Number: 25 Offset: 0) Channel Low

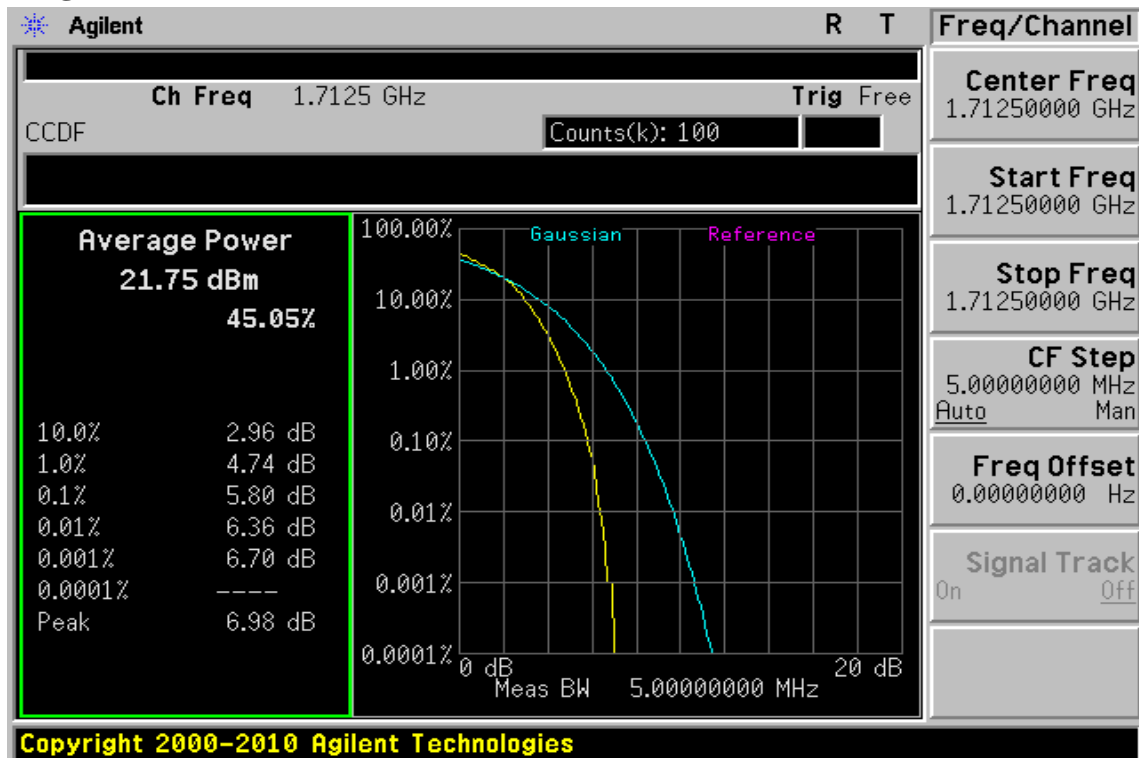
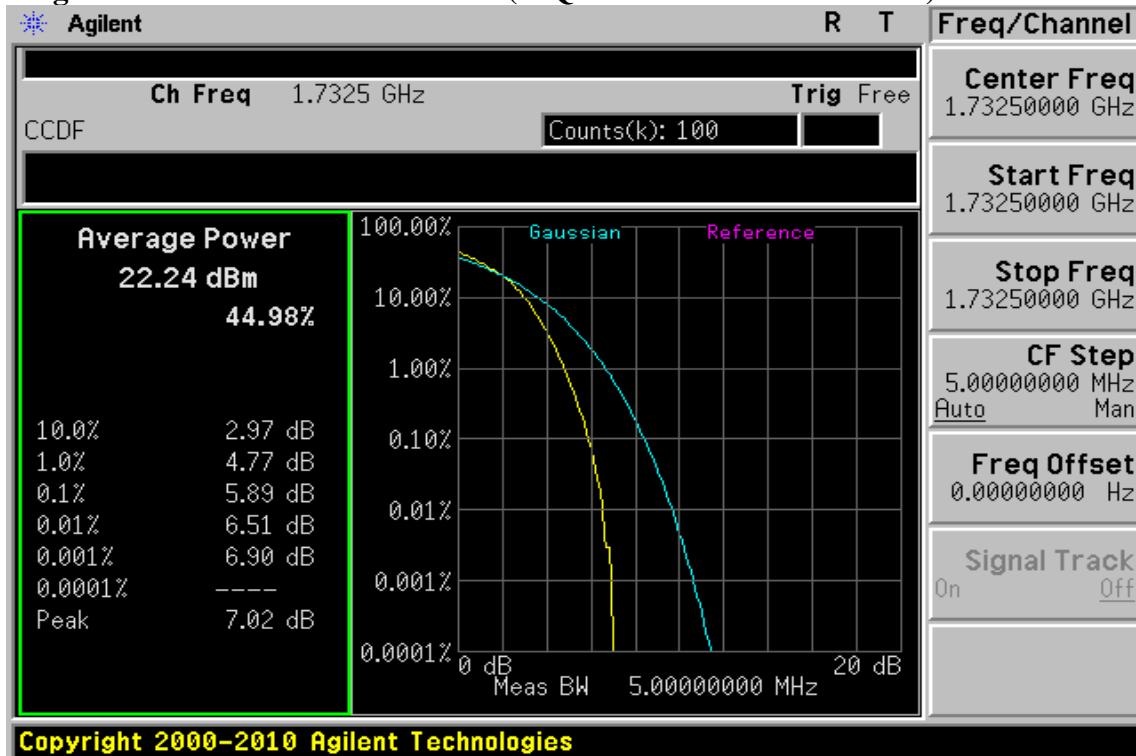

Figure 7-8: 5MHz BW LTE-Band 4(16QAM Number: 25 Offset: 0) Channel Mid



Unless otherwise stated the results shown in this test report refer only to the sample(s) tested and such sample(s) are retained for 90 days only.

除非另有說明，此報告結果僅對測試之樣品負責，同時此樣品僅保留90天。本報告未經本公司書面許可，不可部份複製。

This document is issued by the Company subject to its General Conditions of Service printed overleaf, available on request or accessible at [www.sgs.com/terms\\_and\\_conditions.htm](http://www.sgs.com/terms_and_conditions.htm) and, for electronic format documents, subject to Terms and Conditions for Electronic Documents at [www.sgs.com/terms\\_e-document.htm](http://www.sgs.com/terms_e-document.htm). Attention is drawn to the limitation of liability, indemnification and jurisdiction issues defined therein. Any holder of this document is advised that information contained hereon reflects the Company's findings at the time of its intervention only and within the limits of Client's instructions, if any. The Company's sole responsibility is to its Client and this document does not exonerate parties to a transaction from exercising all their rights and obligations under the transaction documents. This document cannot be reproduced except in full, without prior written approval of the Company. Any unauthorized alteration, forgery or falsification of the content or appearance of this document is unlawful and offenders may be prosecuted to the fullest extent of the law.



**Figure 7-9: 5MHz BW LTE-Band 4(16QAM Number: 25 Offset: 0) Channel High**

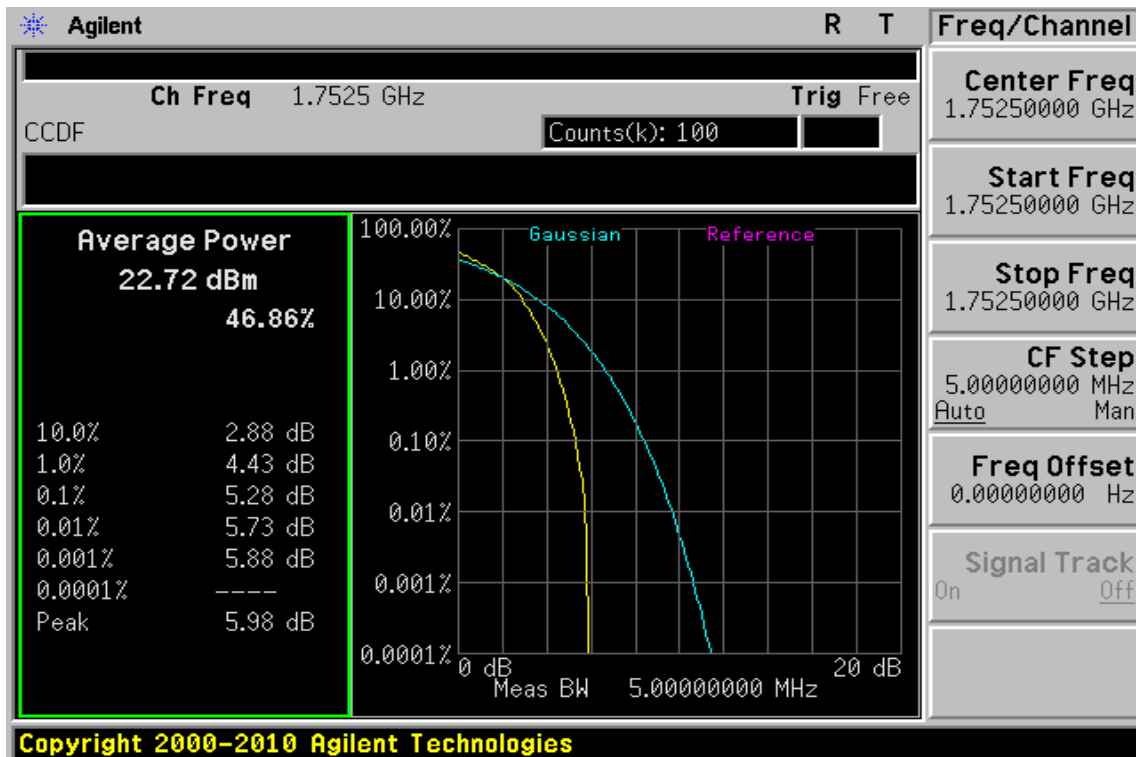

**Figure 7-10: 10MHz BW LTE-Band 4(16QAM Number: 50 Offset: 0) Channel Low**

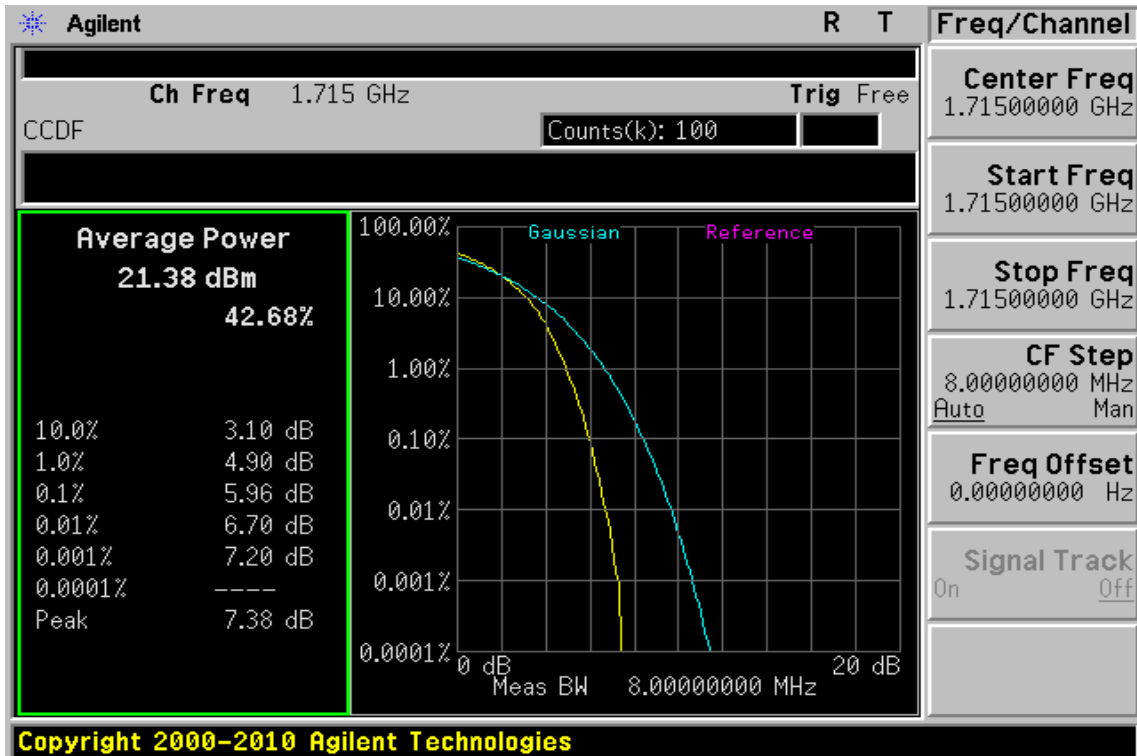

Unless otherwise stated the results shown in this test report refer only to the sample(s) tested and such sample(s) are retained for 90 days only.

除非另有說明，此報告結果僅對測試之樣品負責，同時此樣品僅保留90天。本報告未經本公司書面許可，不可部份複製。

This document is issued by the Company subject to its General Conditions of Service printed overleaf, available on request or accessible at [www.sgs.com/terms\\_and\\_conditions.htm](http://www.sgs.com/terms_and_conditions.htm) and, for electronic format documents, subject to Terms and Conditions for Electronic Documents at [www.sgs.com/terms\\_e-document.htm](http://www.sgs.com/terms_e-document.htm). Attention is drawn to the limitation of liability, indemnification and jurisdiction issues defined therein. Any holder of this document is advised that information contained hereon reflects the Company's findings at the time of its intervention only and within the limits of Client's instructions, if any. The Company's sole responsibility is to its Client and this document does not exonerate parties to a transaction from exercising all their rights and obligations under the transaction documents. This document cannot be reproduced except in full, without prior written approval of the Company. Any unauthorized alteration, forgery or falsification of the content or appearance of this document is unlawful and offenders may be prosecuted to the fullest extent of the law.

Figure 7-11: 10MHz BW LTE-Band 4(16QAM Number: 50 Offset: 0) Channel Mid

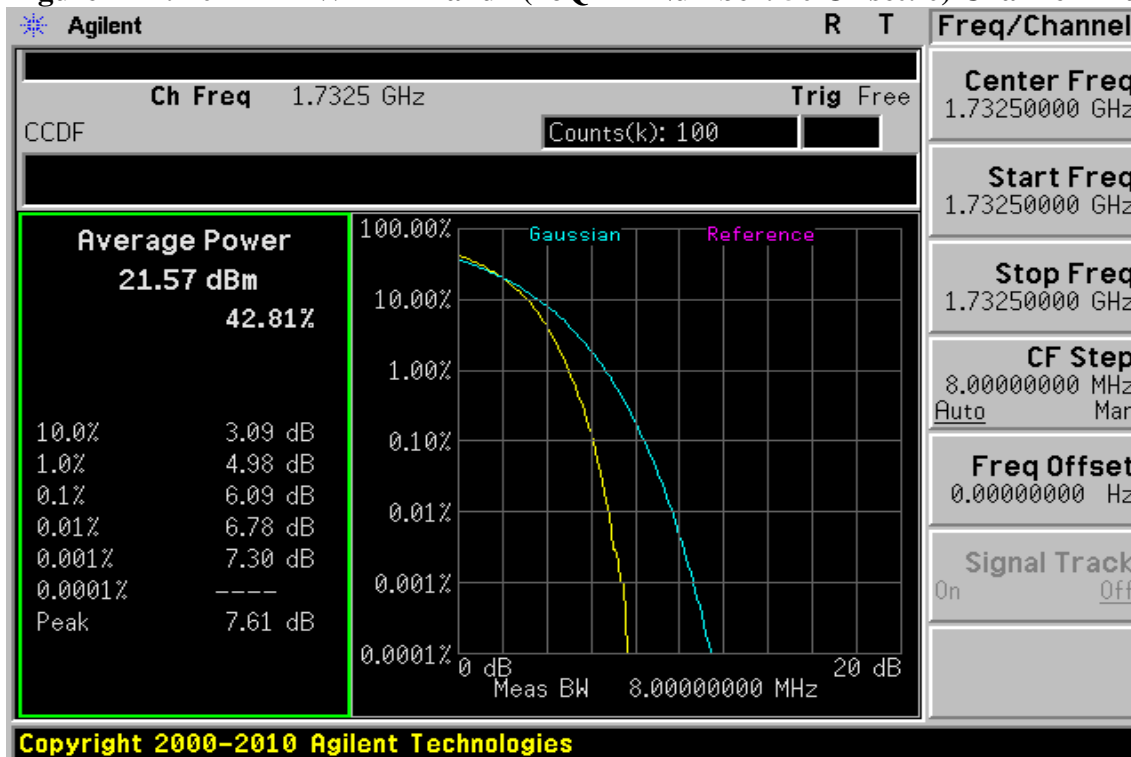
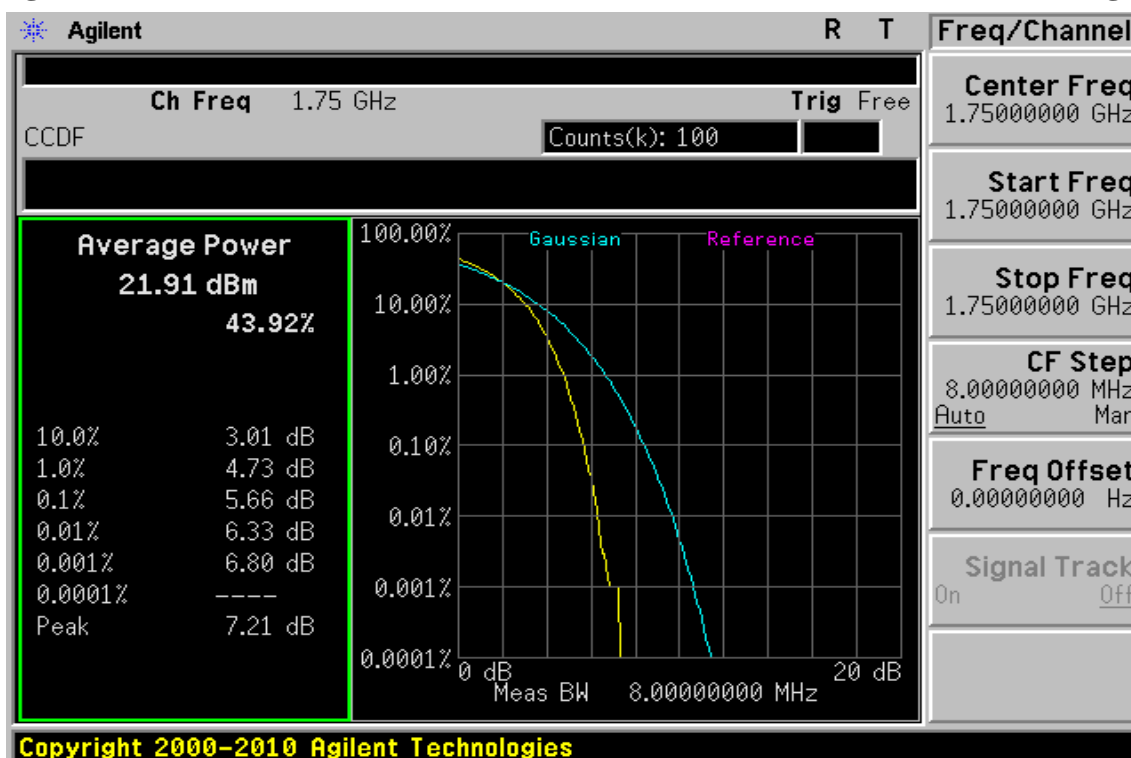

Figure 7-12: 10MHz BW LTE-Band 4(16QAM Number: 50 Offset: 0) Channel High



Unless otherwise stated the results shown in this test report refer only to the sample(s) tested and such sample(s) are retained for 90 days only.

除非另有說明，此報告結果僅對測試之樣品負責，同時此樣品僅保留90天。本報告未經本公司書面許可，不可部份複製。

This document is issued by the Company subject to its General Conditions of Service printed overleaf, available on request or accessible at [www.sgs.com/terms\\_and\\_conditions.htm](http://www.sgs.com/terms_and_conditions.htm) and, for electronic format documents, subject to Terms and Conditions for Electronic Documents at [www.sgs.com/terms\\_e-document.htm](http://www.sgs.com/terms_e-document.htm). Attention is drawn to the limitation of liability, indemnification and jurisdiction issues defined therein. Any holder of this document is advised that information contained hereon reflects the Company's findings at the time of its intervention only and within the limits of Client's instructions, if any. The Company's sole responsibility is to its Client and this document does not exonerate parties to a transaction from exercising all their rights and obligations under the transaction documents. This document cannot be reproduced except in full, without prior written approval of the Company. Any unauthorized alteration, forgery or falsification of the content or appearance of this document is unlawful and offenders may be prosecuted to the fullest extent of the law.

Figure 7-13: 15MHz BW LTE-Band 4(16QAM Number: 75 Offset: 0) Channel Low

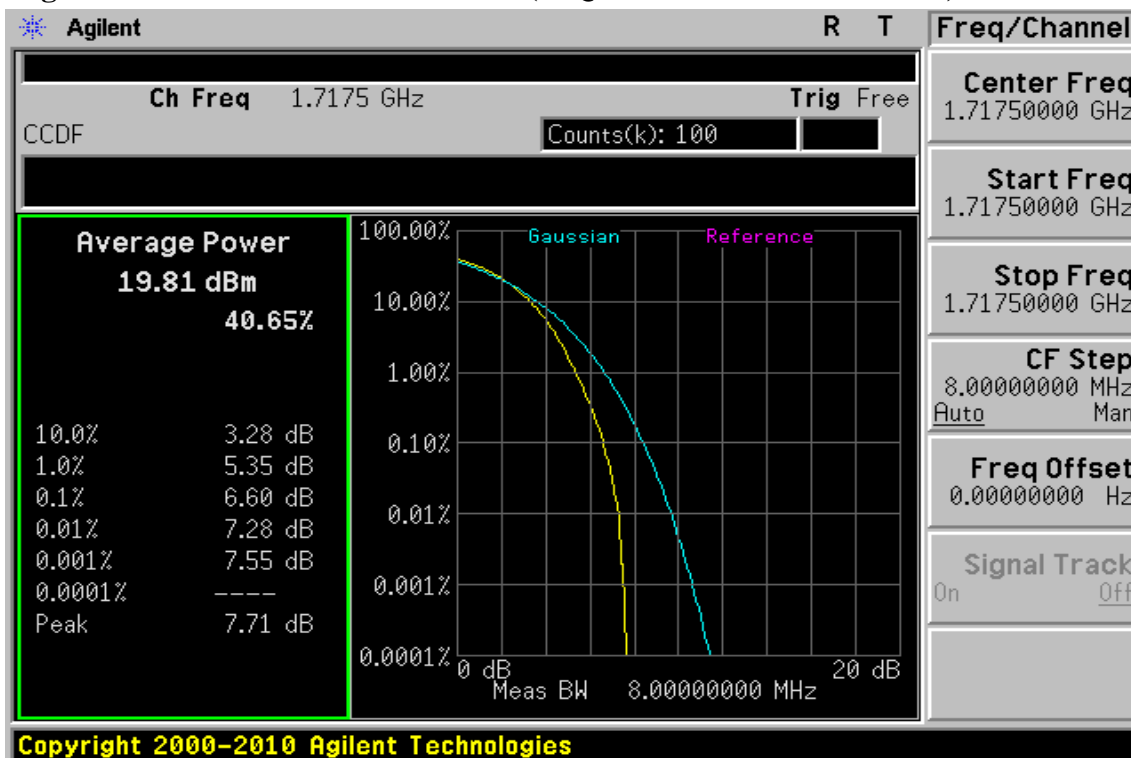
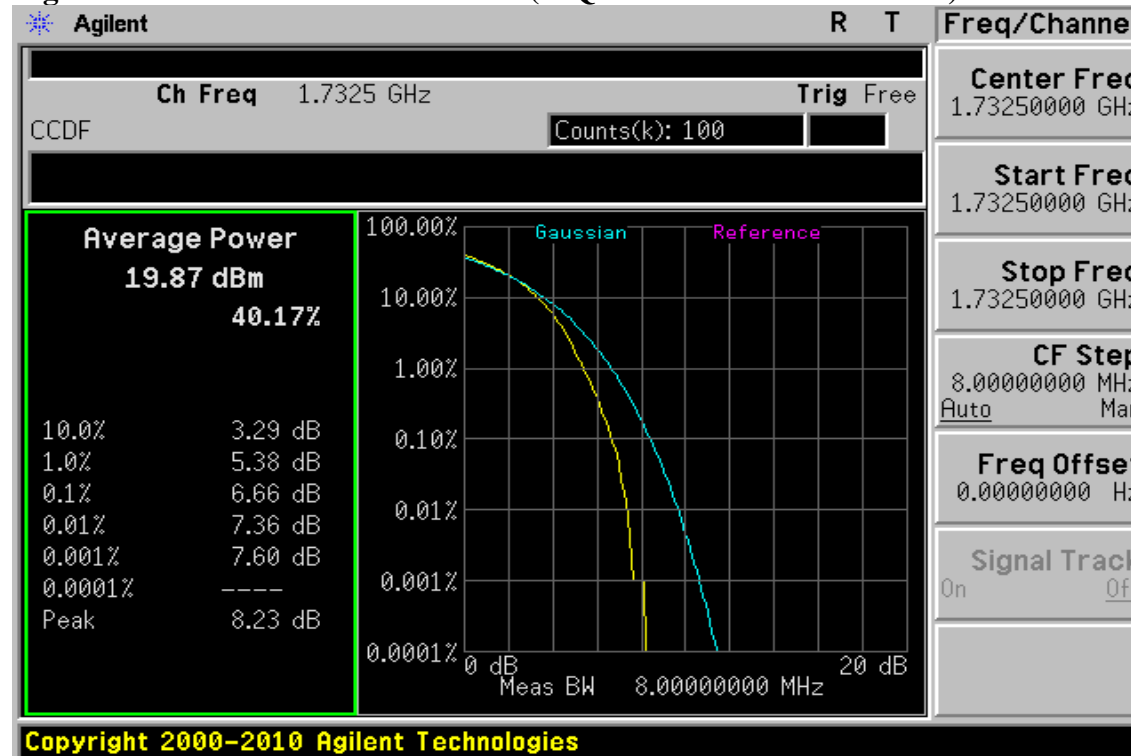

Figure 7-14: 15MHz BW LTE-Band 4(16QAM Number: 75 Offset: 0) Channel Mid



Unless otherwise stated the results shown in this test report refer only to the sample(s) tested and such sample(s) are retained for 90 days only.

除非另有說明，此報告結果僅對測試之樣品負責，同時此樣品僅保留90天。本報告未經本公司書面許可，不可部份複製。

This document is issued by the Company subject to its General Conditions of Service printed overleaf, available on request or accessible at [www.sgs.com/terms\\_and\\_conditions.htm](http://www.sgs.com/terms_and_conditions.htm) and, for electronic format documents, subject to Terms and Conditions for Electronic Documents at [www.sgs.com/terms\\_e-document.htm](http://www.sgs.com/terms_e-document.htm). Attention is drawn to the limitation of liability, indemnification and jurisdiction issues defined therein. Any holder of this document is advised that information contained hereon reflects the Company's findings at the time of its intervention only and within the limits of Client's instructions, if any. The Company's sole responsibility is to its Client and this document does not exonerate parties to a transaction from exercising all their rights and obligations under the transaction documents. This document cannot be reproduced except in full, without prior written approval of the Company. Any unauthorized alteration, forgery or falsification of the content or appearance of this document is unlawful and offenders may be prosecuted to the fullest extent of the law.

**Figure 7-15: 15MHz BW LTE-Band 4(16QAM Number: 75 Offset: 0) Channel High**

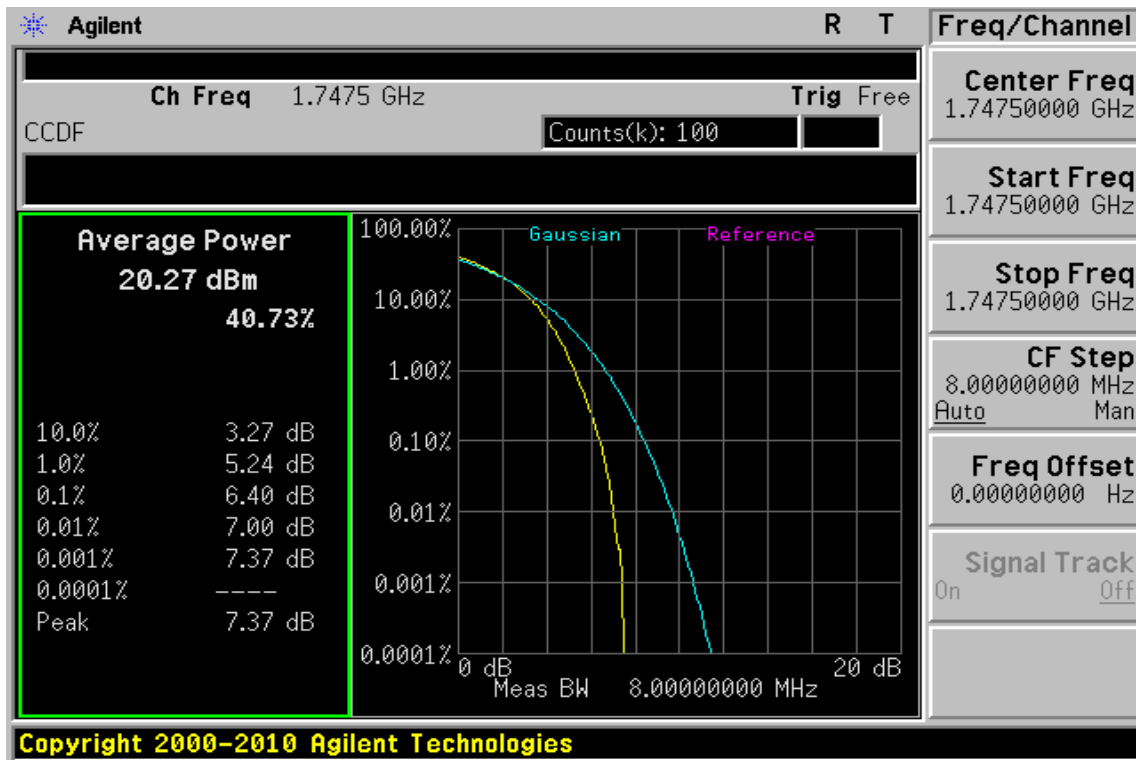

**Figure 7-16: 20MHz BW LTE-Band 4(16QAM Number: 100 Offset: 0) Channel Low**

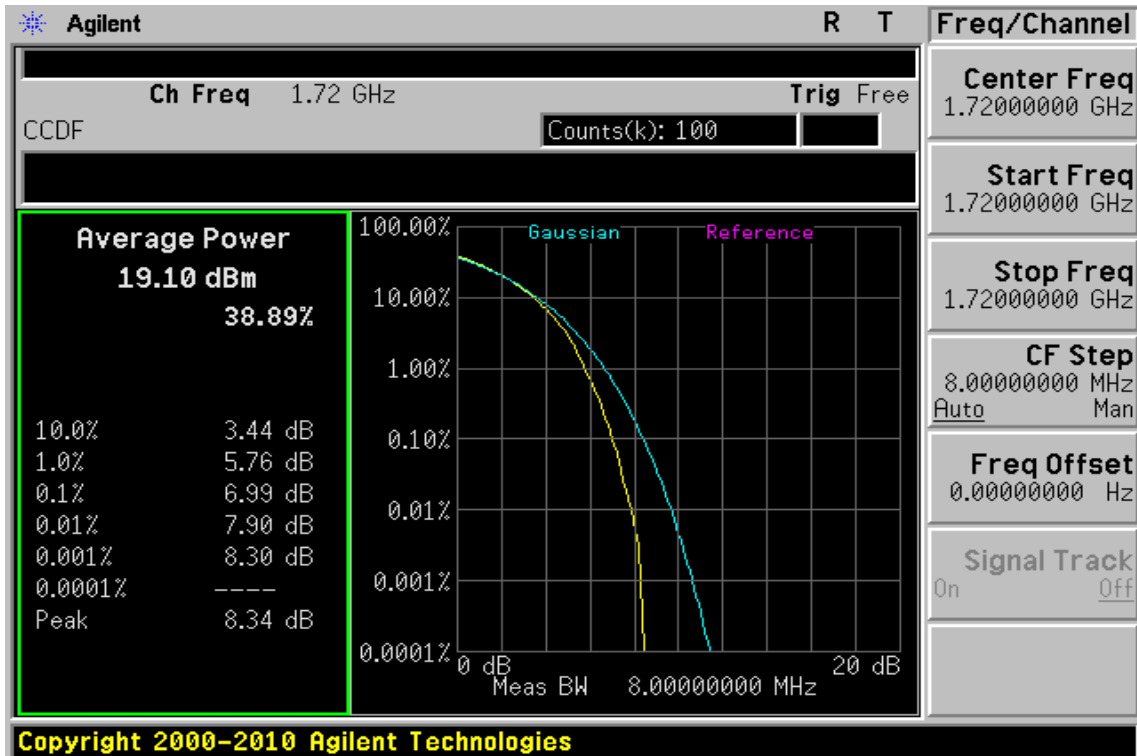

Unless otherwise stated the results shown in this test report refer only to the sample(s) tested and such sample(s) are retained for 90 days only.

除非另有說明，此報告結果僅對測試之樣品負責，同時此樣品僅保留90天。本報告未經本公司書面許可，不可部份複製。

This document is issued by the Company subject to its General Conditions of Service printed overleaf, available on request or accessible at [www.sgs.com/terms\\_and\\_conditions.htm](http://www.sgs.com/terms_and_conditions.htm) and, for electronic format documents, subject to Terms and Conditions for Electronic Documents at [www.sgs.com/terms\\_e-document.htm](http://www.sgs.com/terms_e-document.htm). Attention is drawn to the limitation of liability, indemnification and jurisdiction issues defined therein. Any holder of this document is advised that information contained hereon reflects the Company's findings at the time of its intervention only and within the limits of Client's instructions, if any. The Company's sole responsibility is to its Client and this document does not exonerate parties to a transaction from exercising all their rights and obligations under the transaction documents. This document cannot be reproduced except in full, without prior written approval of the Company. Any unauthorized alteration, forgery or falsification of the content or appearance of this document is unlawful and offenders may be prosecuted to the fullest extent of the law.

Figure 7-17: 20MHz BW LTE-Band 4(16QAM Number: 100 Offset: 0) Channel Mid

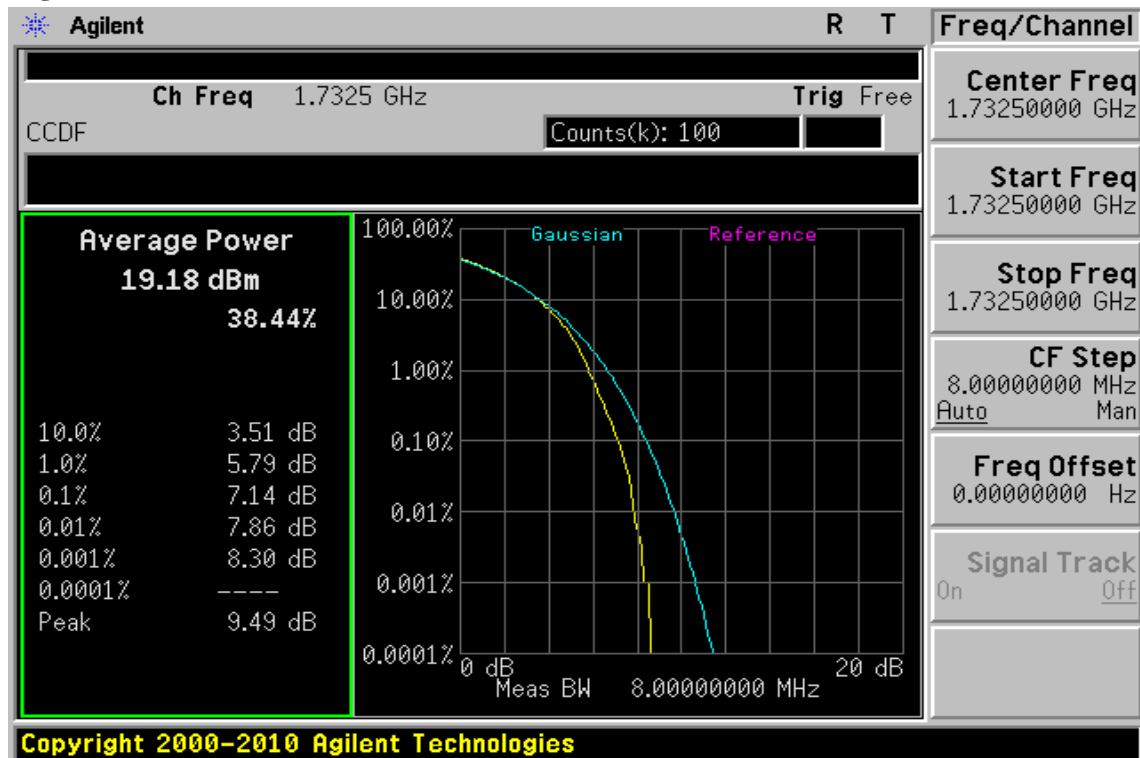
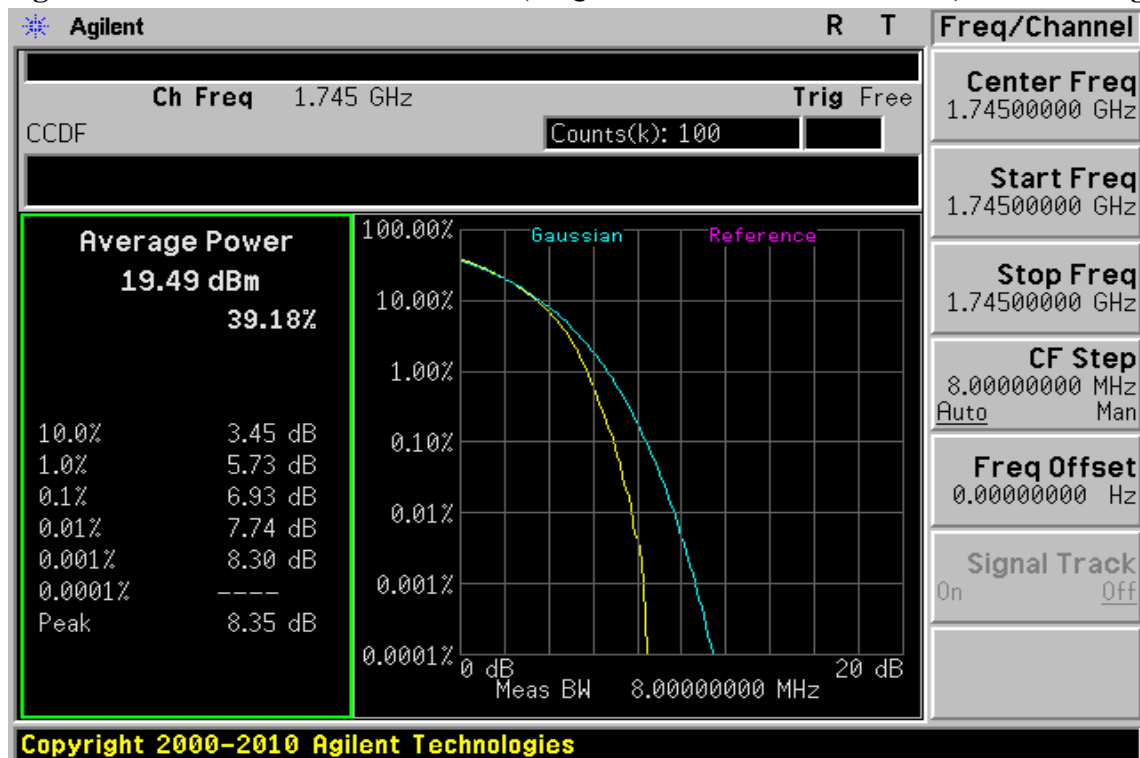

Figure 7-18: 20MHz BW LTE-Band 4(16QAM Number: 100 Offset: 0) Channel High



Unless otherwise stated the results shown in this test report refer only to the sample(s) tested and such sample(s) are retained for 90 days only.

除非另有說明，此報告結果僅對測試之樣品負責，同時此樣品僅保留90天。本報告未經本公司書面許可，不可部份複製。

This document is issued by the Company subject to its General Conditions of Service printed overleaf, available on request or accessible at [www.sgs.com/terms\\_and\\_conditions.htm](http://www.sgs.com/terms_and_conditions.htm) and, for electronic format documents, subject to Terms and Conditions for Electronic Documents at [www.sgs.com/terms\\_e-document.htm](http://www.sgs.com/terms_e-document.htm). Attention is drawn to the limitation of liability, indemnification and jurisdiction issues defined therein. Any holder of this document is advised that information contained hereon reflects the Company's findings at the time of its intervention only and within the limits of Client's instructions, if any. The Company's sole responsibility is to its Client and this document does not exonerate parties to a transaction from exercising all their rights and obligations under the transaction documents. This document cannot be reproduced except in full, without prior written approval of the Company. Any unauthorized alteration, forgery or falsification of the content or appearance of this document is unlawful and offenders may be prosecuted to the fullest extent of the law.

Figure 7-19: 5MHz BW LTE-Band 13(16QAM Number: 25 Offset: 0) Channel Low

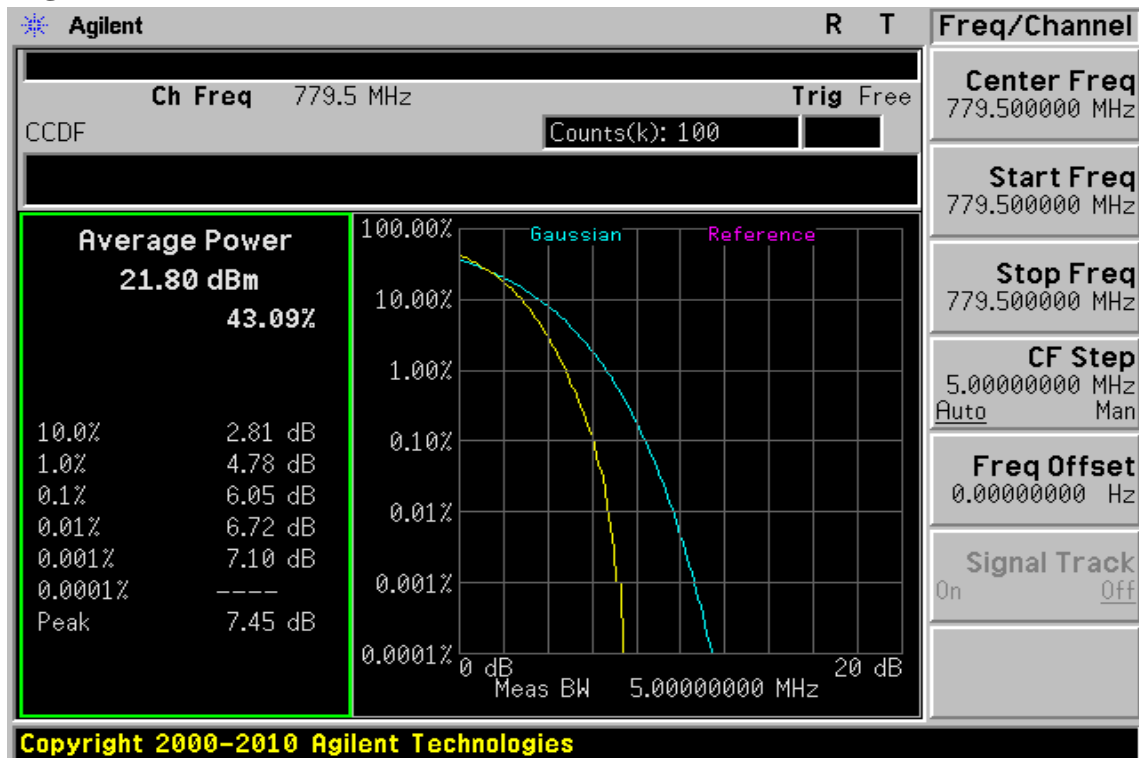
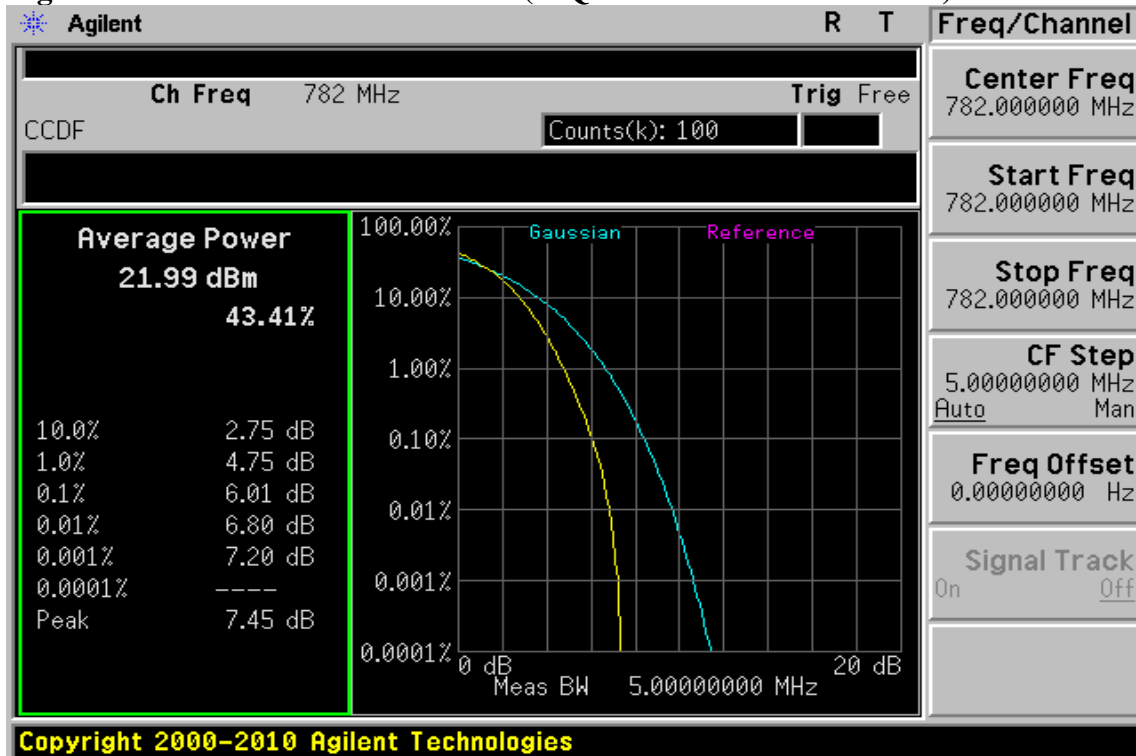

Figure 7-20: 5MHz BW LTE-Band 13(16QAM Number: 25 Offset: 0) Channel Mid



Unless otherwise stated the results shown in this test report refer only to the sample(s) tested and such sample(s) are retained for 90 days only.

除非另有說明，此報告結果僅對測試之樣品負責，同時此樣品僅保留90天。本報告未經本公司書面許可，不可部份複製。

This document is issued by the Company subject to its General Conditions of Service printed overleaf, available on request or accessible at [www.sgs.com/terms\\_and\\_conditions.htm](http://www.sgs.com/terms_and_conditions.htm) and, for electronic format documents, subject to Terms and Conditions for Electronic Documents at [www.sgs.com/terms\\_e-document.htm](http://www.sgs.com/terms_e-document.htm). Attention is drawn to the limitation of liability, indemnification and jurisdiction issues defined therein. Any holder of this document is advised that information contained hereon reflects the Company's findings at the time of its intervention only and within the limits of Client's instructions, if any. The Company's sole responsibility is to its Client and this document does not exonerate parties to a transaction from exercising all their rights and obligations under the transaction documents. This document cannot be reproduced except in full, without prior written approval of the Company. Any unauthorized alteration, forgery or falsification of the content or appearance of this document is unlawful and offenders may be prosecuted to the fullest extent of the law.

**Figure 7-21: 5MHz BW LTE-Band 13(16QAM Number: 25 Offset: 0) Channel High**

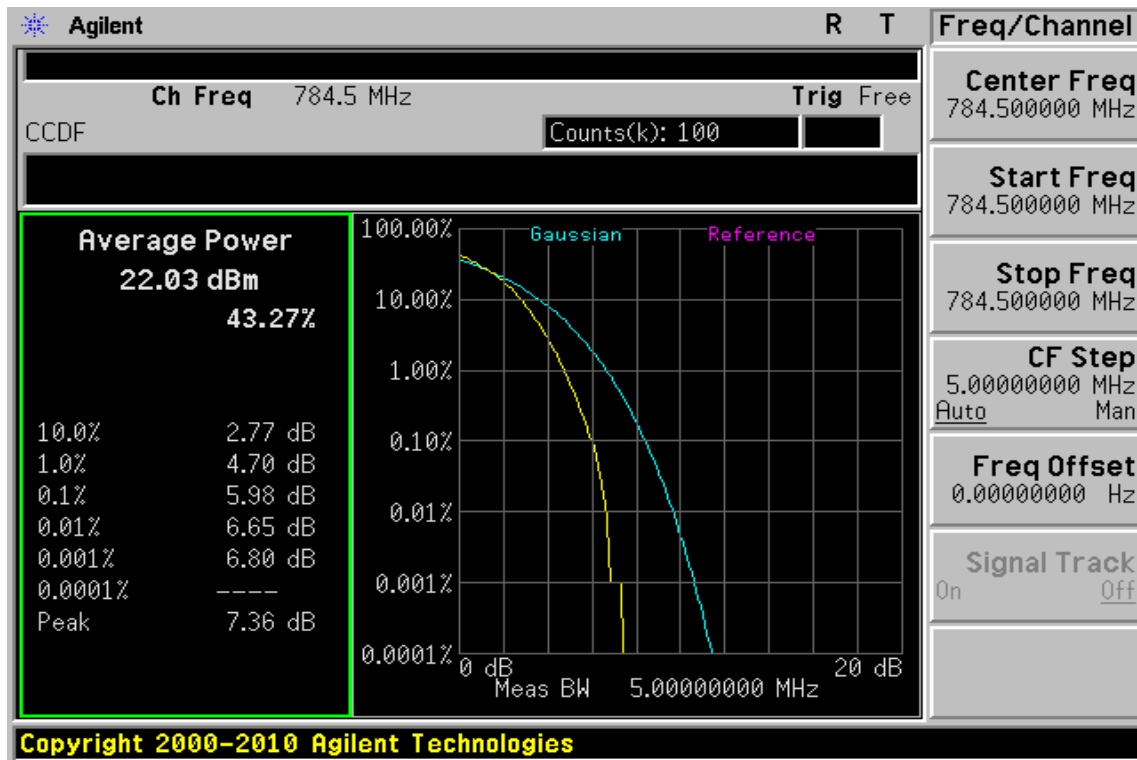

**Figure 7-22: 10MHz BW LTE-Band 13(16QAM Number: 50 Offset: 0) Channel Mid**

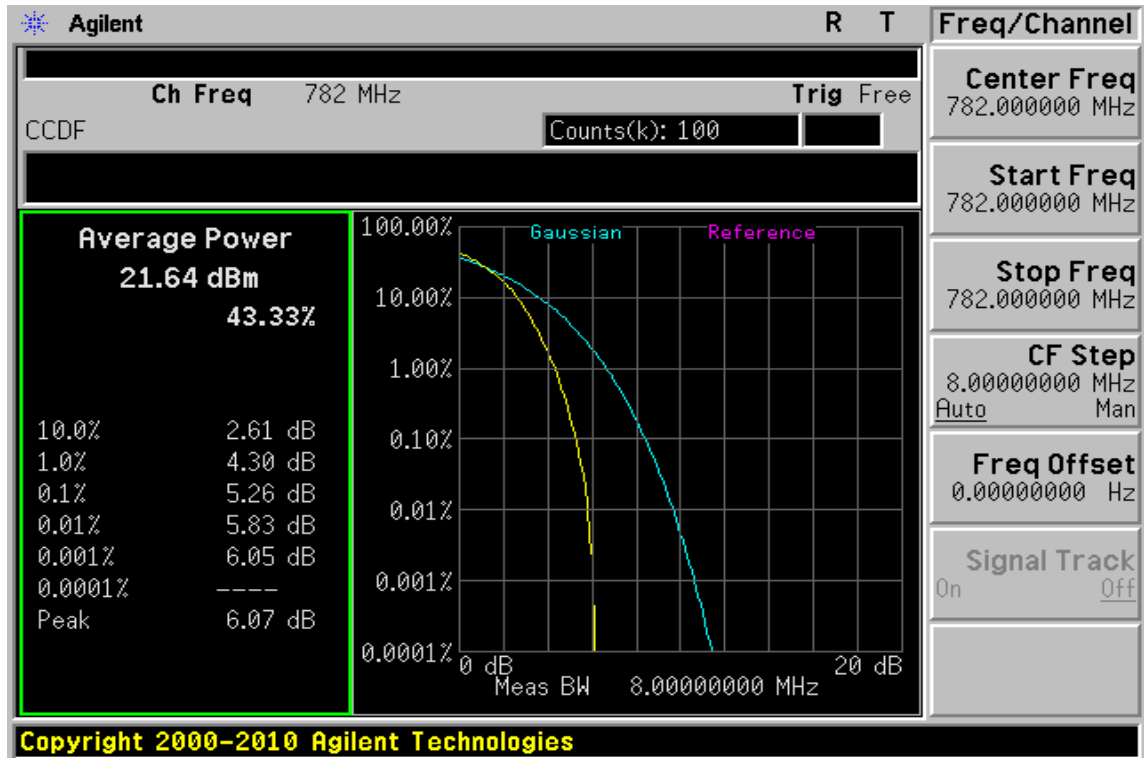

Unless otherwise stated the results shown in this test report refer only to the sample(s) tested and such sample(s) are retained for 90 days only.

除非另有說明，此報告結果僅對測試之樣品負責，同時此樣品僅保留90天。本報告未經本公司書面許可，不可部份複製。

This document is issued by the Company subject to its General Conditions of Service printed overleaf, available on request or accessible at [www.sgs.com/terms\\_and\\_conditions.htm](http://www.sgs.com/terms_and_conditions.htm) and, for electronic format documents, subject to Terms and Conditions for Electronic Documents at [www.sgs.com/terms\\_e-document.htm](http://www.sgs.com/terms_e-document.htm). Attention is drawn to the limitation of liability, indemnification and jurisdiction issues defined therein. Any holder of this document is advised that information contained hereon reflects the Company's findings at the time of its intervention only and within the limits of Client's instructions, if any. The Company's sole responsibility is to its Client and this document does not exonerate parties to a transaction from exercising all their rights and obligations under the transaction documents. This document cannot be reproduced except in full, without prior written approval of the Company. Any unauthorized alteration, forgery or falsification of the content or appearance of this document is unlawful and offenders may be prosecuted to the fullest extent of the law.

## 8. ERP, EIRP MEASUREMENT

### 8.1. Standard Applicable:

According to FCC §2.1046

FCC 27.50(d)(2) Fixed, mobile, and portable (hand-held) stations are limited to 1W EIRP.

FCC 27.50(c)(9) Controlled station and mobile stations are limited to 30W ERP.

### 8.2. Test SET-UP (Block Diagram of Configuration):

(A) Radiated Emission Test Set-Up, Frequency Below 1000MHz

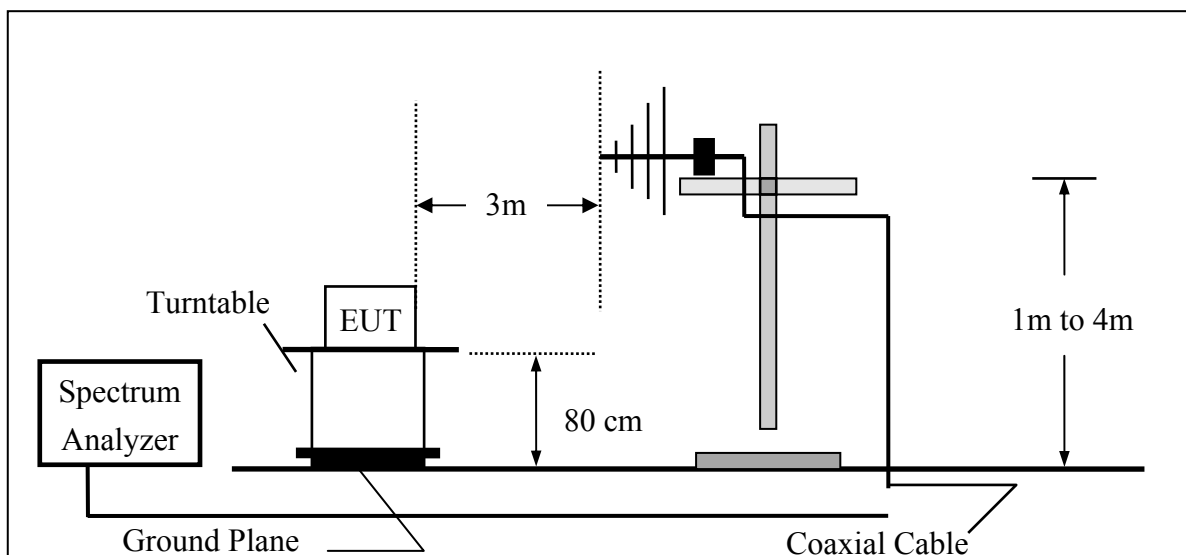

Unless otherwise stated the results shown in this test report refer only to the sample(s) tested and such sample(s) are retained for 90 days only.

除非另有說明，此報告結果僅對測試之樣品負責，同時此樣品僅保留90天。本報告未經本公司書面許可，不可部份複製。

This document is issued by the Company subject to its General Conditions of Service printed overleaf, available on request or accessible at [www.sgs.com/terms\\_and\\_conditions.htm](http://www.sgs.com/terms_and_conditions.htm) and, for electronic format documents, subject to Terms and Conditions for Electronic Documents at [www.sgs.com/terms\\_e-document.htm](http://www.sgs.com/terms_e-document.htm). Attention is drawn to the limitation of liability, indemnification and jurisdiction issues defined therein. Any holder of this document is advised that information contained hereon reflects the Company's findings at the time of its intervention only and within the limits of Client's instructions, if any. The Company's sole responsibility is to its Client and this document does not exonerate parties to a transaction from exercising all their rights and obligations under the transaction documents. This document cannot be reproduced except in full, without prior written approval of the Company. Any unauthorized alteration, forgery or falsification of the content or appearance of this document is unlawful and offenders may be prosecuted to the fullest extent of the law.



(B) Radiated Emission Test Set-UP Frequency Over 1 GHz

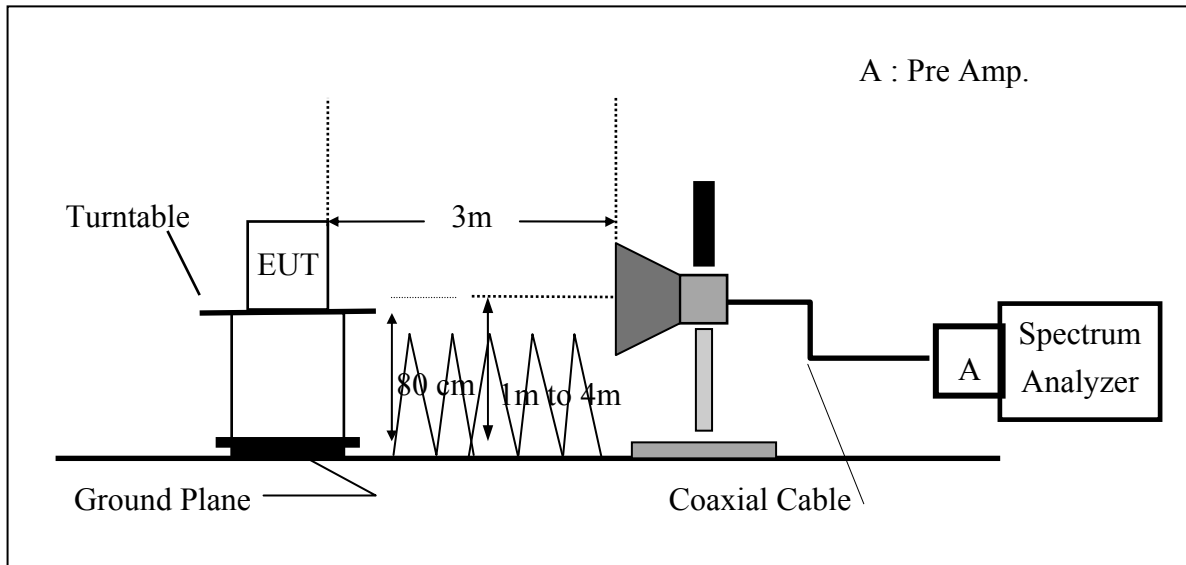

(C) Substituted Method Test Set-UP

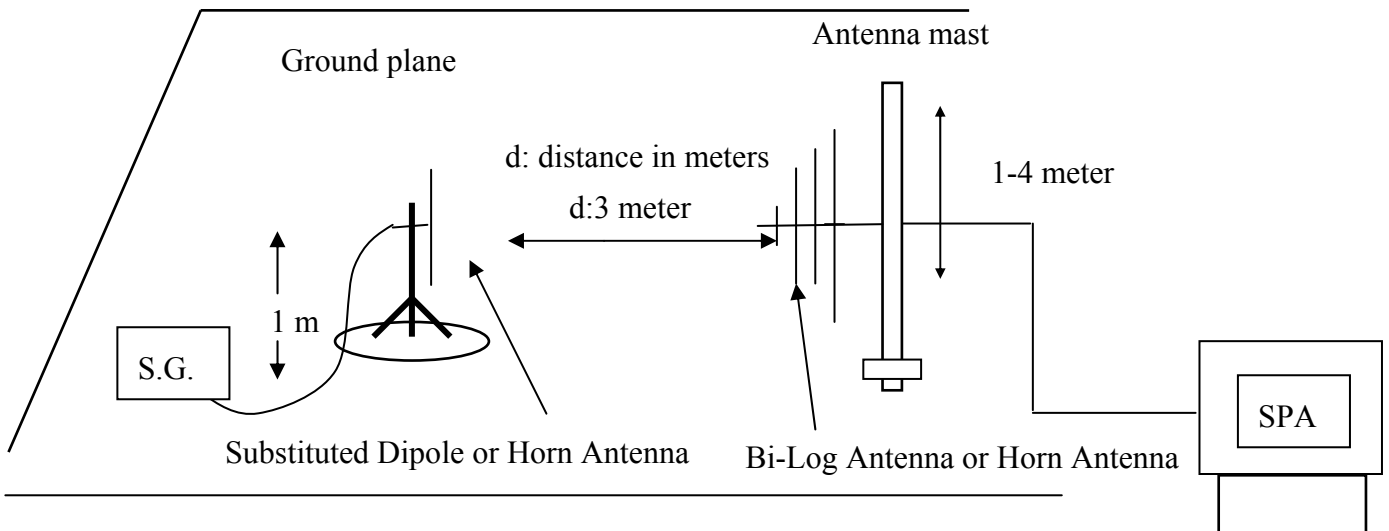

Unless otherwise stated the results shown in this test report refer only to the sample(s) tested and such sample(s) are retained for 90 days only.

除非另有說明，此報告結果僅對測試之樣品負責，同時此樣品僅保留90天。本報告未經本公司書面許可，不可部份複製。

This document is issued by the Company subject to its General Conditions of Service printed overleaf, available on request or accessible at [www.sgs.com/terms\\_and\\_conditions.htm](http://www.sgs.com/terms_and_conditions.htm) and, for electronic format documents, subject to Terms and Conditions for Electronic Documents at [www.sgs.com/terms\\_e-document.htm](http://www.sgs.com/terms_e-document.htm). Attention is drawn to the limitation of liability, indemnification and jurisdiction issues defined therein. Any holder of this document is advised that information contained hereon reflects the Company's findings at the time of its intervention only and within the limits of Client's instructions, if any. The Company's sole responsibility is to its Client and this document does not exonerate parties to a transaction from exercising all their rights and obligations under the transaction documents. This document cannot be reproduced except in full, without prior written approval of the Company. Any unauthorized alteration, forgery or falsification of the content or appearance of this document is unlawful and offenders may be prosecuted to the fullest extent of the law.

### 8.3. Measurement Procedure:

The EUT was placed on a non-conductive turntable using a non-conductive support. The radiated emission at the fundamental frequency was measured at 3 m with a test antenna and EMI spectrum analyzer.

During the measurement, the EUT was in communication with the station. The highest emission was recorded with the rotation of the turntable and the lowering of the test antenna from 4m to 1m. The reading was recorded and the field strength (E in dBuV/m) was calculated and converted.

ERP in frequency band 698MHz - 746MHz were measured using a substitution method. The EUT was replaced by a dipole antenna connected, the S.G. output was recorded and ERP was calculated as follows:

EIRP in frequency band 1710-1755MHz were measured using a substitution method. The EUT was replaced by a horn antenna connected, the S.G. output was recorded and EIRP was calculated as follows:

$$\text{ERP} = \text{S.G. output (dBm)} + \text{Antenna Gain (dBd)} - \text{Cable Loss (dB)}$$

$$\text{EIRP} = \text{S.G. output (dBm)} + \text{Antenna Gain (dBi)} - \text{Cable Loss (dB)}$$

The proper adjustment due to limitation of spectrum capability is given and compensated to the spectrum with a conversion factor of  $10 \cdot \log(\text{TBW}/\text{RBW})$ , where TBW is the transmission BW of UE exceeding the maximum BW UE can extend, and RBW is the resolution BW in UE.

### 8.4. Measurement Equipment Used:

Refer to section 2.4 in this report

Unless otherwise stated the results shown in this test report refer only to the sample(s) tested and such sample(s) are retained for 90 days only.

除非另有說明，此報告結果僅對測試之樣品負責，同時此樣品僅保留90天。本報告未經本公司書面許可，不可部份複製。

This document is issued by the Company subject to its General Conditions of Service printed overleaf, available on request or accessible at [www.sgs.com/terms\\_and\\_conditions.htm](http://www.sgs.com/terms_and_conditions.htm) and, for electronic format documents, subject to Terms and Conditions for Electronic Documents at [www.sgs.com/terms\\_e-document.htm](http://www.sgs.com/terms_e-document.htm). Attention is drawn to the limitation of liability, indemnification and jurisdiction issues defined therein. Any holder of this document is advised that information contained hereon reflects the Company's findings at the time of its intervention only and within the limits of Client's instructions, if any. The Company's sole responsibility is to its Client and this document does not exonerate parties to a transaction from exercising all their rights and obligations under the transaction documents. This document cannot be reproduced except in full, without prior written approval of the Company. Any unauthorized alteration, forgery or falsification of the content or appearance of this document is unlawful and offenders may be prosecuted to the fullest extent of the law.

8.5. Measurement Result:

BAND 4 / BW: 1.4M / QPSK / RB: 1 offset: 0								
EUT			Measurement					
Operation Band	Fundamental Frequency	CH	Antenna Pol.	S.G. Output	Antenna Gain	Cable Loss	EIRP	Limit
	MHz		V/H	dBm	dBi	dB	dBm	dBm
LTE Band 4	1710.7	19957	V	23.00	5.79	-4.50	24.29	30.00
			H	22.38	5.79	-4.50	23.67	30.00
	1732.5	20175	V	25.03	5.75	-4.52	26.25	30.00
			H	21.99	5.75	-4.52	23.21	30.00
	1754.3	20393	V	25.33	5.71	-4.55	<b>26.49</b>	30.00
			H	23.10	5.71	-4.55	24.26	30.00

Remark :

- (1) The RBW,VBW of SPA for frequency RBW= 5MHz , VBW= 8MHz

BAND 4 / BW: 1.4M / QPSK / RB: 1 offset: 5								
EUT			Measurement					
Operation Band	Fundamental Frequency	CH	Antenna Pol.	S.G. Output	Antenna Gain	Cable Loss	EIRP	Limit
	MHz		V/H	dBm	dBi	dB	dBm	dBm
LTE Band 4	1710.7	19957	V	22.92	5.79	-4.50	24.21	30.00
			H	22.00	5.79	-4.50	23.29	30.00
	1732.5	20175	V	24.62	5.75	-4.53	25.84	30.00
			H	22.00	5.75	-4.53	23.22	30.00
	1754.3	20393	V	25.38	5.71	-4.55	<b>26.54</b>	30.00
			H	23.04	5.71	-4.55	24.20	30.00

Remark :

- (1) The RBW,VBW of SPA for frequency RBW= 5MHz , VBW= 8MHz

Unless otherwise stated the results shown in this test report refer only to the sample(s) tested and such sample(s) are retained for 90 days only.

除非另有說明，此報告結果僅對測試之樣品負責，同時此樣品僅保留90天。本報告未經本公司書面許可，不可部份複製。

This document is issued by the Company subject to its General Conditions of Service printed overleaf, available on request or accessible at [www.sgs.com/terms\\_and\\_conditions.htm](http://www.sgs.com/terms_and_conditions.htm) and, for electronic format documents, subject to Terms and Conditions for Electronic Documents at [www.sgs.com/terms\\_e-document.htm](http://www.sgs.com/terms_e-document.htm). Attention is drawn to the limitation of liability, indemnification and jurisdiction issues defined therein. Any holder of this document is advised that information contained hereon reflects the Company's findings at the time of its intervention only and within the limits of Client's instructions, if any. The Company's sole responsibility is to its Client and this document does not exonerate parties to a transaction from exercising all their rights and obligations under the transaction documents. This document cannot be reproduced except in full, without prior written approval of the Company. Any unauthorized alteration, forgery or falsification of the content or appearance of this document is unlawful and offenders may be prosecuted to the fullest extent of the law.

BAND 4 / BW: 1.4M / 16QAM / RB: 1 offset: 0								
EUT			Measurement					
Operation Band	Fundamental Frequency	CH	Antenna Pol.	S.G. Output	Antenna Gain	Cable Loss	EIRP	Limit
	MHz		V/H	dBm	dBi	dB	dBm	dBm
LTE Band 4	1710.7	19957	V	23.20	5.79	-4.50	24.49	30.00
			H	22.40	5.79	-4.50	23.69	30.00
	1732.5	20175	V	25.12	5.75	-4.52	26.35	30.00
			H	22.14	5.75	-4.52	23.36	30.00
	1754.3	20393	V	25.49	5.71	-4.55	<b>26.65</b>	30.00
			H	23.11	5.71	-4.55	24.27	30.00

**Remark :**

- (1) The RBW,VBW of SPA for frequency RBW= 5MHz , VBW= 8MHz

BAND 4 / BW: 1.4M / 16QAM / RB: 1 offset: 5								
EUT			Measurement					
Operation Band	Fundamental Frequency	CH	Antenna Pol.	S.G. Output	Antenna Gain	Cable Loss	EIRP	Limit
	MHz		V/H	dBm	dBi	dB	dBm	dBm
LTE Band 4	1710.7	19957	V	23.20	5.79	-4.50	24.49	30.00
			H	22.27	5.79	-4.50	23.56	30.00
	1732.5	20175	V	24.89	5.75	-4.53	26.11	30.00
			H	22.15	5.75	-4.52	23.37	30.00
	1754.3	20393	V	25.57	5.71	-4.55	<b>26.73</b>	30.00
			H	23.33	5.71	-4.55	24.49	30.00

**Remark :**

- (1) The RBW,VBW of SPA for frequency RBW= 5MHz , VBW= 8MHz

Unless otherwise stated the results shown in this test report refer only to the sample(s) tested and such sample(s) are retained for 90 days only.

除非另有說明，此報告結果僅對測試之樣品負責，同時此樣品僅保留90天。本報告未經本公司書面許可，不可部份複製。

This document is issued by the Company subject to its General Conditions of Service printed overleaf, available on request or accessible at [www.sgs.com/terms\\_and\\_conditions.htm](http://www.sgs.com/terms_and_conditions.htm) and, for electronic format documents, subject to Terms and Conditions for Electronic Documents at [www.sgs.com/terms\\_e-document.htm](http://www.sgs.com/terms_e-document.htm). Attention is drawn to the limitation of liability, indemnification and jurisdiction issues defined therein. Any holder of this document is advised that information contained hereon reflects the Company's findings at the time of its intervention only and within the limits of Client's instructions, if any. The Company's sole responsibility is to its Client and this document does not exonerate parties to a transaction from exercising all their rights and obligations under the transaction documents. This document cannot be reproduced except in full, without prior written approval of the Company. Any unauthorized alteration, forgery or falsification of the content or appearance of this document is unlawful and offenders may be prosecuted to the fullest extent of the law.

BAND 4 / BW: 3M / QPSK / RB: 1 offset: 0								
EUT			Measurement					
Operation Band	Fundamental Frequency	CH	Antenna Pol.	S.G. Output	Antenna Gain	Cable Loss	EIRP	Limit
	MHz		V/H	dBm	dBi	dB	dBm	dBm
LTE Band 4	1711.5	19965	V	22.90	5.79	-4.50	24.19	30.00
			H	21.59	5.79	-4.50	22.88	30.00
	1732.5	20175	V	25.41	5.75	-4.52	<b>26.64</b>	30.00
			H	21.98	5.75	-4.52	23.21	30.00
	1753.5	20385	V	24.46	5.71	-4.55	25.62	30.00
			H	22.90	5.71	-4.55	24.07	30.00

**Remark :**

- (1) The RBW,VBW of SPA for frequency RBW= 8MHz , VBW= 8MHz

BAND 4 / BW: 3M / QPSK / RB: 1 offset: 14								
EUT			Measurement					
Operation Band	Fundamental Frequency	CH	Antenna Pol.	S.G. Output	Antenna Gain	Cable Loss	EIRP	Limit
	MHz		V/H	dBm	dBi	dB	dBm	dBm
LTE Band 4	1711.5	19965	V	23.45	5.78	-4.50	24.73	30.00
			H	21.83	5.79	-4.50	23.12	30.00
	1732.5	20175	V	24.46	5.75	-4.53	25.68	30.00
			H	21.91	5.75	-4.53	23.13	30.00
	1753.5	20385	V	25.31	5.71	-4.55	<b>26.46</b>	30.00
			H	23.09	5.71	-4.55	24.25	30.00

**Remark :**

- (1) The RBW,VBW of SPA for frequency RBW= 8MHz , VBW= 8MHz

Unless otherwise stated the results shown in this test report refer only to the sample(s) tested and such sample(s) are retained for 90 days only.

除非另有說明，此報告結果僅對測試之樣品負責，同時此樣品僅保留90天。本報告未經本公司書面許可，不可部份複製。

This document is issued by the Company subject to its General Conditions of Service printed overleaf, available on request or accessible at [www.sgs.com/terms\\_and\\_conditions.htm](http://www.sgs.com/terms_and_conditions.htm) and, for electronic format documents, subject to Terms and Conditions for Electronic Documents at [www.sgs.com/terms\\_e-document.htm](http://www.sgs.com/terms_e-document.htm). Attention is drawn to the limitation of liability, indemnification and jurisdiction issues defined therein. Any holder of this document is advised that information contained hereon reflects the Company's findings at the time of its intervention only and within the limits of Client's instructions, if any. The Company's sole responsibility is to its Client and this document does not exonerate parties to a transaction from exercising all their rights and obligations under the transaction documents. This document cannot be reproduced except in full, without prior written approval of the Company. Any unauthorized alteration, forgery or falsification of the content or appearance of this document is unlawful and offenders may be prosecuted to the fullest extent of the law.

BAND 4 / BW: 3M / 16QAM / RB: 1 offset: 0								
EUT			Measurement					
Operation Band	Fundamental Frequency	CH	Antenna Pol.	S.G. Output	Antenna Gain	Cable Loss	EIRP	Limit
	MHz		V/H	dBm	dBi	dB	dBm	dBm
LTE Band 4	1711.5	19965	V	23.16	5.79	-4.50	24.45	30.00
			H	21.76	5.79	-4.50	23.05	30.00
	1732.5	20175	V	25.60	5.75	-4.53	<b>26.82</b>	30.00
			H	22.12	5.75	-4.52	23.35	30.00
	1753.5	20385	V	24.70	5.71	-4.55	25.86	30.00
			H	23.11	5.71	-4.55	24.27	30.00

**Remark :**

- (1) The RBW,VBW of SPA for frequency RBW= 8MHz , VBW= 8MHz

BAND 4 / BW: 3M / 16QAM / RB: 1 offset: 14								
EUT			Measurement					
Operation Band	Fundamental Frequency	CH	Antenna Pol.	S.G. Output	Antenna Gain	Cable Loss	EIRP	Limit
	MHz		V/H	dBm	dBi	dB	dBm	dBm
LTE Band 4	1711.5	19965	V	23.58	5.78	-4.50	24.87	30.00
			H	22.03	5.79	-4.50	23.31	30.00
	1732.5	20175	V	24.60	5.75	-4.53	25.82	30.00
			H	22.09	5.75	-4.53	23.31	30.00
	1753.5	20385	V	25.54	5.71	-4.55	<b>26.70</b>	30.00
			H	23.42	5.71	-4.55	24.58	30.00

**Remark :**

- (1) The RBW,VBW of SPA for frequency RBW= 8MHz , VBW= 8MHz

Unless otherwise stated the results shown in this test report refer only to the sample(s) tested and such sample(s) are retained for 90 days only.

除非另有說明，此報告結果僅對測試之樣品負責，同時此樣品僅保留90天。本報告未經本公司書面許可，不可部份複製。

This document is issued by the Company subject to its General Conditions of Service printed overleaf, available on request or accessible at [www.sgs.com/terms\\_and\\_conditions.htm](http://www.sgs.com/terms_and_conditions.htm) and, for electronic format documents, subject to Terms and Conditions for Electronic Documents at [www.sgs.com/terms\\_e-document.htm](http://www.sgs.com/terms_e-document.htm). Attention is drawn to the limitation of liability, indemnification and jurisdiction issues defined therein. Any holder of this document is advised that information contained hereon reflects the Company's findings at the time of its intervention only and within the limits of Client's instructions, if any. The Company's sole responsibility is to its Client and this document does not exonerate parties to a transaction from exercising all their rights and obligations under the transaction documents. This document cannot be reproduced except in full, without prior written approval of the Company. Any unauthorized alteration, forgery or falsification of the content or appearance of this document is unlawful and offenders may be prosecuted to the fullest extent of the law.

BAND 4 / BW: 5M / QPSK / RB: 1 offset: 0								
EUT			Measurement					
Operation Band	Fundamental Frequency	CH	Antenna Pol.	S.G. Output	Antenna Gain	Cable Loss	EIRP	Limit
	MHz		V/H	dBm	dB	dB	dBm	dBm
LTE Band 4	1712.5	19975	V	22.88	5.79	-4.50	24.18	30.00
			H	21.31	5.79	-4.50	22.61	30.00
	1732.5	20175	V	26.15	5.75	-4.52	<b>27.38</b>	30.00
			H	21.76	5.75	-4.52	22.99	30.00
	1752.5	20375	V	23.31	5.72	-4.55	24.48	30.00
			H	22.25	5.72	-4.55	23.42	30.00

**Remark :**

- (1) The RBW,VBW of SPA for frequency RBW= 5MHz , VBW= 8MHz

BAND 4 / BW: 5M / QPSK / RB: 1 offset: 24								
EUT			Measurement					
Operation Band	Fundamental Frequency	CH	Antenna Pol.	S.G. Output	Antenna Gain	Cable Loss	EIRP	Limit
	MHz		V/H	dBm	dB	dB	dBm	dBm
LTE Band 4	1712.5	19975	V	23.88	5.78	-4.50	25.16	30.00
			H	21.45	5.78	-4.50	22.73	30.00
	1732.5	20175	V	24.06	5.75	-4.53	25.27	30.00
			H	21.41	5.75	-4.53	22.63	30.00
	1752.5	20375	V	25.14	5.71	-4.55	<b>26.30</b>	30.00
			H	22.76	5.71	-4.55	23.92	30.00

**Remark :**

- (1) The RBW,VBW of SPA for frequency RBW= 5MHz , VBW= 8MHz

Unless otherwise stated the results shown in this test report refer only to the sample(s) tested and such sample(s) are retained for 90 days only.

除非另有說明，此報告結果僅對測試之樣品負責，同時此樣品僅保留90天。本報告未經本公司書面許可，不可部份複製。

This document is issued by the Company subject to its General Conditions of Service printed overleaf, available on request or accessible at [www.sgs.com/terms\\_and\\_conditions.htm](http://www.sgs.com/terms_and_conditions.htm) and, for electronic format documents, subject to Terms and Conditions for Electronic Documents at [www.sgs.com/terms\\_e-document.htm](http://www.sgs.com/terms_e-document.htm). Attention is drawn to the limitation of liability, indemnification and jurisdiction issues defined therein. Any holder of this document is advised that information contained hereon reflects the Company's findings at the time of its intervention only and within the limits of Client's instructions, if any. The Company's sole responsibility is to its Client and this document does not exonerate parties to a transaction from exercising all their rights and obligations under the transaction documents. This document cannot be reproduced except in full, without prior written approval of the Company. Any unauthorized alteration, forgery or falsification of the content or appearance of this document is unlawful and offenders may be prosecuted to the fullest extent of the law.

BAND 4 / BW: 5M / 16QAM / RB: 1 offset: 0								
EUT			Measurement					
Operation Band	Fundamental Frequency	CH	Antenna Pol.	S.G. Output	Antenna Gain	Cable Loss	EIRP	Limit
	MHz		V/H	dBm	dBi	dB	dBm	dBm
LTE Band 4	1712.5	19975	V	23.02	5.79	-4.50	24.31	30.00
			H	21.33	5.79	-4.50	22.63	30.00
	1732.5	20175	V	26.16	5.75	-4.52	<b>27.39</b>	30.00
			H	21.85	5.75	-4.52	23.08	30.00
	1752.5	20375	V	23.25	5.72	-4.55	24.42	30.00
			H	22.37	5.72	-4.55	23.54	30.00

**Remark :**

- (1) The RBW,VBW of SPA for frequency RBW= 5MHz , VBW= 8MHz

BAND 4 / BW: 5M / 16QAM / RB: 1 offset: 24								
EUT			Measurement					
Operation Band	Fundamental Frequency	CH	Antenna Pol.	S.G. Output	Antenna Gain	Cable Loss	EIRP	Limit
	MHz		V/H	dBm	dBi	dB	dBm	dBm
LTE Band 4	1712.5	19975	V	23.88	5.78	-4.50	25.16	30.00
			H	21.67	5.78	-4.50	22.95	30.00
	1732.5	20175	V	24.14	5.75	-4.53	25.35	30.00
			H	21.73	5.75	-4.53	22.95	30.00
	1752.5	20375	V	25.32	5.71	-4.55	<b>26.48</b>	30.00
			H	23.09	5.71	-4.55	24.24	30.00

**Remark :**

- (1) The RBW,VBW of SPA for frequency RBW= 5MHz , VBW= 8MHz

Unless otherwise stated the results shown in this test report refer only to the sample(s) tested and such sample(s) are retained for 90 days only.

除非另有說明，此報告結果僅對測試之樣品負責，同時此樣品僅保留90天。本報告未經本公司書面許可，不可部份複製。

This document is issued by the Company subject to its General Conditions of Service printed overleaf, available on request or accessible at [www.sgs.com/terms\\_and\\_conditions.htm](http://www.sgs.com/terms_and_conditions.htm) and, for electronic format documents, subject to Terms and Conditions for Electronic Documents at [www.sgs.com/terms\\_e-document.htm](http://www.sgs.com/terms_e-document.htm). Attention is drawn to the limitation of liability, indemnification and jurisdiction issues defined therein. Any holder of this document is advised that information contained hereon reflects the Company's findings at the time of its intervention only and within the limits of Client's instructions, if any. The Company's sole responsibility is to its Client and this document does not exonerate parties to a transaction from exercising all their rights and obligations under the transaction documents. This document cannot be reproduced except in full, without prior written approval of the Company. Any unauthorized alteration, forgery or falsification of the content or appearance of this document is unlawful and offenders may be prosecuted to the fullest extent of the law.



BAND 4 / BW: 10M / QPSK / RB: 1 offset: 0								
EUT			Measurement					
Operation Band	Fundamental Frequency	CH	Antenna Pol.	S.G. Output	Antenna Gain	Cable Loss	EIRP	Limit
	MHz		V/H	dBm	dBi	dB	dBm	dBm
LTE Band 4	1715.0	20000	V	23.03	5.79	-4.50	24.32	30.00
			H	19.40	5.79	-4.50	20.69	30.00
	1732.0	20175	V	26.34	5.76	-4.52	<b>27.58</b>	30.00
			H	19.66	5.76	-4.52	20.89	30.00
	1750.0	20350	V	20.30	5.73	-4.54	21.49	30.00
			H	18.13	5.73	-4.54	19.32	30.00

**Remark :**

- (1) The RBW,VBW of SPA for frequency RBW= 8MHz , VBW= 8MHz

BAND 4 / BW: 10M / QPSK / RB: 1 offset: 49								
EUT			Measurement					
Operation Band	Fundamental Frequency	CH	Antenna Pol.	S.G. Output	Antenna Gain	Cable Loss	EIRP	Limit
	MHz		V/H	dBm	dBi	dB	dBm	dBm
LTE Band 4	1715.0	20000	V	24.67	5.77	-4.51	<b>25.94</b>	30.00
			H	20.10	5.77	-4.51	21.37	30.00
	1732.0	20175	V	22.64	5.74	-4.53	23.85	30.00
			H	4.42	5.74	-4.53	19.82	30.00
	1750.0	20350	V	24.35	5.71	-4.55	25.51	30.00
			H	19.86	5.71	-4.55	21.01	30.00

**Remark :**

- (1) The RBW,VBW of SPA for frequency RBW= 8MHz , VBW= 8MHz

Unless otherwise stated the results shown in this test report refer only to the sample(s) tested and such sample(s) are retained for 90 days only.

除非另有說明，此報告結果僅對測試之樣品負責，同時此樣品僅保留90天。本報告未經本公司書面許可，不可部份複製。

This document is issued by the Company subject to its General Conditions of Service printed overleaf, available on request or accessible at [www.sgs.com/terms\\_and\\_conditions.htm](http://www.sgs.com/terms_and_conditions.htm) and, for electronic format documents, subject to Terms and Conditions for Electronic Documents at [www.sgs.com/terms\\_e-document.htm](http://www.sgs.com/terms_e-document.htm). Attention is drawn to the limitation of liability, indemnification and jurisdiction issues defined therein. Any holder of this document is advised that information contained hereon reflects the Company's findings at the time of its intervention only and within the limits of Client's instructions, if any. The Company's sole responsibility is to its Client and this document does not exonerate parties to a transaction from exercising all their rights and obligations under the transaction documents. This document cannot be reproduced except in full, without prior written approval of the Company. Any unauthorized alteration, forgery or falsification of the content or appearance of this document is unlawful and offenders may be prosecuted to the fullest extent of the law.

BAND 4 / BW: 10M / 16QAM / RB: 1 offset: 0								
EUT			Measurement					
Operation Band	Fundamental Frequency	CH	Antenna Pol.	S.G. Output	Antenna Gain	Cable Loss	EIRP	Limit
	MHz		V/H	dBm	dBi	dB	dBm	dBm
LTE Band 4	1715.0	20000	V	22.98	5.79	-4.50	24.27	30.00
			H	19.46	5.79	-4.50	20.75	30.00
	1732.5	20175	V	26.51	5.76	-4.52	<b>27.75</b>	30.00
			H	19.83	5.76	-4.52	21.07	30.00
	1750.0	20350	V	20.41	5.73	-4.54	21.59	30.00
			H	18.25	5.73	-4.54	19.44	30.00

**Remark :**

- (1) The RBW,VBW of SPA for frequency RBW= 8MHz , VBW= 8MHz

BAND 4 / BW: 10M / 16QAM / RB: 1 offset: 49								
EUT			Measurement					
Operation Band	Fundamental Frequency	CH	Antenna Pol.	S.G. Output	Antenna Gain	Cable Loss	EIRP	Limit
	MHz		V/H	dBm	dBi	dB	dBm	dBm
LTE Band 4	1715.0	20000	V	24.90	5.77	-4.51	<b>26.17</b>	30.00
			H	20.42	5.77	-4.51	21.69	30.00
	1732.5	20175	V	22.75	5.74	-4.53	23.96	30.00
			H	18.73	5.74	-4.53	19.94	30.00
	1750.0	20350	V	24.51	5.71	-4.55	25.67	30.00
			H	20.07	5.71	-4.55	21.23	30.00

**Remark :**

- (1) The RBW,VBW of SPA for frequency RBW= 8MHz , VBW= 8MHz

Unless otherwise stated the results shown in this test report refer only to the sample(s) tested and such sample(s) are retained for 90 days only.

除非另有說明，此報告結果僅對測試之樣品負責，同時此樣品僅保留90天。本報告未經本公司書面許可，不可部份複製。

This document is issued by the Company subject to its General Conditions of Service printed overleaf, available on request or accessible at [www.sgs.com/terms\\_and\\_conditions.htm](http://www.sgs.com/terms_and_conditions.htm) and, for electronic format documents, subject to Terms and Conditions for Electronic Documents at [www.sgs.com/terms\\_e-document.htm](http://www.sgs.com/terms_e-document.htm). Attention is drawn to the limitation of liability, indemnification and jurisdiction issues defined therein. Any holder of this document is advised that information contained hereon reflects the Company's findings at the time of its intervention only and within the limits of Client's instructions, if any. The Company's sole responsibility is to its Client and this document does not exonerate parties to a transaction from exercising all their rights and obligations under the transaction documents. This document cannot be reproduced except in full, without prior written approval of the Company. Any unauthorized alteration, forgery or falsification of the content or appearance of this document is unlawful and offenders may be prosecuted to the fullest extent of the law.

BAND 4 / BW: 15M / QPSK / RB: 1 offset: 0								
EUT			Measurement					
Operation Band	Fundamental Frequency	CH	Antenna Pol.	S.G. Output	Antenna Gain	Cable Loss	EIRP	Limit
	MHz		V/H	dBm	dBi	dB	dBm	dBm
LTE Band 4	1717.5	20025	V	23.08	5.79	-4.50	24.37	30.00
			H	18.18	5.79	-4.50	19.47	30.00
	1732.5	20175	V	26.42	5.76	-4.52	<b>27.67</b>	30.00
			H	19.10	5.76	-4.52	20.35	30.00
	1747.5	20325	V	20.60	5.74	-4.54	21.80	30.00
			H	17.39	5.74	-4.54	18.59	30.00

**Remark :**

- (1) The RBW,VBW of SPA for frequency RBW= 8MHz , VBW= 8MHz

BAND 4 / BW: 15M / QPSK / RB: 1 offset: 74								
EUT			Measurement					
Operation Band	Fundamental Frequency	CH	Antenna Pol.	S.G. Output	Antenna Gain	Cable Loss	EIRP	Limit
	MHz		V/H	dBm	dBi	dB	dBm	dBm
LTE Band 4	1717.5	20025	V	24.81	5.76	-4.51	<b>26.06</b>	30.00
			H	20.55	5.77	-4.51	21.80	30.00
	1732.5	20175	V	21.26	5.74	-4.53	22.47	30.00
			H	18.07	5.74	-4.53	19.27	30.00
	1747.5	20325	V	23.43	5.71	-4.55	24.59	30.00
			H	19.68	5.71	-4.55	20.84	30.00

**Remark :**

- (1) The RBW,VBW of SPA for frequency RBW= 8MHz , VBW= 8MHz

Unless otherwise stated the results shown in this test report refer only to the sample(s) tested and such sample(s) are retained for 90 days only.

除非另有說明，此報告結果僅對測試之樣品負責，同時此樣品僅保留90天。本報告未經本公司書面許可，不可部份複製。

This document is issued by the Company subject to its General Conditions of Service printed overleaf, available on request or accessible at [www.sgs.com/terms\\_and\\_conditions.htm](http://www.sgs.com/terms_and_conditions.htm) and, for electronic format documents, subject to Terms and Conditions for Electronic Documents at [www.sgs.com/terms\\_e-document.htm](http://www.sgs.com/terms_e-document.htm). Attention is drawn to the limitation of liability, indemnification and jurisdiction issues defined therein. Any holder of this document is advised that information contained hereon reflects the Company's findings at the time of its intervention only and within the limits of Client's instructions, if any. The Company's sole responsibility is to its Client and this document does not exonerate parties to a transaction from exercising all their rights and obligations under the transaction documents. This document cannot be reproduced except in full, without prior written approval of the Company. Any unauthorized alteration, forgery or falsification of the content or appearance of this document is unlawful and offenders may be prosecuted to the fullest extent of the law.

BAND 4 / BW: 15M / 16QAM / RB: 1 offset: 0								
EUT			Measurement					
Operation Band	Fundamental Frequency	CH	Antenna Pol.	S.G. Output	Antenna Gain	Cable Loss	EIRP	Limit
	MHz		V/H	dBm	dBi	dB	dBm	dBm
LTE Band 4	1717.5	20025	V	23.24	5.79	-4.50	24.54	30.00
			H	18.31	5.79	-4.50	19.61	30.00
	1732.5	20175	V	26.50	5.76	-4.52	<b>27.75</b>	30.00
			H	19.22	5.76	-4.52	20.47	30.00
	1747.5	20325	V	20.62	5.73	-4.54	21.82	30.00
			H	17.51	5.74	-4.54	18.71	30.00

**Remark :**

- (1) The RBW,VBW of SPA for frequency RBW= 8MHz , VBW= 8MHz

BAND 4 / BW: 15M / 16QAM / RB: 1 offset: 74								
EUT			Measurement					
Operation Band	Fundamental Frequency	CH	Antenna Pol.	S.G. Output	Antenna Gain	Cable Loss	EIRP	Limit
	MHz		V/H	dBm	dBi	dB	dBm	dBm
LTE Band 4	1717.5	20025	V	25.04	5.76	-4.51	<b>26.29</b>	30.00
			H	20.79	5.77	-4.51	22.04	30.00
	1732.5	20175	V	21.41	5.74	-4.53	22.62	30.00
			H	18.16	5.74	-4.53	19.37	30.00
	1747.5	20325	V	23.53	5.71	-4.55	24.69	30.00
			H	19.93	5.71	-4.55	21.09	30.00

**Remark :**

- (1) The RBW,VBW of SPA for frequency RBW= 8MHz , VBW= 8MHz

Unless otherwise stated the results shown in this test report refer only to the sample(s) tested and such sample(s) are retained for 90 days only.

除非另有說明，此報告結果僅對測試之樣品負責，同時此樣品僅保留90天。本報告未經本公司書面許可，不可部份複製。

This document is issued by the Company subject to its General Conditions of Service printed overleaf, available on request or accessible at [www.sgs.com/terms\\_and\\_conditions.htm](http://www.sgs.com/terms_and_conditions.htm) and, for electronic format documents, subject to Terms and Conditions for Electronic Documents at [www.sgs.com/terms\\_e-document.htm](http://www.sgs.com/terms_e-document.htm). Attention is drawn to the limitation of liability, indemnification and jurisdiction issues defined therein. Any holder of this document is advised that information contained hereon reflects the Company's findings at the time of its intervention only and within the limits of Client's instructions, if any. The Company's sole responsibility is to its Client and this document does not exonerate parties to a transaction from exercising all their rights and obligations under the transaction documents. This document cannot be reproduced except in full, without prior written approval of the Company. Any unauthorized alteration, forgery or falsification of the content or appearance of this document is unlawful and offenders may be prosecuted to the fullest extent of the law.

BAND 4 / BW: 20M / QPSK / RB: 1 offset: 0								
EUT			Measurement					
Operation Band	Fundamental Frequency	CH	Antenna Pol.	S.G. Output	Antenna Gain	Cable Loss	EIRP	Limit
	MHz		V/H	dBm	dB	dB	dBm	dBm
LTE Band 4	1720.0	20050	V	23.34	5.79	-4.50	24.63	30.00
			H	18.49	5.79	-4.50	19.78	30.00
	1732.5	20175	V	26.63	5.77	-4.51	<b>27.88</b>	30.00
			H	20.70	5.77	-4.51	21.95	30.00
	1745.0	20300	V	21.55	5.79	-4.50	22.84	30.00
			H	18.29	5.79	-4.50	19.58	30.00

**Remark :**

- (1) The RBW,VBW of SPA for frequency RBW= 8MHz , VBW= 8MHz

BAND 4 / BW: 20M / QPSK / RB: 1 offset: 99								
EUT			Measurement					
Operation Band	Fundamental Frequency	CH	Antenna Pol.	S.G. Output	Antenna Gain	Cable Loss	EIRP	Limit
	MHz		V/H	dBm	dB	dB	dBm	dBm
LTE Band 4	1720.0	20050	V	23.99	5.76	-4.52	25.22	30.00
			H	20.03	5.76	-4.52	21.27	30.00
	1732.5	20175	V	20.31	5.73	-4.54	21.51	30.00
			H	17.56	5.73	-4.54	18.76	30.00
	1745.0	20300	V	27.03	5.76	-4.52	<b>28.27</b>	30.00
			H	20.33	5.76	-4.52	21.58	30.00

**Remark :**

- (1) The RBW,VBW of SPA for frequency RBW= 8MHz , VBW= 8MHz

Unless otherwise stated the results shown in this test report refer only to the sample(s) tested and such sample(s) are retained for 90 days only.

除非另有說明，此報告結果僅對測試之樣品負責，同時此樣品僅保留90天。本報告未經本公司書面許可，不可部份複製。

This document is issued by the Company subject to its General Conditions of Service printed overleaf, available on request or accessible at [www.sgs.com/terms\\_and\\_conditions.htm](http://www.sgs.com/terms_and_conditions.htm) and, for electronic format documents, subject to Terms and Conditions for Electronic Documents at [www.sgs.com/terms\\_e-document.htm](http://www.sgs.com/terms_e-document.htm). Attention is drawn to the limitation of liability, indemnification and jurisdiction issues defined therein. Any holder of this document is advised that information contained hereon reflects the Company's findings at the time of its intervention only and within the limits of Client's instructions, if any. The Company's sole responsibility is to its Client and this document does not exonerate parties to a transaction from exercising all their rights and obligations under the transaction documents. This document cannot be reproduced except in full, without prior written approval of the Company. Any unauthorized alteration, forgery or falsification of the content or appearance of this document is unlawful and offenders may be prosecuted to the fullest extent of the law.

BAND 4 / BW: 20M / 16QAM / RB: 1 offset: 0								
EUT			Measurement					
Operation Band	Fundamental Frequency	CH	Antenna Pol.	S.G. Output	Antenna Gain	Cable Loss	EIRP	Limit
	MHz		V/H	dBm	dBi	dB	dBm	dBm
LTE Band 4	1720.0	20050	V	23.41	5.79	-4.50	24.70	30.00
			H	18.58	5.79	-4.50	19.87	30.00
	1732.5	20175	V	26.77	5.76	-4.51	<b>28.02</b>	30.00
			H	20.86	5.77	-4.51	22.12	30.00
	1745.0	20300	V	21.60	5.79	-4.50	22.89	30.00
			H	18.56	5.79	-4.50	19.85	30.00

**Remark :**

- (1) The RBW,VBW of SPA for frequency RBW= 8MHz , VBW= 8MHz

BAND 4 / BW: 20M / 16QAM / RB: 1 offset: 99								
EUT			Measurement					
Operation Band	Fundamental Frequency	CH	Antenna Pol.	S.G. Output	Antenna Gain	Cable Loss	EIRP	Limit
	MHz		V/H	dBm	dBi	dB	dBm	dBm
LTE Band 4	1720.0	20050	V	23.97	5.76	-4.52	25.21	30.00
			H	20.25	5.76	-4.52	21.49	30.00
	1732.5	20175	V	20.70	5.74	-4.54	21.90	30.00
			H	17.63	5.74	-4.54	18.83	30.00
	1745.0	20300	V	26.90	5.76	-4.52	<b>28.15</b>	30.00
			H	20.41	5.76	-4.52	21.65	30.00

**Remark :**

- (1) The RBW,VBW of SPA for frequency RBW= 8MHz , VBW= 8MHz

Unless otherwise stated the results shown in this test report refer only to the sample(s) tested and such sample(s) are retained for 90 days only.

除非另有說明，此報告結果僅對測試之樣品負責，同時此樣品僅保留90天。本報告未經本公司書面許可，不可部份複製。

This document is issued by the Company subject to its General Conditions of Service printed overleaf, available on request or accessible at [www.sgs.com/terms\\_and\\_conditions.htm](http://www.sgs.com/terms_and_conditions.htm) and, for electronic format documents, subject to Terms and Conditions for Electronic Documents at [www.sgs.com/terms\\_e-document.htm](http://www.sgs.com/terms_e-document.htm). Attention is drawn to the limitation of liability, indemnification and jurisdiction issues defined therein. Any holder of this document is advised that information contained hereon reflects the Company's findings at the time of its intervention only and within the limits of Client's instructions, if any. The Company's sole responsibility is to its Client and this document does not exonerate parties to a transaction from exercising all their rights and obligations under the transaction documents. This document cannot be reproduced except in full, without prior written approval of the Company. Any unauthorized alteration, forgery or falsification of the content or appearance of this document is unlawful and offenders may be prosecuted to the fullest extent of the law.

BAND 13 / BW: 5M / QPSK / RB: 1 offset: 0								
EUT			Measurement					
Operation Band	Fundamental Frequency	CH	Antenna Pol.	S.G. Output	Antenna Gain	Cable Loss	ERP	Limit
	MHz		V/H	dBm	dBd	dB	dBm	dBm
LTE Band 13	779.5	23205	V	21.16	3.47	-2.90	21.73	44.77
			H	13.90	3.47	-2.90	14.47	44.77
	782.0	23230	V	20.33	3.48	-2.91	20.90	44.77
			H	14.13	3.48	-2.91	14.70	44.77
	784.5	23255	V	21.63	3.48	-2.91	<b>22.20</b>	44.77
			H	13.54	3.48	-2.91	14.11	44.77

**Remark :**

- (1) The RBW,VBW of SPA for frequency RBW= 5MHz , VBW= 8MHz

BAND 13 / BW: 5M / QPSK / RB: 1 offset: 24								
EUT			Measurement					
Operation Band	Fundamental Frequency	CH	Antenna Pol.	S.G. Output	Antenna Gain	Cable Loss	ERP	Limit
	MHz		V/H	dBm	dBd	dB	dBm	dBm
LTE Band 13	779.5	23205	V	20.50	3.48	-2.91	21.07	44.77
			H	14.63	3.48	-2.91	15.20	44.77
	782.0	23230	V	20.23	3.49	-2.92	20.80	44.77
			H	13.66	3.49	-2.92	14.23	44.77
	784.5	23255	V	22.32	3.50	-2.92	<b>22.90</b>	44.77
			H	14.87	3.50	-2.92	15.45	44.77

**Remark :**

- (1) The RBW,VBW of SPA for frequency RBW= 5MHz , VBW= 8MHz

Unless otherwise stated the results shown in this test report refer only to the sample(s) tested and such sample(s) are retained for 90 days only.

除非另有說明，此報告結果僅對測試之樣品負責，同時此樣品僅保留90天。本報告未經本公司書面許可，不可部份複製。

This document is issued by the Company subject to its General Conditions of Service printed overleaf, available on request or accessible at [www.sgs.com/terms\\_and\\_conditions.htm](http://www.sgs.com/terms_and_conditions.htm) and, for electronic format documents, subject to Terms and Conditions for Electronic Documents at [www.sgs.com/terms\\_e-document.htm](http://www.sgs.com/terms_e-document.htm). Attention is drawn to the limitation of liability, indemnification and jurisdiction issues defined therein. Any holder of this document is advised that information contained hereon reflects the Company's findings at the time of its intervention only and within the limits of Client's instructions, if any. The Company's sole responsibility is to its Client and this document does not exonerate parties to a transaction from exercising all their rights and obligations under the transaction documents. This document cannot be reproduced except in full, without prior written approval of the Company. Any unauthorized alteration, forgery or falsification of the content or appearance of this document is unlawful and offenders may be prosecuted to the fullest extent of the law.

BAND 13 / BW: 5M / 16QAM / RB: 1 offset: 0								
EUT			Measurement					
Operation Band	Fundamental Frequency	CH	Antenna Pol.	S.G. Output	Antenna Gain	Cable Loss	ERP	Limit
	MHz		V/H	dBm	dBd	dB	dBm	dBm
LTE Band 13	779.5	23205	V	22.16	3.47	-2.90	22.73	44.77
			H	14.86	3.47	-2.90	15.43	44.77
	782.0	23230	V	21.01	3.48	-2.91	21.58	44.77
			H	15.06	3.48	-2.91	15.63	44.77
	784.5	23255	V	22.79	3.48	-2.91	<b>23.36</b>	44.77
			H	15.61	3.48	-2.91	16.18	44.77

**Remark :**

- (1) The RBW,VBW of SPA for frequency RBW= 5MHz , VBW= 8MHz

BAND 13 / BW: 5M / 16QAM / RB: 1 offset: 24								
EUT			Measurement					
Operation Band	Fundamental Frequency	CH	Antenna Pol.	S.G. Output	Antenna Gain	Cable Loss	ERP	Limit
	MHz		V/H	dBm	dBd	dB	dBm	dBm
LTE Band 13	779.5	23205	V	22.21	3.48	-2.91	22.78	44.77
			H	15.36	3.48	-2.91	15.93	44.77
	782.0	23230	V	20.74	3.49	-2.92	21.31	44.77
			H	15.46	3.49	-2.92	16.03	44.77
	784.5	23255	V	22.88	3.50	-2.92	<b>23.46</b>	44.77
			H	15.98	3.50	-2.92	16.55	44.77

**Remark :**

- (1) The RBW,VBW of SPA for frequency RBW= 5MHz , VBW= 8MHz

Unless otherwise stated the results shown in this test report refer only to the sample(s) tested and such sample(s) are retained for 90 days only.

除非另有說明，此報告結果僅對測試之樣品負責，同時此樣品僅保留90天。本報告未經本公司書面許可，不可部份複製。

This document is issued by the Company subject to its General Conditions of Service printed overleaf, available on request or accessible at [www.sgs.com/terms\\_and\\_conditions.htm](http://www.sgs.com/terms_and_conditions.htm) and, for electronic format documents, subject to Terms and Conditions for Electronic Documents at [www.sgs.com/terms\\_e-document.htm](http://www.sgs.com/terms_e-document.htm). Attention is drawn to the limitation of liability, indemnification and jurisdiction issues defined therein. Any holder of this document is advised that information contained hereon reflects the Company's findings at the time of its intervention only and within the limits of Client's instructions, if any. The Company's sole responsibility is to its Client and this document does not exonerate parties to a transaction from exercising all their rights and obligations under the transaction documents. This document cannot be reproduced except in full, without prior written approval of the Company. Any unauthorized alteration, forgery or falsification of the content or appearance of this document is unlawful and offenders may be prosecuted to the fullest extent of the law.



BAND 13 / BW: 10M / QPSK / RB: 1 offset: 0								
EUT			Measurement					
Operation Band	Fundamental Frequency	CH	Antenna Pol.	S.G. Output	Antenna Gain	Cable Loss	ERP	Limit
	MHz		V/H	dBm	dBd	dB	dBm	dBm
LTE Band 13	782.0	23230	V	13.07	3.47	-2.90	13.63	44.77
			H	21.32	3.47	-2.90	<b>21.88</b>	44.77

**Remark :**

- (1) The RBW,VBW of SPA for frequency RBW= 8MHz , VBW= 8MHz

BAND 13 / BW: 10M / QPSK / RB: 1 offset: 49								
EUT			Measurement					
Operation Band	Fundamental Frequency	CH	Antenna Pol.	S.G. Output	Antenna Gain	Cable Loss	ERP	Limit
	MHz		V/H	dBm	dBd	dB	dBm	dBm
LTE Band 13	782.0	23230	V	21.86	3.50	-2.92	<b>22.44</b>	44.77
			H	14.18	3.50	-2.92	14.76	44.77

**Remark :**

- (1) The RBW,VBW of SPA for frequency RBW= 8MHz , VBW= 8MHz

Unless otherwise stated the results shown in this test report refer only to the sample(s) tested and such sample(s) are retained for 90 days only.

除非另有說明，此報告結果僅對測試之樣品負責，同時此樣品僅保留90天。本報告未經本公司書面許可，不可部份複製。

This document is issued by the Company subject to its General Conditions of Service printed overleaf, available on request or accessible at [www.sgs.com/terms\\_and\\_conditions.htm](http://www.sgs.com/terms_and_conditions.htm) and, for electronic format documents, subject to Terms and Conditions for Electronic Documents at [www.sgs.com/terms\\_e-document.htm](http://www.sgs.com/terms_e-document.htm). Attention is drawn to the limitation of liability, indemnification and jurisdiction issues defined therein. Any holder of this document is advised that information contained hereon reflects the Company's findings at the time of its intervention only and within the limits of Client's instructions, if any. The Company's sole responsibility is to its Client and this document does not exonerate parties to a transaction from exercising all their rights and obligations under the transaction documents. This document cannot be reproduced except in full, without prior written approval of the Company. Any unauthorized alteration, forgery or falsification of the content or appearance of this document is unlawful and offenders may be prosecuted to the fullest extent of the law.

BAND 13 / BW: 10M / 16QAM / RB: 1 offset: 0								
EUT			Measurement					
Operation Band	Fundamental Frequency	CH	Antenna Pol.	S.G. Output	Antenna Gain	Cable Loss	ERP	Limit
	MHz		V/H	dBm	dBd	dB	dBm	dBm
LTE Band 13	782.0	23230	V	22.45	3.47	-2.90	<b>23.01</b>	33.00
			H	14.43	3.47	-2.90	15.00	33.00

**Remark :**

- (1) The RBW,VBW of SPA for frequency RBW= 5MHz , VBW= 8MHz

BAND 13 / BW: 10M / 16QAM / RB: 1 offset: 49								
EUT			Measurement					
Operation Band	Fundamental Frequency	CH	Antenna Pol.	S.G. Output	Antenna Gain	Cable Loss	ERP	Limit
	MHz		V/H	dBm	dBd	dB	dBm	dBm
LTE Band 13	782.0	23230	V	22.75	3.50	-2.92	<b>23.33</b>	33.00
			H	15.23	3.50	-2.92	15.81	33.00

**Remark :**

- (1) The RBW,VBW of SPA for frequency RBW= 5MHz , VBW= 8MHz

Unless otherwise stated the results shown in this test report refer only to the sample(s) tested and such sample(s) are retained for 90 days only.

除非另有說明，此報告結果僅對測試之樣品負責，同時此樣品僅保留90天。本報告未經本公司書面許可，不可部份複製。

This document is issued by the Company subject to its General Conditions of Service printed overleaf, available on request or accessible at [www.sgs.com/terms\\_and\\_conditions.htm](http://www.sgs.com/terms_and_conditions.htm) and, for electronic format documents, subject to Terms and Conditions for Electronic Documents at [www.sgs.com/terms\\_e-document.htm](http://www.sgs.com/terms_e-document.htm). Attention is drawn to the limitation of liability, indemnification and jurisdiction issues defined therein. Any holder of this document is advised that information contained hereon reflects the Company's findings at the time of its intervention only and within the limits of Client's instructions, if any. The Company's sole responsibility is to its Client and this document does not exonerate parties to a transaction from exercising all their rights and obligations under the transaction documents. This document cannot be reproduced except in full, without prior written approval of the Company. Any unauthorized alteration, forgery or falsification of the content or appearance of this document is unlawful and offenders may be prosecuted to the fullest extent of the law.

## 9. 99% OCCUPIED BANDWIDTH MEASUREMENT

### 9.1. Standard Applicable:

According to §FCC 2.1049.

### 9.2. Test Set-up:

Refer to section 10.2 in this report

### 9.3. Measurement Procedure:

The EUT's output RF connector was connected with a short cable to the spectrum analyzer, RBW (10/30KHz) was set to about 1% of emission BW, VBW= 3 times RBW(30/100KHz), -26dBc display line was placed on the screen (or 99% bandwidth), the occupied bandwidth is the delta frequency between the two points where the display line intersects the signal trace.

### 9.4. Measurement Equipment Used:

Refer to section 2.4 in this report

Unless otherwise stated the results shown in this test report refer only to the sample(s) tested and such sample(s) are retained for 90 days only.

除非另有說明，此報告結果僅對測試之樣品負責，同時此樣品僅保留90天。本報告未經本公司書面許可，不可部份複製。

This document is issued by the Company subject to its General Conditions of Service printed overleaf, available on request or accessible at [www.sgs.com/terms\\_and\\_conditions.htm](http://www.sgs.com/terms_and_conditions.htm) and, for electronic format documents, subject to Terms and Conditions for Electronic Documents at [www.sgs.com/terms\\_e-document.htm](http://www.sgs.com/terms_e-document.htm). Attention is drawn to the limitation of liability, indemnification and jurisdiction issues defined therein. Any holder of this document is advised that information contained hereon reflects the Company's findings at the time of its intervention only and within the limits of Client's instructions, if any. The Company's sole responsibility is to its Client and this document does not exonerate parties to a transaction from exercising all their rights and obligations under the transaction documents. This document cannot be reproduced except in full, without prior written approval of the Company. Any unauthorized alteration, forgery or falsification of the content or appearance of this document is unlawful and offenders may be prosecuted to the fullest extent of the law.

SGS Taiwan Ltd.

台灣檢驗科技股份有限公司

No.134,WuKungRoad,NewTaipeiIndustrialPark,WukuDistrict,NewTaipeiCity,Taiwan24803/新北市五股區新北產業園區五工路 134 號

t (886-2) 2299-3279

f (886-2) 2298-0488

[www.tw.sgs.com](http://www.tw.sgs.com)

Member of SGS Group

**9.5. Measurement Result:**

EUT Mode	Frequency (MHz)	CH	99% Bandwidth (MHz)
1.4MHz BW LTE-Band 4 (QPSK RB Number: 6 Offset: 0)	1710.7	19957	1.1089
	1732.5	20175	1.1090
	1754.3	20393	1.1125

EUT Mode	Frequency (MHz)	CH	99% Bandwidth (MHz)
1.4MHz BW LTE-Band 4 (16QAM RB Number: 6 Offset: 0)	1710.7	19957	1.1140
	1732.5	20175	1.1181
	1754.3	20393	1.1185

EUT Mode	Frequency (MHz)	CH	99% Bandwidth (MHz)
3MHz BW LTE-Band 4 (QPSK RB Number: 15 Offset: 0)	1711.5	19965	2.7414
	1732.5	20175	2.7278
	1753.5	20385	2.7379

EUT Mode	Frequency (MHz)	CH	99% Bandwidth (MHz)
3MHz BW LTE-Band 4 (16QAM RB Number: 15 Offset: 0)	1711.5	19965	2.7392
	1732.5	20175	2.7424
	1753.5	20385	2.7443

Unless otherwise stated the results shown in this test report refer only to the sample(s) tested and such sample(s) are retained for 90 days only.

除非另有說明，此報告結果僅對測試之樣品負責，同時此樣品僅保留90天。本報告未經本公司書面許可，不可部份複製。

This document is issued by the Company subject to its General Conditions of Service printed overleaf, available on request or accessible at [www.sgs.com/terms\\_and\\_conditions.htm](http://www.sgs.com/terms_and_conditions.htm) and, for electronic format documents, subject to Terms and Conditions for Electronic Documents at [www.sgs.com/terms\\_e-document.htm](http://www.sgs.com/terms_e-document.htm). Attention is drawn to the limitation of liability, indemnification and jurisdiction issues defined therein. Any holder of this document is advised that information contained hereon reflects the Company's findings at the time of its intervention only and within the limits of Client's instructions, if any. The Company's sole responsibility is to its Client and this document does not exonerate parties to a transaction from exercising all their rights and obligations under the transaction documents. This document cannot be reproduced except in full, without prior written approval of the Company. Any unauthorized alteration, forgery or falsification of the content or appearance of this document is unlawful and offenders may be prosecuted to the fullest extent of the law.

EUT Mode	Frequency (MHz)	CH	99% Bandwidth (MHz)
5MHz BW LTE-Band 4 (QPSK RB Number: 25 Offset: 0)	1712.5	19975	4.5236
	1732.5	20175	4.5235
	1752.5	20375	4.5193

EUT Mode	Frequency (MHz)	CH	99% Bandwidth (MHz)
5MHz BW LTE-Band 4 (16QAM RB Number: 25 Offset: 0)	1712.5	19975	4.5249
	1732.5	20175	4.5208
	1752.5	20375	4.5292

EUT Mode	Frequency (MHz)	CH	99% Bandwidth (MHz)
10MHz BW LTE-Band 4 (QPSK RB Number: 50 Offset: 0)	1715	20000	8.9762
	1732.5	20175	8.9835
	1750	20350	9.0091

EUT Mode	Frequency (MHz)	CH	99% Bandwidth (MHz)
10MHz BW LTE-Band 4 (16QAM RB Number: 50 Offset: 0)	1715	20000	8.9958
	1732.5	20175	8.9790
	1750	20350	9.0116

Unless otherwise stated the results shown in this test report refer only to the sample(s) tested and such sample(s) are retained for 90 days only.

除非另有說明，此報告結果僅對測試之樣品負責，同時此樣品僅保留90天。本報告未經本公司書面許可，不可部份複製。

This document is issued by the Company subject to its General Conditions of Service printed overleaf, available on request or accessible at [www.sgs.com/terms\\_and\\_conditions.htm](http://www.sgs.com/terms_and_conditions.htm) and, for electronic format documents, subject to Terms and Conditions for Electronic Documents at [www.sgs.com/terms\\_e-document.htm](http://www.sgs.com/terms_e-document.htm). Attention is drawn to the limitation of liability, indemnification and jurisdiction issues defined therein. Any holder of this document is advised that information contained hereon reflects the Company's findings at the time of its intervention only and within the limits of Client's instructions, if any. The Company's sole responsibility is to its Client and this document does not exonerate parties to a transaction from exercising all their rights and obligations under the transaction documents. This document cannot be reproduced except in full, without prior written approval of the Company. Any unauthorized alteration, forgery or falsification of the content or appearance of this document is unlawful and offenders may be prosecuted to the fullest extent of the law.

EUT Mode	Frequency (MHz)	CH	99% Bandwidth (MHz)
15MHz BW LTE-Band 4 (QPSK RB Number: 75 Offset: 0)	1717.5	20025	13.4872
	1732.5	20175	13.4502
	1747.5	20325	13.4477

EUT Mode	Frequency (MHz)	CH	99% Bandwidth (MHz)
15MHz BW LTE-Band 4 (16QAM RB Number: 75 Offset: 0)	1717.5	20025	13.4496
	1732.5	20175	13.4840
	1747.5	20325	13.4685

EUT Mode	Frequency (MHz)	CH	99% Bandwidth (MHz)
20MHz BW LTE-Band 4 (QPSK RB Number: 100 Offset: 0)	1720	20050	17.8892
	1732.5	20175	17.8919
	1745	20300	17.8522

EUT Mode	Frequency (MHz)	CH	99% Bandwidth (MHz)
20MHz BW LTE-Band 4 (16QAM RB Number: 100 Offset: 0)	1720	20050	17.9328
	1732.5	20175	17.8928
	1745	20300	17.8073

Unless otherwise stated the results shown in this test report refer only to the sample(s) tested and such sample(s) are retained for 90 days only.

除非另有說明，此報告結果僅對測試之樣品負責，同時此樣品僅保留90天。本報告未經本公司書面許可，不可部份複製。

This document is issued by the Company subject to its General Conditions of Service printed overleaf, available on request or accessible at [www.sgs.com/terms\\_and\\_conditions.htm](http://www.sgs.com/terms_and_conditions.htm) and, for electronic format documents, subject to Terms and Conditions for Electronic Documents at [www.sgs.com/terms\\_e-document.htm](http://www.sgs.com/terms_e-document.htm). Attention is drawn to the limitation of liability, indemnification and jurisdiction issues defined therein. Any holder of this document is advised that information contained hereon reflects the Company's findings at the time of its intervention only and within the limits of Client's instructions, if any. The Company's sole responsibility is to its Client and this document does not exonerate parties to a transaction from exercising all their rights and obligations under the transaction documents. This document cannot be reproduced except in full, without prior written approval of the Company. Any unauthorized alteration, forgery or falsification of the content or appearance of this document is unlawful and offenders may be prosecuted to the fullest extent of the law.

EUT Mode	Frequency (MHz)	CH	99% Bandwidth (MHz)
5MHz BW LTE-Band 13 (QPSK RB Number: 25 Offset: 0)	779.5	23205	4.5016
	782	23230	4.4932
	784.5	23255	4.4980

EUT Mode	Frequency (MHz)	CH	99% Bandwidth (MHz)
5MHz BW LTE-Band 13 (16QAM RB Number: 25 Offset: 0)	779.5	23205	4.4923
	782	23230	4.4990
	784.5	23255	4.4892

EUT Mode	Frequency (MHz)	CH	99% Bandwidth (MHz)
10MHz BW LTE-Band 13 (QPSK RB Number: 50 Offset: 0)	782	23230	8.9509

EUT Mode	Frequency (MHz)	CH	99% Bandwidth (MHz)
10MHz BW LTE-Band 13 (16QAM RB Number: 50 Offset: 0)	782	23230	8.9381

Unless otherwise stated the results shown in this test report refer only to the sample(s) tested and such sample(s) are retained for 90 days only.

除非另有說明，此報告結果僅對測試之樣品負責，同時此樣品僅保留90天。本報告未經本公司書面許可，不可部份複製。

This document is issued by the Company subject to its General Conditions of Service printed overleaf, available on request or accessible at [www.sgs.com/terms\\_and\\_conditions.htm](http://www.sgs.com/terms_and_conditions.htm) and, for electronic format documents, subject to Terms and Conditions for Electronic Documents at [www.sgs.com/terms\\_e-document.htm](http://www.sgs.com/terms_e-document.htm). Attention is drawn to the limitation of liability, indemnification and jurisdiction issues defined therein. Any holder of this document is advised that information contained hereon reflects the Company's findings at the time of its intervention only and within the limits of Client's instructions, if any. The Company's sole responsibility is to its Client and this document does not exonerate parties to a transaction from exercising all their rights and obligations under the transaction documents. This document cannot be reproduced except in full, without prior written approval of the Company. Any unauthorized alteration, forgery or falsification of the content or appearance of this document is unlawful and offenders may be prosecuted to the fullest extent of the law.

Figure 9-1: 1.4MHz BW LTE-Band 4(QPSK RB Number: 6 Offset: 0) Channel Low

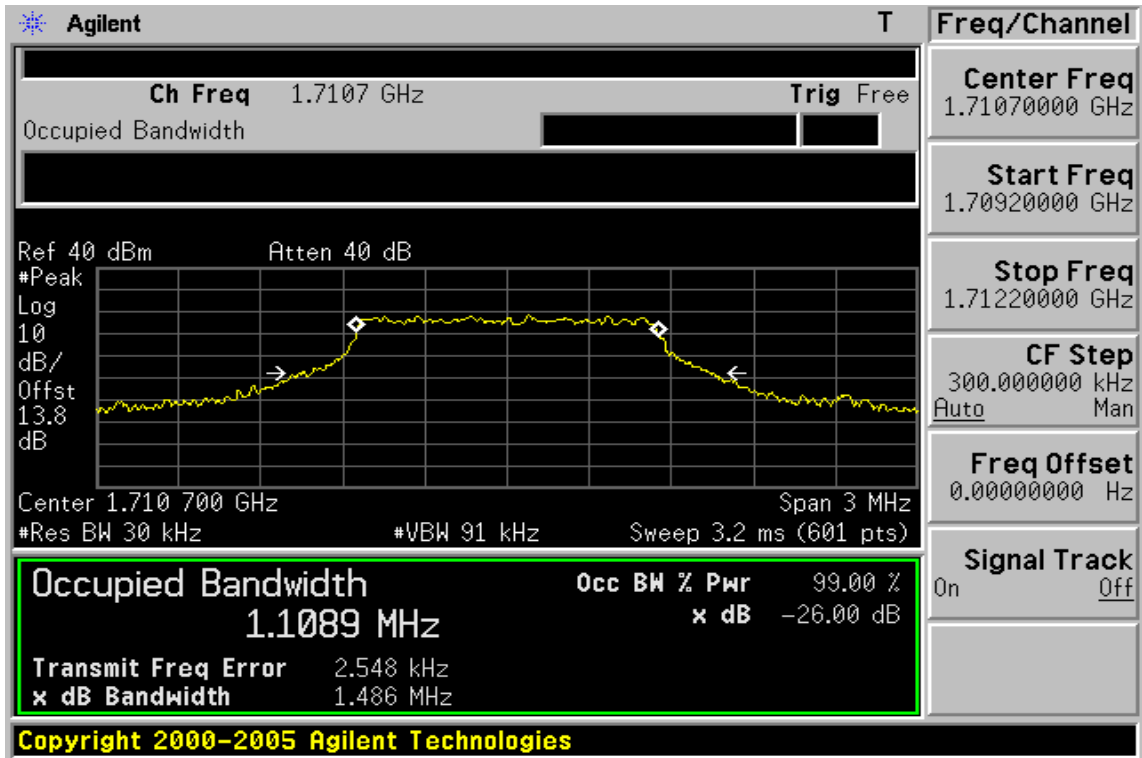
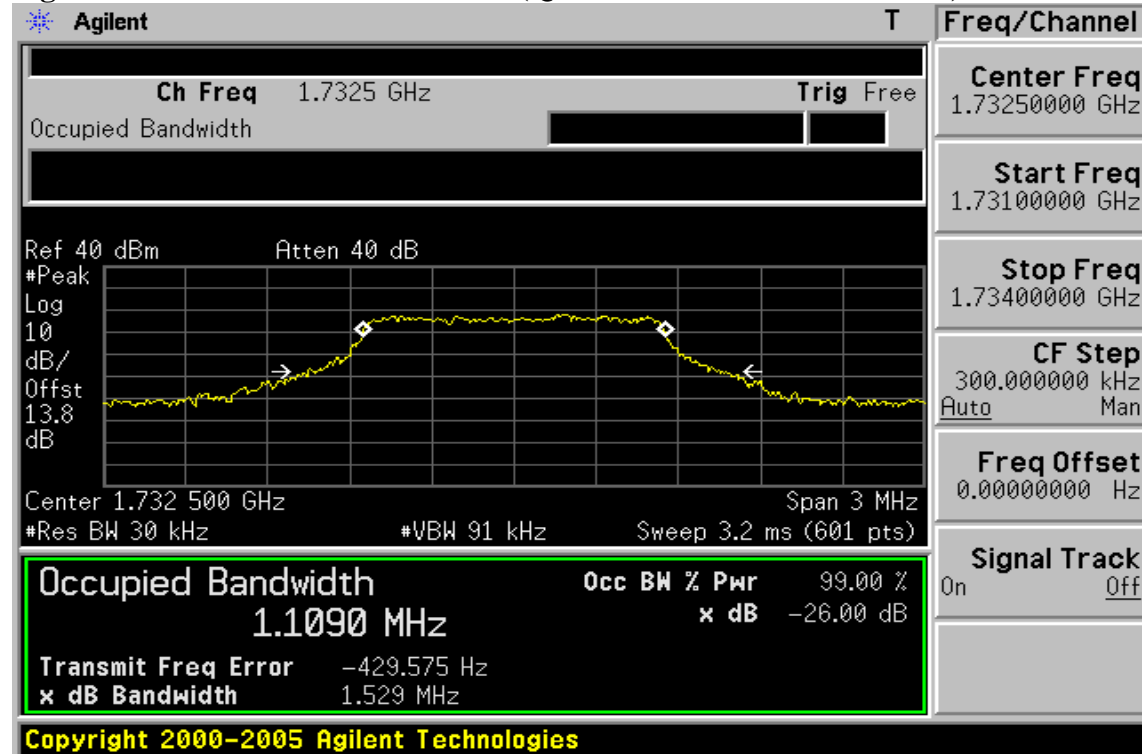

Figure 9-2: 1.4MHz BW LTE-Band 4(QPSK RB Number: 6 Offset: 0) Channel Mid



Unless otherwise stated the results shown in this test report refer only to the sample(s) tested and such sample(s) are retained for 90 days only.

除非另有說明，此報告結果僅對測試之樣品負責，同時此樣品僅保留90天。本報告未經本公司書面許可，不可部份複製。

This document is issued by the Company subject to its General Conditions of Service printed overleaf, available on request or accessible at [www.sgs.com/terms\\_and\\_conditions.htm](http://www.sgs.com/terms_and_conditions.htm) and, for electronic format documents, subject to Terms and Conditions for Electronic Documents at [www.sgs.com/terms\\_e-document.htm](http://www.sgs.com/terms_e-document.htm). Attention is drawn to the limitation of liability, indemnification and jurisdiction issues defined therein. Any holder of this document is advised that information contained hereon reflects the Company's findings at the time of its intervention only and within the limits of Client's instructions, if any. The Company's sole responsibility is to its Client and this document does not exonerate parties to a transaction from exercising all their rights and obligations under the transaction documents. This document cannot be reproduced except in full, without prior written approval of the Company. Any unauthorized alteration, forgery or falsification of the content or appearance of this document is unlawful and offenders may be prosecuted to the fullest extent of the law.

SGS Taiwan Ltd.

No.134,WuKungRoad,NewTaipeiIndustrialPark,WukuDistrict,NewTaipeiCity,Taiwan24803/新北市五股區新北產業園區五工路 134 號

台灣檢驗科技股份有限公司

t (886-2) 2299-3279

f (886-2) 2298-0488

[www.tw.sgs.com](http://www.tw.sgs.com)

Member of SGS Group



**Figure 9-3: 1.4MHz BW LTE-Band 4(QPSK RB Number: 6 Offset: 0) Channel High**

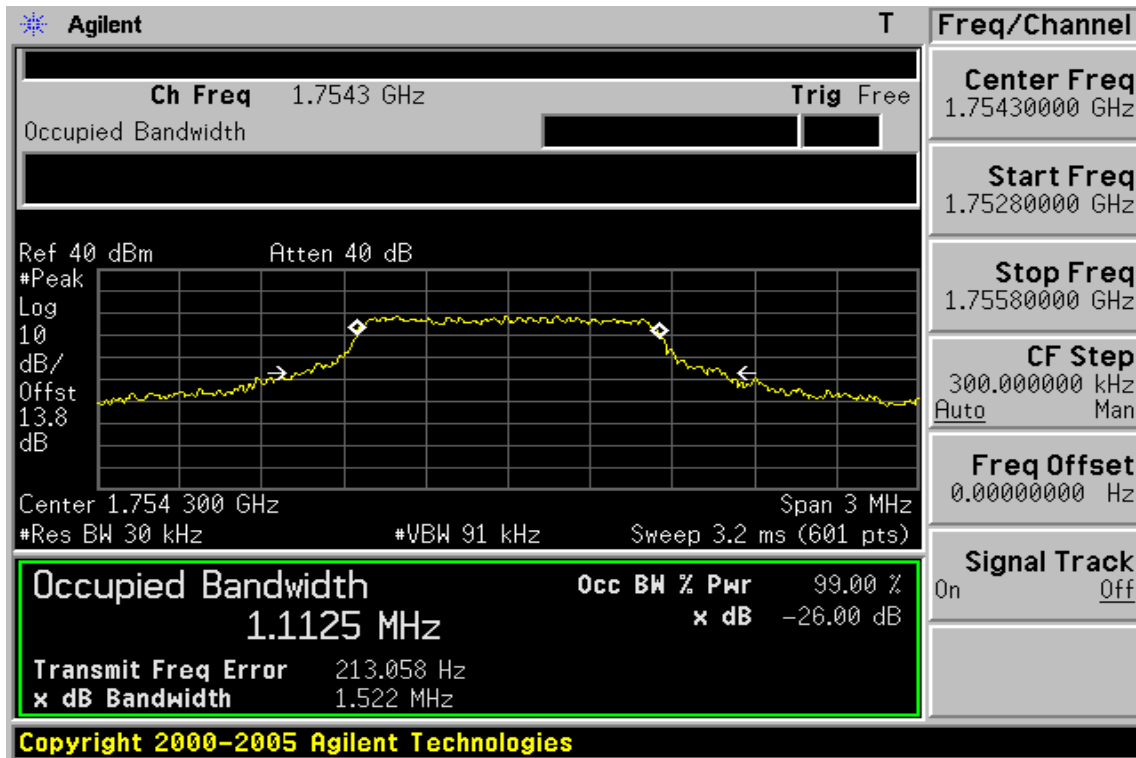

**Figure 9-4: 1.4MHz BW LTE-Band 4(16QAM RB Number: 6 Offset: 0) Channel Low**

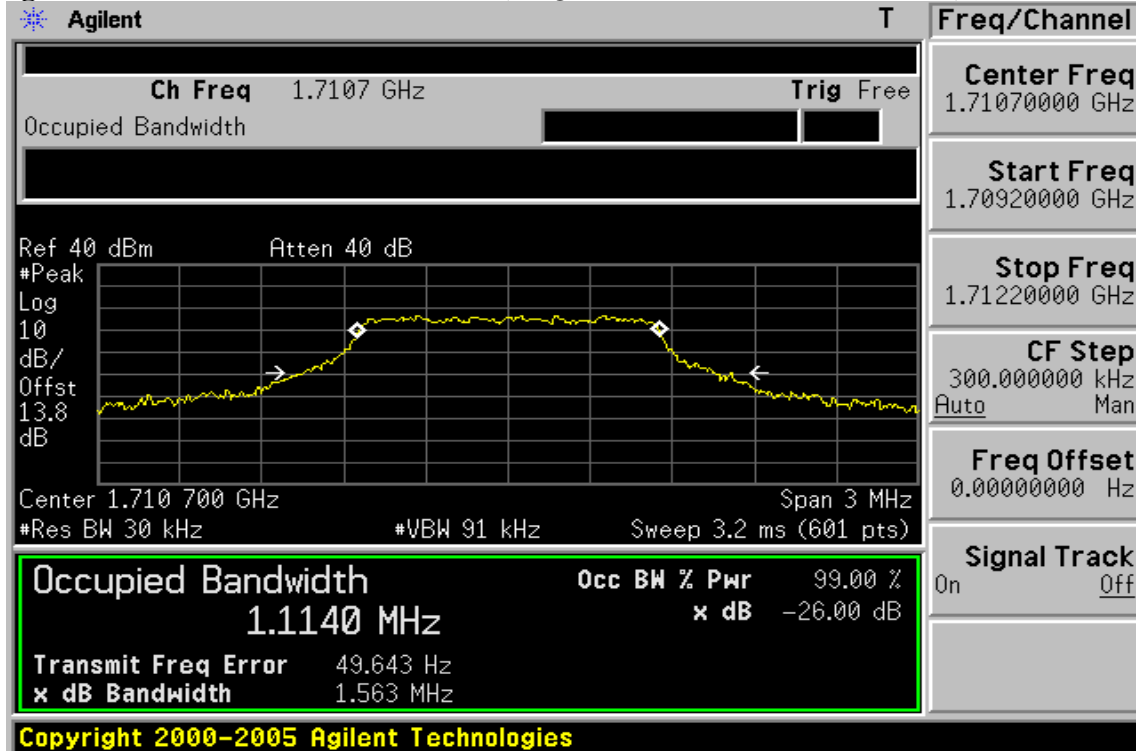

Unless otherwise stated the results shown in this test report refer only to the sample(s) tested and such sample(s) are retained for 90 days only.

除非另有說明，此報告結果僅對測試之樣品負責，同時此樣品僅保留90天。本報告未經本公司書面許可，不可部份複製。

This document is issued by the Company subject to its General Conditions of Service printed overleaf, available on request or accessible at [www.sgs.com/terms\\_and\\_conditions.htm](http://www.sgs.com/terms_and_conditions.htm) and, for electronic format documents, subject to Terms and Conditions for Electronic Documents at [www.sgs.com/terms\\_e-document.htm](http://www.sgs.com/terms_e-document.htm). Attention is drawn to the limitation of liability, indemnification and jurisdiction issues defined therein. Any holder of this document is advised that information contained hereon reflects the Company's findings at the time of its intervention only and within the limits of Client's instructions, if any. The Company's sole responsibility is to its Client and this document does not exonerate parties to a transaction from exercising all their rights and obligations under the transaction documents. This document cannot be reproduced except in full, without prior written approval of the Company. Any unauthorized alteration, forgery or falsification of the content or appearance of this document is unlawful and offenders may be prosecuted to the fullest extent of the law.

Figure 9-5: 1.4MHz BW LTE-Band 4(16QAM RB Number: 6 Offset: 0) Channel Mid

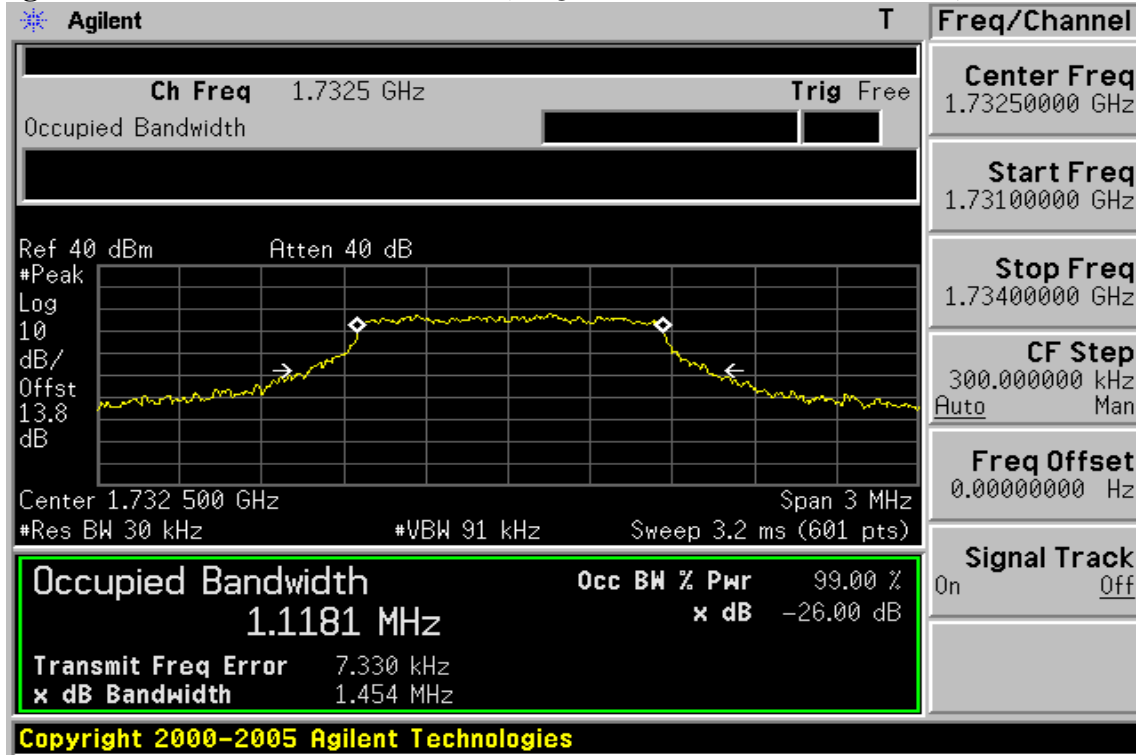
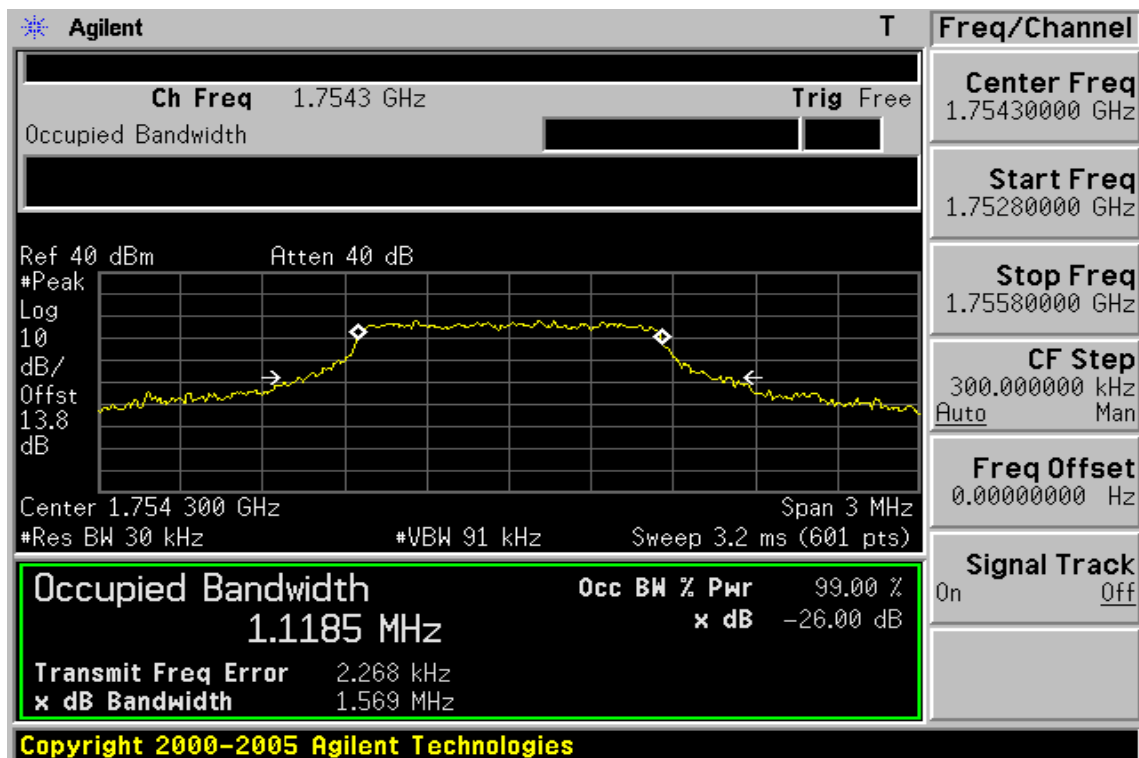

Figure 9-6: 1.4MHz BW LTE-Band 4(16QAM RB Number: 6 Offset: 0) Channel High



Unless otherwise stated the results shown in this test report refer only to the sample(s) tested and such sample(s) are retained for 90 days only.

除非另有說明，此報告結果僅對測試之樣品負責，同時此樣品僅保留90天。本報告未經本公司書面許可，不可部份複製。

This document is issued by the Company subject to its General Conditions of Service printed overleaf, available on request or accessible at [www.sgs.com/terms\\_and\\_conditions.htm](http://www.sgs.com/terms_and_conditions.htm) and, for electronic format documents, subject to Terms and Conditions for Electronic Documents at [www.sgs.com/terms\\_e-document.htm](http://www.sgs.com/terms_e-document.htm). Attention is drawn to the limitation of liability, indemnification and jurisdiction issues defined therein. Any holder of this document is advised that information contained hereon reflects the Company's findings at the time of its intervention only and within the limits of Client's instructions, if any. The Company's sole responsibility is to its Client and this document does not exonerate parties to a transaction from exercising all their rights and obligations under the transaction documents. This document cannot be reproduced except in full, without prior written approval of the Company. Any unauthorized alteration, forgery or falsification of the content or appearance of this document is unlawful and offenders may be prosecuted to the fullest extent of the law.

Figure 9-7: 3MHz BW LTE-Band 4(QPSK RB Number: 15 Offset: 0) Channel Low

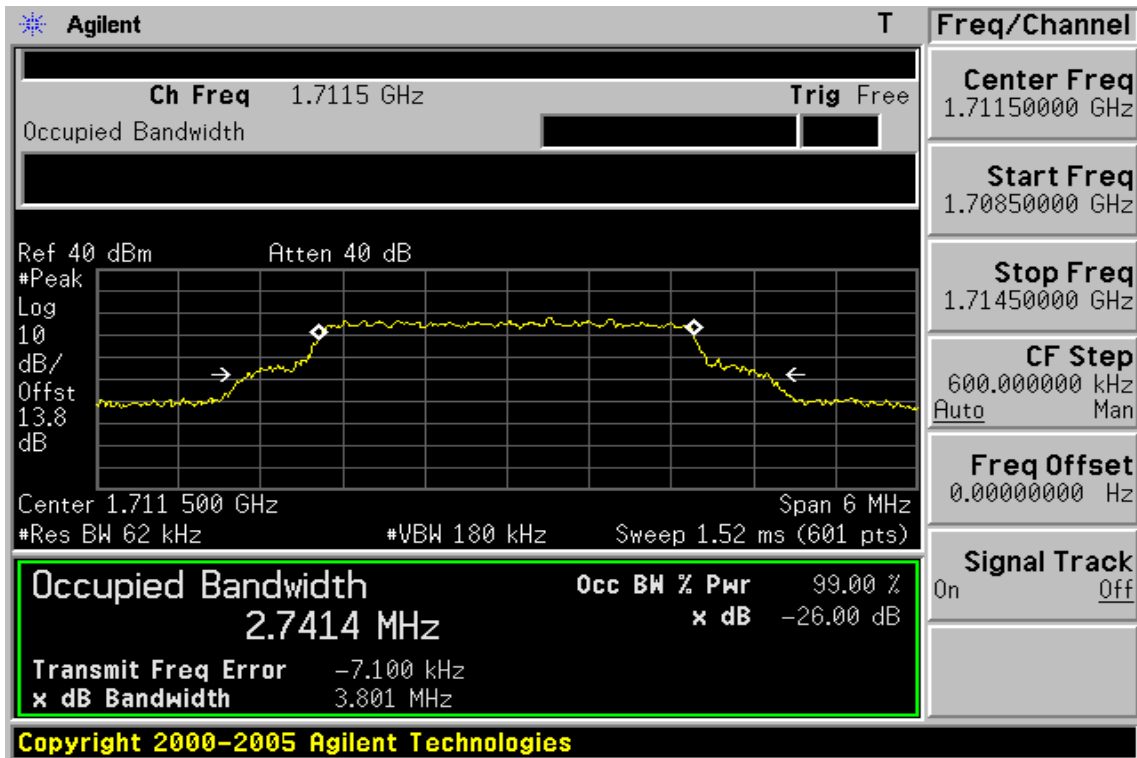
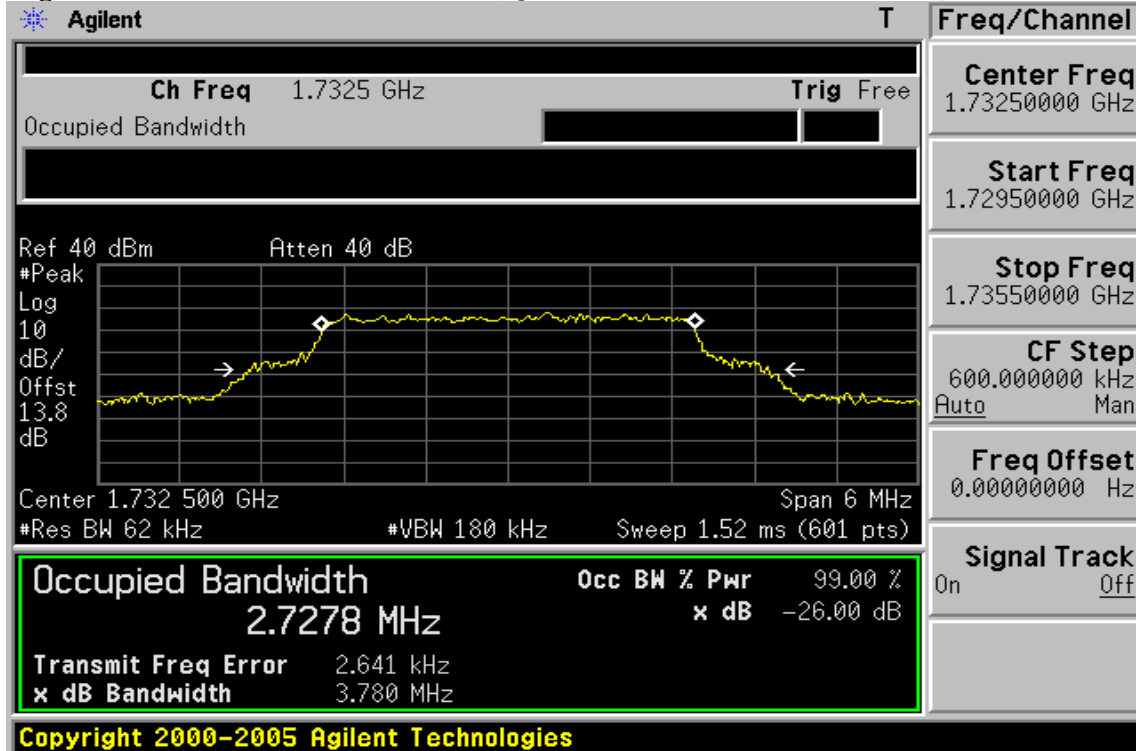

Figure 9-8: 3MHz BW LTE-Band 4(QPSK RB Number: 15 Offset: 0) Channel Mid



Unless otherwise stated the results shown in this test report refer only to the sample(s) tested and such sample(s) are retained for 90 days only.

除非另有說明，此報告結果僅對測試之樣品負責，同時此樣品僅保留90天。本報告未經本公司書面許可，不可部份複製。

This document is issued by the Company subject to its General Conditions of Service printed overleaf, available on request or accessible at [www.sgs.com/terms\\_and\\_conditions.htm](http://www.sgs.com/terms_and_conditions.htm) and, for electronic format documents, subject to Terms and Conditions for Electronic Documents at [www.sgs.com/terms\\_e-document.htm](http://www.sgs.com/terms_e-document.htm). Attention is drawn to the limitation of liability, indemnification and jurisdiction issues defined therein. Any holder of this document is advised that information contained hereon reflects the Company's findings at the time of its intervention only and within the limits of Client's instructions, if any. The Company's sole responsibility is to its Client and this document does not exonerate parties to a transaction from exercising all their rights and obligations under the transaction documents. This document cannot be reproduced except in full, without prior written approval of the Company. Any unauthorized alteration, forgery or falsification of the content or appearance of this document is unlawful and offenders may be prosecuted to the fullest extent of the law.

**Figure 9-9: 3MHz BW LTE-Band 4(QPSK RB Number: 15 Offset: 0) Channel High**

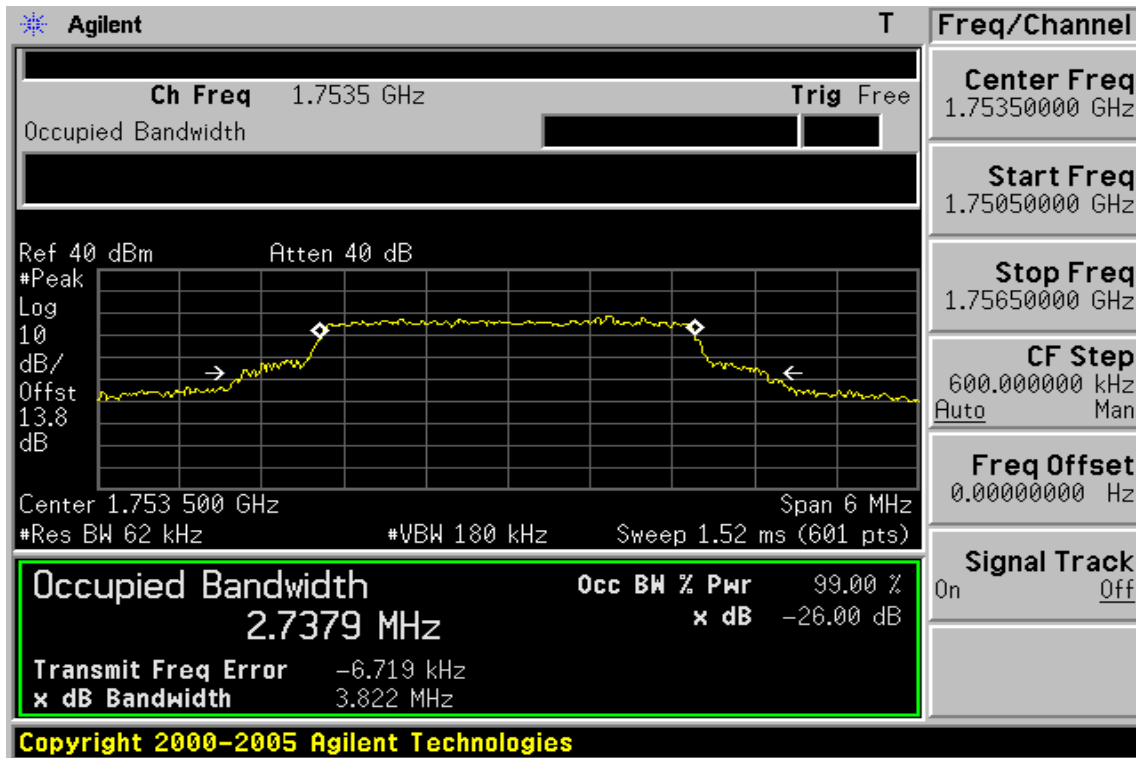

**Figure 9-10: 3MHz BW LTE-Band 4(16QAM RB Number: 15 Offset: 0) Channel Low**

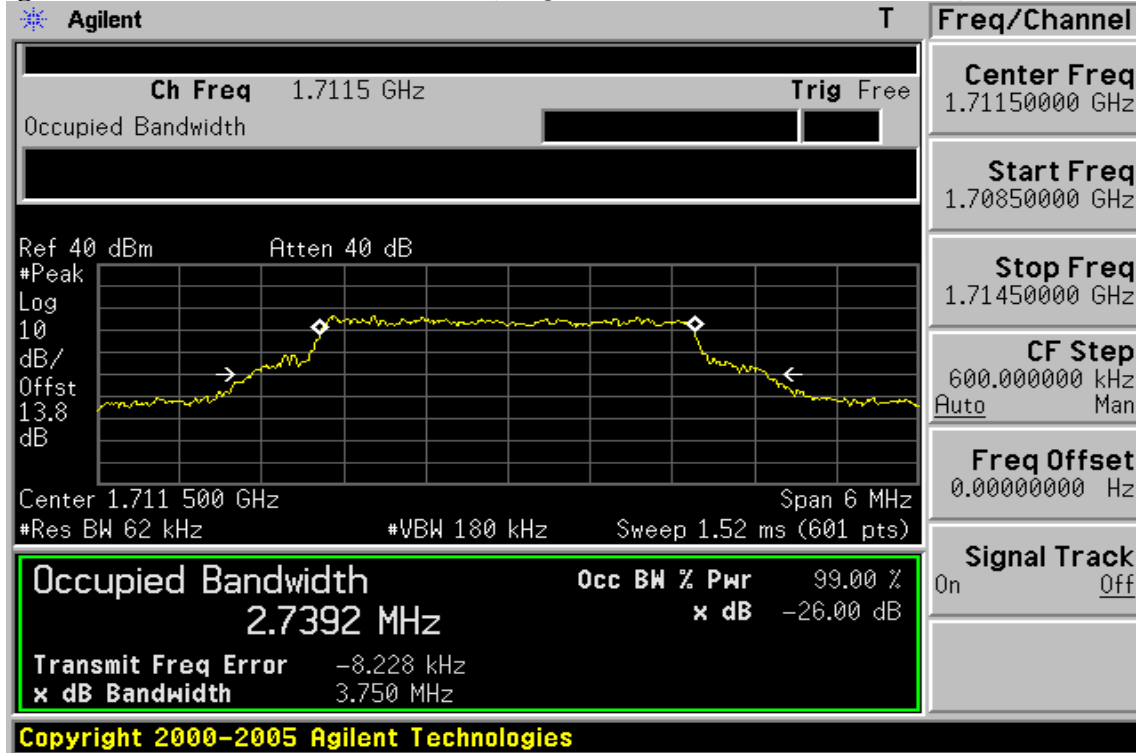

Unless otherwise stated the results shown in this test report refer only to the sample(s) tested and such sample(s) are retained for 90 days only.

除非另有說明，此報告結果僅對測試之樣品負責，同時此樣品僅保留90天。本報告未經本公司書面許可，不可部份複製。

This document is issued by the Company subject to its General Conditions of Service printed overleaf, available on request or accessible at [www.sgs.com/terms\\_and\\_conditions.htm](http://www.sgs.com/terms_and_conditions.htm) and, for electronic format documents, subject to Terms and Conditions for Electronic Documents at [www.sgs.com/terms\\_e-document.htm](http://www.sgs.com/terms_e-document.htm). Attention is drawn to the limitation of liability, indemnification and jurisdiction issues defined therein. Any holder of this document is advised that information contained hereon reflects the Company's findings at the time of its intervention only and within the limits of Client's instructions, if any. The Company's sole responsibility is to its Client and this document does not exonerate parties to a transaction from exercising all their rights and obligations under the transaction documents. This document cannot be reproduced except in full, without prior written approval of the Company. Any unauthorized alteration, forgery or falsification of the content or appearance of this document is unlawful and offenders may be prosecuted to the fullest extent of the law.

Figure 9-11: 3MHz BW LTE-Band 4(16QAM RB Number: 15 Offset: 0) Channel Mid

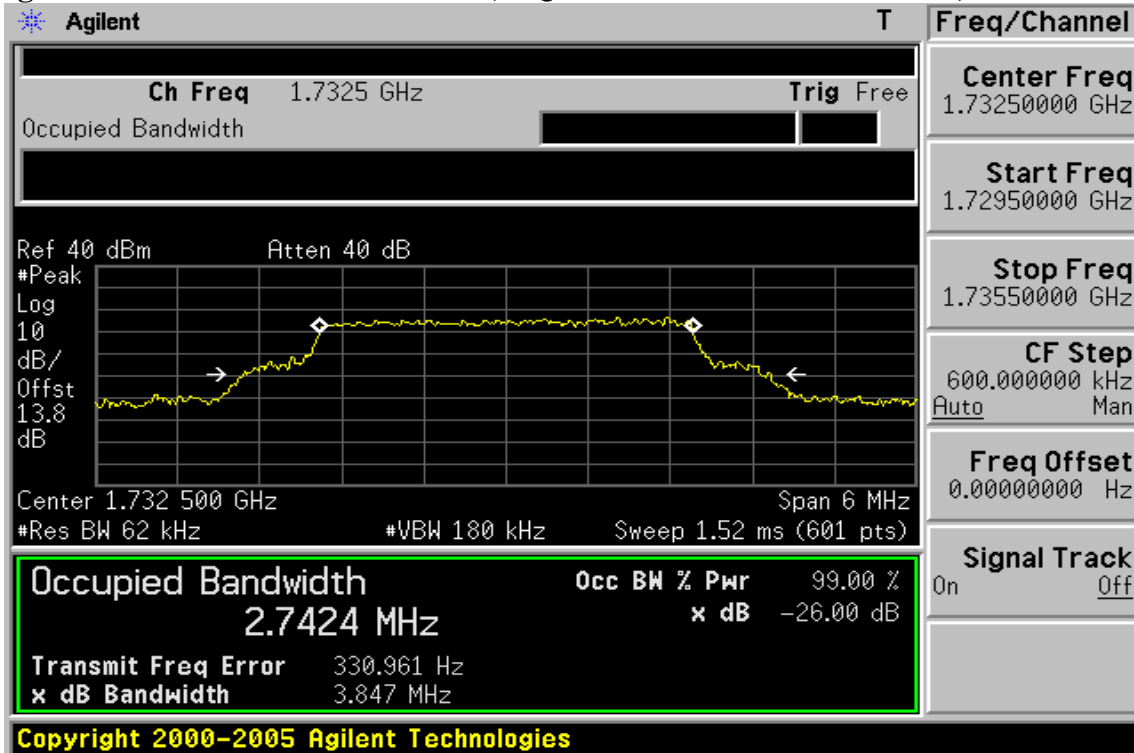
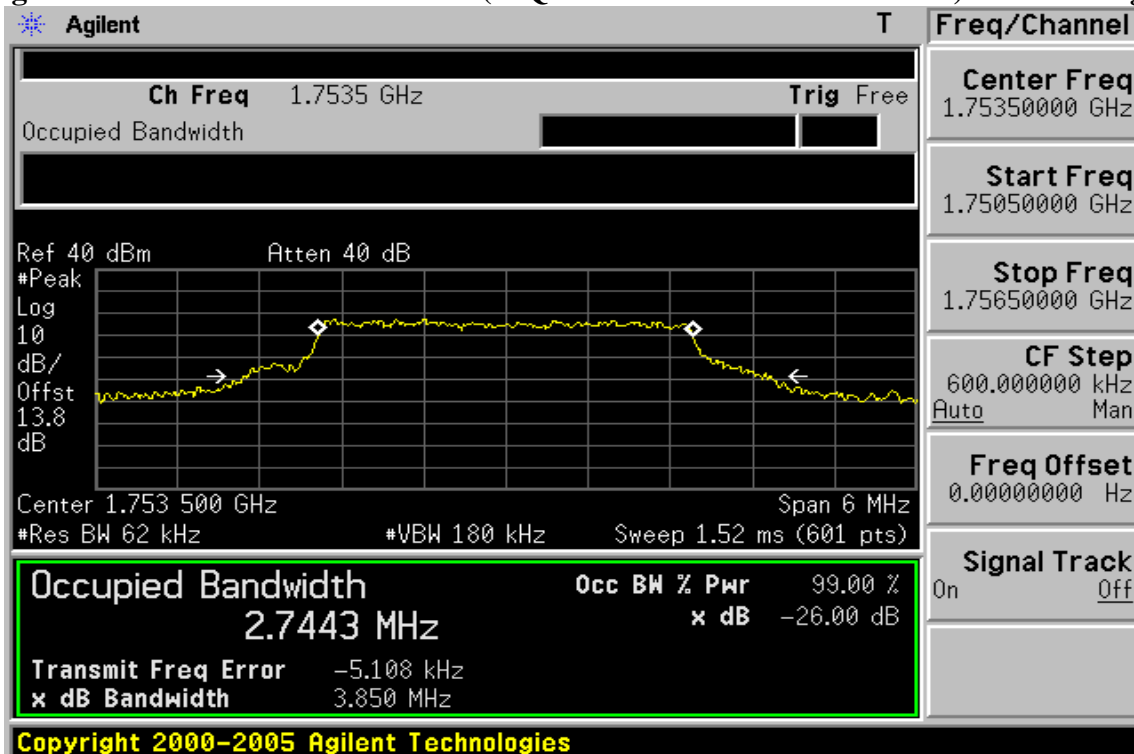

Figure 9-12: 3MHz BW LTE-Band 4(16QAM RB Number: 15 Offset: 0) Channel High



Unless otherwise stated the results shown in this test report refer only to the sample(s) tested and such sample(s) are retained for 90 days only.

除非另有說明，此報告結果僅對測試之樣品負責，同時此樣品僅保留90天。本報告未經本公司書面許可，不可部份複製。

This document is issued by the Company subject to its General Conditions of Service printed overleaf, available on request or accessible at [www.sgs.com/terms\\_and\\_conditions.htm](http://www.sgs.com/terms_and_conditions.htm) and, for electronic format documents, subject to Terms and Conditions for Electronic Documents at [www.sgs.com/terms\\_e-document.htm](http://www.sgs.com/terms_e-document.htm). Attention is drawn to the limitation of liability, indemnification and jurisdiction issues defined therein. Any holder of this document is advised that information contained hereon reflects the Company's findings at the time of its intervention only and within the limits of Client's instructions, if any. The Company's sole responsibility is to its Client and this document does not exonerate parties to a transaction from exercising all their rights and obligations under the transaction documents. This document cannot be reproduced except in full, without prior written approval of the Company. Any unauthorized alteration, forgery or falsification of the content or appearance of this document is unlawful and offenders may be prosecuted to the fullest extent of the law.

Figure 9-13: 5MHz BW LTE-Band 4(QPSK RB Number: 25 Offset: 0) Channel Low

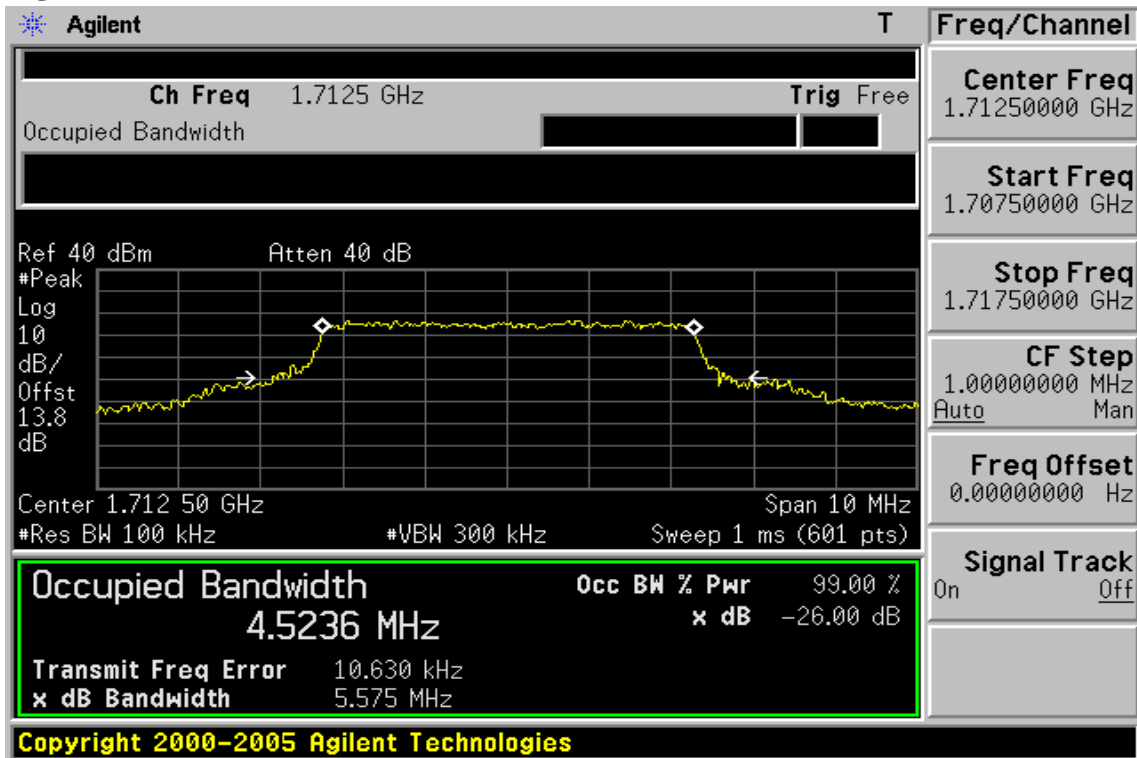
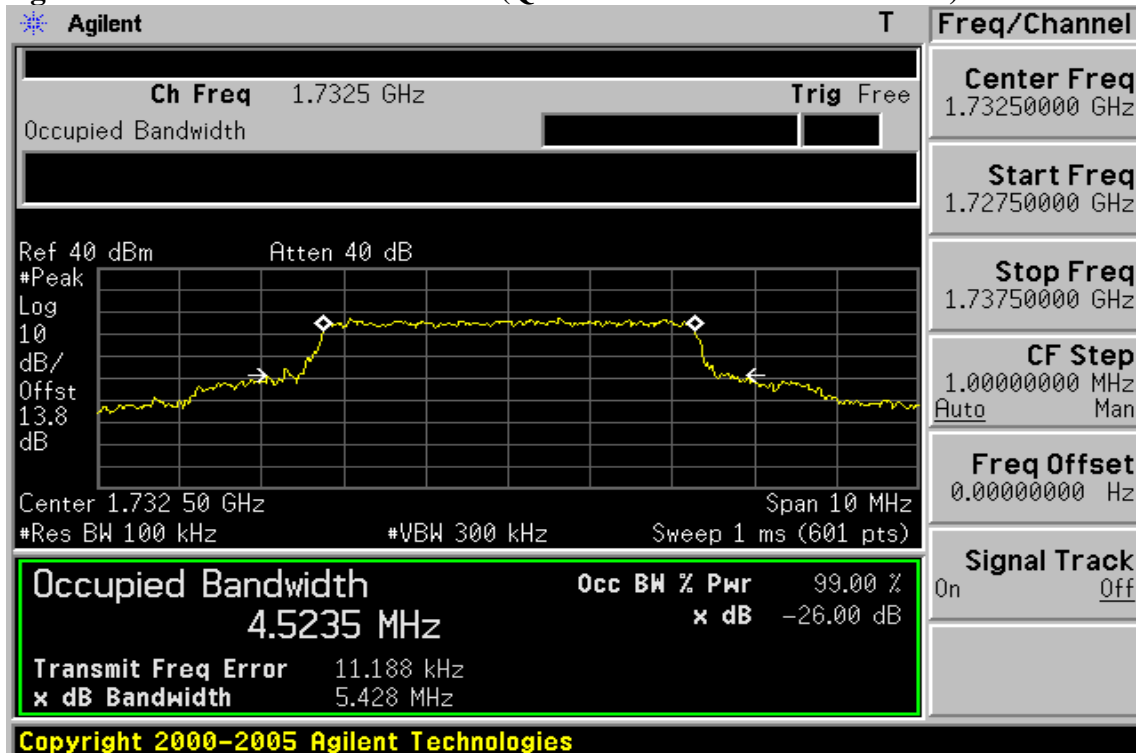

Figure 9-14: 5MHz BW LTE-Band 4(QPSK RB Number: 25 Offset: 0) Channel Mid



Unless otherwise stated the results shown in this test report refer only to the sample(s) tested and such sample(s) are retained for 90 days only.

除非另有說明，此報告結果僅對測試之樣品負責，同時此樣品僅保留90天。本報告未經本公司書面許可，不可部份複製。

This document is issued by the Company subject to its General Conditions of Service printed overleaf, available on request or accessible at [www.sgs.com/terms\\_and\\_conditions.htm](http://www.sgs.com/terms_and_conditions.htm) and, for electronic format documents, subject to Terms and Conditions for Electronic Documents at [www.sgs.com/terms\\_e-document.htm](http://www.sgs.com/terms_e-document.htm). Attention is drawn to the limitation of liability, indemnification and jurisdiction issues defined therein. Any holder of this document is advised that information contained hereon reflects the Company's findings at the time of its intervention only and within the limits of Client's instructions, if any. The Company's sole responsibility is to its Client and this document does not exonerate parties to a transaction from exercising all their rights and obligations under the transaction documents. This document cannot be reproduced except in full, without prior written approval of the Company. Any unauthorized alteration, forgery or falsification of the content or appearance of this document is unlawful and offenders may be prosecuted to the fullest extent of the law.

Figure 9-15: 5MHz BW LTE-Band 4(QPSK RB Number: 25 Offset: 0) Channel High

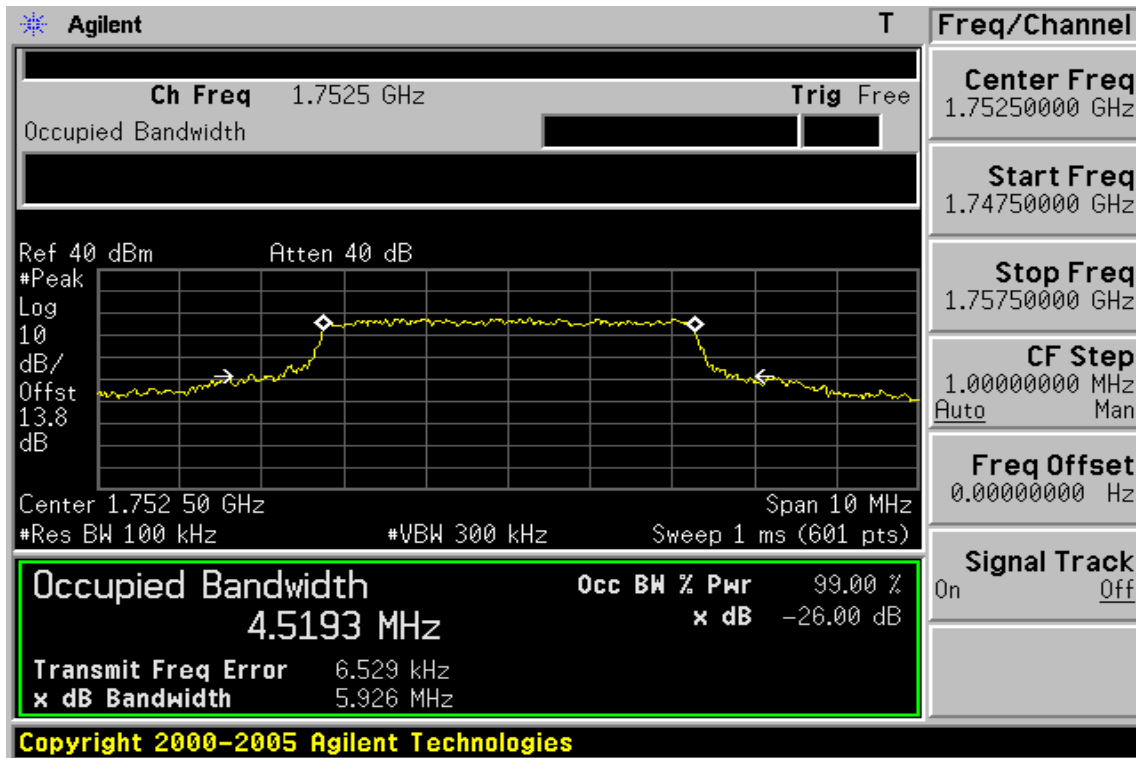
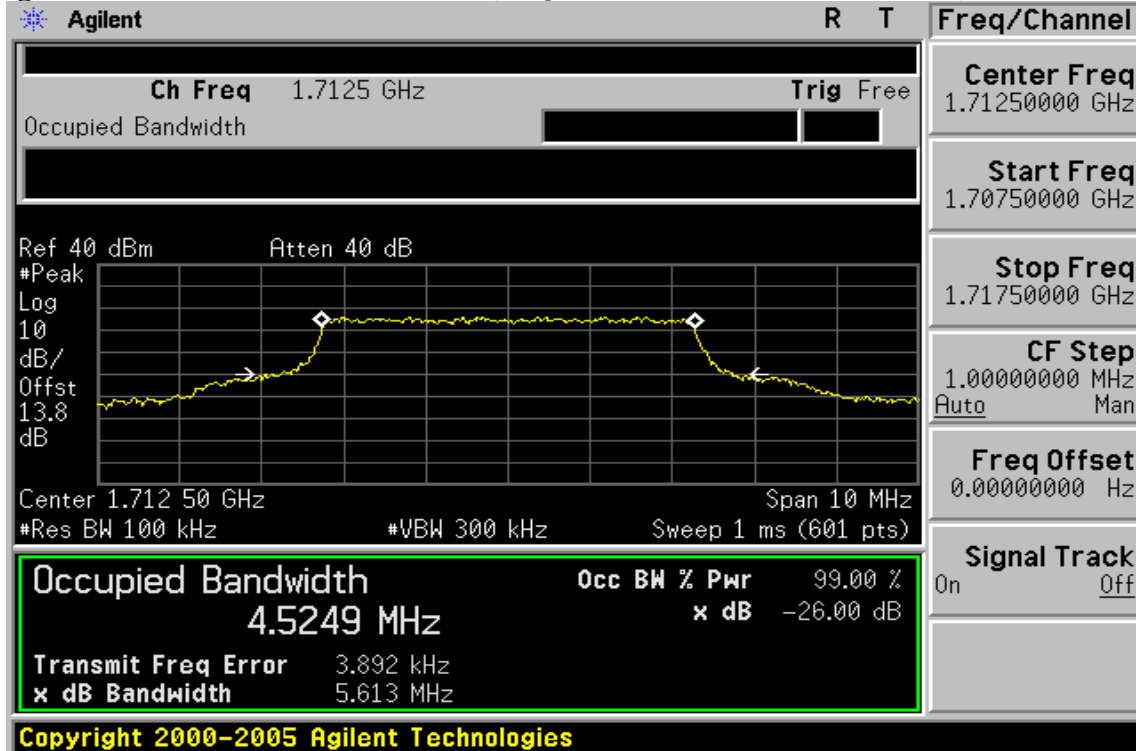

Figure 9-16: 5MHz BW LTE-Band 4(16QAM RB Number: 25 Offset: 0) Channel Low



Unless otherwise stated the results shown in this test report refer only to the sample(s) tested and such sample(s) are retained for 90 days only.

除非另有說明，此報告結果僅對測試之樣品負責，同時此樣品僅保留90天。本報告未經本公司書面許可，不可部份複製。

This document is issued by the Company subject to its General Conditions of Service printed overleaf, available on request or accessible at [www.sgs.com/terms\\_and\\_conditions.htm](http://www.sgs.com/terms_and_conditions.htm) and, for electronic format documents, subject to Terms and Conditions for Electronic Documents at [www.sgs.com/terms\\_e-document.htm](http://www.sgs.com/terms_e-document.htm). Attention is drawn to the limitation of liability, indemnification and jurisdiction issues defined therein. Any holder of this document is advised that information contained hereon reflects the Company's findings at the time of its intervention only and within the limits of Client's instructions, if any. The Company's sole responsibility is to its Client and this document does not exonerate parties to a transaction from exercising all their rights and obligations under the transaction documents. This document cannot be reproduced except in full, without prior written approval of the Company. Any unauthorized alteration, forgery or falsification of the content or appearance of this document is unlawful and offenders may be prosecuted to the fullest extent of the law.

**Figure 9-17: 5MHz BW LTE-Band 4(16QAM RB Number: 25 Offset: 0) Channel Mid**

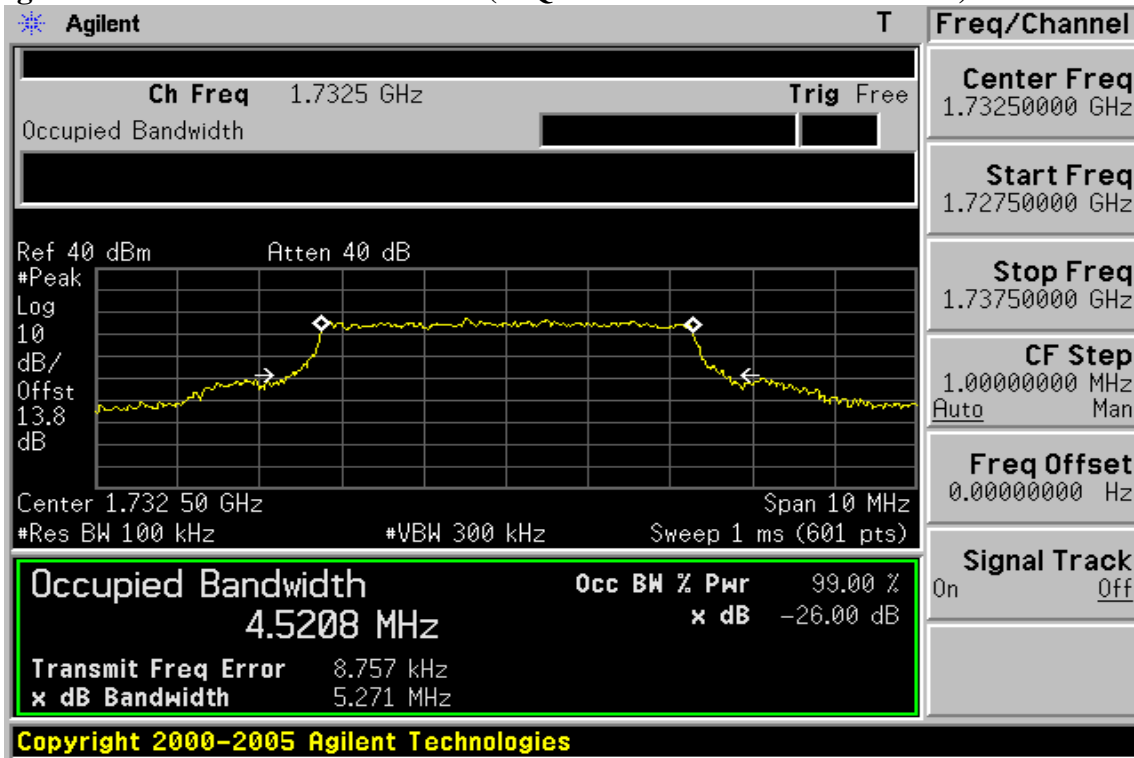

**Figure 9-18: 5MHz BW LTE-Band 4(16QAM RB Number: 25 Offset: 0) Channel High**

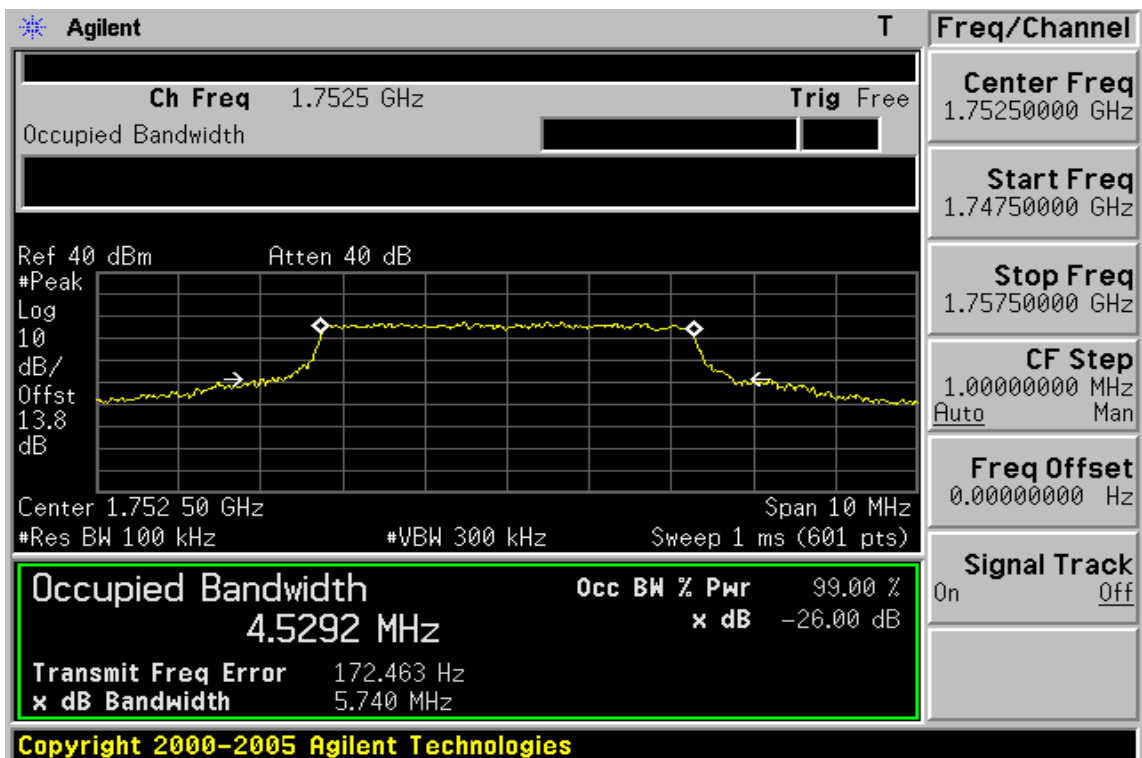

Unless otherwise stated the results shown in this test report refer only to the sample(s) tested and such sample(s) are retained for 90 days only.

除非另有說明，此報告結果僅對測試之樣品負責，同時此樣品僅保留90天。本報告未經本公司書面許可，不可部份複製。

This document is issued by the Company subject to its General Conditions of Service printed overleaf, available on request or accessible at [www.sgs.com/terms\\_and\\_conditions.htm](http://www.sgs.com/terms_and_conditions.htm) and, for electronic format documents, subject to Terms and Conditions for Electronic Documents at [www.sgs.com/terms\\_e-document.htm](http://www.sgs.com/terms_e-document.htm). Attention is drawn to the limitation of liability, indemnification and jurisdiction issues defined therein. Any holder of this document is advised that information contained hereon reflects the Company's findings at the time of its intervention only and within the limits of Client's instructions, if any. The Company's sole responsibility is to its Client and this document does not exonerate parties to a transaction from exercising all their rights and obligations under the transaction documents. This document cannot be reproduced except in full, without prior written approval of the Company. Any unauthorized alteration, forgery or falsification of the content or appearance of this document is unlawful and offenders may be prosecuted to the fullest extent of the law.



Figure 9-19: 10MHz BW LTE-Band 4(QPSK RB Number: 50 Offset: 0) Channel Low

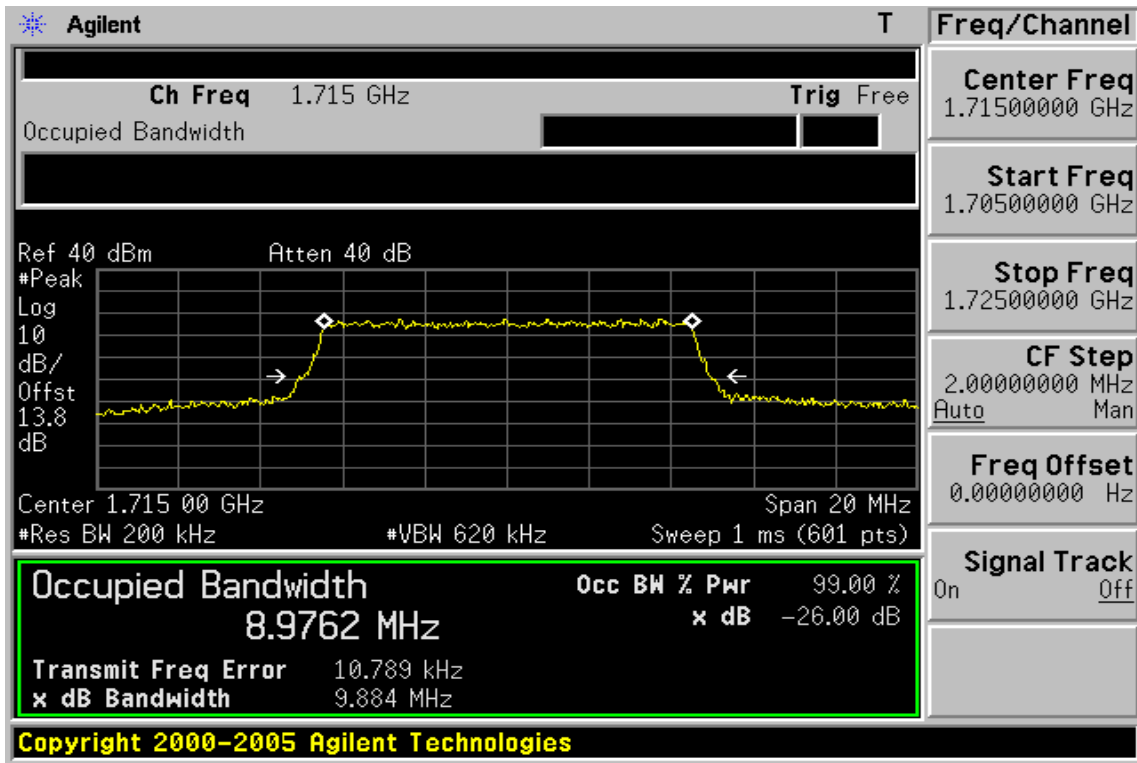
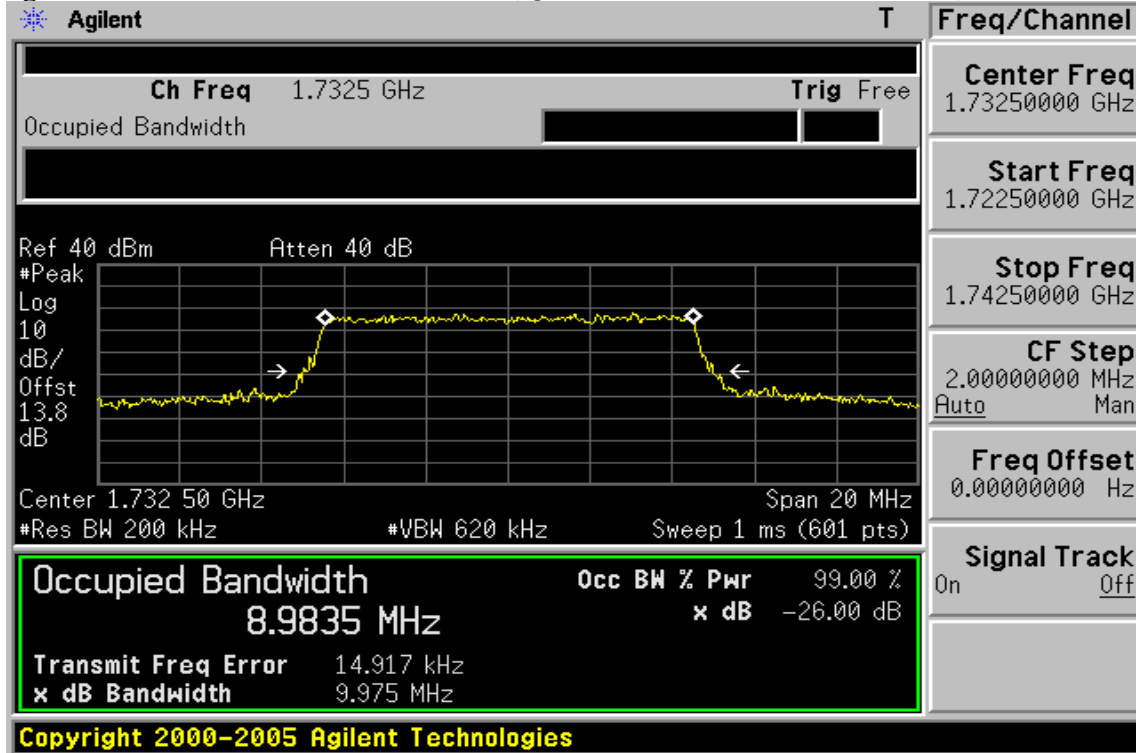

Figure 9-20: 10MHz BW LTE-Band 4(QPSK RB Number: 50 Offset: 0) Channel Mid



Unless otherwise stated the results shown in this test report refer only to the sample(s) tested and such sample(s) are retained for 90 days only.

除非另有說明，此報告結果僅對測試之樣品負責，同時此樣品僅保留90天。本報告未經本公司書面許可，不可部份複製。

This document is issued by the Company subject to its General Conditions of Service printed overleaf, available on request or accessible at [www.sgs.com/terms\\_and\\_conditions.htm](http://www.sgs.com/terms_and_conditions.htm) and, for electronic format documents, subject to Terms and Conditions for Electronic Documents at [www.sgs.com/terms\\_e-document.htm](http://www.sgs.com/terms_e-document.htm). Attention is drawn to the limitation of liability, indemnification and jurisdiction issues defined therein. Any holder of this document is advised that information contained hereon reflects the Company's findings at the time of its intervention only and within the limits of Client's instructions, if any. The Company's sole responsibility is to its Client and this document does not exonerate parties to a transaction from exercising all their rights and obligations under the transaction documents. This document cannot be reproduced except in full, without prior written approval of the Company. Any unauthorized alteration, forgery or falsification of the content or appearance of this document is unlawful and offenders may be prosecuted to the fullest extent of the law.

**Figure 9-21: 10MHz BW LTE-Band 4(QPSK RB Number: 50 Offset: 0) Channel High**

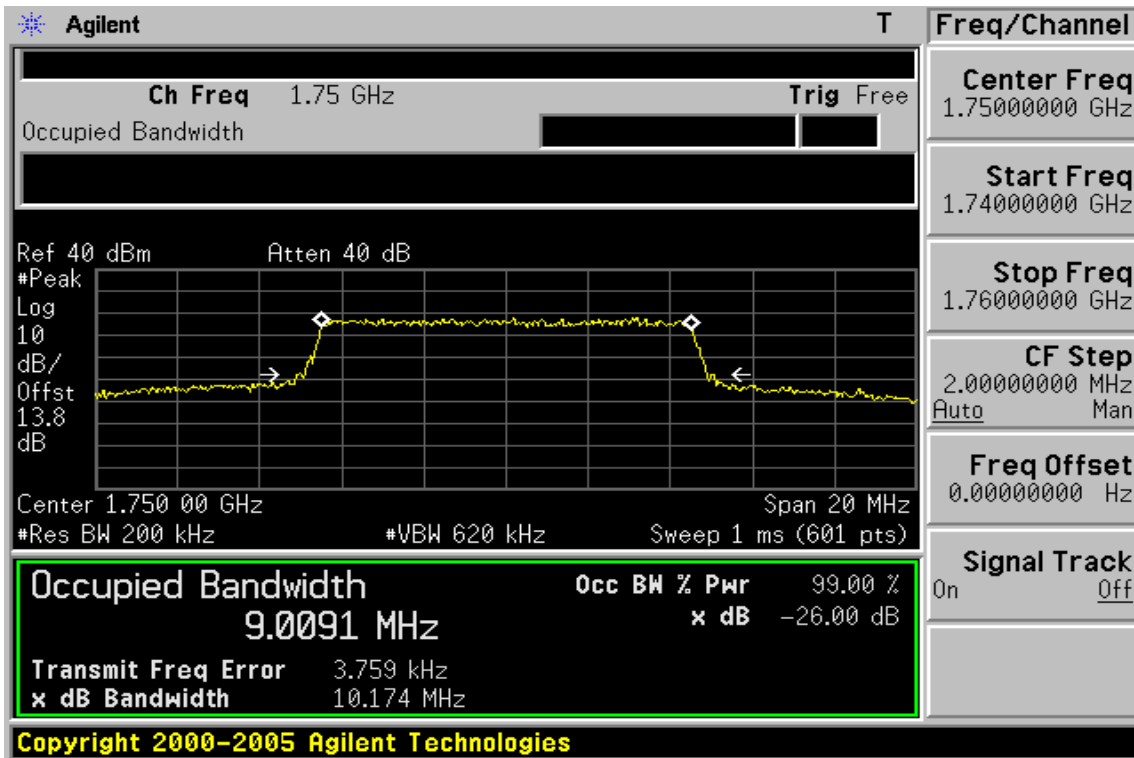

**Figure 9-22: 10MHz BW LTE-Band 4(16QAM RB Number: 50 Offset: 0) Channel Low**

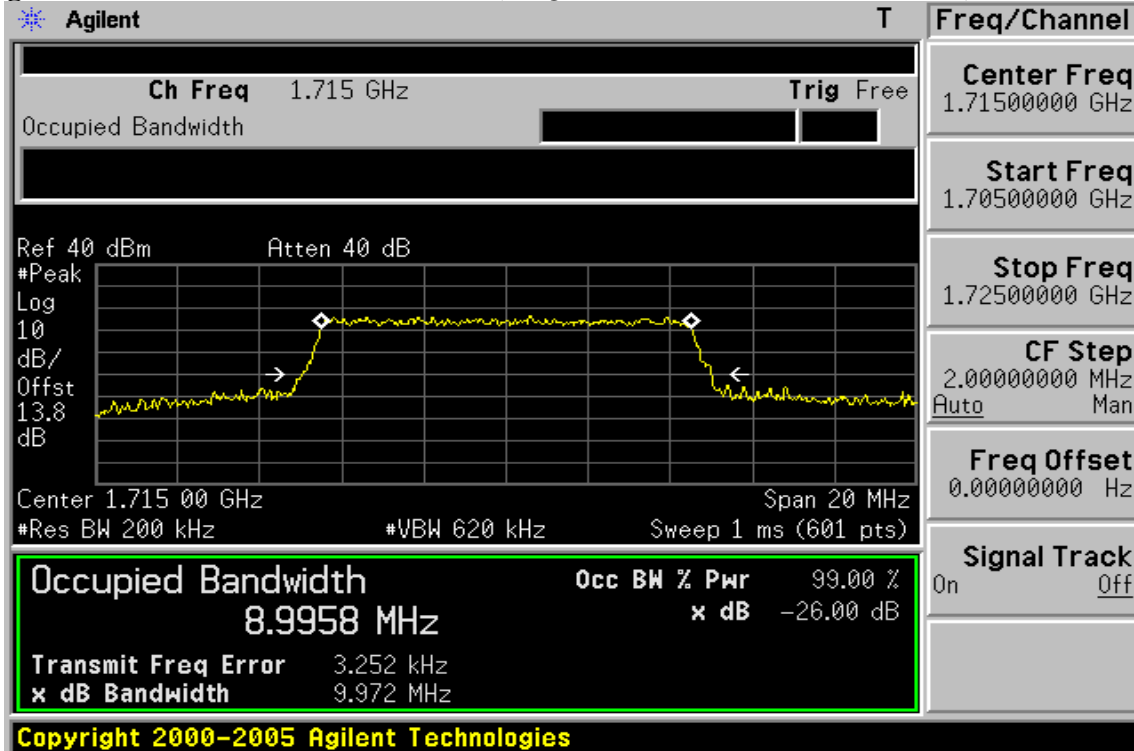

Unless otherwise stated the results shown in this test report refer only to the sample(s) tested and such sample(s) are retained for 90 days only.

除非另有說明，此報告結果僅對測試之樣品負責，同時此樣品僅保留90天。本報告未經本公司書面許可，不可部份複製。

This document is issued by the Company subject to its General Conditions of Service printed overleaf, available on request or accessible at [www.sgs.com/terms\\_and\\_conditions.htm](http://www.sgs.com/terms_and_conditions.htm) and, for electronic format documents, subject to Terms and Conditions for Electronic Documents at [www.sgs.com/terms\\_e-document.htm](http://www.sgs.com/terms_e-document.htm). Attention is drawn to the limitation of liability, indemnification and jurisdiction issues defined therein. Any holder of this document is advised that information contained hereon reflects the Company's findings at the time of its intervention only and within the limits of Client's instructions, if any. The Company's sole responsibility is to its Client and this document does not exonerate parties to a transaction from exercising all their rights and obligations under the transaction documents. This document cannot be reproduced except in full, without prior written approval of the Company. Any unauthorized alteration, forgery or falsification of the content or appearance of this document is unlawful and offenders may be prosecuted to the fullest extent of the law.

Figure 9-23: 10MHz BW LTE-Band 4(16QAM RB Number: 50 Offset: 0) Channel Mid

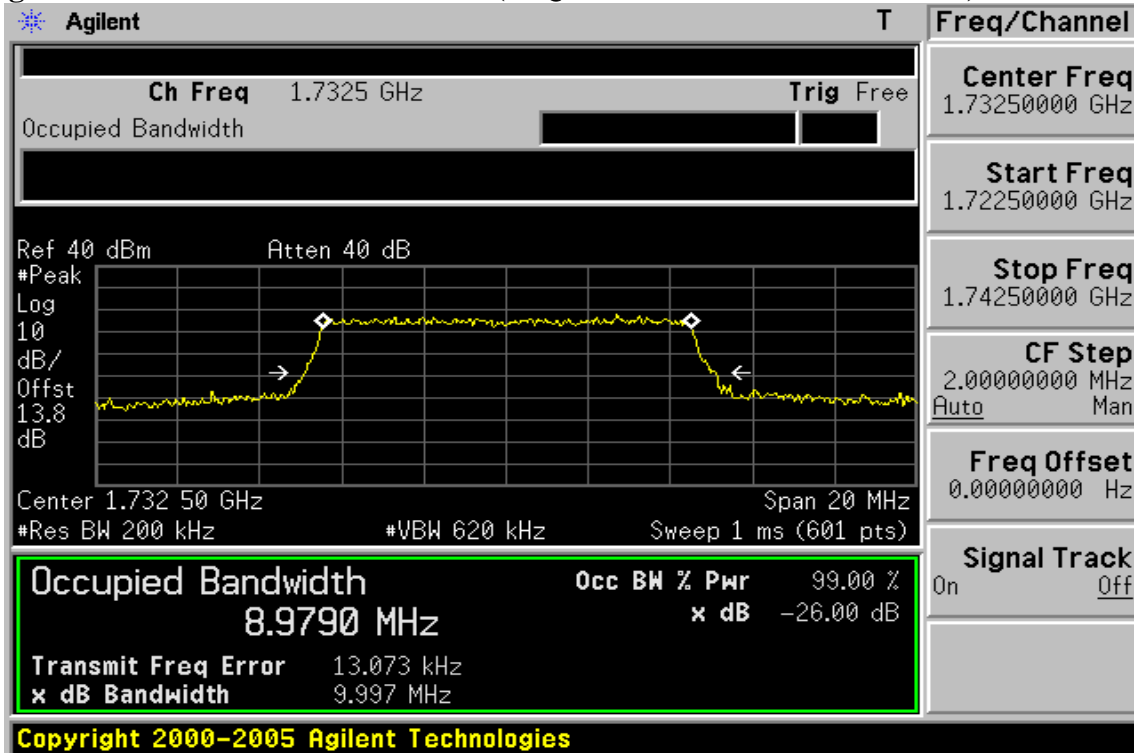
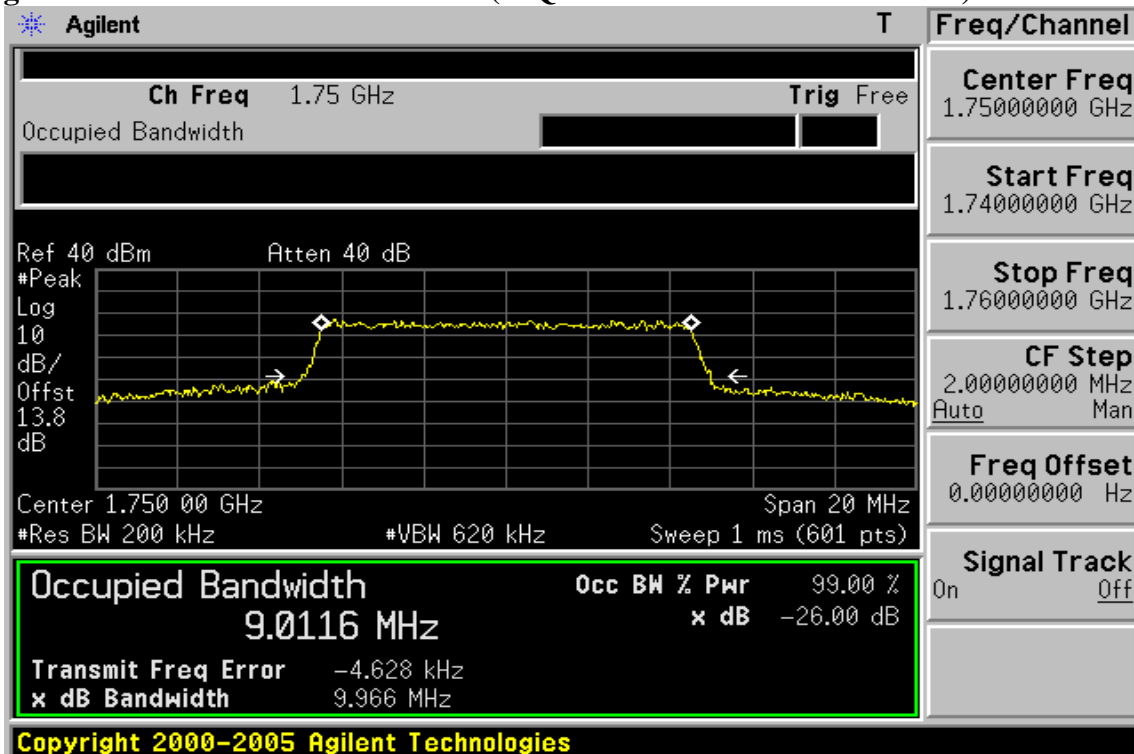

Figure 9-24: 10MHz BW LTE-Band 4(16QAM RB Number: 50 Offset: 0) Channel High



Unless otherwise stated the results shown in this test report refer only to the sample(s) tested and such sample(s) are retained for 90 days only.

除非另有說明，此報告結果僅對測試之樣品負責，同時此樣品僅保留90天。本報告未經本公司書面許可，不可部份複製。

This document is issued by the Company subject to its General Conditions of Service printed overleaf, available on request or accessible at [www.sgs.com/terms\\_and\\_conditions.htm](http://www.sgs.com/terms_and_conditions.htm) and, for electronic format documents, subject to Terms and Conditions for Electronic Documents at [www.sgs.com/terms\\_e-document.htm](http://www.sgs.com/terms_e-document.htm). Attention is drawn to the limitation of liability, indemnification and jurisdiction issues defined therein. Any holder of this document is advised that information contained hereon reflects the Company's findings at the time of its intervention only and within the limits of Client's instructions, if any. The Company's sole responsibility is to its Client and this document does not exonerate parties to a transaction from exercising all their rights and obligations under the transaction documents. This document cannot be reproduced except in full, without prior written approval of the Company. Any unauthorized alteration, forgery or falsification of the content or appearance of this document is unlawful and offenders may be prosecuted to the fullest extent of the law.

Figure 9-25: 15MHz BW LTE-Band 4(QPSK RB Number: 75 Offset: 0) Channel Low

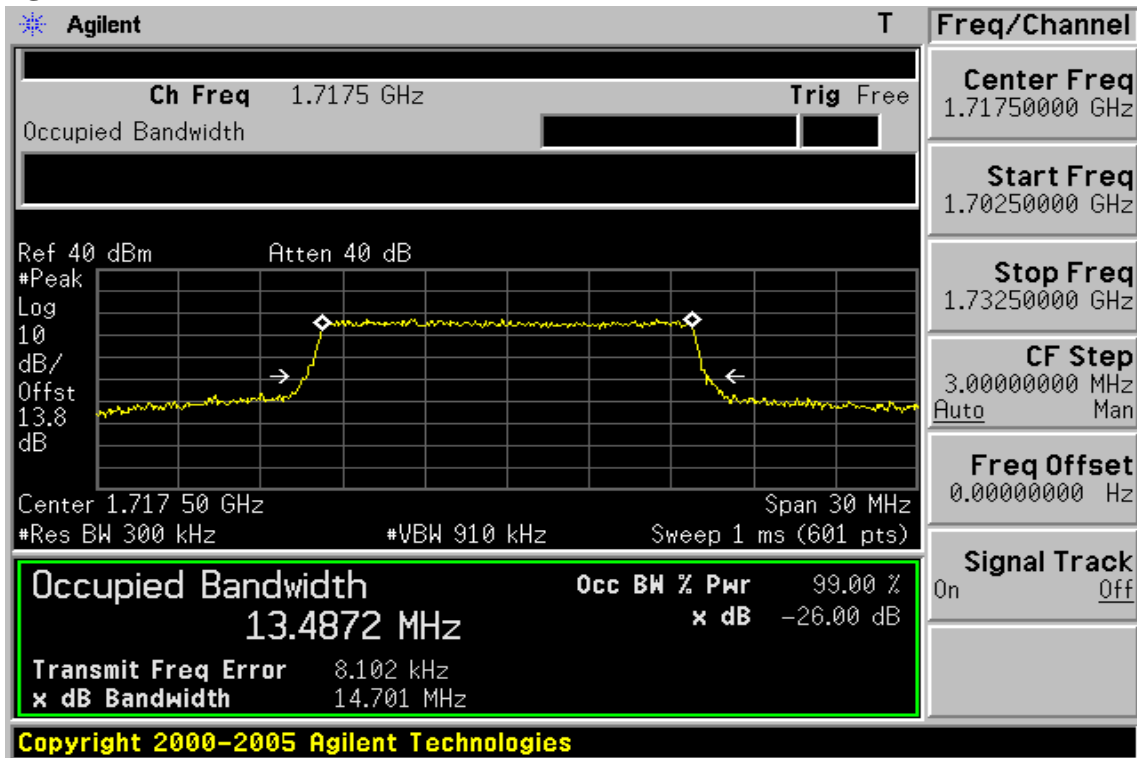
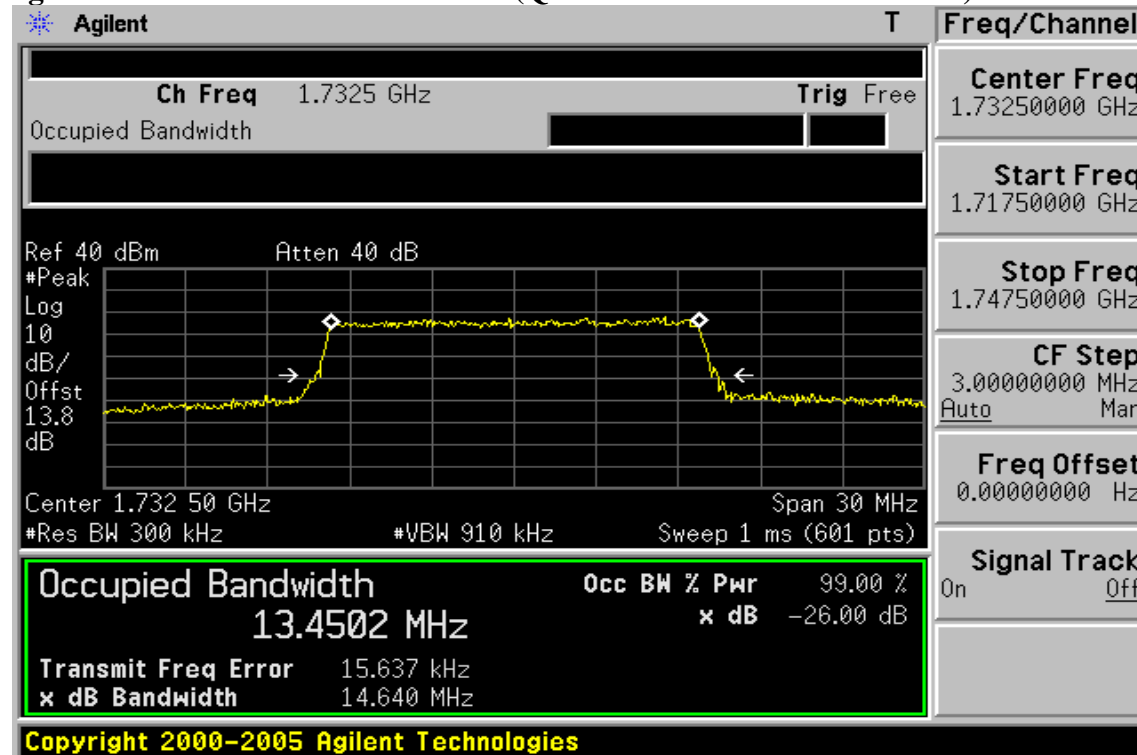

Figure 9-26: 15MHz BW LTE-Band 4(QPSK RB Number: 75 Offset: 0) Channel Mid



Unless otherwise stated the results shown in this test report refer only to the sample(s) tested and such sample(s) are retained for 90 days only.

除非另有說明，此報告結果僅對測試之樣品負責，同時此樣品僅保留90天。本報告未經本公司書面許可，不可部份複製。

This document is issued by the Company subject to its General Conditions of Service printed overleaf, available on request or accessible at [www.sgs.com/terms\\_and\\_conditions.htm](http://www.sgs.com/terms_and_conditions.htm) and, for electronic format documents, subject to Terms and Conditions for Electronic Documents at [www.sgs.com/terms\\_e-document.htm](http://www.sgs.com/terms_e-document.htm). Attention is drawn to the limitation of liability, indemnification and jurisdiction issues defined therein. Any holder of this document is advised that information contained hereon reflects the Company's findings at the time of its intervention only and within the limits of Client's instructions, if any. The Company's sole responsibility is to its Client and this document does not exonerate parties to a transaction from exercising all their rights and obligations under the transaction documents. This document cannot be reproduced except in full, without prior written approval of the Company. Any unauthorized alteration, forgery or falsification of the content or appearance of this document is unlawful and offenders may be prosecuted to the fullest extent of the law.

Figure 9-27: 15MHz BW LTE-Band 4(QPSK RB Number: 75 Offset: 0) Channel High

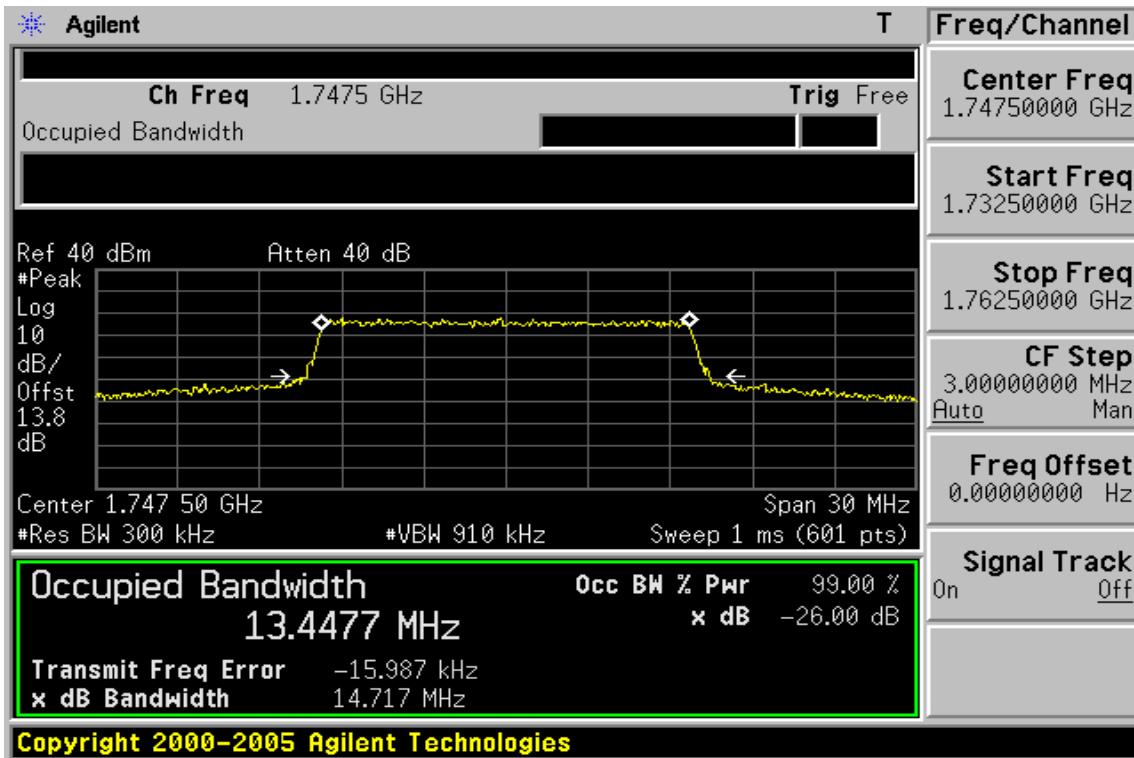
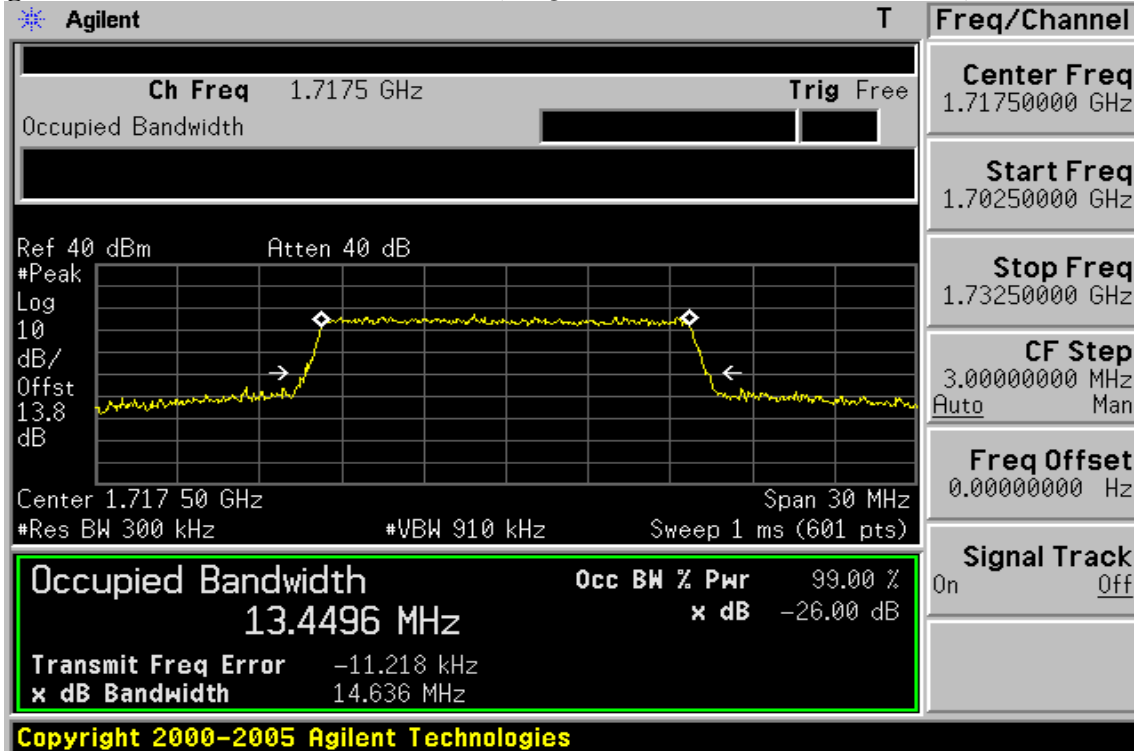

Figure 9-28: 15MHz BW LTE-Band 4(16QAM RB Number: 75 Offset: 0) Channel Low



Unless otherwise stated the results shown in this test report refer only to the sample(s) tested and such sample(s) are retained for 90 days only.

除非另有說明，此報告結果僅對測試之樣品負責，同時此樣品僅保留90天。本報告未經本公司書面許可，不可部份複製。

This document is issued by the Company subject to its General Conditions of Service printed overleaf, available on request or accessible at [www.sgs.com/terms\\_and\\_conditions.htm](http://www.sgs.com/terms_and_conditions.htm) and, for electronic format documents, subject to Terms and Conditions for Electronic Documents at [www.sgs.com/terms\\_e-document.htm](http://www.sgs.com/terms_e-document.htm). Attention is drawn to the limitation of liability, indemnification and jurisdiction issues defined therein. Any holder of this document is advised that information contained hereon reflects the Company's findings at the time of its intervention only and within the limits of Client's instructions, if any. The Company's sole responsibility is to its Client and this document does not exonerate parties to a transaction from exercising all their rights and obligations under the transaction documents. This document cannot be reproduced except in full, without prior written approval of the Company. Any unauthorized alteration, forgery or falsification of the content or appearance of this document is unlawful and offenders may be prosecuted to the fullest extent of the law.

Figure 9-29: 15MHz BW LTE-Band 4(16QAM RB Number: 75 Offset: 0) Channel Mid

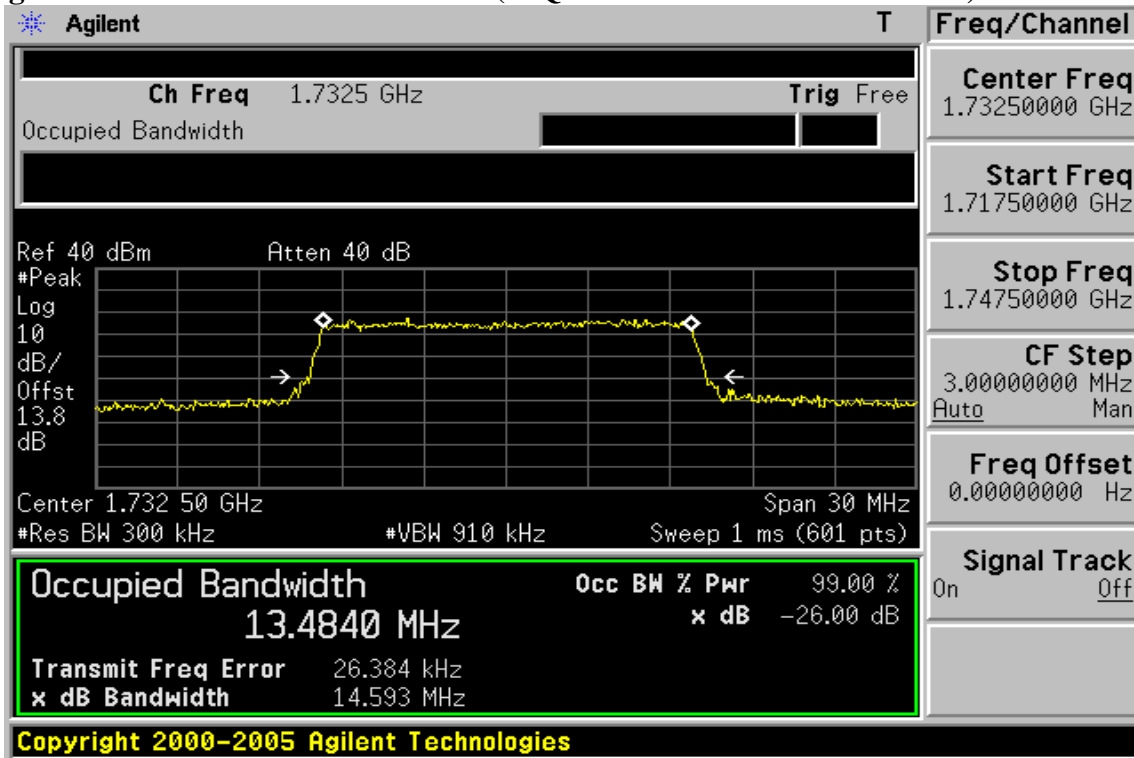
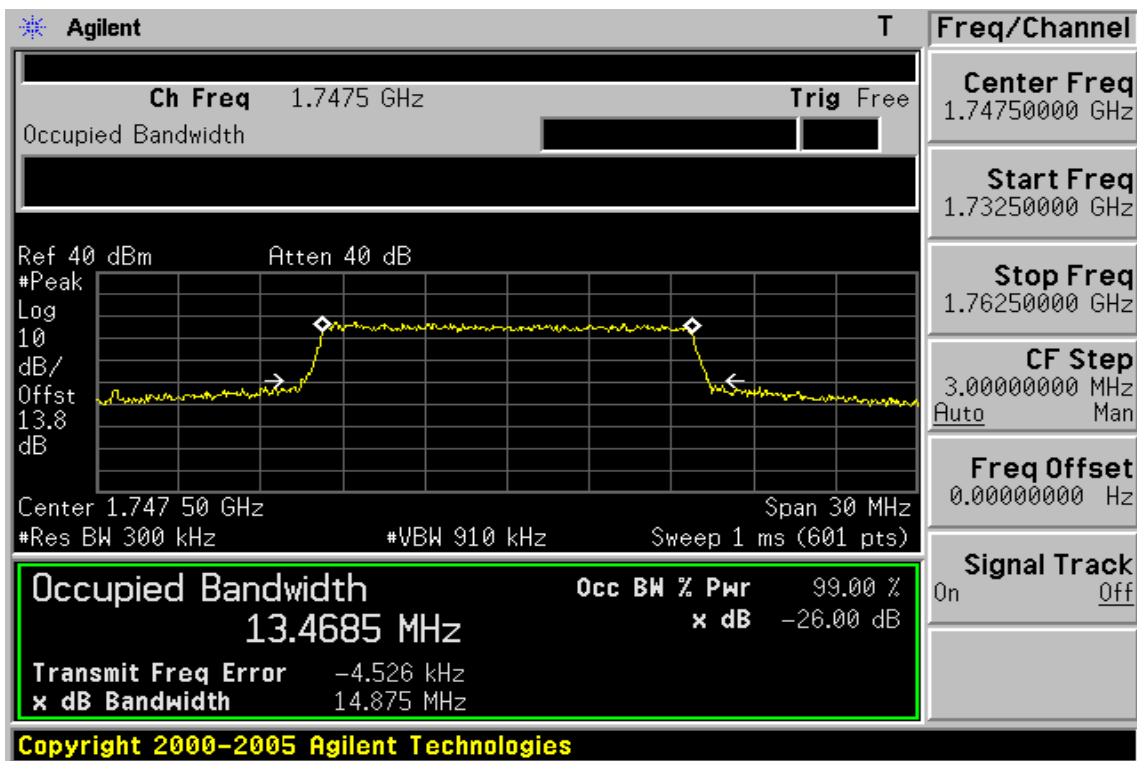

Figure 9-30: 15MHz BW LTE-Band 4(16QAM RB Number: 75 Offset: 0) Channel High



Unless otherwise stated the results shown in this test report refer only to the sample(s) tested and such sample(s) are retained for 90 days only.

除非另有說明，此報告結果僅對測試之樣品負責，同時此樣品僅保留90天。本報告未經本公司書面許可，不可部份複製。

This document is issued by the Company subject to its General Conditions of Service printed overleaf, available on request or accessible at [www.sgs.com/terms\\_and\\_conditions.htm](http://www.sgs.com/terms_and_conditions.htm) and, for electronic format documents, subject to Terms and Conditions for Electronic Documents at [www.sgs.com/terms\\_e-document.htm](http://www.sgs.com/terms_e-document.htm). Attention is drawn to the limitation of liability, indemnification and jurisdiction issues defined therein. Any holder of this document is advised that information contained hereon reflects the Company's findings at the time of its intervention only and within the limits of Client's instructions, if any. The Company's sole responsibility is to its Client and this document does not exonerate parties to a transaction from exercising all their rights and obligations under the transaction documents. This document cannot be reproduced except in full, without prior written approval of the Company. Any unauthorized alteration, forgery or falsification of the content or appearance of this document is unlawful and offenders may be prosecuted to the fullest extent of the law.

Figure 9-31: 20MHz BW LTE-Band 4(QPSK RB Number: 100 Offset: 0) Channel Low

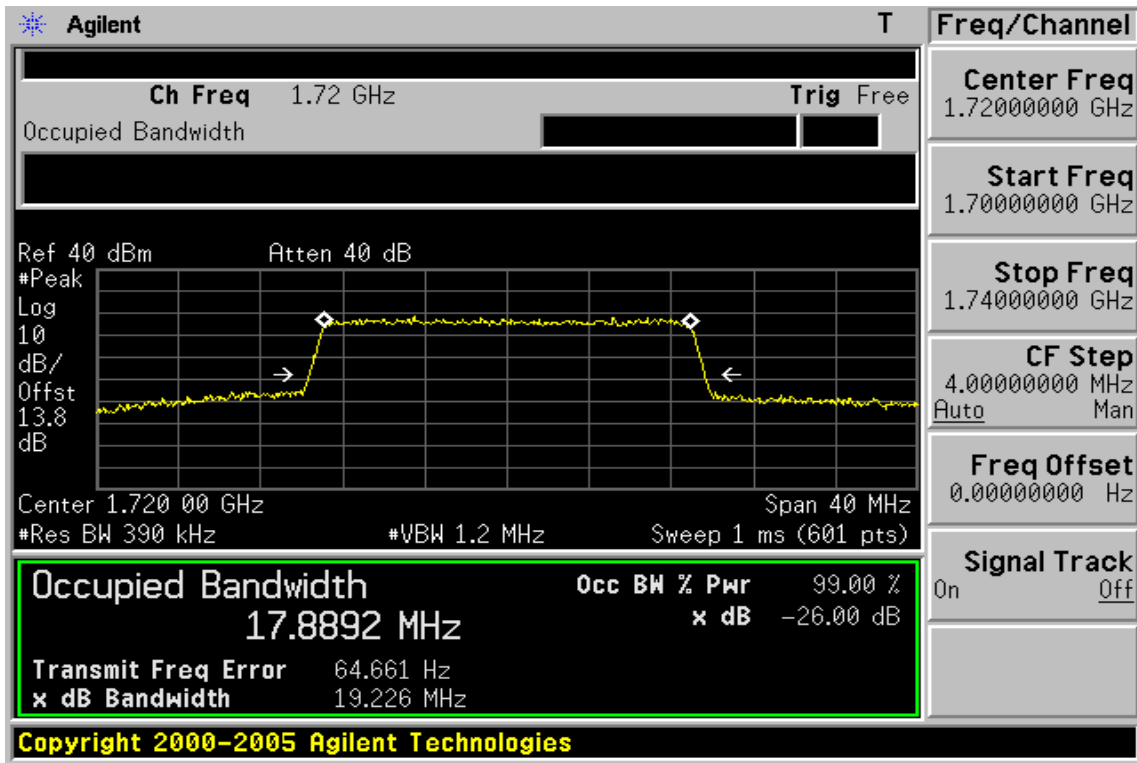
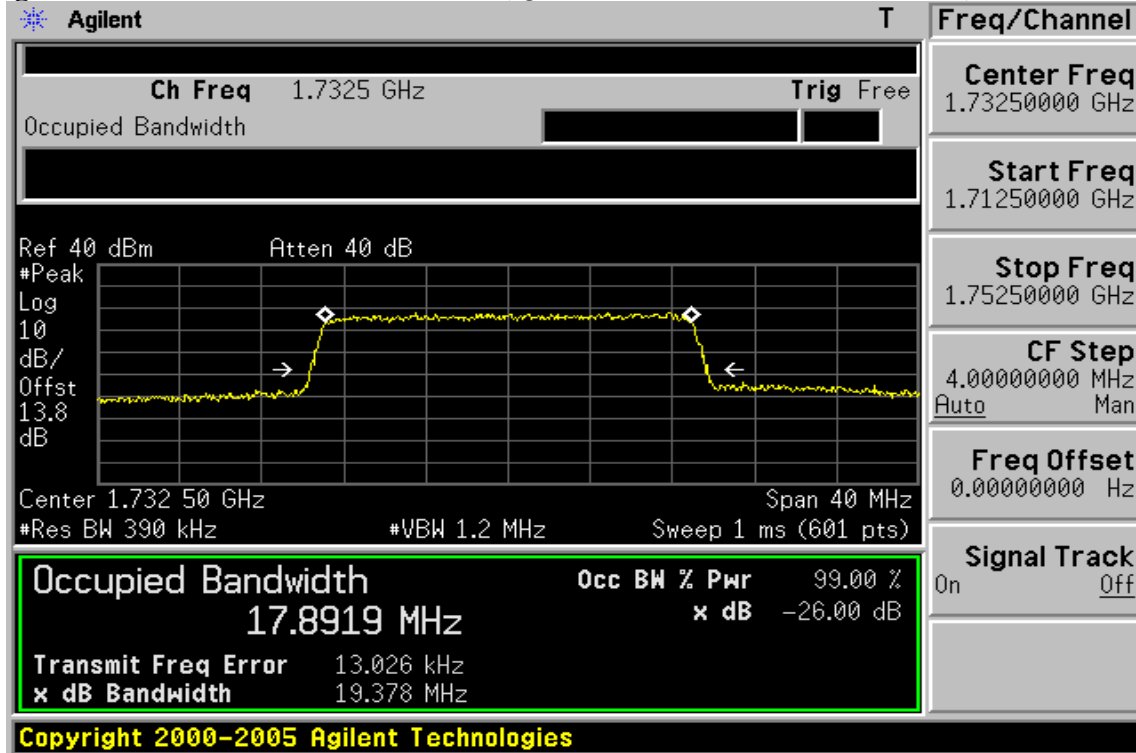

Figure 9-32: 20MHz BW LTE-Band 4(QPSK RB Number: 100 Offset: 0) Channel Mid



Unless otherwise stated the results shown in this test report refer only to the sample(s) tested and such sample(s) are retained for 90 days only.

除非另有說明，此報告結果僅對測試之樣品負責，同時此樣品僅保留90天。本報告未經本公司書面許可，不可部份複製。

This document is issued by the Company subject to its General Conditions of Service printed overleaf, available on request or accessible at [www.sgs.com/terms\\_and\\_conditions.htm](http://www.sgs.com/terms_and_conditions.htm) and, for electronic format documents, subject to Terms and Conditions for Electronic Documents at [www.sgs.com/terms\\_e-document.htm](http://www.sgs.com/terms_e-document.htm). Attention is drawn to the limitation of liability, indemnification and jurisdiction issues defined therein. Any holder of this document is advised that information contained hereon reflects the Company's findings at the time of its intervention only and within the limits of Client's instructions, if any. The Company's sole responsibility is to its Client and this document does not exonerate parties to a transaction from exercising all their rights and obligations under the transaction documents. This document cannot be reproduced except in full, without prior written approval of the Company. Any unauthorized alteration, forgery or falsification of the content or appearance of this document is unlawful and offenders may be prosecuted to the fullest extent of the law.

Figure 9-33: 20MHz BW LTE-Band 4(QPSK RB Number: 100 Offset: 0) Channel High

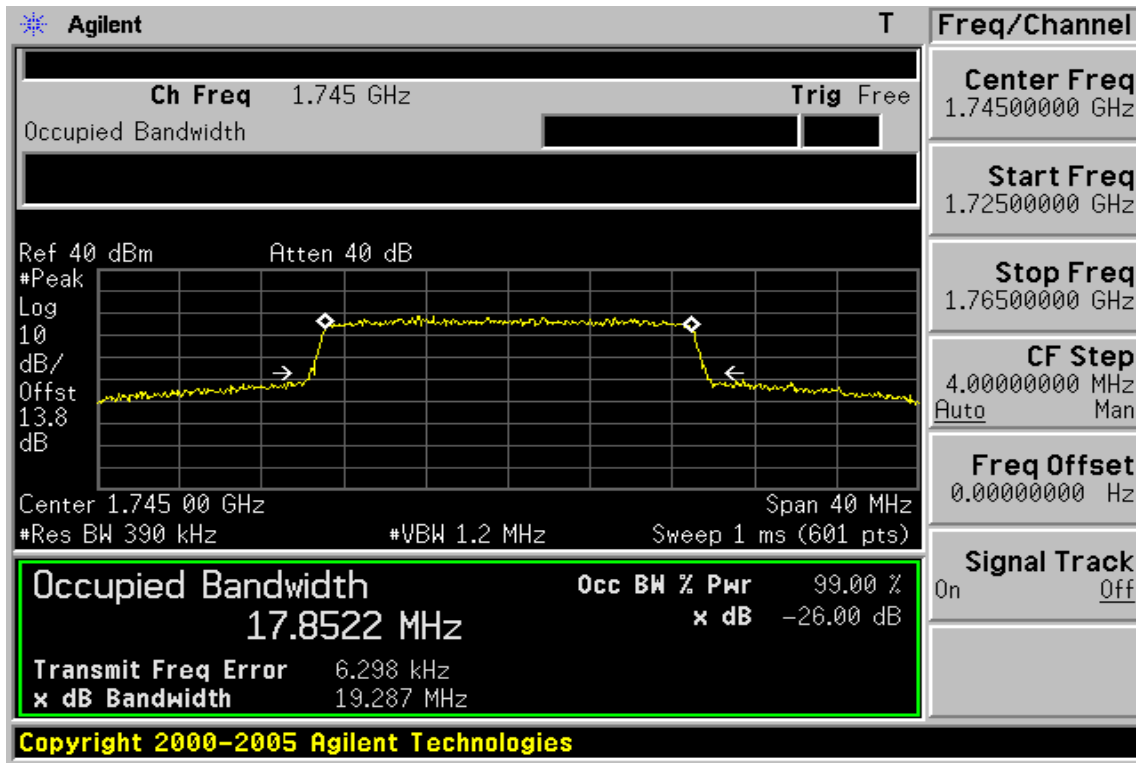
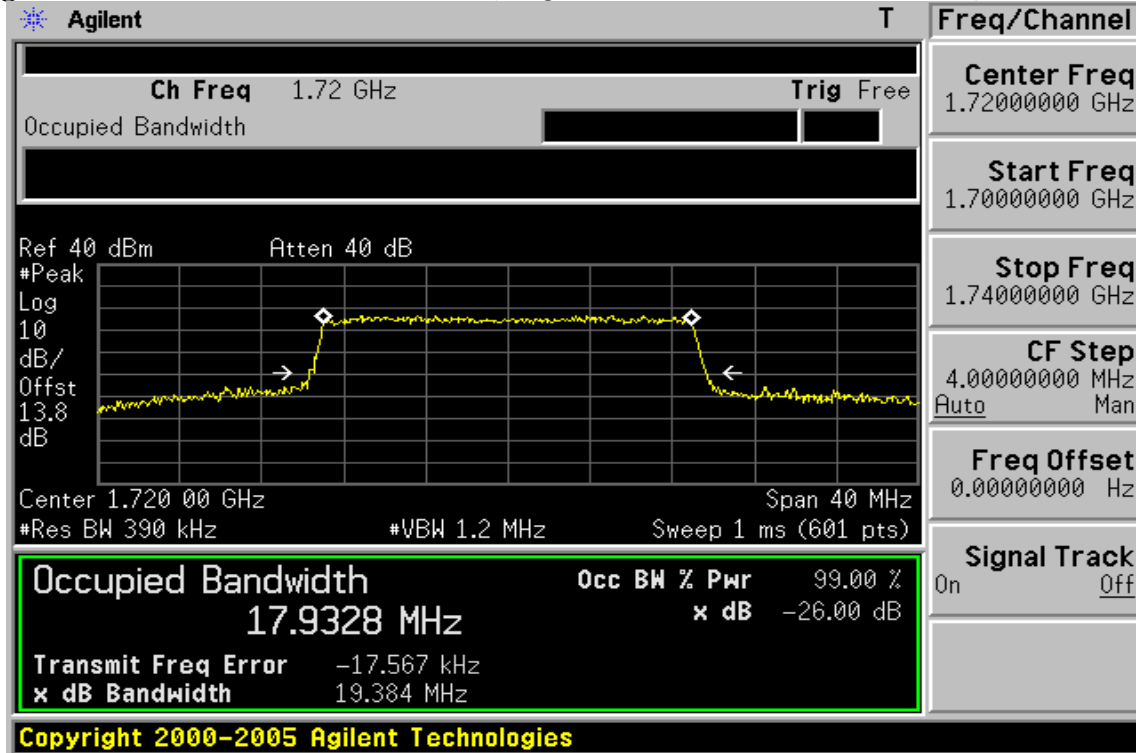

Figure 9-34: 20MHz BW LTE-Band 4(16QAM RB Number: 100 Offset: 0) Channel Low



Unless otherwise stated the results shown in this test report refer only to the sample(s) tested and such sample(s) are retained for 90 days only.

除非另有說明，此報告結果僅對測試之樣品負責，同時此樣品僅保留90天。本報告未經本公司書面許可，不可部份複製。

This document is issued by the Company subject to its General Conditions of Service printed overleaf, available on request or accessible at [www.sgs.com/terms\\_and\\_conditions.htm](http://www.sgs.com/terms_and_conditions.htm) and, for electronic format documents, subject to Terms and Conditions for Electronic Documents at [www.sgs.com/terms\\_e-document.htm](http://www.sgs.com/terms_e-document.htm). Attention is drawn to the limitation of liability, indemnification and jurisdiction issues defined therein. Any holder of this document is advised that information contained hereon reflects the Company's findings at the time of its intervention only and within the limits of Client's instructions, if any. The Company's sole responsibility is to its Client and this document does not exonerate parties to a transaction from exercising all their rights and obligations under the transaction documents. This document cannot be reproduced except in full, without prior written approval of the Company. Any unauthorized alteration, forgery or falsification of the content or appearance of this document is unlawful and offenders may be prosecuted to the fullest extent of the law.



Figure 9-35: 20MHz BW LTE-Band 4(16QAM RB Number: 100 Offset: 0) Channel Mid

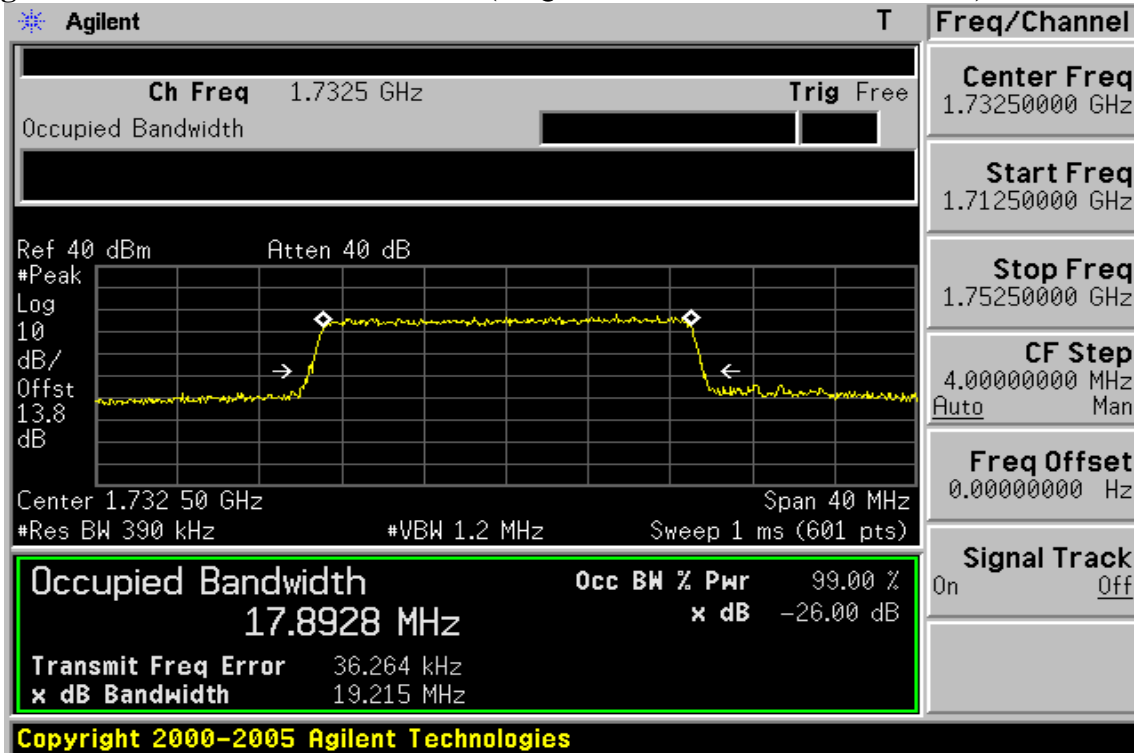
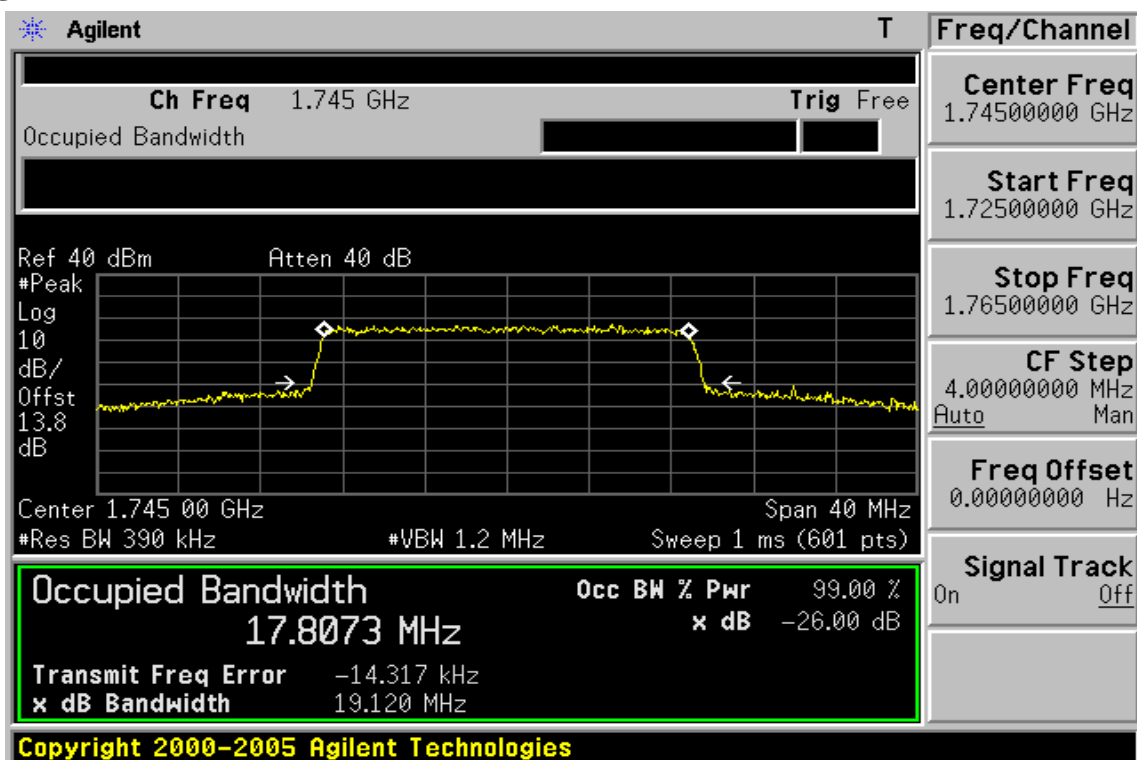

Figure 9-36: 20MHz BW LTE-Band 4(16QAM RB Number: 100 Offset: 0) Channel High



Unless otherwise stated the results shown in this test report refer only to the sample(s) tested and such sample(s) are retained for 90 days only.

除非另有說明，此報告結果僅對測試之樣品負責，同時此樣品僅保留90天。本報告未經本公司書面許可，不可部份複製。

This document is issued by the Company subject to its General Conditions of Service printed overleaf, available on request or accessible at [www.sgs.com/terms\\_and\\_conditions.htm](http://www.sgs.com/terms_and_conditions.htm) and, for electronic format documents, subject to Terms and Conditions for Electronic Documents at [www.sgs.com/terms\\_e-document.htm](http://www.sgs.com/terms_e-document.htm). Attention is drawn to the limitation of liability, indemnification and jurisdiction issues defined therein. Any holder of this document is advised that information contained hereon reflects the Company's findings at the time of its intervention only and within the limits of Client's instructions, if any. The Company's sole responsibility is to its Client and this document does not exonerate parties to a transaction from exercising all their rights and obligations under the transaction documents. This document cannot be reproduced except in full, without prior written approval of the Company. Any unauthorized alteration, forgery or falsification of the content or appearance of this document is unlawful and offenders may be prosecuted to the fullest extent of the law.

Figure 9-37: 5MHz BW LTE-Band 13(QPSK RB Number: 25 Offset: 0) Channel Low

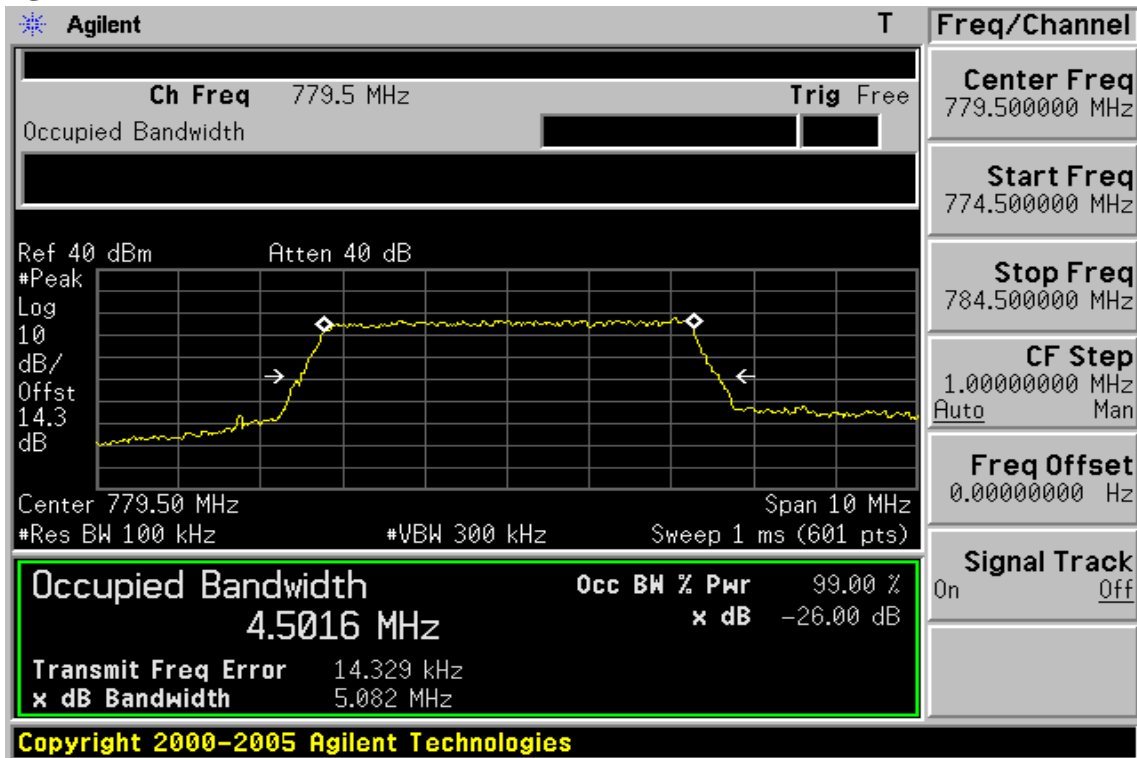
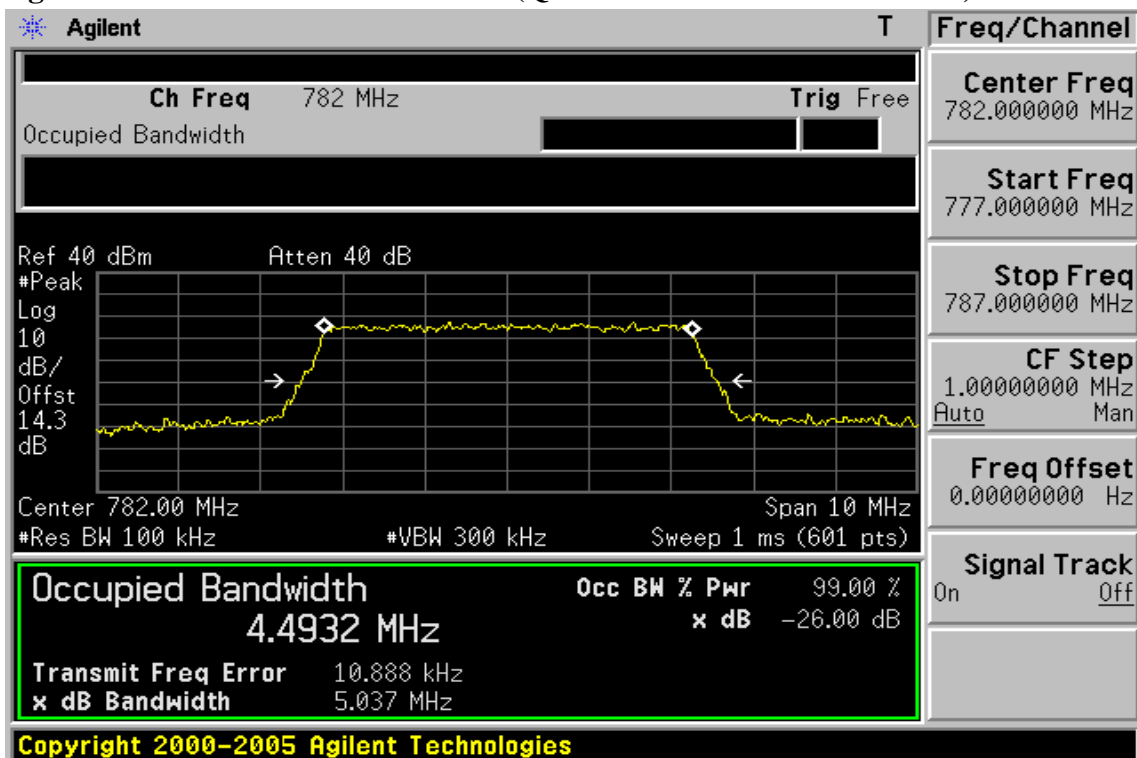

Figure 9-38: 5MHz BW LTE-Band 13(QPSK RB Number: 25 Offset: 0) Channel Mid



Unless otherwise stated the results shown in this test report refer only to the sample(s) tested and such sample(s) are retained for 90 days only.

除非另有說明，此報告結果僅對測試之樣品負責，同時此樣品僅保留90天。本報告未經本公司書面許可，不可部份複製。

This document is issued by the Company subject to its General Conditions of Service printed overleaf, available on request or accessible at [www.sgs.com/terms\\_and\\_conditions.htm](http://www.sgs.com/terms_and_conditions.htm) and, for electronic format documents, subject to Terms and Conditions for Electronic Documents at [www.sgs.com/terms\\_e-document.htm](http://www.sgs.com/terms_e-document.htm). Attention is drawn to the limitation of liability, indemnification and jurisdiction issues defined therein. Any holder of this document is advised that information contained hereon reflects the Company's findings at the time of its intervention only and within the limits of Client's instructions, if any. The Company's sole responsibility is to its Client and this document does not exonerate parties to a transaction from exercising all their rights and obligations under the transaction documents. This document cannot be reproduced except in full, without prior written approval of the Company. Any unauthorized alteration, forgery or falsification of the content or appearance of this document is unlawful and offenders may be prosecuted to the fullest extent of the law.

Figure 9-39: 5MHz BW LTE-Band 13(QPSK RB Number: 25 Offset: 0) Channel High

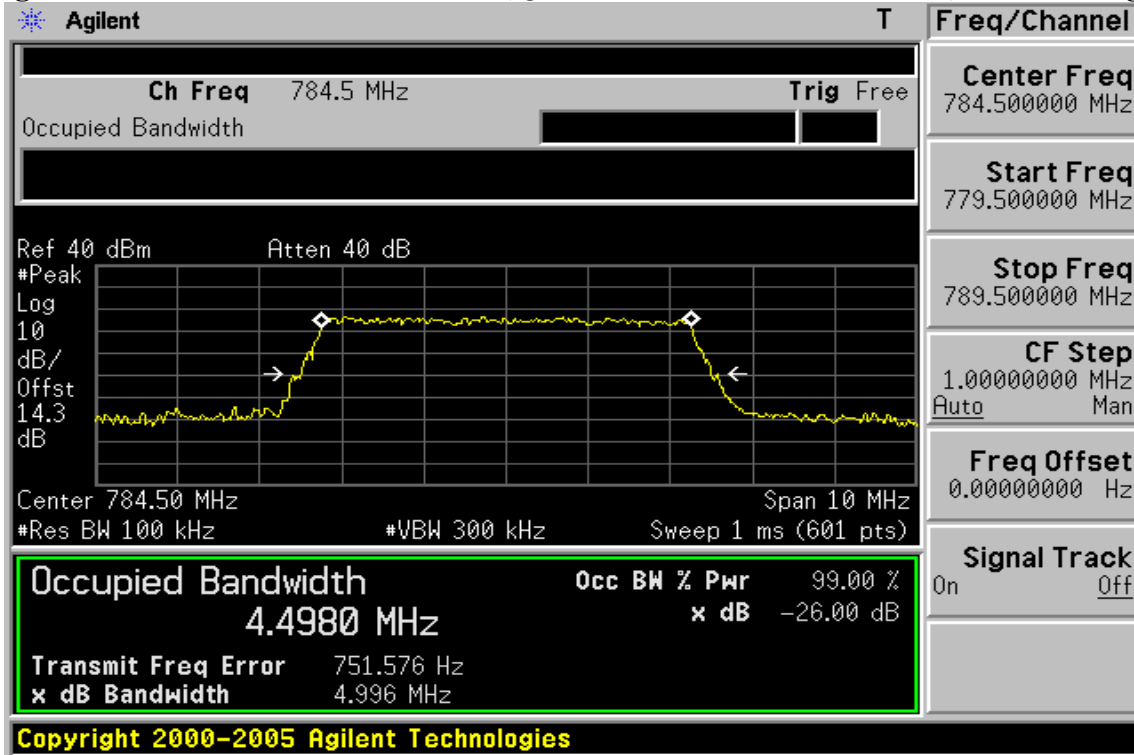
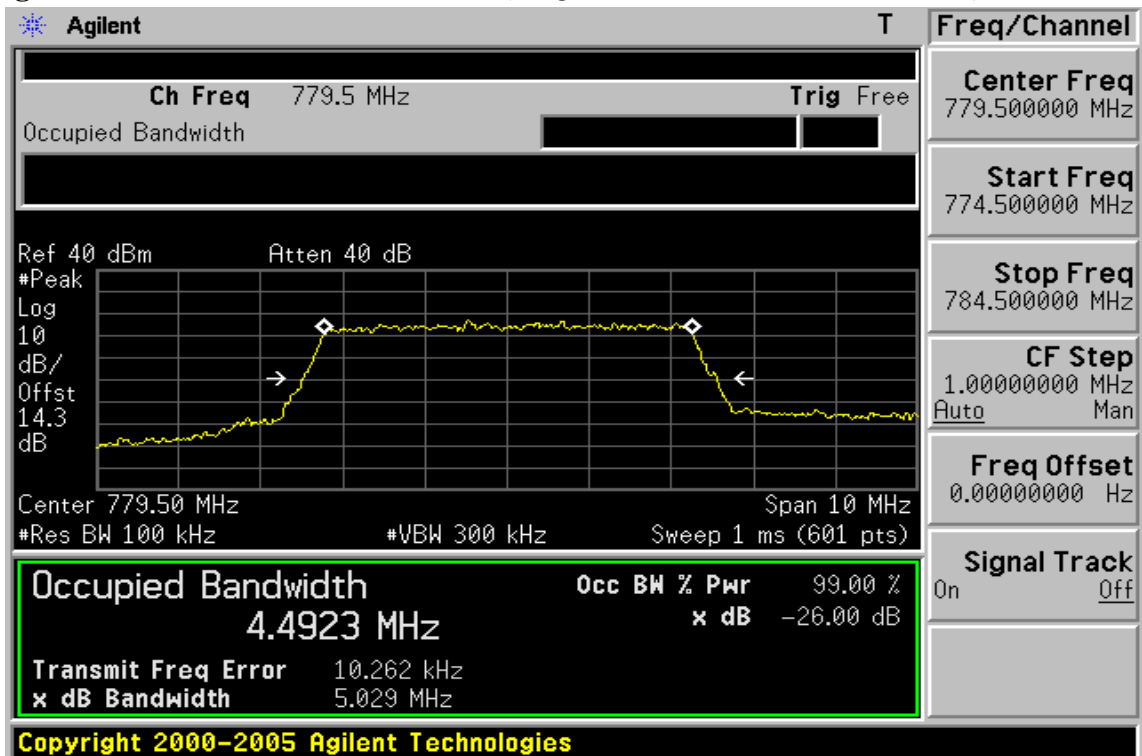

Figure 9-40: 5MHz BW LTE-Band 13(16QAM RB Number: 25 Offset: 0) Channel Low



Unless otherwise stated the results shown in this test report refer only to the sample(s) tested and such sample(s) are retained for 90 days only.

除非另有說明，此報告結果僅對測試之樣品負責，同時此樣品僅保留90天。本報告未經本公司書面許可，不可部份複製。

This document is issued by the Company subject to its General Conditions of Service printed overleaf, available on request or accessible at [www.sgs.com/terms\\_and\\_conditions.htm](http://www.sgs.com/terms_and_conditions.htm) and, for electronic format documents, subject to Terms and Conditions for Electronic Documents at [www.sgs.com/terms\\_e-document.htm](http://www.sgs.com/terms_e-document.htm). Attention is drawn to the limitation of liability, indemnification and jurisdiction issues defined therein. Any holder of this document is advised that information contained hereon reflects the Company's findings at the time of its intervention only and within the limits of Client's instructions, if any. The Company's sole responsibility is to its Client and this document does not exonerate parties to a transaction from exercising all their rights and obligations under the transaction documents. This document cannot be reproduced except in full, without prior written approval of the Company. Any unauthorized alteration, forgery or falsification of the content or appearance of this document is unlawful and offenders may be prosecuted to the fullest extent of the law.

Figure 9-41: 5MHz BW LTE-Band 13(16QAM RB Number: 25 Offset: 0) Channel Mid

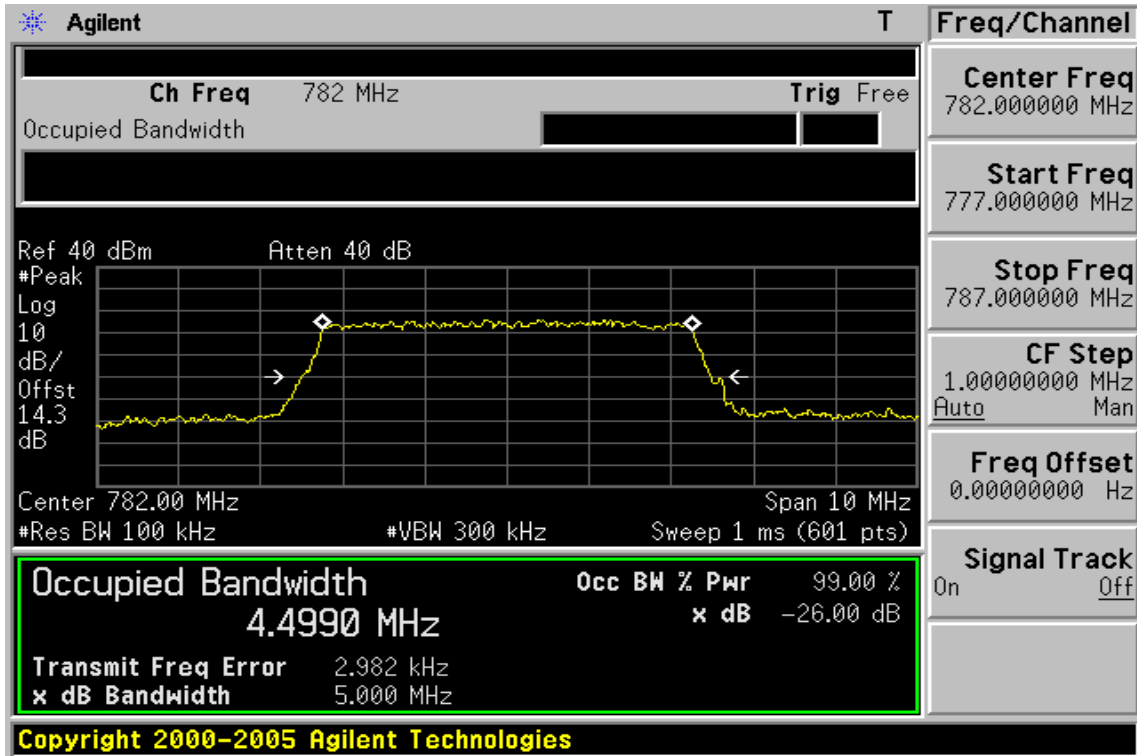
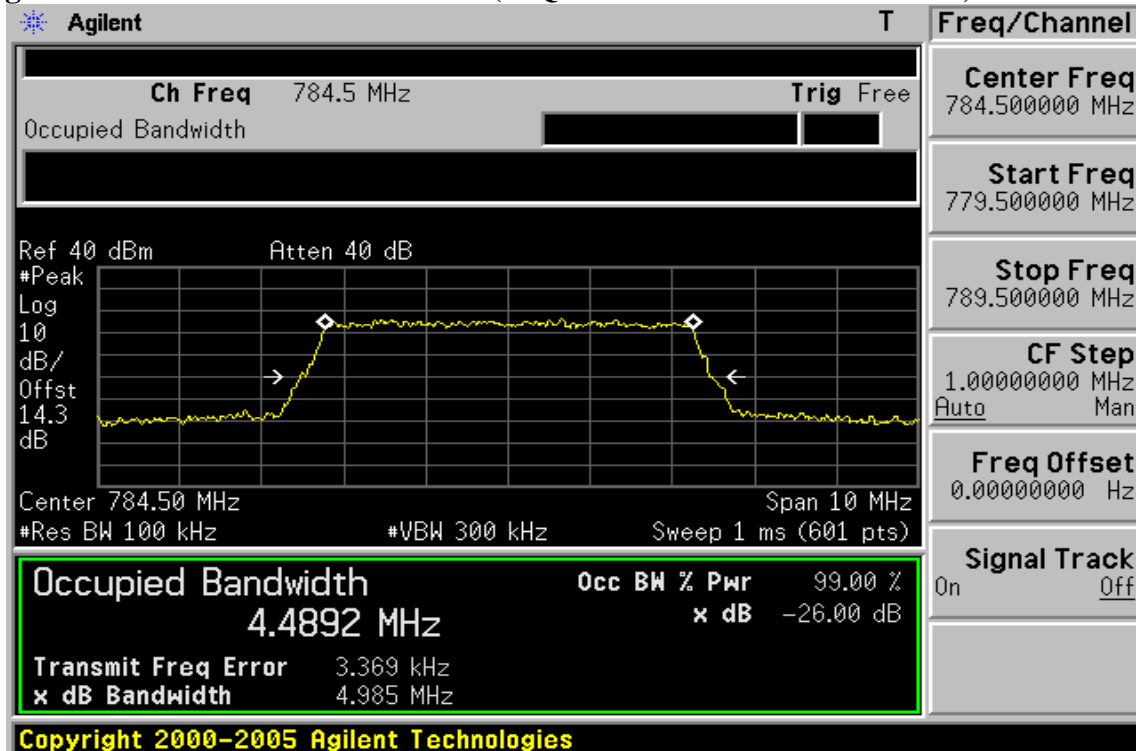

Figure 9-42: 5MHz BW LTE-Band 13(16QAM RB Number: 25 Offset: 0) Channel High



Unless otherwise stated the results shown in this test report refer only to the sample(s) tested and such sample(s) are retained for 90 days only.

除非另有說明，此報告結果僅對測試之樣品負責，同時此樣品僅保留90天。本報告未經本公司書面許可，不可部份複製。

This document is issued by the Company subject to its General Conditions of Service printed overleaf, available on request or accessible at [www.sgs.com/terms\\_and\\_conditions.htm](http://www.sgs.com/terms_and_conditions.htm) and, for electronic format documents, subject to Terms and Conditions for Electronic Documents at [www.sgs.com/terms\\_e-document.htm](http://www.sgs.com/terms_e-document.htm). Attention is drawn to the limitation of liability, indemnification and jurisdiction issues defined therein. Any holder of this document is advised that information contained hereon reflects the Company's findings at the time of its intervention only and within the limits of Client's instructions, if any. The Company's sole responsibility is to its Client and this document does not exonerate parties to a transaction from exercising all their rights and obligations under the transaction documents. This document cannot be reproduced except in full, without prior written approval of the Company. Any unauthorized alteration, forgery or falsification of the content or appearance of this document is unlawful and offenders may be prosecuted to the fullest extent of the law.

Figure 9-43: 10MHz BW LTE-Band 13(QPSK RB Number: 50 Offset: 0) Channel Mid

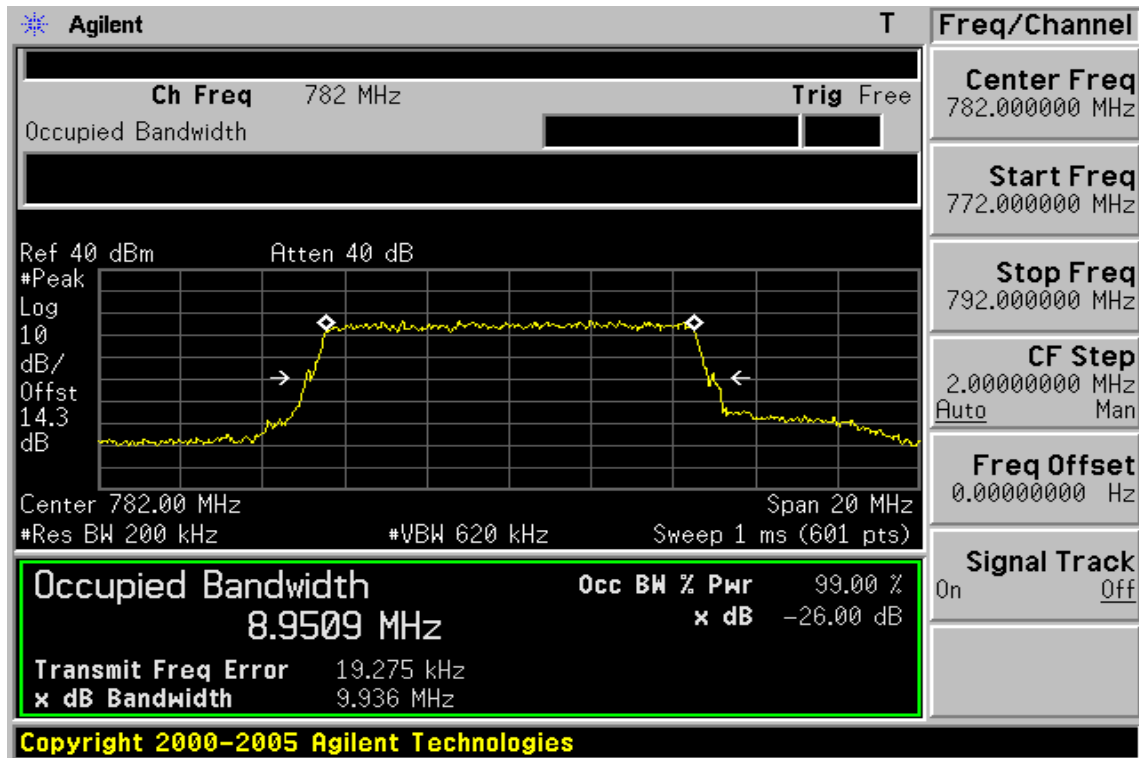
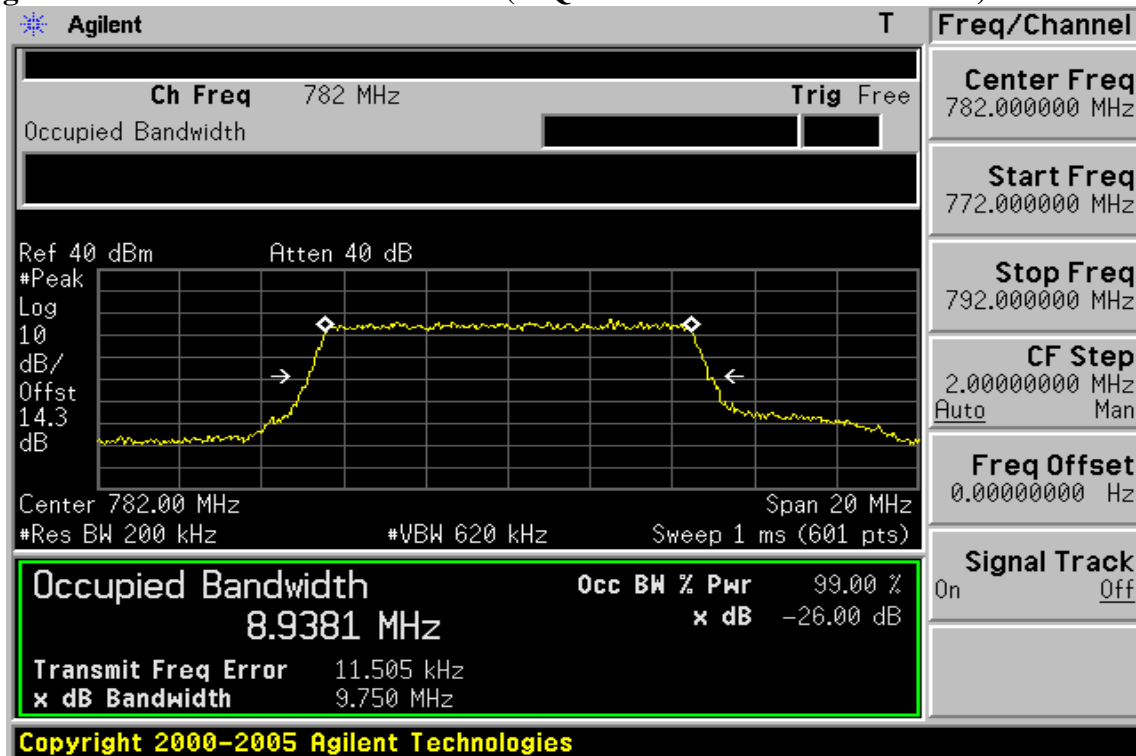

Figure 9-44: 10MHz BW LTE-Band 13(16QAM RB Number: 50 Offset: 0) Channel Mid



Unless otherwise stated the results shown in this test report refer only to the sample(s) tested and such sample(s) are retained for 90 days only.

除非另有說明，此報告結果僅對測試之樣品負責，同時此樣品僅保留90天。本報告未經本公司書面許可，不可部份複製。

This document is issued by the Company subject to its General Conditions of Service printed overleaf, available on request or accessible at [www.sgs.com/terms\\_and\\_conditions.htm](http://www.sgs.com/terms_and_conditions.htm) and, for electronic format documents, subject to Terms and Conditions for Electronic Documents at [www.sgs.com/terms\\_e-document.htm](http://www.sgs.com/terms_e-document.htm). Attention is drawn to the limitation of liability, indemnification and jurisdiction issues defined therein. Any holder of this document is advised that information contained hereon reflects the Company's findings at the time of its intervention only and within the limits of Client's instructions, if any. The Company's sole responsibility is to its Client and this document does not exonerate parties to a transaction from exercising all their rights and obligations under the transaction documents. This document cannot be reproduced except in full, without prior written approval of the Company. Any unauthorized alteration, forgery or falsification of the content or appearance of this document is unlawful and offenders may be prosecuted to the fullest extent of the law.

## 10. OUT OF BAND EMISSION AT ANTENNA TERMINALS

### 10.1. Standard Applicable:

According to FCC §2.1051.

#### Out-of-Band Emission

##### LTE Band4:

FCC §27.53(h) the magnitude of each spurious and harmonic emission that can be detected when the equipment is operated under the conditions specified in the instruction manual and/ or alignment procedure, shall not be less than  $43 + 10 \log$  (mean output power in watts) dBc below the mean power output outside a license's frequency block (-13dBm).

##### LTE Band 13:

FCC §27.53(c) (2)

(c) For operations in the 746–758 MHz band and the 776–788 MHz band, the power of any emission outside the licensee's frequency band(s) of operation shall be attenuated below the transmitter power (P) within the licensed band(s) of operation, measured in watts, in accordance with the following:

(2) On any frequency outside the 776– 788 MHz band, the power of any emission shall be attenuated outside the band below the transmitter power (P) by at least  $43 + 10 \log (P)$  dB (-13dBm)

##### 100KHz Bandedge:

FCC §27.53(c) (5)

##### LTE Band 13:

Compliance with the provisions, §27.53(c) (2) of this section is based on the use of measurement instrumentation employing a resolution bandwidth of 100 kHz or greater. However, in the 100 kHz bands immediately outside and adjacent to the frequency block, a resolution bandwidth of at least 30 kHz may be employed

##### LTE Band4:

Compliance with this provision is based on the use of measurement instrumentation employing a resolution bandwidth of 1 megahertz or greater. However, in the 1 megahertz bands immediately outside and adjacent to the licensee's frequency block, a resolution bandwidth of at least one percent of the emission bandwidth of the fundamental emission of the transmitter may be employed. The emission bandwidth is defined as the width of the signal between two points, one below the carrier center frequency and one above the carrier center frequency, outside of which all emissions are attenuated at least 26 dB below the transmitter power.

Unless otherwise stated the results shown in this test report refer only to the sample(s) tested and such sample(s) are retained for 90 days only.

除非另有說明，此報告結果僅對測試之樣品負責，同時此樣品僅保留90天。本報告未經本公司書面許可，不可部份複製。

This document is issued by the Company subject to its General Conditions of Service printed overleaf, available on request or accessible at [www.sgs.com/terms\\_and\\_conditions.htm](http://www.sgs.com/terms_and_conditions.htm) and, for electronic format documents, subject to Terms and Conditions for Electronic Documents at [www.sgs.com/terms\\_e-document.htm](http://www.sgs.com/terms_e-document.htm). Attention is drawn to the limitation of liability, indemnification and jurisdiction issues defined therein. Any holder of this document is advised that information contained hereon reflects the Company's findings at the time of its intervention only and within the limits of Client's instructions, if any. The Company's sole responsibility is to its Client and this document does not exonerate parties to a transaction from exercising all their rights and obligations under the transaction documents. This document cannot be reproduced except in full, without prior written approval of the Company. Any unauthorized alteration, forgery or falsification of the content or appearance of this document is unlawful and offenders may be prosecuted to the fullest extent of the law.

**10.2. Test SET-UP:**

**Out of band emission & Bandedge**

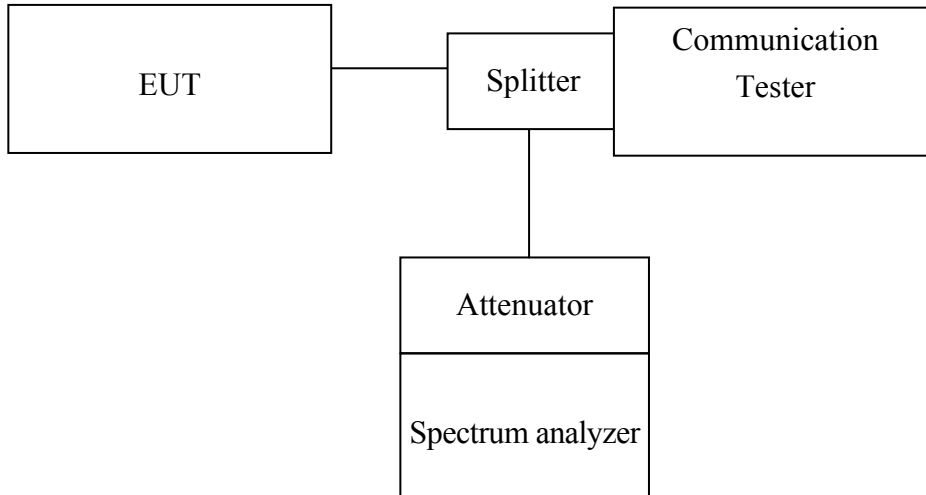

Unless otherwise stated the results shown in this test report refer only to the sample(s) tested and such sample(s) are retained for 90 days only.

除非另有說明，此報告結果僅對測試之樣品負責，同時此樣品僅保留90天。本報告未經本公司書面許可，不可部份複製。

This document is issued by the Company subject to its General Conditions of Service printed overleaf, available on request or accessible at [www.sgs.com/terms\\_and\\_conditions.htm](http://www.sgs.com/terms_and_conditions.htm) and, for electronic format documents, subject to Terms and Conditions for Electronic Documents at [www.sgs.com/terms\\_e-document.htm](http://www.sgs.com/terms_e-document.htm). Attention is drawn to the limitation of liability, indemnification and jurisdiction issues defined therein. Any holder of this document is advised that information contained hereon reflects the Company's findings at the time of its intervention only and within the limits of Client's instructions, if any. The Company's sole responsibility is to its Client and this document does not exonerate parties to a transaction from exercising all their rights and obligations under the transaction documents. This document cannot be reproduced except in full, without prior written approval of the Company. Any unauthorized alteration, forgery or falsification of the content or appearance of this document is unlawful and offenders may be prosecuted to the fullest extent of the law.

### 10.3. Measurement Procedure:

#### Out of Band Emission:

The RF output of the transceiver was connected to a spectrum analyzer through appropriate attenuation. The resolution bandwidth of the spectrum analyzer was set at 1MHz, sufficient scans were taken to show the out of band Emissions if any up to 10th harmonic.

1. To connect Antenna Port of EUT to Spectrum.
2. Set RBW = 1MHz & VBW = 1MHz on Spectrum (LTE Band 4), and RBW= 100kHz & VBW = 100kHz on Spectrum (LTE Band 13).
3. Set Line = -13dBm as the limit line
4. Sweep the frequency to determine spurious emission as seen on spectrum from span of 30 to 1G, 1G to 2.5G, 2.5G to 7.5G, 7.5G to 10G, 10G to 15G and 15G to 20GHz
5. Via Software, combine 6 spans of frequency range into one plot
6. Repeat the measurement on other default test channels

#### Band Edge Requirements:

1. To connect Antenna Port of EUT to Spectrum.
2. Set Span enough to capture entire signal of emission Bandwidth of UE, RBW = 1MHz & VBW = 1MHz on Spectrum (LTE Band 4), and RBW= 100kHz & VBW = 100kHz on Spectrum (LTE Band 13).
3. Marker the point of signal 1MHz immediately outside of edge of frequency band of test channel (LTE Band 13), Marker the point of signal 100KHz immediately outside of edge of frequency band of test channel (LTE Band 4)
4. Set Line = -13dBm as the limit line
5. Repeat the measurement on other default test channels

### 10.4. Measurement Equipment Used:

Refer to section 2.4 in this report

Band Rejecter is not used; the occurrence of the spike on plot shows the signal of the fundamental emission.

Unless otherwise stated the results shown in this test report refer only to the sample(s) tested and such sample(s) are retained for 90 days only.

除非另有說明，此報告結果僅對測試之樣品負責，同時此樣品僅保留90天。本報告未經本公司書面許可，不可部份複製。

This document is issued by the Company subject to its General Conditions of Service printed overleaf, available on request or accessible at [www.sgs.com/terms\\_and\\_conditions.htm](http://www.sgs.com/terms_and_conditions.htm) and, for electronic format documents, subject to Terms and Conditions for Electronic Documents at [www.sgs.com/terms\\_e-document.htm](http://www.sgs.com/terms_e-document.htm). Attention is drawn to the limitation of liability, indemnification and jurisdiction issues defined therein. Any holder of this document is advised that information contained hereon reflects the Company's findings at the time of its intervention only and within the limits of Client's instructions, if any. The Company's sole responsibility is to its Client and this document does not exonerate parties to a transaction from exercising all their rights and obligations under the transaction documents. This document cannot be reproduced except in full, without prior written approval of the Company. Any unauthorized alteration, forgery or falsification of the content or appearance of this document is unlawful and offenders may be prosecuted to the fullest extent of the law.



10.5. Measurement Result:

Figure 10-1: Out of Band emission at antenna terminals–1.4MHz BW LTE-Band 4 (QPSK RB Number: 1 Offset: 0) Channel Lowest

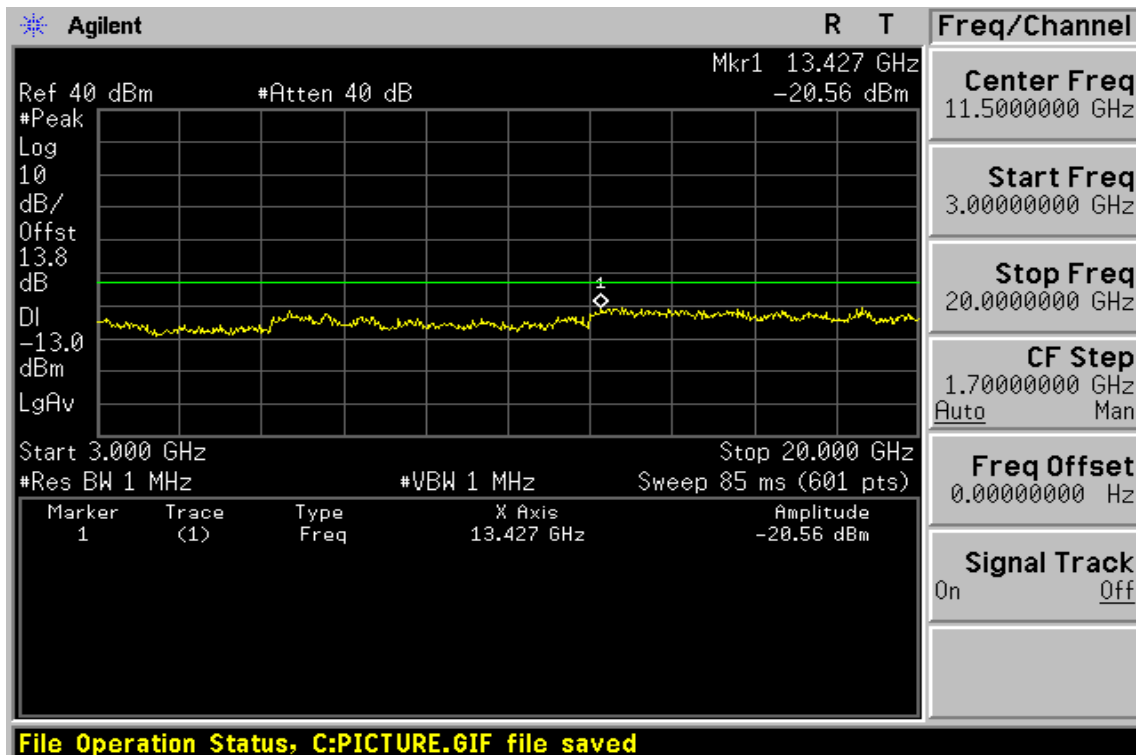
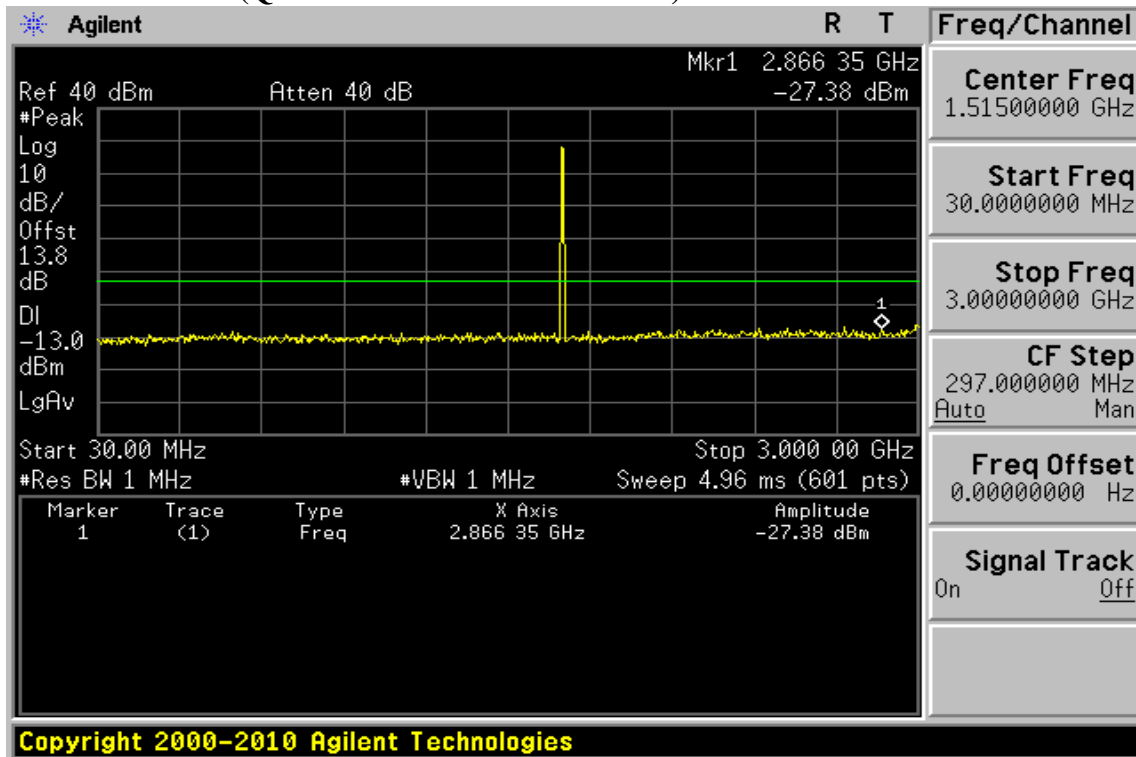

Unless otherwise stated the results shown in this test report refer only to the sample(s) tested and such sample(s) are retained for 90 days only.

除非另有說明，此報告結果僅對測試之樣品負責，同時此樣品僅保留90天。本報告未經本公司書面許可，不可部份複製。

This document is issued by the Company subject to its General Conditions of Service printed overleaf, available on request or accessible at [www.sgs.com/terms\\_and\\_conditions.htm](http://www.sgs.com/terms_and_conditions.htm) and, for electronic format documents, subject to Terms and Conditions for Electronic Documents at [www.sgs.com/terms\\_e-document.htm](http://www.sgs.com/terms_e-document.htm). Attention is drawn to the limitation of liability, indemnification and jurisdiction issues defined therein. Any holder of this document is advised that information contained hereon reflects the Company's findings at the time of its intervention only and within the limits of Client's instructions, if any. The Company's sole responsibility is to its Client and this document does not exonerate parties to a transaction from exercising all their rights and obligations under the transaction documents. This document cannot be reproduced except in full, without prior written approval of the Company. Any unauthorized alteration, forgery or falsification of the content or appearance of this document is unlawful and offenders may be prosecuted to the fullest extent of the law.

**Figure 10-2: Out of Band emission at antenna terminals –1.4MHz BW LTE-Band 4 (QPSK RB Number: 1 Offset: 0) Channel Mid**

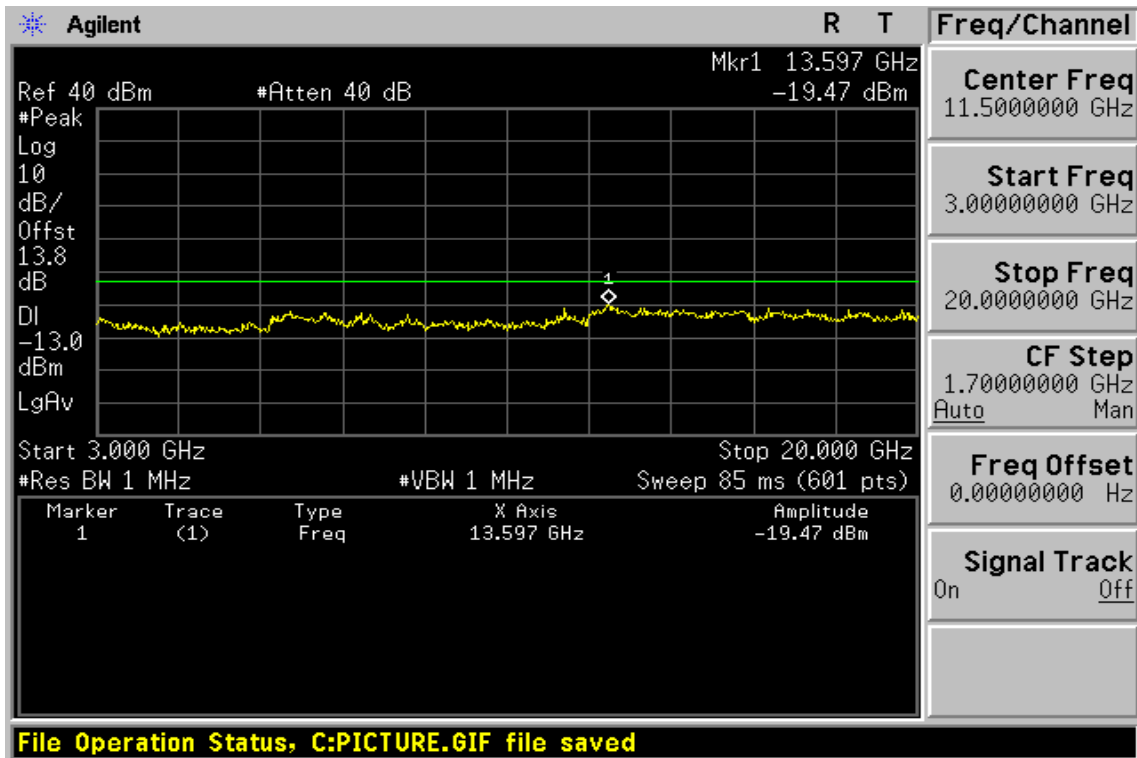
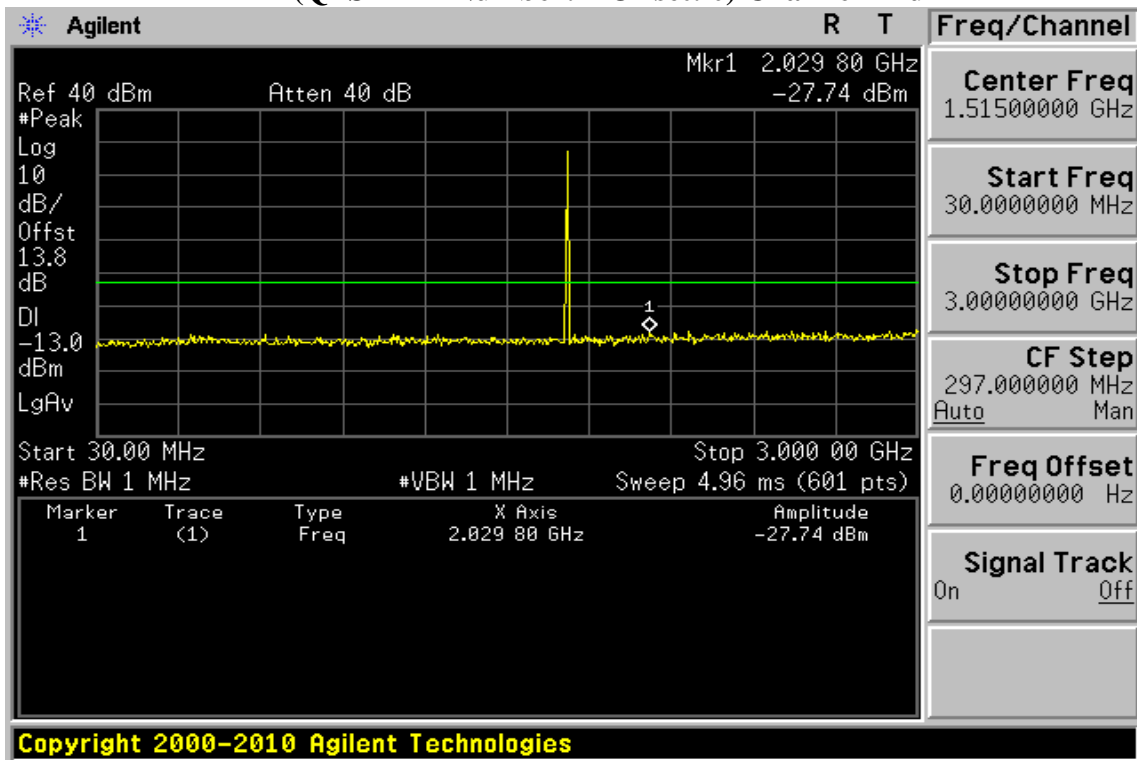

Unless otherwise stated the results shown in this test report refer only to the sample(s) tested and such sample(s) are retained for 90 days only.

除非另有說明，此報告結果僅對測試之樣品負責，同時此樣品僅保留90天。本報告未經本公司書面許可，不可部份複製。

This document is issued by the Company subject to its General Conditions of Service printed overleaf, available on request or accessible at [www.sgs.com/terms\\_and\\_conditions.htm](http://www.sgs.com/terms_and_conditions.htm) and, for electronic format documents, subject to Terms and Conditions for Electronic Documents at [www.sgs.com/terms\\_e-document.htm](http://www.sgs.com/terms_e-document.htm). Attention is drawn to the limitation of liability, indemnification and jurisdiction issues defined therein. Any holder of this document is advised that information contained hereon reflects the Company's findings at the time of its intervention only and within the limits of Client's instructions, if any. The Company's sole responsibility is to its Client and this document does not exonerate parties to a transaction from exercising all their rights and obligations under the transaction documents. This document cannot be reproduced except in full, without prior written approval of the Company. Any unauthorized alteration, forgery or falsification of the content or appearance of this document is unlawful and offenders may be prosecuted to the fullest extent of the law.

**Figure 10-3: Out of Band emission at antenna terminals–1.4MHz BW LTE-Band 4 (QPSK RB Number: 1 Offset: 0) Channel Highest**

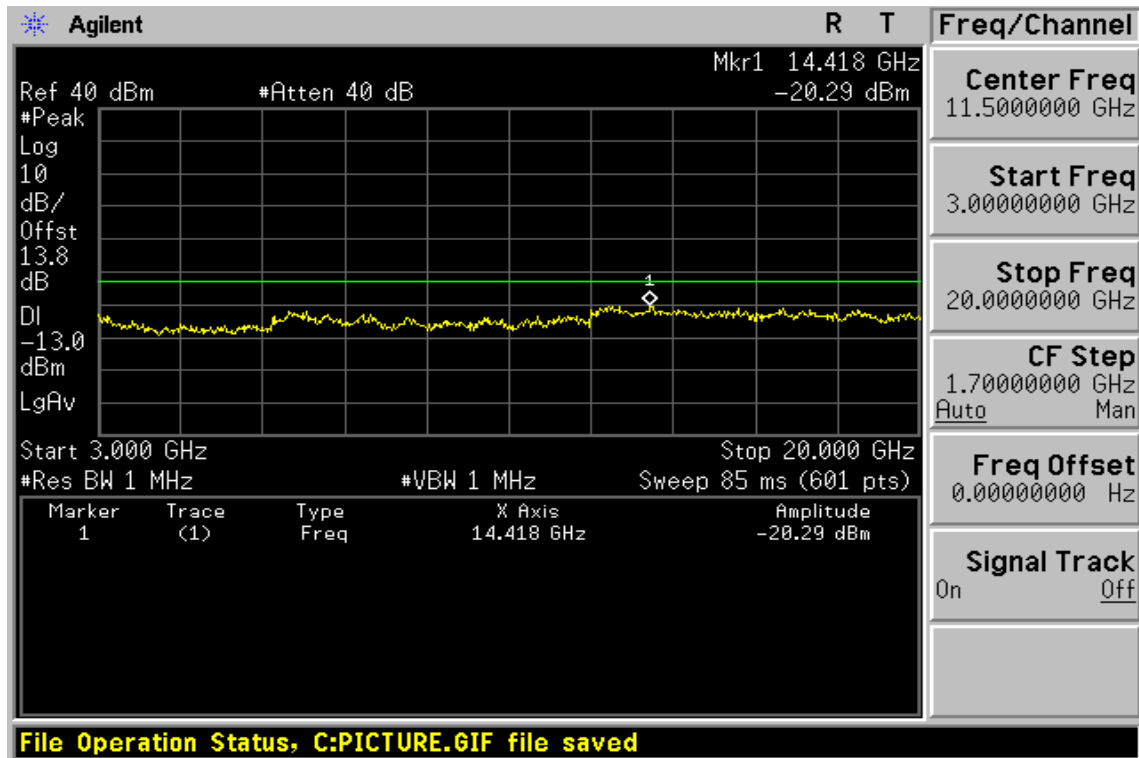
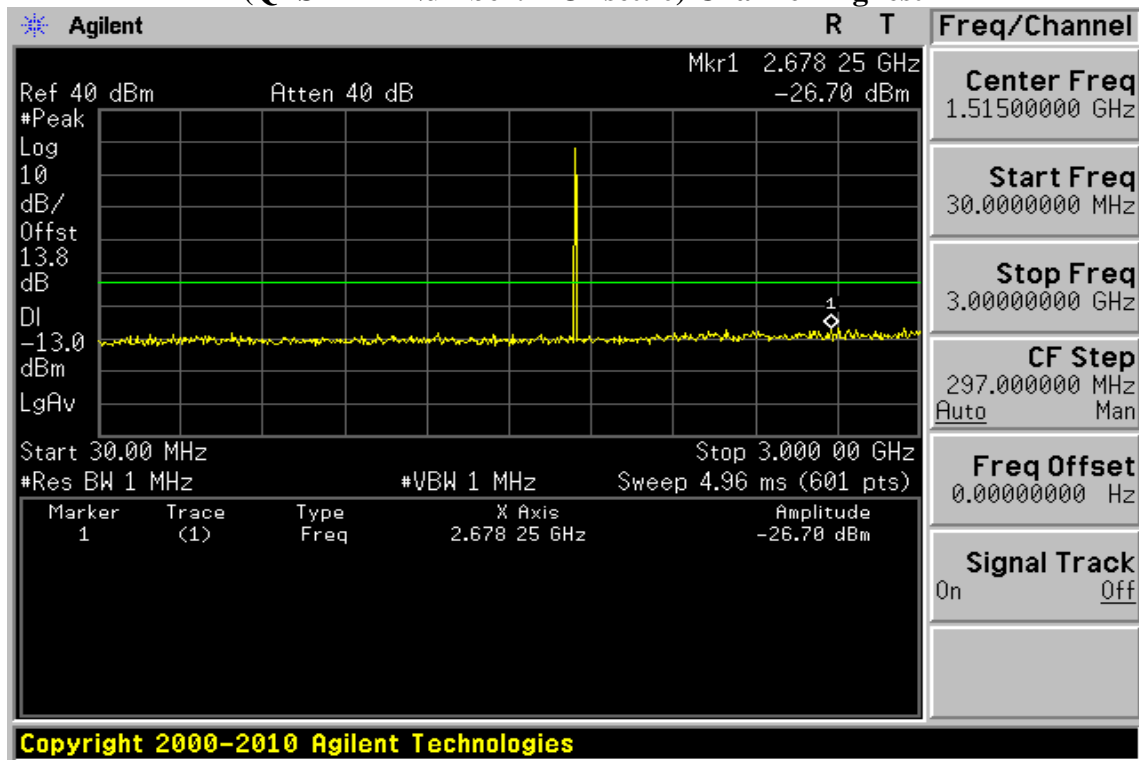

Unless otherwise stated the results shown in this test report refer only to the sample(s) tested and such sample(s) are retained for 90 days only.

除非另有說明，此報告結果僅對測試之樣品負責，同時此樣品僅保留90天。本報告未經本公司書面許可，不可部份複製。

This document is issued by the Company subject to its General Conditions of Service printed overleaf, available on request or accessible at [www.sgs.com/terms\\_and\\_conditions.htm](http://www.sgs.com/terms_and_conditions.htm) and, for electronic format documents, subject to Terms and Conditions for Electronic Documents at [www.sgs.com/terms\\_e-document.htm](http://www.sgs.com/terms_e-document.htm). Attention is drawn to the limitation of liability, indemnification and jurisdiction issues defined therein. Any holder of this document is advised that information contained hereon reflects the Company's findings at the time of its intervention only and within the limits of Client's instructions, if any. The Company's sole responsibility is to its Client and this document does not exonerate parties to a transaction from exercising all their rights and obligations under the transaction documents. This document cannot be reproduced except in full, without prior written approval of the Company. Any unauthorized alteration, forgery or falsification of the content or appearance of this document is unlawful and offenders may be prosecuted to the fullest extent of the law.

**Figure 10-4: Band edge emission at antenna terminals –1.4MHz BW LTE-Band 4 (QPSK RB Number: 1 Offset: 0) Channel Lowest**

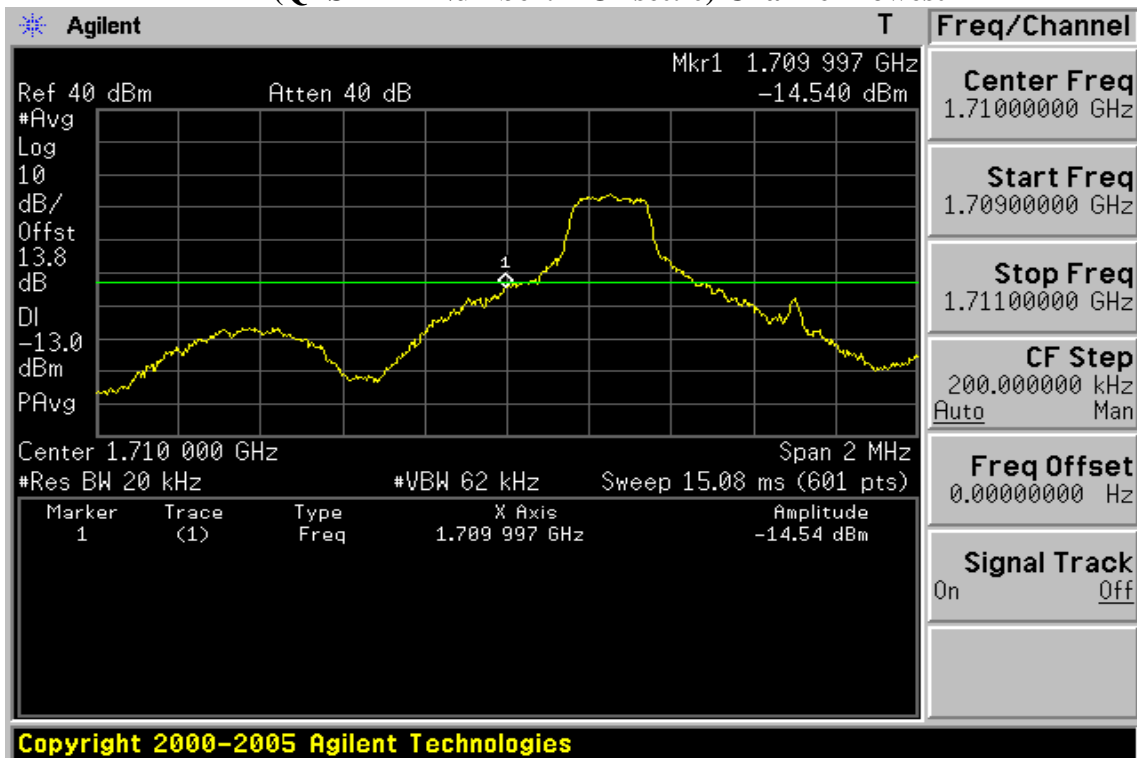

**Figure 10-5: Band edge emission at antenna terminals –1.4MHz BW LTE-Band 4 (QPSK RB Number: 1 Offset: 5) Channel Highest**

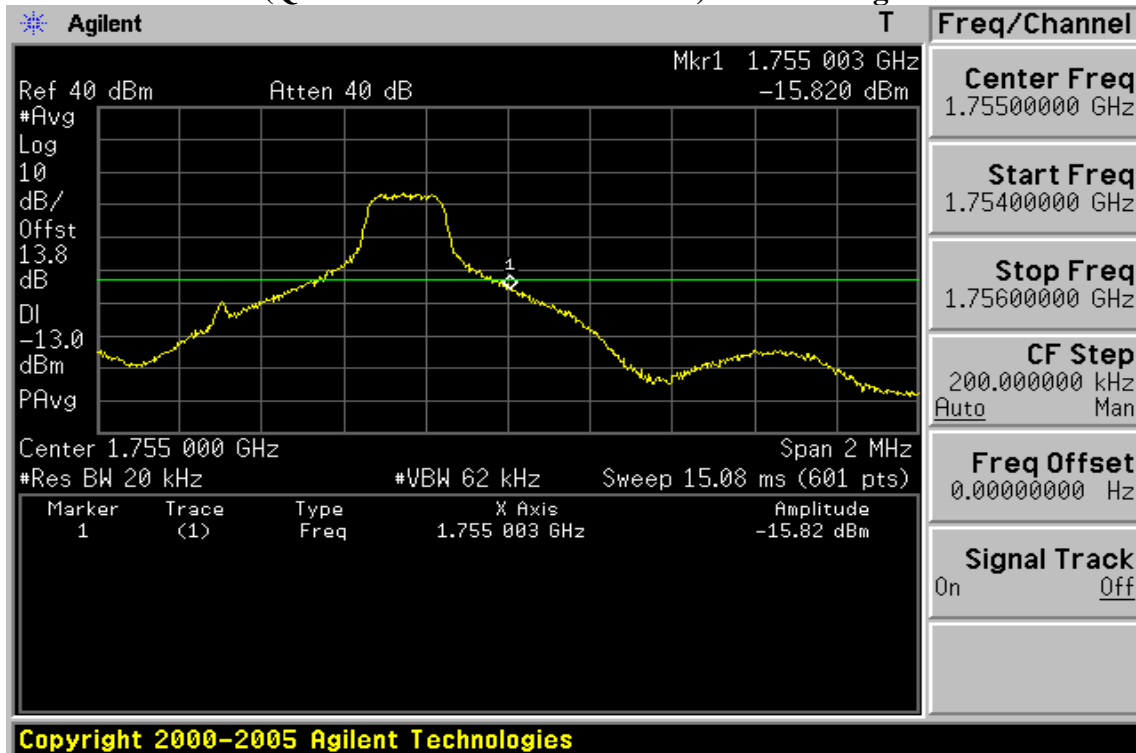

Unless otherwise stated the results shown in this test report refer only to the sample(s) tested and such sample(s) are retained for 90 days only.

除非另有說明，此報告結果僅對測試之樣品負責，同時此樣品僅保留90天。本報告未經本公司書面許可，不可部份複製。

This document is issued by the Company subject to its General Conditions of Service printed overleaf, available on request or accessible at [www.sgs.com/terms\\_and\\_conditions.htm](http://www.sgs.com/terms_and_conditions.htm) and, for electronic format documents, subject to Terms and Conditions for Electronic Documents at [www.sgs.com/terms\\_e-document.htm](http://www.sgs.com/terms_e-document.htm). Attention is drawn to the limitation of liability, indemnification and jurisdiction issues defined therein. Any holder of this document is advised that information contained hereon reflects the Company's findings at the time of its intervention only and within the limits of Client's instructions, if any. The Company's sole responsibility is to its Client and this document does not exonerate parties to a transaction from exercising all their rights and obligations under the transaction documents. This document cannot be reproduced except in full, without prior written approval of the Company. Any unauthorized alteration, forgery or falsification of the content or appearance of this document is unlawful and offenders may be prosecuted to the fullest extent of the law.

**Figure 10-6: Out of Band emission at antenna terminals–3MHz BW LTE-Band 4 (QPSK RB Number: 1 Offset: 0) Channel Lowest**

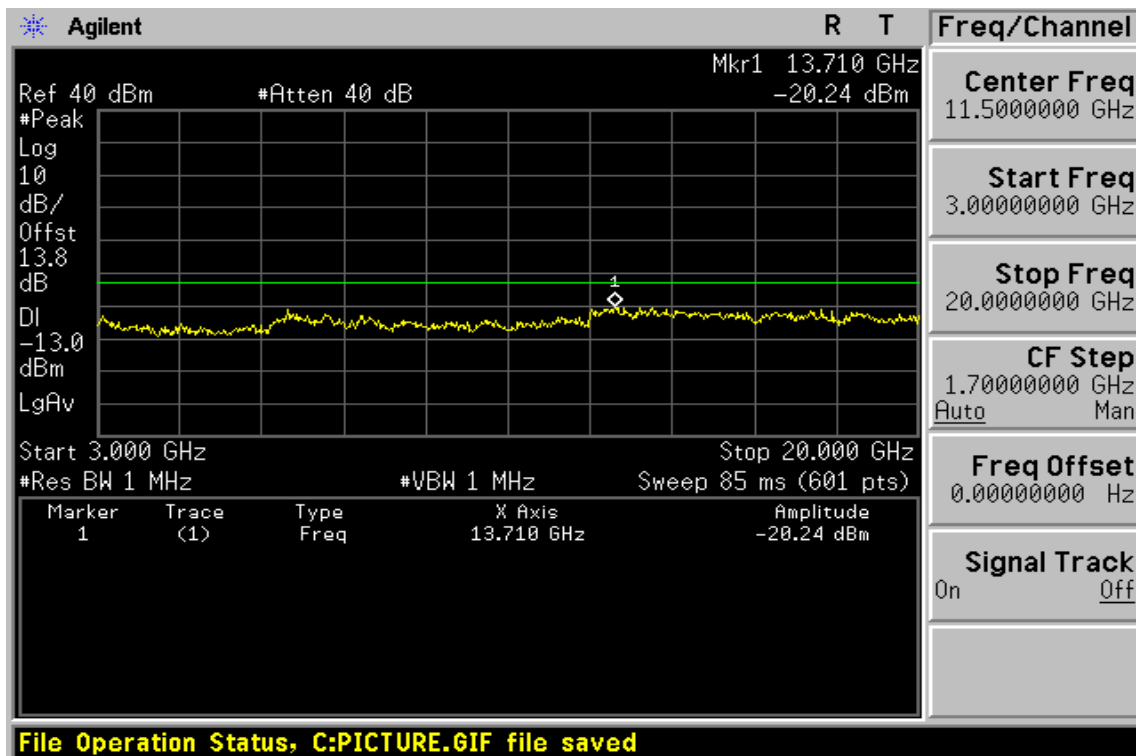
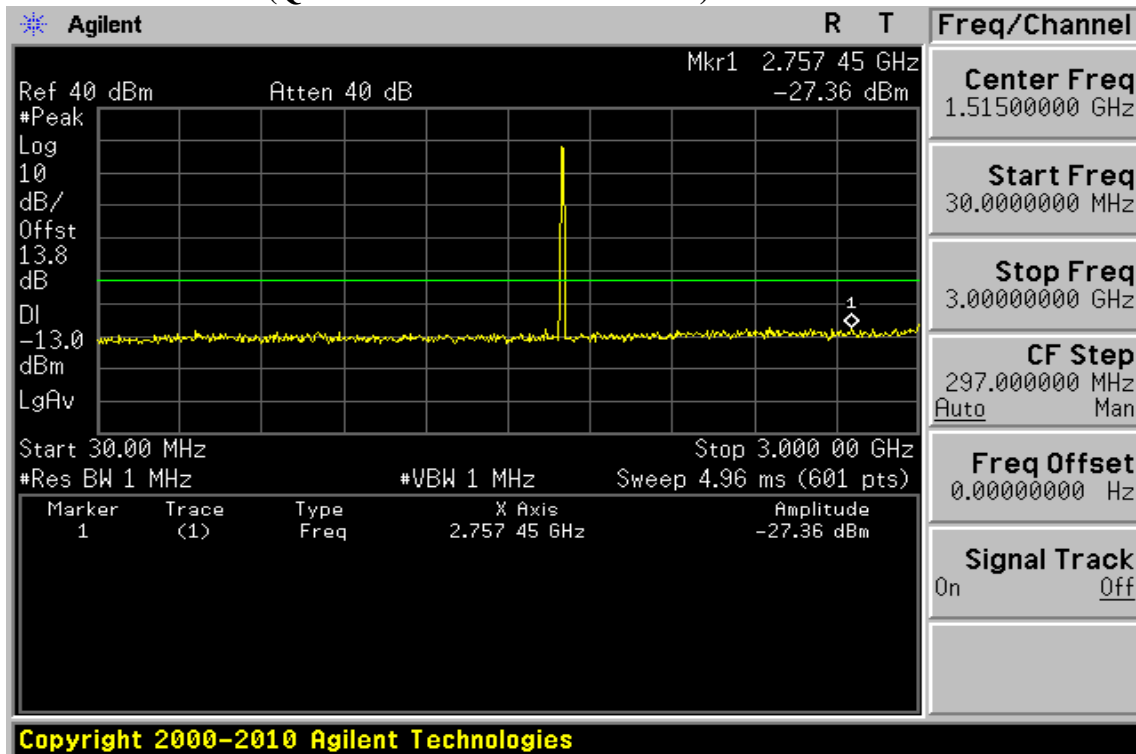

Unless otherwise stated the results shown in this test report refer only to the sample(s) tested and such sample(s) are retained for 90 days only.

除非另有說明，此報告結果僅對測試之樣品負責，同時此樣品僅保留90天。本報告未經本公司書面許可，不可部份複製。

This document is issued by the Company subject to its General Conditions of Service printed overleaf, available on request or accessible at [www.sgs.com/terms\\_and\\_conditions.htm](http://www.sgs.com/terms_and_conditions.htm) and, for electronic format documents, subject to Terms and Conditions for Electronic Documents at [www.sgs.com/terms\\_e-document.htm](http://www.sgs.com/terms_e-document.htm). Attention is drawn to the limitation of liability, indemnification and jurisdiction issues defined therein. Any holder of this document is advised that information contained hereon reflects the Company's findings at the time of its intervention only and within the limits of Client's instructions, if any. The Company's sole responsibility is to its Client and this document does not exonerate parties to a transaction from exercising all their rights and obligations under the transaction documents. This document cannot be reproduced except in full, without prior written approval of the Company. Any unauthorized alteration, forgery or falsification of the content or appearance of this document is unlawful and offenders may be prosecuted to the fullest extent of the law.

**Figure 10-7: Out of Band emission at antenna terminals –3MHz BW LTE-Band 4 (QPSK RB Number: 1 Offset: 0) Channel Mid**

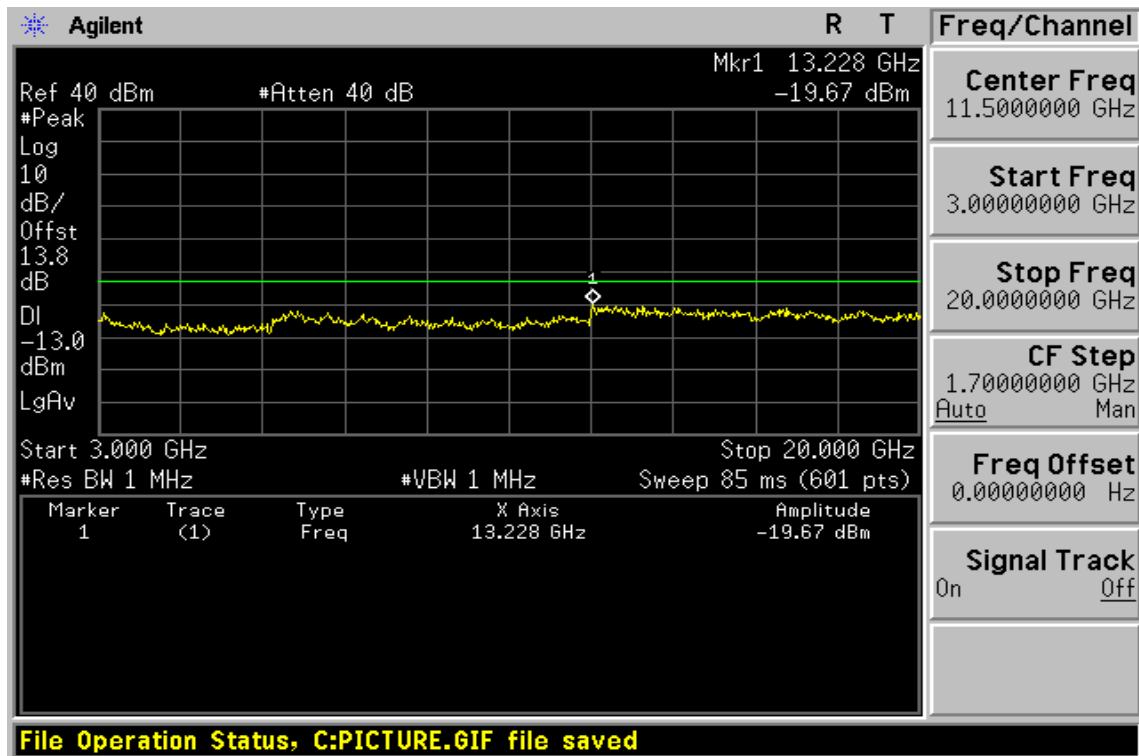
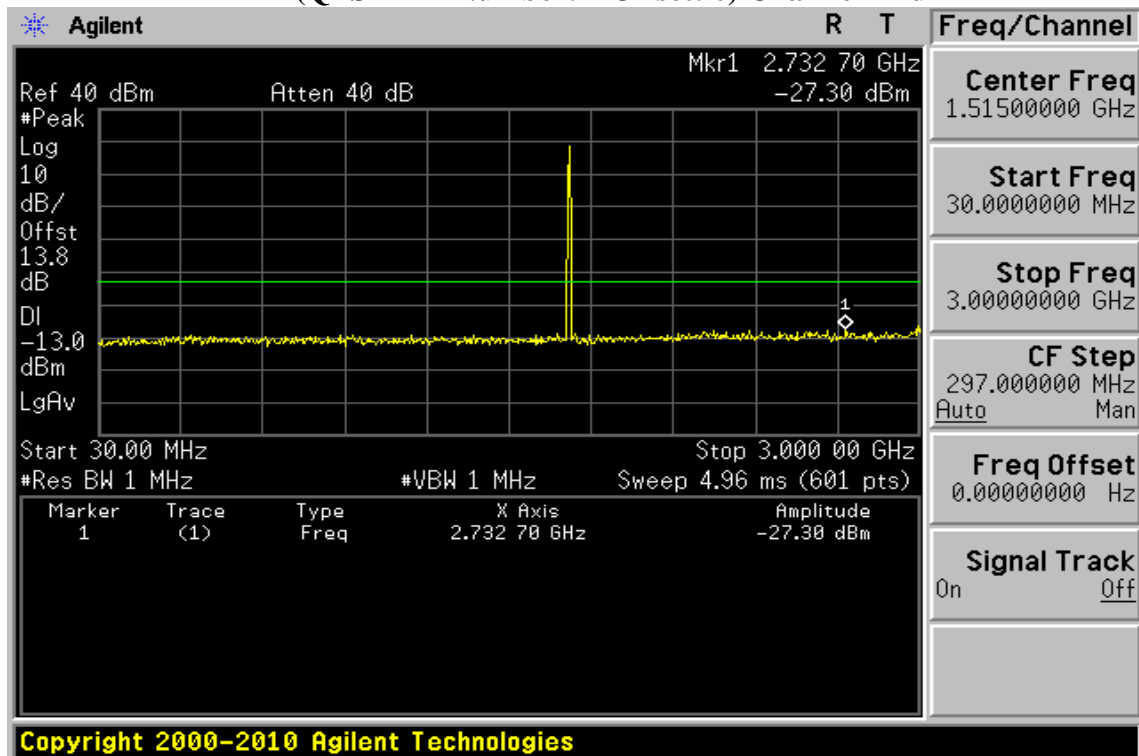

Unless otherwise stated the results shown in this test report refer only to the sample(s) tested and such sample(s) are retained for 90 days only.

除非另有說明，此報告結果僅對測試之樣品負責，同時此樣品僅保留90天。本報告未經本公司書面許可，不可部份複製。

This document is issued by the Company subject to its General Conditions of Service printed overleaf, available on request or accessible at [www.sgs.com/terms\\_and\\_conditions.htm](http://www.sgs.com/terms_and_conditions.htm) and, for electronic format documents, subject to Terms and Conditions for Electronic Documents at [www.sgs.com/terms\\_e-document.htm](http://www.sgs.com/terms_e-document.htm). Attention is drawn to the limitation of liability, indemnification and jurisdiction issues defined therein. Any holder of this document is advised that information contained hereon reflects the Company's findings at the time of its intervention only and within the limits of Client's instructions, if any. The Company's sole responsibility is to its Client and this document does not exonerate parties to a transaction from exercising all their rights and obligations under the transaction documents. This document cannot be reproduced except in full, without prior written approval of the Company. Any unauthorized alteration, forgery or falsification of the content or appearance of this document is unlawful and offenders may be prosecuted to the fullest extent of the law.

**Figure 10-8: Out of Band emission at antenna terminals–3MHz BW LTE-Band 4 (QPSK RB Number: 1 Offset: 0) Channel Highest**

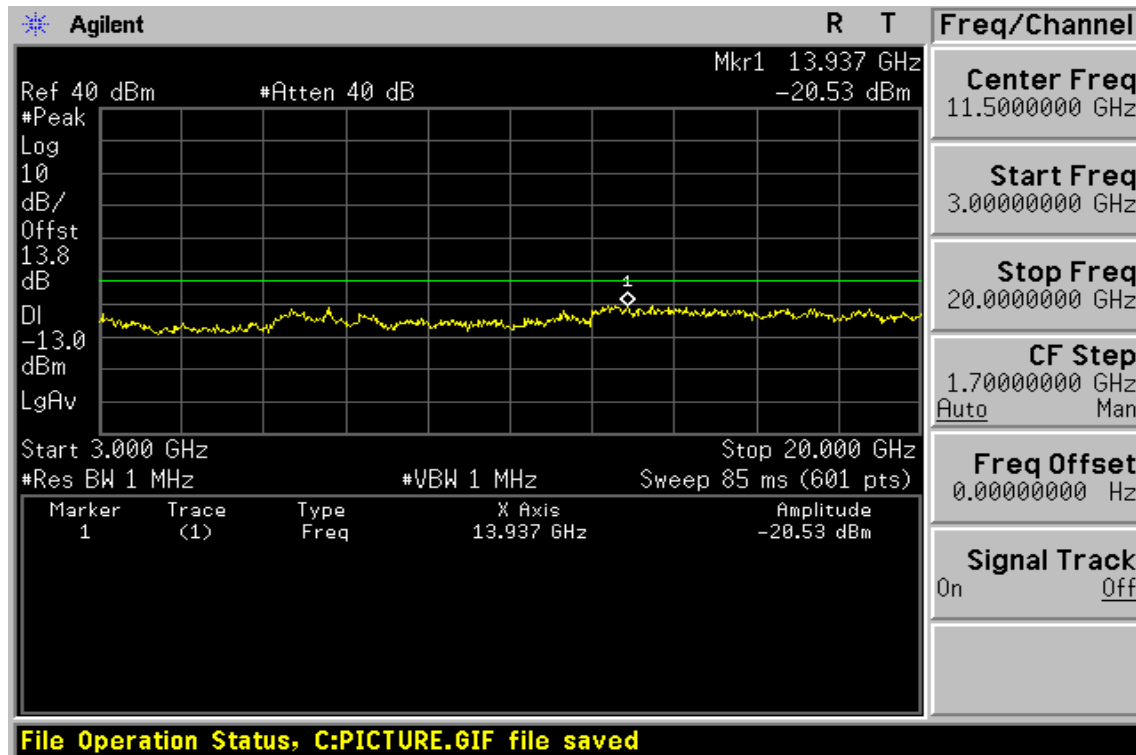
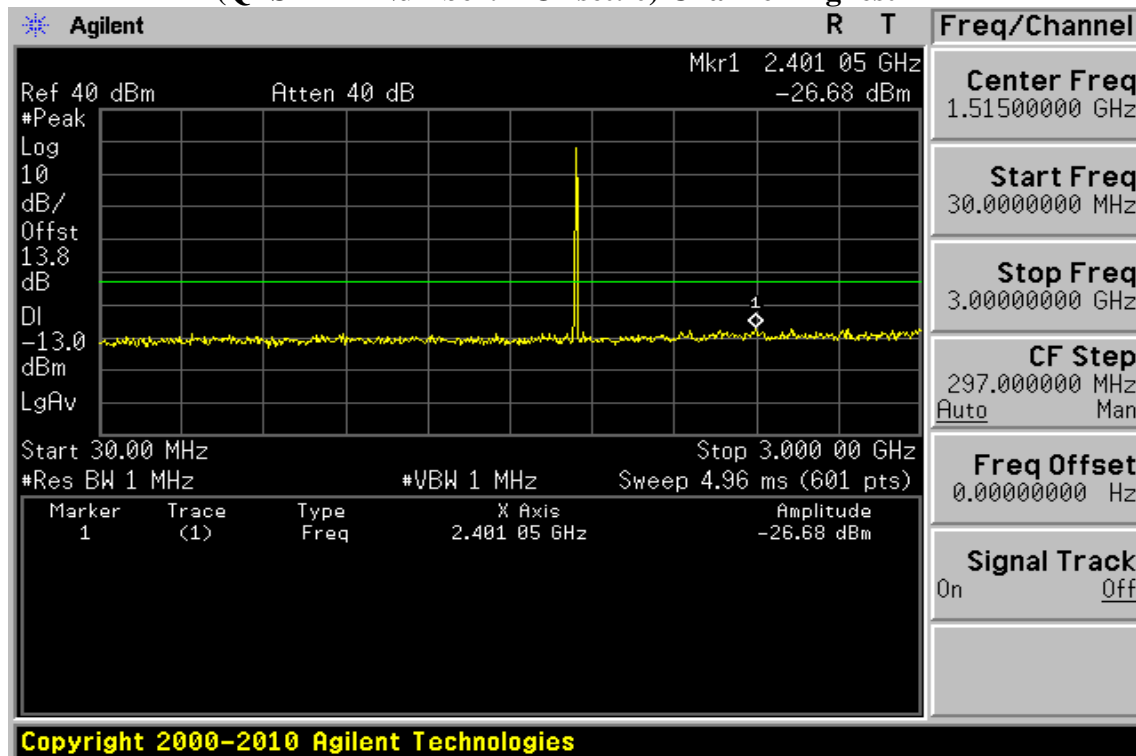

Unless otherwise stated the results shown in this test report refer only to the sample(s) tested and such sample(s) are retained for 90 days only.

除非另有說明，此報告結果僅對測試之樣品負責，同時此樣品僅保留90天。本報告未經本公司書面許可，不可部份複製。

This document is issued by the Company subject to its General Conditions of Service printed overleaf, available on request or accessible at [www.sgs.com/terms\\_and\\_conditions.htm](http://www.sgs.com/terms_and_conditions.htm) and, for electronic format documents, subject to Terms and Conditions for Electronic Documents at [www.sgs.com/terms\\_e-document.htm](http://www.sgs.com/terms_e-document.htm). Attention is drawn to the limitation of liability, indemnification and jurisdiction issues defined therein. Any holder of this document is advised that information contained hereon reflects the Company's findings at the time of its intervention only and within the limits of Client's instructions, if any. The Company's sole responsibility is to its Client and this document does not exonerate parties to a transaction from exercising all their rights and obligations under the transaction documents. This document cannot be reproduced except in full, without prior written approval of the Company. Any unauthorized alteration, forgery or falsification of the content or appearance of this document is unlawful and offenders may be prosecuted to the fullest extent of the law.

**Figure 10-9: Band edge emission at antenna terminals –3MHz BW LTE-Band 4 (QPSK RB Number: 1 Offset: 0) Channel Lowest**

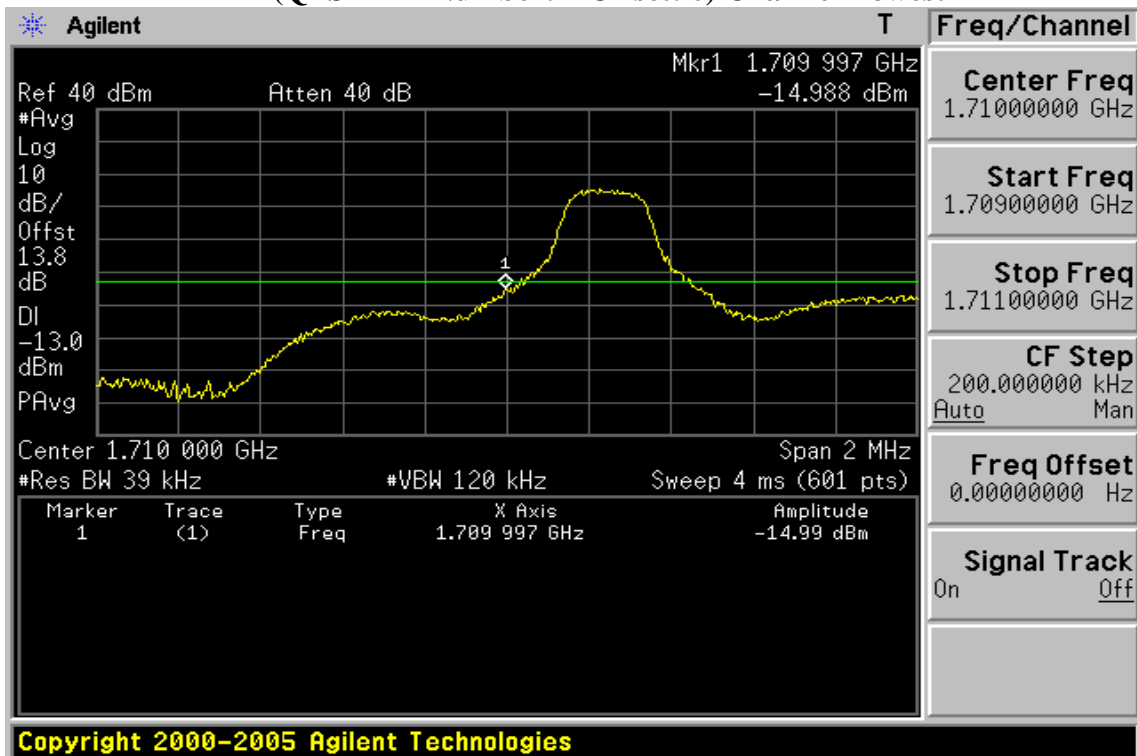

**Figure 10-10: Band edge emission at antenna terminals –3MHz BW LTE-Band 4 (QPSK RB Number: 15 Offset: 0) Channel Highest**

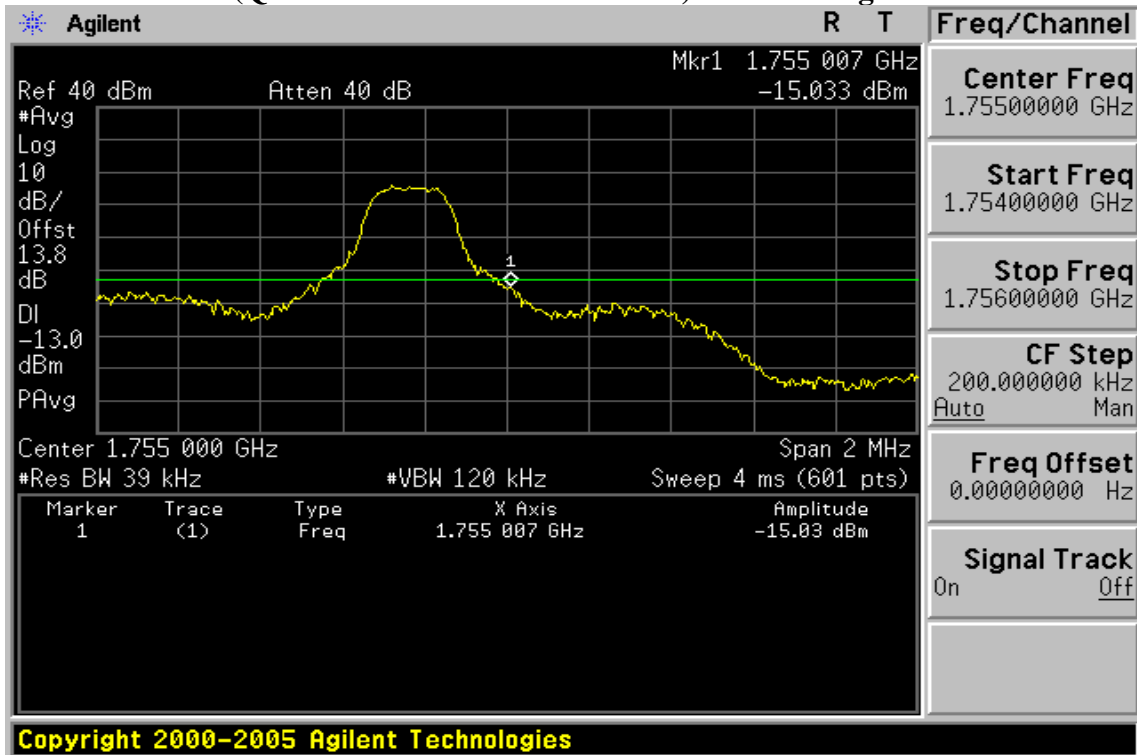

Unless otherwise stated the results shown in this test report refer only to the sample(s) tested and such sample(s) are retained for 90 days only.

除非另有說明，此報告結果僅對測試之樣品負責，同時此樣品僅保留90天。本報告未經本公司書面許可，不可部份複製。

This document is issued by the Company subject to its General Conditions of Service printed overleaf, available on request or accessible at [www.sgs.com/terms\\_and\\_conditions.htm](http://www.sgs.com/terms_and_conditions.htm) and, for electronic format documents, subject to Terms and Conditions for Electronic Documents at [www.sgs.com/terms\\_e-document.htm](http://www.sgs.com/terms_e-document.htm). Attention is drawn to the limitation of liability, indemnification and jurisdiction issues defined therein. Any holder of this document is advised that information contained hereon reflects the Company's findings at the time of its intervention only and within the limits of Client's instructions, if any. The Company's sole responsibility is to its Client and this document does not exonerate parties to a transaction from exercising all their rights and obligations under the transaction documents. This document cannot be reproduced except in full, without prior written approval of the Company. Any unauthorized alteration, forgery or falsification of the content or appearance of this document is unlawful and offenders may be prosecuted to the fullest extent of the law.



**Figure 10-11: Out of Band emission at antenna terminals-5MHz BW LTE-Band 4 (QPSK RB Number: 1 Offset: 0) Channel Lowest**

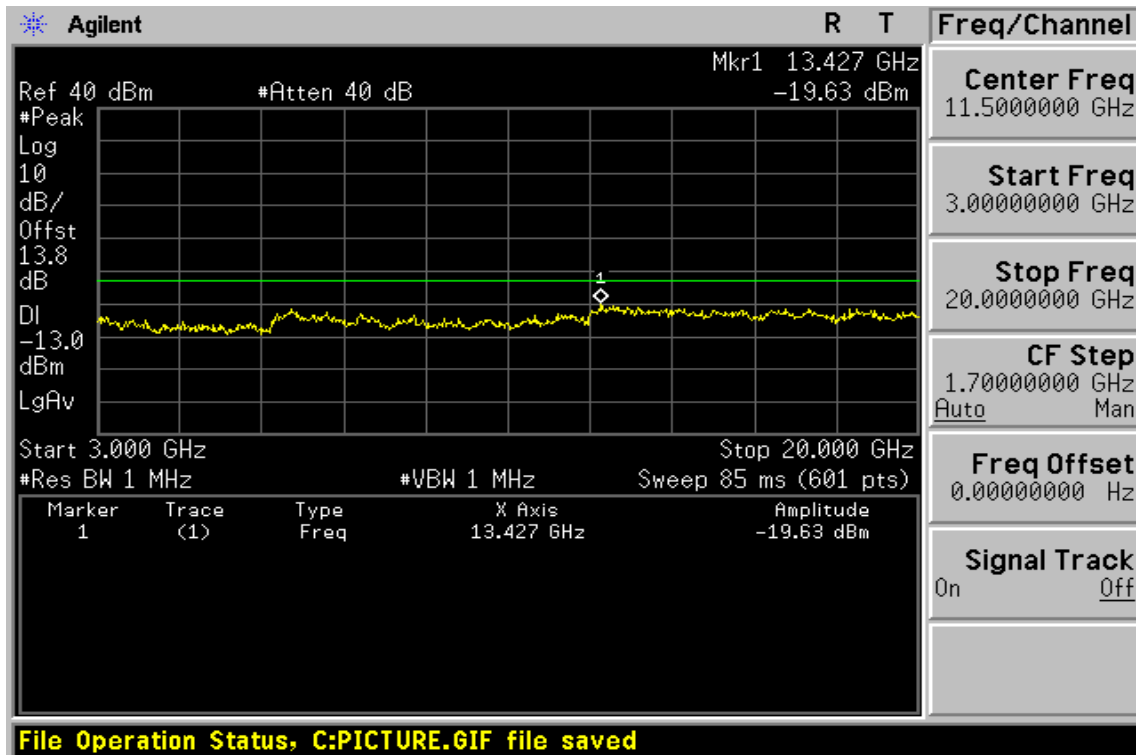
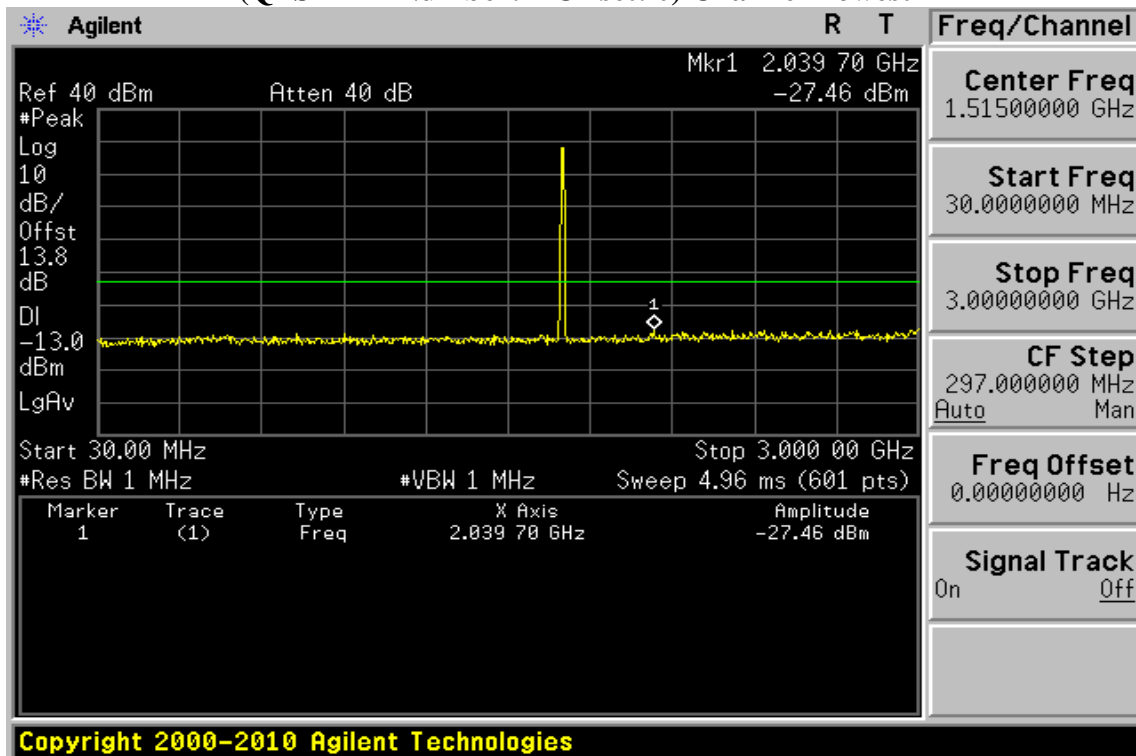

Unless otherwise stated the results shown in this test report refer only to the sample(s) tested and such sample(s) are retained for 90 days only.

除非另有說明，此報告結果僅對測試之樣品負責，同時此樣品僅保留90天。本報告未經本公司書面許可，不可部份複製。

This document is issued by the Company subject to its General Conditions of Service printed overleaf, available on request or accessible at [www.sgs.com/terms\\_and\\_conditions.htm](http://www.sgs.com/terms_and_conditions.htm) and, for electronic format documents, subject to Terms and Conditions for Electronic Documents at [www.sgs.com/terms\\_e-document.htm](http://www.sgs.com/terms_e-document.htm). Attention is drawn to the limitation of liability, indemnification and jurisdiction issues defined therein. Any holder of this document is advised that information contained hereon reflects the Company's findings at the time of its intervention only and within the limits of Client's instructions, if any. The Company's sole responsibility is to its Client and this document does not exonerate parties to a transaction from exercising all their rights and obligations under the transaction documents. This document cannot be reproduced except in full, without prior written approval of the Company. Any unauthorized alteration, forgery or falsification of the content or appearance of this document is unlawful and offenders may be prosecuted to the fullest extent of the law.

**Figure 10-12: Out of Band emission at antenna terminals –5MHz BW LTE-Band 4 (QPSK RB Number: 1 Offset: 0) Channel Mid**

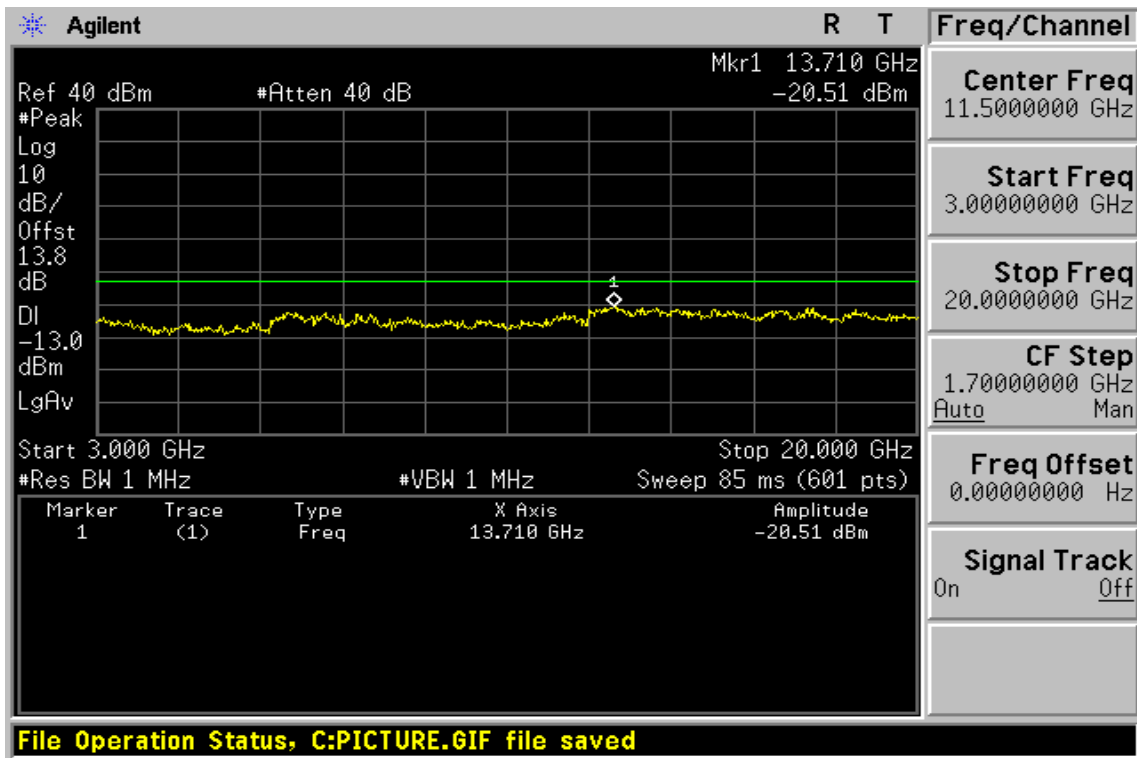
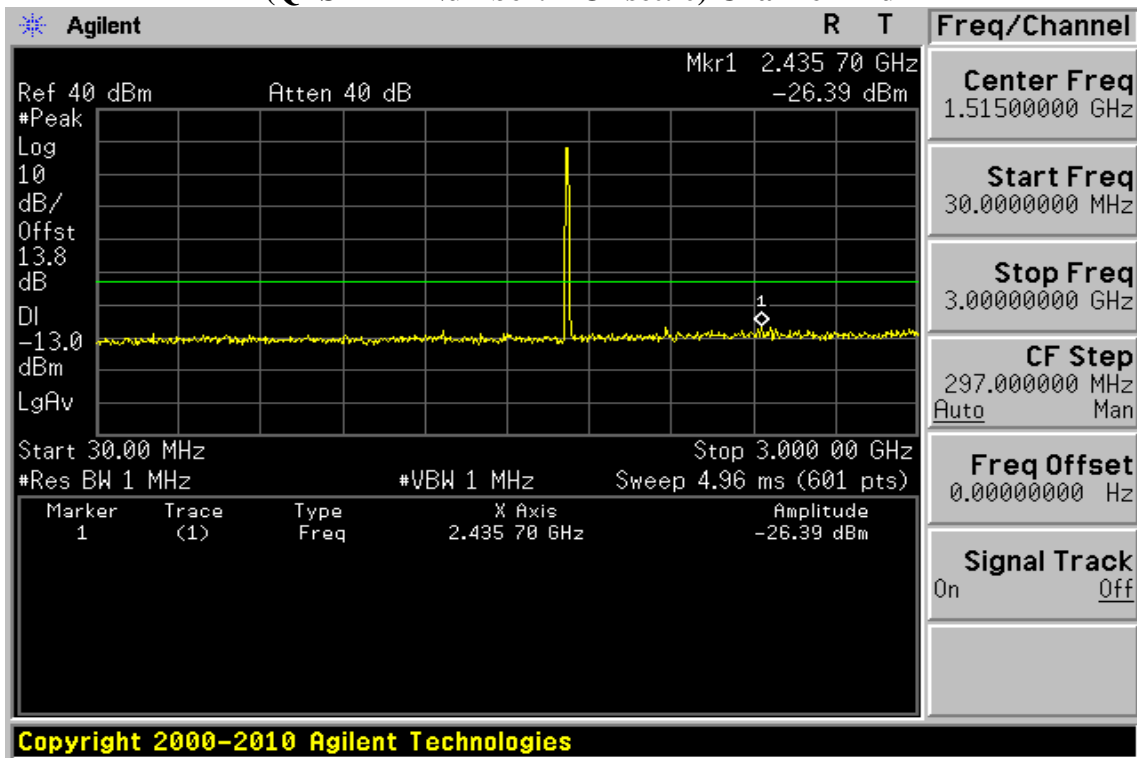

Unless otherwise stated the results shown in this test report refer only to the sample(s) tested and such sample(s) are retained for 90 days only.

除非另有說明，此報告結果僅對測試之樣品負責，同時此樣品僅保留90天。本報告未經本公司書面許可，不可部份複製。

This document is issued by the Company subject to its General Conditions of Service printed overleaf, available on request or accessible at [www.sgs.com/terms\\_and\\_conditions.htm](http://www.sgs.com/terms_and_conditions.htm) and, for electronic format documents, subject to Terms and Conditions for Electronic Documents at [www.sgs.com/terms\\_e-document.htm](http://www.sgs.com/terms_e-document.htm). Attention is drawn to the limitation of liability, indemnification and jurisdiction issues defined therein. Any holder of this document is advised that information contained hereon reflects the Company's findings at the time of its intervention only and within the limits of Client's instructions, if any. The Company's sole responsibility is to its Client and this document does not exonerate parties to a transaction from exercising all their rights and obligations under the transaction documents. This document cannot be reproduced except in full, without prior written approval of the Company. Any unauthorized alteration, forgery or falsification of the content or appearance of this document is unlawful and offenders may be prosecuted to the fullest extent of the law.

**Figure 10-13: Out of Band emission at antenna terminals–5MHz BW LTE-Band 4 (QPSK RB Number: 1 Offset: 0) Channel Highest**

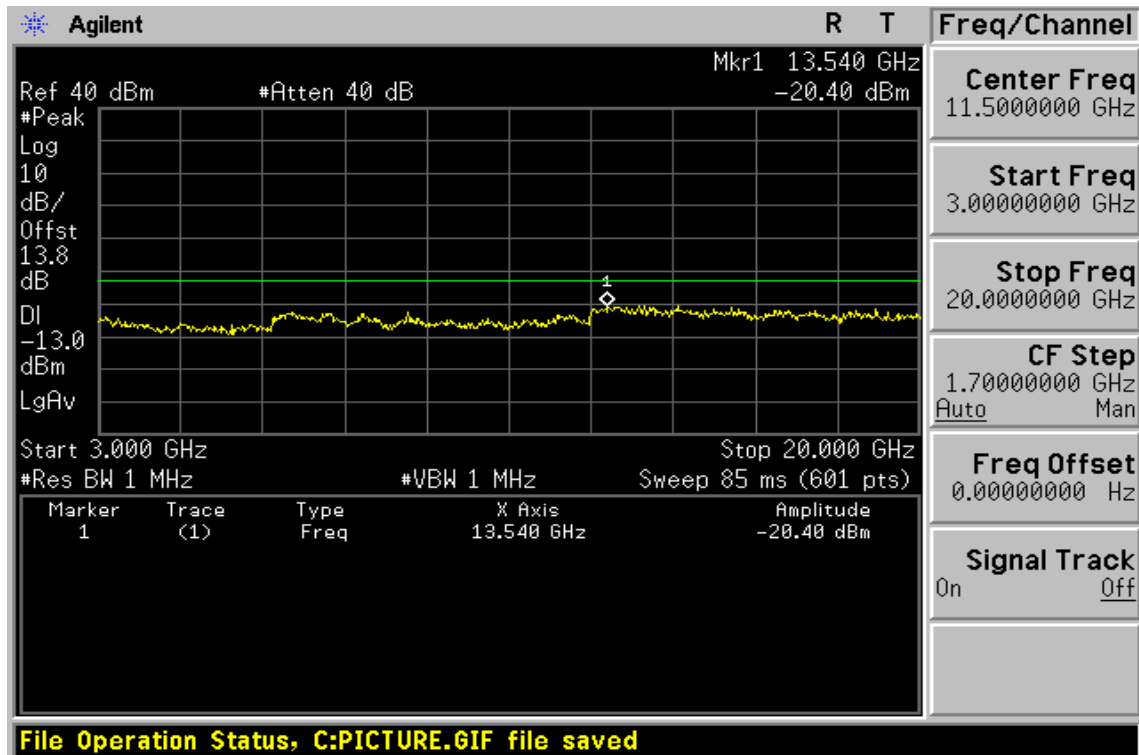
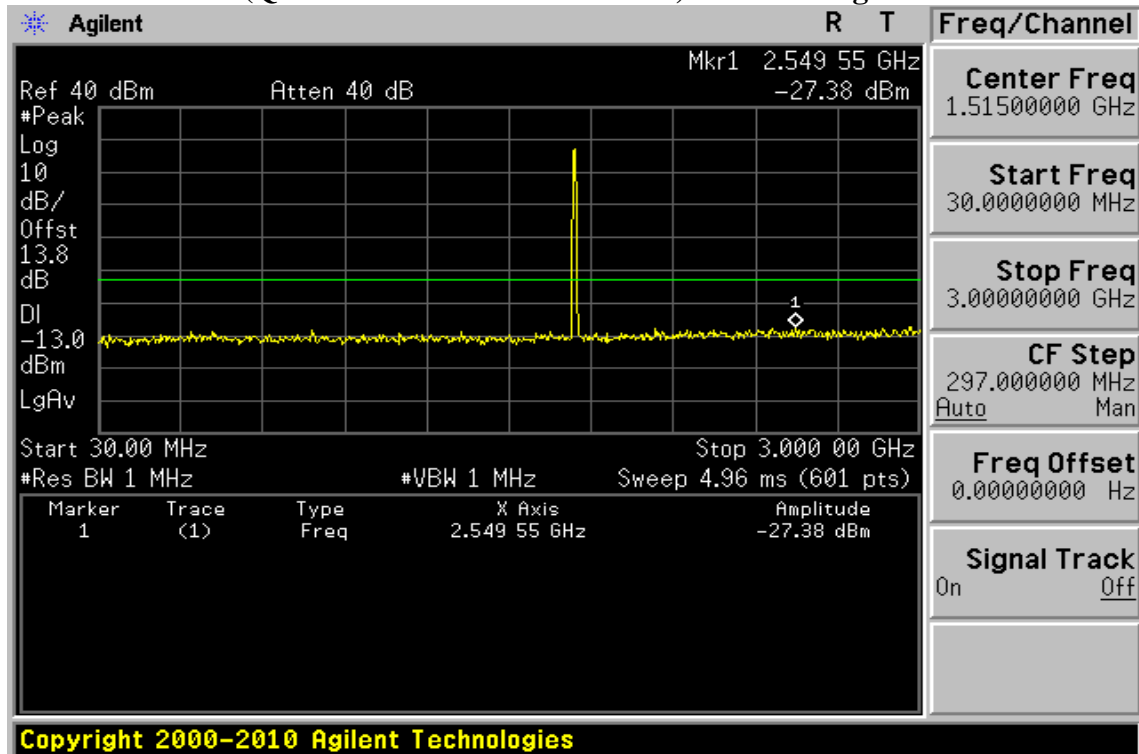

Unless otherwise stated the results shown in this test report refer only to the sample(s) tested and such sample(s) are retained for 90 days only.

除非另有說明，此報告結果僅對測試之樣品負責，同時此樣品僅保留90天。本報告未經本公司書面許可，不可部份複製。

This document is issued by the Company subject to its General Conditions of Service printed overleaf, available on request or accessible at [www.sgs.com/terms\\_and\\_conditions.htm](http://www.sgs.com/terms_and_conditions.htm) and, for electronic format documents, subject to Terms and Conditions for Electronic Documents at [www.sgs.com/terms\\_e-document.htm](http://www.sgs.com/terms_e-document.htm). Attention is drawn to the limitation of liability, indemnification and jurisdiction issues defined therein. Any holder of this document is advised that information contained hereon reflects the Company's findings at the time of its intervention only and within the limits of Client's instructions, if any. The Company's sole responsibility is to its Client and this document does not exonerate parties to a transaction from exercising all their rights and obligations under the transaction documents. This document cannot be reproduced except in full, without prior written approval of the Company. Any unauthorized alteration, forgery or falsification of the content or appearance of this document is unlawful and offenders may be prosecuted to the fullest extent of the law.

**Figure 10-14: Band edge emission at antenna terminals –5MHz BW LTE-Band 4 (QPSK RB Number: 1 Offset: 0) Channel Lowest**

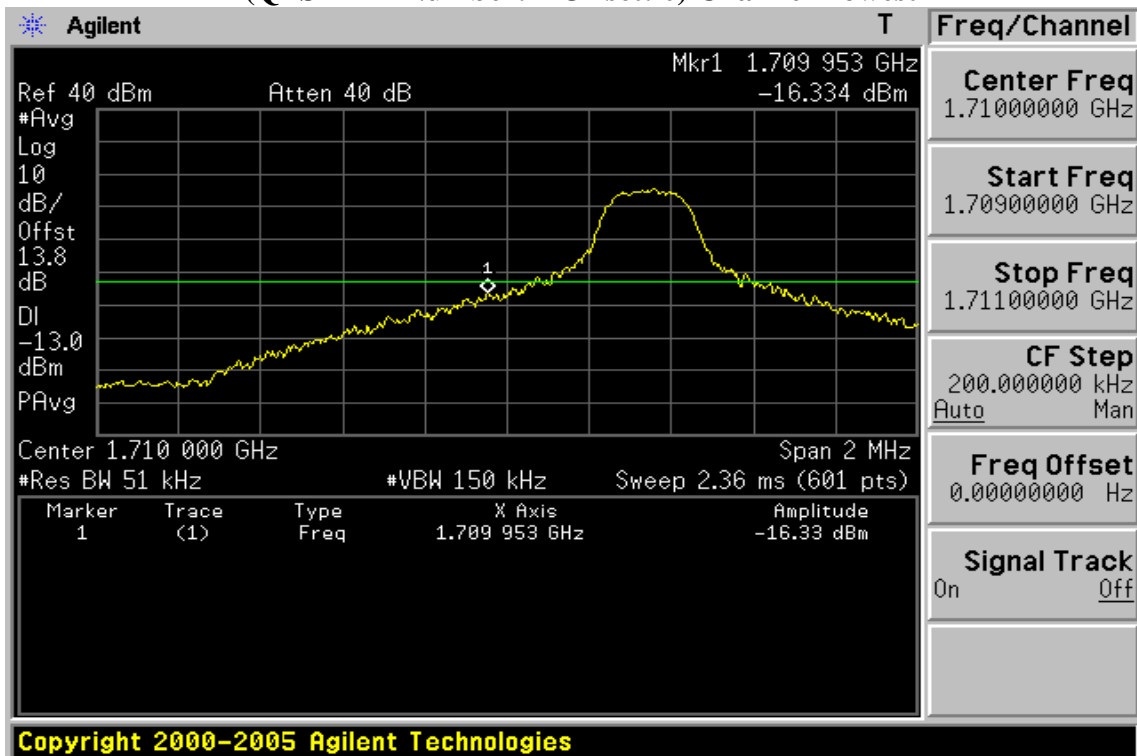

**Figure 10-15: Band edge emission at antenna terminals –5MHz BW LTE-Band 4 (QPSK RB Number: 1 Offset: 24) Channel Highest**

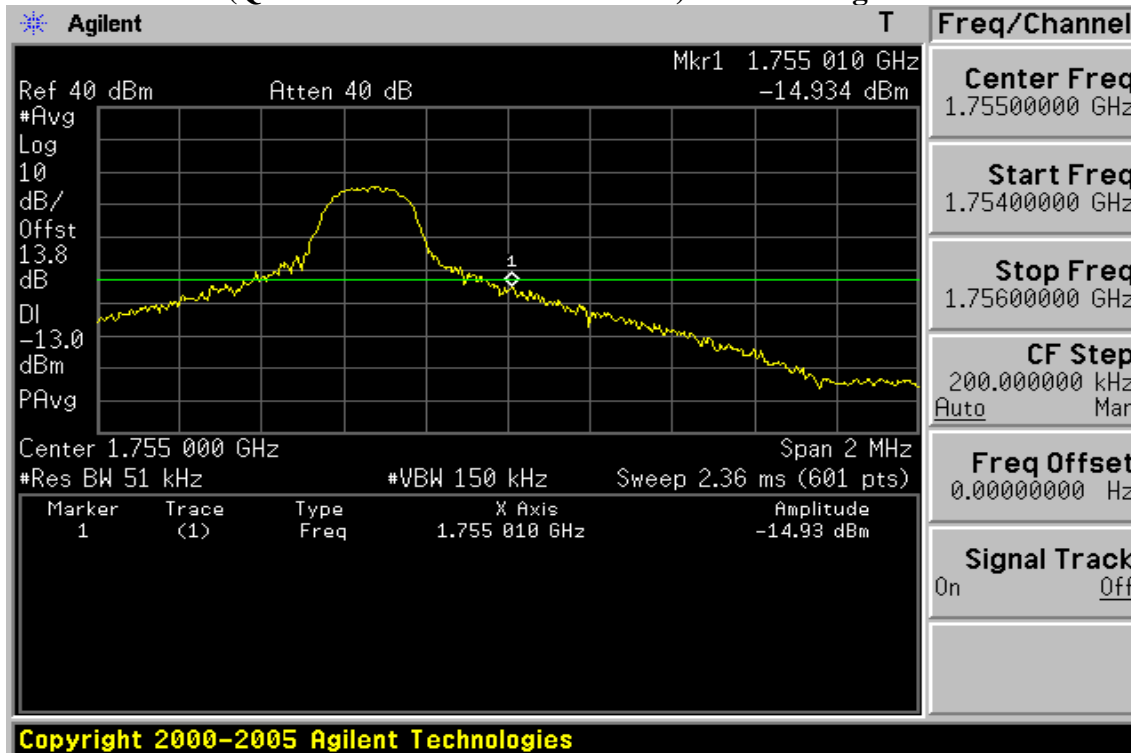

Unless otherwise stated the results shown in this test report refer only to the sample(s) tested and such sample(s) are retained for 90 days only.

除非另有說明，此報告結果僅對測試之樣品負責，同時此樣品僅保留90天。本報告未經本公司書面許可，不可部份複製。

This document is issued by the Company subject to its General Conditions of Service printed overleaf, available on request or accessible at [www.sgs.com/terms\\_and\\_conditions.htm](http://www.sgs.com/terms_and_conditions.htm) and, for electronic format documents, subject to Terms and Conditions for Electronic Documents at [www.sgs.com/terms\\_e-document.htm](http://www.sgs.com/terms_e-document.htm). Attention is drawn to the limitation of liability, indemnification and jurisdiction issues defined therein. Any holder of this document is advised that information contained hereon reflects the Company's findings at the time of its intervention only and within the limits of Client's instructions, if any. The Company's sole responsibility is to its Client and this document does not exonerate parties to a transaction from exercising all their rights and obligations under the transaction documents. This document cannot be reproduced except in full, without prior written approval of the Company. Any unauthorized alteration, forgery or falsification of the content or appearance of this document is unlawful and offenders may be prosecuted to the fullest extent of the law.

**Figure 10-16: Out of Band emission at antenna terminals–10MHz BW LTE-Band 4 (QPSK RB Number: 1 Offset: 0) Channel Lowest**

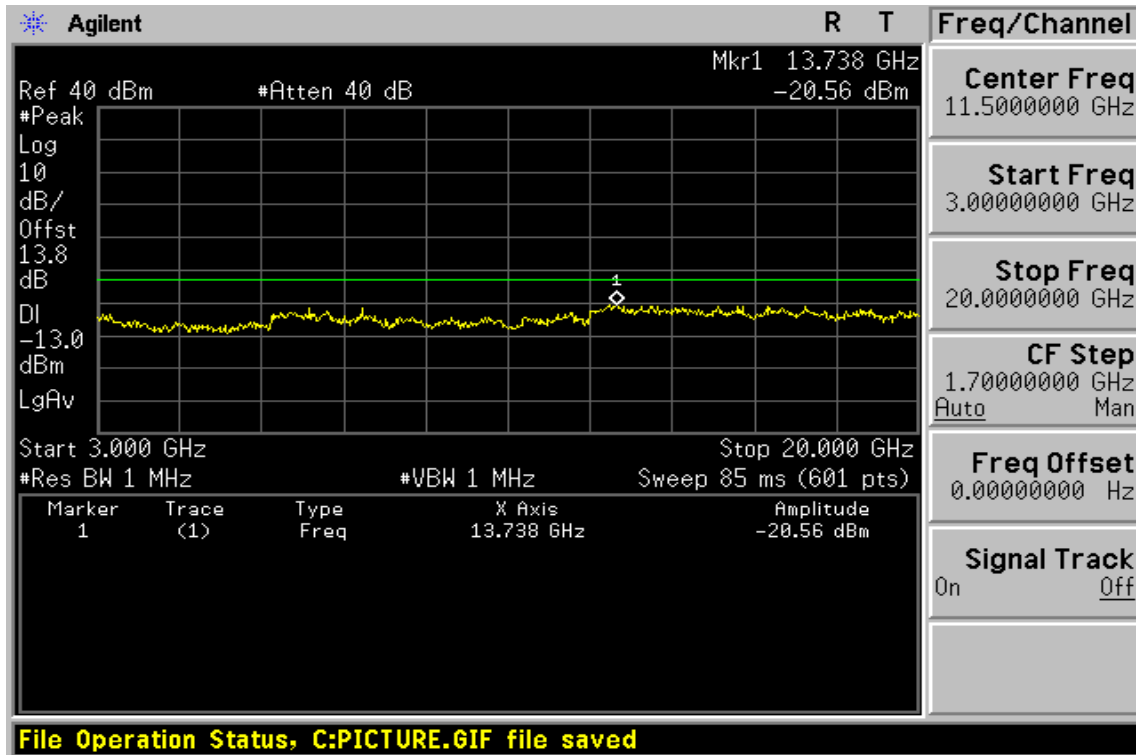
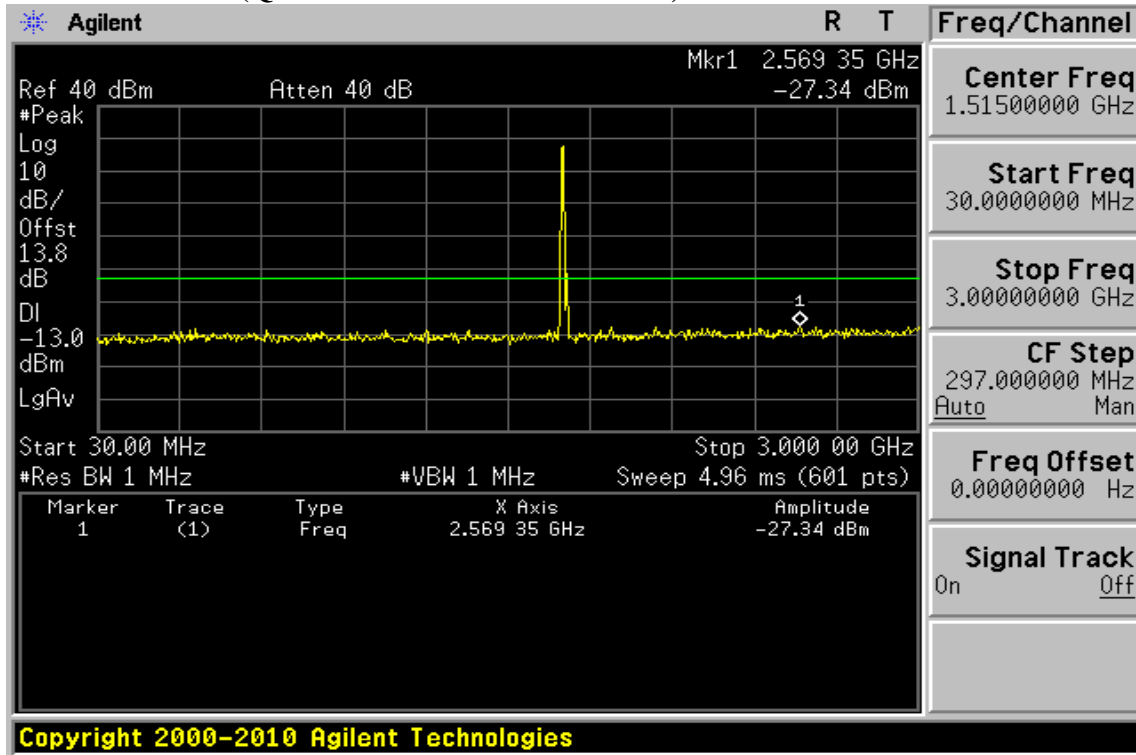

Unless otherwise stated the results shown in this test report refer only to the sample(s) tested and such sample(s) are retained for 90 days only.

除非另有說明，此報告結果僅對測試之樣品負責，同時此樣品僅保留90天。本報告未經本公司書面許可，不可部份複製。

This document is issued by the Company subject to its General Conditions of Service printed overleaf, available on request or accessible at [www.sgs.com/terms\\_and\\_conditions.htm](http://www.sgs.com/terms_and_conditions.htm) and, for electronic format documents, subject to Terms and Conditions for Electronic Documents at [www.sgs.com/terms\\_e-document.htm](http://www.sgs.com/terms_e-document.htm). Attention is drawn to the limitation of liability, indemnification and jurisdiction issues defined therein. Any holder of this document is advised that information contained hereon reflects the Company's findings at the time of its intervention only and within the limits of Client's instructions, if any. The Company's sole responsibility is to its Client and this document does not exonerate parties to a transaction from exercising all their rights and obligations under the transaction documents. This document cannot be reproduced except in full, without prior written approval of the Company. Any unauthorized alteration, forgery or falsification of the content or appearance of this document is unlawful and offenders may be prosecuted to the fullest extent of the law.

**Figure 10-17: Out of Band emission at antenna terminals –10MHz BW LTE-Band 4 (QPSK RB Number: 1 Offset: 0) Channel Mid**

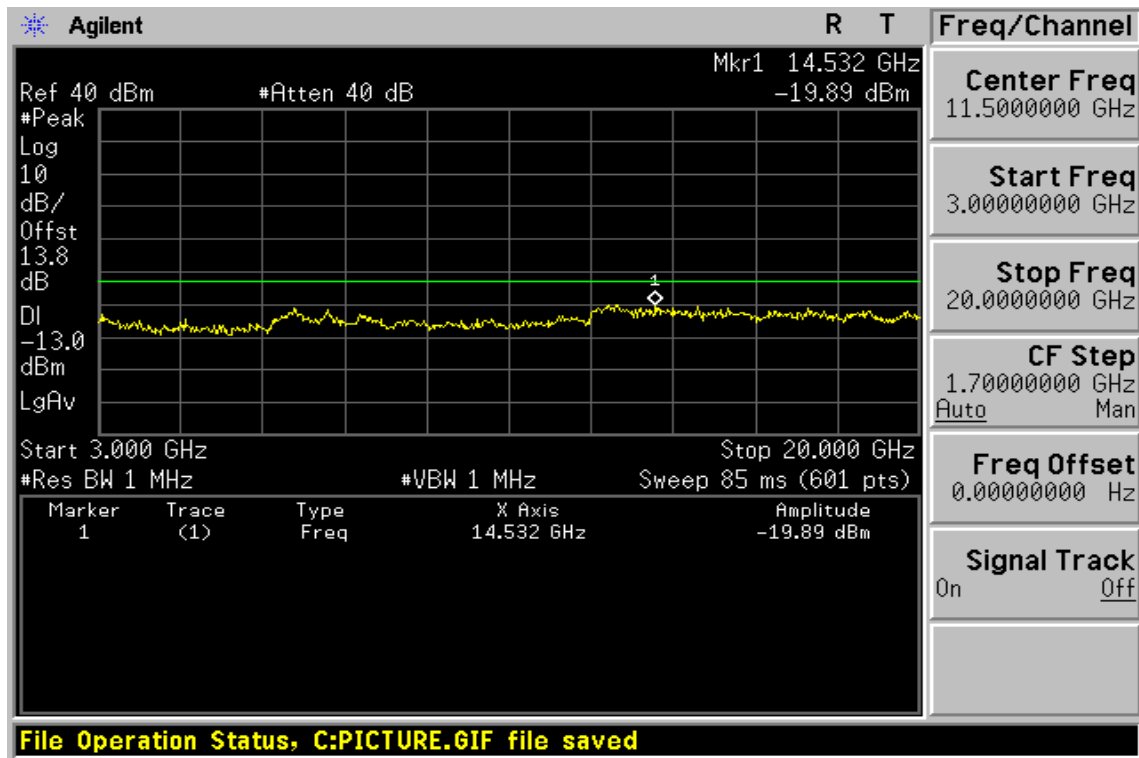
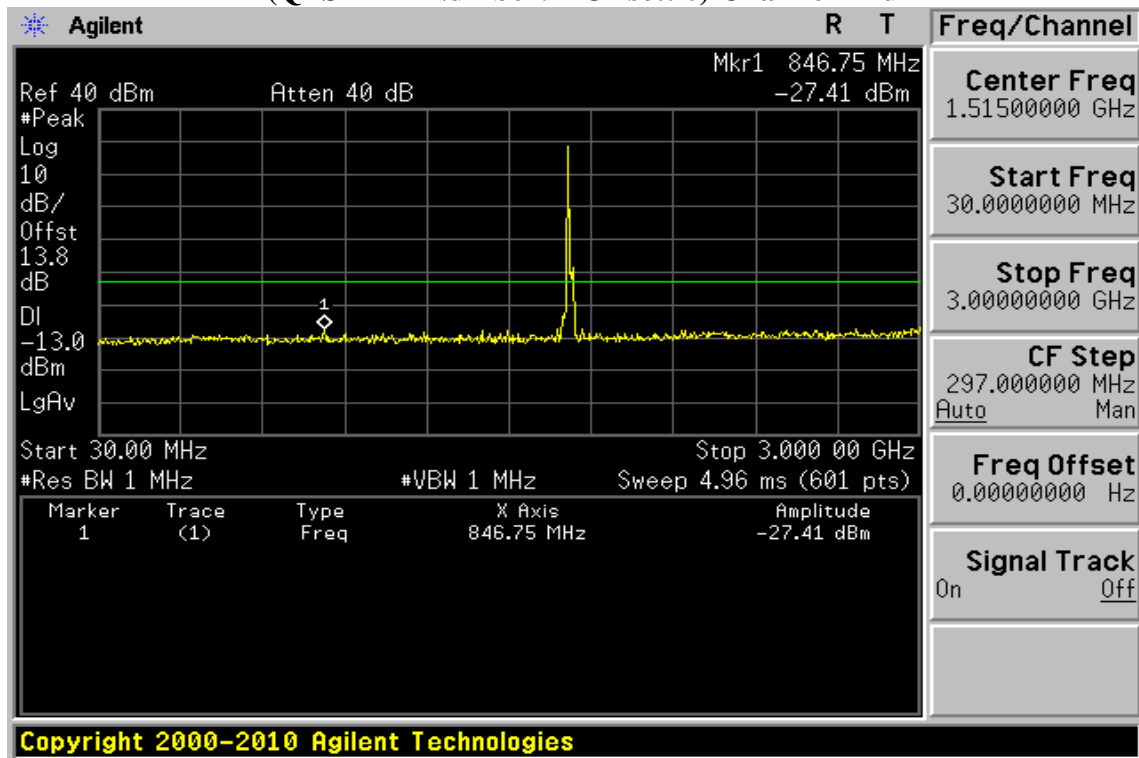

Unless otherwise stated the results shown in this test report refer only to the sample(s) tested and such sample(s) are retained for 90 days only.

除非另有說明，此報告結果僅對測試之樣品負責，同時此樣品僅保留90天。本報告未經本公司書面許可，不可部份複製。

This document is issued by the Company subject to its General Conditions of Service printed overleaf, available on request or accessible at [www.sgs.com/terms\\_and\\_conditions.htm](http://www.sgs.com/terms_and_conditions.htm) and, for electronic format documents, subject to Terms and Conditions for Electronic Documents at [www.sgs.com/terms\\_e-document.htm](http://www.sgs.com/terms_e-document.htm). Attention is drawn to the limitation of liability, indemnification and jurisdiction issues defined therein. Any holder of this document is advised that information contained hereon reflects the Company's findings at the time of its intervention only and within the limits of Client's instructions, if any. The Company's sole responsibility is to its Client and this document does not exonerate parties to a transaction from exercising all their rights and obligations under the transaction documents. This document cannot be reproduced except in full, without prior written approval of the Company. Any unauthorized alteration, forgery or falsification of the content or appearance of this document is unlawful and offenders may be prosecuted to the fullest extent of the law.

**Figure 10-18: Out of Band emission at antenna terminals–10MHz BW LTE-Band 4 (QPSK RB Number: 1 Offset: 0) Channel Highest**

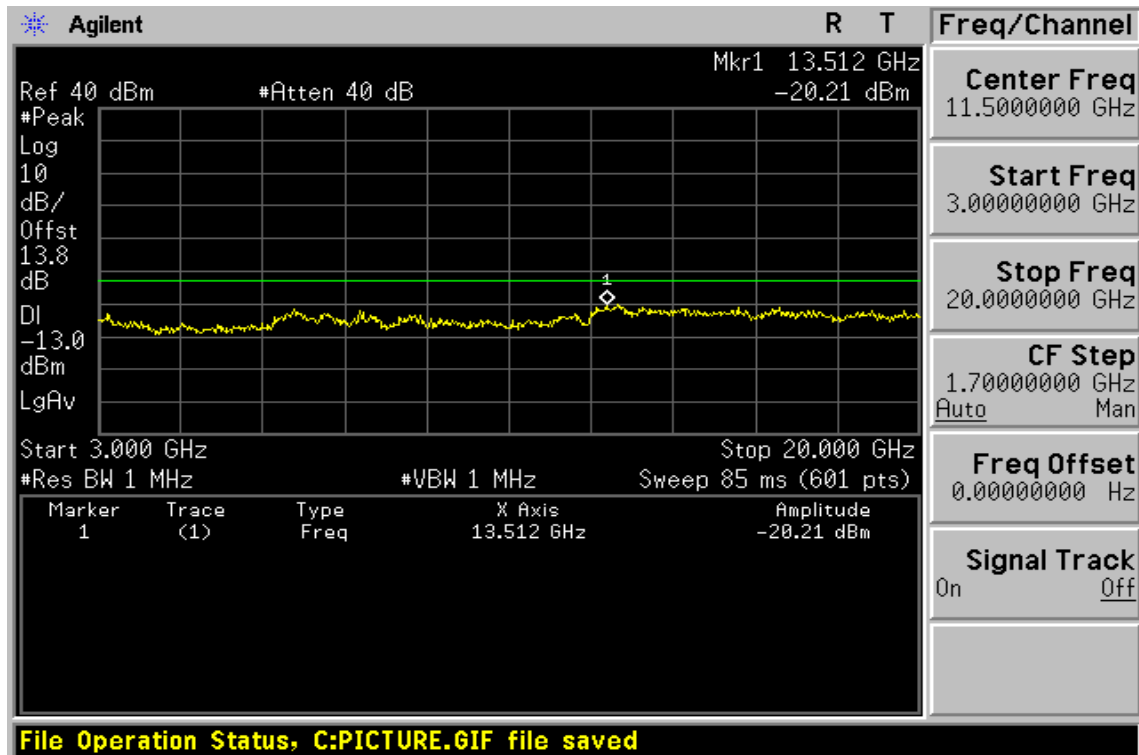
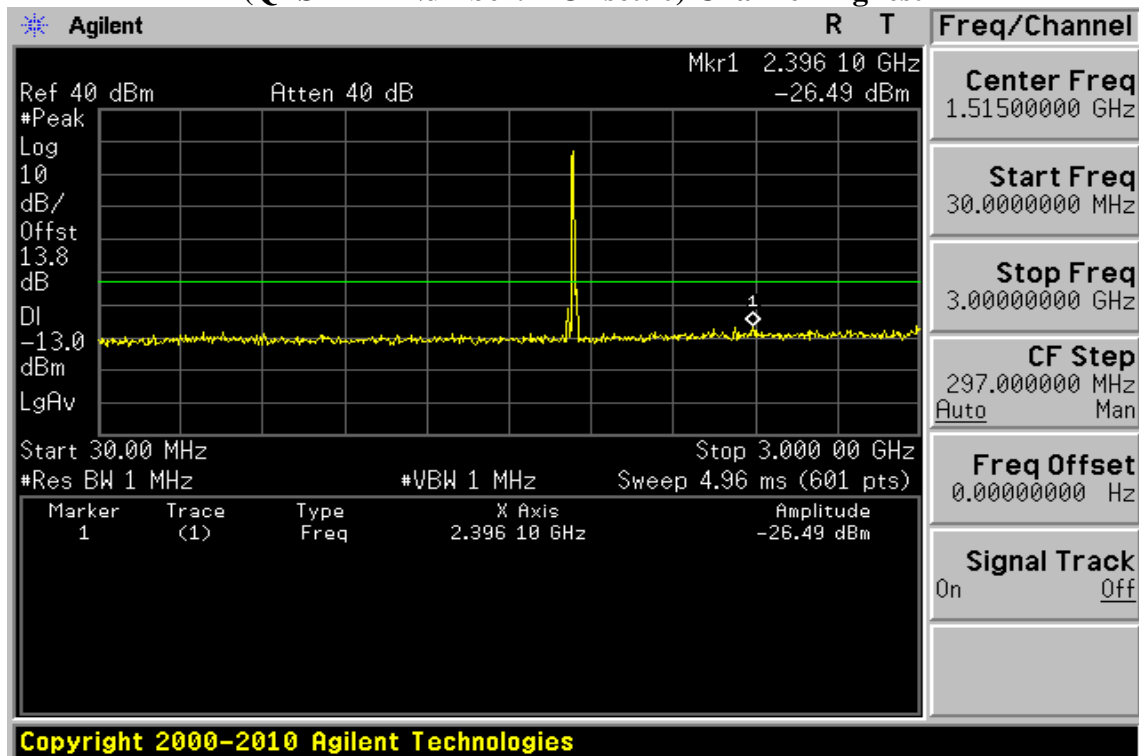

Unless otherwise stated the results shown in this test report refer only to the sample(s) tested and such sample(s) are retained for 90 days only.

除非另有說明，此報告結果僅對測試之樣品負責，同時此樣品僅保留90天。本報告未經本公司書面許可，不可部份複製。

This document is issued by the Company subject to its General Conditions of Service printed overleaf, available on request or accessible at [www.sgs.com/terms\\_and\\_conditions.htm](http://www.sgs.com/terms_and_conditions.htm) and, for electronic format documents, subject to Terms and Conditions for Electronic Documents at [www.sgs.com/terms\\_e-document.htm](http://www.sgs.com/terms_e-document.htm). Attention is drawn to the limitation of liability, indemnification and jurisdiction issues defined therein. Any holder of this document is advised that information contained hereon reflects the Company's findings at the time of its intervention only and within the limits of Client's instructions, if any. The Company's sole responsibility is to its Client and this document does not exonerate parties to a transaction from exercising all their rights and obligations under the transaction documents. This document cannot be reproduced except in full, without prior written approval of the Company. Any unauthorized alteration, forgery or falsification of the content or appearance of this document is unlawful and offenders may be prosecuted to the fullest extent of the law.

**Figure 10-19: Band edge emission at antenna terminals –10MHz BW LTE-Band 4 (QPSK RB Number: 1 Offset: 0) Channel Lowest**

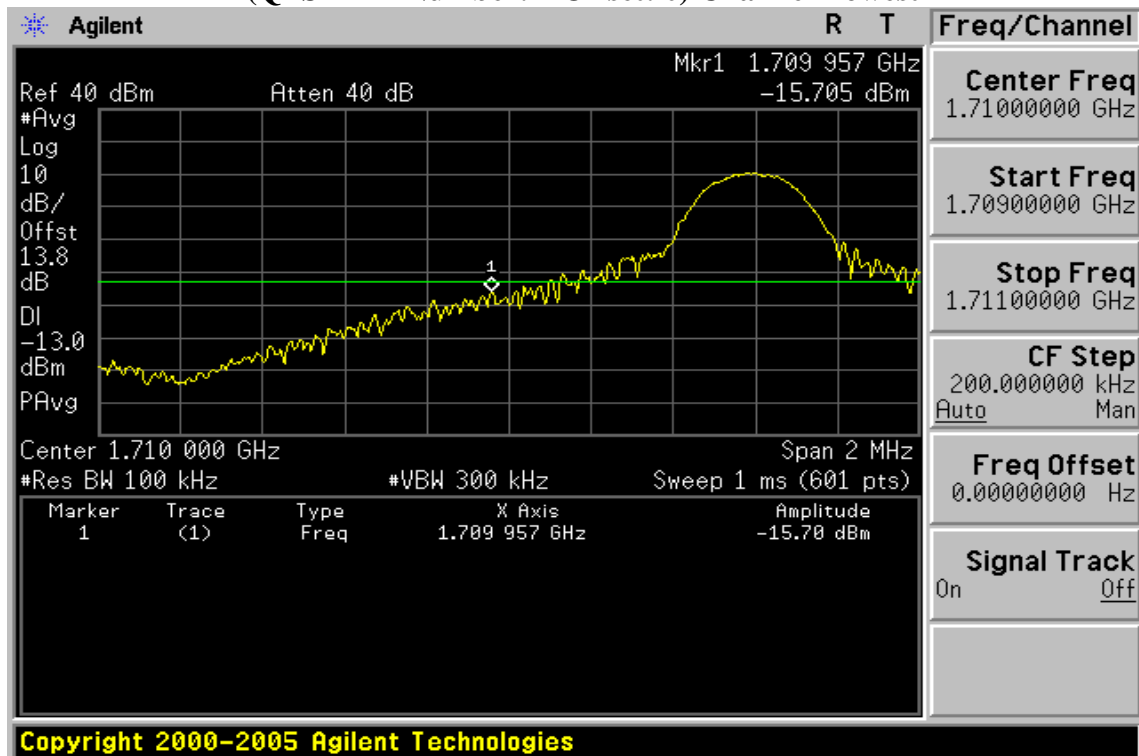

**Figure 10-20: Band edge emission at antenna terminals –10MHz BW LTE-Band 4 (QPSK RB Number: 1 Offset: 49) Channel Highest**



Unless otherwise stated the results shown in this test report refer only to the sample(s) tested and such sample(s) are retained for 90 days only.

除非另有說明，此報告結果僅對測試之樣品負責，同時此樣品僅保留90天。本報告未經本公司書面許可，不可部份複製。

This document is issued by the Company subject to its General Conditions of Service printed overleaf, available on request or accessible at [www.sgs.com/terms\\_and\\_conditions.htm](http://www.sgs.com/terms_and_conditions.htm) and, for electronic format documents, subject to Terms and Conditions for Electronic Documents at [www.sgs.com/terms\\_e-document.htm](http://www.sgs.com/terms_e-document.htm). Attention is drawn to the limitation of liability, indemnification and jurisdiction issues defined therein. Any holder of this document is advised that information contained hereon reflects the Company's findings at the time of its intervention only and within the limits of Client's instructions, if any. The Company's sole responsibility is to its Client and this document does not exonerate parties to a transaction from exercising all their rights and obligations under the transaction documents. This document cannot be reproduced except in full, without prior written approval of the Company. Any unauthorized alteration, forgery or falsification of the content or appearance of this document is unlawful and offenders may be prosecuted to the fullest extent of the law.



**Figure 10-21: Out of Band emission at antenna terminals–15MHz BW LTE-Band 4 (QPSK RB Number: 1 Offset: 0) Channel Lowest**

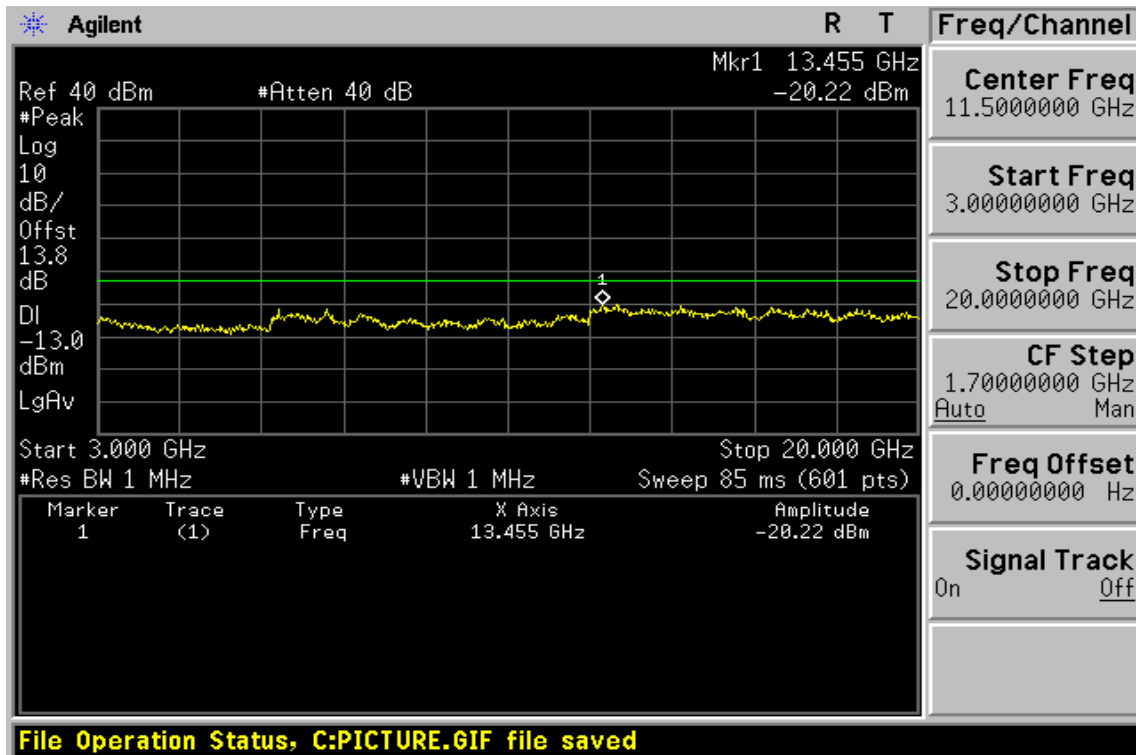
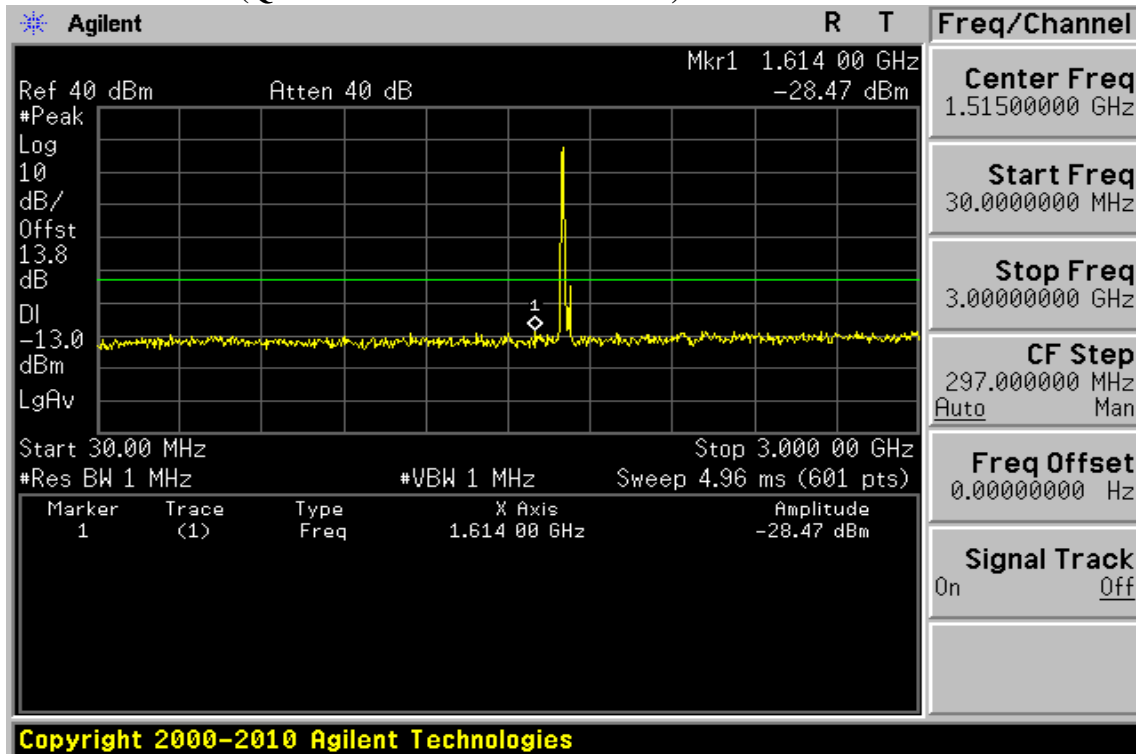

Unless otherwise stated the results shown in this test report refer only to the sample(s) tested and such sample(s) are retained for 90 days only.

除非另有說明，此報告結果僅對測試之樣品負責，同時此樣品僅保留90天。本報告未經本公司書面許可，不可部份複製。

This document is issued by the Company subject to its General Conditions of Service printed overleaf, available on request or accessible at [www.sgs.com/terms\\_and\\_conditions.htm](http://www.sgs.com/terms_and_conditions.htm) and, for electronic format documents, subject to Terms and Conditions for Electronic Documents at [www.sgs.com/terms\\_e-document.htm](http://www.sgs.com/terms_e-document.htm). Attention is drawn to the limitation of liability, indemnification and jurisdiction issues defined therein. Any holder of this document is advised that information contained hereon reflects the Company's findings at the time of its intervention only and within the limits of Client's instructions, if any. The Company's sole responsibility is to its Client and this document does not exonerate parties to a transaction from exercising all their rights and obligations under the transaction documents. This document cannot be reproduced except in full, without prior written approval of the Company. Any unauthorized alteration, forgery or falsification of the content or appearance of this document is unlawful and offenders may be prosecuted to the fullest extent of the law.

**Figure 10-22: Out of Band emission at antenna terminals –15MHz BW LTE-Band 4 (QPSK RB Number: 1 Offset: 0) Channel Mid**

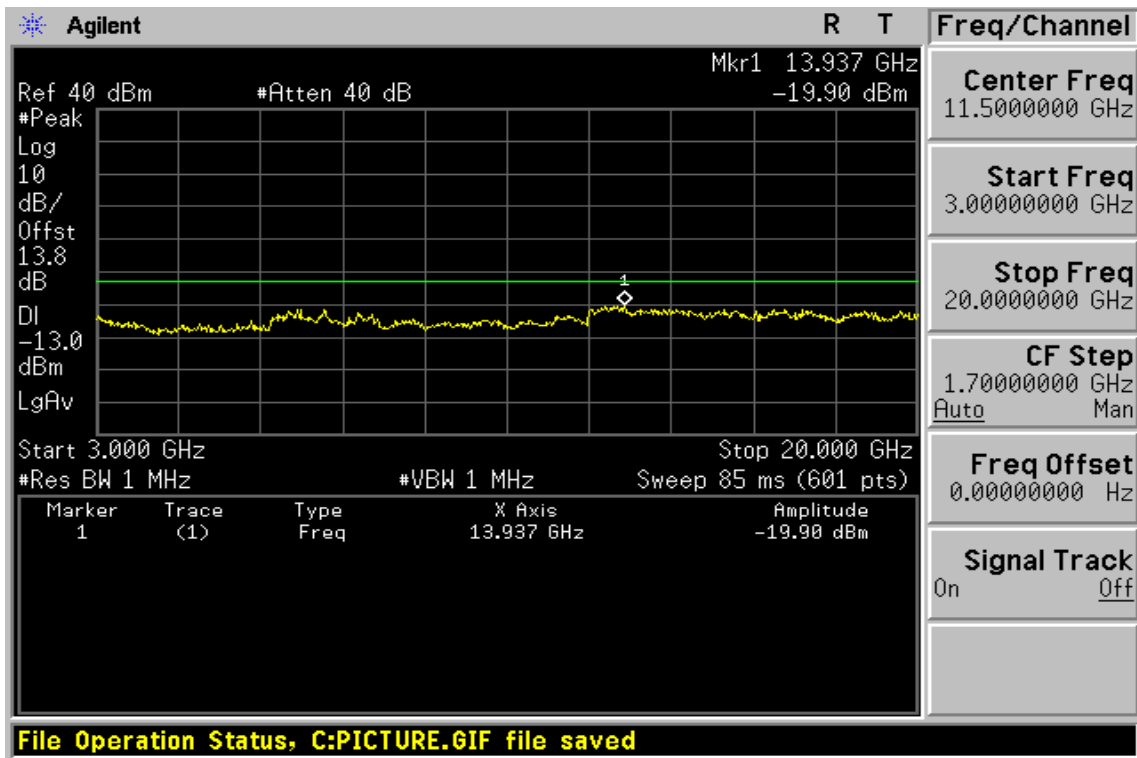
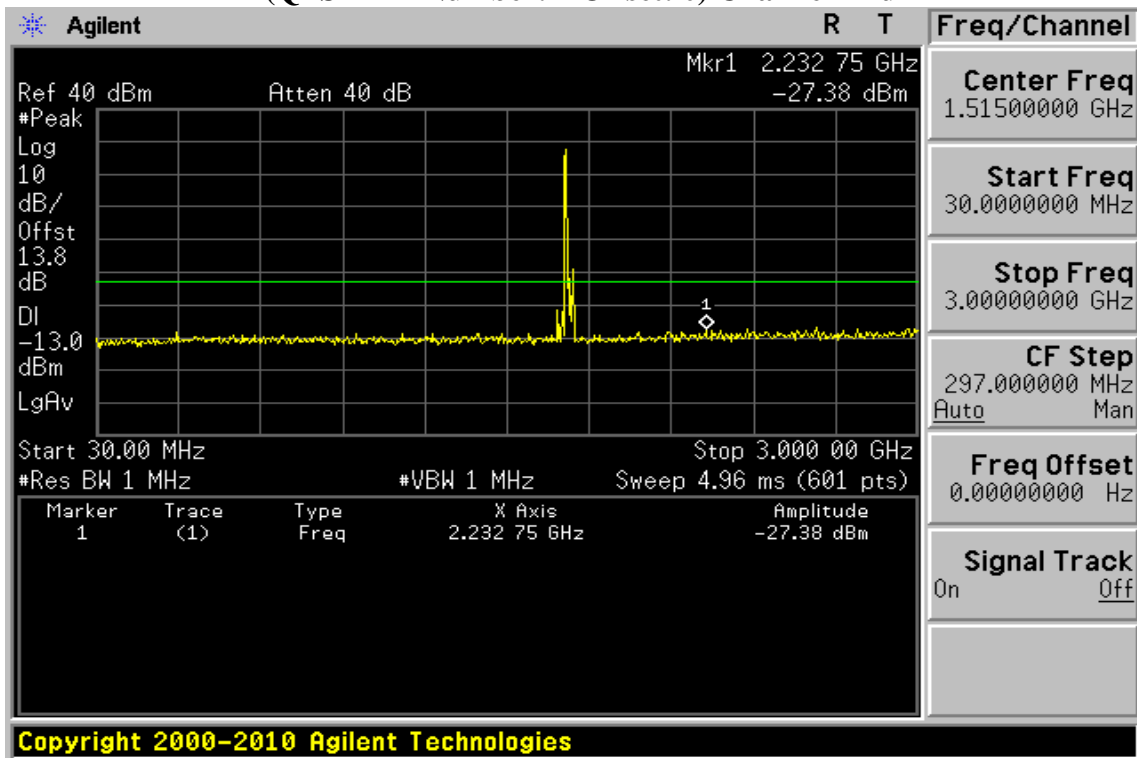

Unless otherwise stated the results shown in this test report refer only to the sample(s) tested and such sample(s) are retained for 90 days only.

除非另有說明，此報告結果僅對測試之樣品負責，同時此樣品僅保留90天。本報告未經本公司書面許可，不可部份複製。

This document is issued by the Company subject to its General Conditions of Service printed overleaf, available on request or accessible at [www.sgs.com/terms\\_and\\_conditions.htm](http://www.sgs.com/terms_and_conditions.htm) and, for electronic format documents, subject to Terms and Conditions for Electronic Documents at [www.sgs.com/terms\\_e-document.htm](http://www.sgs.com/terms_e-document.htm). Attention is drawn to the limitation of liability, indemnification and jurisdiction issues defined therein. Any holder of this document is advised that information contained hereon reflects the Company's findings at the time of its intervention only and within the limits of Client's instructions, if any. The Company's sole responsibility is to its Client and this document does not exonerate parties to a transaction from exercising all their rights and obligations under the transaction documents. This document cannot be reproduced except in full, without prior written approval of the Company. Any unauthorized alteration, forgery or falsification of the content or appearance of this document is unlawful and offenders may be prosecuted to the fullest extent of the law.

**Figure 10-23: Out of Band emission at antenna terminals–15MHz BW LTE-Band 4 (QPSK RB Number: 1 Offset: 0) Channel Highest**

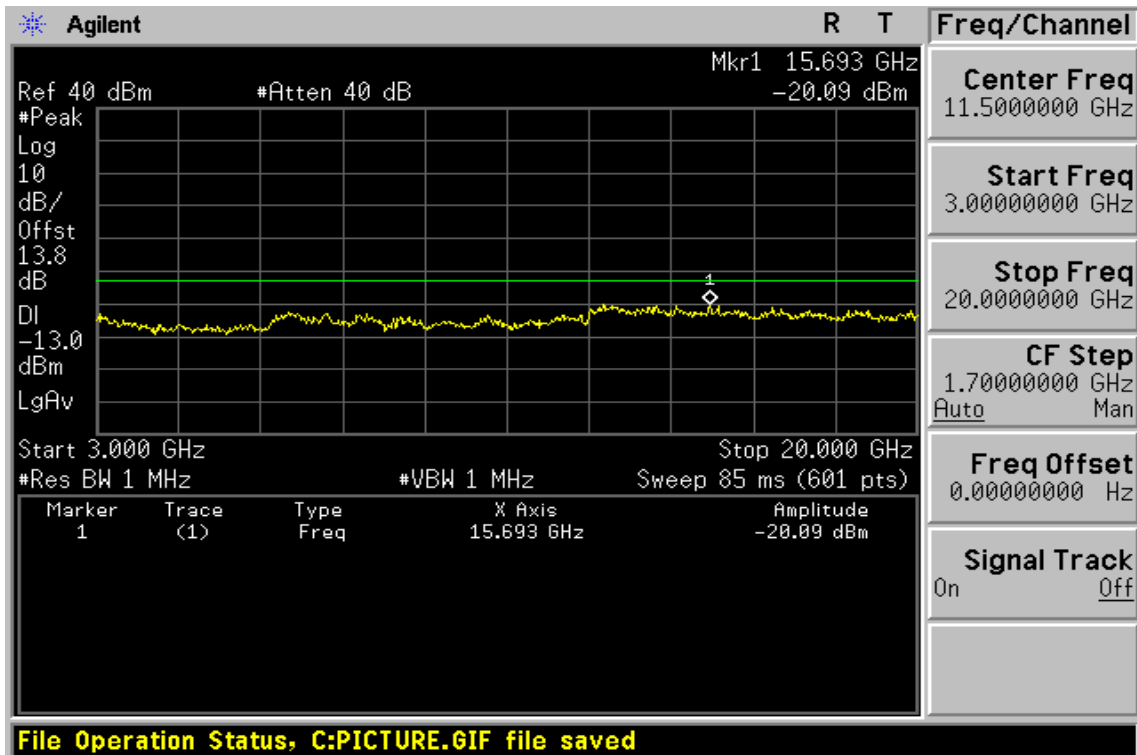
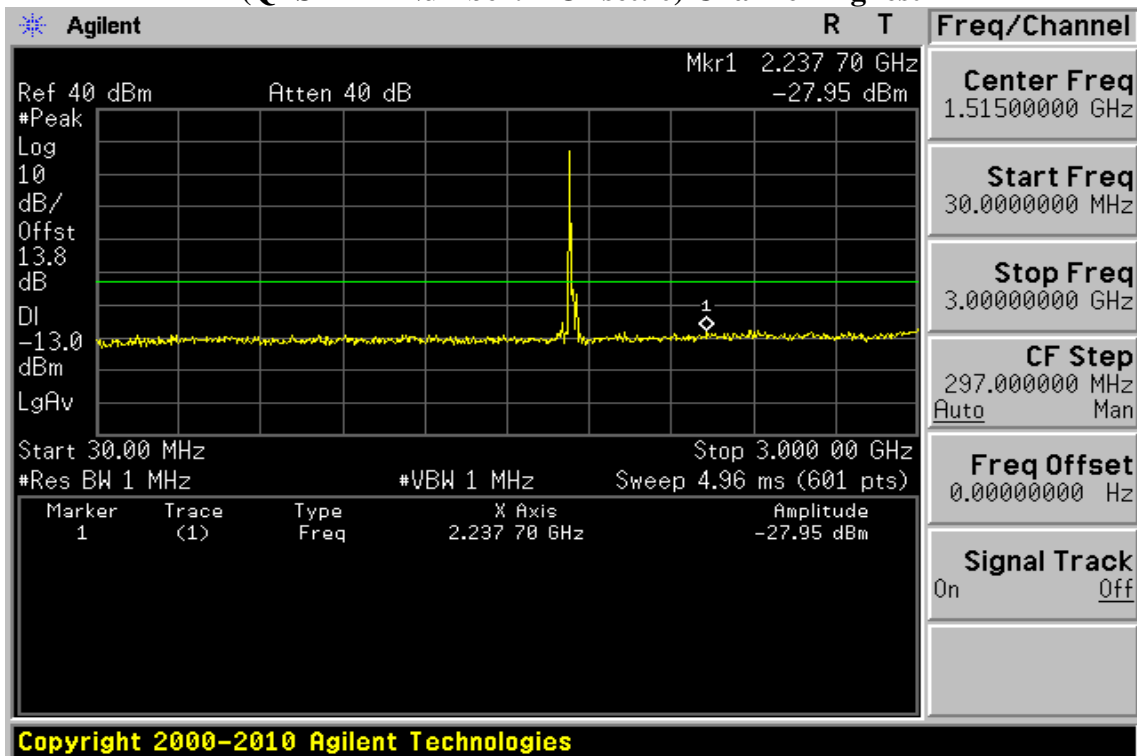

Unless otherwise stated the results shown in this test report refer only to the sample(s) tested and such sample(s) are retained for 90 days only.

除非另有說明，此報告結果僅對測試之樣品負責，同時此樣品僅保留90天。本報告未經本公司書面許可，不可部份複製。

This document is issued by the Company subject to its General Conditions of Service printed overleaf, available on request or accessible at [www.sgs.com/terms\\_and\\_conditions.htm](http://www.sgs.com/terms_and_conditions.htm) and, for electronic format documents, subject to Terms and Conditions for Electronic Documents at [www.sgs.com/terms\\_e-document.htm](http://www.sgs.com/terms_e-document.htm). Attention is drawn to the limitation of liability, indemnification and jurisdiction issues defined therein. Any holder of this document is advised that information contained hereon reflects the Company's findings at the time of its intervention only and within the limits of Client's instructions, if any. The Company's sole responsibility is to its Client and this document does not exonerate parties to a transaction from exercising all their rights and obligations under the transaction documents. This document cannot be reproduced except in full, without prior written approval of the Company. Any unauthorized alteration, forgery or falsification of the content or appearance of this document is unlawful and offenders may be prosecuted to the fullest extent of the law.

**Figure 10-24: Band edge emission at antenna terminals –15MHz BW LTE-Band 4 (QPSK RB Number: 1 Offset: 0) Channel Lowest**

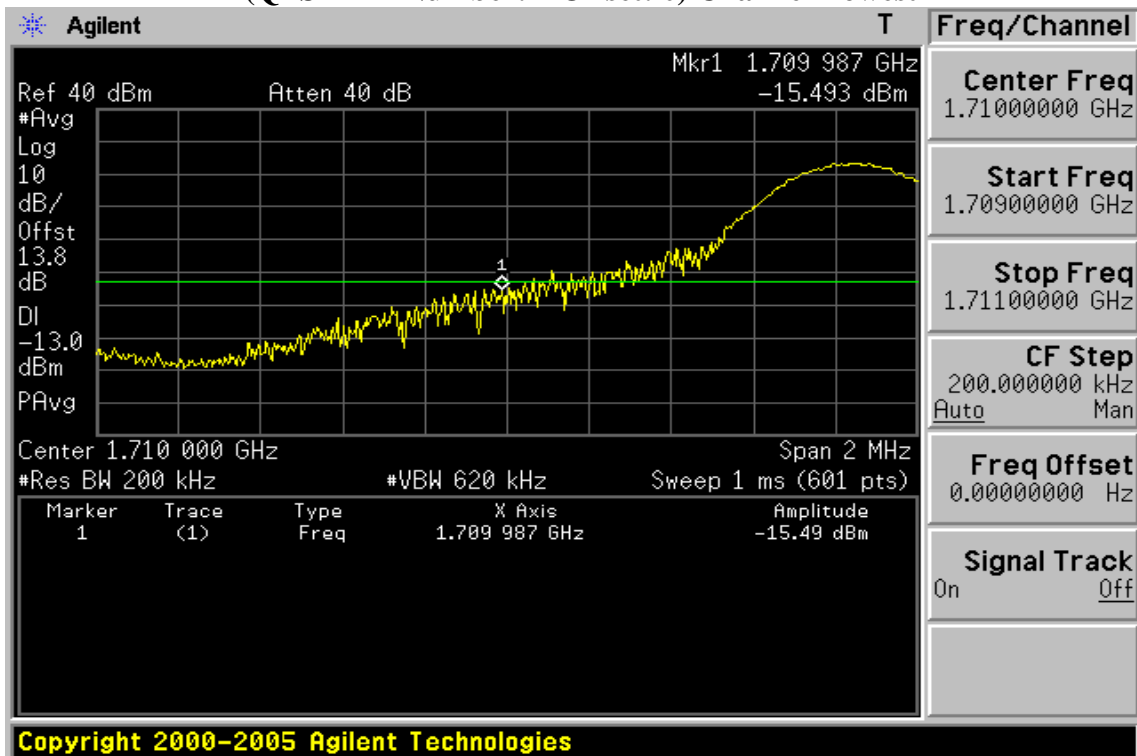

**Figure 10-25: Band edge emission at antenna terminals –15MHz BW LTE-Band 4 (QPSK RB Number: 1 Offset: 74) Channel Highest**

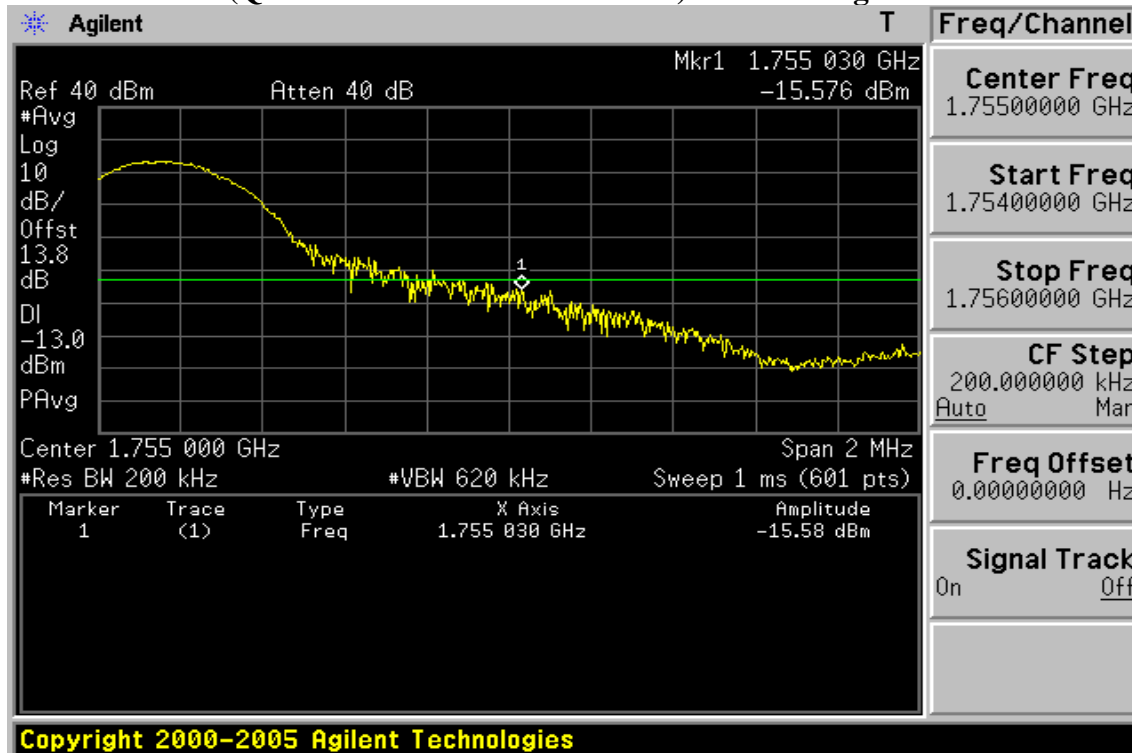

Unless otherwise stated the results shown in this test report refer only to the sample(s) tested and such sample(s) are retained for 90 days only.

除非另有說明，此報告結果僅對測試之樣品負責，同時此樣品僅保留90天。本報告未經本公司書面許可，不可部份複製。

This document is issued by the Company subject to its General Conditions of Service printed overleaf, available on request or accessible at [www.sgs.com/terms\\_and\\_conditions.htm](http://www.sgs.com/terms_and_conditions.htm) and, for electronic format documents, subject to Terms and Conditions for Electronic Documents at [www.sgs.com/terms\\_e-document.htm](http://www.sgs.com/terms_e-document.htm). Attention is drawn to the limitation of liability, indemnification and jurisdiction issues defined therein. Any holder of this document is advised that information contained hereon reflects the Company's findings at the time of its intervention only and within the limits of Client's instructions, if any. The Company's sole responsibility is to its Client and this document does not exonerate parties to a transaction from exercising all their rights and obligations under the transaction documents. This document cannot be reproduced except in full, without prior written approval of the Company. Any unauthorized alteration, forgery or falsification of the content or appearance of this document is unlawful and offenders may be prosecuted to the fullest extent of the law.

**Figure 10-26: Out of Band emission at antenna terminals–20MHz BW LTE-Band 4 (QPSK RB Number: 1 Offset: 99) Channel Lowest**

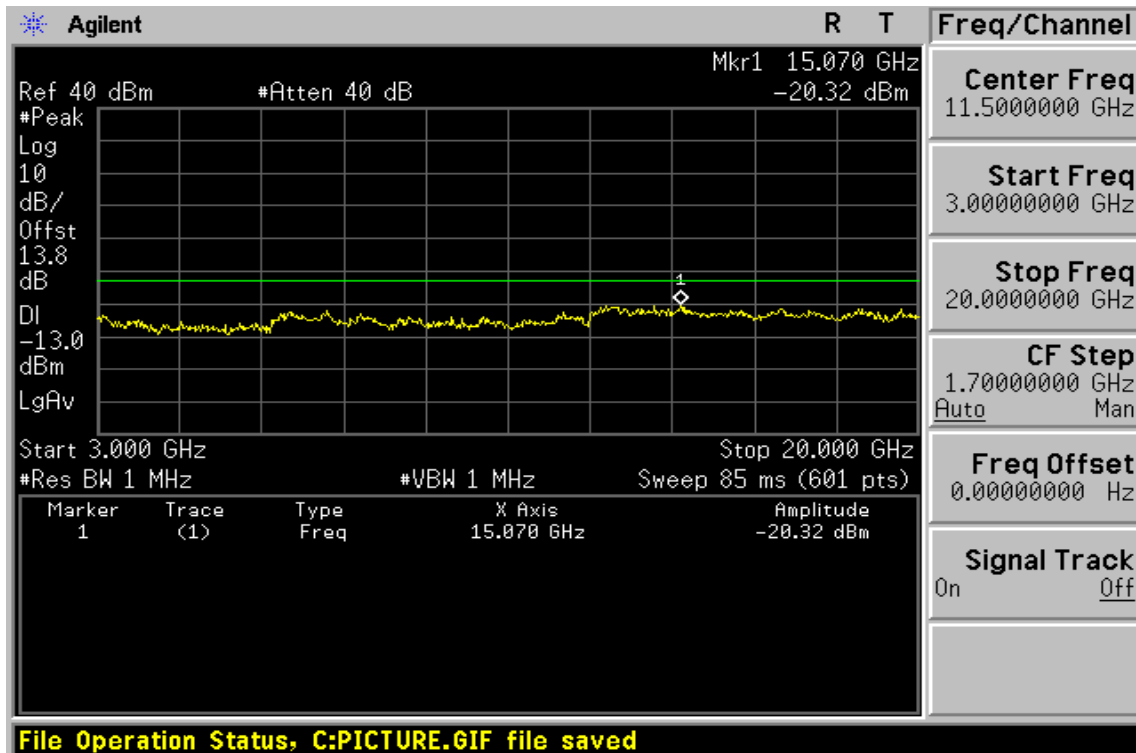
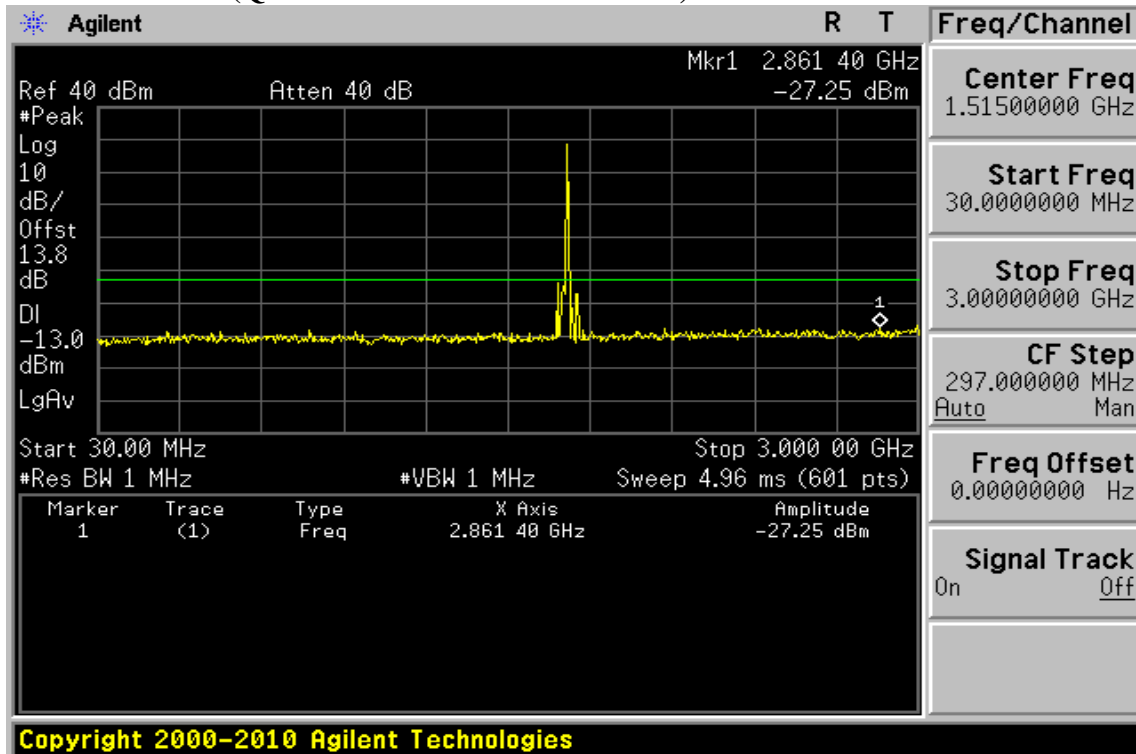

Unless otherwise stated the results shown in this test report refer only to the sample(s) tested and such sample(s) are retained for 90 days only.

除非另有說明，此報告結果僅對測試之樣品負責，同時此樣品僅保留90天。本報告未經本公司書面許可，不可部份複製。

This document is issued by the Company subject to its General Conditions of Service printed overleaf, available on request or accessible at [www.sgs.com/terms\\_and\\_conditions.htm](http://www.sgs.com/terms_and_conditions.htm) and, for electronic format documents, subject to Terms and Conditions for Electronic Documents at [www.sgs.com/terms\\_e-document.htm](http://www.sgs.com/terms_e-document.htm). Attention is drawn to the limitation of liability, indemnification and jurisdiction issues defined therein. Any holder of this document is advised that information contained hereon reflects the Company's findings at the time of its intervention only and within the limits of Client's instructions, if any. The Company's sole responsibility is to its Client and this document does not exonerate parties to a transaction from exercising all their rights and obligations under the transaction documents. This document cannot be reproduced except in full, without prior written approval of the Company. Any unauthorized alteration, forgery or falsification of the content or appearance of this document is unlawful and offenders may be prosecuted to the fullest extent of the law.

**Figure 10-27: Out of Band emission at antenna terminals –20MHz BW LTE-Band 4 (QPSK RB Number: 1 Offset: 99) Channel Mid**

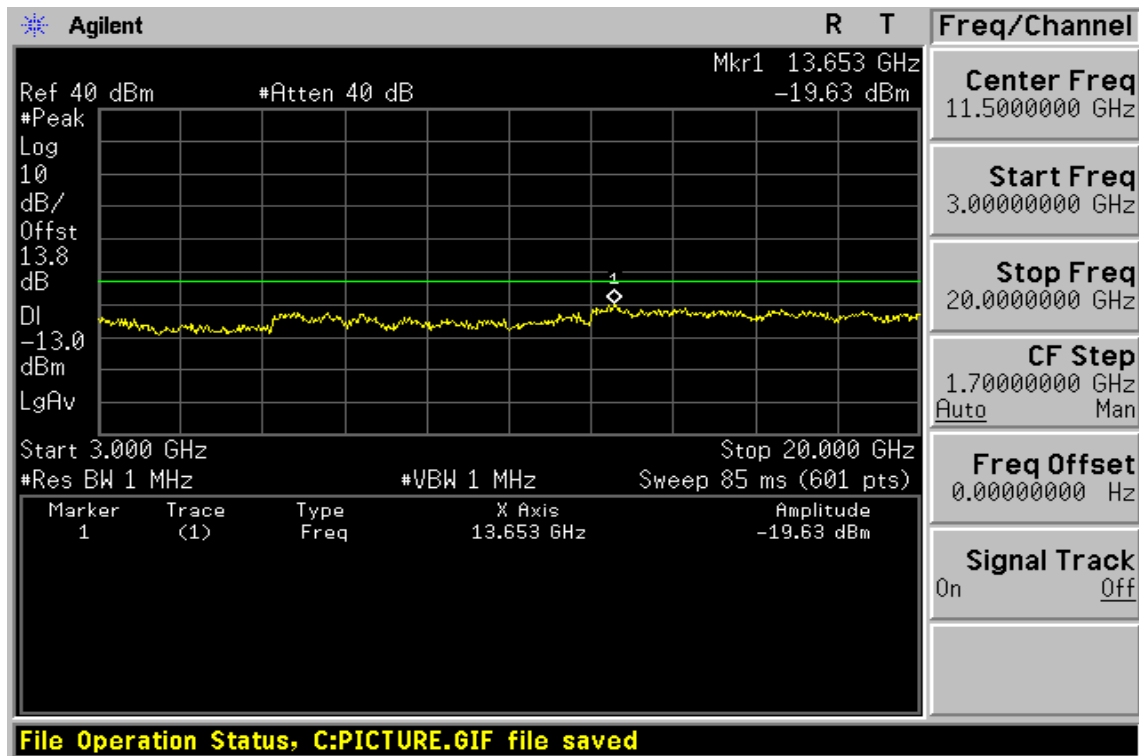
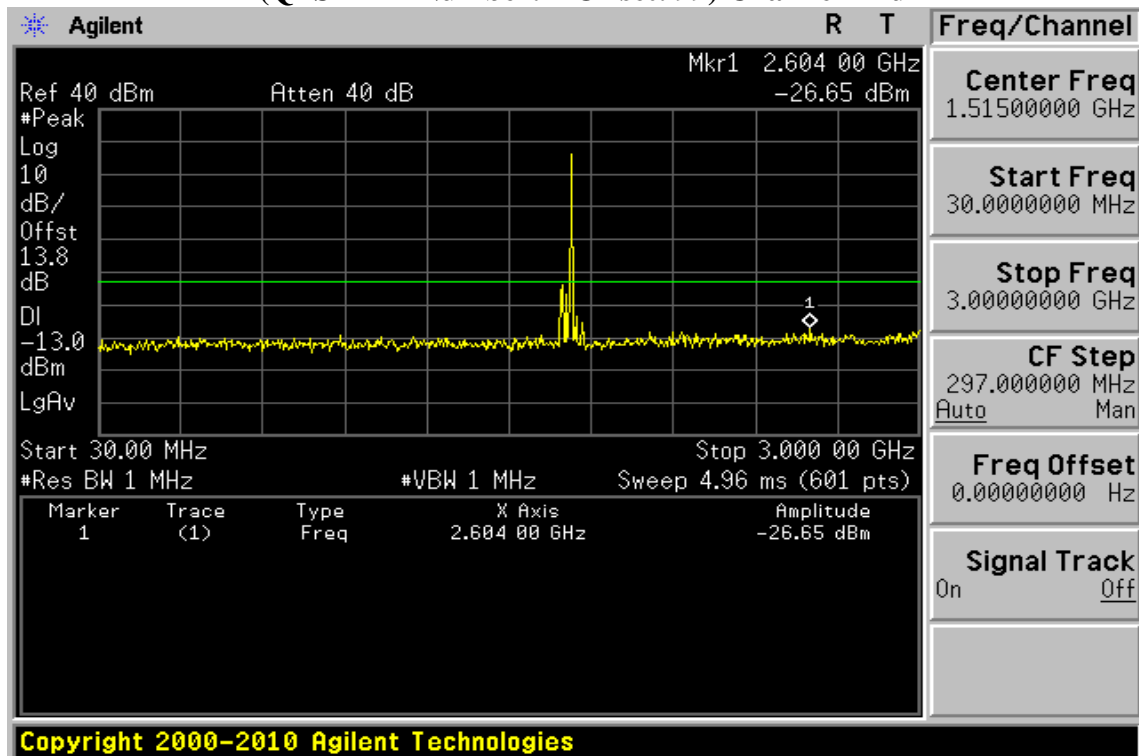

Unless otherwise stated the results shown in this test report refer only to the sample(s) tested and such sample(s) are retained for 90 days only.

除非另有說明，此報告結果僅對測試之樣品負責，同時此樣品僅保留90天。本報告未經本公司書面許可，不可部份複製。

This document is issued by the Company subject to its General Conditions of Service printed overleaf, available on request or accessible at [www.sgs.com/terms\\_and\\_conditions.htm](http://www.sgs.com/terms_and_conditions.htm) and, for electronic format documents, subject to Terms and Conditions for Electronic Documents at [www.sgs.com/terms\\_e-document.htm](http://www.sgs.com/terms_e-document.htm). Attention is drawn to the limitation of liability, indemnification and jurisdiction issues defined therein. Any holder of this document is advised that information contained hereon reflects the Company's findings at the time of its intervention only and within the limits of Client's instructions, if any. The Company's sole responsibility is to its Client and this document does not exonerate parties to a transaction from exercising all their rights and obligations under the transaction documents. This document cannot be reproduced except in full, without prior written approval of the Company. Any unauthorized alteration, forgery or falsification of the content or appearance of this document is unlawful and offenders may be prosecuted to the fullest extent of the law.

**Figure 10-28: Out of Band emission at antenna terminals–20MHz BW LTE-Band 4 (QPSK RB Number: 1 Offset: 99) Channel Highest**

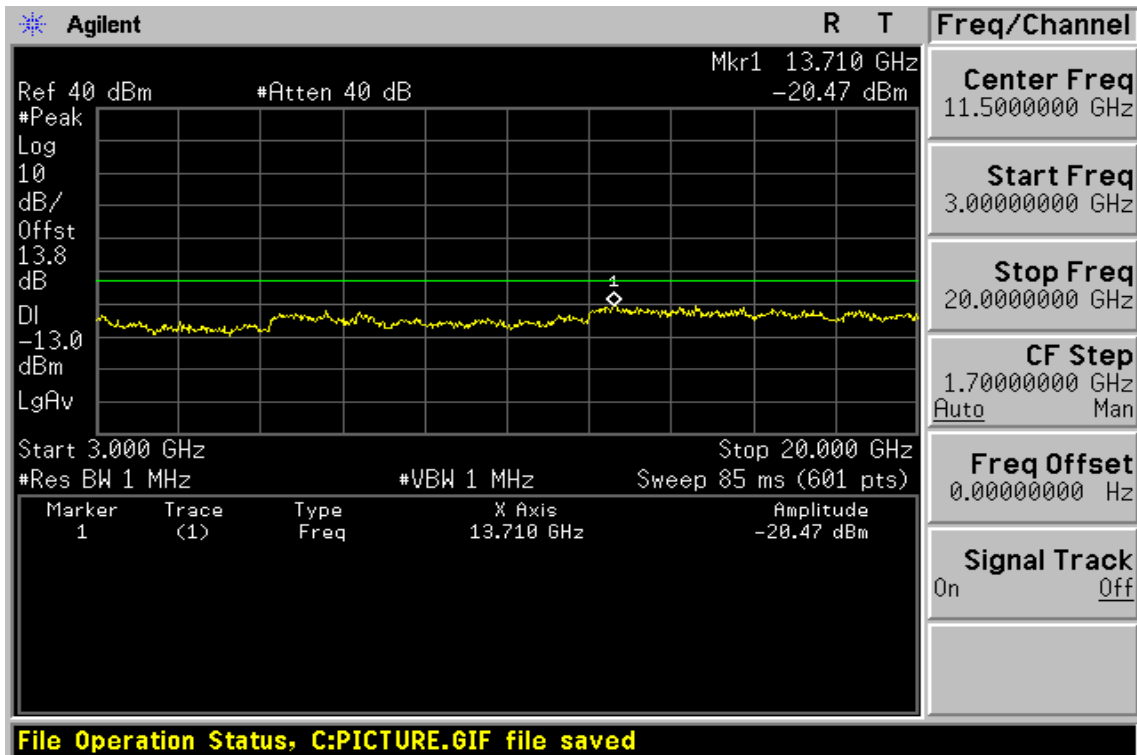
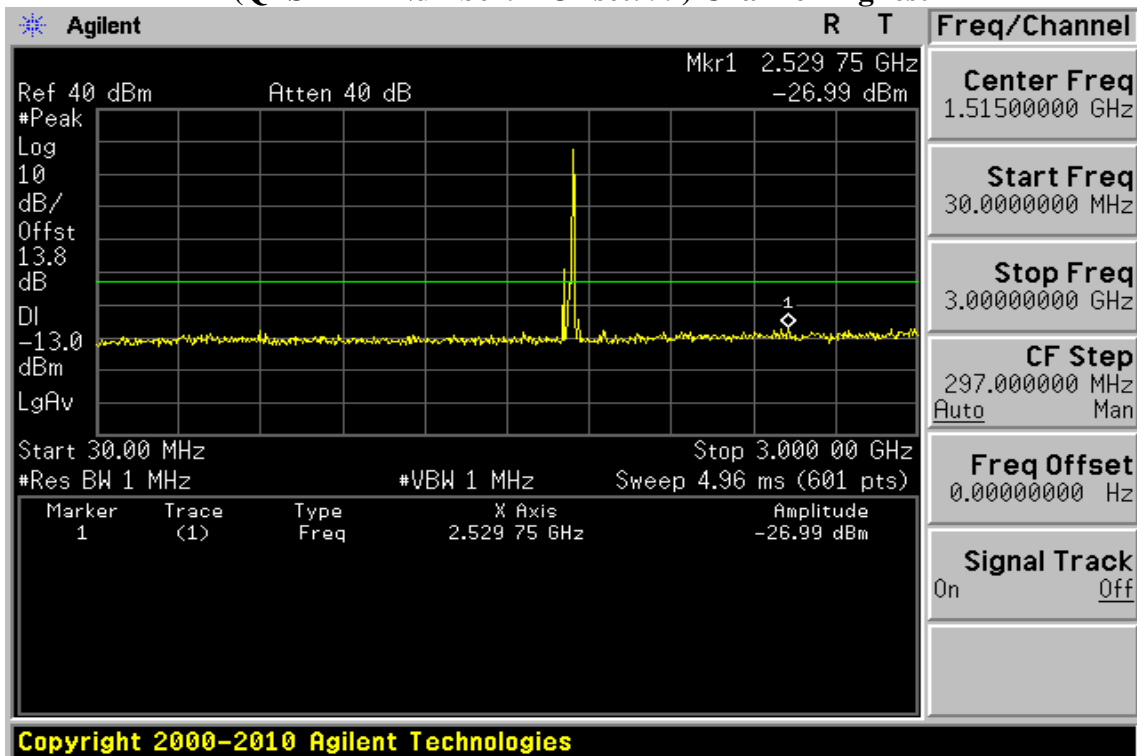

Unless otherwise stated the results shown in this test report refer only to the sample(s) tested and such sample(s) are retained for 90 days only.

除非另有說明，此報告結果僅對測試之樣品負責，同時此樣品僅保留90天。本報告未經本公司書面許可，不可部份複製。

This document is issued by the Company subject to its General Conditions of Service printed overleaf, available on request or accessible at [www.sgs.com/terms\\_and\\_conditions.htm](http://www.sgs.com/terms_and_conditions.htm) and, for electronic format documents, subject to Terms and Conditions for Electronic Documents at [www.sgs.com/terms\\_e-document.htm](http://www.sgs.com/terms_e-document.htm). Attention is drawn to the limitation of liability, indemnification and jurisdiction issues defined therein. Any holder of this document is advised that information contained hereon reflects the Company's findings at the time of its intervention only and within the limits of Client's instructions, if any. The Company's sole responsibility is to its Client and this document does not exonerate parties to a transaction from exercising all their rights and obligations under the transaction documents. This document cannot be reproduced except in full, without prior written approval of the Company. Any unauthorized alteration, forgery or falsification of the content or appearance of this document is unlawful and offenders may be prosecuted to the fullest extent of the law.

**Figure 10-29: Band edge emission at antenna terminals –20MHz BW LTE-Band 4 (QPSK RB Number: 1 Offset: 0) Channel Lowest**

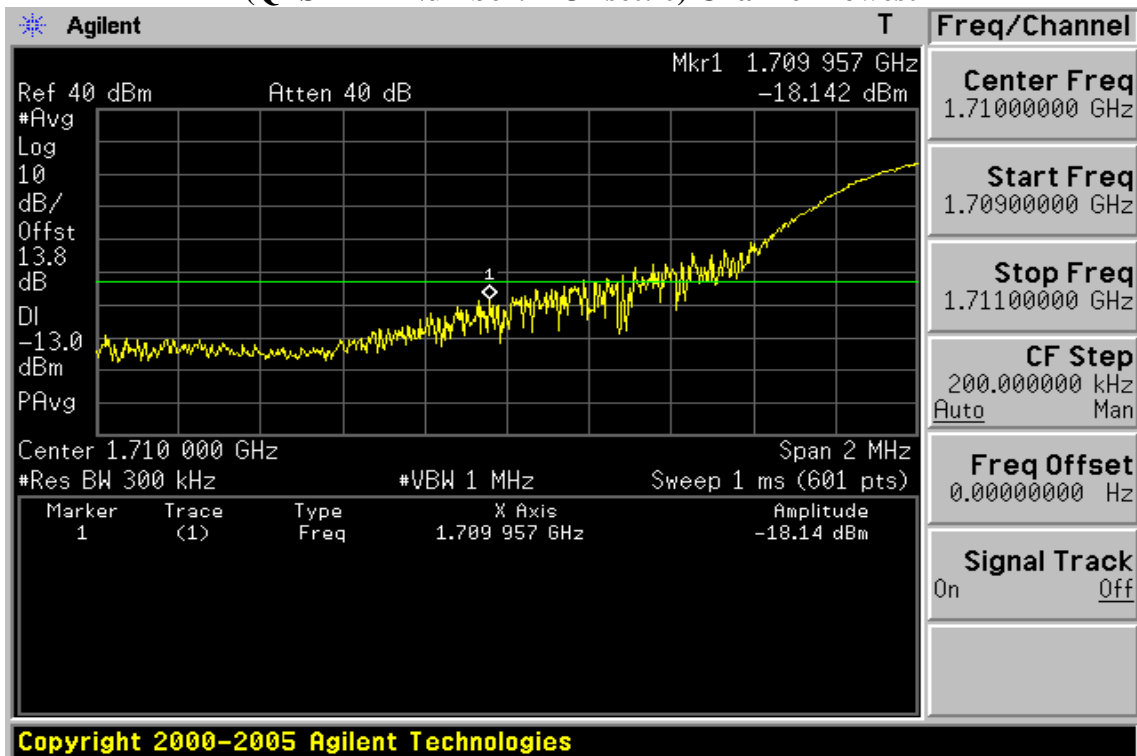

**Figure 10-30: Band edge emission at antenna terminals –10MHz BW LTE-Band 4 (QPSK RB Number: 1 Offset: 99) Channel Highest**

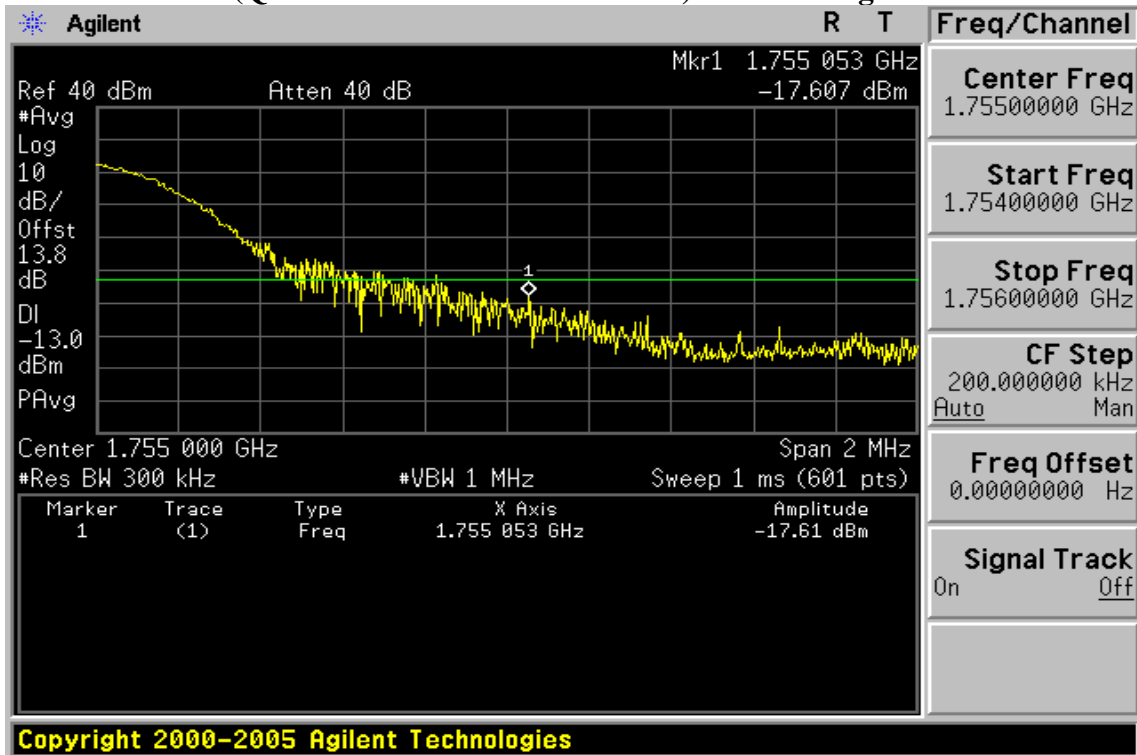

Unless otherwise stated the results shown in this test report refer only to the sample(s) tested and such sample(s) are retained for 90 days only.

除非另有說明，此報告結果僅對測試之樣品負責，同時此樣品僅保留90天。本報告未經本公司書面許可，不可部份複製。

This document is issued by the Company subject to its General Conditions of Service printed overleaf, available on request or accessible at [www.sgs.com/terms\\_and\\_conditions.htm](http://www.sgs.com/terms_and_conditions.htm) and, for electronic format documents, subject to Terms and Conditions for Electronic Documents at [www.sgs.com/terms\\_e-document.htm](http://www.sgs.com/terms_e-document.htm). Attention is drawn to the limitation of liability, indemnification and jurisdiction issues defined therein. Any holder of this document is advised that information contained hereon reflects the Company's findings at the time of its intervention only and within the limits of Client's instructions, if any. The Company's sole responsibility is to its Client and this document does not exonerate parties to a transaction from exercising all their rights and obligations under the transaction documents. This document cannot be reproduced except in full, without prior written approval of the Company. Any unauthorized alteration, forgery or falsification of the content or appearance of this document is unlawful and offenders may be prosecuted to the fullest extent of the law.



**Figure 10-31: Out of Band emission at antenna terminals–5MHz BW LTE-Band 13 (QPSK RB Number: 1 Offset: 0) Channel Lowest**

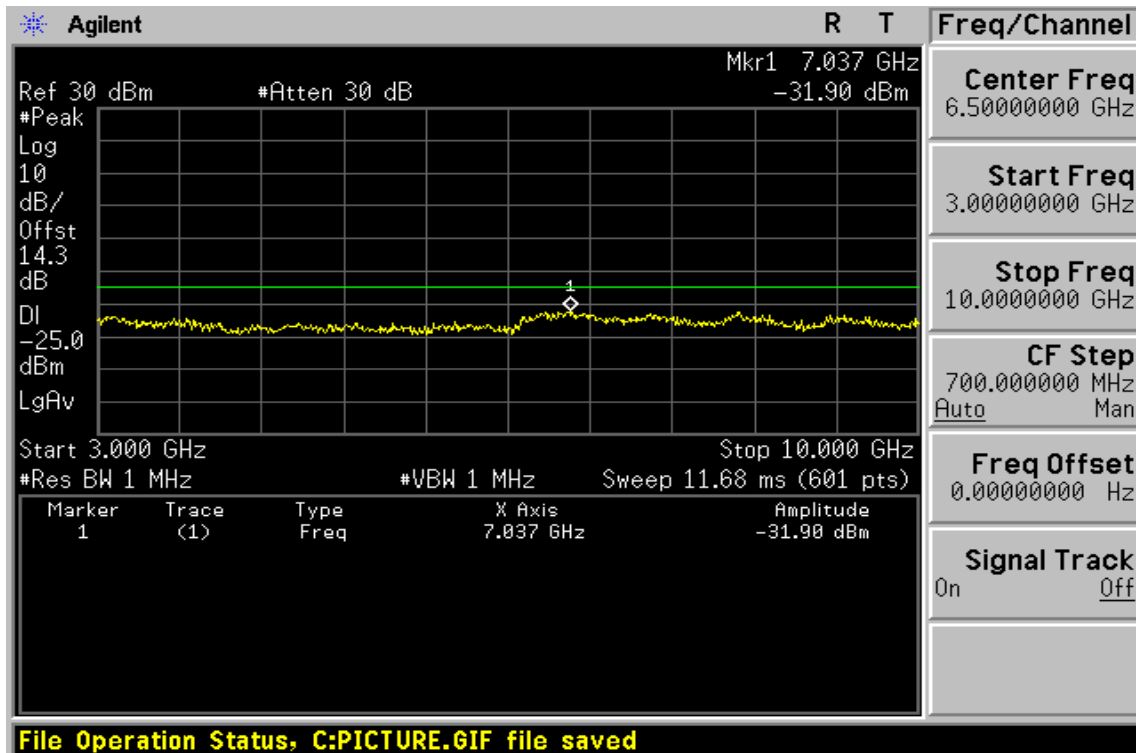
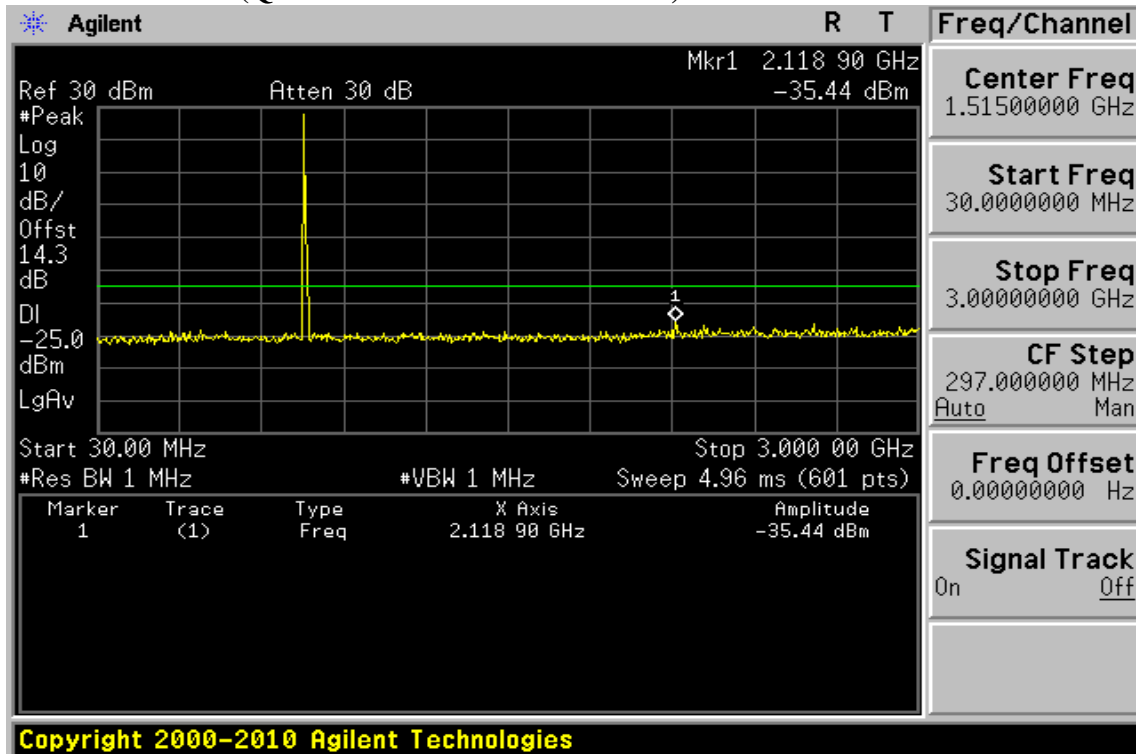

Unless otherwise stated the results shown in this test report refer only to the sample(s) tested and such sample(s) are retained for 90 days only.

除非另有說明，此報告結果僅對測試之樣品負責，同時此樣品僅保留90天。本報告未經本公司書面許可，不可部份複製。

This document is issued by the Company subject to its General Conditions of Service printed overleaf, available on request or accessible at [www.sgs.com/terms\\_and\\_conditions.htm](http://www.sgs.com/terms_and_conditions.htm) and, for electronic format documents, subject to Terms and Conditions for Electronic Documents at [www.sgs.com/terms\\_e-document.htm](http://www.sgs.com/terms_e-document.htm). Attention is drawn to the limitation of liability, indemnification and jurisdiction issues defined therein. Any holder of this document is advised that information contained hereon reflects the Company's findings at the time of its intervention only and within the limits of Client's instructions, if any. The Company's sole responsibility is to its Client and this document does not exonerate parties to a transaction from exercising all their rights and obligations under the transaction documents. This document cannot be reproduced except in full, without prior written approval of the Company. Any unauthorized alteration, forgery or falsification of the content or appearance of this document is unlawful and offenders may be prosecuted to the fullest extent of the law.

**Figure 10-32: Out of Band emission at antenna terminals –5MHz BW LTE-Band 13 (QPSK RB Number: 1 Offset: 0) Channel Mid**

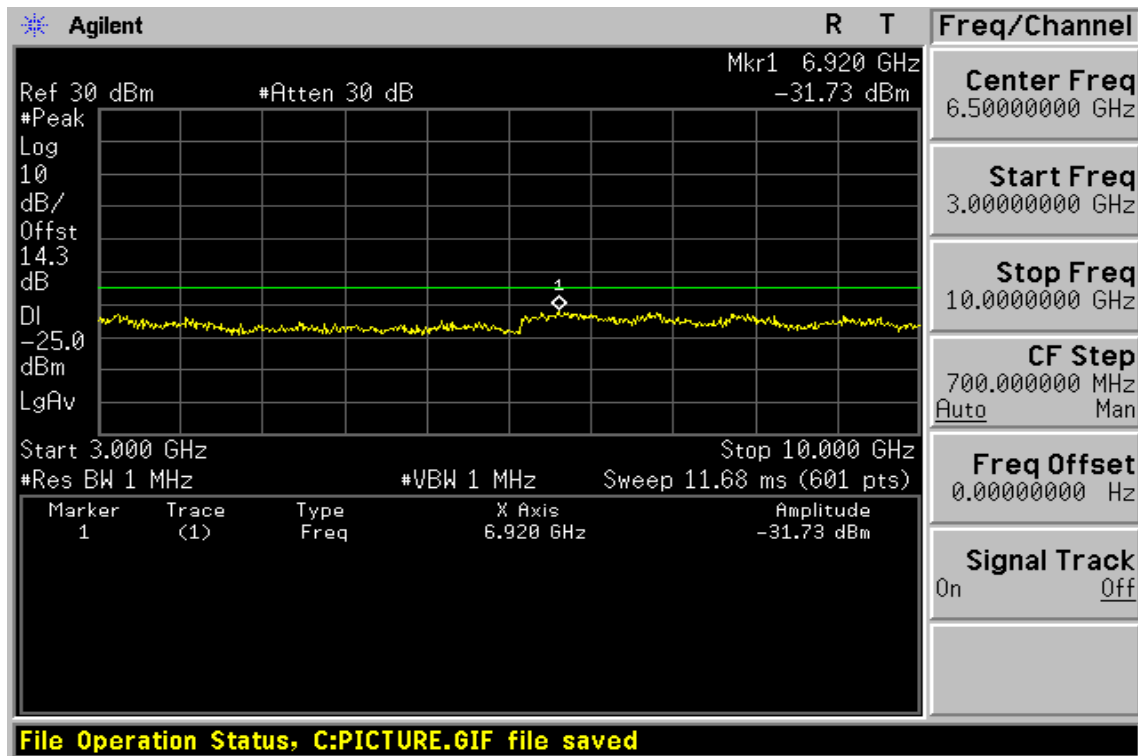
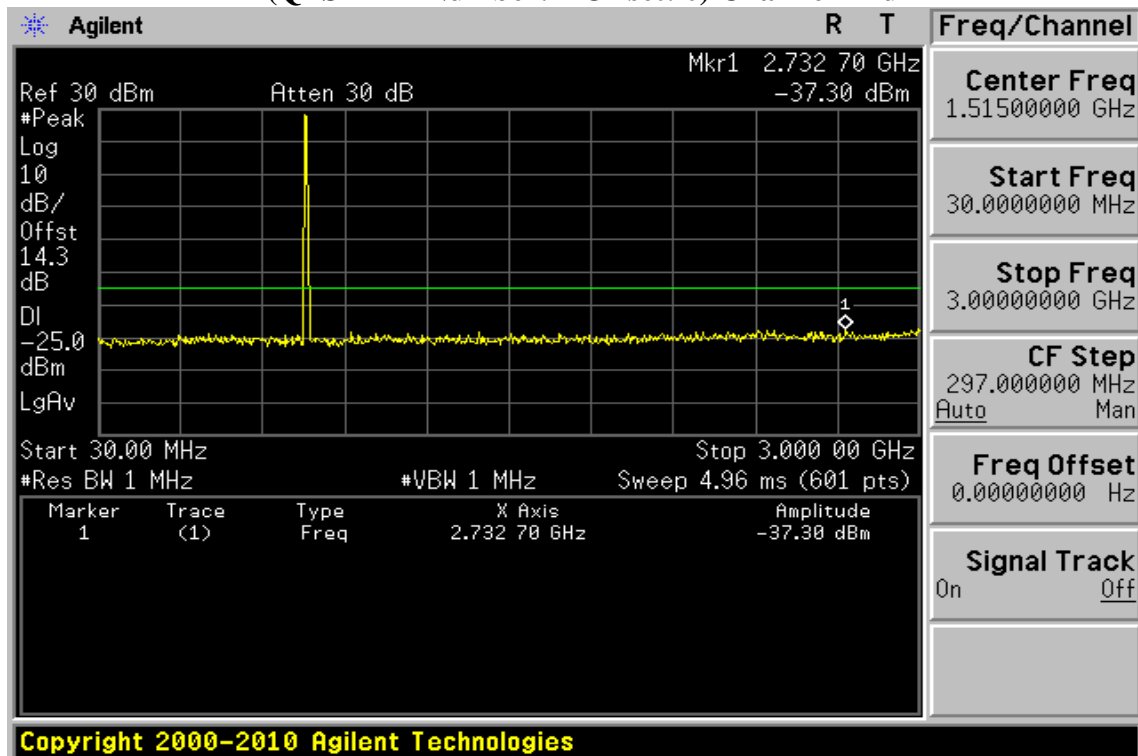

Unless otherwise stated the results shown in this test report refer only to the sample(s) tested and such sample(s) are retained for 90 days only.

除非另有說明，此報告結果僅對測試之樣品負責，同時此樣品僅保留90天。本報告未經本公司書面許可，不可部份複製。

This document is issued by the Company subject to its General Conditions of Service printed overleaf, available on request or accessible at [www.sgs.com/terms\\_and\\_conditions.htm](http://www.sgs.com/terms_and_conditions.htm) and, for electronic format documents, subject to Terms and Conditions for Electronic Documents at [www.sgs.com/terms\\_e-document.htm](http://www.sgs.com/terms_e-document.htm). Attention is drawn to the limitation of liability, indemnification and jurisdiction issues defined therein. Any holder of this document is advised that information contained hereon reflects the Company's findings at the time of its intervention only and within the limits of Client's instructions, if any. The Company's sole responsibility is to its Client and this document does not exonerate parties to a transaction from exercising all their rights and obligations under the transaction documents. This document cannot be reproduced except in full, without prior written approval of the Company. Any unauthorized alteration, forgery or falsification of the content or appearance of this document is unlawful and offenders may be prosecuted to the fullest extent of the law.

**Figure 10-33: Out of Band emission at antenna terminals–5MHz BW LTE-Band 13 (QPSK RB Number: 1 Offset: 24) Channel Highest**

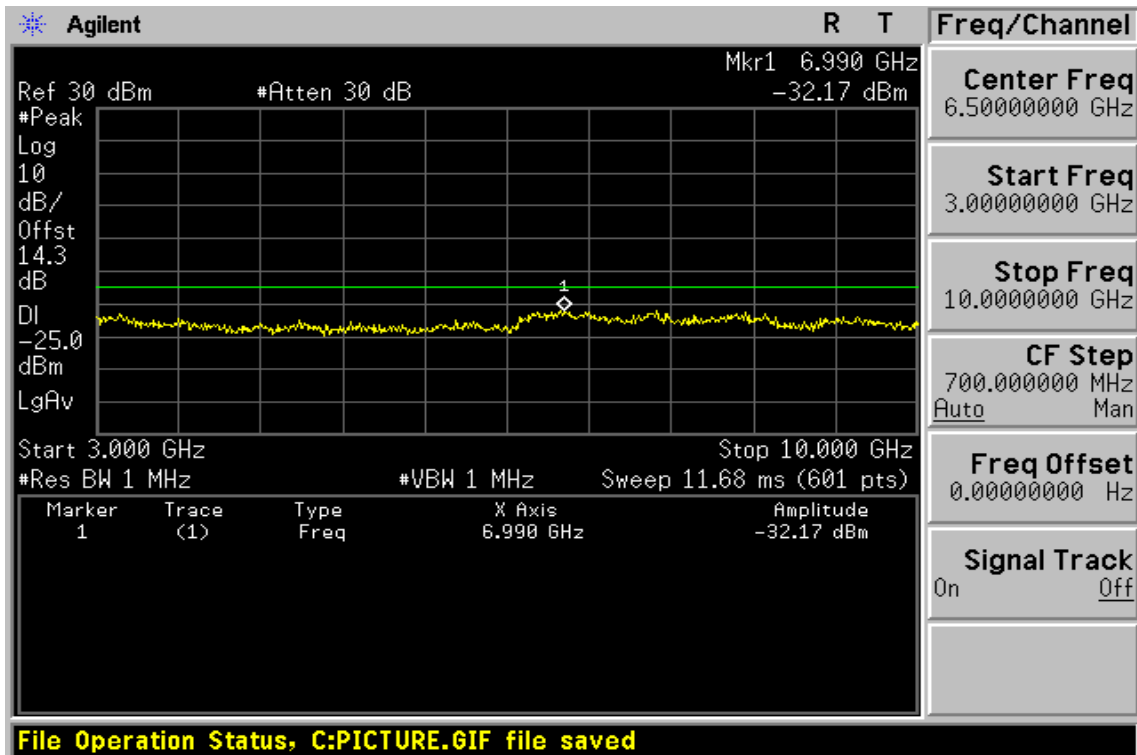
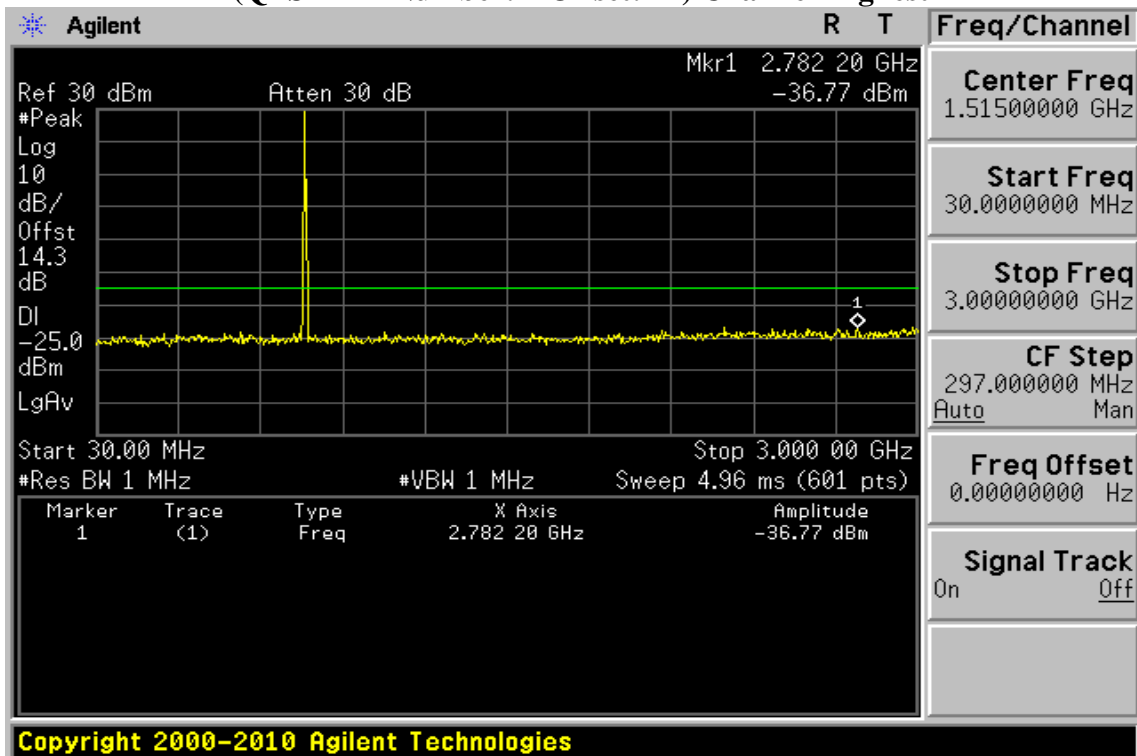

Unless otherwise stated the results shown in this test report refer only to the sample(s) tested and such sample(s) are retained for 90 days only.

除非另有說明，此報告結果僅對測試之樣品負責，同時此樣品僅保留90天。本報告未經本公司書面許可，不可部份複製。

This document is issued by the Company subject to its General Conditions of Service printed overleaf, available on request or accessible at [www.sgs.com/terms\\_and\\_conditions.htm](http://www.sgs.com/terms_and_conditions.htm) and, for electronic format documents, subject to Terms and Conditions for Electronic Documents at [www.sgs.com/terms\\_e-document.htm](http://www.sgs.com/terms_e-document.htm). Attention is drawn to the limitation of liability, indemnification and jurisdiction issues defined therein. Any holder of this document is advised that information contained hereon reflects the Company's findings at the time of its intervention only and within the limits of Client's instructions, if any. The Company's sole responsibility is to its Client and this document does not exonerate parties to a transaction from exercising all their rights and obligations under the transaction documents. This document cannot be reproduced except in full, without prior written approval of the Company. Any unauthorized alteration, forgery or falsification of the content or appearance of this document is unlawful and offenders may be prosecuted to the fullest extent of the law.

**Figure 10-34: Band edge emission at antenna terminals –5MHz BW LTE-Band 13 (QPSK RB Number: 1 Offset: 0) Channel Lowest**

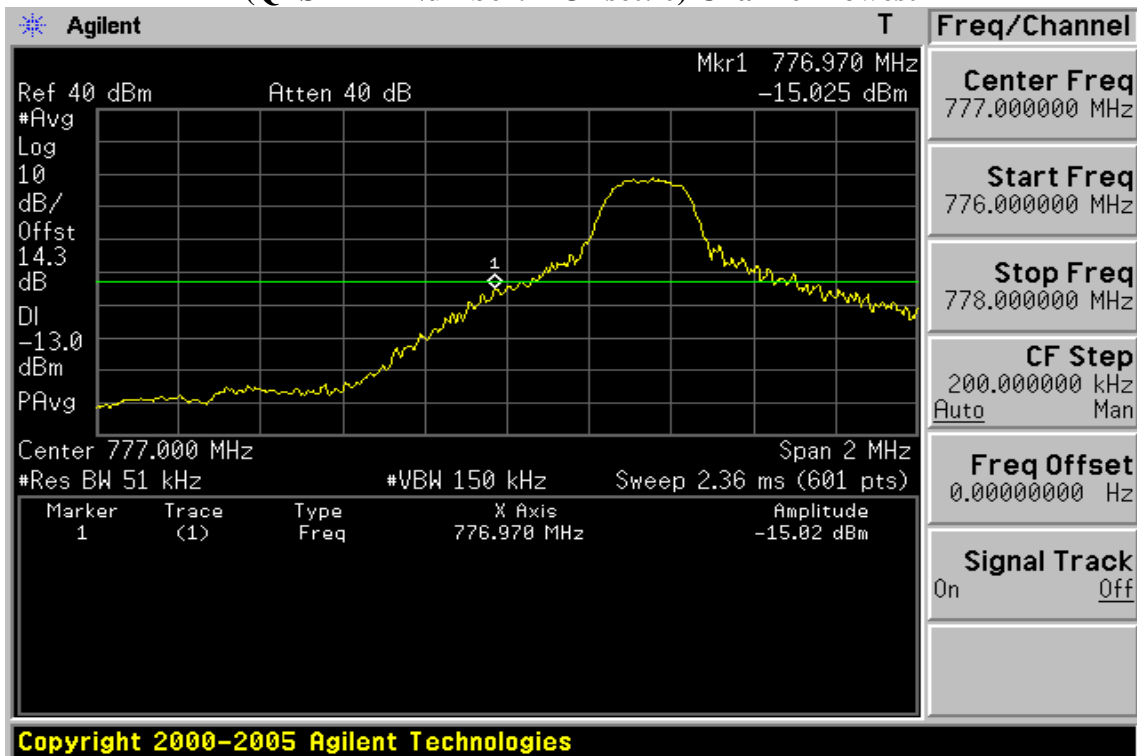

**Figure 10-35: Band edge emission at antenna terminals –5MHz BW LTE-Band 13 (QPSK RB Number: 1 Offset: 24) Channel Highest**

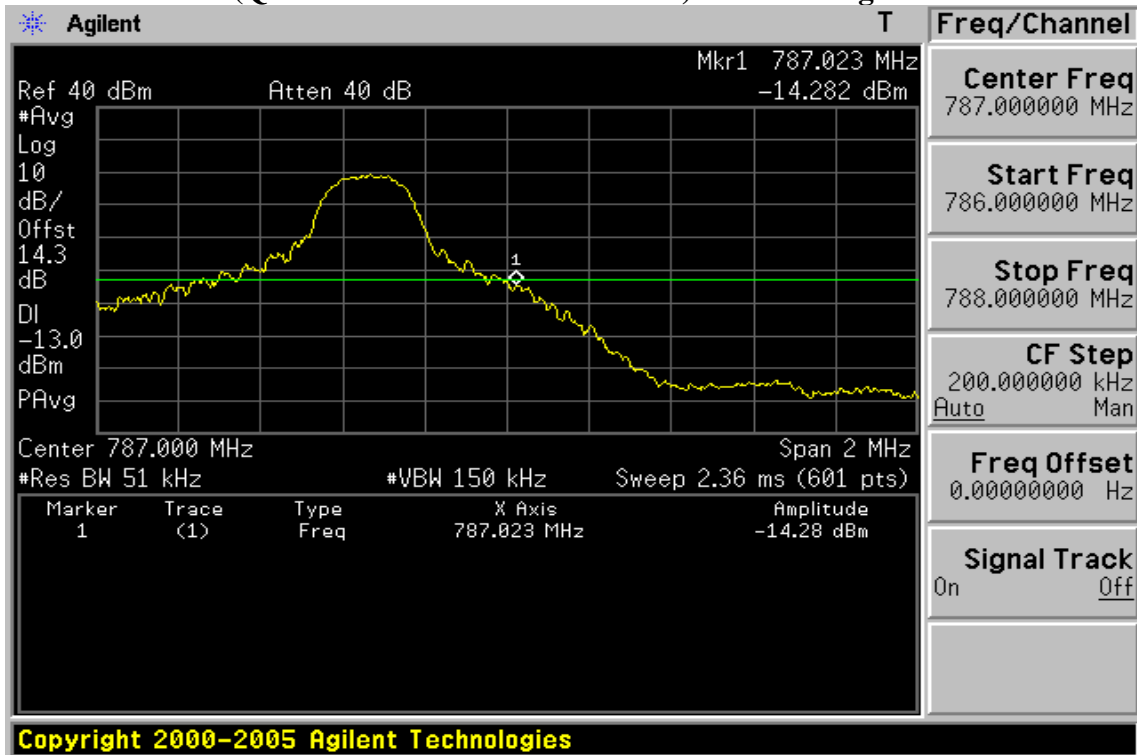

Unless otherwise stated the results shown in this test report refer only to the sample(s) tested and such sample(s) are retained for 90 days only.

除非另有說明，此報告結果僅對測試之樣品負責，同時此樣品僅保留90天。本報告未經本公司書面許可，不可部份複製。

This document is issued by the Company subject to its General Conditions of Service printed overleaf, available on request or accessible at [www.sgs.com/terms\\_and\\_conditions.htm](http://www.sgs.com/terms_and_conditions.htm) and, for electronic format documents, subject to Terms and Conditions for Electronic Documents at [www.sgs.com/terms\\_e-document.htm](http://www.sgs.com/terms_e-document.htm). Attention is drawn to the limitation of liability, indemnification and jurisdiction issues defined therein. Any holder of this document is advised that information contained hereon reflects the Company's findings at the time of its intervention only and within the limits of Client's instructions, if any. The Company's sole responsibility is to its Client and this document does not exonerate parties to a transaction from exercising all their rights and obligations under the transaction documents. This document cannot be reproduced except in full, without prior written approval of the Company. Any unauthorized alteration, forgery or falsification of the content or appearance of this document is unlawful and offenders may be prosecuted to the fullest extent of the law.

**Figure 10-36: Out of Band emission at antenna terminals–10MHz BW LTE-Band 13 (QPSK RB Number: 1 Offset: 0) Channel Mid**

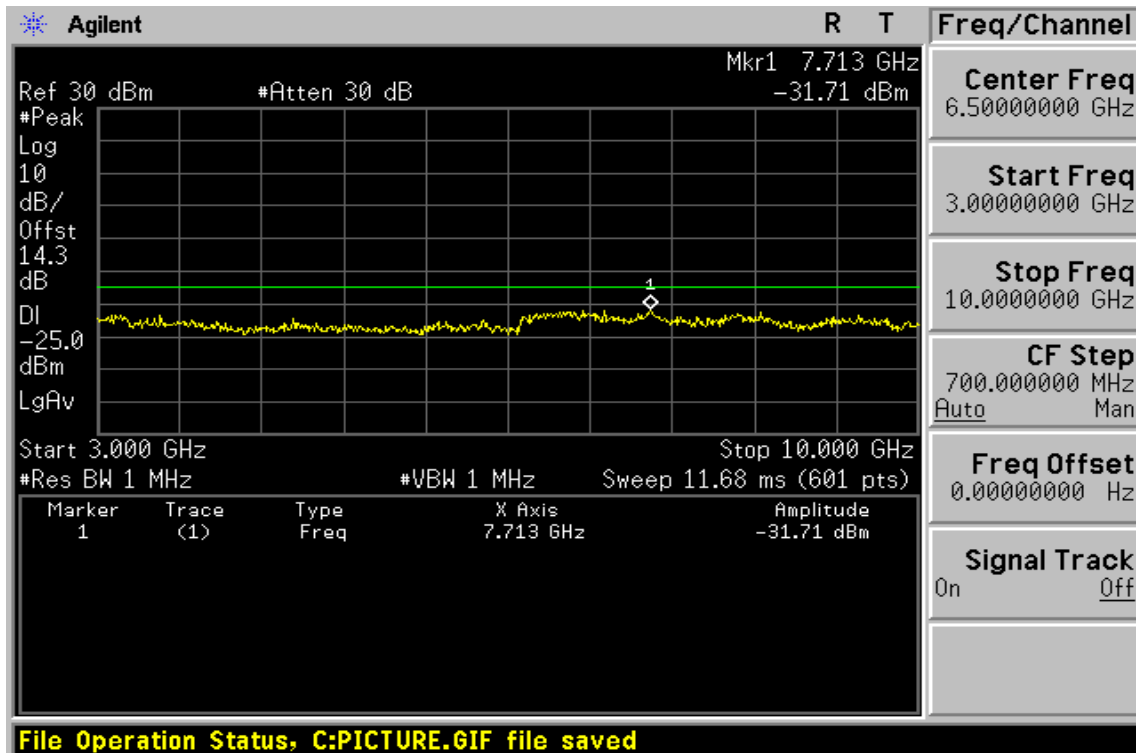
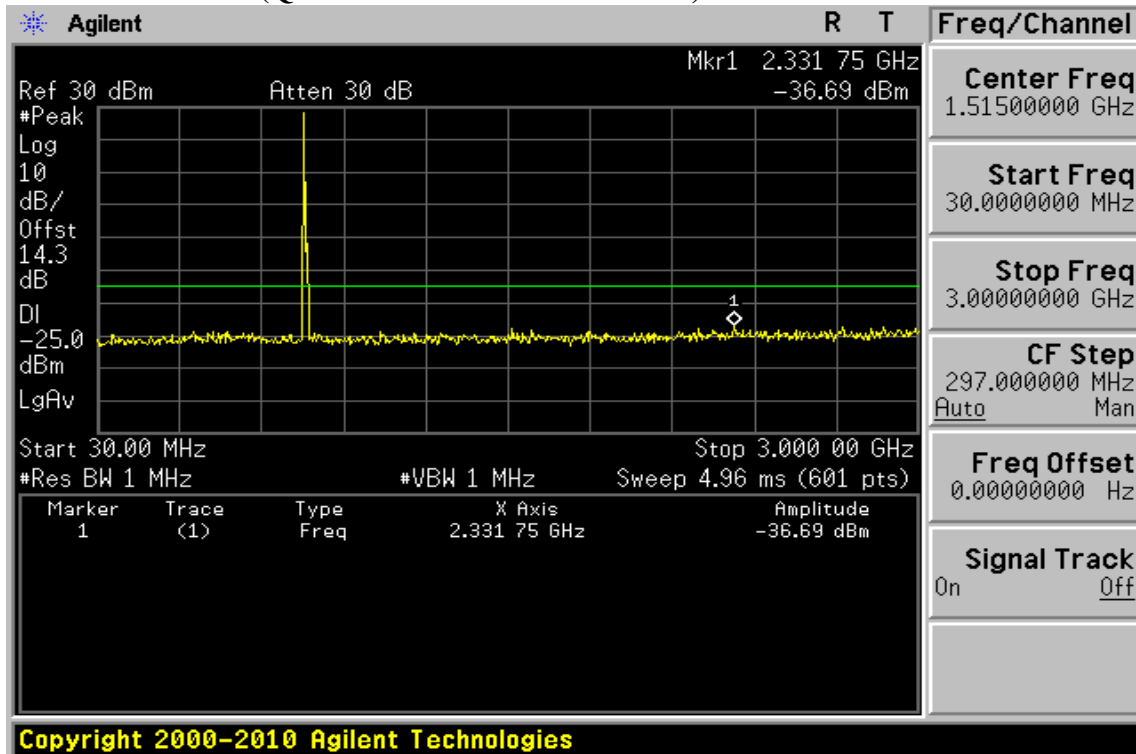

Unless otherwise stated the results shown in this test report refer only to the sample(s) tested and such sample(s) are retained for 90 days only.

除非另有說明，此報告結果僅對測試之樣品負責，同時此樣品僅保留90天。本報告未經本公司書面許可，不可部份複製。

This document is issued by the Company subject to its General Conditions of Service printed overleaf, available on request or accessible at [www.sgs.com/terms\\_and\\_conditions.htm](http://www.sgs.com/terms_and_conditions.htm) and, for electronic format documents, subject to Terms and Conditions for Electronic Documents at [www.sgs.com/terms\\_e-document.htm](http://www.sgs.com/terms_e-document.htm). Attention is drawn to the limitation of liability, indemnification and jurisdiction issues defined therein. Any holder of this document is advised that information contained hereon reflects the Company's findings at the time of its intervention only and within the limits of Client's instructions, if any. The Company's sole responsibility is to its Client and this document does not exonerate parties to a transaction from exercising all their rights and obligations under the transaction documents. This document cannot be reproduced except in full, without prior written approval of the Company. Any unauthorized alteration, forgery or falsification of the content or appearance of this document is unlawful and offenders may be prosecuted to the fullest extent of the law.

**Figure 10-37: Band edge emission at antenna terminals –10MHz BW LTE-Band 13 (QPSK RB Number: 1 Offset: 0) Channel Mid**

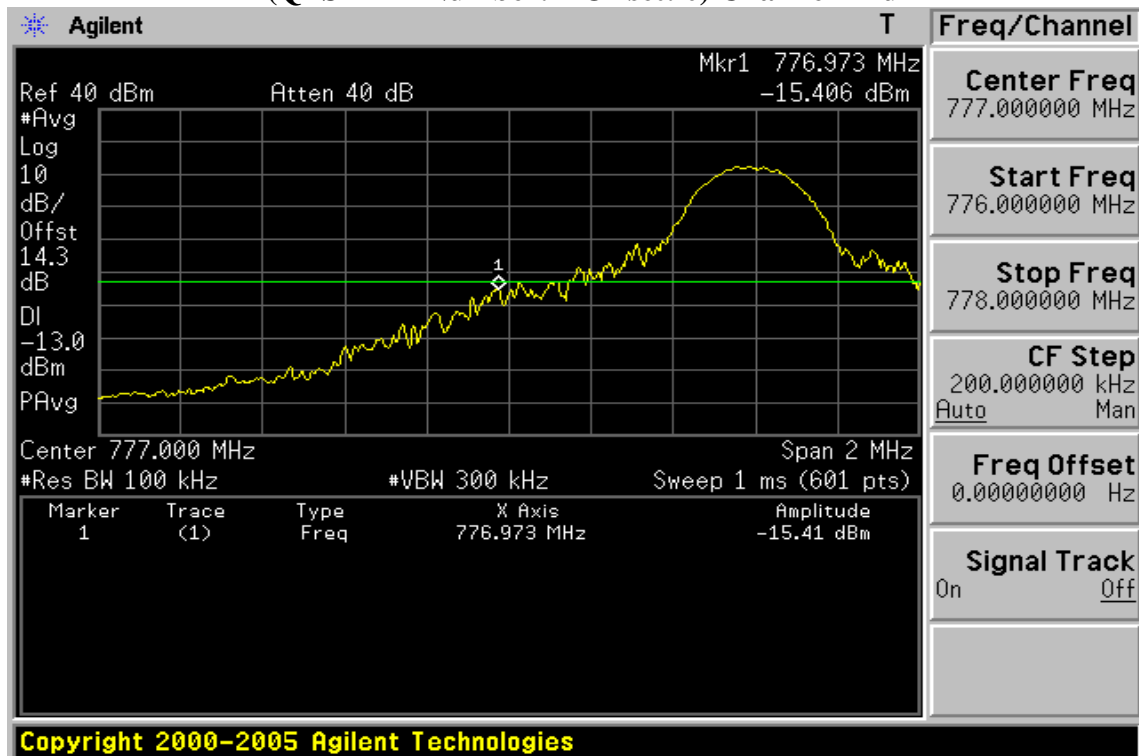

Unless otherwise stated the results shown in this test report refer only to the sample(s) tested and such sample(s) are retained for 90 days only.

除非另有說明，此報告結果僅對測試之樣品負責，同時此樣品僅保留90天。本報告未經本公司書面許可，不可部份複製。

This document is issued by the Company subject to its General Conditions of Service printed overleaf, available on request or accessible at [www.sgs.com/terms\\_and\\_conditions.htm](http://www.sgs.com/terms_and_conditions.htm) and, for electronic format documents, subject to Terms and Conditions for Electronic Documents at [www.sgs.com/terms\\_e-document.htm](http://www.sgs.com/terms_e-document.htm). Attention is drawn to the limitation of liability, indemnification and jurisdiction issues defined therein. Any holder of this document is advised that information contained hereon reflects the Company's findings at the time of its intervention only and within the limits of Client's instructions, if any. The Company's sole responsibility is to its Client and this document does not exonerate parties to a transaction from exercising all their rights and obligations under the transaction documents. This document cannot be reproduced except in full, without prior written approval of the Company. Any unauthorized alteration, forgery or falsification of the content or appearance of this document is unlawful and offenders may be prosecuted to the fullest extent of the law.

## 11. FIELD STRENGTH OF SPURIOUS RADIATION MEASUREMENT

### 11.1. Standard Applicable:

According to FCC §2.1053,

#### **LTE Band4:**

FCC §27.53(h) the magnitude of each spurious and harmonic emission that can be detected when the equipment is operated under the conditions specified in the instruction manual and/ or alignment procedure, shall not be less than  $43 + 10 \log$  (mean output power in watts) dBc below the mean power output outside a license's frequency block (-13dBm).

#### **LTE Band 13:**

FCC §27.53(c) (2)

(c) For operations in the 746–758 MHz band and the 776–788 MHz band, the power of any emission outside the licensee's frequency band(s) of operation shall be attenuated below the transmitter power (P) within the licensed band(s) of operation, measured in watts, in accordance with the following:

(2) On any frequency outside the 776– 788 MHz band, the power of any emission shall be attenuated outside the band below the transmitter power (P) by at least  $43 + 10 \log (P)$  dB (-13dBm)

Unless otherwise stated the results shown in this test report refer only to the sample(s) tested and such sample(s) are retained for 90 days only.

除非另有說明，此報告結果僅對測試之樣品負責，同時此樣品僅保留90天。本報告未經本公司書面許可，不可部份複製。

This document is issued by the Company subject to its General Conditions of Service printed overleaf, available on request or accessible at [www.sgs.com/terms\\_and\\_conditions.htm](http://www.sgs.com/terms_and_conditions.htm) and, for electronic format documents, subject to Terms and Conditions for Electronic Documents at [www.sgs.com/terms\\_e-document.htm](http://www.sgs.com/terms_e-document.htm). Attention is drawn to the limitation of liability, indemnification and jurisdiction issues defined therein. Any holder of this document is advised that information contained hereon reflects the Company's findings at the time of its intervention only and within the limits of Client's instructions, if any. The Company's sole responsibility is to its Client and this document does not exonerate parties to a transaction from exercising all their rights and obligations under the transaction documents. This document cannot be reproduced except in full, without prior written approval of the Company. Any unauthorized alteration, forgery or falsification of the content or appearance of this document is unlawful and offenders may be prosecuted to the fullest extent of the law.

**11.2. EUT Setup (Block Diagram of Configuration):**

Radiated Emission Test Set-Up, Frequency Below 1000MHz

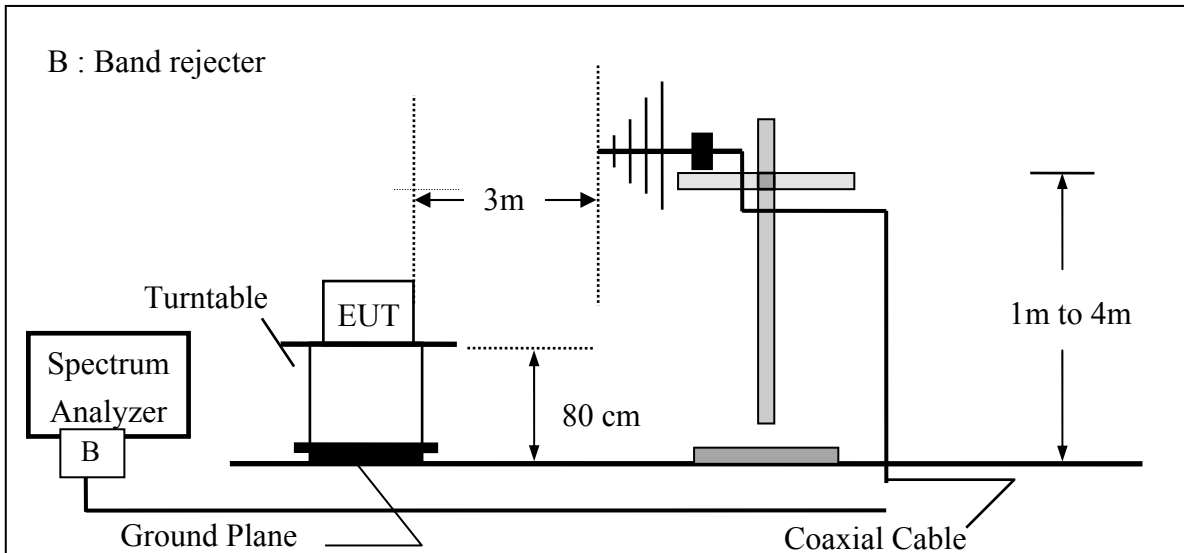

Radiated Emission Test Set-UP Frequency Over 1 GHz

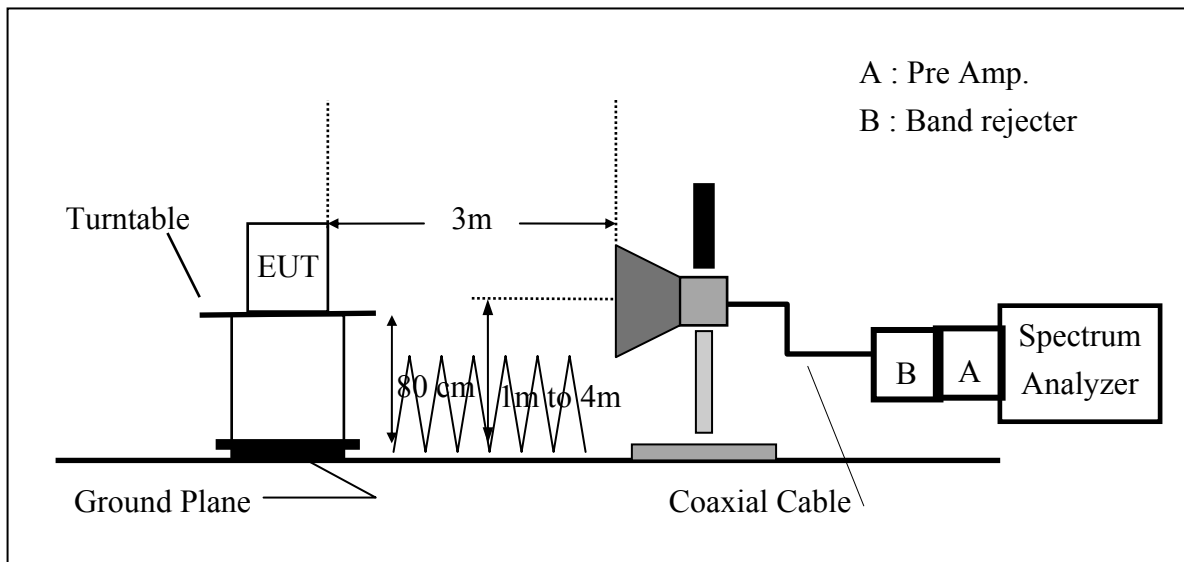

Unless otherwise stated the results shown in this test report refer only to the sample(s) tested and such sample(s) are retained for 90 days only.

除非另有說明，此報告結果僅對測試之樣品負責，同時此樣品僅保留90天。本報告未經本公司書面許可，不可部份複製。

This document is issued by the Company subject to its General Conditions of Service printed overleaf, available on request or accessible at [www.sgs.com/terms\\_and\\_conditions.htm](http://www.sgs.com/terms_and_conditions.htm) and, for electronic format documents, subject to Terms and Conditions for Electronic Documents at [www.sgs.com/terms\\_e-document.htm](http://www.sgs.com/terms_e-document.htm). Attention is drawn to the limitation of liability, indemnification and jurisdiction issues defined therein. Any holder of this document is advised that information contained hereon reflects the Company's findings at the time of its intervention only and within the limits of Client's instructions, if any. The Company's sole responsibility is to its Client and this document does not exonerate parties to a transaction from exercising all their rights and obligations under the transaction documents. This document cannot be reproduced except in full, without prior written approval of the Company. Any unauthorized alteration, forgery or falsification of the content or appearance of this document is unlawful and offenders may be prosecuted to the fullest extent of the law.



### 11.3. Measurement Procedure:

The EUT was placed on a non-conductive; The measurement antenna was placed at a distance of 3 meters from the EUT. During the tests, the antenna height and the EUT azimuth were varied in order to identify the maximum level of emissions from the EUT. This maximization process was repeated with the EUT positioned in each of its three orthogonal orientations.

The frequency range up to tenth harmonic was investigated for each of three fundamental frequency (low, middle and high channels). Once spurious emission was identified, the power of the emission was determined using the substitution method.

The spurious emissions attenuation was calculated as the difference between radiated power at the fundamental frequency and the spurious emissions frequency.

ERP= S.G. output (dBm) + Antenna Gain (dBd) – Cable Loss (dB)

EIRP = S.G. output (dBm) + Antenna Gain(dBi) – Cable Loss (dB)

Spectrum Setting: RBW, VBW = 1MHz, Detector = Peak (LTE Band 4), RBW, VBW = 100kHz, Detector = Peak (LTE Band 13).

### 11.4. Measurement Equipment Used:

Refer to section 2.4 in this report

Unless otherwise stated the results shown in this test report refer only to the sample(s) tested and such sample(s) are retained for 90 days only.

除非另有說明，此報告結果僅對測試之樣品負責，同時此樣品僅保留90天。本報告未經本公司書面許可，不可部份複製。

This document is issued by the Company subject to its General Conditions of Service printed overleaf, available on request or accessible at [www.sgs.com/terms\\_and\\_conditions.htm](http://www.sgs.com/terms_and_conditions.htm) and, for electronic format documents, subject to Terms and Conditions for Electronic Documents at [www.sgs.com/terms\\_e-document.htm](http://www.sgs.com/terms_e-document.htm). Attention is drawn to the limitation of liability, indemnification and jurisdiction issues defined therein. Any holder of this document is advised that information contained hereon reflects the Company's findings at the time of its intervention only and within the limits of Client's instructions, if any. The Company's sole responsibility is to its Client and this document does not exonerate parties to a transaction from exercising all their rights and obligations under the transaction documents. This document cannot be reproduced except in full, without prior written approval of the Company. Any unauthorized alteration, forgery or falsification of the content or appearance of this document is unlawful and offenders may be prosecuted to the fullest extent of the law.

**11.5. Measurement Result:**

**Radiated Spurious Emission Measurement Result: 20MHz BW LTE-Band 4(The Worst Case)**

Operation Band	:LTE B4	Test Date	:2014-07-08
ARFCN	:CH 20050 QPSK BW 20 RB 1 99	Temp./Humi.	:22 deg_C / 64 RH
Fundamental Frequency	:1720.0 MHz	Engineer	:Tin
Operation Mode	:TX LOW		
EUT Pol.	:E2 Plane	Measurement Antenna Pol.	:VERTICAL

Freq. MHz	Note F/H/E/S	EIRP dBm	SG Output Level dBm	Antenna Gain dBi	Cable Loss dB	Limit dBm	Safe Margin dB
50.37	S	-58.52	-47.31	-10.20	-1.00	-13.00	-45.52
88.20	S	-59.13	-58.76	0.80	-1.17	-13.00	-46.13
278.32	S	-55.31	-58.99	5.49	-1.80	-13.00	-42.31
305.48	S	-59.37	-63.09	5.60	-1.88	-13.00	-46.37
339.43	S	-62.31	-66.12	5.76	-1.96	-13.00	-49.31
593.57	S	-59.13	-62.17	5.64	-2.60	-13.00	-46.13
3440.00	H	-41.17	-43.28	8.69	-6.58	-13.00	-28.17
5160.00	H	---					
6880.00	H	---					
8600.00	H	---					
10320.00	H	---					
12040.00	H	---					
13760.00	H	---					
15480.00	H	---					
17200.00	H	---					

$EIRP(dBm) = SG\ Level(dBm) + Antenna\ Gain(dBd) + Cable\ Loss(dB)$

Note : "F" : denotes Fundamental Frequency. ; "H" : denotes Harmonic Frequency.

"E" : denotes Band Edge Frequency. ; "S" : denotes Spurious Frequency.

"---" : denotes Noise Floor.

Unless otherwise stated the results shown in this test report refer only to the sample(s) tested and such sample(s) are retained for 90 days only.

除非另有說明，此報告結果僅對測試之樣品負責，同時此樣品僅保留90天。本報告未經本公司書面許可，不可部份複製。

This document is issued by the Company subject to its General Conditions of Service printed overleaf, available on request or accessible at [www.sgs.com/terms\\_and\\_conditions.htm](http://www.sgs.com/terms_and_conditions.htm) and, for electronic format documents, subject to Terms and Conditions for Electronic Documents at [www.sgs.com/terms\\_e-document.htm](http://www.sgs.com/terms_e-document.htm). Attention is drawn to the limitation of liability, indemnification and jurisdiction issues defined therein. Any holder of this document is advised that information contained hereon reflects the Company's findings at the time of its intervention only and within the limits of Client's instructions, if any. The Company's sole responsibility is to its Client and this document does not exonerate parties to a transaction from exercising all their rights and obligations under the transaction documents. This document cannot be reproduced except in full, without prior written approval of the Company. Any unauthorized alteration, forgery or falsification of the content or appearance of this document is unlawful and offenders may be prosecuted to the fullest extent of the law.

**Radiated Spurious Emission Measurement Result: 20MHz BW LTE-Band 4**

Operation Band	:LTE B4	Test Date	:2014-07-08
ARFCN	:CH 20050 QPSK BW 20 RB 1 99	Temp./Humi.	:22 deg_C / 64 RH
Fundamental Frequency	:1720.0 MHz	Engineer	:Tin
Operation Mode	:TX LOW	Measurement Antenna Pol.	:HORIZONTAL
EUT Pol.	:E2 Plane		

Freq. MHz	Note F/H/E/S	EIRP dBm	SG Output Level dBm	Antenna Gain dBi	Cable Loss dB	Limit dBm	Safe Margin dB
48.43	S	-62.34	-50.86	-10.51	-0.97	-13.00	-49.34
88.20	S	-63.68	-63.31	0.80	-1.17	-13.00	-50.68
127.00	S	-62.18	-60.99	0.11	-1.31	-13.00	-49.18
285.11	S	-61.72	-65.42	5.53	-1.82	-13.00	-48.72
574.17	S	-58.00	-61.22	5.77	-2.55	-13.00	-45.00
678.93	S	-58.39	-61.63	5.96	-2.72	-13.00	-45.39
3440.00	H	-41.89	-44.00	8.69	-6.58	-13.00	-28.89
5160.00	H	---					
6880.00	H	---					
8600.00	H	---					
10320.00	H	---					
12040.00	H	---					
13760.00	H	---					
15480.00	H	---					
17200.00	H	---					

$EIRP(dBm) = SG\ Level(dBm) + Antenna\ Gain(dBd) + Cable\ Loss(dB)$

Note : "F" : denotes Fundamental Frequency. ; "H" : denotes Harmonic Frequency.

"E" : denotes Band Edge Frequency. ; "S" : denotes Spurious Frequency.

"---" : denotes Noise Floor.

Unless otherwise stated the results shown in this test report refer only to the sample(s) tested and such sample(s) are retained for 90 days only.

除非另有說明，此報告結果僅對測試之樣品負責，同時此樣品僅保留90天。本報告未經本公司書面許可，不可部份複製。

This document is issued by the Company subject to its General Conditions of Service printed overleaf, available on request or accessible at [www.sgs.com/terms\\_and\\_conditions.htm](http://www.sgs.com/terms_and_conditions.htm) and, for electronic format documents, subject to Terms and Conditions for Electronic Documents at [www.sgs.com/terms\\_e-document.htm](http://www.sgs.com/terms_e-document.htm). Attention is drawn to the limitation of liability, indemnification and jurisdiction issues defined therein. Any holder of this document is advised that information contained hereon reflects the Company's findings at the time of its intervention only and within the limits of Client's instructions, if any. The Company's sole responsibility is to its Client and this document does not exonerate parties to a transaction from exercising all their rights and obligations under the transaction documents. This document cannot be reproduced except in full, without prior written approval of the Company. Any unauthorized alteration, forgery or falsification of the content or appearance of this document is unlawful and offenders may be prosecuted to the fullest extent of the law.

**Radiated Spurious Emission Measurement Result: 20MHz BW LTE-Band 4**

Operation Band	:LTE B4	Test Date	:2014-07-08
ARFCN	:CH 20175 QPSK BW 20 RB 1 99	Temp./Humi.	:22 deg_C / 64 RH
Fundamental Frequency	:1732.5 MHz	Engineer	:Tin
Operation Mode	:TX MID	Measurement Antenna Pol.	:VERTICAL
EUT Pol.	:E2 Plane		

Freq. MHz	Note F/H/E/S	EIRP dBm	SG Output Level dBm	Antenna Gain dBi	Cable Loss dB	Limit dBm	Safe Margin dB
50.37	S	-57.52	-46.32	-10.20	-1.00	-13.00	-44.52
87.23	S	-58.72	-58.09	0.51	-1.15	-13.00	-45.72
278.32	S	-55.14	-58.82	5.49	-1.80	-13.00	-42.14
339.43	S	-61.73	-65.54	5.76	-1.96	-13.00	-48.73
593.57	S	-58.33	-61.36	5.64	-2.60	-13.00	-45.33
676.02	S	-59.27	-62.51	5.96	-2.71	-13.00	-46.27
3465.00	H	-38.74	-40.90	8.76	-6.61	-13.00	-25.74
5197.50	H	---					
6930.00	H	-44.37	-46.68	11.75	-9.44	-13.00	-31.37
8662.50	H	---	-46.32	-10.20	-1.00	-13.00	-44.52
10395.00	H	---	-	-	-	-	-
12127.50	H	---	-	-	-	-	-
13860.00	H	---	-	-	-	-	-
15592.50	H	---	-	-	-	-	-
17325.00	H	---	-	-	-	-	-

EIRP(dBm) = SG Level(dBm) + Antenna Gain(dBd) + Cable Loss(dB)

Note : "F" : denotes Fundamental Frequency. ; "H" : denotes Harmonic Frequency.

"E" : denotes Band Edge Frequency. ; "S" : denotes Spurious Frequency.

"---" : denotes Noise Floor.

Unless otherwise stated the results shown in this test report refer only to the sample(s) tested and such sample(s) are retained for 90 days only.

除非另有說明，此報告結果僅對測試之樣品負責，同時此樣品僅保留90天。本報告未經本公司書面許可，不可部份複製。

This document is issued by the Company subject to its General Conditions of Service printed overleaf, available on request or accessible at [www.sgs.com/terms\\_and\\_conditions.htm](http://www.sgs.com/terms_and_conditions.htm) and, for electronic format documents, subject to Terms and Conditions for Electronic Documents at [www.sgs.com/terms\\_e-document.htm](http://www.sgs.com/terms_e-document.htm). Attention is drawn to the limitation of liability, indemnification and jurisdiction issues defined therein. Any holder of this document is advised that information contained hereon reflects the Company's findings at the time of its intervention only and within the limits of Client's instructions, if any. The Company's sole responsibility is to its Client and this document does not exonerate parties to a transaction from exercising all their rights and obligations under the transaction documents. This document cannot be reproduced except in full, without prior written approval of the Company. Any unauthorized alteration, forgery or falsification of the content or appearance of this document is unlawful and offenders may be prosecuted to the fullest extent of the law.

**Radiated Spurious Emission Measurement Result: 20MHz BW LTE-Band 4**

Operation Band	:LTE B4	Test Date	:2014-07-08
ARFCN	:CH 20175 QPSK BW 20 RB 1 99	Temp./Humi.	:22 deg_C / 64 RH
Fundamental Frequency	:1732.5 MHz	Engineer	:Tin
Operation Mode	:TX MID	Measurement Antenna Pol.	:HORIZONTAL
EUT Pol.	:E2 Plane		

Freq.	Note	EIRP	SG	Antenna	Cable	Limit	Safe
MHz	F/H/E/S	dBm	Output Level dBm	Gain dBi	Loss dB	dBm	Margin dB
48.43	S	-62.82	-51.34	-10.51	-0.97	-13.00	-49.82
160.95	S	-59.70	-58.82	0.53	-1.41	-13.00	-46.70
192.96	S	-60.54	-63.93	4.89	-1.49	-13.00	-47.54
278.32	S	-61.74	-65.43	5.49	-1.80	-13.00	-48.74
572.23	S	-58.17	-61.40	5.78	-2.55	-13.00	-45.17
676.02	S	-59.71	-62.96	5.96	-2.71	-13.00	-46.71
3465.00	H	-44.44	-46.59	8.76	-6.61	-13.00	-31.44
5197.50	H	---					
6930.00	H	---					
8662.50	H	---					
10395.00	H	---					
12127.50	H	---					
13860.00	H	---					
15592.50	H	---					
17325.00	H	---					

$EIRP(dBm) = SG\ Level(dBm) + Antenna\ Gain(dBd) + Cable\ Loss(dB)$

Note : “F” : denotes Fundamental Frequency. ; “H” : denotes Harmonic Frequency.  
 “E” : denotes Band Edge Frequency. ; “S” : denotes Spurious Frequency.  
 “---” : denotes Noise Floor.

Unless otherwise stated the results shown in this test report refer only to the sample(s) tested and such sample(s) are retained for 90 days only.

除非另有說明，此報告結果僅對測試之樣品負責，同時此樣品僅保留90天。本報告未經本公司書面許可，不可部份複製。

This document is issued by the Company subject to its General Conditions of Service printed overleaf, available on request or accessible at [www.sgs.com/terms\\_and\\_conditions.htm](http://www.sgs.com/terms_and_conditions.htm) and, for electronic format documents, subject to Terms and Conditions for Electronic Documents at [www.sgs.com/terms\\_e-document.htm](http://www.sgs.com/terms_e-document.htm). Attention is drawn to the limitation of liability, indemnification and jurisdiction issues defined therein. Any holder of this document is advised that information contained hereon reflects the Company's findings at the time of its intervention only and within the limits of Client's instructions, if any. The Company's sole responsibility is to its Client and this document does not exonerate parties to a transaction from exercising all their rights and obligations under the transaction documents. This document cannot be reproduced except in full, without prior written approval of the Company. Any unauthorized alteration, forgery or falsification of the content or appearance of this document is unlawful and offenders may be prosecuted to the fullest extent of the law.

**Radiated Spurious Emission Measurement Result: 20MHz BW LTE-Band 4**

Operation Band	:LTE B4	Test Date	:2014-07-08
ARFCN	:CH 20300 QPSK BW 20 RB 1 99	Temp./Humi.	:22 deg_C / 64 RH
Fundamental Frequency	:1745.0 MHz	Engineer	:Tin
Operation Mode	:TX HIGH	Measurement Antenna Pol.	:VERTICAL
EUT Pol.	:E2 Plane		

Freq.	Note	EIRP	SG	Antenna	Cable	Limit	Safe
MHz	F/H/E/S	dBm	Output Level dBm	Gain dBi	Loss dB	dBm	Margin dB
48.43	S	-56.48	-45.00	-10.51	-0.97	-13.00	-43.48
88.20	S	-59.29	-58.92	0.80	-1.17	-13.00	-46.29
278.32	S	-55.56	-59.25	5.49	-1.80	-13.00	-42.56
312.27	S	-58.63	-62.37	5.63	-1.90	-13.00	-45.63
339.43	S	-61.46	-65.27	5.76	-1.96	-13.00	-48.46
586.78	S	-59.05	-62.15	5.68	-2.59	-13.00	-46.05
3490.00	H	-34.55	-36.73	8.81	-6.63	-13.00	-21.55
5235.00	H	---					
6980.00	H	-44.52	-46.86	11.82	-9.49	-13.00	-31.52
8725.00	H	---					
10470.00	H	---					
12215.00	H	---					
13960.00	H	---					
15705.00	H	---					
17450.00	H	---					

$EIRP(dBm) = SG\ Level(dBm) + Antenna\ Gain(dBd) + Cable\ Loss(dB)$

Note : "F" : denotes Fundamental Frequency. ; "H" : denotes Harmonic Frequency.

"E" : denotes Band Edge Frequency. ; "S" : denotes Spurious Frequency.

"---" : denotes Noise Floor.

Unless otherwise stated the results shown in this test report refer only to the sample(s) tested and such sample(s) are retained for 90 days only.

除非另有說明，此報告結果僅對測試之樣品負責，同時此樣品僅保留90天。本報告未經本公司書面許可，不可部份複製。

This document is issued by the Company subject to its General Conditions of Service printed overleaf, available on request or accessible at [www.sgs.com/terms\\_and\\_conditions.htm](http://www.sgs.com/terms_and_conditions.htm) and, for electronic format documents, subject to Terms and Conditions for Electronic Documents at [www.sgs.com/terms\\_e-document.htm](http://www.sgs.com/terms_e-document.htm). Attention is drawn to the limitation of liability, indemnification and jurisdiction issues defined therein. Any holder of this document is advised that information contained hereon reflects the Company's findings at the time of its intervention only and within the limits of Client's instructions, if any. The Company's sole responsibility is to its Client and this document does not exonerate parties to a transaction from exercising all their rights and obligations under the transaction documents. This document cannot be reproduced except in full, without prior written approval of the Company. Any unauthorized alteration, forgery or falsification of the content or appearance of this document is unlawful and offenders may be prosecuted to the fullest extent of the law.

**Radiated Spurious Emission Measurement Result: 20MHz BW LTE-Band 4**

Operation Band	:LTE B4	Test Date	:2014-07-08
ARFCN	:CH 20300 QPSK BW 20 RB 1 99	Temp./Humi.	:22 deg_C / 64 RH
Fundamental Frequency	:1745.0 MHz	Engineer	:Tin
Operation Mode	:TX HIGH	Measurement Antenna Pol.	:HORIZONTAL
EUT Pol.	:E2 Plane		

Freq. MHz	Note F/H/E/S	EIRP dBm	SG Output Level dBm	Antenna Gain dBi	Cable Loss dB	Limit dBm	Safe Margin dB
126.03	S	-61.83	-60.64	0.11	-1.30	-13.00	-48.83
159.98	S	-60.40	-59.40	0.41	-1.41	-13.00	-47.40
278.32	S	-61.25	-64.94	5.49	-1.80	-13.00	-48.25
574.17	S	-58.83	-62.04	5.77	-2.55	-13.00	-45.83
676.02	S	-60.34	-63.59	5.96	-2.71	-13.00	-47.34
728.40	S	-61.14	-64.04	5.70	-2.80	-13.00	-48.14
3490.00	H	-40.43	-42.61	8.81	-6.63	-13.00	-27.43
5235.00	H	---					
6980.00	H	---					
8725.00	H	---					
10470.00	H	---					
12215.00	H	---					
13960.00	H	---					
15705.00	H	---					
17450.00	H	---					

$EIRP(dBm) = SG\ Level(dBm) + Antenna\ Gain(dBd) + Cable\ Loss(dB)$

Note : "F" : denotes Fundamental Frequency. ; "H" : denotes Harmonic Frequency.

"E" : denotes Band Edge Frequency. ; "S" : denotes Spurious Frequency.

"---" : denotes Noise Floor.

Unless otherwise stated the results shown in this test report refer only to the sample(s) tested and such sample(s) are retained for 90 days only.

除非另有說明，此報告結果僅對測試之樣品負責，同時此樣品僅保留90天。本報告未經本公司書面許可，不可部份複製。

This document is issued by the Company subject to its General Conditions of Service printed overleaf, available on request or accessible at [www.sgs.com/terms\\_and\\_conditions.htm](http://www.sgs.com/terms_and_conditions.htm) and, for electronic format documents, subject to Terms and Conditions for Electronic Documents at [www.sgs.com/terms\\_e-document.htm](http://www.sgs.com/terms_e-document.htm). Attention is drawn to the limitation of liability, indemnification and jurisdiction issues defined therein. Any holder of this document is advised that information contained hereon reflects the Company's findings at the time of its intervention only and within the limits of Client's instructions, if any. The Company's sole responsibility is to its Client and this document does not exonerate parties to a transaction from exercising all their rights and obligations under the transaction documents. This document cannot be reproduced except in full, without prior written approval of the Company. Any unauthorized alteration, forgery or falsification of the content or appearance of this document is unlawful and offenders may be prosecuted to the fullest extent of the law.

**Radiated Spurious Emission Measurement Result: 5MHz BW LTE-Band 13(The Worst Case)**

Operation Band	:LTE B13	Test Date	:2014-07-08
ARFCN	:CH 23230 16QAM BW 5 RB 1 24	Temp./Humi.	:22 deg_C / 64 RH
Fundamental Frequency	:782 MHz	Engineer	:Tin
Operation Mode	:TX MID	Measurement Antenna Pol.	:VERTICAL
EUT Pol.	:E2 Plane		

Freq. MHz	Note F/H/E/S	ERP dBm	SG Output Level dBm	Antenna Gain dBd	Cable Loss dB	Limit dBm	Safe Margin dB
48.43	S	-58.81	-45.18	-12.66	-0.97	-13.00	-45.81
88.20	S	-58.04	-55.52	-1.35	-1.17	-13.00	-45.04
271.53	S	-58.68	-60.29	3.39	-1.78	-13.00	-45.68
346.22	S	-60.46	-62.14	3.64	-1.97	-13.00	-47.46
387.93	S	-63.37	-64.95	3.63	-2.05	-13.00	-50.37
571.26	S	-64.83	-65.92	3.64	-2.55	-13.00	-51.83
1564.00	H	-43.06	-42.67	3.91	-4.31	-40.00	-3.06
2346.00	H	-54.77	-53.05	3.58	-5.30	-13.00	-41.77
3128.00	H	-53.54	-52.87	5.57	-6.25	-13.00	-40.54
3910.00	H	---					
4692.00	H	---					
5474.00	H	---					
6256.00	H	---					
7038.00	H	---					
7820.00	H	---					

ERP(dBm) = SG Level(dBm) + Antenna Gain(dBd) + Cable Loss(dB)

Note : “F” : denotes Fundamental Frequency. ; “H” : denotes Harmonic Frequency.

“E” : denotes Band Edge Frequency. ; “S” : denotes Spurious Frequency.

“---” : denotes Noise Floor.

Unless otherwise stated the results shown in this test report refer only to the sample(s) tested and such sample(s) are retained for 90 days only.

除非另有說明，此報告結果僅對測試之樣品負責，同時此樣品僅保留90天。本報告未經本公司書面許可，不可部份複製。

This document is issued by the Company subject to its General Conditions of Service printed overleaf, available on request or accessible at [www.sgs.com/terms\\_and\\_conditions.htm](http://www.sgs.com/terms_and_conditions.htm) and, for electronic format documents, subject to Terms and Conditions for Electronic Documents at [www.sgs.com/terms\\_e-document.htm](http://www.sgs.com/terms_e-document.htm). Attention is drawn to the limitation of liability, indemnification and jurisdiction issues defined therein. Any holder of this document is advised that information contained hereon reflects the Company's findings at the time of its intervention only and within the limits of Client's instructions, if any. The Company's sole responsibility is to its Client and this document does not exonerate parties to a transaction from exercising all their rights and obligations under the transaction documents. This document cannot be reproduced except in full, without prior written approval of the Company. Any unauthorized alteration, forgery or falsification of the content or appearance of this document is unlawful and offenders may be prosecuted to the fullest extent of the law.



**Radiated Spurious Emission Measurement Result: 5MHz BW LTE-Band 13**

Operation Band	:LTE B13	Test Date	:2014-07-08
ARFCN	:CH 23230 16QAM BW 5 RB 1 24	Temp./Humi.	:22 deg_C / 64 RH
Fundamental Frequency	:782 MHz	Engineer	:Tin
Operation Mode	:TX MID	Measurement Antenna Pol.	:HORIZONTAL
EUT Pol.	:E2 Plane		

Freq. MHz	Note F/H/E/S	ERP dBm	SG Output Level dBm	Antenna Gain dBd	Cable Loss dB	Limit dBm	Safe Margin dB
126.03	S	-61.07	-57.73	-2.04	-1.30	-13.00	-48.07
157.07	S	-58.54	-55.27	-1.87	-1.40	-13.00	-45.54
195.87	S	-58.22	-59.74	3.02	-1.50	-13.00	-45.22
278.32	S	-63.99	-65.53	3.34	-1.80	-13.00	-50.99
387.93	S	-63.44	-65.02	3.63	-2.05	-13.00	-50.44
572.23	S	-60.81	-61.89	3.63	-2.55	-13.00	-47.81
1564.00	H	-43.35	-42.96	3.91	-4.31	-40.00	-3.35
2346.00	H	-57.84	-56.12	3.58	-5.30	-13.00	-44.84
3128.00	H	-56.39	-55.71	5.57	-6.25	-13.00	-43.39
3910.00	H	---					
4692.00	H	---					
5474.00	H	---					
6256.00	H	---					
7038.00	H	---					
7820.00	H	---					

ERP(dBm) = SG Level(dBm) + Antenna Gain(dBd) + Cable Loss(dB)

Note : “F” : denotes Fundamental Frequency. ; “H” : denotes Harmonic Frequency.

“E” : denotes Band Edge Frequency. ; “S” : denotes Spurious Frequency.

“---” : denotes Noise Floor.

Unless otherwise stated the results shown in this test report refer only to the sample(s) tested and such sample(s) are retained for 90 days only.

除非另有說明，此報告結果僅對測試之樣品負責，同時此樣品僅保留90天。本報告未經本公司書面許可，不可部份複製。

This document is issued by the Company subject to its General Conditions of Service printed overleaf, available on request or accessible at [www.sgs.com/terms\\_and\\_conditions.htm](http://www.sgs.com/terms_and_conditions.htm) and, for electronic format documents, subject to Terms and Conditions for Electronic Documents at [www.sgs.com/terms\\_e-document.htm](http://www.sgs.com/terms_e-document.htm). Attention is drawn to the limitation of liability, indemnification and jurisdiction issues defined therein. Any holder of this document is advised that information contained hereon reflects the Company's findings at the time of its intervention only and within the limits of Client's instructions, if any. The Company's sole responsibility is to its Client and this document does not exonerate parties to a transaction from exercising all their rights and obligations under the transaction documents. This document cannot be reproduced except in full, without prior written approval of the Company. Any unauthorized alteration, forgery or falsification of the content or appearance of this document is unlawful and offenders may be prosecuted to the fullest extent of the law.

## 12. FREQUENCY STABILITY V.S. TEMPERATURE MEASUREMENT

### 12.1. Standard Applicable:

According to FCC §2.1055(a) (1)

Frequency Tolerance: +/-2.5ppm for 1700MHz band

+/-2.5ppm for 700MHz band

The carrier frequency shall not depart from the reference frequency in excess of  $\pm 2.5$  ppm for mobile stations

### 12.2. Test Set-up:

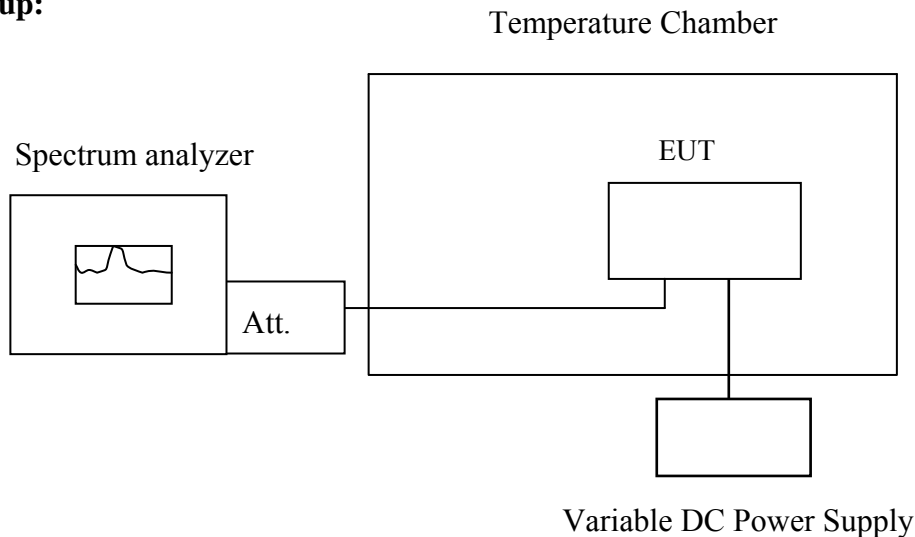

**Note :** Measurement setup for testing on Antenna connector

Unless otherwise stated the results shown in this test report refer only to the sample(s) tested and such sample(s) are retained for 90 days only.

除非另有說明，此報告結果僅對測試之樣品負責，同時此樣品僅保留90天。本報告未經本公司書面許可，不可部份複製。

This document is issued by the Company subject to its General Conditions of Service printed overleaf, available on request or accessible at [www.sgs.com/terms\\_and\\_conditions.htm](http://www.sgs.com/terms_and_conditions.htm) and, for electronic format documents, subject to Terms and Conditions for Electronic Documents at [www.sgs.com/terms\\_e-document.htm](http://www.sgs.com/terms_e-document.htm). Attention is drawn to the limitation of liability, indemnification and jurisdiction issues defined therein. Any holder of this document is advised that information contained hereon reflects the Company's findings at the time of its intervention only and within the limits of Client's instructions, if any. The Company's sole responsibility is to its Client and this document does not exonerate parties to a transaction from exercising all their rights and obligations under the transaction documents. This document cannot be reproduced except in full, without prior written approval of the Company. Any unauthorized alteration, forgery or falsification of the content or appearance of this document is unlawful and offenders may be prosecuted to the fullest extent of the law.

### 12.3. Measurement Procedure:

The equipment under test was connected to an external AC or DC power supply and input rated voltage. RF output was connected to a frequency counter or spectrum analyzer via feed through attenuators. The EUT was placed inside the temperature chamber. Set the spectrum analyzer RBW low enough to obtain the desired frequency resolution and measure EUT 25°C operating frequency as reference frequency. Turn EUT off and set the chamber temperature to -30°C. After the temperature stabilized for approximately 30 minutes recorded the frequency. Repeat step measure with 10°C increased per stage until the highest temperature of +50°C reached.

### 12.4. Measurement Equipment Used:

Refer to section 2.4 in this report

Unless otherwise stated the results shown in this test report refer only to the sample(s) tested and such sample(s) are retained for 90 days only.

除非另有說明，此報告結果僅對測試之樣品負責，同時此樣品僅保留90天。本報告未經本公司書面許可，不可部份複製。

This document is issued by the Company subject to its General Conditions of Service printed overleaf, available on request or accessible at [www.sgs.com/terms\\_and\\_conditions.htm](http://www.sgs.com/terms_and_conditions.htm) and, for electronic format documents, subject to Terms and Conditions for Electronic Documents at [www.sgs.com/terms\\_e-document.htm](http://www.sgs.com/terms_e-document.htm). Attention is drawn to the limitation of liability, indemnification and jurisdiction issues defined therein. Any holder of this document is advised that information contained hereon reflects the Company's findings at the time of its intervention only and within the limits of Client's instructions, if any. The Company's sole responsibility is to its Client and this document does not exonerate parties to a transaction from exercising all their rights and obligations under the transaction documents. This document cannot be reproduced except in full, without prior written approval of the Company. Any unauthorized alteration, forgery or falsification of the content or appearance of this document is unlawful and offenders may be prosecuted to the fullest extent of the law.

**12.5. Measurement Result:**

Reference Frequency: LTE B4 Mid Channel 1732.5 MHz 1.4M QPSK CH 20175				
Limit: +/- 2.5 ppm = Hz				
Power Supply	Environment	Frequency	Delta (Hz)	Limit (Hz)
Vdc	Temperature ( )	(MHz)		
3.3	-30	1732.499987	-1.70	4331
3.3	-20	1732.499989	0.00	4331
3.3	-10	1732.499987	-1.50	4331
3.3	0	1732.499986	-2.40	4331
3.3	10	1732.499982	-6.90	4331
3.3	20	1732.499989	0.00	4331
3.3	30	1732.499988	-0.60	4331
3.3	40	1732.499990	1.00	4331
3.3	50	1732.499988	-0.40	4331

Reference Frequency: LTE B4 Mid Channel 1732.5 MHz 1.4M 16QAM CH 20175				
Limit: +/- 2.5 ppm = Hz				
Power Supply	Environment	Frequency	Delta (Hz)	Limit (Hz)
Vdc	Temperature ( )	(MHz)		
3.3	-30	1732.499981	-1.00	4331
3.3	-20	1732.499983	1.70	4331
3.3	-10	1732.499985	3.60	4331
3.3	0	1732.499986	4.60	4331
3.3	10	1732.499987	5.80	4331
3.3	20	1732.499982	0.00	4331
3.3	30	1732.499981	-1.00	4331
3.3	40	1732.499989	7.80	4331
3.3	50	1732.499988	5.90	4331

Unless otherwise stated the results shown in this test report refer only to the sample(s) tested and such sample(s) are retained for 90 days only.

除非另有說明，此報告結果僅對測試之樣品負責，同時此樣品僅保留90天。本報告未經本公司書面許可，不可部份複製。

This document is issued by the Company subject to its General Conditions of Service printed overleaf, available on request or accessible at [www.sgs.com/terms\\_and\\_conditions.htm](http://www.sgs.com/terms_and_conditions.htm) and, for electronic format documents, subject to Terms and Conditions for Electronic Documents at [www.sgs.com/terms\\_e-document.htm](http://www.sgs.com/terms_e-document.htm). Attention is drawn to the limitation of liability, indemnification and jurisdiction issues defined therein. Any holder of this document is advised that information contained hereon reflects the Company's findings at the time of its intervention only and within the limits of Client's instructions, if any. The Company's sole responsibility is to its Client and this document does not exonerate parties to a transaction from exercising all their rights and obligations under the transaction documents. This document cannot be reproduced except in full, without prior written approval of the Company. Any unauthorized alteration, forgery or falsification of the content or appearance of this document is unlawful and offenders may be prosecuted to the fullest extent of the law.

Reference Frequency: LTE B4 Mid Channel 1732.5 MHz 3M QPSK CH 20175				
Limit: +/- 2.5 ppm = Hz				
Power Supply	Environment	Frequency	Delta (Hz)	Limit (Hz)
Vdc	Temperature ( )	(MHz)		
3.3	-30	1732.500007	2.00	4331
3.3	-20	1732.500007	1.40	4331
3.3	-10	1732.500008	3.30	4331
3.3	0	1732.500004	-1.50	4331
3.3	10	1732.500009	3.60	4331
3.3	20	1732.500005	0.00	4331
3.3	30	1732.500007	1.60	4331
3.3	40	1732.500009	4.00	4331
3.3	50	1732.500012	6.90	4331

Reference Frequency: LTE B4 Mid Channel 1732.5 MHz 3M 16QAM CH 20175				
Limit: +/- 2.5 ppm = Hz				
Power Supply	Environment	Frequency	Delta (Hz)	Limit (Hz)
Vdc	Temperature ( )	(MHz)		
3.3	-30	1732.500003	-0.50	4331
3.3	-20	1732.500006	1.80	4331
3.3	-10	1732.500006	1.90	4331
3.3	0	1732.500006	2.30	4331
3.3	10	1732.500005	1.00	4331
3.3	20	1732.500004	0.00	4331
3.3	30	1732.500009	4.80	4331
3.3	40	1732.500006	1.90	4331
3.3	50	1732.500009	5.00	4331

Unless otherwise stated the results shown in this test report refer only to the sample(s) tested and such sample(s) are retained for 90 days only.

除非另有說明，此報告結果僅對測試之樣品負責，同時此樣品僅保留90天。本報告未經本公司書面許可，不可部份複製。

This document is issued by the Company subject to its General Conditions of Service printed overleaf, available on request or accessible at [www.sgs.com/terms\\_and\\_conditions.htm](http://www.sgs.com/terms_and_conditions.htm) and, for electronic format documents, subject to Terms and Conditions for Electronic Documents at [www.sgs.com/terms\\_e-document.htm](http://www.sgs.com/terms_e-document.htm). Attention is drawn to the limitation of liability, indemnification and jurisdiction issues defined therein. Any holder of this document is advised that information contained hereon reflects the Company's findings at the time of its intervention only and within the limits of Client's instructions, if any. The Company's sole responsibility is to its Client and this document does not exonerate parties to a transaction from exercising all their rights and obligations under the transaction documents. This document cannot be reproduced except in full, without prior written approval of the Company. Any unauthorized alteration, forgery or falsification of the content or appearance of this document is unlawful and offenders may be prosecuted to the fullest extent of the law.

Reference Frequency: LTE B4 Mid Channel 1732.5 MHz 5M QPSK CH 20175				
Limit: +/- 2.5 ppm = Hz				
Power Supply	Environment	Frequency	Delta (Hz)	Limit (Hz)
Vdc	Temperature ( )	(MHz)		
3.3	-30	1732.500013	4.30	4331
3.3	-20	1732.500014	4.80	4331
3.3	-10	1732.500011	2.70	4331
3.3	0	1732.500013	4.20	4331
3.3	10	1732.500011	1.80	4331
3.3	20	1732.500009	0.00	4331
3.3	30	1732.500006	-2.30	4331
3.3	40	1732.499989	-19.90	4331
3.3	50	1732.499995	-14.10	4331

Reference Frequency: LTE B4 Mid Channel 1732.5 MHz 5M 16QAM CH 20175				
Limit: +/- 2.5 ppm = Hz				
Power Supply	Environment	Frequency	Delta (Hz)	Limit (Hz)
Vdc	Temperature ( )	(MHz)		
3.3	-30	1732.500007	3.80	4331
3.3	-20	1732.500004	0.80	4331
3.3	-10	1732.500007	3.60	4331
3.3	0	1732.500006	2.80	4331
3.3	10	1732.500005	1.50	4331
3.3	20	1732.500003	0.00	4331
3.3	30	1732.500003	-0.20	4331
3.3	40	1732.500002	-0.90	4331
3.3	50	1732.499992	-10.90	4331

Unless otherwise stated the results shown in this test report refer only to the sample(s) tested and such sample(s) are retained for 90 days only.

除非另有說明，此報告結果僅對測試之樣品負責，同時此樣品僅保留90天。本報告未經本公司書面許可，不可部份複製。

This document is issued by the Company subject to its General Conditions of Service printed overleaf, available on request or accessible at [www.sgs.com/terms\\_and\\_conditions.htm](http://www.sgs.com/terms_and_conditions.htm) and, for electronic format documents, subject to Terms and Conditions for Electronic Documents at [www.sgs.com/terms\\_e-document.htm](http://www.sgs.com/terms_e-document.htm). Attention is drawn to the limitation of liability, indemnification and jurisdiction issues defined therein. Any holder of this document is advised that information contained hereon reflects the Company's findings at the time of its intervention only and within the limits of Client's instructions, if any. The Company's sole responsibility is to its Client and this document does not exonerate parties to a transaction from exercising all their rights and obligations under the transaction documents. This document cannot be reproduced except in full, without prior written approval of the Company. Any unauthorized alteration, forgery or falsification of the content or appearance of this document is unlawful and offenders may be prosecuted to the fullest extent of the law.

SGS Taiwan Ltd.

No.134,WuKungRoad,NewTaipeiIndustrialPark,WukuDistrict,NewTaipeiCity,Taiwan24803/新北市五股區新北產業園區五工路 134 號

台灣檢驗科技股份有限公司

t (886-2) 2299-3279

f (886-2) 2298-0488

[www.tw.sgs.com](http://www.tw.sgs.com)

Member of SGS Group

Reference Frequency: LTE B4 Mid Channel 1732.5 MHz 10M QPSK CH 20175				
Limit: +/- 2.5 ppm = Hz				
Power Supply	Environment	Frequency	Delta (Hz)	Limit (Hz)
Vdc	Temperature ( )	(MHz)		
3.3	-30	1732.500011	4.60	4331
3.3	-20	1732.500010	3.60	4331
3.3	-10	1732.500009	2.80	4331
3.3	0	1732.499999	-7.30	4331
3.3	10	1732.499994	-11.90	4331
3.3	20	1732.500006	0.00	4331
3.3	30	1732.500004	-2.40	4331
3.3	40	1732.499995	-11.50	4331
3.3	50	1732.499993	-13.20	4331

Reference Frequency: LTE B4 Mid Channel 1732.5 MHz 10M 16QAM CH 20175				
Limit: +/- 2.5 ppm = Hz				
Power Supply	Environment	Frequency	Delta (Hz)	Limit (Hz)
Vdc	Temperature ( )	(MHz)		
3.3	-30	1732.500005	2.40	4331
3.3	-20	1732.500006	2.80	4331
3.3	-10	1732.500007	4.00	4331
3.3	0	1732.500001	-1.80	4331
3.3	10	1732.500003	-0.10	4331
3.3	20	1732.500003	0.00	4331
3.3	30	1732.500004	0.90	4331
3.3	40	1732.500005	2.50	4331
3.3	50	1732.499989	-13.50	4331

Unless otherwise stated the results shown in this test report refer only to the sample(s) tested and such sample(s) are retained for 90 days only.

除非另有說明，此報告結果僅對測試之樣品負責，同時此樣品僅保留90天。本報告未經本公司書面許可，不可部份複製。

This document is issued by the Company subject to its General Conditions of Service printed overleaf, available on request or accessible at [www.sgs.com/terms\\_and\\_conditions.htm](http://www.sgs.com/terms_and_conditions.htm) and, for electronic format documents, subject to Terms and Conditions for Electronic Documents at [www.sgs.com/terms\\_e-document.htm](http://www.sgs.com/terms_e-document.htm). Attention is drawn to the limitation of liability, indemnification and jurisdiction issues defined therein. Any holder of this document is advised that information contained hereon reflects the Company's findings at the time of its intervention only and within the limits of Client's instructions, if any. The Company's sole responsibility is to its Client and this document does not exonerate parties to a transaction from exercising all their rights and obligations under the transaction documents. This document cannot be reproduced except in full, without prior written approval of the Company. Any unauthorized alteration, forgery or falsification of the content or appearance of this document is unlawful and offenders may be prosecuted to the fullest extent of the law.

Reference Frequency: LTE B4 Mid Channel 1732.5 MHz 15M QPSK CH 20175				
Limit: +/- 2.5 ppm = Hz				
Power Supply	Environment	Frequency	Delta (Hz)	Limit (Hz)
Vdc	Temperature ( )	(MHz)		
3.3	-30	1732.500008	5.40	4331
3.3	-20	1732.500006	3.70	4331
3.3	-10	1732.500004	1.50	4331
3.3	0	1732.500003	1.00	4331
3.3	10	1732.499999	-3.70	4331
3.3	20	1732.500002	0.00	4331
3.3	30	1732.500003	1.20	4331
3.3	40	1732.500001	-1.10	4331
3.3	50	1732.499994	-8.10	4331

Reference Frequency: LTE B4 Mid Channel 1732.5 MHz 15M 16QAM CH 20175				
Limit: +/- 2.5 ppm = Hz				
Power Supply	Environment	Frequency	Delta (Hz)	Limit (Hz)
Vdc	Temperature ( )	(MHz)		
3.3	-30	1732.500004	0.50	4331
3.3	-20	1732.500004	0.00	4331
3.3	-10	1732.500006	1.90	4331
3.3	0	1732.500006	2.30	4331
3.3	10	1732.500002	-1.40	4331
3.3	20	1732.500004	0.00	4331
3.3	30	1732.499999	-5.20	4331
3.3	40	1732.500004	-0.30	4331
3.3	50	1732.499994	-9.50	4331

Unless otherwise stated the results shown in this test report refer only to the sample(s) tested and such sample(s) are retained for 90 days only.

除非另有說明，此報告結果僅對測試之樣品負責，同時此樣品僅保留90天。本報告未經本公司書面許可，不可部份複製。

This document is issued by the Company subject to its General Conditions of Service printed overleaf, available on request or accessible at [www.sgs.com/terms\\_and\\_conditions.htm](http://www.sgs.com/terms_and_conditions.htm) and, for electronic format documents, subject to Terms and Conditions for Electronic Documents at [www.sgs.com/terms\\_e-document.htm](http://www.sgs.com/terms_e-document.htm). Attention is drawn to the limitation of liability, indemnification and jurisdiction issues defined therein. Any holder of this document is advised that information contained hereon reflects the Company's findings at the time of its intervention only and within the limits of Client's instructions, if any. The Company's sole responsibility is to its Client and this document does not exonerate parties to a transaction from exercising all their rights and obligations under the transaction documents. This document cannot be reproduced except in full, without prior written approval of the Company. Any unauthorized alteration, forgery or falsification of the content or appearance of this document is unlawful and offenders may be prosecuted to the fullest extent of the law.

SGS Taiwan Ltd.

No.134,WuKungRoad,NewTaipeiIndustrialPark,WukuDistrict,NewTaipeiCity,Taiwan24803/新北市五股區新北產業園區五工路 134 號

台灣檢驗科技股份有限公司

t (886-2) 2299-3279

f (886-2) 2298-0488

www.tw.sgs.com

Member of SGS Group



Reference Frequency: LTE B4 Mid Channel 1732.5 MHz 20M QPSK CH 20175				
Limit: +/- 2.5 ppm = Hz				
Power Supply	Environment	Frequency	Delta (Hz)	Limit (Hz)
Vdc	Temperature ( )	(MHz)		
3.3	-30	1732.499993	-9.10	4331
3.3	-20	1732.500004	1.40	4331
3.3	-10	1732.499998	-4.10	4331
3.3	0	1732.499997	-5.00	4331
3.3	10	1732.499994	-8.00	4331
3.3	20	1732.500002	0.00	4331
3.3	30	1732.500003	0.20	4331
3.3	40	1732.500003	0.80	4331
3.3	50	1732.500014	11.40	4331

Reference Frequency: LTE B4 Mid Channel 1732.5 MHz 20M 16QAM CH 20175				
Limit: +/- 2.5 ppm = Hz				
Power Supply	Environment	Frequency	Delta (Hz)	Limit (Hz)
Vdc	Temperature ( )	(MHz)		
3.3	-30	1732.499995	-1.00	4331
3.3	-20	1732.499993	-3.70	4331
3.3	-10	1732.499994	-2.60	4331
3.3	0	1732.499991	-5.60	4331
3.3	10	1732.499997	0.30	4331
3.3	20	1732.499996	0.00	4331
3.3	30	1732.499997	0.90	4331
3.3	40	1732.499991	-4.80	4331
3.3	50	1732.499993	-3.60	4331

Unless otherwise stated the results shown in this test report refer only to the sample(s) tested and such sample(s) are retained for 90 days only.

除非另有說明，此報告結果僅對測試之樣品負責，同時此樣品僅保留90天。本報告未經本公司書面許可，不可部份複製。

This document is issued by the Company subject to its General Conditions of Service printed overleaf, available on request or accessible at [www.sgs.com/terms\\_and\\_conditions.htm](http://www.sgs.com/terms_and_conditions.htm) and, for electronic format documents, subject to Terms and Conditions for Electronic Documents at [www.sgs.com/terms\\_e-document.htm](http://www.sgs.com/terms_e-document.htm). Attention is drawn to the limitation of liability, indemnification and jurisdiction issues defined therein. Any holder of this document is advised that information contained hereon reflects the Company's findings at the time of its intervention only and within the limits of Client's instructions, if any. The Company's sole responsibility is to its Client and this document does not exonerate parties to a transaction from exercising all their rights and obligations under the transaction documents. This document cannot be reproduced except in full, without prior written approval of the Company. Any unauthorized alteration, forgery or falsification of the content or appearance of this document is unlawful and offenders may be prosecuted to the fullest extent of the law.

Reference Frequency: LTE B13 Mid Channel 782 MHz @ 5M QPSK CH 23230				
Limit: +/- 2.5 ppm = Hz				
Power Supply	Environment	Frequency	Delta (Hz)	Limit (Hz)
Vdc	Temperature ( )	(MHz)		
3.3	-30	781.999980	2.00	1955
3.3	-20	781.999981	2.90	1955
3.3	-10	781.999981	3.70	1955
3.3	0	781.999981	2.90	1955
3.3	10	781.999984	6.10	1955
3.3	20	781.999978	0.00	1955
3.3	30	781.999985	7.10	1955
3.3	40	781.999986	8.60	1955
3.3	50	781.999989	11.10	1955

Reference Frequency: LTE B13 Mid Channel 782 MHz 5M 16QAM CH 23230				
Limit: +/- 2.5 ppm = Hz				
Power Supply	Environment	Frequency	Delta (Hz)	Limit (Hz)
Vdc	Temperature ( )	(MHz)		
3.3	-30	781.999984	3.30	1955
3.3	-20	781.999986	5.20	1955
3.3	-10	781.999987	5.70	1955
3.3	0	781.999985	3.50	1955
3.3	10	781.999981	-0.20	1955
3.3	20	781.999981	0.00	1955
3.3	30	781.999982	0.50	1955
3.3	40	781.999982	1.00	1955
3.3	50	781.999982	0.70	1955

Unless otherwise stated the results shown in this test report refer only to the sample(s) tested and such sample(s) are retained for 90 days only.

除非另有說明，此報告結果僅對測試之樣品負責，同時此樣品僅保留90天。本報告未經本公司書面許可，不可部份複製。

This document is issued by the Company subject to its General Conditions of Service printed overleaf, available on request or accessible at [www.sgs.com/terms\\_and\\_conditions.htm](http://www.sgs.com/terms_and_conditions.htm) and, for electronic format documents, subject to Terms and Conditions for Electronic Documents at [www.sgs.com/terms\\_e-document.htm](http://www.sgs.com/terms_e-document.htm). Attention is drawn to the limitation of liability, indemnification and jurisdiction issues defined therein. Any holder of this document is advised that information contained hereon reflects the Company's findings at the time of its intervention only and within the limits of Client's instructions, if any. The Company's sole responsibility is to its Client and this document does not exonerate parties to a transaction from exercising all their rights and obligations under the transaction documents. This document cannot be reproduced except in full, without prior written approval of the Company. Any unauthorized alteration, forgery or falsification of the content or appearance of this document is unlawful and offenders may be prosecuted to the fullest extent of the law.

Reference Frequency: LTE B13 Mid Channel 782 MHz 10M QPSK CH 23230				
Limit: +/- 2.5 ppm = Hz				
Power Supply	Environment	Frequency	Delta (Hz)	Limit (Hz)
Vdc	Temperature ( )	(MHz)		
3.3	-30	781.999992	-1.20	1955
3.3	-20	781.999994	0.80	1955
3.3	-10	781.999992	-1.10	1955
3.3	0	781.999990	-2.50	1955
3.3	10	781.999992	-1.10	1955
3.3	20	781.999993	0.00	1955
3.3	30	781.999992	-0.40	1955
3.3	40	781.999991	-1.70	1955
3.3	50	781.999993	-0.20	1955

Reference Frequency: LTE B13 Mid Channel 782 MHz 10M 16QAM CH 23230				
Limit: +/- 2.5 ppm = Hz				
Power Supply	Environment	Frequency	Delta (Hz)	Limit (Hz)
Vdc	Temperature ( )	(MHz)		
3.3	-30	781.999992	0.90	1955
3.3	-20	781.999993	1.40	1955
3.3	-10	781.999993	1.60	1955
3.3	0	781.999992	0.00	1955
3.3	10	781.999991	-0.60	1955
3.3	20	781.999992	0.00	1955
3.3	30	781.999992	0.20	1955
3.3	40	781.999992	0.10	1955
3.3	50	781.999991	-0.20	1955

Unless otherwise stated the results shown in this test report refer only to the sample(s) tested and such sample(s) are retained for 90 days only.

除非另有說明，此報告結果僅對測試之樣品負責，同時此樣品僅保留90天。本報告未經本公司書面許可，不可部份複製。

This document is issued by the Company subject to its General Conditions of Service printed overleaf, available on request or accessible at [www.sgs.com/terms\\_and\\_conditions.htm](http://www.sgs.com/terms_and_conditions.htm) and, for electronic format documents, subject to Terms and Conditions for Electronic Documents at [www.sgs.com/terms\\_e-document.htm](http://www.sgs.com/terms_e-document.htm). Attention is drawn to the limitation of liability, indemnification and jurisdiction issues defined therein. Any holder of this document is advised that information contained hereon reflects the Company's findings at the time of its intervention only and within the limits of Client's instructions, if any. The Company's sole responsibility is to its Client and this document does not exonerate parties to a transaction from exercising all their rights and obligations under the transaction documents. This document cannot be reproduced except in full, without prior written approval of the Company. Any unauthorized alteration, forgery or falsification of the content or appearance of this document is unlawful and offenders may be prosecuted to the fullest extent of the law.

SGS Taiwan Ltd.

No.134,WuKungRoad,NewTaipeiIndustrialPark,WukuDistrict,NewTaipeiCity,Taiwan24803/新北市五股區新北產業園區五工路 134 號

台灣檢驗科技股份有限公司

t (886-2) 2299-3279

f (886-2) 2298-0488

[www.tw.sgs.com](http://www.tw.sgs.com)

Member of SGS Group

## 13. FREQUENCY STABILITY V.S. VOLTAGE MEASUREMENT

### 13.1. Standard Applicable:

According to FCC §2.1055(d) (2)

Frequency Tolerance: +/-2.5ppm for 1700MHz band

+/-2.5ppm for 700MHz band

The carrier frequency shall not depart from the reference frequency in excess of  $\pm 2.5$  ppm for mobile stations.

### 13.2. Test Set-up:

Refer to section 10.2 in this report

### 13.3. Measurement Procedure:

Set chamber temperature to 25 . Use a variable AC power supply / DC power source to power the EUT and set the voltage to rated voltage. Set the spectrum analyzer RBW low enough to obtain the desired frequency resolution and recorded the frequency.

Reduce the input voltage to specified extreme-voltage-variation (+/- 15%) and endpoint, record the maximum frequency change.

### 13.4. Measurement Equipment Used:

Refer to section 2.4 in this report

Unless otherwise stated the results shown in this test report refer only to the sample(s) tested and such sample(s) are retained for 90 days only.

除非另有說明，此報告結果僅對測試之樣品負責，同時此樣品僅保留90天。本報告未經本公司書面許可，不可部份複製。

This document is issued by the Company subject to its General Conditions of Service printed overleaf, available on request or accessible at [www.sgs.com/terms\\_and\\_conditions.htm](http://www.sgs.com/terms_and_conditions.htm) and, for electronic format documents, subject to Terms and Conditions for Electronic Documents at [www.sgs.com/terms\\_e-document.htm](http://www.sgs.com/terms_e-document.htm). Attention is drawn to the limitation of liability, indemnification and jurisdiction issues defined therein. Any holder of this document is advised that information contained hereon reflects the Company's findings at the time of its intervention only and within the limits of Client's instructions, if any. The Company's sole responsibility is to its Client and this document does not exonerate parties to a transaction from exercising all their rights and obligations under the transaction documents. This document cannot be reproduced except in full, without prior written approval of the Company. Any unauthorized alteration, forgery or falsification of the content or appearance of this document is unlawful and offenders may be prosecuted to the fullest extent of the law.

**13.5. Measurement Result:**

Reference Frequency: LTE B4 Mid Channel 1732.5 MHz @ 25 1.4M QPSK CH 20175				
Limit: +/- 2.5 ppm = Hz				
Power Supply	Environment	Frequency	Delta (Hz)	Limit (Hz)
Vdc	Temperature ( )	(MHz)		
3.465	25	1732.500010	-1.00	4331
3.300	25	1732.500011	0.00	4331
3.135	25	1732.500008	-2.10	4331
2.92 (End Point)	25	1732.500001	-9.20	4331

Reference Frequency: LTE B4 Mid Channel 1732.5 MHz @ 25 1.4M 16QAM CH 20175				
Limit: +/- 2.5 ppm = Hz				
Power Supply	Environment	Frequency	Delta (Hz)	Limit (Hz)
Vdc	Temperature ( )	(MHz)		
3.465	25	1732.500004	-1.50	4331
3.300	25	1732.500005	0.00	4331
3.135	25	1732.500005	-0.60	4331
2.92 (End Point)	25	1732.500003	-2.90	4331

Unless otherwise stated the results shown in this test report refer only to the sample(s) tested and such sample(s) are retained for 90 days only.

除非另有說明，此報告結果僅對測試之樣品負責，同時此樣品僅保留90天。本報告未經本公司書面許可，不可部份複製。

This document is issued by the Company subject to its General Conditions of Service printed overleaf, available on request or accessible at [www.sgs.com/terms\\_and\\_conditions.htm](http://www.sgs.com/terms_and_conditions.htm) and, for electronic format documents, subject to Terms and Conditions for Electronic Documents at [www.sgs.com/terms\\_e-document.htm](http://www.sgs.com/terms_e-document.htm). Attention is drawn to the limitation of liability, indemnification and jurisdiction issues defined therein. Any holder of this document is advised that information contained hereon reflects the Company's findings at the time of its intervention only and within the limits of Client's instructions, if any. The Company's sole responsibility is to its Client and this document does not exonerate parties to a transaction from exercising all their rights and obligations under the transaction documents. This document cannot be reproduced except in full, without prior written approval of the Company. Any unauthorized alteration, forgery or falsification of the content or appearance of this document is unlawful and offenders may be prosecuted to the fullest extent of the law.

Reference Frequency: LTE B4 Mid Channel 1732.5 MHz @ 25 3M QPSK CH 20175				
Limit: +/- 2.5 ppm = Hz				
Power Supply	Environment	Frequency	Delta (Hz)	Limit (Hz)
Vdc	Temperature ( )	(MHz)		
3.465	25	1732.500006	-1.30	4331
3.300	25	1732.500007	0.00	4331
3.135	25	1732.500012	4.70	4331
2.92 (End Point)	25	1732.500011	3.80	4331

Reference Frequency: LTE B4 Mid Channel 1732.5 MHz @ 25 3M 16QAM CH 20175				
Limit: +/- 2.5 ppm = Hz				
Power Supply	Environment	Frequency	Delta (Hz)	Limit (Hz)
Vdc	Temperature ( )	(MHz)		
3.465	25	1732.500007	-2.50	4331
3.300	25	1732.500009	0.00	4331
3.135	25	1732.500012	3.00	4331
2.92 (End Point)	25	1732.500011	1.80	4331

Unless otherwise stated the results shown in this test report refer only to the sample(s) tested and such sample(s) are retained for 90 days only.

除非另有說明，此報告結果僅對測試之樣品負責，同時此樣品僅保留90天。本報告未經本公司書面許可，不可部份複製。

This document is issued by the Company subject to its General Conditions of Service printed overleaf, available on request or accessible at [www.sgs.com/terms\\_and\\_conditions.htm](http://www.sgs.com/terms_and_conditions.htm) and, for electronic format documents, subject to Terms and Conditions for Electronic Documents at [www.sgs.com/terms\\_e-document.htm](http://www.sgs.com/terms_e-document.htm). Attention is drawn to the limitation of liability, indemnification and jurisdiction issues defined therein. Any holder of this document is advised that information contained hereon reflects the Company's findings at the time of its intervention only and within the limits of Client's instructions, if any. The Company's sole responsibility is to its Client and this document does not exonerate parties to a transaction from exercising all their rights and obligations under the transaction documents. This document cannot be reproduced except in full, without prior written approval of the Company. Any unauthorized alteration, forgery or falsification of the content or appearance of this document is unlawful and offenders may be prosecuted to the fullest extent of the law.

Reference Frequency: LTE B4 Mid Channel 1732.5 MHz @ 25 5M QPSK CH 20175				
Limit: +/- 2.5 ppm = Hz				
Power Supply	Environment	Frequency	Delta (Hz)	Limit (Hz)
Vdc	Temperature ( )	(MHz)		
3.465	25	1732.500006	-3.20	4331
3.300	25	1732.500010	0.00	4331
3.135	25	1732.500005	-4.60	4331
2.92 (End Point)	25	1732.500006	-3.70	4331

Reference Frequency: LTE B4 Mid Channel 1732.5 MHz @ 25 5M 16QAM CH 20175				
Limit: +/- 2.5 ppm = Hz				
Power Supply	Environment	Frequency	Delta (Hz)	Limit (Hz)
Vdc	Temperature ( )	(MHz)		
3.465	25	1732.500007	-2.40	4331
3.300	25	1732.500009	0.00	4331
3.135	25	1732.500005	-4.10	4331
2.92 (End Point)	25	1732.500007	-2.40	4331

Unless otherwise stated the results shown in this test report refer only to the sample(s) tested and such sample(s) are retained for 90 days only.

除非另有說明，此報告結果僅對測試之樣品負責，同時此樣品僅保留90天。本報告未經本公司書面許可，不可部份複製。

This document is issued by the Company subject to its General Conditions of Service printed overleaf, available on request or accessible at [www.sgs.com/terms\\_and\\_conditions.htm](http://www.sgs.com/terms_and_conditions.htm) and, for electronic format documents, subject to Terms and Conditions for Electronic Documents at [www.sgs.com/terms\\_e-document.htm](http://www.sgs.com/terms_e-document.htm). Attention is drawn to the limitation of liability, indemnification and jurisdiction issues defined therein. Any holder of this document is advised that information contained hereon reflects the Company's findings at the time of its intervention only and within the limits of Client's instructions, if any. The Company's sole responsibility is to its Client and this document does not exonerate parties to a transaction from exercising all their rights and obligations under the transaction documents. This document cannot be reproduced except in full, without prior written approval of the Company. Any unauthorized alteration, forgery or falsification of the content or appearance of this document is unlawful and offenders may be prosecuted to the fullest extent of the law.

Reference Frequency: LTE B4 Mid Channel 1732.5 MHz @ 25 10M QPSK CH 20175				
Limit: +/- 2.5 ppm = Hz				
Power Supply	Environment	Frequency	Delta (Hz)	Limit (Hz)
Vdc	Temperature ( )	(MHz)		
3.465	25	1732.500004	-1.60	4331
3.300	25	1732.500005	0.00	4331
3.135	25	1732.500004	-1.80	4331
2.92 (End Point)	25	1732.500004	-1.10	4331

Reference Frequency: LTE B4 Mid Channel 1732.5 MHz @ 25 10M 16QAM CH 20175				
Limit: +/- 2.5 ppm = Hz				
Power Supply	Environment	Frequency	Delta (Hz)	Limit (Hz)
Vdc	Temperature ( )	(MHz)		
3.465	25	1732.500004	-0.80	4331
3.300	25	1732.500005	0.00	4331
3.135	25	1732.500005	-0.50	4331
2.92 (End Point)	25	1732.500006	0.80	4331

Unless otherwise stated the results shown in this test report refer only to the sample(s) tested and such sample(s) are retained for 90 days only.

除非另有說明，此報告結果僅對測試之樣品負責，同時此樣品僅保留90天。本報告未經本公司書面許可，不可部份複製。

This document is issued by the Company subject to its General Conditions of Service printed overleaf, available on request or accessible at [www.sgs.com/terms\\_and\\_conditions.htm](http://www.sgs.com/terms_and_conditions.htm) and, for electronic format documents, subject to Terms and Conditions for Electronic Documents at [www.sgs.com/terms\\_e-document.htm](http://www.sgs.com/terms_e-document.htm). Attention is drawn to the limitation of liability, indemnification and jurisdiction issues defined therein. Any holder of this document is advised that information contained hereon reflects the Company's findings at the time of its intervention only and within the limits of Client's instructions, if any. The Company's sole responsibility is to its Client and this document does not exonerate parties to a transaction from exercising all their rights and obligations under the transaction documents. This document cannot be reproduced except in full, without prior written approval of the Company. Any unauthorized alteration, forgery or falsification of the content or appearance of this document is unlawful and offenders may be prosecuted to the fullest extent of the law.



Reference Frequency: LTE B4 Mid Channel 1732.5 MHz @ 25 15M QPSK CH 20175				
Limit: +/- 2.5 ppm = Hz				
Power Supply	Environment	Frequency	Delta (Hz)	Limit (Hz)
Vdc	Temperature ( )	(MHz)		
3.465	25	1732.499998	4.20	4331
3.300	25	1732.499994	0.00	4331
3.135	25	1732.499997	3.20	4331
2.92 (End Point)	25	1732.499996	2.00	4331

Reference Frequency: LTE B4 Mid Channel 1732.5 MHz @ 25 15M 16QAM CH 20175				
Limit: +/- 2.5 ppm = Hz				
Power Supply	Environment	Frequency	Delta (Hz)	Limit (Hz)
Vdc	Temperature ( )	(MHz)		
3.465	25	1732.499996	-1.20	4331
3.300	25	1732.499997	0.00	4331
3.135	25	1732.499996	-0.80	4331
2.92 (End Point)	25	1732.499996	-1.00	4331

Unless otherwise stated the results shown in this test report refer only to the sample(s) tested and such sample(s) are retained for 90 days only.

除非另有說明，此報告結果僅對測試之樣品負責，同時此樣品僅保留90天。本報告未經本公司書面許可，不可部份複製。

This document is issued by the Company subject to its General Conditions of Service printed overleaf, available on request or accessible at [www.sgs.com/terms\\_and\\_conditions.htm](http://www.sgs.com/terms_and_conditions.htm) and, for electronic format documents, subject to Terms and Conditions for Electronic Documents at [www.sgs.com/terms\\_e-document.htm](http://www.sgs.com/terms_e-document.htm). Attention is drawn to the limitation of liability, indemnification and jurisdiction issues defined therein. Any holder of this document is advised that information contained hereon reflects the Company's findings at the time of its intervention only and within the limits of Client's instructions, if any. The Company's sole responsibility is to its Client and this document does not exonerate parties to a transaction from exercising all their rights and obligations under the transaction documents. This document cannot be reproduced except in full, without prior written approval of the Company. Any unauthorized alteration, forgery or falsification of the content or appearance of this document is unlawful and offenders may be prosecuted to the fullest extent of the law.

Reference Frequency: LTE B4 Mid Channel 1732.5 MHz @ 25 20M QPSK CH 20175				
Limit: +/- 2.5 ppm = 2091 Hz				
Power Supply	Environment	Frequency	Delta (Hz)	Limit (Hz)
Vdc	Temperature ( )	(MHz)		
3.465	25	1732.500017	-2.30	4331
3.300	25	1732.500019	0.00	4331
3.135	25	1732.500015	-3.80	4331
2.92 (End Point)	25	1732.500017	-1.70	4331

Reference Frequency: LTE B4 Mid Channel 1732.5 MHz @ 25 20M 16QAM CH 20175				
Limit: +/- 2.5 ppm = Hz				
Power Supply	Environment	Frequency	Delta (Hz)	Limit (Hz)
Vdc	Temperature ( )	(MHz)		
3.465	25	1732.500013	0.90	4331
3.300	25	1732.500012	0.00	4331
3.135	25	1732.500014	1.80	4331
2.92 (End Point)	25	1732.500015	3.50	4331

Unless otherwise stated the results shown in this test report refer only to the sample(s) tested and such sample(s) are retained for 90 days only.

除非另有說明，此報告結果僅對測試之樣品負責，同時此樣品僅保留90天。本報告未經本公司書面許可，不可部份複製。

This document is issued by the Company subject to its General Conditions of Service printed overleaf, available on request or accessible at [www.sgs.com/terms\\_and\\_conditions.htm](http://www.sgs.com/terms_and_conditions.htm) and, for electronic format documents, subject to Terms and Conditions for Electronic Documents at [www.sgs.com/terms\\_e-document.htm](http://www.sgs.com/terms_e-document.htm). Attention is drawn to the limitation of liability, indemnification and jurisdiction issues defined therein. Any holder of this document is advised that information contained hereon reflects the Company's findings at the time of its intervention only and within the limits of Client's instructions, if any. The Company's sole responsibility is to its Client and this document does not exonerate parties to a transaction from exercising all their rights and obligations under the transaction documents. This document cannot be reproduced except in full, without prior written approval of the Company. Any unauthorized alteration, forgery or falsification of the content or appearance of this document is unlawful and offenders may be prosecuted to the fullest extent of the law.

Reference Frequency: LTE B13 Mid Channel 782 MHz @ 25 5M QPSK CH 23230				
Limit: +/- 2.5 ppm = Hz				
Power Supply	Environment	Frequency	Delta (Hz)	Limit (Hz)
Vdc	Temperature ( )	(MHz)		
3.465	25	781.999982	8.30	1955
3.300	25	781.999973	0.00	1955
3.135	25	781.999969	-4.40	1955
2.92 (End Point)	25	781.999984	11.20	1955

Reference Frequency: LTE B13 Mid Channel 782MHz @ 25 5M 16QAM CH 23230				
Limit: +/- 2.5 ppm = Hz				
Power Supply	Environment	Frequency	Delta (Hz)	Limit (Hz)
Vdc	Temperature ( )	(MHz)		
3.465	25	781.999997	-0.90	1955
3.300	25	781.999998	0.00	1955
3.135	25	781.999996	-1.60	1955
2.92 (End Point)	25	781.999990	-7.10	1955

Unless otherwise stated the results shown in this test report refer only to the sample(s) tested and such sample(s) are retained for 90 days only.

除非另有說明，此報告結果僅對測試之樣品負責，同時此樣品僅保留90天。本報告未經本公司書面許可，不可部份複製。

This document is issued by the Company subject to its General Conditions of Service printed overleaf, available on request or accessible at [www.sgs.com/terms\\_and\\_conditions.htm](http://www.sgs.com/terms_and_conditions.htm) and, for electronic format documents, subject to Terms and Conditions for Electronic Documents at [www.sgs.com/terms\\_e-document.htm](http://www.sgs.com/terms_e-document.htm). Attention is drawn to the limitation of liability, indemnification and jurisdiction issues defined therein. Any holder of this document is advised that information contained hereon reflects the Company's findings at the time of its intervention only and within the limits of Client's instructions, if any. The Company's sole responsibility is to its Client and this document does not exonerate parties to a transaction from exercising all their rights and obligations under the transaction documents. This document cannot be reproduced except in full, without prior written approval of the Company. Any unauthorized alteration, forgery or falsification of the content or appearance of this document is unlawful and offenders may be prosecuted to the fullest extent of the law.

Reference Frequency: LTE B13 Mid Channel 782 MHz @ 25 10M QPSK CH 23230				
Limit: +/- 2.5 ppm = Hz				
Power Supply	Environment	Frequency	Delta (Hz)	Limit (Hz)
Vdc	Temperature ( )	(MHz)		
3.465	25	781.999984	-8.80	1955
3.300	25	781.999993	0.00	1955
3.135	25	781.999995	2.10	1955
2.92 (End Point)	25	781.999991	-2.60	1955

Reference Frequency: LTE B17 Mid Channel 782 MHz @ 25 10M 16QAM CH 23230				
Limit: +/- 2.5 ppm = Hz				
Power Supply	Environment	Frequency	Delta (Hz)	Limit (Hz)
Vdc	Temperature ( )	(MHz)		
3.465	25	781.999991	3.10	1955
3.300	25	781.999988	0.00	1955
3.135	25	781.999995	6.50	1955
2.92 (End Point)	25	781.999987	-1.20	1955

Unless otherwise stated the results shown in this test report refer only to the sample(s) tested and such sample(s) are retained for 90 days only.

除非另有說明，此報告結果僅對測試之樣品負責，同時此樣品僅保留90天。本報告未經本公司書面許可，不可部份複製。

This document is issued by the Company subject to its General Conditions of Service printed overleaf, available on request or accessible at [www.sgs.com/terms\\_and\\_conditions.htm](http://www.sgs.com/terms_and_conditions.htm) and, for electronic format documents, subject to Terms and Conditions for Electronic Documents at [www.sgs.com/terms\\_e-document.htm](http://www.sgs.com/terms_e-document.htm). Attention is drawn to the limitation of liability, indemnification and jurisdiction issues defined therein. Any holder of this document is advised that information contained hereon reflects the Company's findings at the time of its intervention only and within the limits of Client's instructions, if any. The Company's sole responsibility is to its Client and this document does not exonerate parties to a transaction from exercising all their rights and obligations under the transaction documents. This document cannot be reproduced except in full, without prior written approval of the Company. Any unauthorized alteration, forgery or falsification of the content or appearance of this document is unlawful and offenders may be prosecuted to the fullest extent of the law.

## 14. Maximum Permissible Exposure (MPE)

### 14.1. Related Submittal(s) / Grant (s)

This submittal(s) (test report) is intended to comply with § 2.1091 radiofrequency radiation exposure evaluation: mobile devices of the FCC CFR 47 Rules, CFR 1.1310 (b) Radio frequency Radiation Exposure Requirement.

### 14.2. Special Accessories

Not available for this EUT intended for grant.

### 14.3. Equipment Modifications

Not available for this EUT intended for grant.

### 14.4. Limitation

Frequency Range (MHz)	Electric Field Strength (V/m)	Magnetic Field Strength (A/m)	Power Density (mW/cm <sup>2</sup> )	Averaging Time (minute)
Limits for General Population/Uncontrolled Exposure				
0.3-1.34	614	1.63	*(100)	30
1.34-30	824/f	2.19/f	*(180/f <sup>2</sup> )	30
30-300	27.5	0.073	0.2	30
300-1500	/	/	F/1500	30
1500-15000	/	/	1.0	30

F = frequency in MHz

\* = Plane-wave equipment power density

Frequency Range (MHz)	Electric Field (V/m rms)	Magnetic Field (A/m rms)	Power Density (W/m <sup>2</sup> )	Averaging Time (minutes)
0.003-1	280	2.19	-	6
1-10	280/f	2.19/f	-	6
10-30	28	2.19/f	-	6
30-300	28	0.073	2 <sup>*</sup>	6
300-1500	1.585 f <sup>0.5</sup>	0.0042 f <sup>0.5</sup>	f/150	6
1500-15000	61.4	0.163	10	6
15000-150000	61.4	0.163	10	616000/f <sup>1.2</sup>
150000-300000	0.158 f <sup>0.5</sup>	4.21 x 10 <sup>-4</sup> f <sup>0.5</sup>	6.67 x 10 <sup>-5</sup> f	616000/f <sup>1.2</sup>

Note: f is frequency in MHz.

\* Power density limit is applicable at frequencies greater than 100 MHz.

Unless otherwise stated the results shown in this test report refer only to the sample(s) tested and such sample(s) are retained for 90 days only.

除非另有說明，此報告結果僅對測試之樣品負責，同時此樣品僅保留90天。本報告未經本公司書面許可，不可部份複製。

This document is issued by the Company subject to its General Conditions of Service printed overleaf, available on request or accessible at [www.sgs.com/terms\\_and\\_conditions.htm](http://www.sgs.com/terms_and_conditions.htm) and, for electronic format documents, subject to Terms and Conditions for Electronic Documents at [www.sgs.com/terms\\_e-document.htm](http://www.sgs.com/terms_e-document.htm). Attention is drawn to the limitation of liability, indemnification and jurisdiction issues defined therein. Any holder of this document is advised that information contained hereon reflects the Company's findings at the time of its intervention only and within the limits of Client's instructions, if any. The Company's sole responsibility is to its Client and this document does not exonerate parties to a transaction from exercising all their rights and obligations under the transaction documents. This document cannot be reproduced except in full, without prior written approval of the Company. Any unauthorized alteration, forgery or falsification of the content or appearance of this document is unlawful and offenders may be prosecuted to the fullest extent of the law.

## 14.5. Maximum Permissible Exposure (MPE) Evaluation

The evaluation and calculation as deduces below presents only worst-case that produces highest value of the result:

Operation Configuration of the Worst-Case picked up to evaluate:

### **BAND 4**

**Transmission Band Width: 20M, Modulation: QPSK, RB allocation: 1 offset: 99**

### **BAND 13**

**Transmission Band Width: 5M , Modulation: 16QAM, RB allocation: 1 offset: 24**

Unless otherwise stated the results shown in this test report refer only to the sample(s) tested and such sample(s) are retained for 90 days only.

除非另有說明，此報告結果僅對測試之樣品負責，同時此樣品僅保留90天。本報告未經本公司書面許可，不可部份複製。

This document is issued by the Company subject to its General Conditions of Service printed overleaf, available on request or accessible at [www.sgs.com/terms\\_and\\_conditions.htm](http://www.sgs.com/terms_and_conditions.htm) and, for electronic format documents, subject to Terms and Conditions for Electronic Documents at [www.sgs.com/terms\\_e-document.htm](http://www.sgs.com/terms_e-document.htm). Attention is drawn to the limitation of liability, indemnification and jurisdiction issues defined therein. Any holder of this document is advised that information contained hereon reflects the Company's findings at the time of its intervention only and within the limits of Client's instructions, if any. The Company's sole responsibility is to its Client and this document does not exonerate parties to a transaction from exercising all their rights and obligations under the transaction documents. This document cannot be reproduced except in full, without prior written approval of the Company. Any unauthorized alteration, forgery or falsification of the content or appearance of this document is unlawful and offenders may be prosecuted to the fullest extent of the law.

Operation in LTE band (1712.5 – 1752.5 MHz)

The EIRP in LTE band 4 20MHz /QPSK/RB 1 offset: 99 is 28.27dBm. max. The resulted power density at a distance of 20 cm can be deducted as follows:

BAND 4 / BW: 20M / QPSK / RB: 1 offset: 99								
EUT			Measurement					
Operation Band	Fundamental Frequency	CH	Antenna Pol.	S.G. Output	Antenna Gain	Cable Loss	EIRP	Limit
	MHz		V/H	dBm	dBi	dB	dBm	dBm
LTE Band 4	1720.0	20050	V	23.99	5.76	-4.52	25.22	30.00
			H	20.03	5.76	-4.52	21.27	30.00
	1732.5	20175	V	20.31	5.73	-4.54	21.51	30.00
			H	17.56	5.73	-4.54	18.76	30.00
	1745.0	20300	V	27.03	5.76	-4.52	<b>28.27</b>	30.00
			H	20.33	5.76	-4.52	21.58	30.00

$$EIRP = 28.27 \text{ dBm} = 671.429 \text{ mW}$$

$$\begin{aligned} \text{Power Density} &= EIRP * \text{Duty Cycle} / (4 \pi R^2) \\ &= 671.429 * 1 / (4 * \pi * 20^2) = 0.13358 \text{ mW/cm}^2 \end{aligned}$$

where Duty Cycle is 1 for LTE band 4 20MHz /QPSK/RB 1 offset: 99 operation and R is 20 cm.

The MPE limit for General Population/Uncontrolled Exposure is referred to in section 14.4, and it is,

$$MPE \text{ limit} = 1.0 \text{ mW/cm}^2$$

The resulted power density is below the limit of MPE, and therefore in LTE band 4 is compliant with the FCC rules on RF exposure.

Unless otherwise stated the results shown in this test report refer only to the sample(s) tested and such sample(s) are retained for 90 days only.

除非另有說明，此報告結果僅對測試之樣品負責，同時此樣品僅保留90天。本報告未經本公司書面許可，不可部份複製。

This document is issued by the Company subject to its General Conditions of Service printed overleaf, available on request or accessible at [www.sgs.com/terms\\_and\\_conditions.htm](http://www.sgs.com/terms_and_conditions.htm) and, for electronic format documents, subject to Terms and Conditions for Electronic Documents at [www.sgs.com/terms\\_e-document.htm](http://www.sgs.com/terms_e-document.htm). Attention is drawn to the limitation of liability, indemnification and jurisdiction issues defined therein. Any holder of this document is advised that information contained hereon reflects the Company's findings at the time of its intervention only and within the limits of Client's instructions, if any. The Company's sole responsibility is to its Client and this document does not exonerate parties to a transaction from exercising all their rights and obligations under the transaction documents. This document cannot be reproduced except in full, without prior written approval of the Company. Any unauthorized alteration, forgery or falsification of the content or appearance of this document is unlawful and offenders may be prosecuted to the fullest extent of the law.

Operation in LTE band (782.0 MHz)

The ERP in LTE band 13 5MHz /16QAM/RB 1 offset: 24 is 23.46dBm max at LTE mode. The resulted power density at a distance of 20 cm can be deducted as follows:

BAND 13 / BW: 5M / 16QAM / RB: 1 offset: 24								
EUT			Measurement					
Operation Band	Fundamental Frequency	CH	Antenna Pol.	S.G. Output	Antenna Gain	Cable Loss	ERP	Limit
	MHz		V/H	dBm	dBi	dB	dBm	dBm
LTE Band 13	779.5	23205	V	22.21	3.48	-2.91	22.78	33.00
			H	15.36	3.48	-2.91	15.93	33.00
	782.0	23230	V	20.74	3.49	-2.92	21.31	33.00
			H	15.46	3.49	-2.92	16.03	33.00
	784.5	23255	V	22.88	3.50	-2.92	<b>23.46</b>	33.00
			H	15.98	3.50	-2.92	16.55	33.00

$$ERP = 23.46dBm = 220.820mW$$

$$Power Density = ERP * Duty Cycle / (4 * R^2) \\ = 220.820 * 1 / (4 * 20^2) = 0.04413 mW/cm^2$$

where Duty Cycle is 1 for LTE band 13 5MHz /16QAM/RB 1 offset: 24 operation and R is 20 cm.

The MPE limit for General Population/Uncontrolled Exposure is shown in the FCC OET Bulletin 65 Supplement C and can be calculated as follows:

$$MPE\ limit = 782 / 1500 = 0.521\ mW/cm^2$$

As we can see the resulted power density is below the MPE limit, therefore in LTE band 13 is compliant with the FCC rules on RF exposure.

Unless otherwise stated the results shown in this test report refer only to the sample(s) tested and such sample(s) are retained for 90 days only.

除非另有說明，此報告結果僅對測試之樣品負責，同時此樣品僅保留90天。本報告未經本公司書面許可，不可部份複製。

This document is issued by the Company subject to its General Conditions of Service printed overleaf, available on request or accessible at [www.sgs.com/terms\\_and\\_conditions.htm](http://www.sgs.com/terms_and_conditions.htm) and, for electronic format documents, subject to Terms and Conditions for Electronic Documents at [www.sgs.com/terms\\_e-document.htm](http://www.sgs.com/terms_e-document.htm). Attention is drawn to the limitation of liability, indemnification and jurisdiction issues defined therein. Any holder of this document is advised that information contained hereon reflects the Company's findings at the time of its intervention only and within the limits of Client's instructions, if any. The Company's sole responsibility is to its Client and this document does not exonerate parties to a transaction from exercising all their rights and obligations under the transaction documents. This document cannot be reproduced except in full, without prior written approval of the Company. Any unauthorized alteration, forgery or falsification of the content or appearance of this document is unlawful and offenders may be prosecuted to the fullest extent of the law.



## 15. The Derivation of Maximum Allowable Gain

### 15.1. The Justification How Gain is Derived:

This submittal(s) (test report) is intended to comply with Section Part 27, subpart C & subpart L of the FCC CFR 47 Rules. As per FCC's ruling part, 1.1310, the power density limit for General Population/Uncontrolled Exposure is f/1500 mW/cm<sup>2</sup> through 300MHz to 1500MHz, and 1.0 mW/cm<sup>2</sup> through 1.5 GHz to 100 GHz, respectively. Since this related application is characterized as mobile application as defined by FCC, the MPE is obtained at 20cm in determination for its compliance with the power density limit.

The formula listing as follows is applied in determination of Power Density:

$$S = (P \cdot G) / (4\pi \cdot R^2)$$

Where,

S = Power Density

P = Conducted Output Power Measured at Antenna Port

G = Gain of Maximum Transmitting Antenna (linear gain)

R = Separating Distance from Transmitting Antenna

This related radio application is classified as mobile device in operation of general population / uncontrolled exposure condition.

### Limitation

Frequency Range (MHz)	Electric Field Strength (V/m)	Magnetic Field Strength (A/m)	Power Density (mW/cm <sup>2</sup> )	Averaging Time (minute)
Limits for General Population/Uncontrolled Exposure				
0.3-1.34	614	1.63	*(100)	30
1.34-30	824/f	2.19/f	*(180/f <sup>2</sup> )	30
30-300	27.5	0.073	0.2	30
300-1500	/	/	F/1500	30
1500-15000	/	/	1.0	30

Unless otherwise stated the results shown in this test report refer only to the sample(s) tested and such sample(s) are retained for 90 days only.

除非另有說明，此報告結果僅對測試之樣品負責，同時此樣品僅保留90天。本報告未經本公司書面許可，不可部份複製。

This document is issued by the Company subject to its General Conditions of Service printed overleaf, available on request or accessible at [www.sgs.com/terms\\_and\\_conditions.htm](http://www.sgs.com/terms_and_conditions.htm) and, for electronic format documents, subject to Terms and Conditions for Electronic Documents at [www.sgs.com/terms\\_e-document.htm](http://www.sgs.com/terms_e-document.htm). Attention is drawn to the limitation of liability, indemnification and jurisdiction issues defined therein. Any holder of this document is advised that information contained hereon reflects the Company's findings at the time of its intervention only and within the limits of Client's instructions, if any. The Company's sole responsibility is to its Client and this document does not exonerate parties to a transaction from exercising all their rights and obligations under the transaction documents. This document cannot be reproduced except in full, without prior written approval of the Company. Any unauthorized alteration, forgery or falsification of the content or appearance of this document is unlawful and offenders may be prosecuted to the fullest extent of the law.

## 15.2. Maximum Linear Gain Determination using MPE

Re-arrange the formula of Power Density in terms of maximum gain,

It yields,

$$G = S \cdot (4 \cdot R^2) / P$$

Where,

$S = F/150W/m^2$  (300MHz -1500MHz) or  $10W/m^2$  (1.5GHz-150GHz)

$P =$  Conducted Output Power Measured at Antenna Port with respect to applied band.

$G =$  Maximum Linear Gain

$R = 20cm$

## Maximum Linear Gain Determination using ERP/EIRP

As per 27.50 (d)(2) , 27.50 (c)(9) ERP/EIRP is limited as 1W,30W, Maximum allowable gain that complies with them can be obtained by the following relationship.

**EIRP/ERP = Maximum Allowable Gain + Maximum Burst Power as measured at antenna terminal.**

Re-arrange the above equation in terms of Maximum Allowable Gain, *It yields,*

**Maximum Allowable Gain = EIRP/ERP – Maximum Burst Power as measured at antenna terminal**

Unless otherwise stated the results shown in this test report refer only to the sample(s) tested and such sample(s) are retained for 90 days only.

除非另有說明，此報告結果僅對測試之樣品負責，同時此樣品僅保留90天。本報告未經本公司書面許可，不可部份複製。

This document is issued by the Company subject to its General Conditions of Service printed overleaf, available on request or accessible at [www.sgs.com/terms\\_and\\_conditions.htm](http://www.sgs.com/terms_and_conditions.htm) and, for electronic format documents, subject to Terms and Conditions for Electronic Documents at [www.sgs.com/terms\\_e-document.htm](http://www.sgs.com/terms_e-document.htm). Attention is drawn to the limitation of liability, indemnification and jurisdiction issues defined therein. Any holder of this document is advised that information contained hereon reflects the Company's findings at the time of its intervention only and within the limits of Client's instructions, if any. The Company's sole responsibility is to its Client and this document does not exonerate parties to a transaction from exercising all their rights and obligations under the transaction documents. This document cannot be reproduced except in full, without prior written approval of the Company. Any unauthorized alteration, forgery or falsification of the content or appearance of this document is unlawful and offenders may be prosecuted to the fullest extent of the law.

**Maximum Source-based Time Average power for LTE mode:**

24.58dBm (1720.0MHz) for band 4, 23.43dBm (782.0 MHz) for band 13.

**15.3. The Computation of Maximum Allowable Linear Gain using MPE limit**Operation in LTE band 4

Given the maximum source-based time-averaged power as 24.58dBm, and MPE limit as  $1\text{W}/\text{m}^2$ . Therefore, antenna gain is calculated as 12.43dBi

Operation in LTE band 13

Given the maximum source-based time-averaged power as 23.43dBm, and MPE limit as  $0.52\text{W}/\text{m}^2$ . Therefore, antenna gain is calculated as 10.75dBi

**15.4. The Computation of Maximum Allowable Linear Gain using ERP/EIRP limit**Operation in LTE band 4

Given the maximum source-based time-averaged power as 24.58dBm, and EIRP limit as 1W  
Therefore, antenna gain is calculated as 5.42dBi

Operation in LTE band 13

Given the maximum source-based time-averaged power as 23.43dBm, and ERP limit as 30W  
Therefore, antenna gain is calculated as 21.34dBi

Unless otherwise stated the results shown in this test report refer only to the sample(s) tested and such sample(s) are retained for 90 days only.

除非另有說明，此報告結果僅對測試之樣品負責，同時此樣品僅保留90天。本報告未經本公司書面許可，不可部份複製。

This document is issued by the Company subject to its General Conditions of Service printed overleaf, available on request or accessible at [www.sgs.com/terms\\_and\\_conditions.htm](http://www.sgs.com/terms_and_conditions.htm) and, for electronic format documents, subject to Terms and Conditions for Electronic Documents at [www.sgs.com/terms\\_e-document.htm](http://www.sgs.com/terms_e-document.htm). Attention is drawn to the limitation of liability, indemnification and jurisdiction issues defined therein. Any holder of this document is advised that information contained hereon reflects the Company's findings at the time of its intervention only and within the limits of Client's instructions, if any. The Company's sole responsibility is to its Client and this document does not exonerate parties to a transaction from exercising all their rights and obligations under the transaction documents. This document cannot be reproduced except in full, without prior written approval of the Company. Any unauthorized alteration, forgery or falsification of the content or appearance of this document is unlawful and offenders may be prosecuted to the fullest extent of the law.