

## FCC Test Report (BT-EDR)

**Report No.:** RF200103E02-1

**FCC ID:** TLZ-CU427

**Test Model:** AW-CU427-P, AW-CU427-E

**Received Date:** Jan. 03, 2020

**Test Date:** Apr. 14 to 16, 2020

**Issued Date:** Apr. 22, 2020

**Applicant:** AzureWave Technologies, Inc.

**Address:** 8F., No.94, Baozhong Rd. , Xindian Dist., New Taipei City , Taiwan 231

**Issued By:** Bureau Veritas Consumer Products Services (H.K.) Ltd., Taoyuan Branch  
Hsin Chu Laboratory

**Lab Address:** E-2, No.1, Li Hsin 1st Road, Hsinchu Science Park, Hsinchu City 300,  
Taiwan

**Test Location :** E-2, No.1, Li Hsin 1st Road, Hsinchu Science Park, Hsinchu City 300,  
Taiwan

**FCC Registration /  
Designation Number:** 723255 / TW2022



This report is for your exclusive use. Any copying or replication of this report to or for any other person or entity, or use of our name or trademark, is permitted only with our prior written permission. This report sets forth our findings solely with respect to the test samples identified herein. The results set forth in this report are not indicative or representative of the quality or characteristics of the lot from which a test sample was taken or any similar or identical product unless specifically and expressly noted. Our report includes all of the tests requested by you and the results thereof based upon the information that you provided to us. You have 60 days from date of issuance of this report to notify us of any material error or omission caused by our negligence, provided, however, that such notice shall be in writing and shall specifically address the issue you wish to raise. A failure to raise such issue within the prescribed time shall constitute your unqualified acceptance of the completeness of this report, the tests conducted and the correctness of the report contents. Unless specific mention, the uncertainty of measurement has been explicitly taken into account to declare the compliance or non-compliance to the specification. The report must not be used by the client to claim product certification, approval, or endorsement by TAF or any government agencies.

## Table of Contents

<b>Release Control Record</b> .....	<b>4</b>
<b>1 Certificate of Conformity</b> .....	<b>5</b>
<b>2 Summary of Test Results</b> .....	<b>6</b>
2.1 Measurement Uncertainty .....	6
2.2 Modification Record .....	7
<b>3 General Information</b> .....	<b>8</b>
3.1 General Description of EUT (BT-EDR) .....	8
3.2 Description of Test Modes .....	9
3.2.1 Test Mode Applicability and Tested Channel Detail .....	10
3.3 Duty Cycle of Test Signal .....	12
3.4 Description of Support Units .....	13
3.4.1 Configuration of System under Test .....	13
3.5 General Description of Applied Standards and References .....	14
<b>4 Test Types and Results</b> .....	<b>15</b>
4.1 Radiated Emission and Bandedge Measurement .....	15
4.1.1 Limits of Radiated Emission and Bandedge Measurement .....	15
4.1.2 Test Instruments .....	16
4.1.3 Test Procedures .....	18
4.1.4 Deviation from Test Standard .....	19
4.1.5 Test Setup .....	19
4.1.6 EUT Operating Conditions .....	20
4.1.7 Test Results (Mode 1) .....	21
4.1.8 Test Results (Mode 2) .....	29
4.2 Conducted Emission Measurement .....	37
4.2.1 Limits of Conducted Emission Measurement .....	37
4.2.2 Test Instruments .....	37
4.2.3 Test Procedures .....	38
4.2.4 Deviation From Test Standard .....	38
4.2.5 Test Setup .....	38
4.2.6 EUT Operating Condition .....	38
4.2.7 Test Results .....	39
4.3 Number of Hopping Frequency Used .....	41
4.3.1 Limits of Hopping Frequency Used Measurement .....	41
4.3.2 Test Setup .....	41
4.3.3 Test Instruments .....	41
4.3.4 Test Procedure .....	41
4.3.5 Deviation from Test Standard .....	41
4.3.6 Test Results .....	42
4.4 Dwell Time on Each Channel .....	43
4.4.1 Limits of Dwell Time on Each Channel Measurement .....	43
4.4.2 Test Setup .....	43
4.4.3 Test Instruments .....	43
4.4.4 Test Procedures .....	43
4.4.5 Deviation from Test Standard .....	43
4.4.6 Test Results .....	44
4.5 Channel Bandwidth .....	48
4.5.1 Limits of Channel Bandwidth Measurement .....	48
4.5.2 Test Setup .....	48
4.5.3 Test Instruments .....	48
4.5.4 Test Procedure .....	48
4.5.5 Deviation from Test Standard .....	48
4.5.6 EUT Operating Condition .....	48
4.5.7 Test Results .....	49

4.6 Hopping Channel Separation.....	50
4.6.1 Limits of Hopping Channel Separation Measurement.....	50
4.6.2 Test Setup.....	50
4.6.3 Test Instruments .....	50
4.6.4 Test Procedure .....	50
4.6.5 Deviation from Test Standard .....	50
4.6.6 Test Results .....	51
4.7 Maximum Output Power .....	52
4.7.1 Limits of Maximum Output Power Measurement .....	52
4.7.2 Test Setup.....	52
4.7.3 Test Instruments .....	52
4.7.4 Test Procedure .....	52
4.7.5 Deviation from Test Standard .....	52
4.7.6 EUT Operating Condition .....	52
4.7.7 Test Results .....	53
4.8 Conducted Out of Band Emission Measurement .....	54
4.8.1 Limits of Conducted Out of Band Emission Measurement.....	54
4.8.2 Test Instruments .....	54
4.8.3 Test Procedure .....	54
4.8.4 Deviation from Test Standard .....	54
4.8.5 EUT Operating Condition .....	54
4.8.6 Test Results .....	54
<b>5 Pictures of Test Arrangements.....</b>	<b>57</b>
<b>Annex A- Band-edge measurement .....</b>	<b>58</b>
<b>Annex A.1 - Test Results (Mode 1).....</b>	<b>58</b>
<b>Annex A.2 - Test Results (Mode 2).....</b>	<b>60</b>
<b>Appendix – Information of the Testing Laboratories .....</b>	<b>62</b>

### Release Control Record

Issue No.	Description	Date Issued
RF200103E02-1	Original release.	Apr. 22, 2020

## 1 Certificate of Conformity

**Product:** IEEE 802.11 b/g/n MAC/baseband/radio and Bluetooth 4.2 IoT Module Internal Antenna

**Brand:** AzureWave

**Test Model:** AW-CU427-P, AW-CU427-E

**Sample Status:** ENGINEERING SAMPLE

**Applicant:** AzureWave Technologies, Inc.

**Test Date:** Apr. 14 to 16, 2020

**Standards:** 47 CFR FCC Part 15, Subpart C (Section 15.247)  
ANSI C63.10: 2013

The above equipment has been tested by **Bureau Veritas Consumer Products Services (H.K.) Ltd., Taoyuan Branch**, and found compliance with the requirement of the above standards. The test record, data evaluation & Equipment Under Test (EUT) configurations represented herein are true and accurate accounts of the measurements of the sample's EMC characteristics under the conditions specified in this report.

**Prepared by :** Joyce Kuo , **Date:** Apr. 22, 2020  
Joyce Kuo / Specialist

**Approved by :** Clark Lin , **Date:** Apr. 22, 2020  
Clark Lin / Technical Manager

## 2 Summary of Test Results

47 CFR FCC Part 15, Subpart C (SECTION 15.247)			
FCC Clause	Test Item	Result	Remarks
15.207	AC Power Conducted Emission	PASS	Meet the requirement of limit. Minimum passing margin is -9.20dB at 0.15000MHz.
15.247(a)(1)(iii)	Number of Hopping Frequency Used	PASS	Meet the requirement of limit.
15.247(a)(1)(iii)	Dwell Time on Each Channel	PASS	Meet the requirement of limit.
15.247(a)(1)	1. Hopping Channel Separation 2. Spectrum Bandwidth of a Frequency Hopping Sequence Spread Spectrum System	PASS	Meet the requirement of limit.
15.247(b)	Maximum Peak Output Power	PASS	Meet the requirement of limit.
15.205 & 209 & 15.247(d)	Radiated Emissions & Band Edge Measurement	PASS	Meet the requirement of limit. Minimum passing margin is -3.2dB at 798.28MHz.
15.247(d)	Antenna Port Emission	PASS	Meet the requirement of limit.
15.203	Antenna Requirement	PASS	Antenna connector is i-pex(MHF) not a standard connector.

### NOTE:

1. If The Frequency Hopping System operating in 2400-2483.5MHz band and the output power less than 125mW. The hopping channel carrier frequencies separated by a minimum of 25kHz or two-thirds of the 20dB bandwidth of hopping channel whichever is greater.
2. For 2.4GHz band compliance with rule 15.247(d) of the band-edge items, the test plots were recorded in Annex A. Test Procedures refer to report 4.1.3.
3. Determining compliance based on the results of the compliance measurement, not taking into account measurement instrumentation uncertainty.

### 2.1 Measurement Uncertainty

Where relevant, the following measurement uncertainty levels have been estimated for tests performed on the EUT as specified in CISPR 16-4-2:

Measurement	Frequency	Expanded Uncertainty (k=2) ( $\pm$ )
Conducted Emissions at mains ports	150kHz ~ 30MHz	1.9 dB
Conducted emissions	-	2.5 dB
Radiated Emissions up to 1 GHz	9kHz ~ 30MHz	3.1 dB
	30MHz ~ 1GHz	5.5 dB
Radiated Emissions above 1 GHz	1GHz ~ 18GHz	5.1 dB
	18GHz ~ 40GHz	5.3 dB

## 2.2 Modification Record

There were no modifications required for compliance.

### 3 General Information

#### 3.1 General Description of EUT (BT-EDR)

Product	IEEE 802.11 b/g/n MAC/baseband/radio and Bluetooth 4.2 IoT Module Internal Antenna
Brand	AzureWave
Test Model	AW-CU427-P, AW-CU427-E
Status of EUT	ENGINEERING SAMPLE
Power Supply Rating	DC 3.6V from host equipment
Modulation Type	GFSK, $\pi/4$ -DQPSK, 8DPSK
Modulation Technology	FHSS
Transfer Rate	Up to 3Mbps
Operating Frequency	2402MHz ~ 2480MHz
Number of Channel	79
Output Power	9.772mW
Antenna Type	Refer to Note
Antenna Connector	Refer to Note
Accessory Device	NA
Data Cable Supplied	NA

Note:

1. WLAN & Bluetooth technology cannot transmit at same time.
2. The EUT has below model names which are identical to each other in all aspects except for the followings:

Brand	Model	Difference
AzureWave	AW-CU427-E	External Antenna
	AW-CU427-P	Internal PCB Antenna

3. The antenna provided to the EUT, please refer to the following table:

Antenna NO.	RF Chain NO.	Brand	Model	Antenna Net Gain(dBi)	Frequency range	Antenna Type	Connector Type	Cable Length (mm)
1	0	mag layers	MSA-4008-25GC1-A1	2.98	2.4~2.4835GHz	PIFA	i-pex(MHF)	150
2	0	AzureWave	AW-CU427	3.12	2.4~2.4835GHz	PIFA	None	-

4. The above EUT information is declared by manufacturer and for more detailed features description, please refers to the manufacturer's specifications or user's manual.



### 3.2 Description of Test Modes

79 channels are provided for BT-EDR mode:

Channel	Freq. (MHz)	Channel	Freq. (MHz)	Channel	Freq. (MHz)	Channel	Freq. (MHz)
0	2402	20	2422	40	2442	60	2462
1	2403	21	2423	41	2443	61	2463
2	2404	22	2424	42	2444	62	2464
3	2405	23	2425	43	2445	63	2465
4	2406	24	2426	44	2446	64	2466
5	2407	25	2427	45	2447	65	2467
6	2408	26	2428	46	2448	66	2468
7	2409	27	2429	47	2449	67	2469
8	2410	28	2430	48	2450	68	2470
9	2411	29	2431	49	2451	69	2471
10	2412	30	2432	50	2452	70	2472
11	2413	31	2433	51	2453	71	2473
12	2414	32	2434	52	2454	72	2474
13	2415	33	2435	53	2455	73	2475
14	2416	34	2436	54	2456	74	2476
15	2417	35	2437	55	2457	75	2477
16	2418	36	2438	56	2458	76	2478
17	2419	37	2439	57	2459	77	2479
18	2420	38	2440	58	2460	78	2480
19	2421	39	2441	59	2461		

### 3.2.1 Test Mode Applicability and Tested Channel Detail

EUT CONFIGURE MODE	APPLICABLE TO				DESCRIPTION
	RE $\geq$ 1G	RE $<$ 1G	PLC	APCM	
1	√	√	-	√	Model: AW-CU427-P, Internal Antenna (Ant. 2)
2	√	√	√	-	Model: AW-CU427-E, External Antenna (Ant. 1)

Where **RE $\geq$ 1G**: Radiated Emission above 1GHz & Bandedge Measurement **RE $<$ 1G**: Radiated Emission below 1GHz

**PLC**: Power Line Conducted Emission **APCM**: Antenna Port Conducted Measurement

- Note:
- The EUT's Internal Antenna had been pre-tested on the positioned of each 3 axis. The worst case was found when positioned on **X-plane (Below 1GHz) & Z-plane (Above 1GHz)**.
  - The EUT's External Antenna had been pre-tested on the positioned of each 3 axis. The worst case was found when positioned on **Y-plane (Below 1GHz) & Z-plane (Above 1GHz)**.

#### Radiated Emission Test (Above 1GHz):

- Pre-Scan has been conducted to determine the worst-case mode from all possible combinations between available modulations, data rates and antenna ports (if EUT with antenna diversity architecture).
- Following channel(s) was (were) selected for the final test as listed below.

AVAILABLE CHANNEL	TESTED CHANNEL	MODULATION TECHNOLOGY	MODULATION TYPE	PACKET TYPE
0 to 78	0, 39, 78	FHSS	GFSK	DH5
0 to 78	0, 39, 78	FHSS	8DPSK	3DH5

#### Radiated Emission Test (Below 1GHz):

- Pre-Scan has been conducted to determine the worst-case mode from all possible combinations between available modulations, data rates and antenna ports (if EUT with antenna diversity architecture).
- Following channel(s) was (were) selected for the final test as listed below.

AVAILABLE CHANNEL	TESTED CHANNEL	MODULATION TECHNOLOGY	MODULATION TYPE	PACKET TYPE
0 to 78	39	FHSS	GFSK	DH5

#### Power Line Conducted Emission Test:

- Pre-Scan has been conducted to determine the worst-case mode from all possible combinations between available modulations, data rates and antenna ports (if EUT with antenna diversity architecture).
- Following channel(s) was (were) selected for the final test as listed below.

AVAILABLE CHANNEL	TESTED CHANNEL	MODULATION TECHNOLOGY	MODULATION TYPE	PACKET TYPE
0 to 78	39	FHSS	GFSK	DH5

**Antenna Port Conducted Measurement:**

- Pre-Scan has been conducted to determine the worst-case mode from all possible combinations between available modulations, data rates and antenna ports (if EUT with antenna diversity architecture).
- Following channel(s) was (were) selected for the final test as listed below.

AVAILABLE CHANNEL	TESTED CHANNEL	MODULATION TECHNOLOGY	MODULATION TYPE	PACKET TYPE
0 to 78	0, 39, 78	FHSS	GFSK	DH5
0 to 78	0, 39, 78	FHSS	8DPSK	3DH5

**Test Condition:**

APPLICABLE TO	ENVIRONMENTAL CONDITIONS	Input Power (System)	TESTED BY
RE $\geq$ 1G	23deg. C, 67%RH	120Vac, 60Hz	Gary Cheng
RE $<$ 1G	23deg. C, 67%RH	120Vac, 60Hz	Ryan Du
PLC	25deg. C, 75%RH	120Vac, 60Hz	Ryan Du
APCM	25deg. C, 60%RH	120Vac, 60Hz	Anderson Chen

### 3.3 Duty Cycle of Test Signal

If duty cycle of test signal is < 98%, duty factor shall be considered.

**GFSK** : Duty cycle = 2.885 ms/3.752 ms = 0.769 , Duty factor =  $10 * \log( 1/\text{Duty cycle}) = 2.885$

**8DPSK** : Duty cycle = 2.872 ms/3.772 ms = 0.765 , Duty factor =  $10 * \log( 1/\text{Duty cycle}) = 1.16$

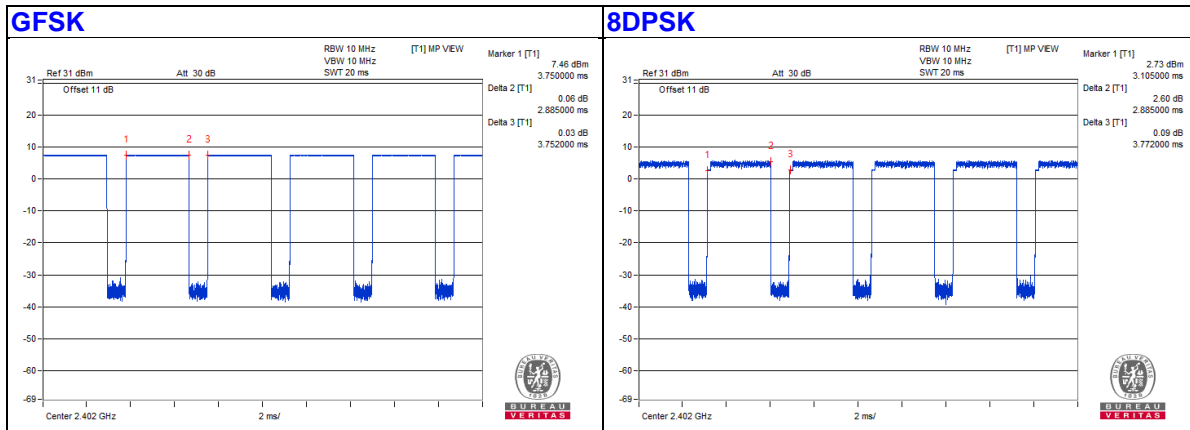

### 3.4 Description of Support Units

The EUT has been tested as an independent unit together with other necessary accessories or support units. The following support units or accessories were used to form a representative test configuration during the tests.

ID	Product	Brand	Model No.	Serial No.	FCC ID	Remarks
A.	Laptop	DELL	E5430	HYV4VY1	FCC DoC	Provided by Lab
B.	Test Tool	AzureWave	NA	NA	NA	Supplied by client
C.	Adapter	DELL	LA90PM111	NA	NA	Provided by Lab

ID	Descriptions	Qty.	Length (m)	Shielding (Yes/No)	Cores (Qty.)	Remarks
1.	USB Cable	1	1.8	No	0	Provided by Lab
2.	DC Cable	1	1.7	No	1	Provided by Lab
3.	AC Cable	1	0.8	No	0	Provided by Lab

Note: The core is originally attached to the cable.

#### 3.4.1 Configuration of System under Test

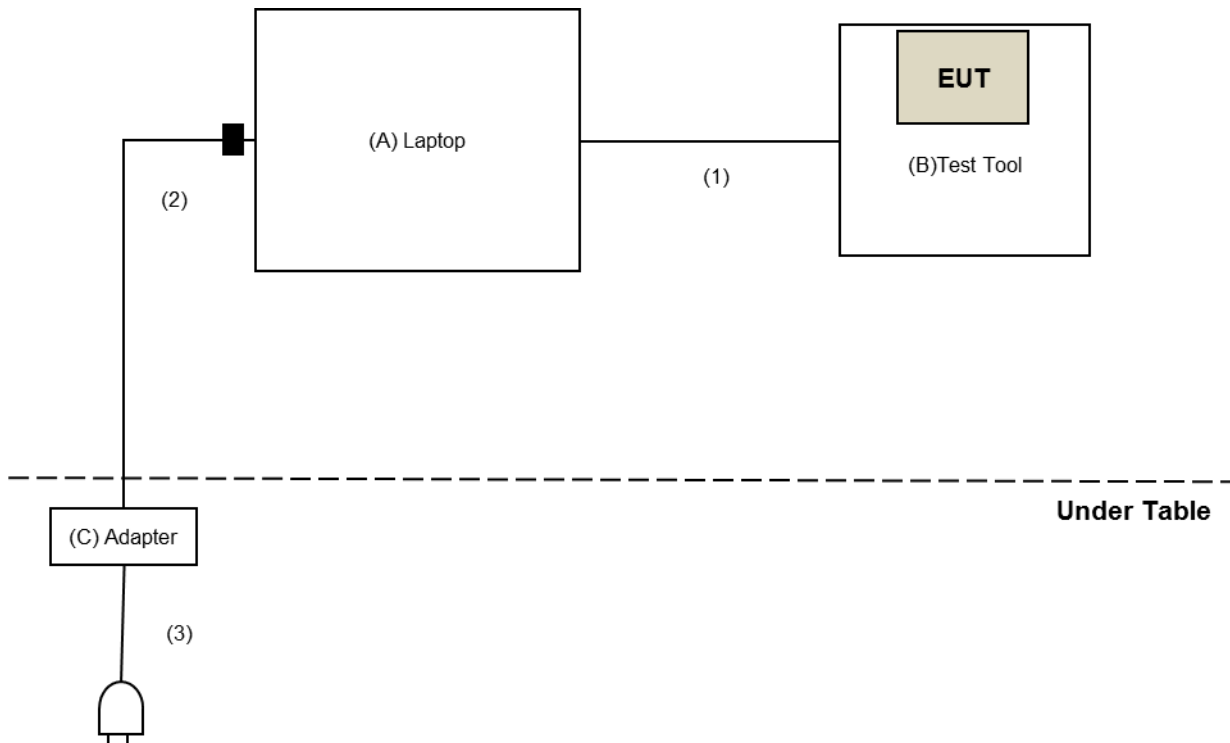

### 3.5 General Description of Applied Standards and References

The EUT is a RF Product. According to the specifications of the manufacturer, it must comply with the requirements of the following standards and references:

**FCC Part 15, Subpart C (15.247)**  
**KDB 558074 D01 15.247 Meas Guidance v05r02**  
ANSI C63.10-2013

All test items have been performed and recorded as per the above standards.

## 4 Test Types and Results

### 4.1 Radiated Emission and Bandedge Measurement

#### 4.1.1 Limits of Radiated Emission and Bandedge Measurement

Radiated emissions which fall in the restricted bands must comply with the radiated emission limits specified as below table. Other emissions shall be at least 20dB below the highest level of the desired power:

Frequencies (MHz)	Field Strength (microvolts/meter)	Measurement Distance (meters)
0.009 ~ 0.490	2400/F(kHz)	300
0.490 ~ 1.705	24000/F(kHz)	30
1.705 ~ 30.0	30	30
30 ~ 88	100	3
88 ~ 216	150	3
216 ~ 960	200	3
Above 960	500	3

**NOTE:**

1. The lower limit shall apply at the transition frequencies.
2. Emission level (dBuV/m) = 20 log Emission level (uV/m).
3. For frequencies above 1000MHz, the field strength limits are based on average detector, however, the peak field strength of any emission shall not exceed the maximum permitted average limits, specified above by more than 20dB under any condition of modulation.

#### 4.1.2 Test Instruments

##### For Radiated Emission

DESCRIPTION & MANUFACTURER	MODEL NO.	SERIAL NO.	CALIBRATED DATE	CALIBRATED UNTIL
Test Receiver Agilent	N9038A	MY51210202	Dec. 13, 2019	Dec. 12, 2020
Pre-Amplifier EMCI	EMC001340	980142	May 30, 2019	May 29, 2020
Loop Antenna Electro-Metrics	EM-6879	264	Feb. 18, 2020	Feb. 17, 2021
RF Cable	NA	LOOPCAB-001	Jan. 08, 2020	Jan. 07, 2021
RF Cable	NA	LOOPCAB-002	Jan. 08, 2020	Jan. 07, 2021
Pre-Amplifier Mini-Circuits	ZFL-1000VH2B	AMP-ZFL-01	Oct. 23, 2019	Oct. 22, 2020
Trilog Broadband Antenna SCHWARZBECK	VULB 9168	9168-406	Nov. 11, 2019	Nov. 10, 2020
RF Cable	8D	966-4-1	Mar. 18, 2020	Mar. 17, 2021
RF Cable	8D	966-4-2	Mar. 18, 2020	Mar. 17, 2021
RF Cable	8D	966-4-3	Mar. 18, 2020	Mar. 17, 2021
Fixed attenuator Mini-Circuits	UNAT-5+	PAD-3m-4-01	Sep. 26, 2019	Sep. 25, 2020
Horn_Antenna SCHWARZBECK	BBHA 9120D	9120D-783	Nov. 24, 2019	Nov. 23, 2020
Pre-Amplifier EMCI	EMC12630SE	980385	Aug. 15, 2019	Aug. 14, 2020
RF Cable	EMC104-SM-SM-1200	160923	Jan. 15, 2020	Jan. 14, 2021
RF Cable	EMC104-SM-SM-2000	180502	May 03, 2019	May 02, 2020
RF Cable	EMC104-SM-SM-6000	180418	May 03, 2019	May 02, 2020
Pre-Amplifier EMCI	EMC184045SE	980387	Jan. 15, 2020	Jan. 14, 2021
Horn_Antenna SCHWARZBECK	BBHA 9170	BBHA9170519	Nov. 24, 2019	Nov. 23, 2020
RF Cable	EMC102-KM-KM-1200	160924	Jan. 15, 2020	Jan. 14, 2021
RF Cable	EMC-KM-KM-4000	200214	Mar. 11, 2020	Mar. 10, 2021
Software	ADT_Radiated_V8.7.08	NA	NA	NA
Boresight Antenna Tower & Turn Table Max-Full	MF-7802BS	MF780208530	NA	NA

**Note:**

1. The calibration interval of the above test instruments is 12 months and the calibrations are traceable to NML/ROC and NIST/USA.
2. The test was performed in 966 Chamber No. 4.
3. Loop antenna was used for all emissions below 30 MHz.
4. Tested Date: Apr. 14 to 16, 2020



**For other test:**

DESCRIPTION & MANUFACTURER	MODEL NO.	SERIAL NO.	CALIBRATED DATE	CALIBRATED UNTIL
Spectrum Analyzer R&S	FSV40	100964	June 04, 2019	June 03, 2020
Power meter Anritsu	ML2495A	1014008	May 13, 2019	May 12, 2020
Power sensor Anritsu	MA2411B	0917122	May 13, 2019	May 12, 2020
Fixed Attenuator Mini-Circuits	MDCS18N-10	MDCS18N-10-01	Apr. 14, 2020	Apr. 13, 2021
Software	ADT_RF Test Software V6.6.5.4	NA	NA	NA

- NOTE:**
1. The test was performed in Oven room 2.
  2. The calibration interval of the above test instruments is 12 months and the calibrations are traceable to NML/ROC and NIST/USA.
  3. Tested Date: Apr. 15, 2020

#### 4.1.3 Test Procedures

##### **For Radiated emission below 30MHz**

- a. The EUT was placed on the top of a rotating table 0.8 meters above the ground at a 3 meter chamber room. The table was rotated 360 degrees to determine the position of the highest radiation.
- b. The EUT was set 3 meters away from the interference-receiving antenna, which was mounted on the top of a variable-height antenna tower.
- c. Parallel, perpendicular, and ground-parallel orientations of the antenna are set to make the measurement.
- d. For each suspected emission, the EUT was arranged to its worst case and the rotatable table was turned from 0 degrees to 360 degrees to find the maximum reading.
- e. The test-receiver system was set to Quasi-Peak Detect Function and Specified Bandwidth with Maximum Hold Mode.

##### **NOTE:**

1. The resolution bandwidth and video bandwidth of test receiver/spectrum analyzer is 9kHz at frequency below 30MHz.

##### **For Radiated emission above 30MHz**

- a. The EUT was placed on the top of a rotating table 0.8 meters (for 30MHz ~ 1GHz) / 1.5 meters (for above 1GHz) above the ground at 3 meter chamber room for test. The table was rotated 360 degrees to determine the position of the highest radiation.
- b. The EUT was set 3 meters away from the interference-receiving antenna, which was mounted on the top of a variable-height antenna tower.
- c. The height of antenna is varied from one meter to four meters above the ground to determine the maximum value of the field strength. Both horizontal and vertical polarizations of the antenna are set to make the measurement.
- d. For each suspected emission, the EUT was arranged to its worst case and then the antenna was tuned to heights from 1 meter to 4 meters and the rotatable table was turned from 0 degrees to 360 degrees to find the maximum reading.
- e. The test-receiver system was set to quasi-peak detect function and specified bandwidth with maximum hold mode when the test frequency is below 1 GHz.
- f. The test-receiver system was set to peak and average detect function and specified bandwidth with maximum hold mode when the test frequency is above 1 GHz. If the peak reading value also meets average limit, measurement with the average detector is unnecessary.

##### **Note:**

1. The resolution bandwidth and video bandwidth of test receiver/spectrum analyzer is 120kHz for Quasi-peak detection (QP) at frequency below 1GHz.
2. The resolution bandwidth of test receiver/spectrum analyzer is 1 MHz and the video bandwidth is 3 MHz for Peak detection (PK) at frequency above 1GHz.
3. The resolution bandwidth of test receiver/spectrum analyzer is 1MHz and the video bandwidth is  $\geq 1/T$  (Duty cycle < 98%) or 10Hz (Duty cycle  $\geq 98\%$ ) for Average detection (AV) at frequency above 1GHz.
4. All modes of operation were investigated and the worst-case emissions are reported.

4.1.4 Deviation from Test Standard

No deviation.

4.1.5 Test Setup

**For Radiated emission below 30MHz**

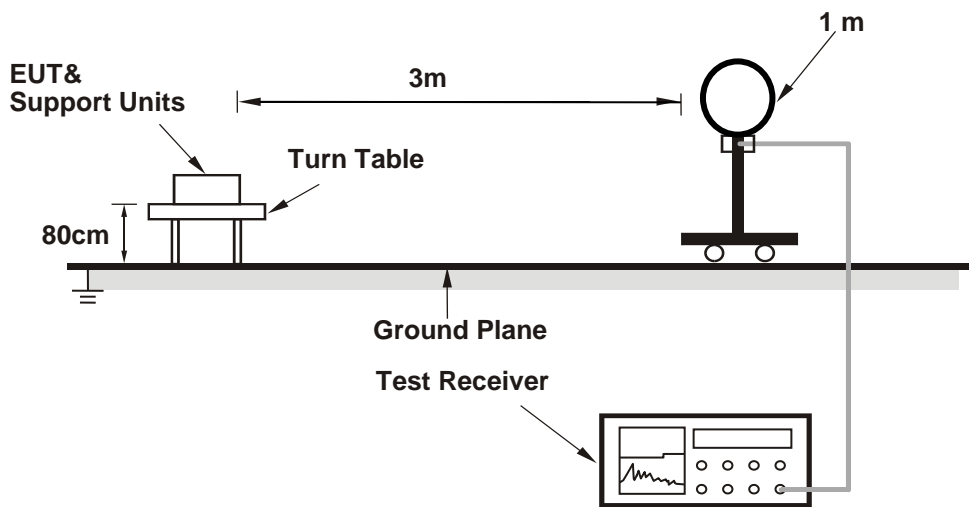

**For Radiated emission 30MHz to 1GHz**

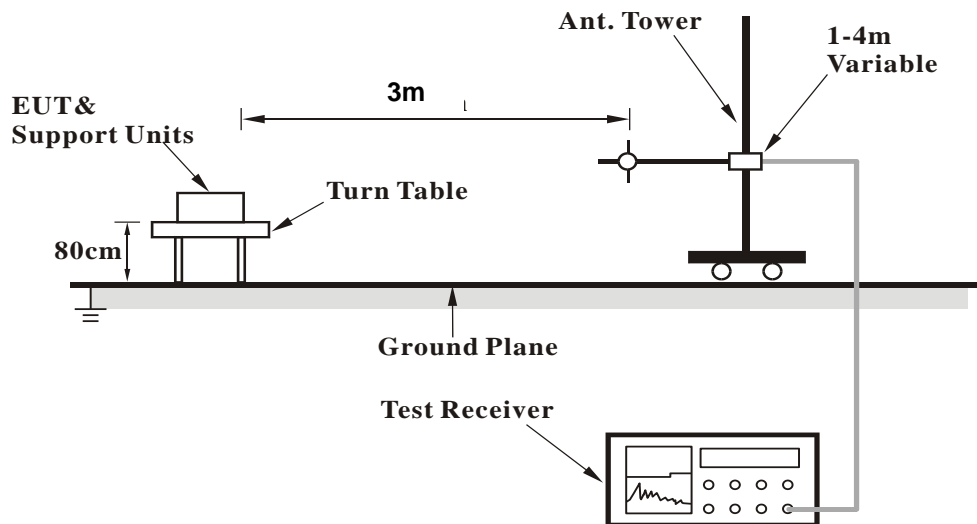

**For Radiated emission above 1GHz**

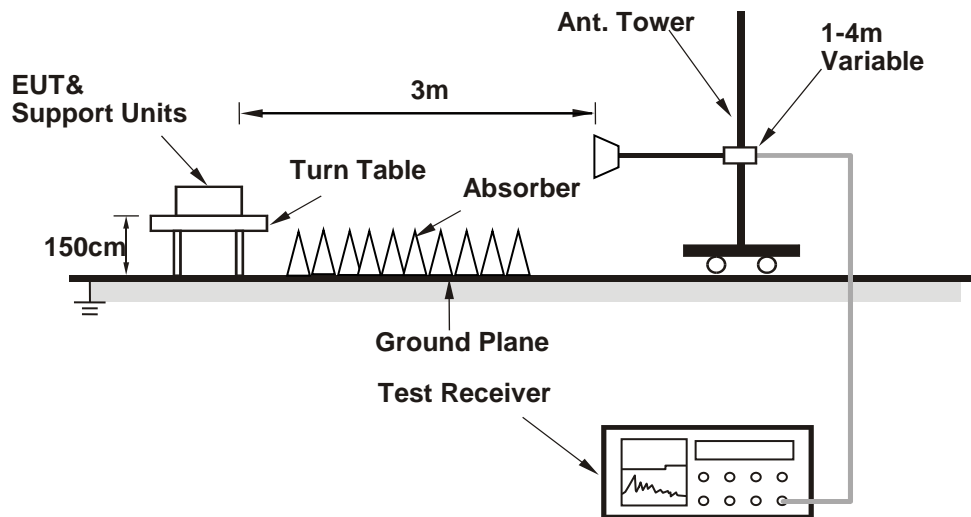

For the actual test configuration, please refer to the attached file (Test Setup Photo).

**4.1.6 EUT Operating Conditions**

- a. Connected the EUT with the Laptop Computer which is placed on testing table.
- b. Controlling software (wl.exe use Test scripts.bat) has been activated to set the EUT under transmission condition continuously at specific channel frequency.

4.1.7 Test Results (Mode 1)

Above 1GHz Data:

BT\_GFSK

<b>CHANNEL</b>	TX Channel 0	<b>DETECTOR FUNCTION</b>	Peak (PK)
<b>FREQUENCY RANGE</b>	1GHz ~ 25GHz		Average (AV)

**ANTENNA POLARITY & TEST DISTANCE: HORIZONTAL AT 3 M**

NO.	FREQ. (MHz)	EMISSION LEVEL (dBuV/m)	LIMIT (dBuV/m)	MARGIN (dB)	ANTENNA HEIGHT (m)	TABLE ANGLE (Degree)	RAW VALUE (dBuV)	CORRECTION FACTOR (dB/m)
1	2390.00	54.2 PK	74.0	-19.8	1.00 H	139	55.7	-1.5
2	2390.00	42.5 AV	54.0	-11.5	1.00 H	139	44.0	-1.5
3	*2402.00	108.0 PK			1.00 H	139	109.5	-1.5
4	*2402.00	107.5 AV			1.00 H	139	109.0	-1.5
5	4804.00	40.7 PK	74.0	-33.3	2.13 H	101	38.0	2.7
6	4804.00	31.9 AV	54.0	-22.1	2.13 H	101	29.2	2.7

**ANTENNA POLARITY & TEST DISTANCE: VERTICAL AT 3 M**

NO.	FREQ. (MHz)	EMISSION LEVEL (dBuV/m)	LIMIT (dBuV/m)	MARGIN (dB)	ANTENNA HEIGHT (m)	TABLE ANGLE (Degree)	RAW VALUE (dBuV)	CORRECTION FACTOR (dB/m)
1	2390.00	54.4 PK	74.0	-19.6	1.04 V	85	55.9	-1.5
2	2390.00	42.4 AV	54.0	-11.6	1.04 V	85	43.9	-1.5
3	*2402.00	103.8 PK			1.04 V	85	105.3	-1.5
4	*2402.00	103.3 AV			1.04 V	85	104.8	-1.5
5	4804.00	44.1 PK	74.0	-29.9	1.76 V	214	41.4	2.7
6	4804.00	38.3 AV	54.0	-15.7	1.76 V	214	35.6	2.7

**REMARKS:**

1. Emission Level(dBuV/m) = Raw Value(dBuV) + Correction Factor(dB/m)
2. Correction Factor(dB/m) = Antenna Factor(dB/m) + Cable Factor(dB) – Pre-Amplifier Factor(dB)
3. Margin value = Emission Level – Limit value
4. The other emission levels were very low against the limit.
5. " \* ": Fundamental frequency.

<b>CHANNEL</b>	TX Channel 39	<b>DETECTOR FUNCTION</b>	Peak (PK)
<b>FREQUENCY RANGE</b>	1GHz ~ 25GHz		Average (AV)

**ANTENNA POLARITY & TEST DISTANCE: HORIZONTAL AT 3 M**

NO.	FREQ. (MHz)	EMISSION LEVEL (dBuV/m)	LIMIT (dBuV/m)	MARGIN (dB)	ANTENNA HEIGHT (m)	TABLE ANGLE (Degree)	RAW VALUE (dBuV)	CORRECTION FACTOR (dB/m)
1	*2441.00	107.7 PK			1.07 H	151	109.1	-1.4
2	*2441.00	107.1 AV			1.07 H	151	108.5	-1.4
3	4882.00	41.0 PK	74.0	-33.0	2.17 H	112	38.5	2.5
4	4882.00	32.0 AV	54.0	-22.0	2.17 H	112	29.5	2.5
5	7323.00	43.4 PK	74.0	-30.6	1.90 H	233	33.9	9.5
6	7323.00	33.4 AV	54.0	-20.6	1.90 H	233	23.9	9.5

**ANTENNA POLARITY & TEST DISTANCE: VERTICAL AT 3 M**

NO.	FREQ. (MHz)	EMISSION LEVEL (dBuV/m)	LIMIT (dBuV/m)	MARGIN (dB)	ANTENNA HEIGHT (m)	TABLE ANGLE (Degree)	RAW VALUE (dBuV)	CORRECTION FACTOR (dB/m)
1	*2441.00	104.3 PK			1.03 V	74	105.7	-1.4
2	*2441.00	103.8 AV			1.03 V	74	105.2	-1.4
3	4882.00	44.5 PK	74.0	-29.5	1.77 V	200	42.0	2.5
4	4882.00	38.6 AV	54.0	-15.4	1.77 V	200	36.1	2.5
5	7323.00	43.7 PK	74.0	-30.3	2.49 V	128	34.2	9.5
6	7323.00	34.8 AV	54.0	-19.2	2.49 V	128	25.3	9.5

**REMARKS:**

1. Emission Level(dBuV/m) = Raw Value(dBuV) + Correction Factor(dB/m)
2. Correction Factor(dB/m) = Antenna Factor(dB/m) + Cable Factor(dB) – Pre-Amplifier Factor(dB)
3. Margin value = Emission Level – Limit value
4. The other emission levels were very low against the limit.
5. " \* ": Fundamental frequency.

<b>CHANNEL</b>	TX Channel 78	<b>DETECTOR FUNCTION</b>	Peak (PK)
<b>FREQUENCY RANGE</b>	1GHz ~ 25GHz		Average (AV)

**ANTENNA POLARITY & TEST DISTANCE: HORIZONTAL AT 3 M**

NO.	FREQ. (MHz)	EMISSION LEVEL (dBuV/m)	LIMIT (dBuV/m)	MARGIN (dB)	ANTENNA HEIGHT (m)	TABLE ANGLE (Degree)	RAW VALUE (dBuV)	CORRECTION FACTOR (dB/m)
1	*2480.00	106.9 PK			1.02 H	137	108.4	-1.5
2	*2480.00	106.4 AV			1.02 H	137	107.9	-1.5
3	2483.50	54.6 PK	74.0	-19.4	1.02 H	137	56.1	-1.5
4	2483.50	43.7 AV	54.0	-10.3	1.02 H	137	45.2	-1.5
5	4960.00	40.8 PK	74.0	-33.2	2.14 H	94	37.9	2.9
6	4960.00	31.8 AV	54.0	-22.2	2.14 H	94	28.9	2.9
7	7440.00	44.2 PK	74.0	-29.8	1.93 H	245	34.3	9.9
8	7440.00	34.1 AV	54.0	-19.9	1.93 H	245	24.2	9.9

**ANTENNA POLARITY & TEST DISTANCE: VERTICAL AT 3 M**

NO.	FREQ. (MHz)	EMISSION LEVEL (dBuV/m)	LIMIT (dBuV/m)	MARGIN (dB)	ANTENNA HEIGHT (m)	TABLE ANGLE (Degree)	RAW VALUE (dBuV)	CORRECTION FACTOR (dB/m)
1	*2480.00	103.0 PK			1.00 V	86	104.5	-1.5
2	*2480.00	102.4 AV			1.00 V	86	103.9	-1.5
3	2483.50	55.0 PK	74.0	-19.0	1.00 V	86	56.5	-1.5
4	2483.50	43.2 AV	54.0	-10.8	1.00 V	86	44.7	-1.5
5	4960.00	44.1 PK	74.0	-29.9	1.79 V	213	41.2	2.9
6	4960.00	38.0 AV	54.0	-16.0	1.79 V	213	35.1	2.9
7	7440.00	44.2 PK	74.0	-29.8	2.57 V	127	34.3	9.9
8	7440.00	35.4 AV	54.0	-18.6	2.57 V	127	25.5	9.9

**REMARKS:**

1. Emission Level(dBuV/m) = Raw Value(dBuV) + Correction Factor(dB/m)
2. Correction Factor(dB/m) = Antenna Factor(dB/m) + Cable Factor(dB) – Pre-Amplifier Factor(dB)
3. Margin value = Emission Level – Limit value
4. The other emission levels were very low against the limit.
5. " \* ": Fundamental frequency.

**BT\_8DPSK**

<b>CHANNEL</b>	TX Channel 0	<b>DETECTOR FUNCTION</b>	Peak (PK)
<b>FREQUENCY RANGE</b>	1GHz ~ 25GHz		Average (AV)

**ANTENNA POLARITY & TEST DISTANCE: HORIZONTAL AT 3 M**

NO.	FREQ. (MHz)	EMISSION LEVEL (dBuV/m)	LIMIT (dBuV/m)	MARGIN (dB)	ANTENNA HEIGHT (m)	TABLE ANGLE (Degree)	RAW VALUE (dBuV)	CORRECTION FACTOR (dB/m)
1	2390.00	54.2 PK	74.0	-19.8	1.03 H	136	55.7	-1.5
2	2390.00	42.5 AV	54.0	-11.5	1.03 H	136	44.0	-1.5
3	*2402.00	104.3 PK			1.03 H	136	105.8	-1.5
4	*2402.00	100.3 AV			1.03 H	136	101.8	-1.5
5	4804.00	40.4 PK	74.0	-33.6	2.11 H	85	37.7	2.7
6	4804.00	31.5 AV	54.0	-22.5	2.11 H	85	28.8	2.7

**ANTENNA POLARITY & TEST DISTANCE: VERTICAL AT 3 M**

NO.	FREQ. (MHz)	EMISSION LEVEL (dBuV/m)	LIMIT (dBuV/m)	MARGIN (dB)	ANTENNA HEIGHT (m)	TABLE ANGLE (Degree)	RAW VALUE (dBuV)	CORRECTION FACTOR (dB/m)
1	2390.00	54.6 PK	74.0	-19.4	1.02 V	86	56.1	-1.5
2	2390.00	42.7 AV	54.0	-11.3	1.02 V	86	44.2	-1.5
3	*2402.00	99.9 PK			1.02 V	86	101.4	-1.5
4	*2402.00	95.9 AV			1.02 V	86	97.4	-1.5
5	4804.00	45.0 PK	74.0	-29.0	1.72 V	215	42.3	2.7
6	4804.00	38.8 AV	54.0	-15.2	1.72 V	215	36.1	2.7

**REMARKS:**

1. Emission Level(dBuV/m) = Raw Value(dBuV) + Correction Factor(dB/m)
2. Correction Factor(dB/m) = Antenna Factor(dB/m) + Cable Factor(dB) – Pre-Amplifier Factor(dB)
3. Margin value = Emission Level – Limit value
4. The other emission levels were very low against the limit.
5. " \* ": Fundamental frequency.



<b>CHANNEL</b>	TX Channel 39	<b>DETECTOR FUNCTION</b>	Peak (PK)
<b>FREQUENCY RANGE</b>	1GHz ~ 25GHz		Average (AV)

**ANTENNA POLARITY & TEST DISTANCE: HORIZONTAL AT 3 M**

NO.	FREQ. (MHz)	EMISSION LEVEL (dBuV/m)	LIMIT (dBuV/m)	MARGIN (dB)	ANTENNA HEIGHT (m)	TABLE ANGLE (Degree)	RAW VALUE (dBuV)	CORRECTION FACTOR (dB/m)
1	*2441.00	104.5 PK			1.01 H	132	105.9	-1.4
2	*2441.00	100.5 AV			1.01 H	132	101.9	-1.4
3	4882.00	40.6 PK	74.0	-33.4	2.12 H	106	38.1	2.5
4	4882.00	31.8 AV	54.0	-22.2	2.12 H	106	29.3	2.5
5	7323.00	43.4 PK	74.0	-30.6	1.96 H	239	33.9	9.5
6	7323.00	33.4 AV	54.0	-20.6	1.96 H	239	23.9	9.5

**ANTENNA POLARITY & TEST DISTANCE: VERTICAL AT 3 M**

NO.	FREQ. (MHz)	EMISSION LEVEL (dBuV/m)	LIMIT (dBuV/m)	MARGIN (dB)	ANTENNA HEIGHT (m)	TABLE ANGLE (Degree)	RAW VALUE (dBuV)	CORRECTION FACTOR (dB/m)
1	*2441.00	99.7 PK			1.05 V	76	101.1	-1.4
2	*2441.00	95.5 AV			1.05 V	76	96.9	-1.4
3	4882.00	44.2 PK	74.0	-29.8	1.80 V	212	41.7	2.5
4	4882.00	38.4 AV	54.0	-15.6	1.80 V	212	35.9	2.5
5	7323.00	43.4 PK	74.0	-30.6	2.49 V	120	33.9	9.5
6	7323.00	34.7 AV	54.0	-19.3	2.49 V	120	25.2	9.5

**REMARKS:**

1. Emission Level(dBuV/m) = Raw Value(dBuV) + Correction Factor(dB/m)
2. Correction Factor(dB/m) = Antenna Factor(dB/m) + Cable Factor(dB) – Pre-Amplifier Factor(dB)
3. Margin value = Emission Level – Limit value
4. The other emission levels were very low against the limit.
5. " \* ": Fundamental frequency.

<b>CHANNEL</b>	TX Channel 78	<b>DETECTOR FUNCTION</b>	Peak (PK)
<b>FREQUENCY RANGE</b>	1GHz ~ 25GHz		Average (AV)

**ANTENNA POLARITY & TEST DISTANCE: HORIZONTAL AT 3 M**

NO.	FREQ. (MHz)	EMISSION LEVEL (dBuV/m)	LIMIT (dBuV/m)	MARGIN (dB)	ANTENNA HEIGHT (m)	TABLE ANGLE (Degree)	RAW VALUE (dBuV)	CORRECTION FACTOR (dB/m)
1	*2480.00	104.6 PK			1.06 H	143	106.1	-1.5
2	*2480.00	100.6 AV			1.06 H	143	102.1	-1.5
3	2483.50	54.7 PK	74.0	-19.3	1.06 H	143	56.2	-1.5
4	2483.50	42.9 AV	54.0	-11.1	1.06 H	143	44.4	-1.5
5	4960.00	40.2 PK	74.0	-33.8	2.12 H	116	37.3	2.9
6	4960.00	31.6 AV	54.0	-22.4	2.12 H	116	28.7	2.9
7	7440.00	43.7 PK	74.0	-30.3	1.98 H	250	33.8	9.9
8	7440.00	33.8 AV	54.0	-20.2	1.98 H	250	23.9	9.9

**ANTENNA POLARITY & TEST DISTANCE: VERTICAL AT 3 M**

NO.	FREQ. (MHz)	EMISSION LEVEL (dBuV/m)	LIMIT (dBuV/m)	MARGIN (dB)	ANTENNA HEIGHT (m)	TABLE ANGLE (Degree)	RAW VALUE (dBuV)	CORRECTION FACTOR (dB/m)
1	*2480.00	99.8 PK			1.06 V	82	101.3	-1.5
2	*2480.00	95.7 AV			1.06 V	82	97.2	-1.5
3	2483.50	54.7 PK	74.0	-19.3	1.06 V	82	56.2	-1.5
4	2483.50	42.4 AV	54.0	-11.6	1.06 V	82	43.9	-1.5
5	4960.00	44.8 PK	74.0	-29.2	1.71 V	202	41.9	2.9
6	4960.00	39.1 AV	54.0	-14.9	1.71 V	202	36.2	2.9
7	7440.00	43.9 PK	74.0	-30.1	2.45 V	117	34.0	9.9
8	7440.00	34.9 AV	54.0	-19.1	2.45 V	117	25.0	9.9

**REMARKS:**

1. Emission Level(dBuV/m) = Raw Value(dBuV) + Correction Factor(dB/m)
2. Correction Factor(dB/m) = Antenna Factor(dB/m) + Cable Factor(dB) – Pre-Amplifier Factor(dB)
3. Margin value = Emission Level – Limit value
4. The other emission levels were very low against the limit.
5. " \* ": Fundamental frequency.

**Below 1GHz Data:**

**BT\_GFSK**

<b>CHANNEL</b>	TX Channel 39	<b>DETECTOR FUNCTION</b>	Quasi-Peak (QP)
<b>FREQUENCY RANGE</b>	9kHz ~ 1GHz		

ANTENNA POLARITY & TEST DISTANCE: HORIZONTAL AT 3 M								
NO.	FREQ. (MHz)	EMISSION LEVEL (dBuV/m)	LIMIT (dBuV/m)	MARGIN (dB)	ANTENNA HEIGHT (m)	TABLE ANGLE (Degree)	RAW VALUE (dBuV)	CORRECTION FACTOR (dB/m)
1	32.09	33.1 QP	40.0	-6.9	1.00 H	276	42.6	-9.5
2	100.32	30.1 QP	43.5	-13.4	2.00 H	249	42.1	-12.0
3	165.73	37.3 QP	43.5	-6.2	1.79 H	196	45.2	-7.9
4	231.95	35.0 QP	46.0	-11.0	1.50 H	72	44.9	-9.9
5	335.98	34.1 QP	46.0	-11.9	1.00 H	167	40.0	-5.9
6	797.95	42.3 QP	46.0	-3.7	1.50 H	299	37.7	4.6

**REMARKS:**

1. Emission Level(dBuV/m) = Raw Value(dBuV) + Correction Factor(dB/m)
2. Correction Factor(dB/m) = Antenna Factor(dB/m) + Cable Factor(dB) – Pre-Amplifier Factor(dB)
3. Margin value = Emission Level – Limit value
4. The other emission levels were very low against the limit of frequency range 30MHz~1000MHz.
5. The emission levels were very low against the limit of frequency range 9kHz~30MHz: the amplitude of spurious emissions attenuated more than 20 dB below the permissible value to be report.

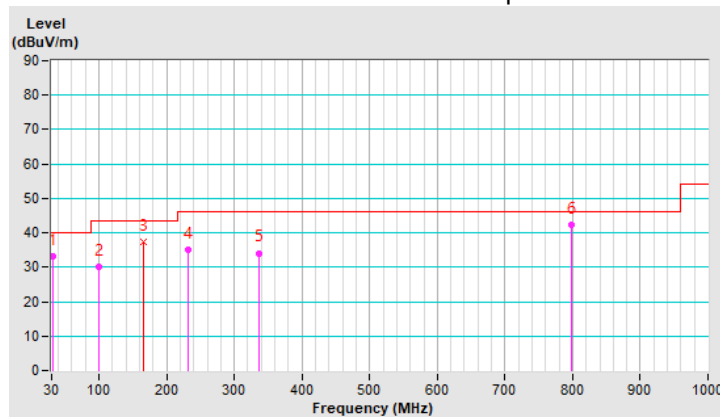

<b>CHANNEL</b>	TX Channel 39	<b>DETECTOR FUNCTION</b>	Quasi-Peak (QP)
<b>FREQUENCY RANGE</b>	9kHz ~ 1GHz		

ANTENNA POLARITY & TEST DISTANCE: VERTICAL AT 3 M								
NO.	FREQ. (MHz)	EMISSION LEVEL (dBuV/m)	LIMIT (dBuV/m)	MARGIN (dB)	ANTENNA HEIGHT (m)	TABLE ANGLE (Degree)	RAW VALUE (dBuV)	CORRECTION FACTOR (dB/m)
1	31.52	35.6 QP	40.0	-4.4	1.00 V	235	45.0	-9.4
2	49.41	32.2 QP	40.0	-7.8	2.00 V	81	40.0	-7.8
3	100.03	34.2 QP	43.5	-9.3	1.50 V	154	46.3	-12.1
4	165.96	37.1 QP	43.5	-6.4	1.05 V	253	45.0	-7.9
5	232.12	32.3 QP	46.0	-13.7	1.00 V	303	42.2	-9.9
6	797.94	39.6 QP	46.0	-6.4	1.00 V	291	35.0	4.6

**REMARKS:**

1. Emission Level(dBuV/m) = Raw Value(dBuV) + Correction Factor(dB/m)
2. Correction Factor(dB/m) = Antenna Factor(dB/m) + Cable Factor(dB) – Pre-Amplifier Factor(dB)
3. Margin value = Emission Level – Limit value
4. The other emission levels were very low against the limit of frequency range 30MHz~1000MHz.
5. The emission levels were very low against the limit of frequency range 9kHz~30MHz: the amplitude of spurious emissions attenuated more than 20 dB below the permissible value to be report.

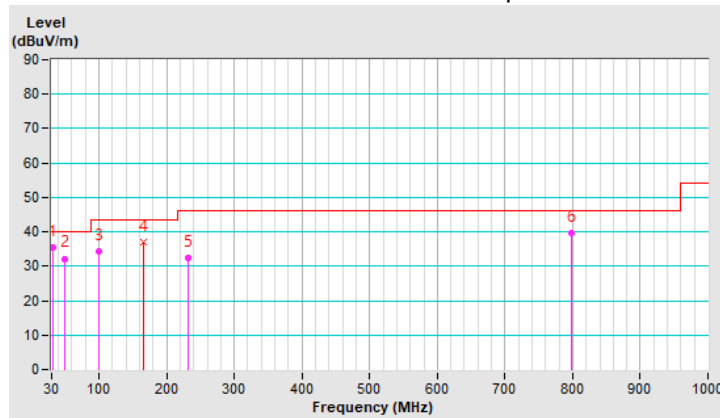

## 4.1.8 Test Results (Mode 2)

## ABOVE 1GHz DATA

## BT\_GFSK

<b>CHANNEL</b>	TX Channel 0	<b>DETECTOR FUNCTION</b>	Peak (PK)
<b>FREQUENCY RANGE</b>	1GHz ~ 25GHz		Average (AV)

**ANTENNA POLARITY & TEST DISTANCE: HORIZONTAL AT 3 M**

NO.	FREQ. (MHz)	EMISSION LEVEL (dBuV/m)	LIMIT (dBuV/m)	MARGIN (dB)	ANTENNA HEIGHT (m)	TABLE ANGLE (Degree)	RAW VALUE (dBuV)	CORRECTION FACTOR (dB/m)
1	2390.00	51.1 PK	74.0	-22.9	1.16 H	34	52.6	-1.5
2	2390.00	41.3 AV	54.0	-12.7	1.16 H	34	42.8	-1.5
3	*2402.00	102.5 PK			1.16 H	34	104.0	-1.5
4	*2402.00	101.8 AV			1.16 H	34	103.3	-1.5
5	4804.00	40.3 PK	74.0	-33.7	1.00 H	331	37.6	2.7
6	4804.00	31.3 AV	54.0	-22.7	1.00 H	331	28.6	2.7

**ANTENNA POLARITY & TEST DISTANCE: VERTICAL AT 3 M**

NO.	FREQ. (MHz)	EMISSION LEVEL (dBuV/m)	LIMIT (dBuV/m)	MARGIN (dB)	ANTENNA HEIGHT (m)	TABLE ANGLE (Degree)	RAW VALUE (dBuV)	CORRECTION FACTOR (dB/m)
1	2390.00	50.1 PK	74.0	-23.9	1.04 V	304	51.6	-1.5
2	2390.00	41.4 AV	54.0	-12.6	1.04 V	304	42.9	-1.5
3	*2402.00	95.5 PK			1.04 V	304	97.0	-1.5
4	*2402.00	94.8 AV			1.04 V	304	96.3	-1.5
5	4804.00	41.7 PK	74.0	-32.3	1.05 V	284	39.0	2.7
6	4804.00	35.8 AV	54.0	-18.2	1.05 V	284	33.1	2.7

**REMARKS:**

1. Emission Level(dBuV/m) = Raw Value(dBuV) + Correction Factor(dB/m)
2. Correction Factor(dB/m) = Antenna Factor(dB/m) + Cable Factor(dB) – Pre-Amplifier Factor(dB)
3. Margin value = Emission Level – Limit value
4. The other emission levels were very low against the limit.
5. " \* ": Fundamental frequency.

<b>CHANNEL</b>	TX Channel 39	<b>DETECTOR FUNCTION</b>	Peak (PK)
<b>FREQUENCY RANGE</b>	1GHz ~ 25GHz		Average (AV)

**ANTENNA POLARITY & TEST DISTANCE: HORIZONTAL AT 3 M**

NO.	FREQ. (MHz)	EMISSION LEVEL (dBuV/m)	LIMIT (dBuV/m)	MARGIN (dB)	ANTENNA HEIGHT (m)	TABLE ANGLE (Degree)	RAW VALUE (dBuV)	CORRECTION FACTOR (dB/m)
1	*2441.00	103.2 PK			1.21 H	234	104.6	-1.4
2	*2441.00	102.4 AV			1.21 H	234	103.8	-1.4
3	4882.00	39.7 PK	74.0	-34.3	1.00 H	331	37.2	2.5
4	4882.00	31.3 AV	54.0	-22.7	1.00 H	331	28.8	2.5
5	7323.00	44.6 PK	74.0	-29.4	1.43 H	172	35.1	9.5
6	7323.00	33.2 AV	54.0	-20.8	1.43 H	172	23.7	9.5

**ANTENNA POLARITY & TEST DISTANCE: VERTICAL AT 3 M**

NO.	FREQ. (MHz)	EMISSION LEVEL (dBuV/m)	LIMIT (dBuV/m)	MARGIN (dB)	ANTENNA HEIGHT (m)	TABLE ANGLE (Degree)	RAW VALUE (dBuV)	CORRECTION FACTOR (dB/m)
1	*2441.00	102.0 PK			1.68 V	223	103.4	-1.4
2	*2441.00	101.3 AV			1.68 V	223	102.7	-1.4
3	4882.00	41.2 PK	74.0	-32.8	1.06 V	269	38.7	2.5
4	4882.00	35.3 AV	54.0	-18.7	1.06 V	269	32.8	2.5
5	7323.00	44.1 PK	74.0	-29.9	1.04 V	164	34.6	9.5
6	7323.00	32.9 AV	54.0	-21.1	1.04 V	164	23.4	9.5

**REMARKS:**

1. Emission Level(dBuV/m) = Raw Value(dBuV) + Correction Factor(dB/m)
2. Correction Factor(dB/m) = Antenna Factor(dB/m) + Cable Factor(dB) – Pre-Amplifier Factor(dB)
3. Margin value = Emission Level – Limit value
4. The other emission levels were very low against the limit.
5. " \* ": Fundamental frequency.

<b>CHANNEL</b>	TX Channel 78	<b>DETECTOR FUNCTION</b>	Peak (PK)
<b>FREQUENCY RANGE</b>	1GHz ~ 25GHz		Average (AV)

**ANTENNA POLARITY & TEST DISTANCE: HORIZONTAL AT 3 M**

NO.	FREQ. (MHz)	EMISSION LEVEL (dBuV/m)	LIMIT (dBuV/m)	MARGIN (dB)	ANTENNA HEIGHT (m)	TABLE ANGLE (Degree)	RAW VALUE (dBuV)	CORRECTION FACTOR (dB/m)
1	*2480.00	104.9 PK			1.02 H	205	106.4	-1.5
2	*2480.00	104.2 AV			1.02 H	205	105.7	-1.5
3	2483.50	53.1 PK	74.0	-20.9	1.02 H	205	54.6	-1.5
4	2483.50	42.6 AV	54.0	-11.4	1.02 H	205	44.1	-1.5
5	4960.00	40.2 PK	74.0	-33.8	1.00 H	337	37.3	2.9
6	4960.00	31.5 AV	54.0	-22.5	1.00 H	337	28.6	2.9
7	7440.00	44.3 PK	74.0	-29.7	1.45 H	164	34.4	9.9
8	7440.00	32.9 AV	54.0	-21.1	1.45 H	164	23.0	9.9

**ANTENNA POLARITY & TEST DISTANCE: VERTICAL AT 3 M**

NO.	FREQ. (MHz)	EMISSION LEVEL (dBuV/m)	LIMIT (dBuV/m)	MARGIN (dB)	ANTENNA HEIGHT (m)	TABLE ANGLE (Degree)	RAW VALUE (dBuV)	CORRECTION FACTOR (dB/m)
1	*2480.00	102.4 PK			1.50 V	276	103.9	-1.5
2	*2480.00	101.9 AV			1.50 V	276	103.4	-1.5
3	2483.50	53.8 PK	74.0	-20.2	1.50 V	276	55.3	-1.5
4	2483.50	42.7 AV	54.0	-11.3	1.50 V	276	44.2	-1.5
5	4960.00	41.7 PK	74.0	-32.3	1.08 V	281	38.8	2.9
6	4960.00	35.8 AV	54.0	-18.2	1.08 V	281	32.9	2.9
7	7440.00	44.2 PK	74.0	-29.8	1.02 V	178	34.3	9.9
8	7440.00	33.3 AV	54.0	-20.7	1.02 V	178	23.4	9.9

**REMARKS:**

1. Emission Level(dBuV/m) = Raw Value(dBuV) + Correction Factor(dB/m)
2. Correction Factor(dB/m) = Antenna Factor(dB/m) + Cable Factor(dB) – Pre-Amplifier Factor(dB)
3. Margin value = Emission Level – Limit value
4. The other emission levels were very low against the limit.
5. " \* ": Fundamental frequency.

**BT\_8DPSK**

<b>CHANNEL</b>	TX Channel 0	<b>DETECTOR FUNCTION</b>	Peak (PK)
<b>FREQUENCY RANGE</b>	1GHz ~ 25GHz		Average (AV)

**ANTENNA POLARITY & TEST DISTANCE: HORIZONTAL AT 3 M**

NO.	FREQ. (MHz)	EMISSION LEVEL (dBuV/m)	LIMIT (dBuV/m)	MARGIN (dB)	ANTENNA HEIGHT (m)	TABLE ANGLE (Degree)	RAW VALUE (dBuV)	CORRECTION FACTOR (dB/m)
1	2390.00	50.5 PK	74.0	-23.5	1.20 H	36	52.0	-1.5
2	2390.00	41.2 AV	54.0	-12.8	1.20 H	36	42.7	-1.5
3	*2402.00	98.7 PK			1.20 H	36	100.2	-1.5
4	*2402.00	94.7 AV			1.20 H	36	96.2	-1.5
5	4804.00	40.7 PK	74.0	-33.3	1.00 H	351	38.0	2.7
6	4804.00	31.7 AV	54.0	-22.3	1.00 H	351	29.0	2.7

**ANTENNA POLARITY & TEST DISTANCE: VERTICAL AT 3 M**

NO.	FREQ. (MHz)	EMISSION LEVEL (dBuV/m)	LIMIT (dBuV/m)	MARGIN (dB)	ANTENNA HEIGHT (m)	TABLE ANGLE (Degree)	RAW VALUE (dBuV)	CORRECTION FACTOR (dB/m)
1	2390.00	50.1 PK	74.0	-23.9	1.13 V	305	51.6	-1.5
2	2390.00	41.1 AV	54.0	-12.9	1.13 V	305	42.6	-1.5
3	*2402.00	91.9 PK			1.13 V	305	93.4	-1.5
4	*2402.00	87.6 AV			1.13 V	305	89.1	-1.5
5	4804.00	41.6 PK	74.0	-32.4	1.04 V	265	38.9	2.7
6	4804.00	35.9 AV	54.0	-18.1	1.04 V	265	33.2	2.7

**REMARKS:**

1. Emission Level(dBuV/m) = Raw Value(dBuV) + Correction Factor(dB/m)
2. Correction Factor(dB/m) = Antenna Factor(dB/m) + Cable Factor(dB) – Pre-Amplifier Factor(dB)
3. Margin value = Emission Level – Limit value
4. The other emission levels were very low against the limit.
5. " \* ": Fundamental frequency.



<b>CHANNEL</b>	TX Channel 39	<b>DETECTOR FUNCTION</b>	Peak (PK)
<b>FREQUENCY RANGE</b>	1GHz ~ 25GHz		Average (AV)

**ANTENNA POLARITY & TEST DISTANCE: HORIZONTAL AT 3 M**

NO.	FREQ. (MHz)	EMISSION LEVEL (dBuV/m)	LIMIT (dBuV/m)	MARGIN (dB)	ANTENNA HEIGHT (m)	TABLE ANGLE (Degree)	RAW VALUE (dBuV)	CORRECTION FACTOR (dB/m)
1	*2441.00	100.3 PK			1.25 H	39	101.7	-1.4
2	*2441.00	96.6 AV			1.25 H	39	98.0	-1.4
3	4882.00	40.3 PK	74.0	-33.7	1.00 H	338	37.8	2.5
4	4882.00	31.3 AV	54.0	-22.7	1.00 H	338	28.8	2.5
5	7323.00	44.3 PK	74.0	-29.7	1.39 H	150	34.8	9.5
6	7323.00	32.8 AV	54.0	-21.2	1.39 H	150	23.3	9.5

**ANTENNA POLARITY & TEST DISTANCE: VERTICAL AT 3 M**

NO.	FREQ. (MHz)	EMISSION LEVEL (dBuV/m)	LIMIT (dBuV/m)	MARGIN (dB)	ANTENNA HEIGHT (m)	TABLE ANGLE (Degree)	RAW VALUE (dBuV)	CORRECTION FACTOR (dB/m)
1	*2441.00	89.5 PK			1.07 V	291	90.9	-1.4
2	*2441.00	85.3 AV			1.07 V	291	86.7	-1.4
3	4882.00	42.0 PK	74.0	-32.0	1.09 V	274	39.5	2.5
4	4882.00	35.9 AV	54.0	-18.1	1.09 V	274	33.4	2.5
5	7323.00	44.4 PK	74.0	-29.6	1.00 V	188	34.9	9.5
6	7323.00	33.4 AV	54.0	-20.6	1.00 V	188	23.9	9.5

**REMARKS:**

1. Emission Level(dBuV/m) = Raw Value(dBuV) + Correction Factor(dB/m)
2. Correction Factor(dB/m) = Antenna Factor(dB/m) + Cable Factor(dB) – Pre-Amplifier Factor(dB)
3. Margin value = Emission Level – Limit value
4. The other emission levels were very low against the limit.
5. " \* ": Fundamental frequency.

<b>CHANNEL</b>	TX Channel 78	<b>DETECTOR FUNCTION</b>	Peak (PK)
<b>FREQUENCY RANGE</b>	1GHz ~ 25GHz		Average (AV)

**ANTENNA POLARITY & TEST DISTANCE: HORIZONTAL AT 3 M**

NO.	FREQ. (MHz)	EMISSION LEVEL (dBuV/m)	LIMIT (dBuV/m)	MARGIN (dB)	ANTENNA HEIGHT (m)	TABLE ANGLE (Degree)	RAW VALUE (dBuV)	CORRECTION FACTOR (dB/m)
1	*2480.00	100.6 PK			1.04 H	205	102.1	-1.5
2	*2480.00	96.7 AV			1.04 H	205	98.2	-1.5
3	2483.50	52.5 PK	74.0	-21.5	1.04 H	205	54.0	-1.5
4	2483.50	43.6 AV	54.0	-10.4	1.04 H	205	45.1	-1.5
5	4960.00	39.6 PK	74.0	-34.4	1.01 H	340	36.7	2.9
6	4960.00	31.1 AV	54.0	-22.9	1.01 H	340	28.2	2.9
7	7440.00	44.4 PK	74.0	-29.6	1.46 H	174	34.5	9.9
8	7440.00	33.2 AV	54.0	-20.8	1.46 H	174	23.3	9.9

**ANTENNA POLARITY & TEST DISTANCE: VERTICAL AT 3 M**

NO.	FREQ. (MHz)	EMISSION LEVEL (dBuV/m)	LIMIT (dBuV/m)	MARGIN (dB)	ANTENNA HEIGHT (m)	TABLE ANGLE (Degree)	RAW VALUE (dBuV)	CORRECTION FACTOR (dB/m)
1	*2480.00	89.2 PK			1.03 V	274	90.7	-1.5
2	*2480.00	84.9 AV			1.03 V	274	86.4	-1.5
3	2483.50	52.9 PK	74.0	-21.1	1.03 V	274	54.4	-1.5
4	2483.50	43.4 AV	54.0	-10.6	1.03 V	274	44.9	-1.5
5	4960.00	42.2 PK	74.0	-31.8	1.13 V	282	39.3	2.9
6	4960.00	36.0 AV	54.0	-18.0	1.13 V	282	33.1	2.9
7	7440.00	44.6 PK	74.0	-29.4	1.03 V	169	34.7	9.9
8	7440.00	33.8 AV	54.0	-20.2	1.03 V	169	23.9	9.9

**REMARKS:**

1. Emission Level(dBuV/m) = Raw Value(dBuV) + Correction Factor(dB/m)
2. Correction Factor(dB/m) = Antenna Factor(dB/m) + Cable Factor(dB) – Pre-Amplifier Factor(dB)
3. Margin value = Emission Level – Limit value
4. The other emission levels were very low against the limit.
5. " \* ": Fundamental frequency.

**Below 1GHz Data:**

**BT\_GFSK**

<b>CHANNEL</b>	TX Channel 39	<b>DETECTOR FUNCTION</b>	Quasi-Peak (QP)
<b>FREQUENCY RANGE</b>	9kHz ~ 1GHz		

**ANTENNA POLARITY & TEST DISTANCE: HORIZONTAL AT 3 M**

NO.	FREQ. (MHz)	EMISSION LEVEL (dBuV/m)	LIMIT (dBuV/m)	MARGIN (dB)	ANTENNA HEIGHT (m)	TABLE ANGLE (Degree)	RAW VALUE (dBuV)	CORRECTION FACTOR (dB/m)
1	31.97	33.7 QP	40.0	-6.3	1.00 H	10	43.2	-9.5
2	50.32	30.6 QP	40.0	-9.4	3.00 H	3	38.4	-7.8
3	166.02	38.0 QP	43.5	-5.5	1.82 H	77	46.0	-8.0
4	232.40	35.7 QP	46.0	-10.3	1.00 H	101	45.6	-9.9
5	335.98	35.2 QP	46.0	-10.8	1.00 H	195	41.1	-5.9
6	798.28	42.8 QP	46.0	-3.2	1.00 H	256	38.2	4.6

**REMARKS:**

1. Emission Level(dBuV/m) = Raw Value(dBuV) + Correction Factor(dB/m)
2. Correction Factor(dB/m) = Antenna Factor(dB/m) + Cable Factor(dB) – Pre-Amplifier Factor(dB)
3. Margin value = Emission Level – Limit value
4. The other emission levels were very low against the limit of frequency range 30MHz~1000MHz.
5. The emission levels were very low against the limit of frequency range 9kHz~30MHz: the amplitude of spurious emissions attenuated more than 20 dB below the permissible value to be report.

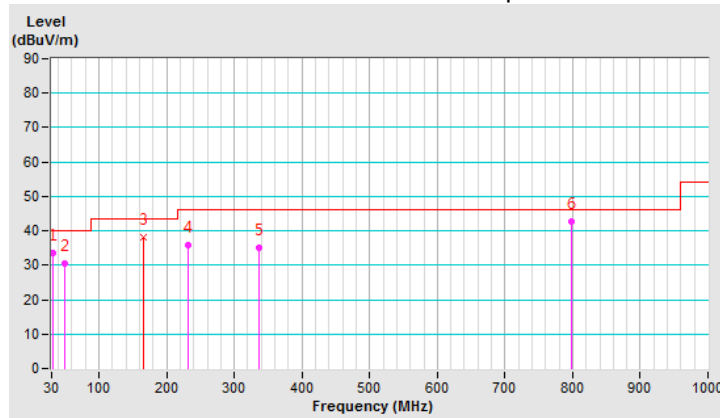

<b>CHANNEL</b>	TX Channel 39	<b>DETECTOR FUNCTION</b>	Quasi-Peak (QP)
<b>FREQUENCY RANGE</b>	9kHz ~ 1GHz		

ANTENNA POLARITY & TEST DISTANCE: VERTICAL AT 3 M								
NO.	FREQ. (MHz)	EMISSION LEVEL (dBuV/m)	LIMIT (dBuV/m)	MARGIN (dB)	ANTENNA HEIGHT (m)	TABLE ANGLE (Degree)	RAW VALUE (dBuV)	CORRECTION FACTOR (dB/m)
1	31.46	36.3 QP	40.0	-3.7	1.00 V	185	45.7	-9.4
2	100.00	35.0 QP	43.5	-8.5	1.50 V	95	47.1	-12.1
3	165.94	37.7 QP	43.5	-5.8	1.00 V	269	45.6	-7.9
4	232.42	32.5 QP	46.0	-13.5	1.00 V	212	42.4	-9.9
5	335.99	32.5 QP	46.0	-13.5	1.50 V	303	38.4	-5.9
6	798.20	39.3 QP	46.0	-6.7	1.00 V	277	34.7	4.6

**REMARKS:**

1. Emission Level(dBuV/m) = Raw Value(dBuV) + Correction Factor(dB/m)
2. Correction Factor(dB/m) = Antenna Factor(dB/m) + Cable Factor(dB) – Pre-Amplifier Factor(dB)
3. Margin value = Emission Level – Limit value
4. The other emission levels were very low against the limit of frequency range 30MHz~1000MHz.
5. The emission levels were very low against the limit of frequency range 9kHz~30MHz: the amplitude of spurious emissions attenuated more than 20 dB below the permissible value to be report.

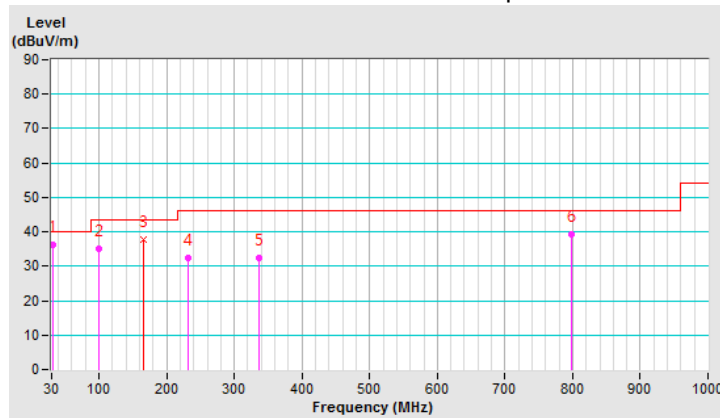

## 4.2 Conducted Emission Measurement

### 4.2.1 Limits of Conducted Emission Measurement

Frequency (MHz)	Conducted Limit (dBuV)	
	Quasi-peak	Average
0.15 - 0.5	66 - 56	56 - 46
0.50 - 5.0	56	46
5.0 - 30.0	60	50

Note: 1. The lower limit shall apply at the transition frequencies.

2. The limit decreases in line with the logarithm of the frequency in the range of 0.15 to 0.50MHz.

### 4.2.2 Test Instruments

DESCRIPTION & MANUFACTURER	MODEL NO.	SERIAL NO.	CALIBRATED DATE	CALIBRATED UNTIL
Test Receiver R&S	ESCS 30	847124/029	Oct. 23, 2019	Oct. 22, 2020
Line-Impedance Stabilization Network (for EUT) R&S	ESH3-Z5	848773/004	Oct. 23, 2019	Oct. 22, 2020
Line-Impedance Stabilization Network (for Peripheral) R&S	ESH3-Z5	835239/001	Mar. 19, 2020	Mar. 18, 2021
50 ohms Terminator	50	3	Oct. 23, 2019	Oct. 22, 2020
RF Cable	5D-FB	COCCAB-001	Sep. 27, 2019	Sep. 26, 2020
Fixed attenuator EMCI	STI02-2200-10	005	Aug. 30, 2019	Aug. 29, 2020
Software BVADT	BVADT_Cond_ V7.3.7.4	NA	NA	NA

**Note:**

1. The calibration interval of the above test instruments are 12 months and the calibrations are traceable to NML/ROC and NIST/USA.
2. The test was performed in Conduction 1.
3. Tested Date: Apr. 15, 2020

#### 4.2.3 Test Procedures

- The EUT was placed 0.4 meters from the conducting wall of the shielded room with EUT being connected to the power mains through a line impedance stabilization network (LISN). Other support units were connected to the power mains through another LISN. The two LISNs provide 50 ohm/ 50uH of coupling impedance for the measuring instrument.
- Both lines of the power mains connected to the EUT were checked for maximum conducted interference.
- The frequency range from 150kHz to 30MHz was searched. Emission levels under (Limit - 20dB) was not recorded.

**NOTE:** The resolution bandwidth and video bandwidth of test receiver is 9kHz for quasi-peak detection (QP) and average detection (AV) at frequency 0.15MHz-30MHz.

#### 4.2.4 Deviation From Test Standard

No deviation.

#### 4.2.5 Test Setup

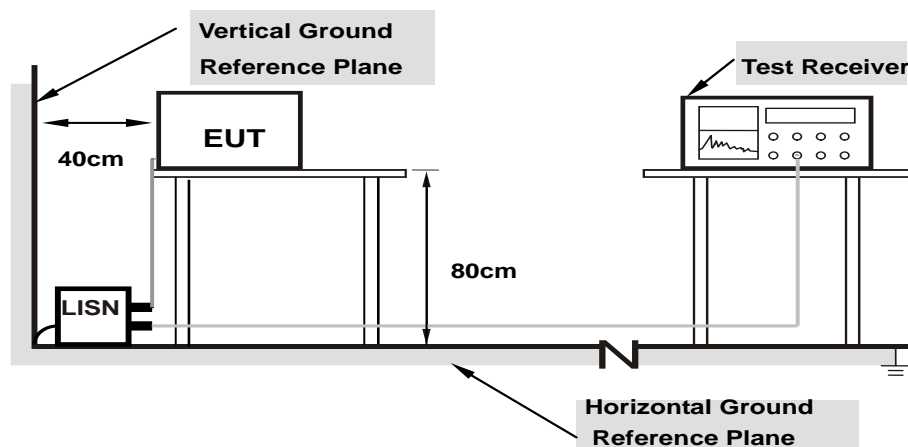

**Note: 1.Support units were connected to second LISN.**

For the actual test configuration, please refer to the attached file (Test Setup Photo).

#### 4.2.6 EUT Operating Condition

Same as 4.1.6.

#### 4.2.7 Test Results

Phase	Line (L)	Detector Function	Quasi-Peak (QP) / Average (AV)
-------	----------	-------------------	--------------------------------

Phase Of Power : Line (L)										
No	Frequency (MHz)	Correction Factor (dB)	Reading Value (dBuV)		Emission Level (dBuV)		Limit (dBuV)		Margin (dB)	
			Q.P.	AV.	Q.P.	AV.	Q.P.	AV.	Q.P.	AV.
1	0.15000	9.97	46.83	25.76	56.80	35.73	66.00	56.00	-9.20	-20.27
2	0.22031	9.97	39.82	11.39	49.79	21.36	62.81	52.81	-13.02	-31.45
3	0.37656	9.98	31.25	21.41	41.23	31.39	58.35	48.35	-17.12	-16.96
4	0.60313	9.99	25.59	16.38	35.58	26.37	56.00	46.00	-20.42	-19.63
5	2.33594	10.09	26.69	20.63	36.78	30.72	56.00	46.00	-19.22	-15.28
6	17.33594	10.90	27.09	17.87	37.99	28.77	60.00	50.00	-22.01	-21.23

#### Remarks:

1. Q.P. and AV. are abbreviations of quasi-peak and average individually.
2. The emission levels of other frequencies were very low against the limit.
3. Margin value = Emission level – Limit value
4. Correction factor = Insertion loss + Cable loss
5. Emission Level = Correction Factor + Reading Value

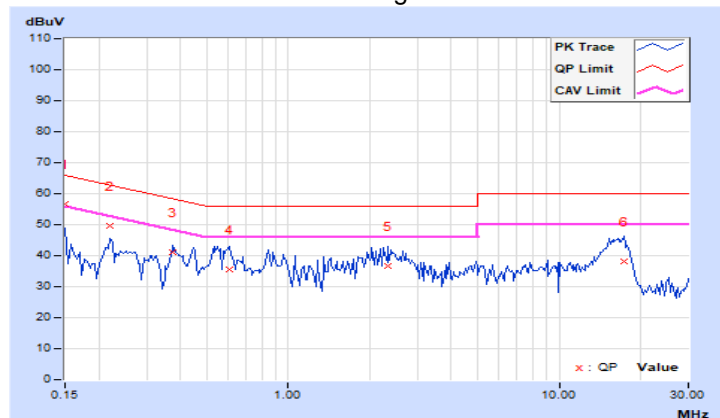

Phase	Neutral (N)	Detector Function	Quasi-Peak (QP) / Average (AV)
-------	-------------	-------------------	--------------------------------

Phase Of Power : Neutral (N)										
No	Frequency (MHz)	Correction Factor (dB)	Reading Value (dBuV)		Emission Level (dBuV)		Limit (dBuV)		Margin (dB)	
			Q.P.	AV.	Q.P.	AV.	Q.P.	AV.	Q.P.	AV.
1	0.18906	9.97	21.14	9.78	31.11	19.75	64.08	54.08	-32.97	-34.33
2	0.40391	9.98	14.41	12.74	24.39	22.72	57.77	47.77	-33.38	-25.05
3	0.93125	10.02	24.78	17.09	34.80	27.11	56.00	46.00	-21.20	-18.89
4	2.00781	10.06	27.09	19.26	37.15	29.32	56.00	46.00	-18.85	-16.68
5	4.09766	10.14	20.80	1.16	30.94	11.30	56.00	46.00	-25.06	-34.70
6	12.56250	10.50	20.48	12.76	30.98	23.26	60.00	50.00	-29.02	-26.74

**Remarks:**

1. Q.P. and AV. are abbreviations of quasi-peak and average individually.
2. The emission levels of other frequencies were very low against the limit.
3. Margin value = Emission level – Limit value
4. Correction factor = Insertion loss + Cable loss
5. Emission Level = Correction Factor + Reading Value

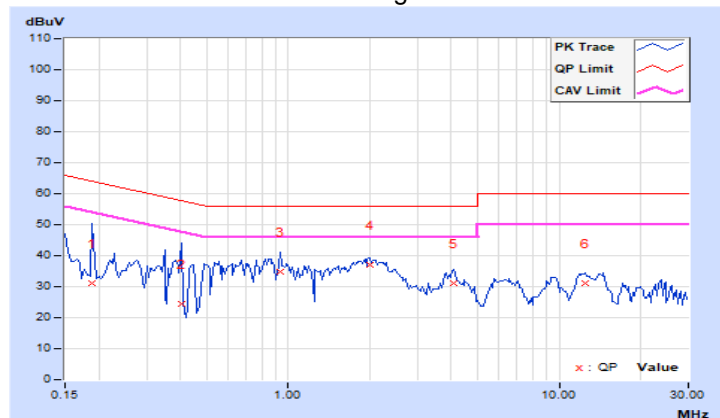



### 4.3 Number of Hopping Frequency Used

#### 4.3.1 Limits of Hopping Frequency Used Measurement

At least 15 channels frequencies, and should be equally spaced.

#### 4.3.2 Test Setup



#### 4.3.3 Test Instruments

Refer to section 4.1.2 to get information of above instrument.

#### 4.3.4 Test Procedure

- a. Check the calibration of the measuring instrument (SA) using either an internal calibrator or a known signal from an external generator.
- b. Turn on the EUT and connect its antenna terminal to measurement via a low loss cable. Then set it to any one measured frequency within its operating range and make sure the instrument is operated in its linear range.
- c. Set the SA on MaxHold Mode, and then keep the EUT in hopping mode. Record all the signals from each channel until each one has been recorded.
- d. Set the SA on View mode and then plot the result on SA screen.
- e. Repeat above procedures until all frequencies measured were complete.

#### 4.3.5 Deviation from Test Standard

No deviation.

### 4.3.6 Test Results

There are 79 hopping frequencies in the hopping mode. Please refer to next page for the test result. On the plots, it shows that the hopping frequencies are equally spaced.

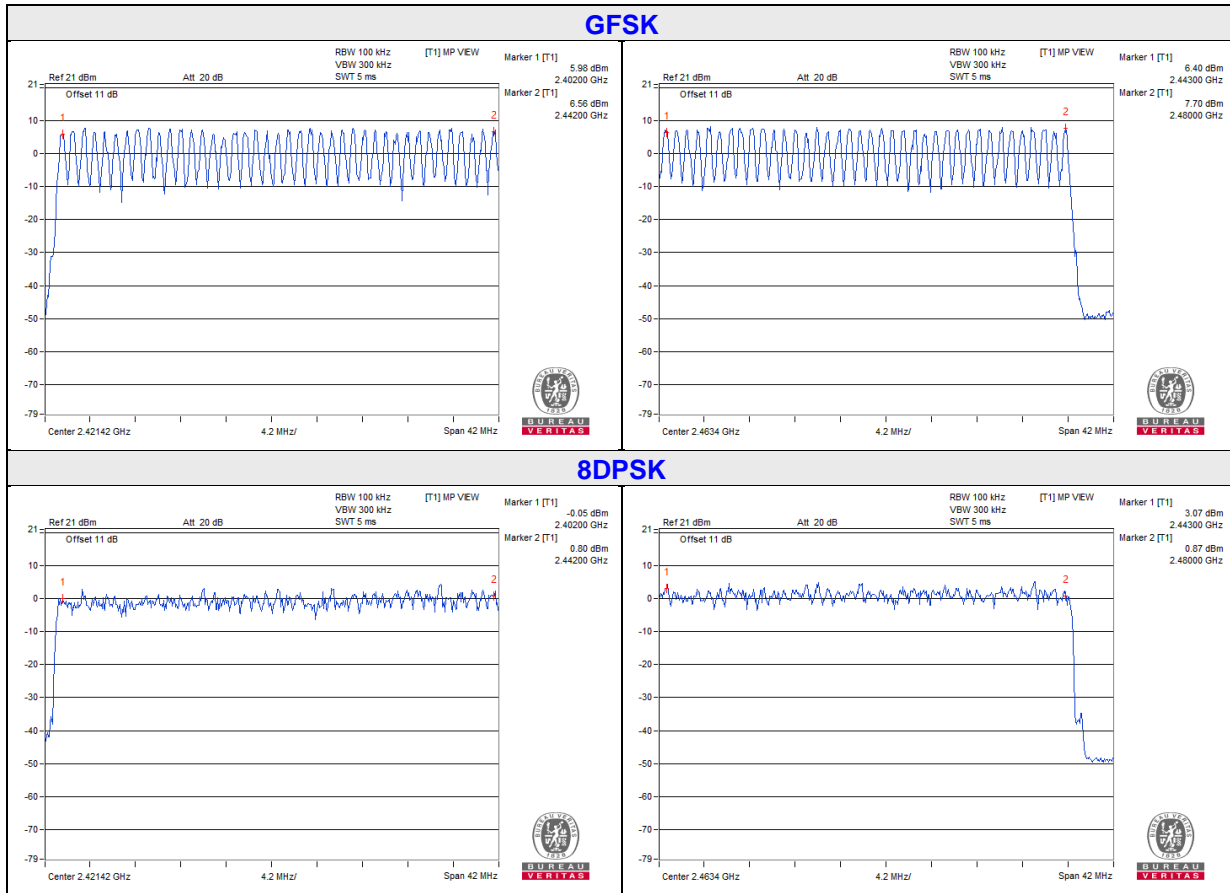

#### 4.4 Dwell Time on Each Channel

##### 4.4.1 Limits of Dwell Time on Each Channel Measurement

The average time of occupancy on any channel shall not be greater than 0.4 seconds within a period of 0.4 seconds multiplied by the number of hopping channels employed.

##### 4.4.2 Test Setup

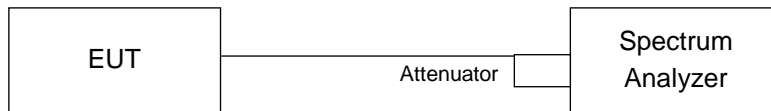

##### 4.4.3 Test Instruments

Refer to section 4.1.2 to get information of above instrument.

##### 4.4.4 Test Procedures

- a. Check the calibration of the measuring instrument (SA) using either an internal calibrator or a known signal from an external generator.
- b. Turn on the EUT and connect its antenna terminal to measurement via a low loss cable. Then set it to any one measured frequency within its operating range and make sure the instrument is operated in its linear range.
- c. Adjust the center frequency of SA on any frequency be measured and set SA to zero span mode. And then, set RBW and VBW of spectrum analyzer to proper value.
- d. Measure the time duration of one transmission on the measured frequency. And then plot the result with time difference of this time duration.
- e. Repeat above procedures until all different time-slot modes have been completed.

##### 4.4.5 Deviation from Test Standard

No deviation.

#### 4.4.6 Test Results

##### GFSK

Mode	Number of transmission in a 31.6 (79Hopping*0.4)	Length of transmission time (msec)	Result (msec)	Limit (msec)
DH1	46 (times / 5 sec) * 6.32 = 291 times	0.492	143.17	400
DH3	25 (times / 5 sec) * 6.32 = 158 times	1.75	276.5	400
DH5	18 (times / 5 sec) * 6.32 = 114 times	3.04	346.56	400

**NOTE:** Test plots of the transmitting time slot are shown on next page.

### DH1

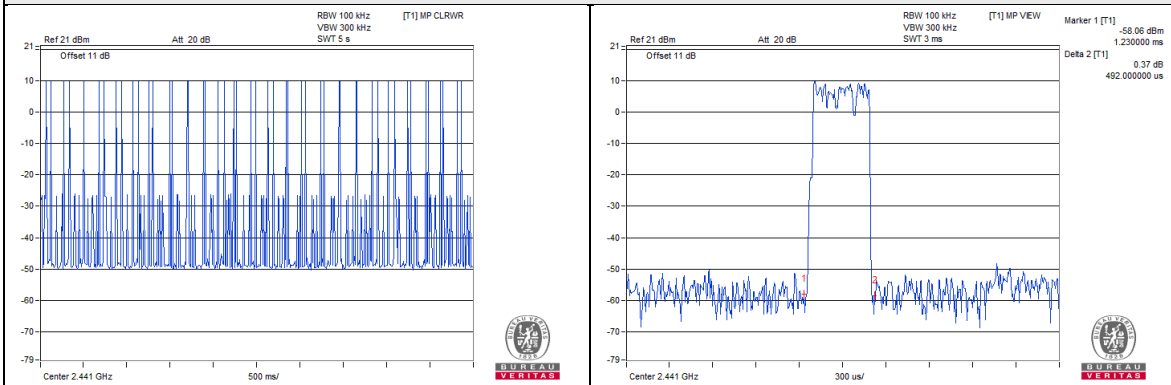

### DH3

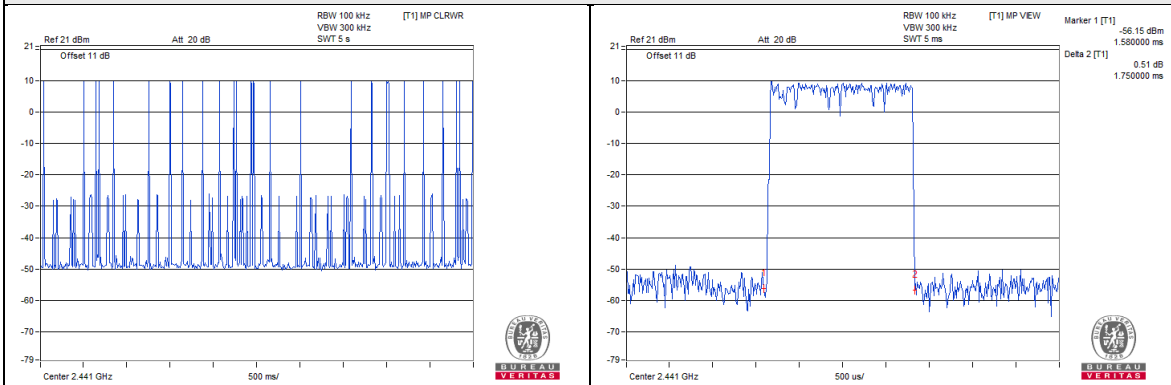

### DH5

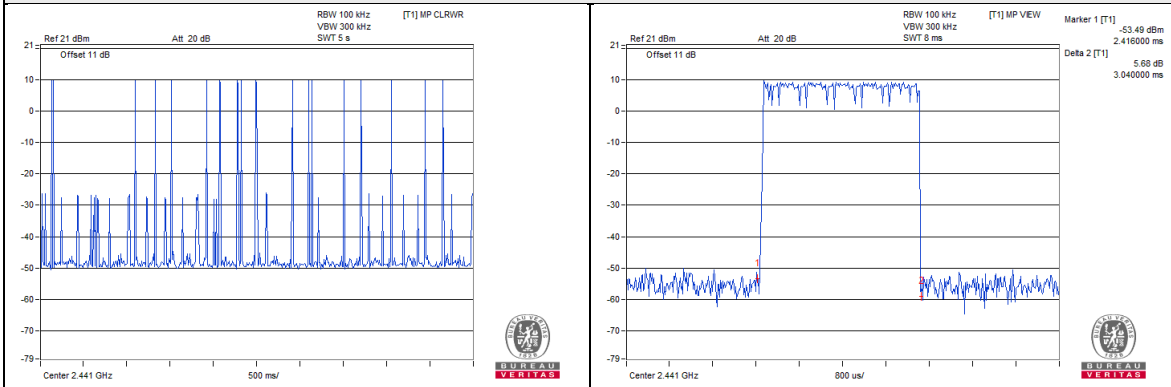

### 8DPSK

Mode	Number of transmission in a 31.6 (79Hopping*0.4)	Length of transmission time (msec)	Result (msec)	Limit (msec)
3DH1	50 (times / 5 sec) * 6.32 = 316 times	0.45	142.2	400
3DH3	26 (times / 5 sec) * 6.32 = 165 times	1.75	288.75	400
3DH5	16(times / 5 sec) * 6.32 = 102 times	3.056	311.71	400

**NOTE:** Test plots of the transmitting time slot are shown on next page.

### 3DH1

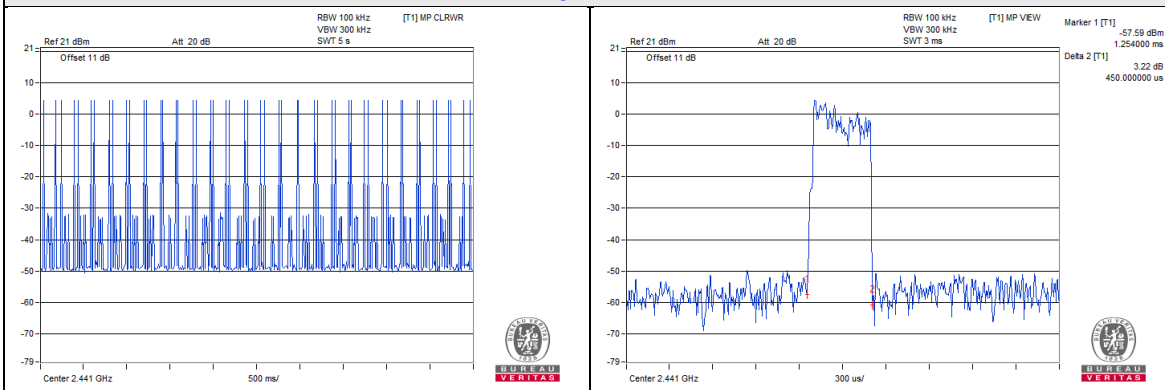

### 3DH3

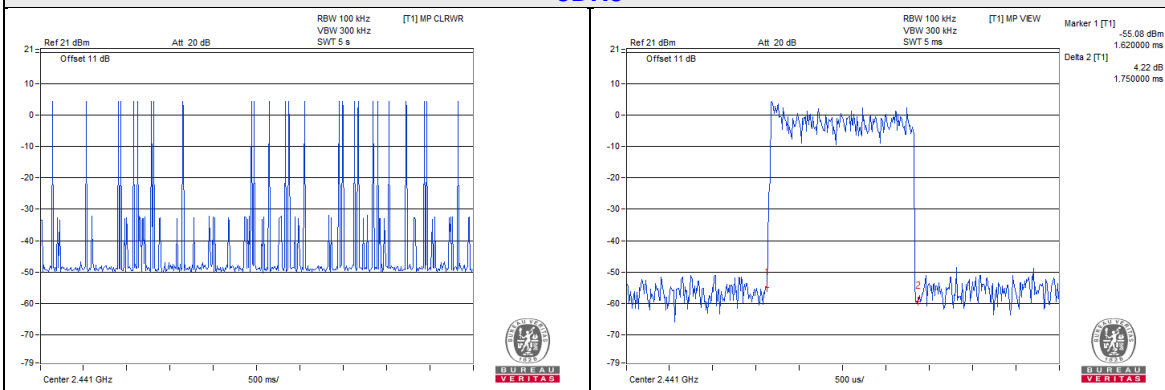

### 3DH5

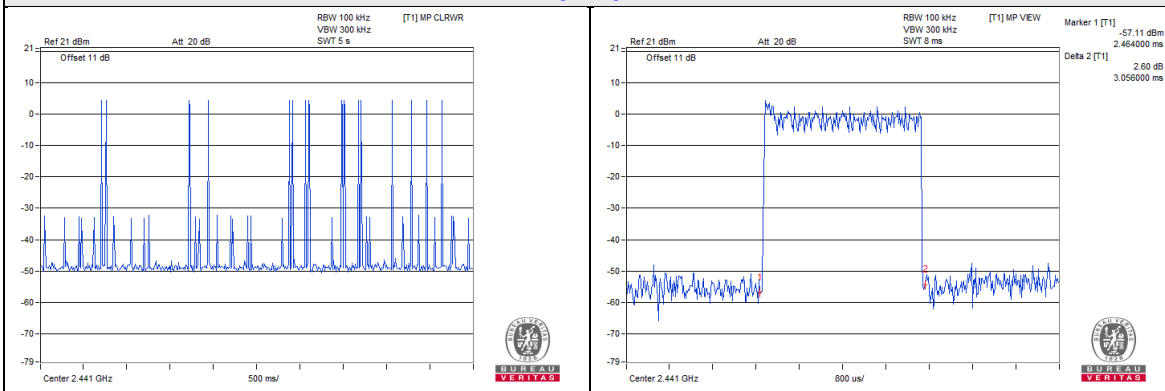

## 4.5 Channel Bandwidth

### 4.5.1 Limits of Channel Bandwidth Measurement

For frequency hopping system operating in the 2400-2483.5MHz, If the 20dB bandwidth of hopping channel is greater than 25kHz, two-thirds 20dB bandwidth of hopping channel shall be a minimum limit for the hopping channel separation.

### 4.5.2 Test Setup

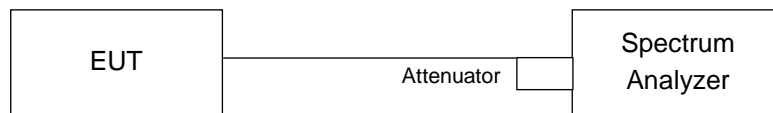

### 4.5.3 Test Instruments

Refer to section 4.1.2 to get information of above instrument.

### 4.5.4 Test Procedure

- Check the calibration of the measuring instrument using either an internal calibrator or a known signal from an external generator.
- Turn on the EUT and connect it to measurement instrument. Then set it to any one convenient frequency within its operating range. Set a reference level on the measuring instrument equal to the highest peak value.
- Measure the frequency difference of two frequencies that were attenuated 20dB from the reference level. Record the frequency difference as the emission bandwidth.
- Repeat above procedures until all frequencies measured were complete.

### 4.5.5 Deviation from Test Standard

No deviation.

### 4.5.6 EUT Operating Condition

The software provided by client enabled the EUT to transmit and receive data at lowest, middle and highest channel frequencies individually.



### 4.5.7 Test Results

Channel	Frequency (MHz)	20dB Bandwidth (MHz)	
		GFSK	8DPSK
0	2402	0.99	1.32
39	2441	0.99	1.32
78	2480	0.99	1.32

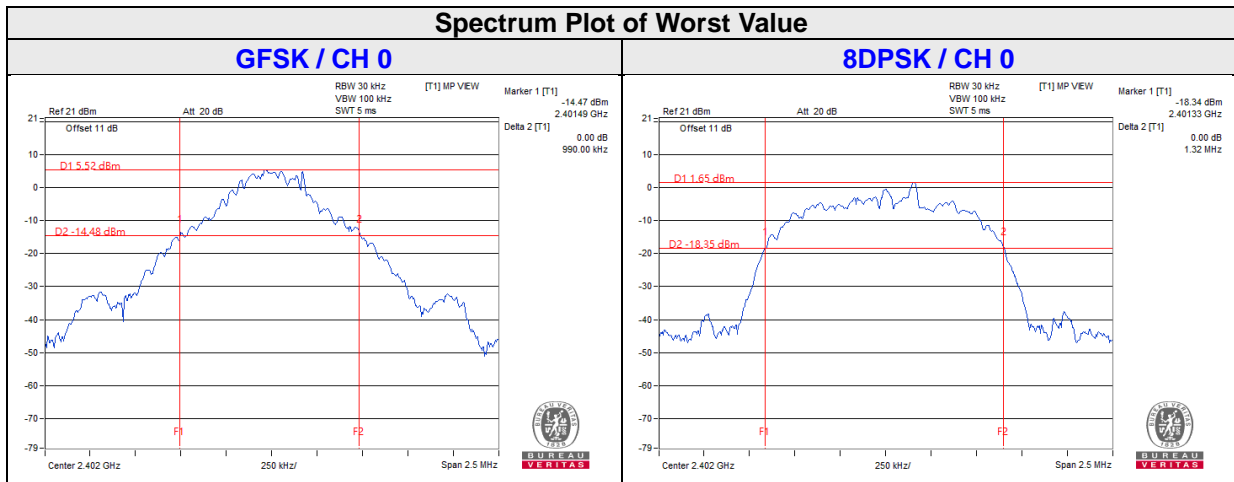

## 4.6 Hopping Channel Separation

### 4.6.1 Limits of Hopping Channel Separation Measurement

At least 25kHz or two-third of 20dB hopping channel bandwidth (whichever is greater).

### 4.6.2 Test Setup

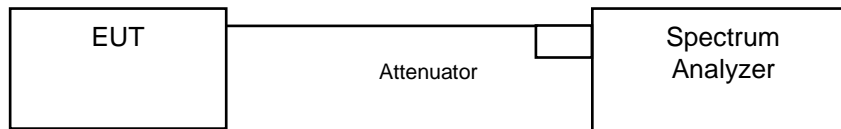

### 4.6.3 Test Instruments

Refer to section 4.1.2 to get information of above instrument.

### 4.6.4 Test Procedure

Measurement Procedure REF

- a. Check the calibration of the measuring instrument using either an internal calibrator or a known signal from an external generator.
- b. Turn on the EUT and connect it to measurement instrument. Then set it to any one convenient frequency within its operating range.
- c. By using the MaxHold function record the separation of two adjacent channels.
- d. Measure the frequency difference of these two adjacent channels by SA MARK function. And then plot the result on SA screen.
- e. Repeat above procedures until all frequencies measured were complete.

### 4.6.5 Deviation from Test Standard

No deviation.

#### 4.6.6 Test Results

Channel	Frequency (MHz)	Adjacent Channel Separation (MHz)		20dB Bandwidth (MHz)		Minimum Limit (MHz)		Pass / Fail
		GFSK	8DPSK	GFSK	8DPSK	GFSK	8DPSK	
0	2402	1	1	0.99	1.32	0.66	0.88	Pass
39	2441	1	1	0.99	1.32	0.66	0.88	Pass
78	2480	1	1	0.99	1.32	0.66	0.88	Pass

**NOTE:** The minimum limit is two-third 20dB bandwidth.

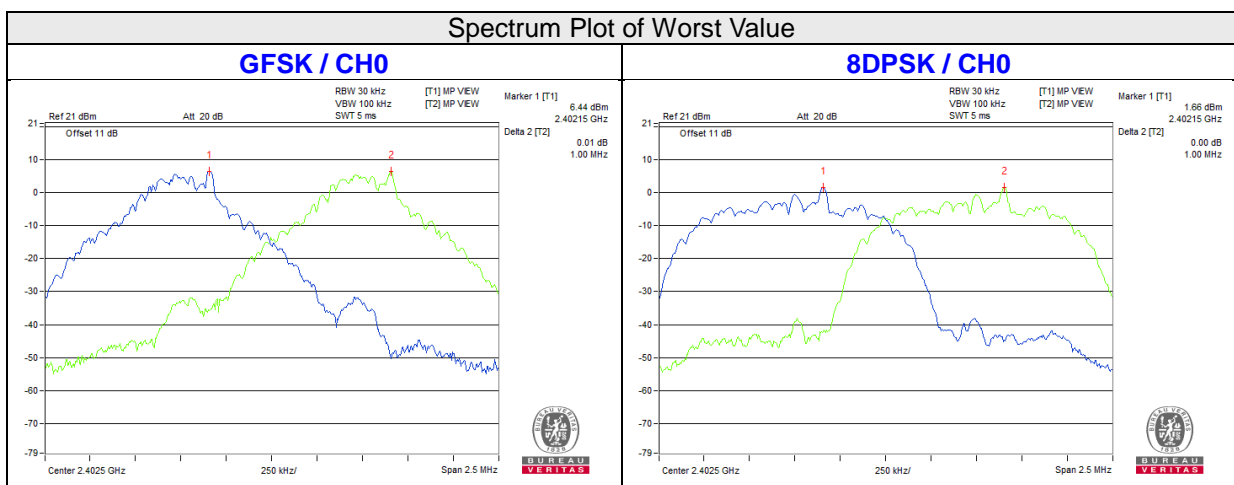

## 4.7 Maximum Output Power

### 4.7.1 Limits of Maximum Output Power Measurement

The Maximum Output Power Measurement is 125mW.

### 4.7.2 Test Setup

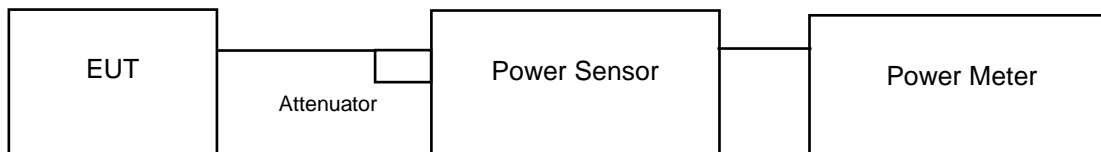

### 4.7.3 Test Instruments

Refer to section 4.1.2 to get information of above instrument.

### 4.7.4 Test Procedure

A peak power sensor was used on the output port of the EUT. A power meter was used to read the response of the peak power sensor. Record the power level.

Average power sensor was used to perform output power measurement, trigger and gating function of wide band power meter is enabled to measure max output power of TX on burst. Duty factor is not added to measured value.

### 4.7.5 Deviation from Test Standard

No deviation.

### 4.7.6 EUT Operating Condition

The software provided by client enabled the EUT to transmit and receive data at lowest, middle and highest channel frequencies individually.

#### 4.7.7 Test Results

##### FOR PEAK POWER

Channel	Frequency (MHZ)	GFSK		8DPSK		Power Limit (mW)	Pass / Fail
		Output Power (mW)	Output Power (dBm)	Output Power (mW)	Output Power (dBm)		
0	2402	7.063	8.49	3.811	5.81	125	Pass
39	2441	9.772	9.90	4.009	6.03	125	Pass
78	2480	9.638	9.84	3.855	5.86	125	Pass

##### FOR AVERAGE POWER

Channel	Frequency (MHZ)	GFSK		8DPSK	
		Average Power (mW)	Average Power (dBm)	Average Power (mW)	Average Power (dBm)
0	2402	6.855	8.36	1.954	2.91
39	2441	9.594	9.82	2.075	3.17
78	2480	8.337	9.21	1.963	2.93

## 4.8 Conducted Out of Band Emission Measurement

### 4.8.1 Limits of Conducted Out of Band Emission Measurement

Below 20dB of the highest emission level of operating band (in 100kHz Resolution Bandwidth).

### 4.8.2 Test Instruments

Refer to section 4.1.2 to get information of above instrument.

### 4.8.3 Test Procedure

The transmitter output was connected to the spectrum analyzer via a low lose cable. Set both RBW and VBW of spectrum analyzer to 100 kHz and 300 kHz with suitable frequency span including 100 MHz bandwidth from band edge. The band edges was measured and recorded.

### 4.8.4 Deviation from Test Standard

No deviation.

### 4.8.5 EUT Operating Condition

The software provided by client enabled the EUT to transmit and receive data at lowest and highest channel frequencies individually.

### 4.8.6 Test Results

The spectrum plots are attached on the following images. D1 line indicates the highest level, D2 line indicates the 20dB offset below D1. It shows compliance with the requirement.

**GFSK**

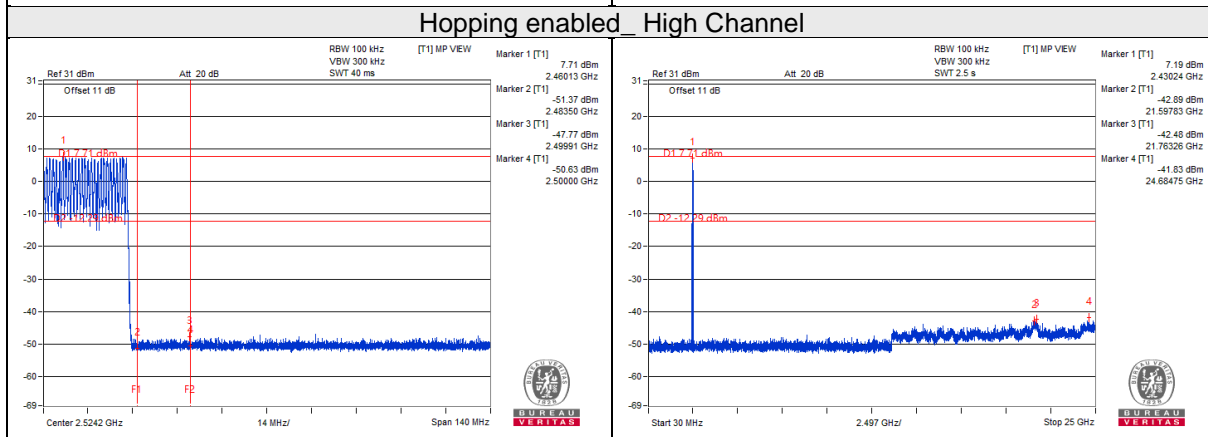
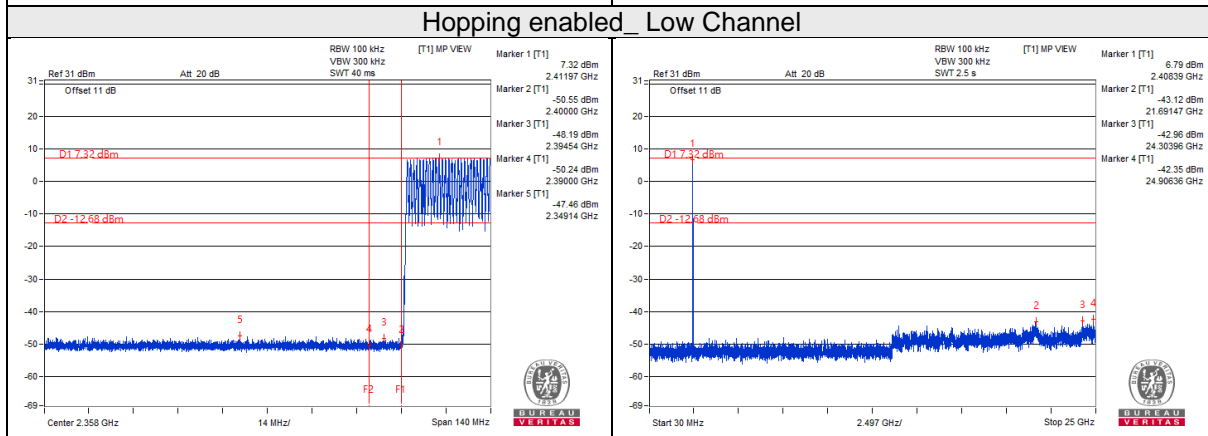
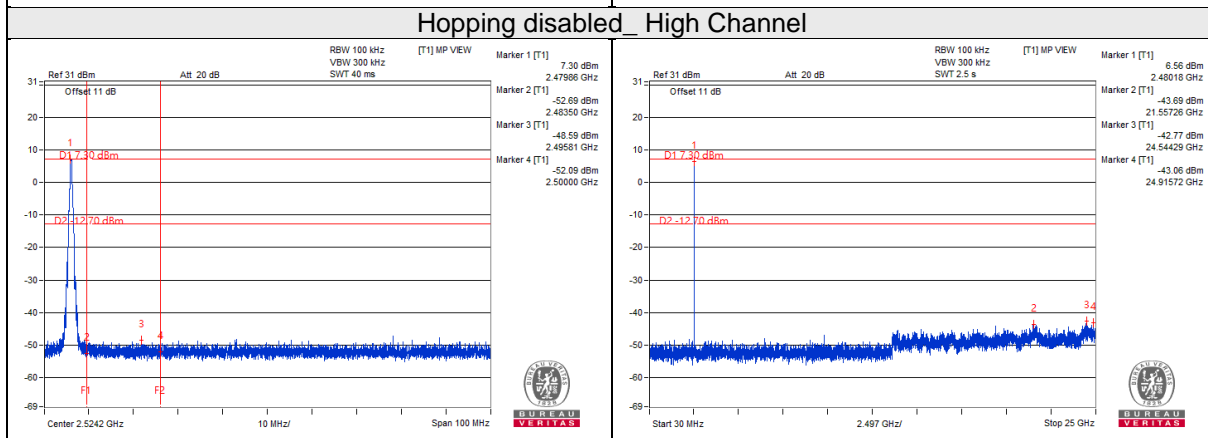
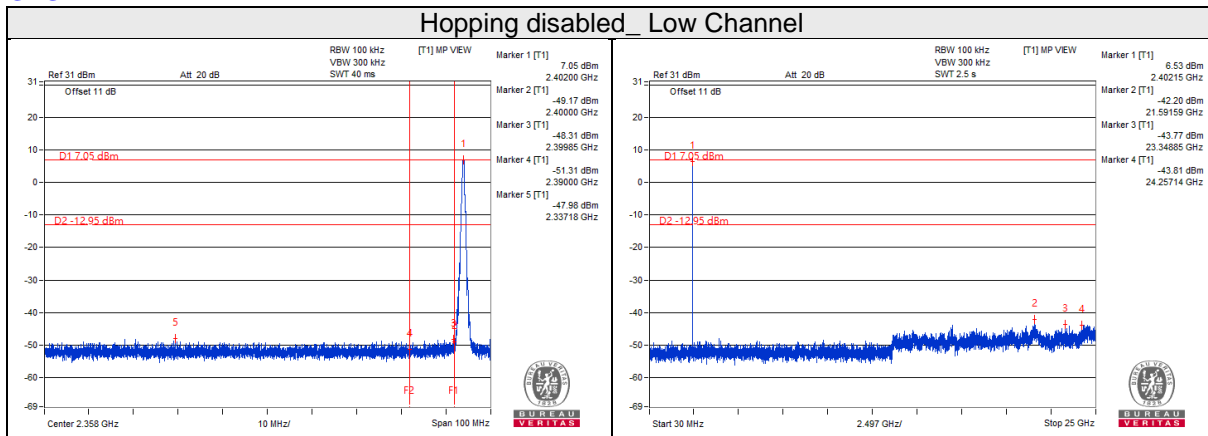

8DPSK

Hopping disabled\_Low Channel

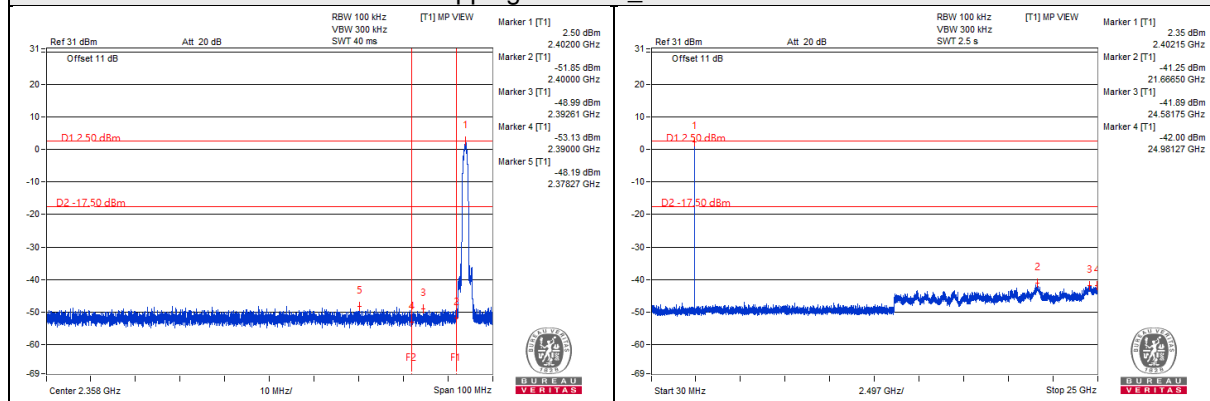

Hopping disabled\_High Channel

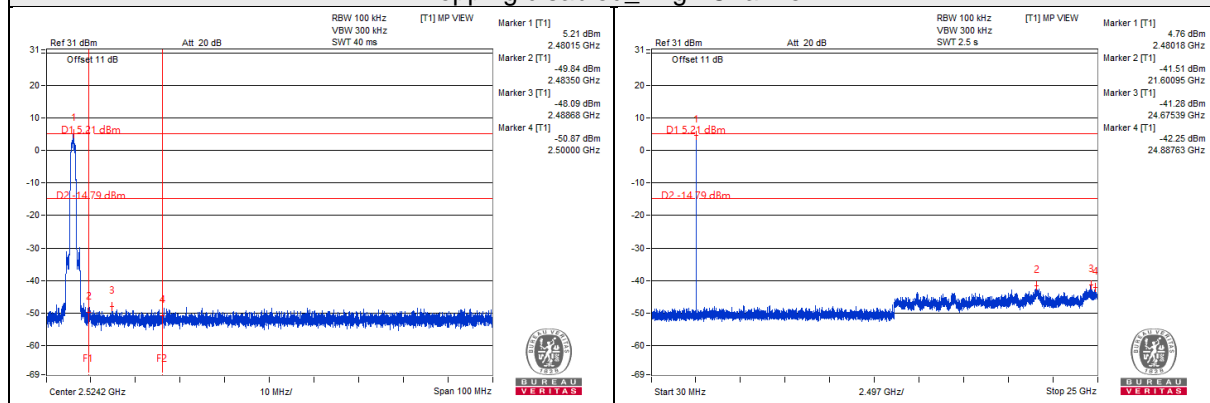

Hopping enabled\_Low Channel

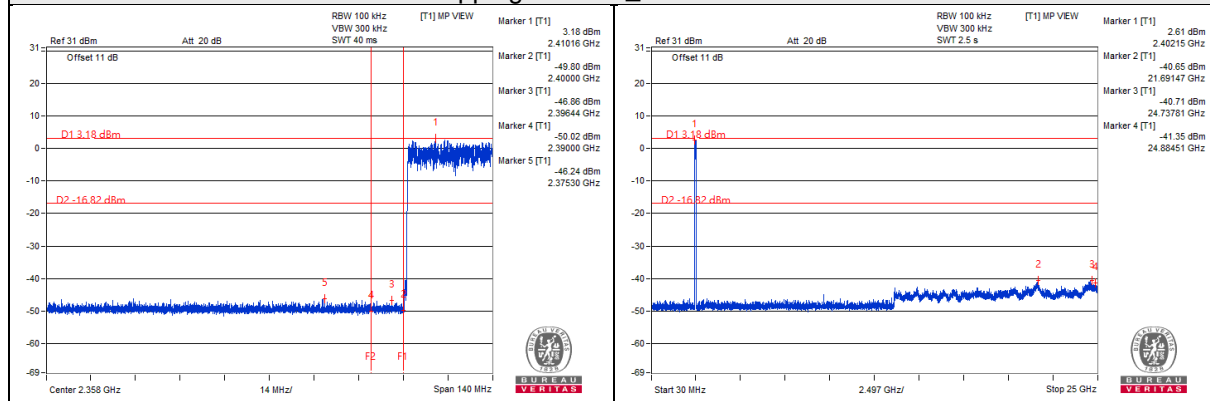

Hopping enabled\_High Channel

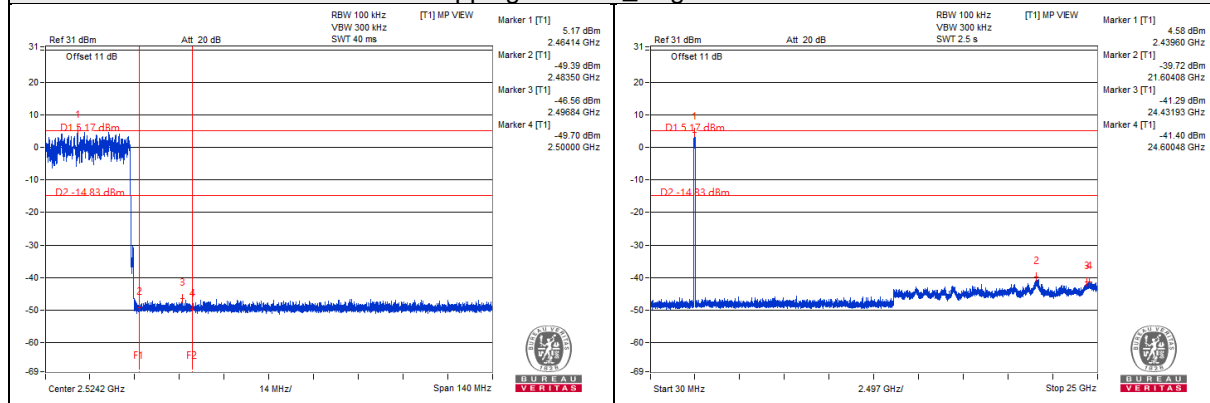



## 5 Pictures of Test Arrangements

Please refer to the attached file (Test Setup Photo).

# Annex A- Band-edge measurement

## Annex A.1 - Test Results (Mode 1)

BT\_GFSK

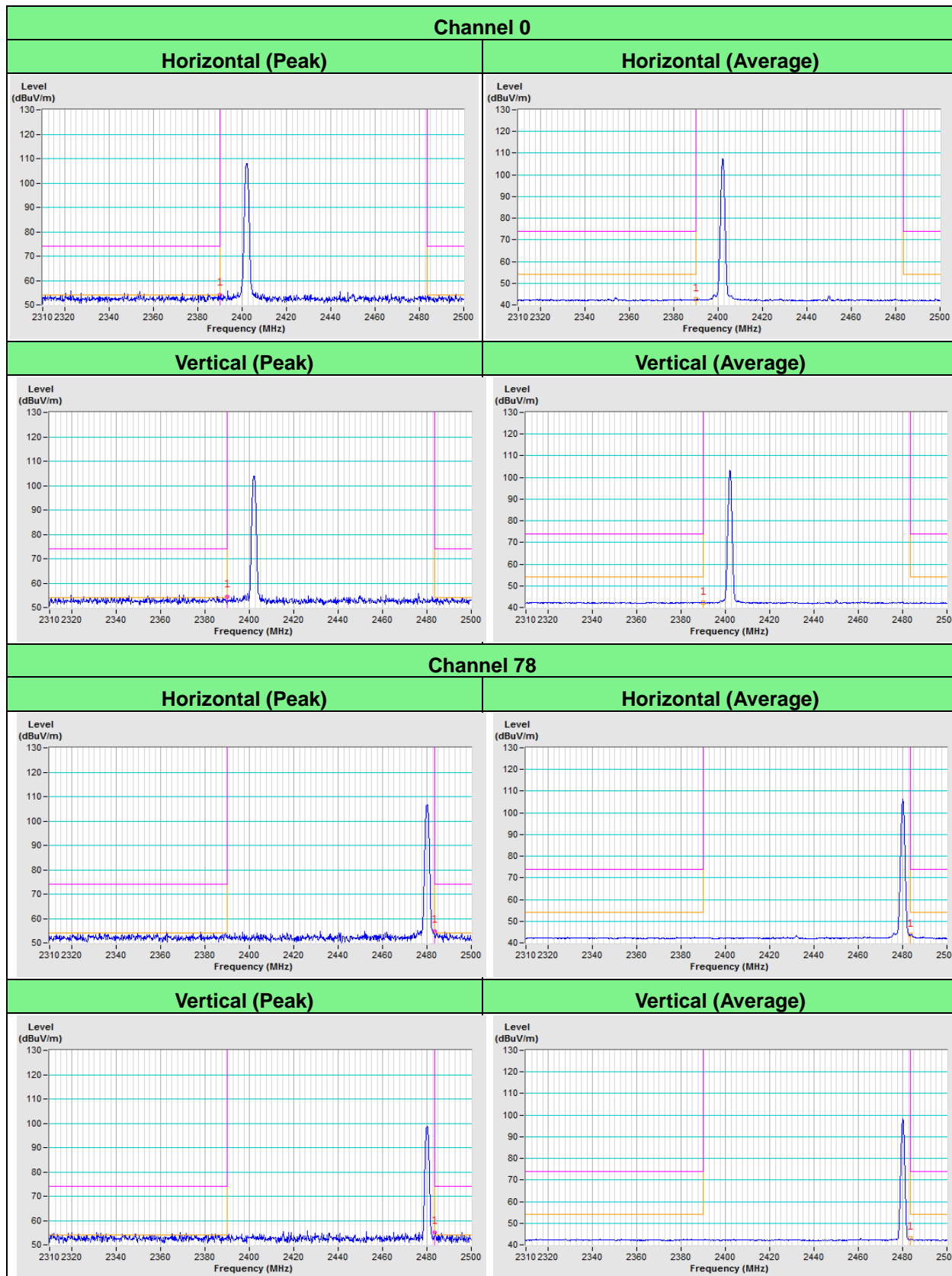

BT\_8DPSK

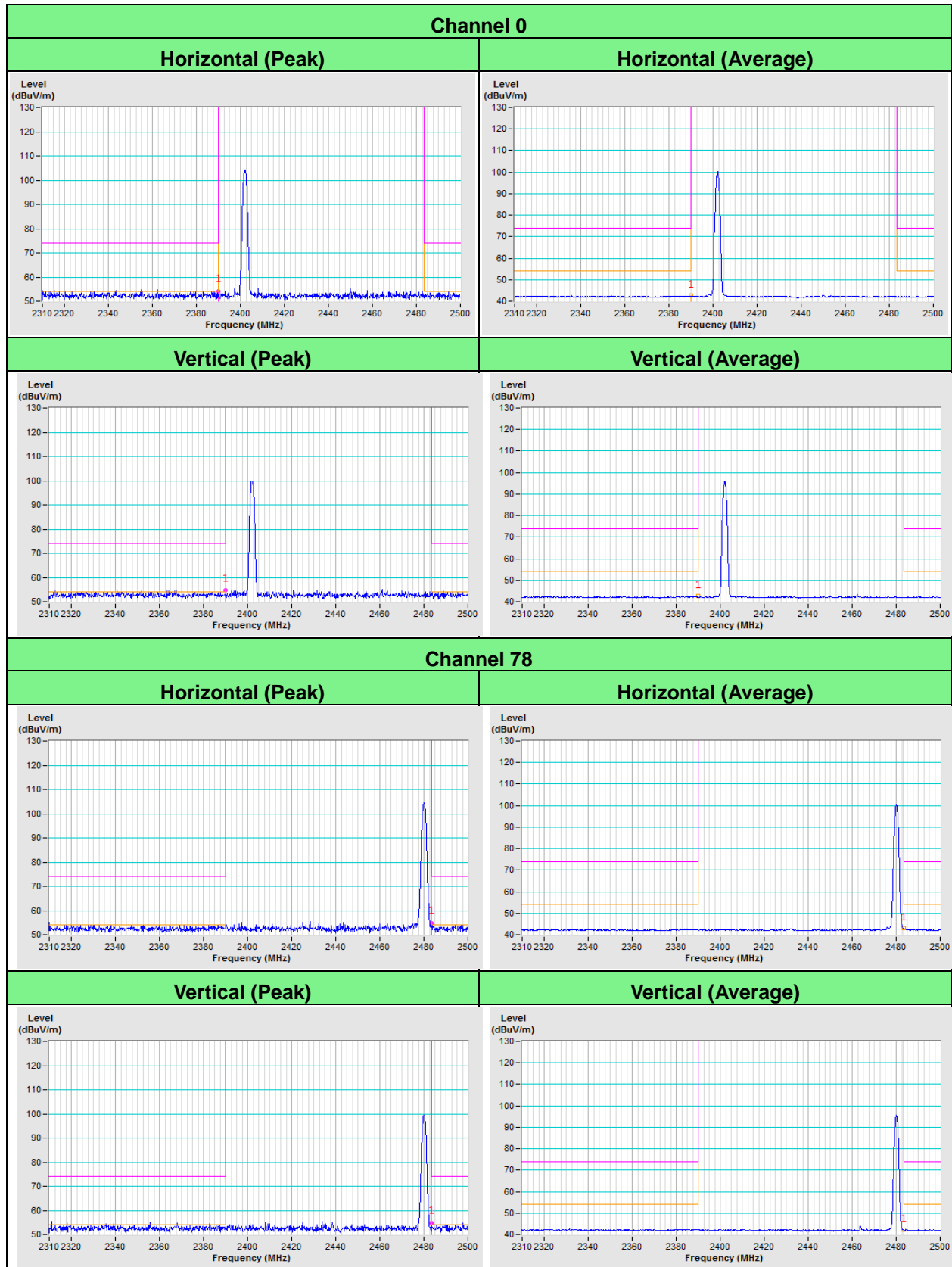

## Annex A.2 - Test Results (Mode 2)

BT\_GFSK

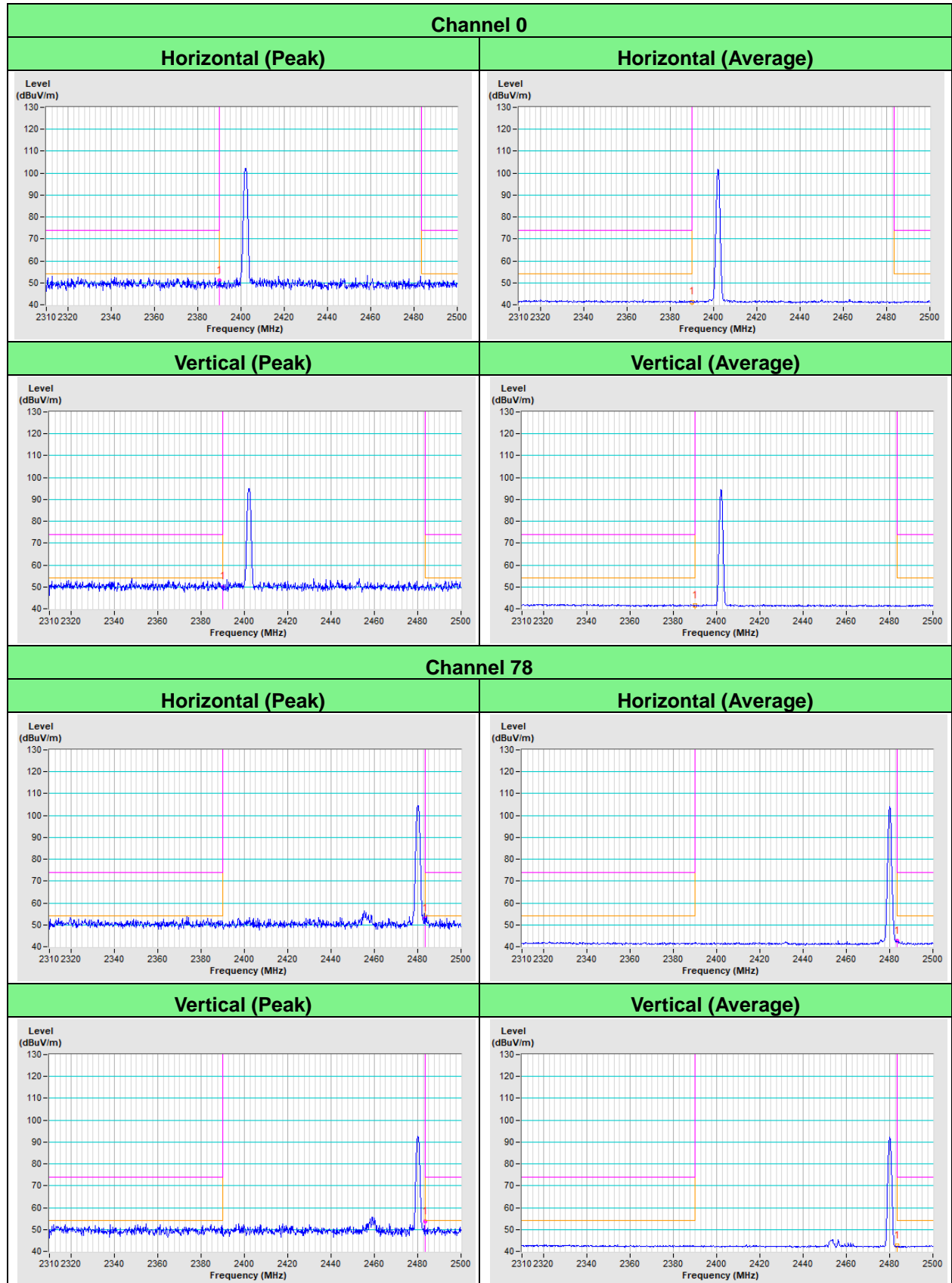

BT\_8DPSK

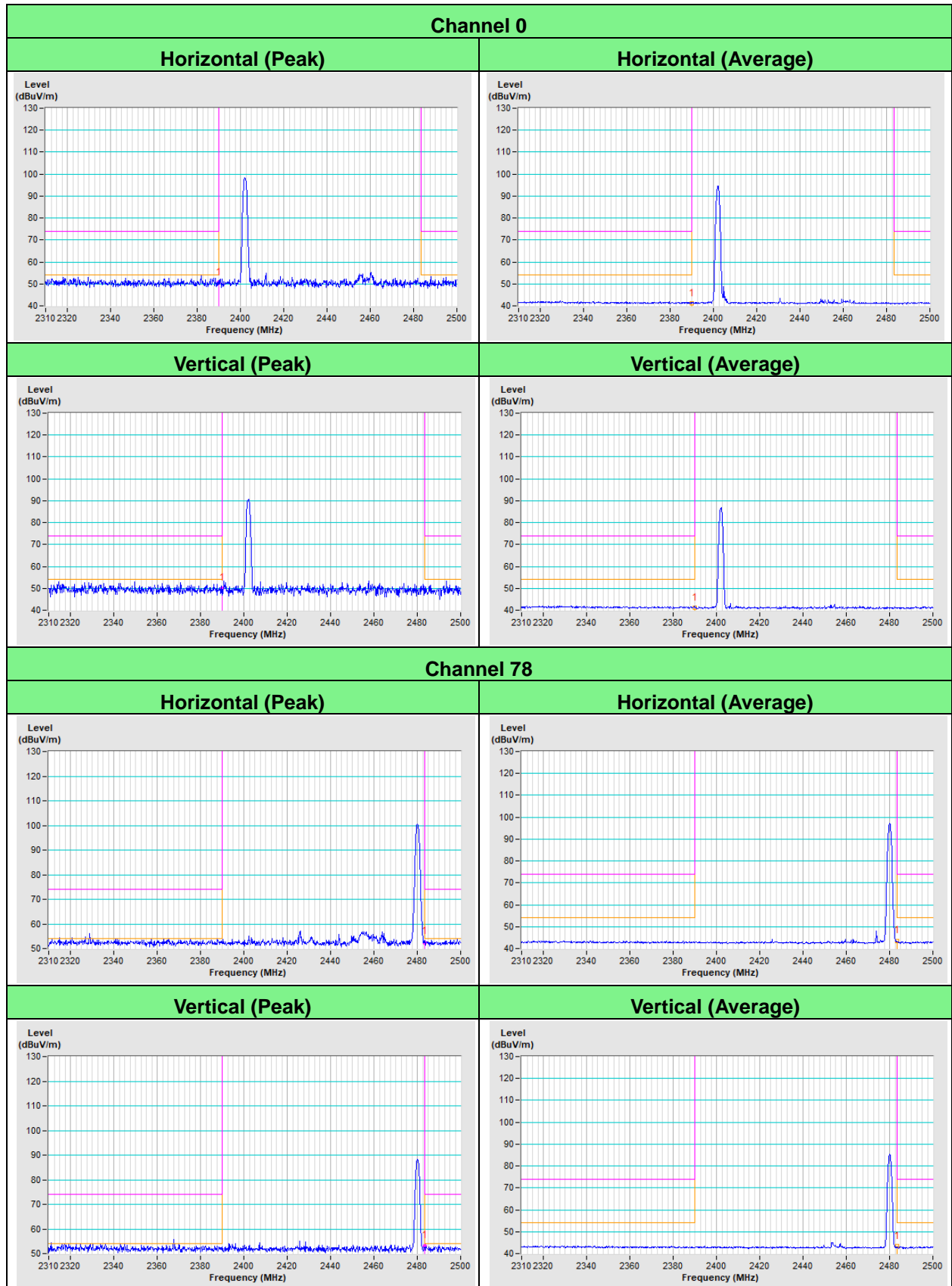

## Appendix – Information of the Testing Laboratories

We, Bureau Veritas Consumer Products Services (H.K.) Ltd., Taoyuan Branch, were founded in 1988 to provide our best service in EMC, Radio, Telecom and Safety consultation. Our laboratories are FCC recognized accredited test firms and accredited according to ISO/IEC 17025.

If you have any comments, please feel free to contact us at the following:

**Lin Kou EMC/RF Lab**

Tel: 886-2-26052180

Fax: 886-2-26051924

**Hsin Chu EMC/RF/Telecom Lab**

Tel: 886-3-6668565

Fax: 886-3-6668323

**Hwa Ya EMC/RF/Safety Lab**

Tel: 886-3-3183232

Fax: 886-3-3270892

**Email:** [service.adt@tw.bureauveritas.com](mailto:service.adt@tw.bureauveritas.com)

**Web Site:** [www.bureauveritas-adt.com](http://www.bureauveritas-adt.com)

The address and road map of all our labs can be found in our web site also.

--- END ---