



FCC RADIO TEST REPORT

FCC ID : TLZ-CM390SM
Equipment : IEEE 802.11a/b/g/n/ac WiFi with Bluetooth 5.0 Combo Stamp Module
Brand Name : AzureWave
Model Name : AW-CM390SM
Applicant : AzureWave Technologies, Inc.
8F., No.94, Baozhong Rd., Xindian Dist., New Taipei City 23144, Taiwan
Standard : 47 CFR FCC Part 15.247

The product was received on Mar. 12, 2020, and testing was started from Mar. 19, 2020 and completed on Apr. 29, 2020. We, SPORTON INTERNATIONAL INC. EMC & Wireless Communications Laboratory, would like to declare that the tested sample has been evaluated in accordance with the procedures given in ANSI C63.10-2013 and shown compliance with the applicable technical standards.

The report must not be used by the client to claim product certification, approval, or endorsement by TAF or any agency of government.

The test results in this report apply exclusively to the tested model / sample. Without written approval of SPORTON INTERNATIONAL INC. EMC & Wireless Communications Laboratory, the test report shall not be reproduced except in full.

Approved by: Cliff Chang

SPORTON INTERNATIONAL INC. EMC & Wireless Communications Laboratory
No. 52, Huaya 1st Rd., Guishan Dist., Taoyuan City, Taiwan (R.O.C.)



Table of Contents

History of this test report.....3

Summary of Test Result.....4

1 General Description5

1.1 Information.....5

1.2 Applicable Standards7

1.3 Testing Location Information7

1.4 Measurement Uncertainty7

2 Test Configuration of EUT8

2.1 Test Channel Mode8

2.2 The Worst Case Measurement Configuration9

2.3 EUT Operation during Test10

2.4 Accessories10

2.5 Support Equipment.....11

2.6 Test Setup Diagram12

3 Transmitter Test Result15

3.1 AC Power-line Conducted Emissions15

3.2 DTS Bandwidth.....17

3.3 Maximum Conducted Output Power18

3.4 Power Spectral Density21

3.5 Emissions in Non-restricted Frequency Bands23

3.6 Emissions in Restricted Frequency Bands.....24

4 Test Equipment and Calibration Data28

Appendix A. Test Results of AC Power-line Conducted Emissions

Appendix B. Test Results of DTS Bandwidth

Appendix C. Test Results of Maximum Conducted Output Power

Appendix D. Test Results of Power Spectral Density

Appendix E. Test Results of Emissions in Non-restricted Frequency Bands

Appendix F. Test Results of Emissions in Restricted Frequency Bands

Appendix G. Test Results of Radiated Emission Co-location

Appendix H. Test Photos

Photographs of EUT v01



Summary of Test Result

Report Clause	Ref Std. Clause	Test Items	Result (PASS/FAIL)	Remark
1.1.2	15.203	Antenna Requirement	PASS	-
3.1	15.207	AC Power-line Conducted Emissions	PASS	-
3.2	15.247(a)	DTS Bandwidth	PASS	-
3.3	15.247(b)	Maximum Conducted Output Power	PASS	-
3.4	15.247(e)	Power Spectral Density	PASS	-
3.5	15.247(d)	Emissions in Non-restricted Frequency Bands	PASS	-
3.6	15.247(d)	Emissions in Restricted Frequency Bands	PASS	-

Declaration of Conformity:

The test results with all measurement uncertainty excluded are presented in accordance with the regulation limits or requirements declared by manufacturers.

Comments and Explanations:

The declared of product specification for EUT presented in the report are provided by the manufacturer, and the manufacturer takes all the responsibilities for the accuracy of product specification.

Reviewed by: **Sam Chen**
Report Producer: **Sandy Chuang**



1 General Description

1.1 Information

1.1.1 RF General Information

Frequency Range (MHz)	Bluetooth Mode	Ch. Frequency (MHz)	Channel Number
2400-2483.5	LE	2402-2480	0-39 [40]

Band	Mode	BWch (MHz)	Nant
2.4G	BT-LE(1Mbps)	1	1

Note:

- ♦ Bluetooth LE uses a GFSK modulation.
- ♦ BWch is the nominal channel bandwidth.

1.1.2 Antenna Information

Ant.	Port	Brand	P/N	Antenna Type	Connector	Gain (dBi)		
						WLAN		Bluetooth
						2.4GHz	5GHz	
1	1	MAG.LAYERS	MSA-4008-25GC1-A1	PIFA	I-PEX	2.98	5.16	2.98

Note: The above information was declared by manufacturer.

For 2.4GHz function:

For IEEE 802.11b/g/n (1TX/1RX):

Only Port 1 can be used as transmitting/receiving antenna.

For 5GHz function:

For IEEE 802.11a/n/ac (1TX/1RX):

Only Port 1 can be used as transmitting/receiving antenna.

For Bluetooth function:

Only Port 1 can be used as transmitting/receiving antenna.

1.1.3 Mode Test Duty Cycle

Mode	DC	DCF(dB)	T(s)	VBW(Hz) ≥ 1/T
BT-LE(1Mbps)	0.626	2.03	391.25u	3k

Note:

- ♦ DC is Duty Cycle.
- ♦ DCF is Duty Cycle Factor.



1.1.4 EUT Operational Condition

EUT Power Type	From host system		
Function	<input checked="" type="checkbox"/> Point-to-multipoint	<input type="checkbox"/> Point-to-point	
Test Software Version	Version 7.45.173(r707987 CY WLTEST)FWID 01-6c82dde4		
Support Mode	<input checked="" type="checkbox"/> LE 1M PHY: 1 Mb/s		
	<input type="checkbox"/> LE Coded PHY (S=2): 500 Kb/s		
	<input type="checkbox"/> LE Coded PHY (S=8): 125 Kb/s		
	<input type="checkbox"/> LE 2M PHY: 2 Mb/s		

Note: The above information was declared by manufacturer.



1.2 Applicable Standards

According to the specifications of the manufacturer, the EUT must comply with the requirements of the following standards:

- ◆ 47 CFR FCC Part 15
- ◆ ANSI C63.10-2013

The following reference test guidance is not within the scope of accreditation of TAF.

- ◆ FCC KDB 558074 D01 v05r02
- ◆ FCC KDB 414788 D01 v01r01

1.3 Testing Location Information

Testing Location		
<input type="checkbox"/>	HWA YA	ADD : No. 52, Huaya 1st Rd., Guishan Dist., Taoyuan City, Taiwan (R.O.C.) TEL : 886-3-327-3456 FAX : 886-3-327-0973
<input checked="" type="checkbox"/>	JHUBEI	ADD : No.8, Lane 724, Bo-ai St., Jhubei City, HsinChu County 302, Taiwan, R.O.C. TEL : 886-3-656-9065 FAX : 886-3-656-9085

Test Condition	Test Site No.	Test Engineer	Test Environment	Test Date
RF Conducted	TH03-CB	Lucas Huangs	22-22.4°C / 45-47%	Mar. 25, 2020~ Mar. 31, 2020
Radiated<Below 1GHz>	03CH04-CB	Stim Sung	21.1-22.7°C / 45-47%	Mar. 25, 2020~ Apr. 29, 2020
Radiated<Above 1GHz>	03CH03-CB	Brian Sun	21.3-22.7°C / 47-49%	Mar. 19, 2020 Mar. 31, 2020
AC Conduction	CO01-CB	Max Lin	23~24°C / 59~60%	Apr. 16, 2020

Test site Designation No. TW0006 with FCC.

Test site registered number IC 4086D with Industry Canada.

1.4 Measurement Uncertainty

ISO/IEC 17025 requires that an estimate of the measurement uncertainties associated with the emissions test results be included in the report. The measurement uncertainties given below are based on a 95% confidence level (based on a coverage factor (k=2))

Test Items	Uncertainty	Remark
Conducted Emission (150kHz ~ 30MHz)	2.0 dB	Confidence levels of 95%
Radiated Emission (30MHz ~ 1,000MHz)	4.3 dB	Confidence levels of 95%
Radiated Emission (1GHz ~ 18GHz)	4.3 dB	Confidence levels of 95%
Radiated Emission (18GHz ~ 40GHz)	5.1 dB	Confidence levels of 95%
Conducted Emission	2.4 dB	Confidence levels of 95%
Output Power Measurement	1.5 dB	Confidence levels of 95%
Power Density Measurement	2.4 dB	Confidence levels of 95%
Bandwidth Measurement	2%	Confidence levels of 95%



2 Test Configuration of EUT

2.1 Test Channel Mode

Mode	Power Setting
BT-LE(1Mbps)	-
2402MHz	Default
2440MHz	Default
2480MHz	Default



2.2 The Worst Case Measurement Configuration

The Worst Case Mode for Following Conformance Tests	
Tests Item	AC power-line conducted emissions
Condition	AC power-line conducted measurement for line and neutral
Operating Mode	Normal Link
1	EUT + 2.4GHz + Bluetooth with Ant.
2	EUT + 5GHz + Bluetooth with Ant.
For operating mode 1 is the worst case and it was record in this test report.	

The Worst Case Mode for Following Conformance Tests	
Tests Item	DTS Bandwidth Maximum Conducted Output Power Power Spectral Density Emissions in Non-restricted Frequency Bands
Test Condition	Conducted measurement at transmit chains

The Worst Case Mode for Following Conformance Tests	
Tests Item	Emissions in Restricted Frequency Bands
Test Condition	Radiated measurement If EUT consist of multiple antenna assembly (multiple antenna are used in EUT regardless of spatial multiplexing MIMO configuration), the radiated test should be performed with highest antenna gain of each antenna type.
Operating Mode < 1GHz	Normal Link
1	EUT in Z axis + 2.4GHz + Bluetooth with Ant.
2	EUT in Z axis + 5GHz + Bluetooth with Ant.
For operating mode 2 is the worst case and it was record in this test report.	
Operating Mode > 1GHz	CTX
The EUT was performed at X axis, Y axis and Z axis position test, and the worst case was found at X axis So the measurement will follow this same test configuration.	
1	EUT in X axis + Ant.



The Worst Case Mode for Following Conformance Tests	
Tests Item	Simultaneous Transmission Analysis - Radiated Emission Co-location
Test Condition	Radiated measurement
Operating Mode	Normal Link
1	EUT in Z axis: Bluetooth+WLAN 2.4GHz
2	EUT in Z axis: Bluetooth+WLAN 5GHz
For operating mode 1 was the worst case and it was record in this test report.	
Refer to Appendix G for Radiated Emission Co-location.	

The Worst Case Mode for Following Conformance Tests	
Tests Item	Simultaneous Transmission Analysis - Co-location RF Exposure Evaluation
Operating Mode	
1	Bluetooth+WLAN 2.4GHz
2	Bluetooth+WLAN 5GHz
Refer to Sporton Test Report No.: FA030609 for Co-location RF Exposure Evaluation.	

2.3 EUT Operation during Test

For CTX Mode:

The EUT was programmed to be in continuously transmitting mode.

For Normal Link:

During the test, the EUT operation to normal function.

2.4 Accessories

N/A



2.5 Support Equipment

For AC Conduction:

Support Equipment				
No.	Equipment	Brand Name	Model Name	FCC ID
A	Fixture	AzureWave	CK77 94V-0	N/A
B	Notebook	DELL	E6430	N/A
C	Earphone	e-Power	S90W	N/A
D	Mouse	HP	FM100	N/A
E	Smart phone	Samsung	Galaxy J2	A3LSMJ200F
F	AP	ASUS	RP-N53	MSQ-RPN53

For Radiated (below 1GHz):

Support Equipment				
No.	Equipment	Brand Name	Model Name	FCC ID
A	Notebook	DELL	E4300	N/A
B	WLAN AP	ASUS	RT-AX88U	MSQ-RTAXHP00
C	Smart phone	Samsung	Galaxy J2	A3LSMJ200F
D	Fixture	AzureWave	CK77 94V-0	N/A
E	Earphone	e-Power	S90W	N/A
F	Mouse	HP	FM100	N/A

For Radiated (above 1GHz):

Support Equipment				
No.	Equipment	Brand Name	Model Name	FCC ID
A	Notebook	DELL	E4300	N/A
B	Fixture	AzureWave	CK77 94V-0	N/A

For RF Conducted:

Support Equipment				
No.	Equipment	Brand Name	Model Name	FCC ID
A	Notebook	DELL	E4300	N/A
B	Fixture	AzureWave	CK77 94V-0	N/A

2.6 Test Setup Diagram

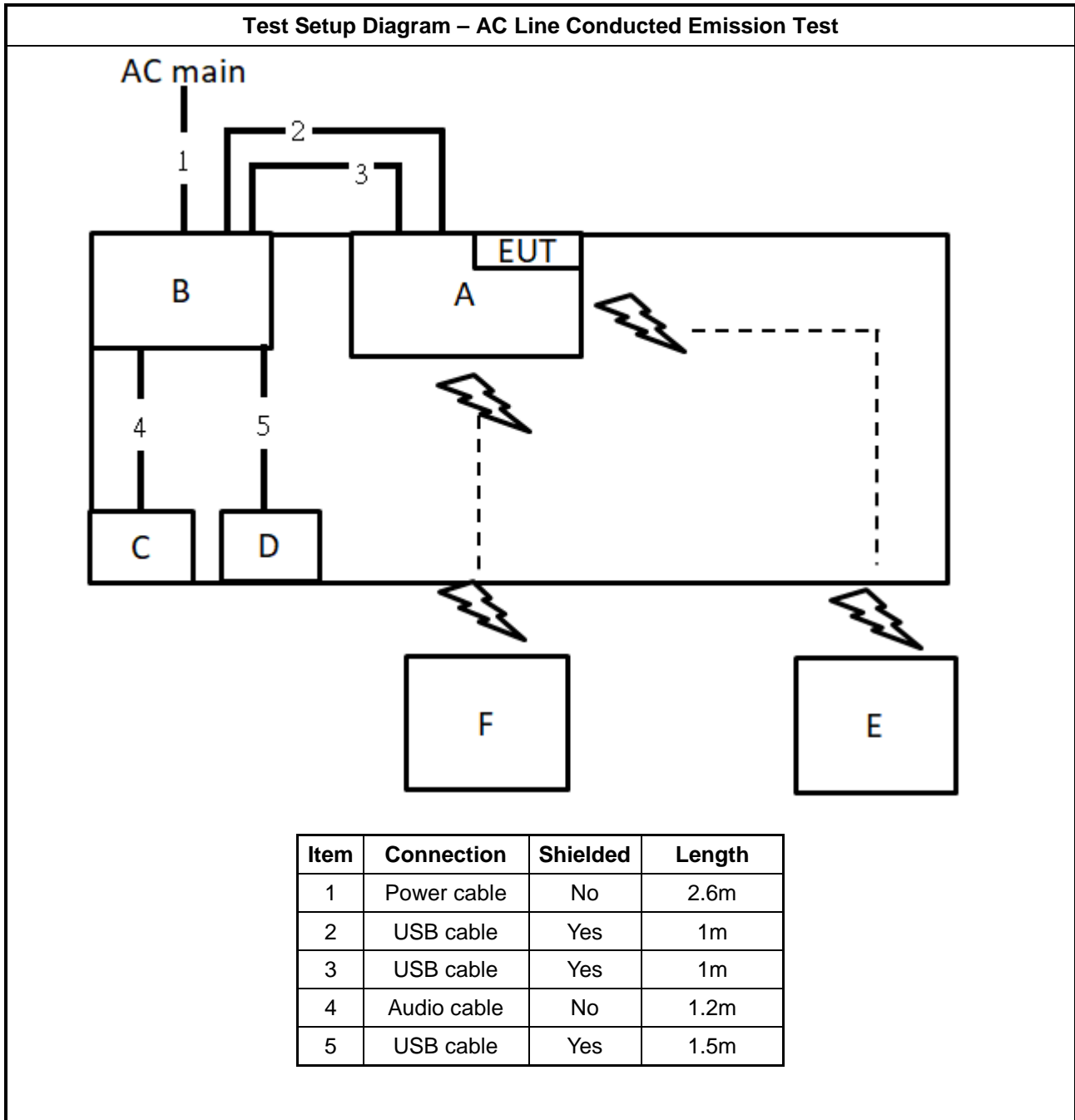

Test Setup Diagram - Radiated Test < 1GHz

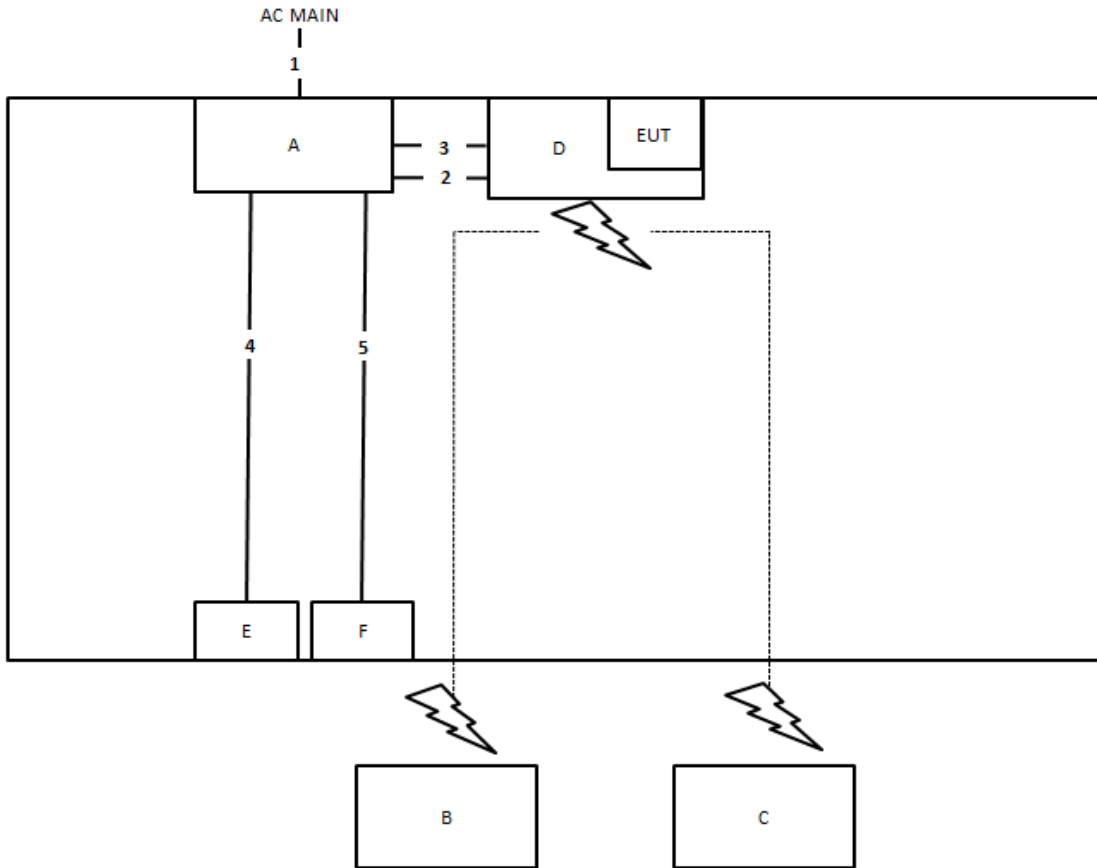

Item	Connection	Shielded	Length
1	Power cable	No	2.6m
2	USB cable	Yes	1m
3	USB cable	Yes	1m
4	Audio cable	No	1.2m
5	USB cable	Yes	1.5m

Test Setup Diagram - Radiated Test > 1GHz

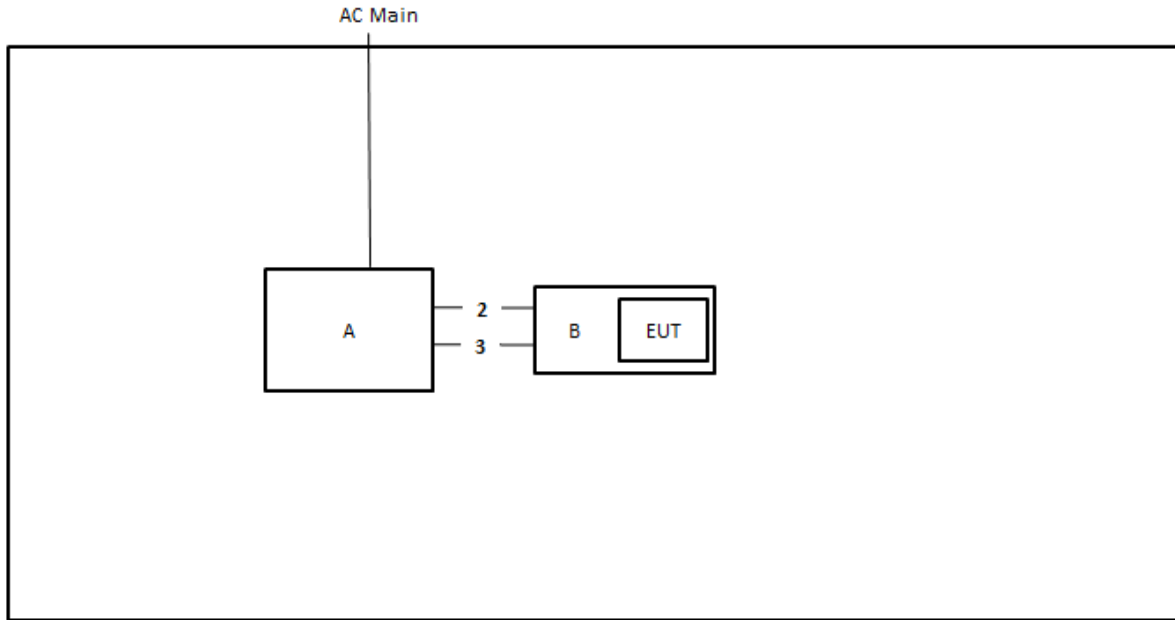

Item	Connection	Shielded	Length
1	USB cable	No	1m
2	USB cable	No	1m



3 Transmitter Test Result

3.1 AC Power-line Conducted Emissions

3.1.1 AC Power-line Conducted Emissions Limit

AC Power-line Conducted Emissions Limit		
Frequency Emission (MHz)	Quasi-Peak	Average
0.15-0.5	66 - 56 *	56 - 46 *
0.5-5	56	46
5-30	60	50

Note 1: * Decreases with the logarithm of the frequency.

3.1.2 Measuring Instruments

Refer a test equipment and calibration data table in this test report.

3.1.3 Test Procedures

Test Method
▪ Refer as ANSI C63.10-2013, clause 6.2 for AC power-line conducted emissions.

3.1.4 Test Setup

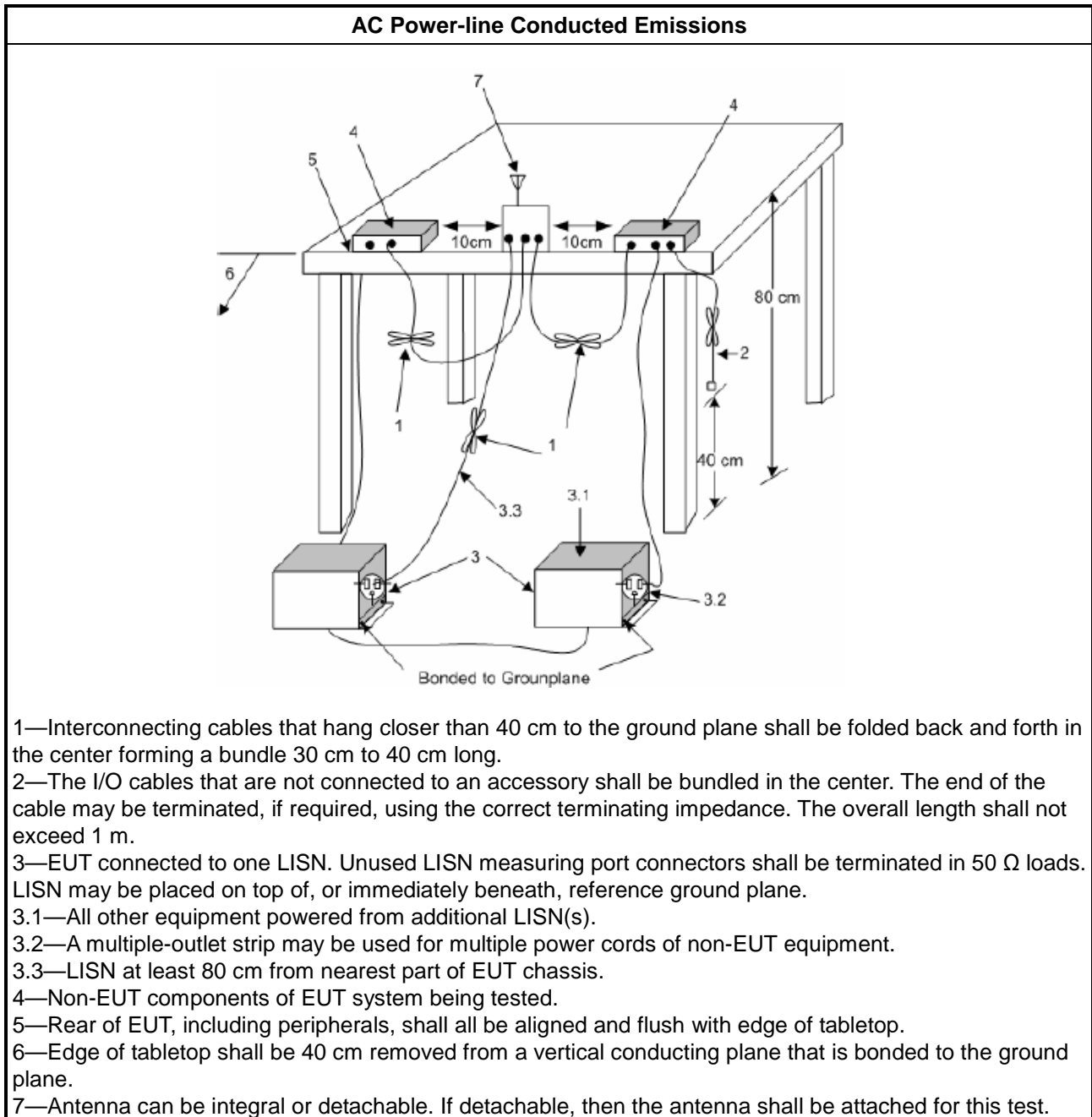

3.1.5 Test Result of AC Power-line Conducted Emissions

Refer as Appendix A

3.2 DTS Bandwidth

3.2.1 6dB Bandwidth Limit

6dB Bandwidth Limit
Systems using digital modulation techniques:
<ul style="list-style-type: none"> ▪ 6 dB bandwidth \geq 500 kHz.

3.2.2 Measuring Instruments

Refer a test equipment and calibration data table in this test report.

3.2.3 Test Procedures

Test Method
<ul style="list-style-type: none"> ▪ For the emission bandwidth shall be measured using one of the options below:
<input checked="" type="checkbox"/> Refer as FCC KDB 558074, clause 8.2 & C63.10 clause 11.8.1 Option 1 for 6 dB bandwidth measurement.
<input type="checkbox"/> Refer as FCC KDB 558074, clause 8.2 & C63.10 clause 11.8.2 Option 2 for 6 dB bandwidth measurement.
<input type="checkbox"/> Refer as ANSI C63.10, clause 6.9.1 for occupied bandwidth testing.

3.2.4 Test Setup

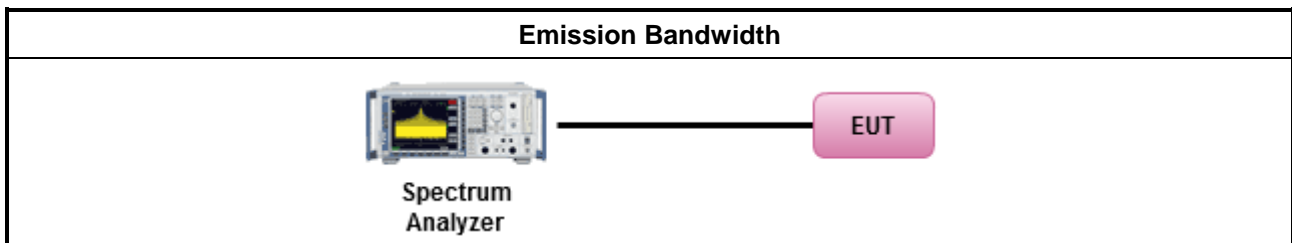

3.2.5 Test Result of Emission Bandwidth

Refer as Appendix B



3.3 Maximum Conducted Output Power

3.3.1 Maximum Conducted Output Power Limit

Maximum Conducted Output Power Limit	
	<ul style="list-style-type: none"> ▪ If $G_{TX} \leq 6$ dBi, then $P_{Out} \leq 30$ dBm (1 W)
	<ul style="list-style-type: none"> ▪ Point-to-multipoint systems (P2M): If $G_{TX} > 6$ dBi, then $P_{Out} = 30 - (G_{TX} - 6)$ dBm
	<ul style="list-style-type: none"> ▪ Point-to-point systems (P2P): If $G_{TX} > 6$ dBi, then $P_{Out} = 30 - (G_{TX} - 6)/3$ dBm
	<ul style="list-style-type: none"> ▪ Smart antenna system (SAS): <ul style="list-style-type: none"> - Single beam: If $G_{TX} > 6$ dBi, then $P_{Out} = 30 - (G_{TX} - 6)/3$ dBm - Overlap beam: If $G_{TX} > 6$ dBi, then $P_{Out} = 30 - (G_{TX} - 6)/3$ dBm - Aggregate power on all beams: If $G_{TX} > 6$ dBi, then $P_{Out} = 30 - (G_{TX} - 6)/3 + 8$ dB dBm
<p>P_{Out} = maximum peak conducted output power or maximum conducted output power in dBm, G_{TX} = the maximum transmitting antenna directional gain in dBi.</p>	

3.3.2 Measuring Instruments

Refer a test equipment and calibration data table in this test report.



3.3.3 Test Procedures

Test Method	
<ul style="list-style-type: none"> ▪ Maximum Peak Conducted Output Power 	
<input type="checkbox"/>	Refer as FCC KDB 558074, clause 8.3.1.1 & C63.10 clause 11.9.1.1 (RBW ≥ EBW method).
<input type="checkbox"/>	Refer as FCC KDB 558074, clause 8.3.1.3 & C63.10 clause 11.9.1.3 (peak power meter).
<ul style="list-style-type: none"> ▪ Maximum Conducted Output Power 	
[duty cycle ≥ 98% or external video / power trigger]	
<input type="checkbox"/>	Refer as FCC KDB 558074, clause 8.3.2.2 & C63.10 clause 11.9.2.2.2 Method AVGSA-1.
<input type="checkbox"/>	Refer as FCC KDB 558074, clause 8.3.2.2 & C63.10 clause 11.9.2.2.3 Method AVGSA-1A. (alternative)
duty cycle < 98% and average over on/off periods with duty factor	
<input type="checkbox"/>	Refer as FCC KDB 558074, clause 8.3.2.2 & C63.10 clause 11.9.2.2.4 Method AVGSA-2.
<input type="checkbox"/>	Refer as FCC KDB 558074, clause 8.3.2.2 & C63.10 clause 11.9.2.2.5 Method AVGSA-2A (alternative)
<input type="checkbox"/>	Refer as FCC KDB 558074, clause 8.3.2.2 & C63.10 clause 11.9.2.2.6 Method AVGSA-3
<input type="checkbox"/>	Refer as FCC KDB 558074, clause 8.3.2.2 & C63.10 clause 11.9.2.2.7 Method AVGSA-3A (alternative)
Measurement using a power meter (PM)	
<input type="checkbox"/>	Refer as FCC KDB 558074, clause 8.3.2.3 & C63.10 clause 11.9.2.3.1 Method AVGPM (using an RF average power meter).
<input checked="" type="checkbox"/>	Refer as FCC KDB 558074, clause 8.3.2.3 & C63.10 clause 11.9.2.3.2 Method AVGPM-G (using an gate RF average power meter).
<ul style="list-style-type: none"> ▪ For conducted measurement. 	
<ul style="list-style-type: none"> ▪ If the EUT supports multiple transmit chains using options given below: Refer as FCC KDB 662911, In-band power measurements. Using the measure-and-sum approach, measured all transmit ports individually. Sum the power (in linear power units e.g., mW) of all ports for each individual sample and save them. 	
<ul style="list-style-type: none"> ▪ If multiple transmit chains, EIRP calculation could be following as methods: $P_{total} = P_1 + P_2 + \dots + P_n$ (calculated in linear unit [mW] and transfer to log unit [dBm]) $EIRP_{total} = P_{total} + DG$ 	

3.3.4 Test Setup

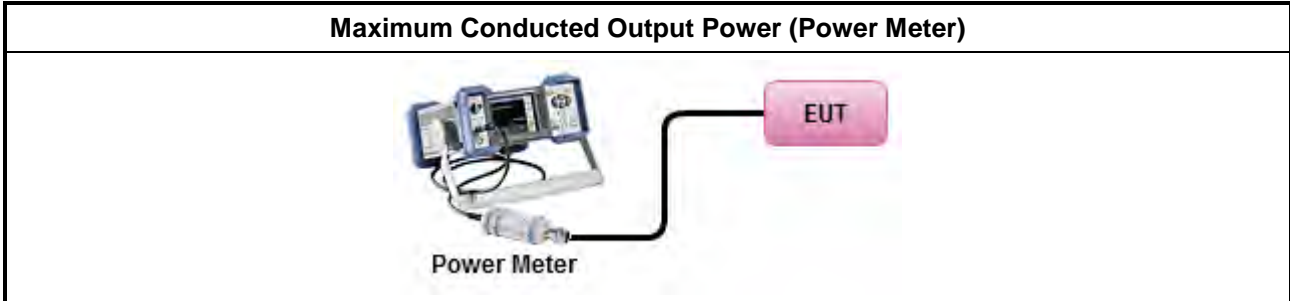

3.3.5 Test Result of Maximum Conducted Output Power

Refer as Appendix C



3.4 Power Spectral Density

3.4.1 Power Spectral Density Limit

Power Spectral Density Limit
<ul style="list-style-type: none"> Power Spectral Density (PSD) ≤ 8 dBm/3kHz

3.4.2 Measuring Instruments

Refer a test equipment and calibration data table in this test report.

3.4.3 Test Procedures

Test Method
<ul style="list-style-type: none"> Peak power spectral density procedures that the same method as used to determine the conducted output power. If maximum peak conducted output power was measured to demonstrate compliance to the output power limit, then the peak PSD procedure below (Method PKPSD) shall be used. If maximum conducted output power was measured to demonstrate compliance to the output power limit, then one of the average PSD procedures shall be used, as applicable based on the following criteria (the peak PSD procedure is also an acceptable option).
<input checked="" type="checkbox"/> Refer as FCC KDB 558074, clause 8.4 & C63.10 clause 11.10 Method Max. PSD. [duty cycle ≥ 98% or external video / power trigger]
<ul style="list-style-type: none"> For conducted measurement.
<ul style="list-style-type: none"> If The EUT supports multiple transmit chains using options given below: <ul style="list-style-type: none"> <input type="checkbox"/> Option 1: Measure and sum the spectra across the outputs. Refer as FCC KDB 662911, In-band power spectral density (PSD). Sample all transmit ports simultaneously using a spectrum analyzer for each transmit port. Where the trace bin-by-bin of each transmit port summing can be performed. (i.e., in the first spectral bin of output 1 is summed with that in the first spectral bin of output 2 and that from the first spectral bin of output 3, and so on up to the NTX output to obtain the value for the first frequency bin of the summed spectrum.). Add up the amplitude (power) values for the different transmit chains and use this as the new data trace. <input type="checkbox"/> Option 2: Measure and sum spectral maxima across the outputs. With this technique, spectra are measured at each output of the device at the required resolution bandwidth. The maximum value (peak) of each spectrum is determined. These maximum values are then summed mathematically in linear power units across the outputs. These operations shall be performed separately over frequency spans that have different out-of-band or spurious emission limits, <input type="checkbox"/> Option 3: Measure and add 10 log(N) dB, where N is the number of transmit chains. Refer as FCC KDB 662911, In-band power spectral density (PSD). Performed at each transmit chains and each transmit chains shall be compared with the limit have been reduced with 10 log(N). Or each transmit chains shall be add 10 log(N) to compared with the limit.

3.4.4 Test Setup

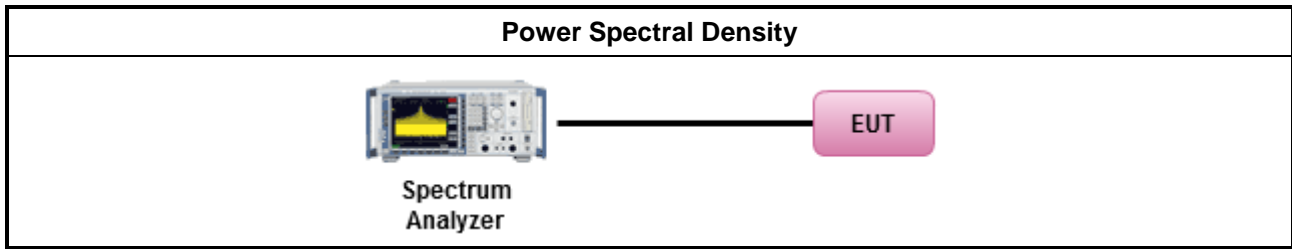

3.4.5 Test Result of Power Spectral Density

Refer as Appendix D

3.5 Emissions in Non-restricted Frequency Bands

3.5.1 Emissions in Non-restricted Frequency Bands Limit

Un-restricted Band Emissions Limit	
RF output power procedure	Limit (dBc)
Peak output power procedure	20
Average output power procedure	30

Note 1: If the peak output power procedure is used to measure the fundamental emission power to demonstrate compliance to requirements, then the peak conducted output power measured within any 100 kHz outside the authorized frequency band shall be attenuated by at least 20 dB relative to the maximum measured in-band peak PSD level.

Note 2: If the average output power procedure is used to measure the fundamental emission power to demonstrate compliance to requirements, then the power in any 100 kHz outside of the authorized frequency band shall be attenuated by at least 30 dB relative to the maximum measured in-band average PSD level.

3.5.2 Measuring Instruments

Refer a test equipment and calibration data table in this test report.

3.5.3 Test Procedures

Test Method
<ul style="list-style-type: none"> Refer as FCC KDB 558074, clause 8.5 for unwanted emissions into non-restricted bands.

3.5.4 Test Setup

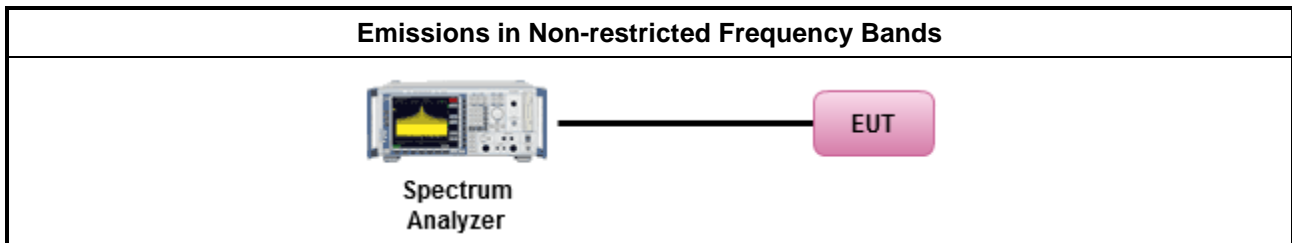

3.5.5 Test Result of Emissions in Non-restricted Frequency Bands

Refer as Appendix E



3.6 Emissions in Restricted Frequency Bands

3.6.1 Emissions in Restricted Frequency Bands Limit

Restricted Band Emissions Limit			
Frequency Range (MHz)	Field Strength (uV/m)	Field Strength (dBuV/m)	Measure Distance (m)
0.009~0.490	2400/F(kHz)	48.5 - 13.8	300
0.490~1.705	24000/F(kHz)	33.8 - 23	30
1.705~30.0	30	29	30
30~88	100	40	3
88~216	150	43.5	3
216~960	200	46	3
Above 960	500	54	3

Note 1: Test distance for frequencies at or above 30 MHz, measurements may be performed at a distance other than the limit distance provided they are not performed in the near field and the emissions to be measured can be detected by the measurement equipment. When performing measurements at a distance other than that specified, the results shall be extrapolated to the specified distance using an extrapolation factor of 20 dB/decade (inverse of linear distance for field-strength measurements, inverse of linear distance-squared for power-density measurements).

Note 2: Test distance for frequencies at below 30 MHz, measurements may be performed at a distance closer than the EUT limit distance; however, an attempt should be made to avoid making measurements in the near field. When performing measurements below 30 MHz at a closer distance than the limit distance, the results shall be extrapolated to the specified distance by either making measurements at a minimum of two or more distances on at least one radial to determine the proper extrapolation factor or by using the square of an inverse linear distance extrapolation factor (40 dB / decade). The test report shall specify the extrapolation method used to determine compliance of the EUT.

Note 3: Using the distance of 1m during the test for above 18 GHz, and the test value to correct for the distance factor at 3m.

3.6.2 Measuring Instruments

Refer a test equipment and calibration data table in this test report.



3.6.3 Test Procedures

Test Method	
<ul style="list-style-type: none"> ▪ The average emission levels shall be measured in [duty cycle \geq 98 or duty factor]. 	
<ul style="list-style-type: none"> ▪ Refer as ANSI C63.10, clause 6.10.3 band-edge testing shall be performed at the lowest frequency channel and highest frequency channel within the allowed operating band. 	
<ul style="list-style-type: none"> ▪ For the transmitter unwanted emissions shall be measured using following options below: 	
	<ul style="list-style-type: none"> ▪ Refer as FCC KDB 558074, clause 8.6 for unwanted emissions into restricted bands.
	<input type="checkbox"/> Refer as FCC KDB 558074, clause 8.6 & C63.10 clause 11.12.2.5.1(trace averaging for duty cycle \geq 98%).
	<input type="checkbox"/> Refer as FCC KDB 558074, clause 8.6 & C63.10 clause 11.12.2.5.2(trace averaging + duty factor).
	<input checked="" type="checkbox"/> Refer as FCC KDB 558074, clause 8.6 & C63.10 clause 11.12.2.5.3(Reduced VBW \geq 1/T).
	<input type="checkbox"/> Refer as ANSI C63.10, clause 11.12.2.5.3 (Reduced VBW). VBW \geq 1/T, where T is pulse time.
	<input type="checkbox"/> Refer as ANSI C63.10, clause 7.5 average value of pulsed emissions.
	<input checked="" type="checkbox"/> Refer as FCC KDB 558074, clause 8.6 & C63.10 clause 11.12.2.4 measurement procedure peak limit.
<ul style="list-style-type: none"> ▪ For the transmitter band-edge emissions shall be measured using following options below: 	
	<ul style="list-style-type: none"> ▪ Refer as FCC KDB 558074 clause 8.7 & c63.10 clause 11.13.1, When the performing peak or average radiated measurements, emissions within 2 MHz of the authorized band edge may be measured using the marker-delta method described below.
	<ul style="list-style-type: none"> ▪ Refer as FCC KDB 558074, clause 8.7 (ANSI C63.10, clause 6.10.6) for marker-delta method for band-edge measurements.
	<ul style="list-style-type: none"> ▪ Refer as FCC KDB 558074, clause 8.7 for narrower resolution bandwidth (100kHz) using the band power and summing the spectral levels (i.e., 1 MHz).
	<ul style="list-style-type: none"> ▪ For conducted unwanted emissions into restricted bands (absolute emission limits). Devices with multiple transmit chains using options given below: (1) Measure and sum the spectra across the outputs or (2) Measure and add 10 log(N) dB
	<ul style="list-style-type: none"> ▪ For FCC KDB 662911 The methodology described here may overestimate array gain, thereby resulting in apparent failures to satisfy the out-of-band limits even if the device is actually compliant. In such cases, compliance may be demonstrated by performing radiated tests around the frequencies at which the apparent failures occurred.

3.6.4 Test Setup

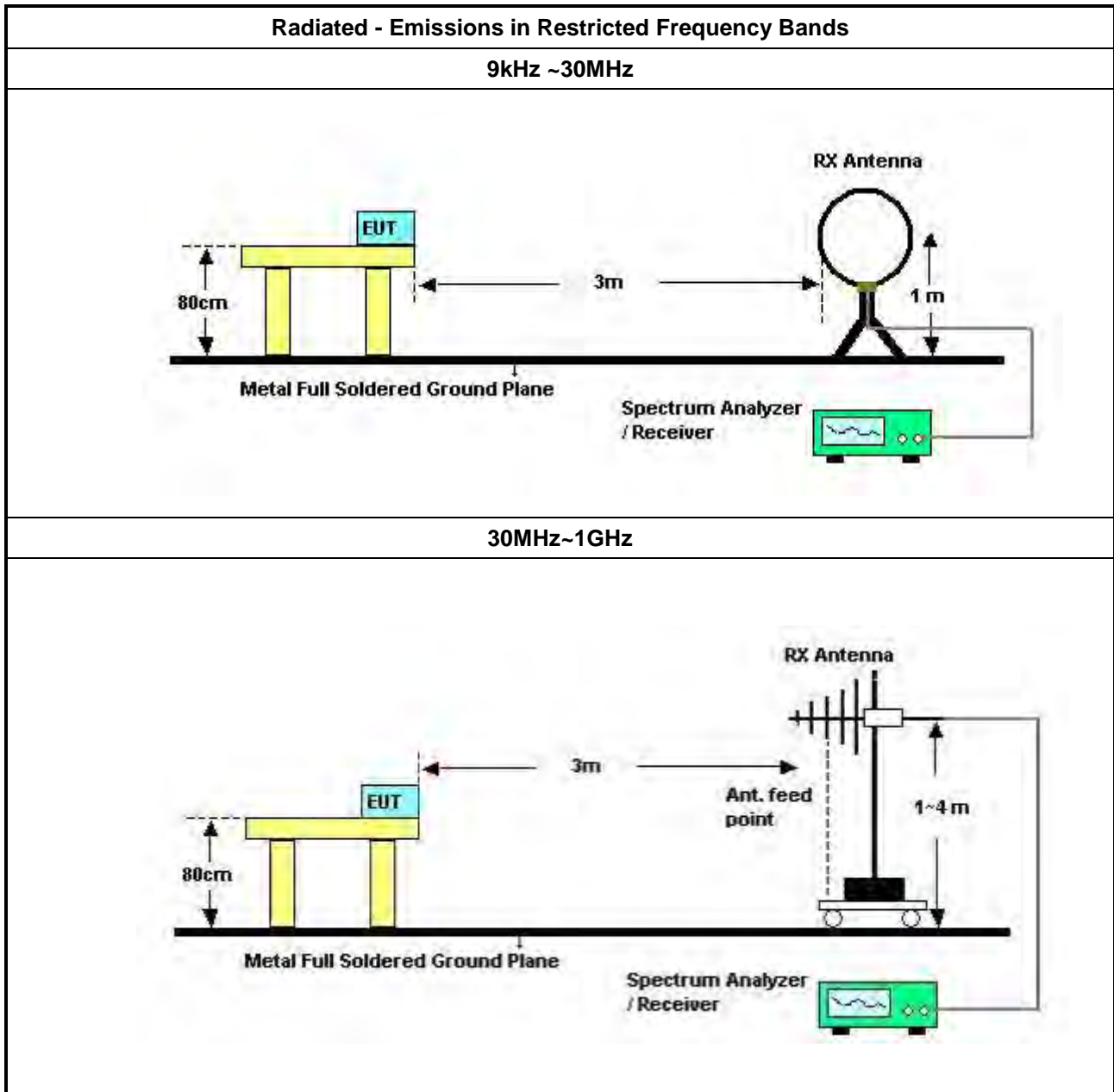

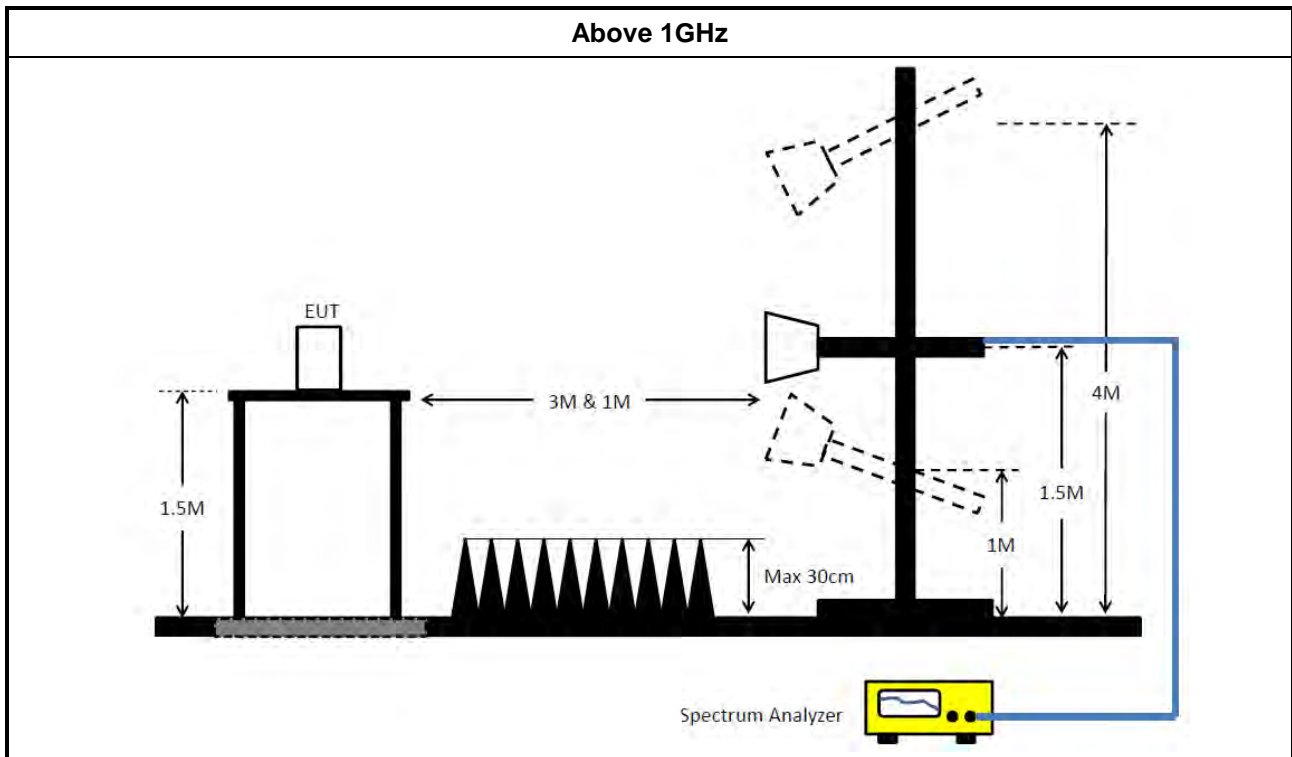

3.6.5 Measurement Results Calculation

The measured Level is calculated using:

Corrected Reading: Antenna Factor + Cable Loss + Read Level - Preamp Factor = Level.

3.6.6 Emissions in Restricted Frequency Bands (Below 30MHz)

There is a comparison data of both open-field test site and alternative test site - semi-Anechoic chamber according to KDB414788 Radiated Test Site, and the result came out very similar.

All amplitude of spurious emissions that are attenuated by more than 20 dB below the permissible value has no need to be reported.

The radiated emissions were investigated from 9 kHz or the lowest frequency generated within the device, up to the 10 harmonic or 40 GHz, whichever is appropriate.

3.6.7 Test Result of Emissions in Restricted Frequency Bands

Refer as Appendix F



4 Test Equipment and Calibration Data

Instrument	Manufacturer	Model No.	Serial No.	Characteristics	Calibration Date	Calibration Due Date	Remark
EMI Receiver	Agilent	N9038A	My52260123	9kHz ~ 8.45GHz	Feb. 26, 2020	Feb. 25, 2021	Conduction (CO01-CB)
LISN	F.C.C.	FCC-LISN-50-16-2	04083	150kHz ~ 100MHz	Dec. 25, 2019	Dec. 24, 2020	Conduction (CO01-CB)
LISN	Schwarzbeck	NSLK 8127	8127647	9kHz ~ 30MHz	Feb. 25, 2020	Feb. 24, 2021	Conduction (CO01-CB)
COND Cable	Woken	Cable	Low cable-CO01	9kHz ~ 30MHz	May 21, 2019	May 20, 2020	Conduction (CO01-CB)
Software	Audix	E3	6.120210n	-	N.C.R.	N.C.R.	Conduction (CO01-CB)
Loop Antenna	Teseq	HLA 6120	24155	9kHz - 30 MHz	Mar. 29, 2019	Mar. 28, 2020	Radiation (03CH04-CB)
Loop Antenna	Teseq	HLA 6120	24155	9kHz - 30 MHz	Apr. 13, 2020	Apr. 12, 2021	Radiation (03CH04-CB)
BILOG ANTENNA with 6 dB attenuator	Schaffner & EMC I	CBL6112B & N-6-06	22021&AT-N06 07	30MHz ~ 1GHz	Oct. 12, 2019	Oct. 11, 2020	Radiation (03CH04-CB)
Pre-Amplifier	Agilent	310N	187291	0.1MHz ~ 1GHz	Mar. 19, 2020	Mar. 18, 2021	Radiation (03CH04-CB)
Spectrum Analyzer	R&S	FSP40	100142	9kHz~40GHz	Dec. 18, 2019	Dec. 17, 2020	Radiation (03CH04-CB)
EMI Test Receiver	R&S	ESCS	826547/017	9kHz ~ 2.75GHz	May 15, 2019	May 14, 2020	Radiation (03CH04-CB)
RF Cable-low	Woken	RG402	Low Cable-03+22	30MHz ~ 1GHz	Oct. 07, 2019	Oct. 06, 2020	Radiation (03CH04-CB)
Horn Antenna	ETS · Lindgren	3115	6821	750MHz~18GHz	Jan. 20, 2020	Jan. 19, 2021	Radiation (03CH03-CB)
Horn Antenna	Schwarzbeck	BBHA 9170	BBHA9170252	15GHz ~ 40GHz	Jun. 27, 2019	Jun. 26, 2020	Radiation (03CH03-CB)
Pre-Amplifier	Agilent	8449B	3008A02097	1GHz ~ 26.5GHz	Dec. 19, 2019	Dec. 18, 2020	Radiation (03CH03-CB)
Pre-Amplifier	MITEQ	TTA1840-35-H G	1864479	18GHz ~ 40GHz	Jul. 03, 2019	Jul. 02, 2020	Radiation (03CH03-CB)
Spectrum Analyzer	R&S	FSP40	100019	9kHz ~ 40GHz	Jun. 19, 2019	Jun. 18, 2020	Radiation (03CH03-CB)
RF Cable-high	Woken	RG402	High Cable-20+27	1GHz ~ 18GHz	Oct. 07, 2019	Oct. 06, 2020	Radiation (03CH03-CB)



Instrument	Manufacturer	Model No.	Serial No.	Characteristics	Calibration Date	Calibration Due Date	Remark
RF Cable-high	Woken	RG402	High Cable-27	1GHz ~ 18GHz	Oct. 07, 2019	Oct. 06, 2020	Radiation (03CH03-CB)
RF Cable-high	Woken	RG402	High Cable-40G#1	18GHz ~ 40 GHz	Jul. 24, 2019	Jul. 23, 2020	Radiation (03CH03-CB)
RF Cable-high	Woken	RG402	High Cable-40G#2	18GHz ~ 40 GHz	Jul. 24, 2019	Jul. 23, 2020	Radiation (03CH03-CB)
Spectrum analyzer	R&S	FSV40	101028	9kHz~40GHz	Nov. 01, 2019	Oct. 31, 2020	Conducted (TH03-CB)
Power Sensor	Anritsu	MA2411B	1726195	300MHz~40GHz	Aug. 13, 2019	Aug. 12, 2020	Conducted (TH03-CB)
Power Meter	Anritsu	ML2495A	1035008	300MHz~40GHz	Aug. 13, 2019	Aug. 12, 2020	Conducted (TH03-CB)
RF Cable-high	Woken	RG402	High Cable-11	1 GHz – 26.5 GHz	Oct. 07, 2019	Oct. 06, 2020	Conducted (TH03-CB)
RF Cable-high	Woken	RG402	High Cable-12	1 GHz – 26.5 GHz	Oct. 07, 2019	Oct. 06, 2020	Conducted (TH03-CB)
RF Cable-high	Woken	RG402	High Cable-13	1 GHz – 26.5 GHz	Oct. 07, 2019	Oct. 06, 2020	Conducted (TH03-CB)
RF Cable-high	Woken	RG402	High Cable-14	1 GHz – 26.5 GHz	Oct. 07, 2019	Oct. 06, 2020	Conducted (TH03-CB)
RF Cable-high	Woken	RG402	High Cable-15	1 GHz – 26.5 GHz	Oct. 07, 2019	Oct. 06, 2020	Conducted (TH03-CB)

Note: Calibration Interval of instruments listed above is one year.

NCR means Non-Calibration required.



AC Power-line Conducted Emissions Result

Appendix A

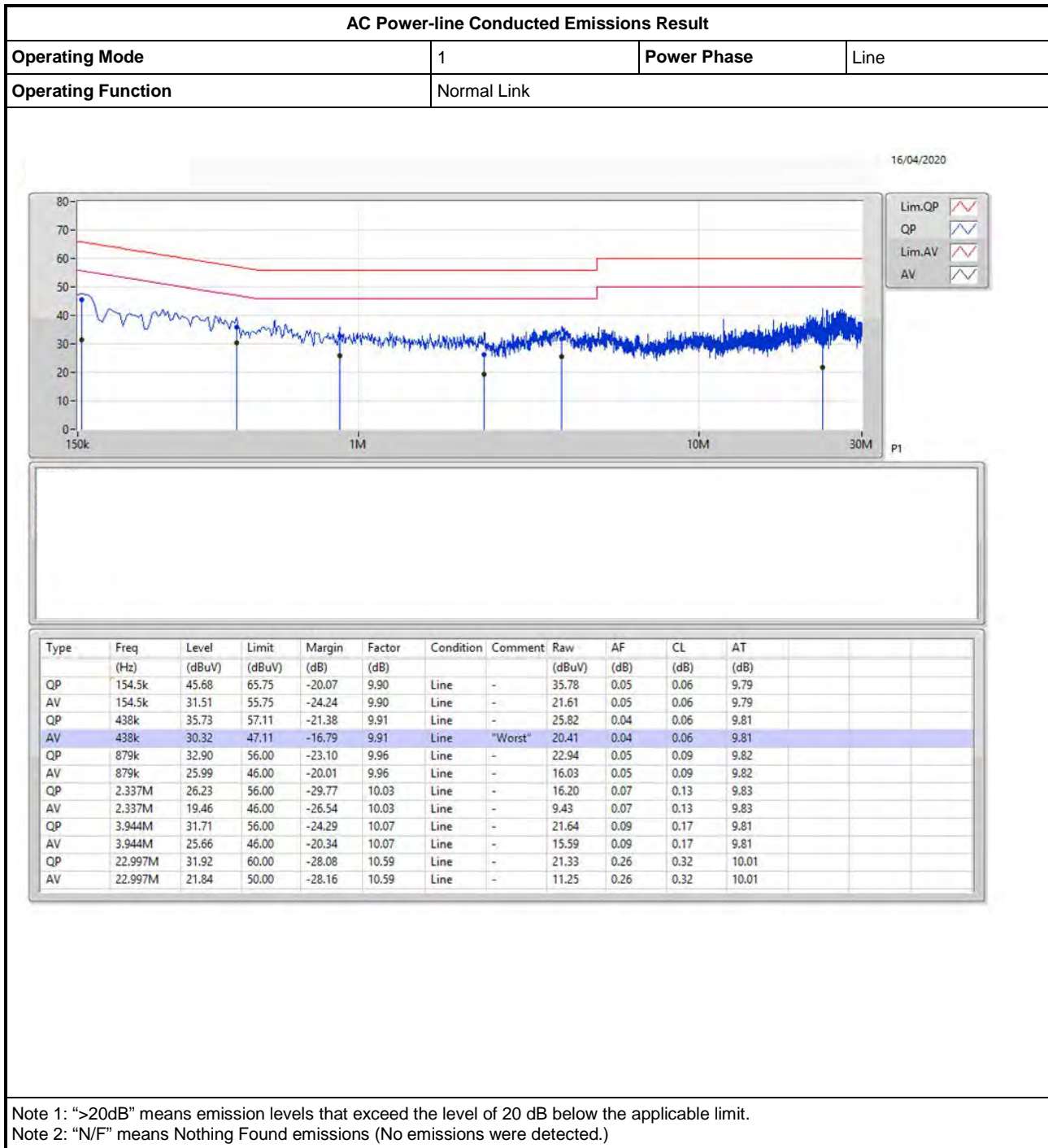



AC Power-line Conducted Emissions Result

Appendix A

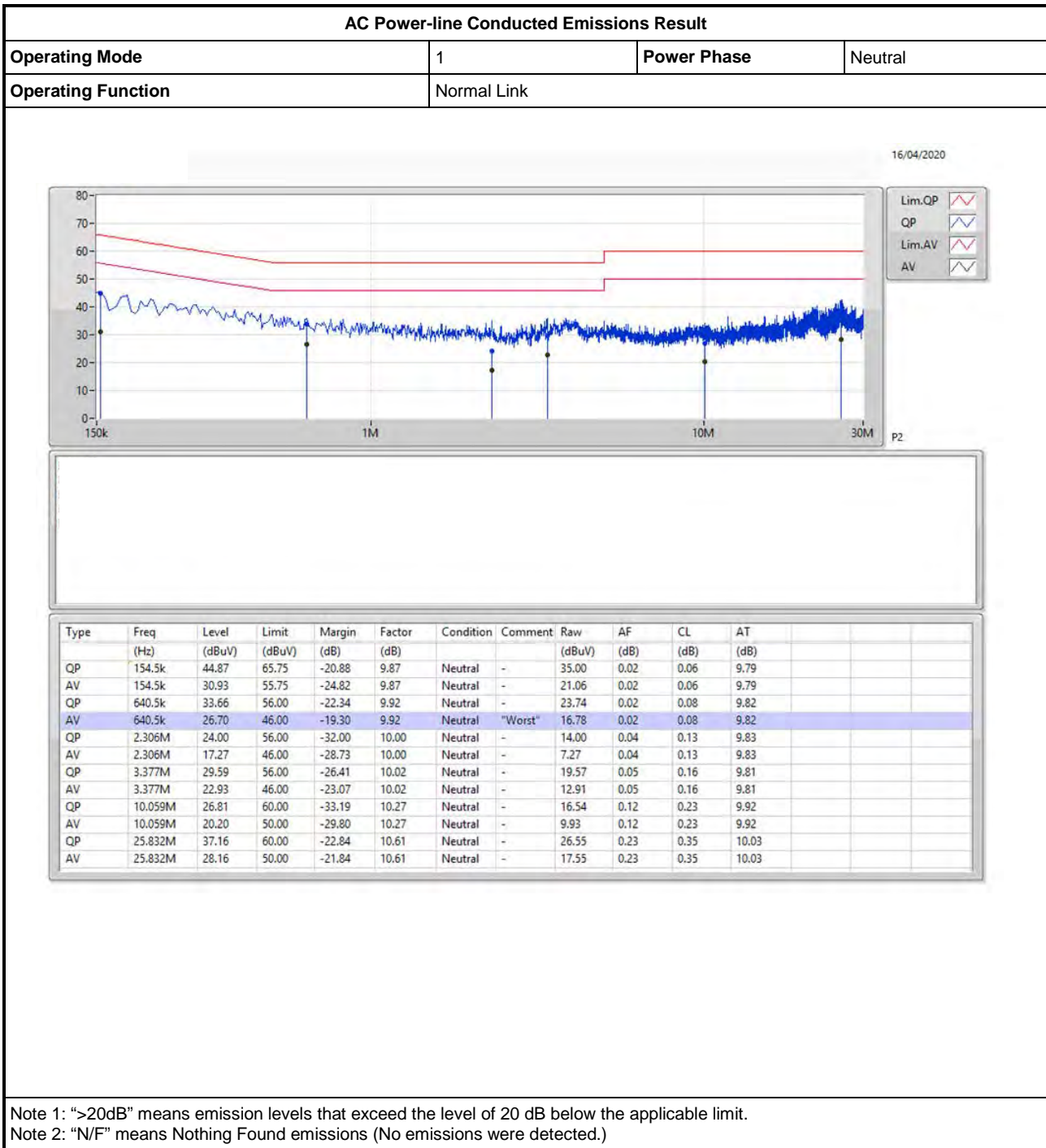



Summary

Mode	Max-N dB (Hz)	Max-OBW (Hz)	ITU-Code	Min-N dB (Hz)	Min-OBW (Hz)
2.4-2.4835GHz	-	-	-	-	-
BT-LE(1Mbps)	715k	1.053M	1M05F1D	712.5k	1.053M

Max-N dB = Maximum 6dB down bandwidth; **Max-OBW** = Maximum 99% occupied bandwidth;
Min-N dB = Minimum 6dB down bandwidth; **Min-OBW** = Minimum 99% occupied bandwidth;



Result

Mode	Result	Limit (Hz)	Port 1-N dB (Hz)	Port 1-OBW (Hz)
BT-LE(1Mbps)	-	-	-	-
2402MHz	Pass	500k	713.75k	1.053M
2440MHz	Pass	500k	712.5k	1.053M
2480MHz	Pass	500k	715k	1.053M

Port X-N dB = Port X 6dB down bandwidth; Port X-OBW = Port X 99% occupied bandwidth;

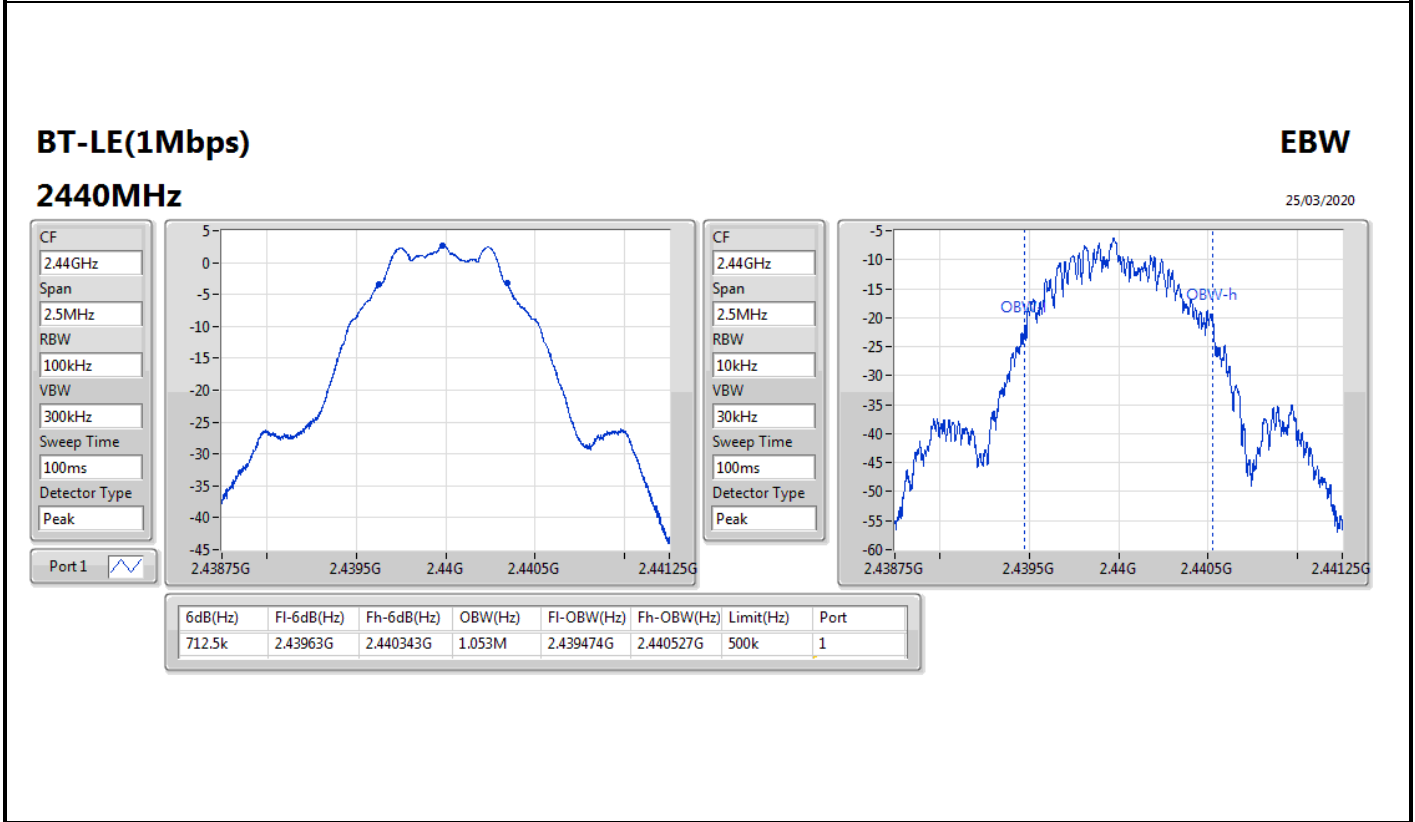
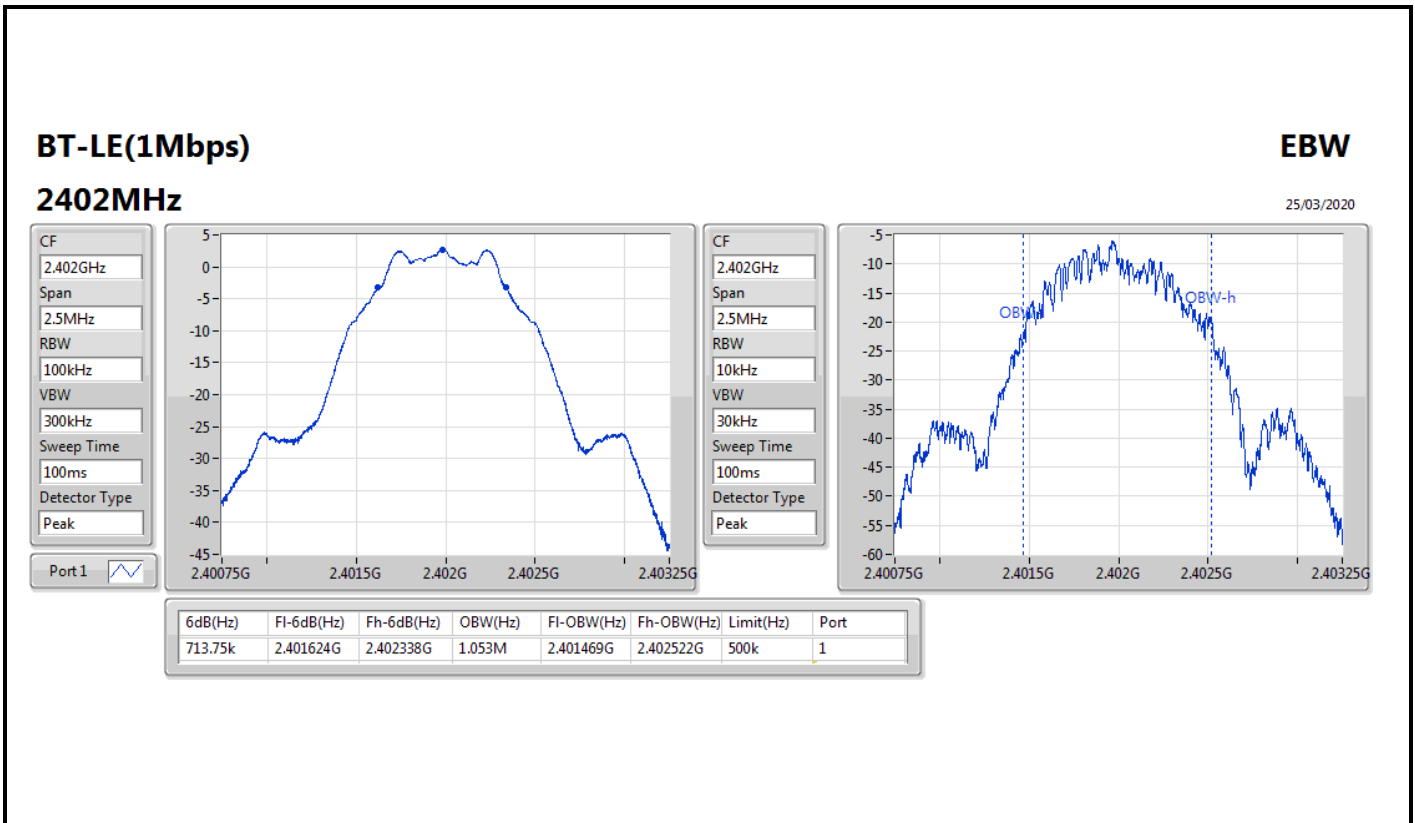

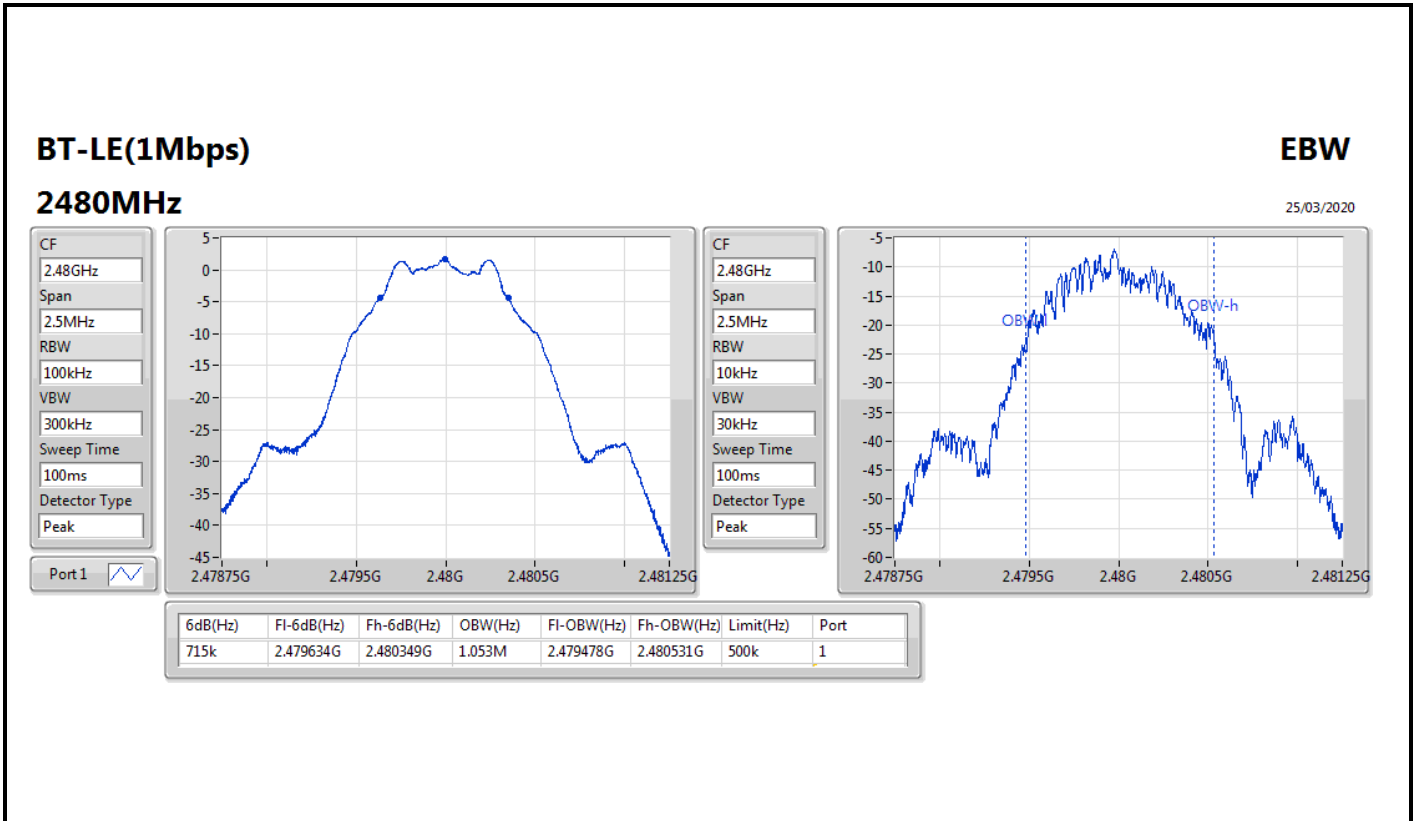



Summary

Mode	Power (dBm)	Power (W)
2.4-2.4835GHz	-	-
BT-LE(1Mbps)	5.70	0.00372



Result

Mode	Result	Gain (dBi)	Power (dBm)	Power Limit (dBm)
BT-LE(1Mbps)	-	-	-	-
2402MHz	Pass	2.98	5.70	30.00
2440MHz	Pass	2.98	5.34	30.00
2480MHz	Pass	2.98	4.49	30.00

DG = Directional Gain; **Port X** = Port X output power



Summary

Mode	PD (dBm/RBW)
2.4-2.4835GHz	-
BT-LE(1Mbps)	-8.84

RBW=3 kHz.



Result

Mode	Result	Gain (dBi)	PD (dBm/RBW)	PD Limit (dBm/RBW)
BT-LE(1Mbps)	-	-	-	-
2402MHz	Pass	2.98	-8.84	8.00
2440MHz	Pass	2.98	-9.10	8.00
2480MHz	Pass	2.98	-10.59	8.00

DG = Directional Gain; RBW=3 kHz;

PD = trace bin-by-bin of each transmits port summing can be performed maximum power density; Port X = Port X power density;

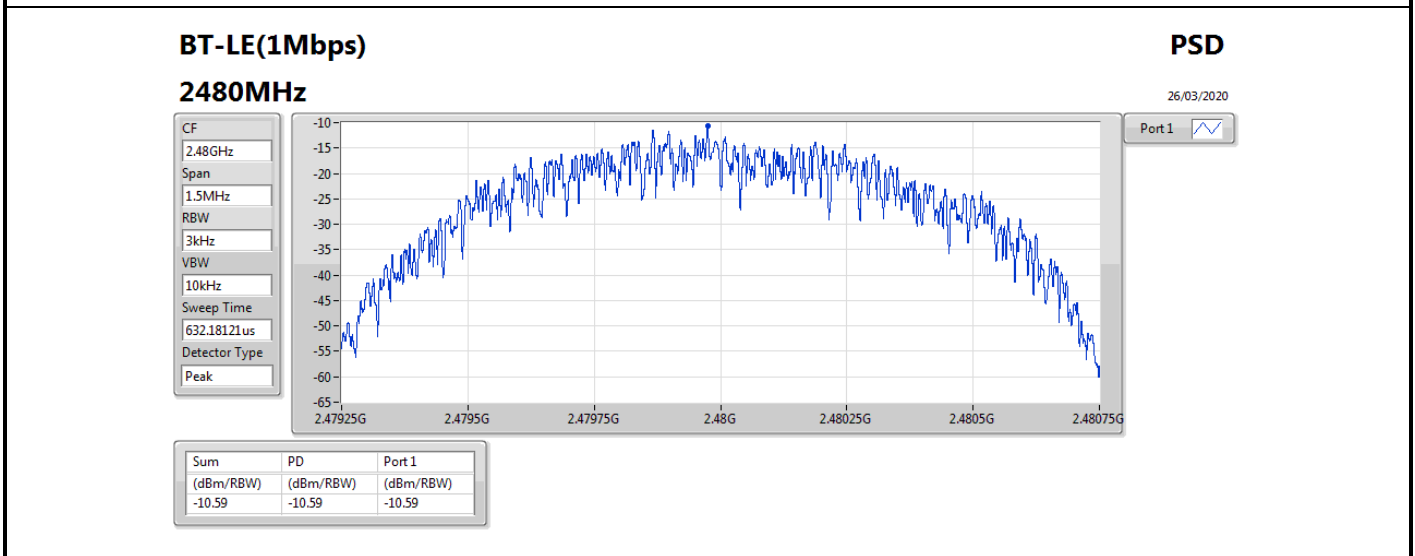
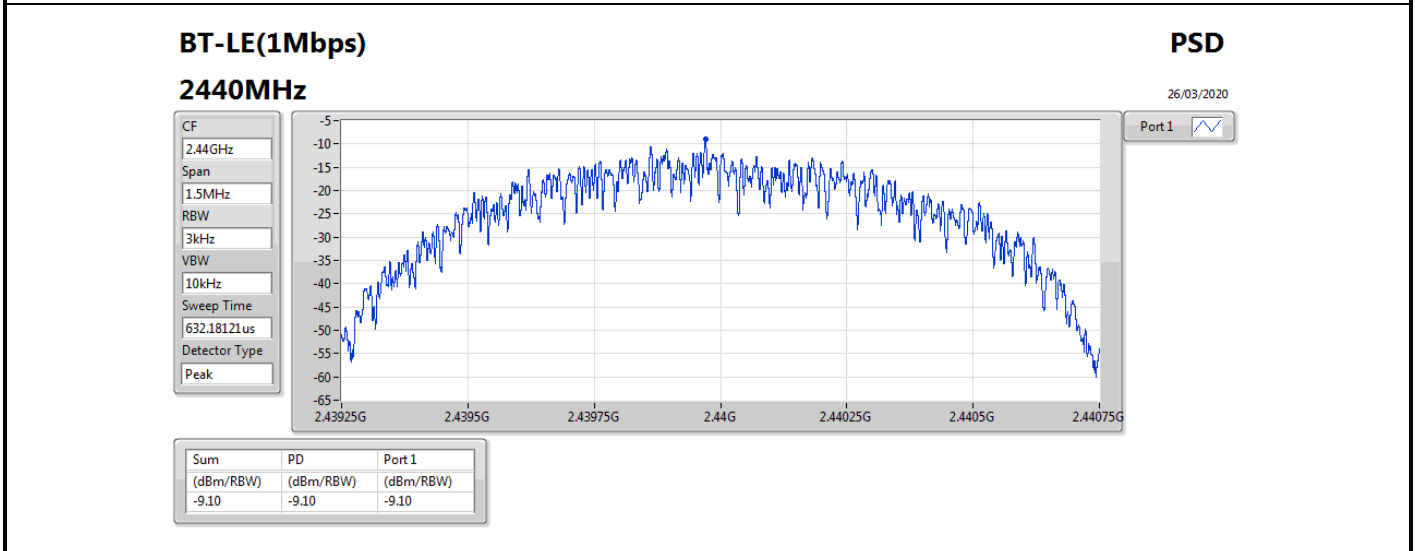
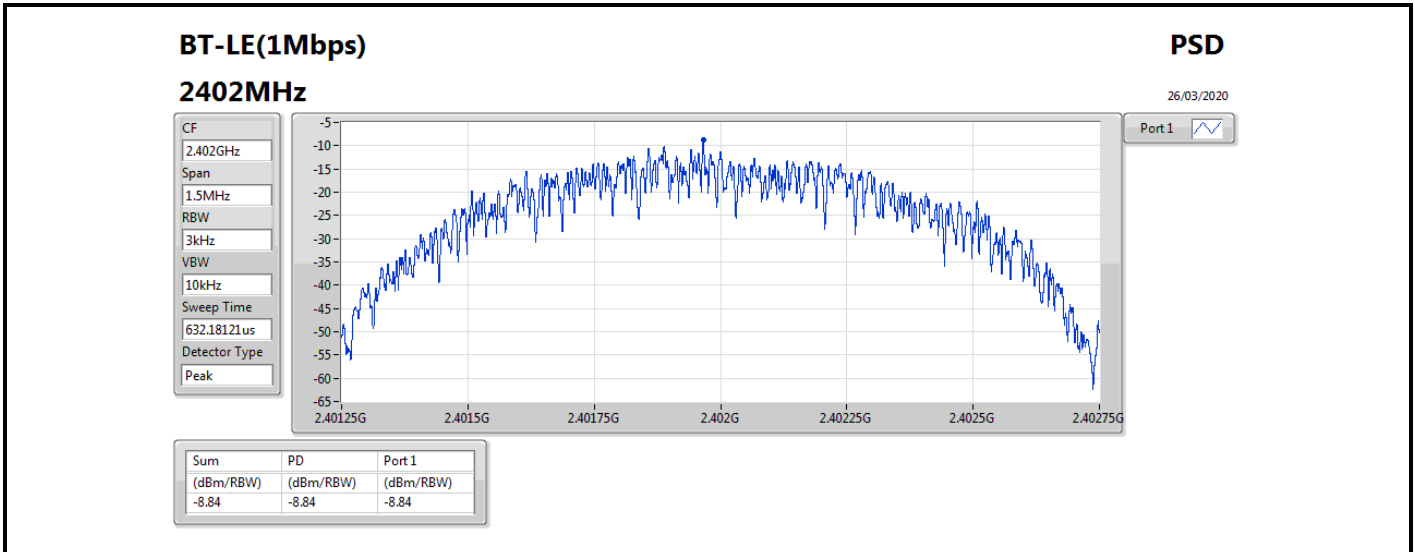



Summary

Mode	Result	Ref (Hz)	Ref (dBm)	Limit (dBm)	Freq (Hz)	Level (dBm)	Freq (Hz)	Level (dBm)	Freq (Hz)	Level (dBm)	Freq (Hz)	Level (dBm)	Freq (Hz)	Level (dBm)	Port
2.4-2.4835GHz	-	-	-	-	-	-	-	-	-	-	-	-	-	-	-
BT-LE(1Mbps)	Pass	2.40196G	2.72	-27.28	752.04M	-52.80	2.39123G	-52.12	2.4G	-53.89	2.49548G	-50.90	23.38869G	-40.66	1



Result

Mode	Result	Ref (Hz)	Ref (dBm)	Limit (dBm)	Freq (Hz)	Level (dBm)	Freq (Hz)	Level (dBm)	Freq (Hz)	Level (dBm)	Freq (Hz)	Level (dBm)	Freq (Hz)	Level (dBm)	Port
BT-LE(1Mbps)	-	-	-	-	-	-	-	-	-	-	-	-	-	-	-
2402MHz	Pass	2.40196G	2.72	-27.28	856.61M	-52.46	2.39767G	-51.79	2.4G	-54.56	2.48685G	-51.50	16.88158G	-41.50	1
2440MHz	Pass	2.40196G	2.72	-27.28	705.92M	-51.95	2.39587G	-52.34	2.4G	-53.22	2.49641G	-50.99	23.54898G	-40.64	1
2480MHz	Pass	2.40196G	2.72	-27.28	752.04M	-52.80	2.39123G	-52.12	2.4G	-53.89	2.49548G	-50.90	23.38869G	-40.66	1

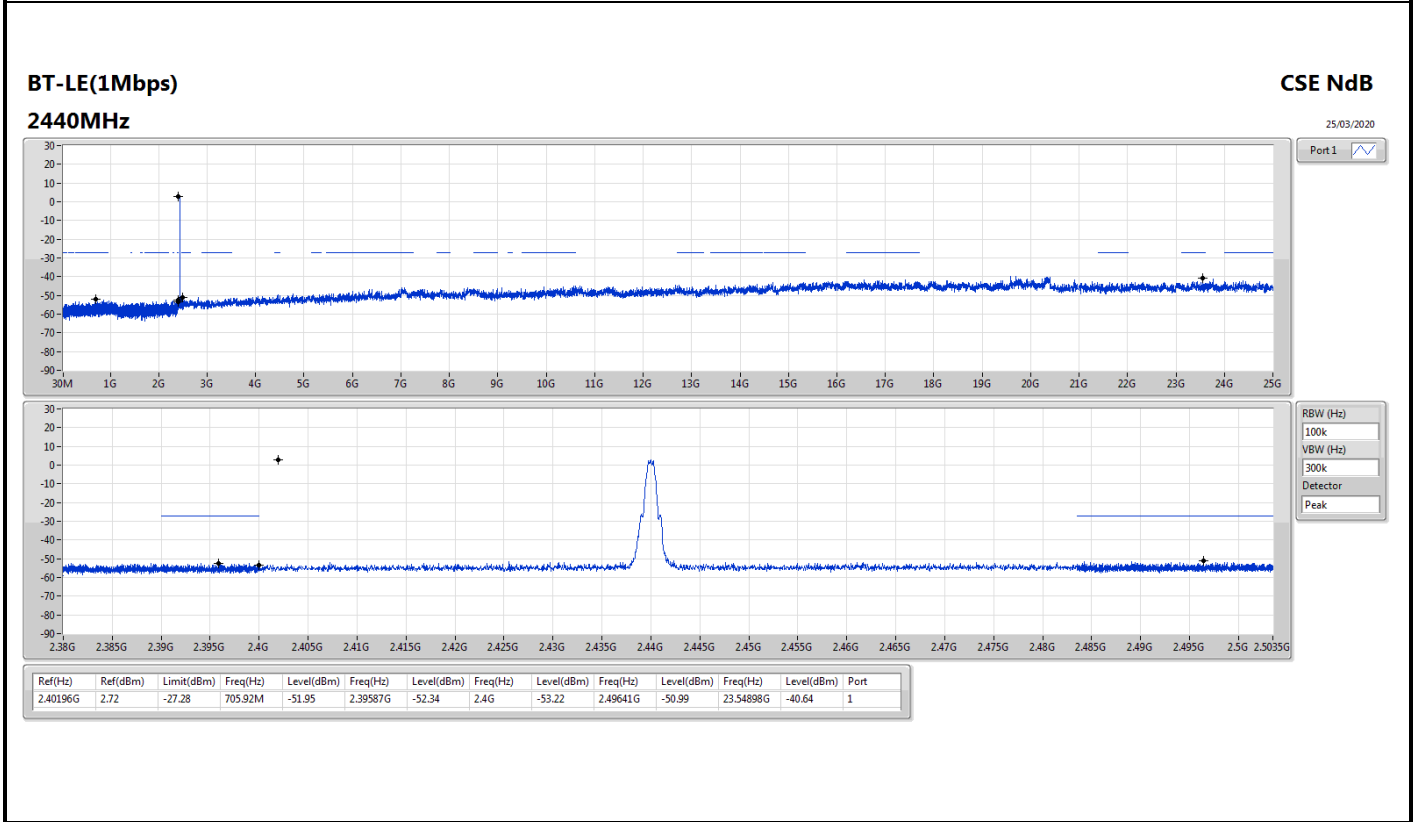
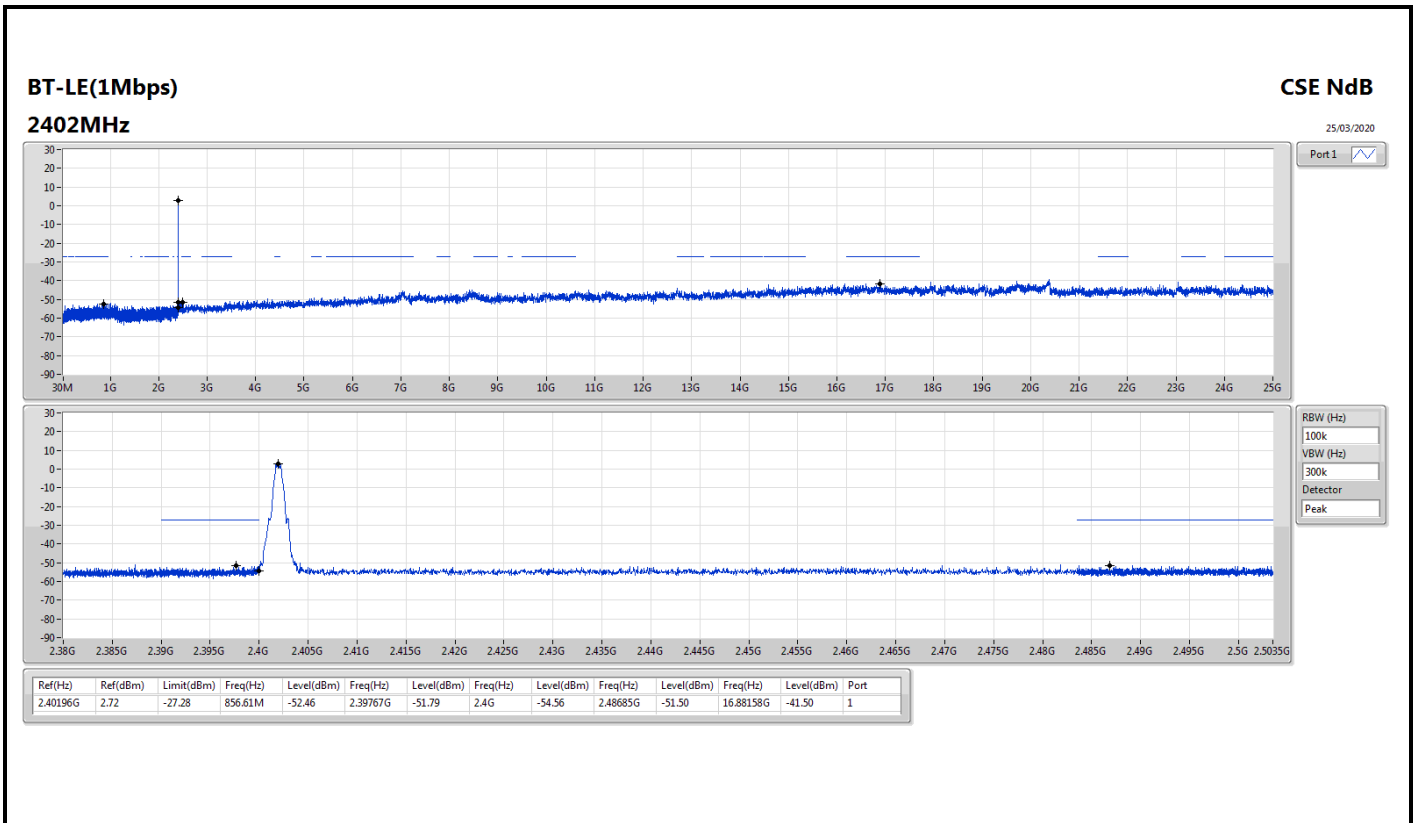

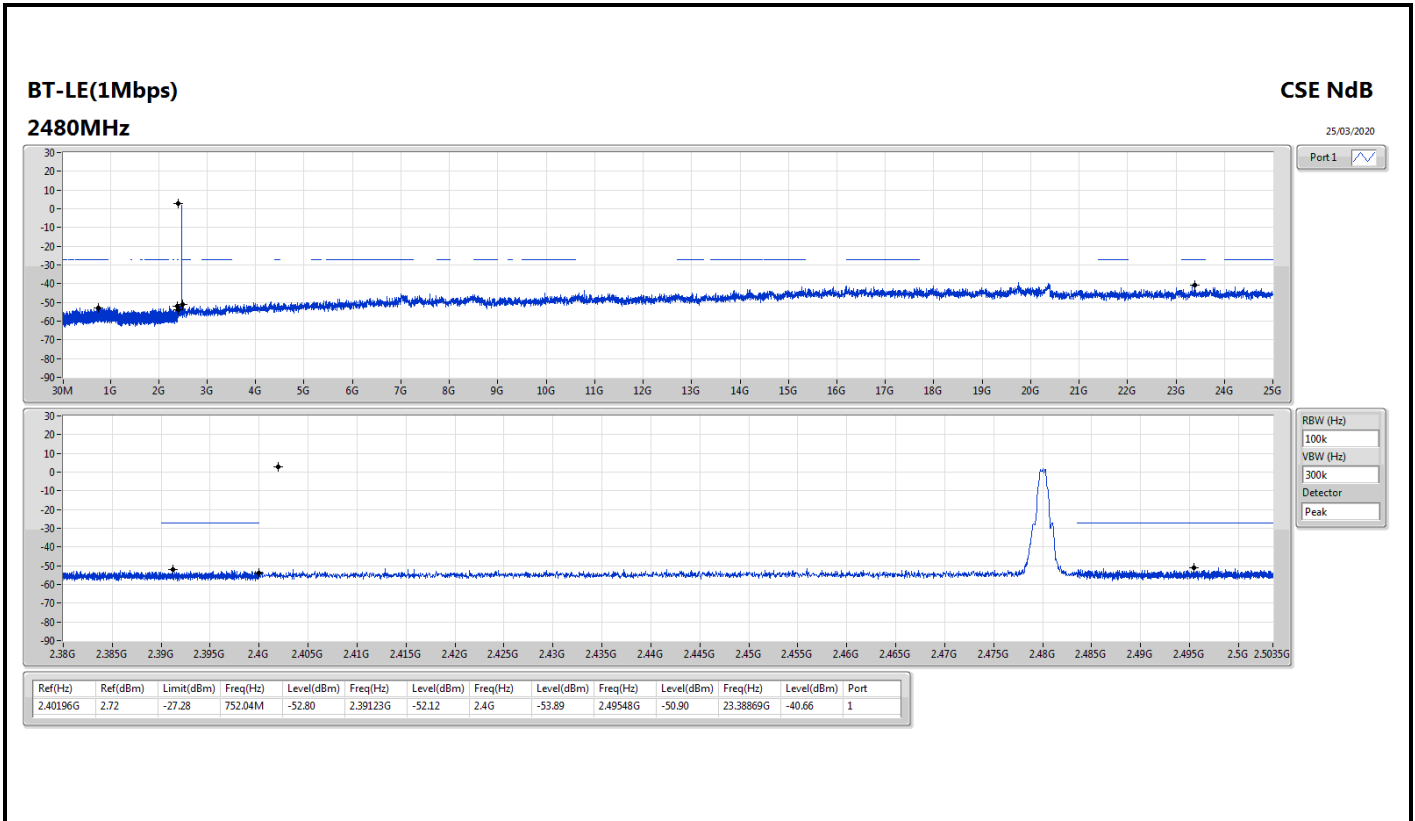

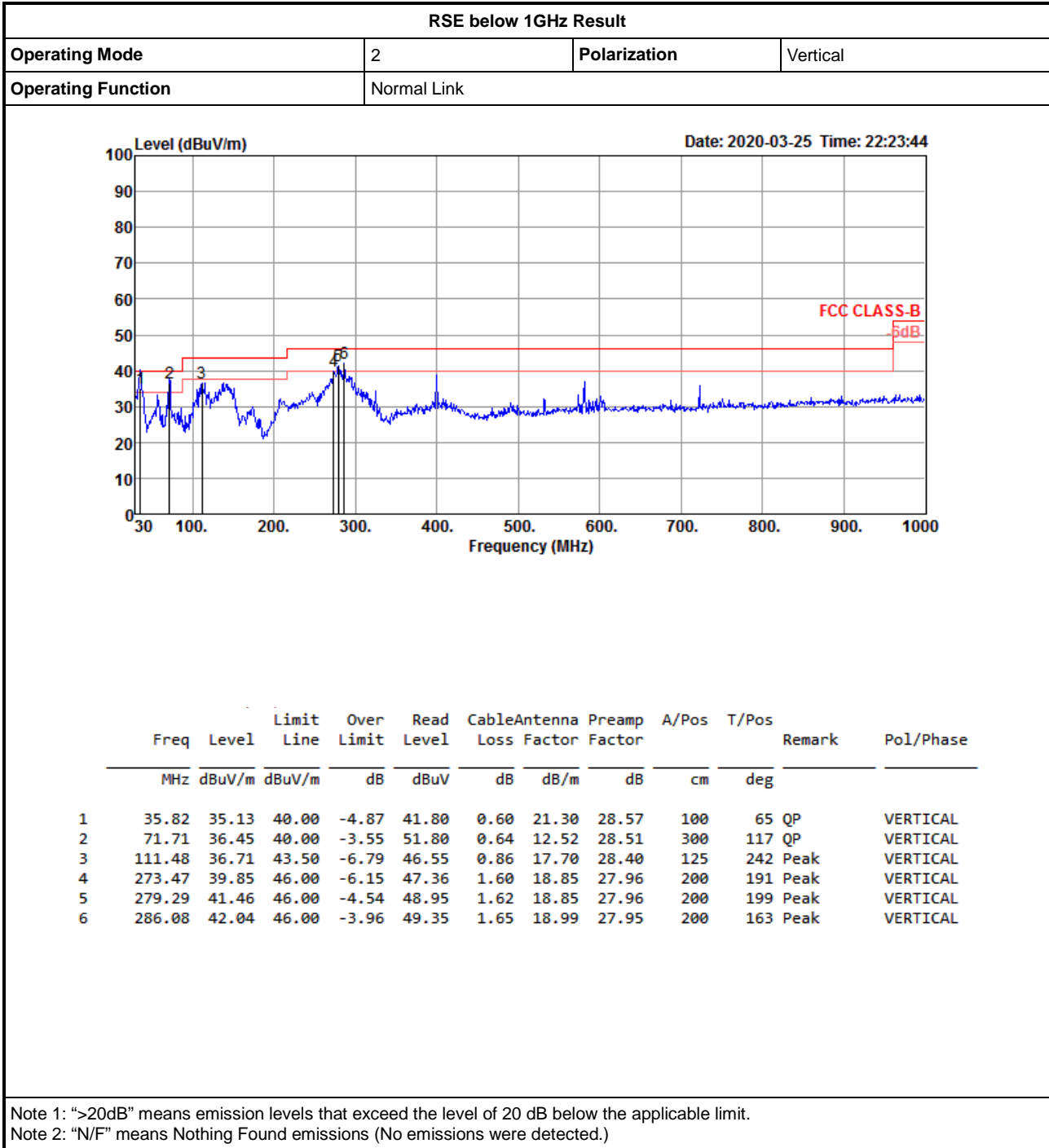

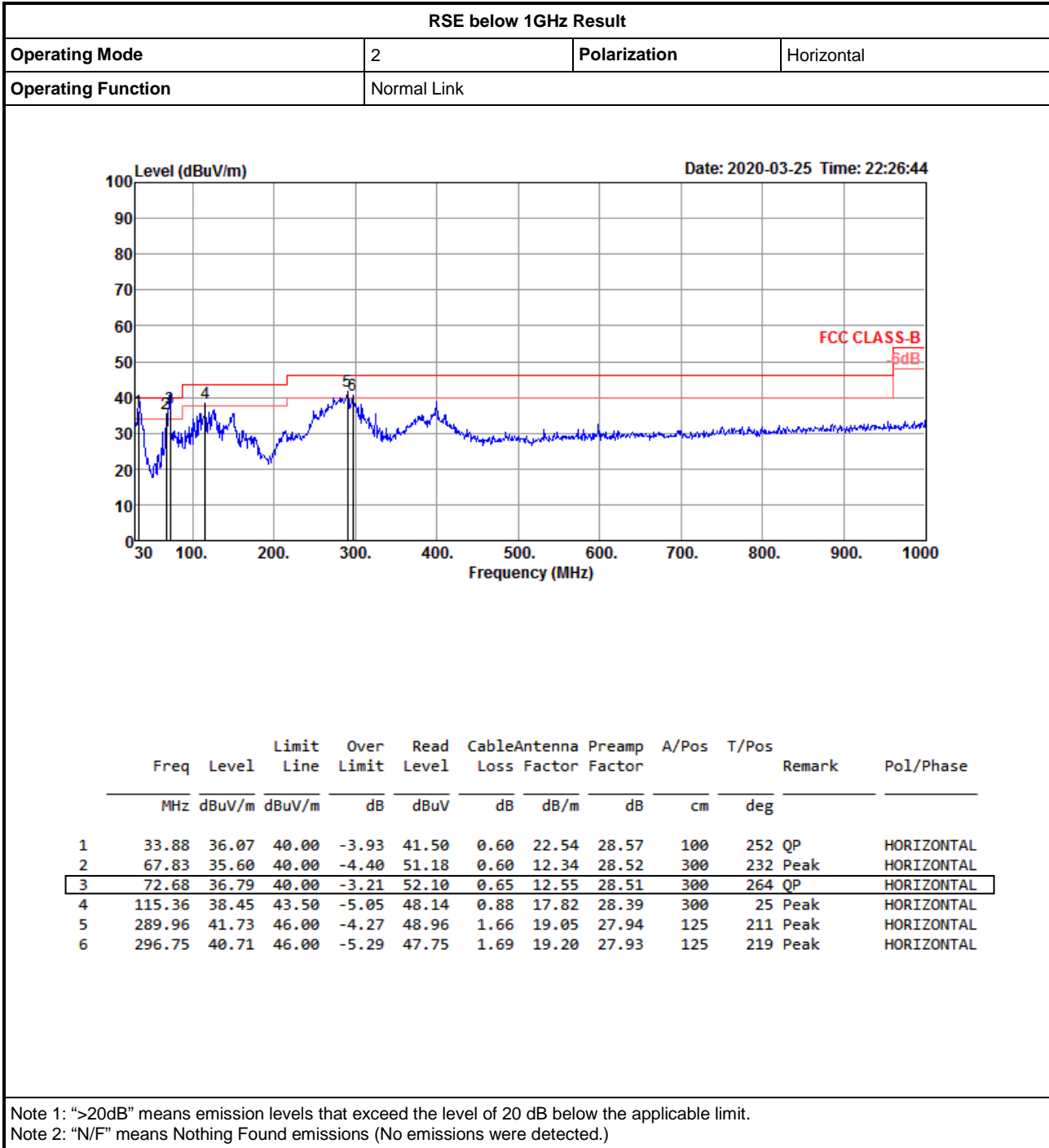



Summary

Mode	Result	Type	Freq (Hz)	Level (dBuV/m)	Limit (dBuV/m)	Margin (dB)	Dist (m)	Condition	Azimuth (°)	Height (m)	Comments
2.4-2.4835GHz	-	-	-	-	-	-	-	-	-	-	-
BT-LE(1Mbps)	Pass	AV	2.4835G	48.88	54.00	-5.12	3	Vertical	31	2.42	-

BT-LE(1Mbps)

25/03/2020

2402MHz_TX

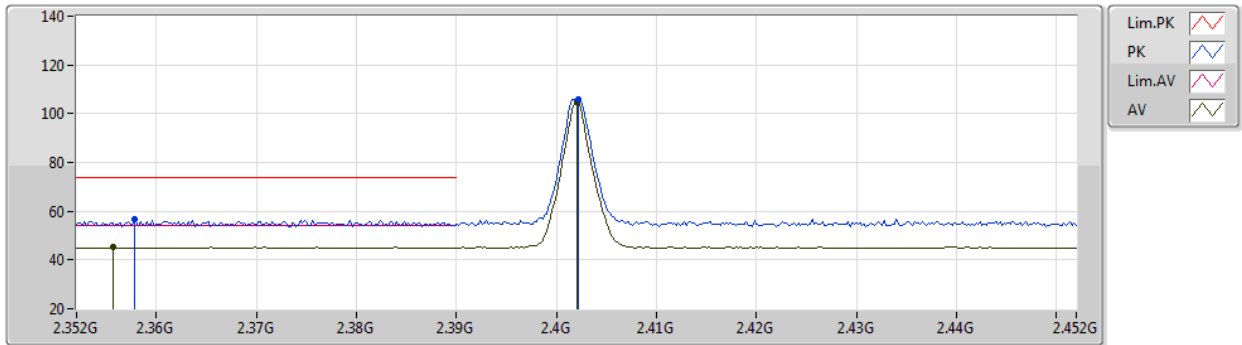

EUT X_1TX
Setting Default
02-D-B-2

Type	Freq (Hz)	Level (dBuV/m)	Limit (dBuV/m)	Margin (dB)	Raw (dBuV)	Dist (m)	Condition	Azimuth (°)	Height (m)	Comment	AF (dB)	CL (dB)	PA (dB)
PK	2.3578G	56.57	74.00	-17.43	24.78	3	Vertical	17	2.00	-	28.29	3.50	-
AV	2.3556G	45.27	54.00	-8.73	13.49	3	Vertical	17	2.00	-	28.28	3.50	-
PK	2.4022G	106.09	Inf	-Inf	74.09	3	Vertical	17	2.00	-	28.50	3.50	-
AV	2.402G	104.63	Inf	-Inf	72.63	3	Vertical	17	2.00	-	28.50	3.50	-

BT-LE(1Mbps)

25/03/2020

2402MHz_TX

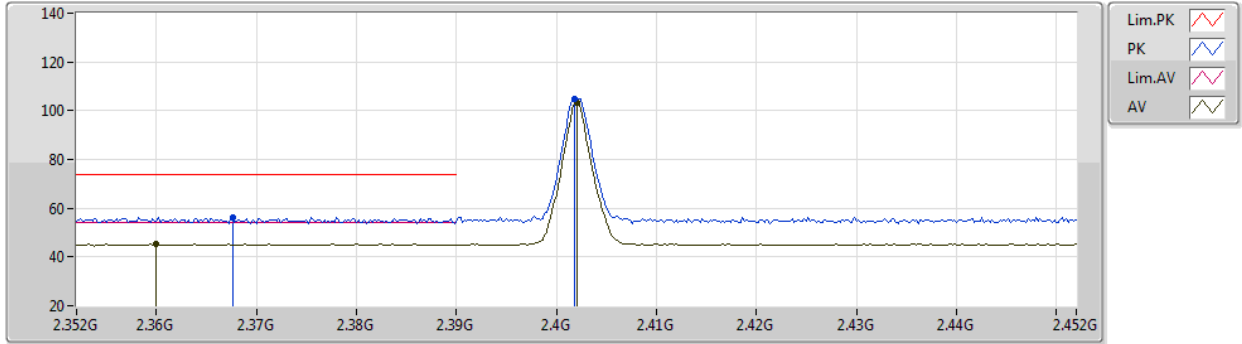

EUT X_1TX
Setting Default
02-D-B-2

Type	Freq (Hz)	Level (dBuV/m)	Limit (dBuV/m)	Margin (dB)	Raw (dBuV)	Dist (m)	Condition	Azimuth (°)	Height (m)	Comment	AF (dB)	CL (dB)	PA (dB)
PK	2.3676G	56.43	74.00	-17.57	24.59	3	Horizontal	6	2.97	-	28.34	3.50	-
AV	2.36G	45.22	54.00	-8.78	13.42	3	Horizontal	6	2.97	-	28.30	3.50	-
PK	2.4018G	104.70	Inf	-Inf	72.70	3	Horizontal	6	2.97	-	28.50	3.50	-
AV	2.402G	103.17	Inf	-Inf	71.17	3	Horizontal	6	2.97	-	28.50	3.50	-

BT-LE(1Mbps)

25/03/2020

2402MHz_TX

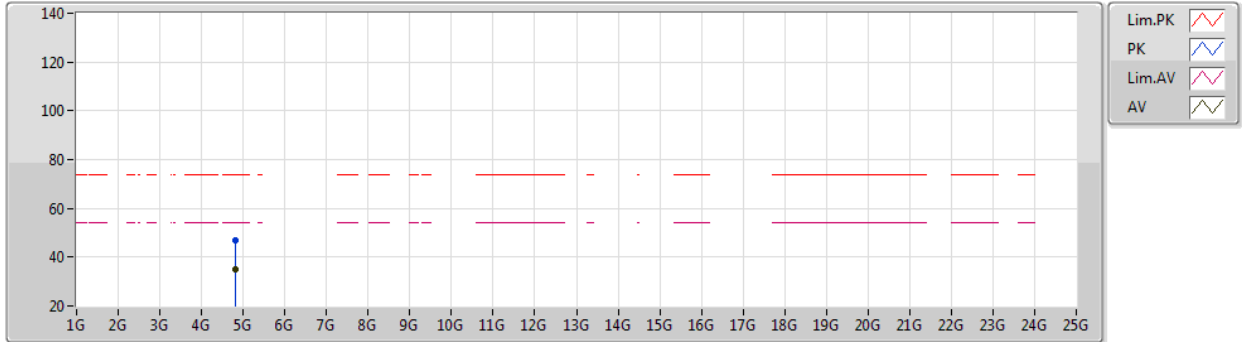

EUT X_1TX
Setting Default
02-D-B-2

Type	Freq (Hz)	Level (dBuV/m)	Limit (dBuV/m)	Margin (dB)	Raw (dBuV)	Dist (m)	Condition	Azimuth (°)	Height (m)	Comment	AF (dB)	CL (dB)	PA (dB)
PK	4.80436G	46.73	74.00	-27.27	38.59	3	Vertical	132	1.23	-	32.72	5.80	30.38
AV	4.80402G	35.17	54.00	-18.83	27.02	3	Vertical	132	1.23	-	32.73	5.80	30.38

BT-LE(1Mbps)

25/03/2020

2402MHz_TX

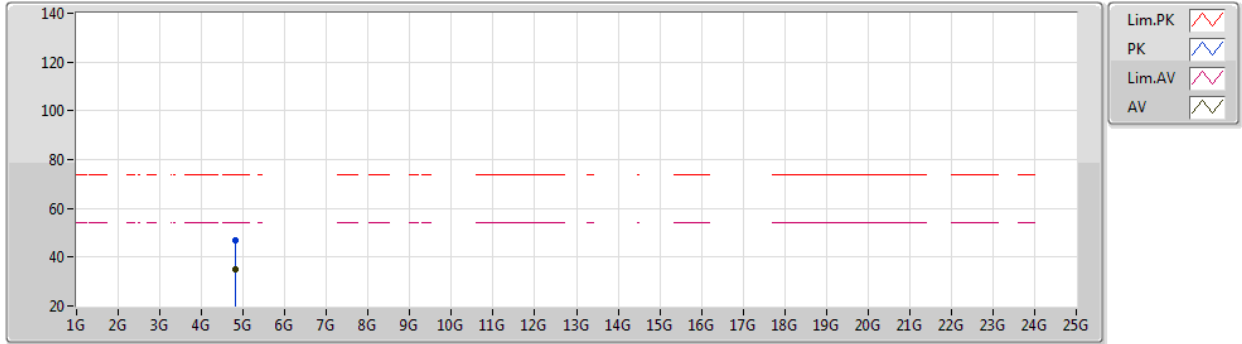

EUT X_1TX
Setting Default
02-D-B-2

Type	Freq (Hz)	Level (dBuV/m)	Limit (dBuV/m)	Margin (dB)	Raw (dBuV)	Dist (m)	Condition	Azimuth (°)	Height (m)	Comment	AF (dB)	CL (dB)	PA (dB)
PK	4.80482G	47.03	74.00	-26.97	38.87	3	Horizontal	170	2.67	-	32.74	5.80	30.38
AV	4.80444G	35.17	54.00	-18.83	27.05	3	Horizontal	170	2.67	-	32.70	5.80	30.38

BT-LE(1Mbps)

25/03/2020

2440MHz_TX

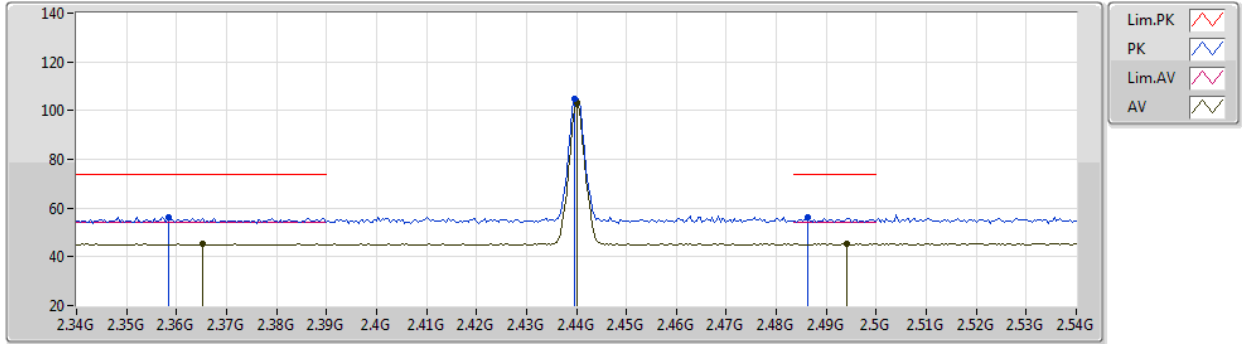

EUT X_1TX
Setting Default
02-D-B-2

Type	Freq (Hz)	Level (dBuV/m)	Limit (dBuV/m)	Margin (dB)	Raw (dBuV)	Dist (m)	Condition	Azimuth (°)	Height (m)	Comment	AF (dB)	CL (dB)	PA (dB)
PK	2.3584G	56.36	74.00	-17.64	24.57	3	Vertical	19	2.26	-	28.29	3.50	-
AV	2.3652G	45.26	54.00	-8.74	13.43	3	Vertical	19	2.26	-	28.33	3.50	-
PK	2.4396G	104.78	Inf	-Inf	72.74	3	Vertical	19	2.26	-	28.50	3.54	-
AV	2.44G	103.24	Inf	-Inf	71.20	3	Vertical	19	2.26	-	28.50	3.54	-
PK	2.4864G	56.01	74.00	-17.99	23.92	3	Vertical	19	2.26	-	28.50	3.59	-
AV	2.494G	45.37	54.00	-8.63	13.28	3	Vertical	19	2.26	-	28.50	3.59	-

BT-LE(1Mbps)

25/03/2020

2440MHz_TX

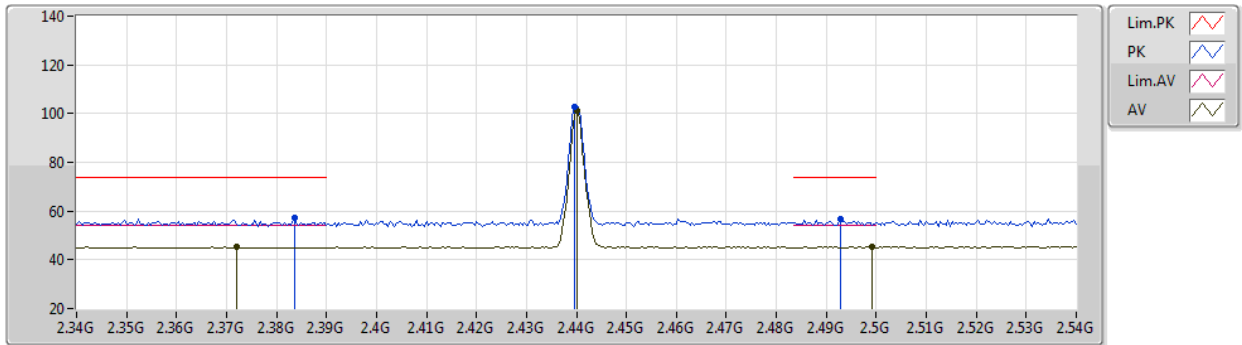

EUT X_1TX
Setting Default
02-D-B-2

Type	Freq (Hz)	Level (dBuV/m)	Limit (dBuV/m)	Margin (dB)	Raw (dBuV)	Dist (m)	Condition	Azimuth (°)	Height (m)	Comment	AF (dB)	CL (dB)	PA (dB)
PK	2.3836G	57.13	74.00	-16.87	25.21	3	Horizontal	0	2.61	-	28.42	3.50	-
AV	2.372G	45.19	54.00	-8.81	13.33	3	Horizontal	0	2.61	-	28.36	3.50	-
PK	2.4396G	102.70	Inf	-Inf	70.66	3	Horizontal	0	2.61	-	28.50	3.54	-
AV	2.44G	101.24	Inf	-Inf	69.20	3	Horizontal	0	2.61	-	28.50	3.54	-
PK	2.4928G	56.62	74.00	-17.38	24.53	3	Horizontal	0	2.61	-	28.50	3.59	-
AV	2.4992G	45.47	54.00	-8.53	13.37	3	Horizontal	0	2.61	-	28.50	3.60	-

BT-LE(1Mbps)

25/03/2020

2440MHz_TX

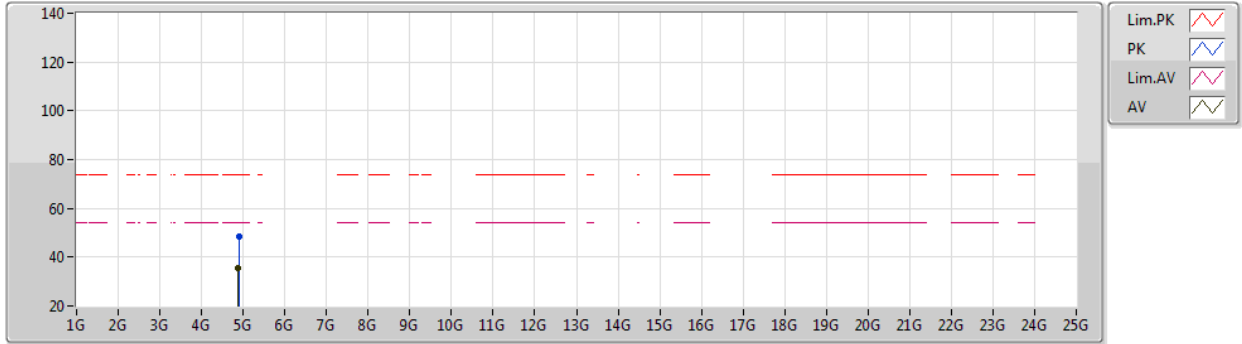

EUT X_1TX
Setting Default
02-D-B-2

Type	Freq (Hz)	Level (dBuV/m)	Limit (dBuV/m)	Margin (dB)	Raw (dBuV)	Dist (m)	Condition	Azimuth (°)	Height (m)	Comment	AF (dB)	CL (dB)	PA (dB)
PK	4.89134G	48.63	74.00	-25.37	40.06	3	Vertical	79	2.40	-	33.07	5.85	30.35
AV	4.87898G	35.72	54.00	-18.28	27.22	3	Vertical	79	2.40	-	33.02	5.84	30.36

BT-LE(1Mbps)

25/03/2020

2440MHz_TX

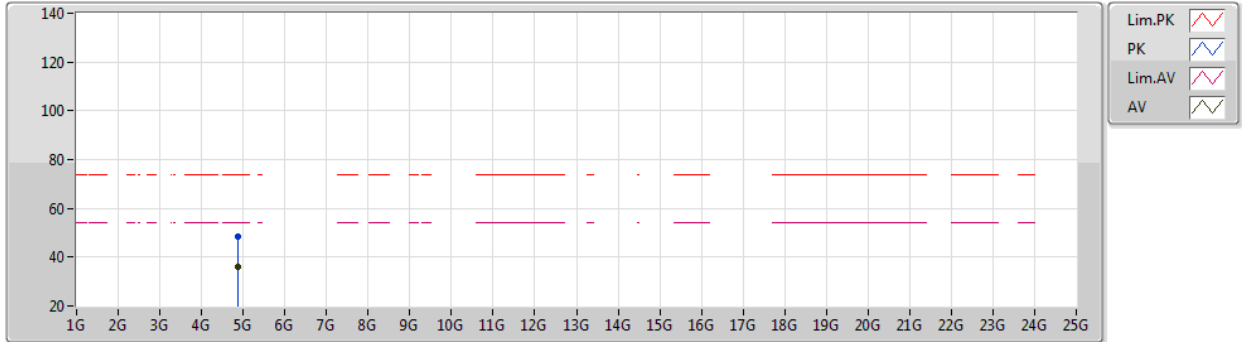

EUT X_1TX
Setting Default
02-D-B-2

Type	Freq (Hz)	Level (dBuV/m)	Limit (dBuV/m)	Margin (dB)	Raw (dBuV)	Dist (m)	Condition	Azimuth (°)	Height (m)	Comment	AF (dB)	CL (dB)	PA (dB)
PK	4.88804G	48.62	74.00	-25.38	40.08	3	Horizontal	48	2.80	-	33.05	5.84	30.35
AV	4.87784G	35.81	54.00	-18.19	27.32	3	Horizontal	48	2.80	-	33.01	5.84	30.36

BT-LE(1Mbps)

25/03/2020

2480MHz_TX

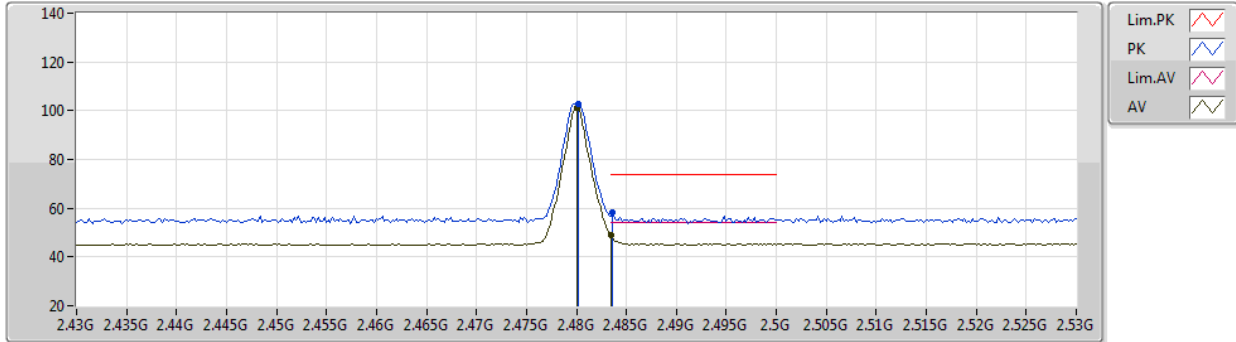

EUT X_1TX
Setting Default
02-D-B-2

Type	Freq (Hz)	Level (dBuV/m)	Limit (dBuV/m)	Margin (dB)	Raw (dBuV)	Dist (m)	Condition	Azimuth (°)	Height (m)	Comment	AF (dB)	CL (dB)	PA (dB)
PK	2.4802G	102.53	Inf	-Inf	70.45	3	Vertical	31	2.42	-	28.50	3.58	-
AV	2.48G	101.09	Inf	-Inf	69.01	3	Vertical	31	2.42	-	28.50	3.58	-
PK	2.4836G	58.51	74.00	-15.49	26.43	3	Vertical	31	2.42	-	28.50	3.58	-
AV	2.4835G	48.88	54.00	-5.12	16.80	3	Vertical	31	2.42	-	28.50	3.58	-

BT-LE(1Mbps)

25/03/2020

2480MHz_TX

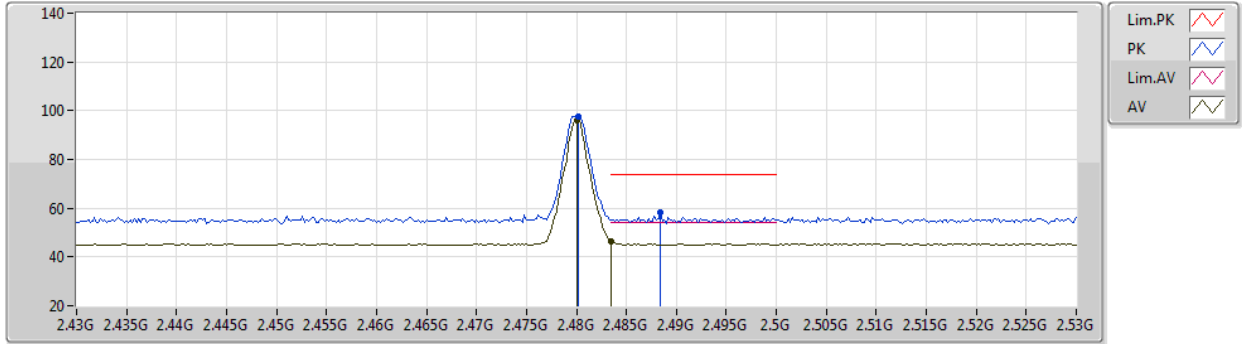

EUT X_1TX
Setting Default
02-D-B-2

Type	Freq (Hz)	Level (dBuV/m)	Limit (dBuV/m)	Margin (dB)	Raw (dBuV)	Dist (m)	Condition	Azimuth (°)	Height (m)	Comment	AF (dB)	CL (dB)	PA (dB)
PK	2.4802G	97.71	Inf	-Inf	65.63	3	Horizontal	336	2.49	-	28.50	3.58	-
AV	2.48G	96.28	Inf	-Inf	64.20	3	Horizontal	336	2.49	-	28.50	3.58	-
PK	2.4884G	58.27	74.00	-15.73	26.18	3	Horizontal	336	2.49	-	28.50	3.59	-
AV	2.4835G	46.55	54.00	-7.45	14.47	3	Horizontal	336	2.49	-	28.50	3.58	-

BT-LE(1Mbps)

25/03/2020

2480MHz_TX

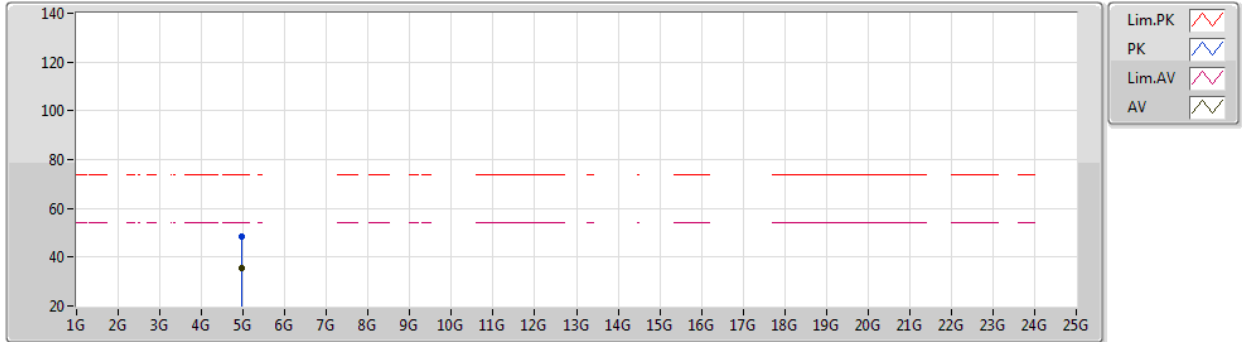

EUT X_1TX
Setting Default
02-D-B-2

Type	Freq (Hz)	Level (dBuV/m)	Limit (dBuV/m)	Margin (dB)	Raw (dBuV)	Dist (m)	Condition	Azimuth (°)	Height (m)	Comment	AF (dB)	CL (dB)	PA (dB)
PK	4.95824G	48.32	74.00	-25.68	39.59	3	Vertical	104	1.49	-	33.20	5.87	30.34
AV	4.96098G	35.65	54.00	-18.35	26.86	3	Vertical	104	1.49	-	33.24	5.89	30.34

BT-LE(1Mbps)

25/03/2020

2480MHz_TX

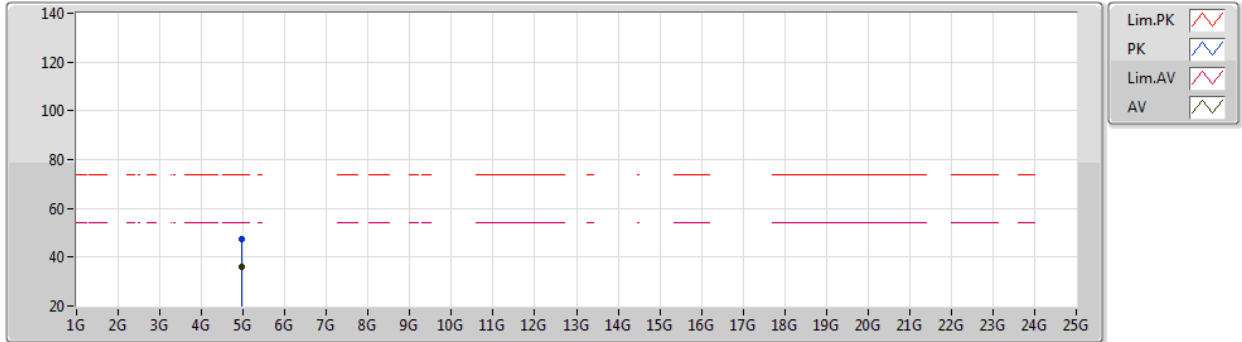

EUT X_1TX
Setting Default
02-D-B-2

Type	Freq (Hz)	Level (dBuV/m)	Limit (dBuV/m)	Margin (dB)	Raw (dBuV)	Dist (m)	Condition	Azimuth (°)	Height (m)	Comment	AF (dB)	CL (dB)	PA (dB)
PK	4.96124G	47.37	74.00	-26.63	38.60	3	Horizontal	321	1.79	-	33.23	5.88	30.34
AV	4.96086G	35.79	54.00	-18.21	27.01	3	Horizontal	321	1.79	-	33.24	5.88	30.34

