



FCC RADIO TEST REPORT

FCC ID : TLZ-CM390SM
Equipment : IEEE 802.11a/b/g/n/ac WiFi with Bluetooth 5.0
Combo Stamp Module
Brand Name : AzureWave
Model Name : AW-CM390SM
Applicant : AzureWave Technologies, Inc.
8F., No.94, Baozhong Rd., Xindian Dist., New Taipei
City 23144, Taiwan
Standard : 47 CFR FCC Part 15.407

The product was received on Mar. 12, 2020, and testing was started from Mar. 19, 2020 and completed on Jun. 02, 2020. We, SPORTON INTERNATIONAL INC. EMC & Wireless Communications Laboratory, would like to declare that the tested sample has been evaluated in accordance with the procedures given in ANSI C63.10-2013 and shown compliance with the applicable technical standards.

The report must not be used by the client to claim product certification, approval, or endorsement by TAF or any agency of government.

The test results in this report apply exclusively to the tested model / sample. Without written approval of SPORTON INTERNATIONAL INC. EMC & Wireless Communications Laboratory, the test report shall not be reproduced except in full.

Approved by: Cliff Chang

SPORTON INTERNATIONAL INC. EMC & Wireless Communications Laboratory

No. 52, Huaya 1st Rd., Guishan Dist., Taoyuan City, Taiwan (R.O.C.)



Table of Contents

History of this test report.....3

Summary of Test Result.....4

1 General Description5

1.1 Information.....5

1.2 Applicable Standards8

1.3 Testing Location Information8

1.4 Measurement Uncertainty8

2 Test Configuration of EUT9

2.1 Test Channel Mode9

2.2 The Worst Case Measurement Configuration11

2.3 EUT Operation during Test12

2.4 Accessories12

2.5 Support Equipment.....13

2.6 Test Setup Diagram14

3 Transmitter Test Result17

3.1 AC Power-line Conducted Emissions17

3.2 Emission Bandwidth19

3.3 Maximum Conducted Output Power20

3.4 Peak Power Spectral Density.....22

3.5 Unwanted Emissions.....25

4 Test Equipment and Calibration Data29

Appendix A. Test Results of AC Power-line Conducted Emissions

Appendix B. Test Results of Emission Bandwidth

Appendix C. Test Results of Maximum Conducted Output Power

Appendix D. Test Results of Peak Power Spectral Density

Appendix E. Test Results of Unwanted Emissions

Appendix F. Test Results of Radiated Emission Co-location

Appendix G. Test Photos

Photographs of EUT v01



Summary of Test Result

Report Clause	Ref Std. Clause	Test Items	Result (PASS/FAIL)	Remark
1.1.2	15.203	Antenna Requirement	PASS	-
3.1	15.207	AC Power-line Conducted Emissions	PASS	-
3.2	15.407(a)	Emission Bandwidth	PASS	-
3.3	15.407(a)	Maximum Conducted Output Power	PASS	-
3.4	15.407(a)	Peak Power Spectral Density	PASS	-
3.5	15.407(b)	Unwanted Emissions	PASS	-

Declaration of Conformity:

The test results with all measurement uncertainty excluded are presented in accordance with the regulation limits or requirements declared by manufacturers.

Comments and Explanations:

The declared of product specification for EUT presented in the report are provided by the manufacturer, and the manufacturer takes all the responsibilities for the accuracy of product specification.

Reviewed by: Sam Chen

Report Producer: Sandy Chuang



1 General Description

1.1 Information

1.1.1 RF General Information

Frequency Range (MHz)	IEEE Std. 802.11	Ch. Frequency (MHz)	Channel Number
5150-5250	a, n (HT20), ac (VHT20)	5180-5240	36-48 [4]
5250-5350		5260-5320	52-64 [4]
5470-5725		5500-5720	100-144 [12]
5725-5850		5745-5825	149-165 [5]
5150-5250	n (HT40), ac (VHT40)	5190-5230	38-46 [2]
5250-5350		5270-5310	54-62 [2]
5470-5725		5510-5710	102-142 [6]
5725-5850		5755-5795	151-159 [2]
5150-5250	ac (VHT80)	5210	42 [1]
5250-5350		5290	58 [1]
5470-5725		5530-5690	106-138 [3]
5725-5850		5775	155 [1]



Band	Mode	BWch (MHz)	Nant
5.15-5.25GHz	802.11a	20	1TX
5.15-5.25GHz	802.11n HT20	20	1TX
5.15-5.25GHz	802.11ac VHT20	20	1TX
5.15-5.25GHz	802.11n HT40	40	1TX
5.15-5.25GHz	802.11ac VHT40	40	1TX
5.15-5.25GHz	802.11ac VHT80	80	1TX
5.25-5.35GHz	802.11a	20	1TX
5.25-5.35GHz	802.11n HT20	20	1TX
5.25-5.35GHz	802.11ac VHT20	20	1TX
5.25-5.35GHz	802.11n HT40	40	1TX
5.25-5.35GHz	802.11ac VHT40	40	1TX
5.25-5.35GHz	802.11ac VHT80	80	1TX
5.47-5.725GHz	802.11a	20	1TX
5.47-5.725GHz	802.11n HT20	20	1TX
5.47-5.725GHz	802.11ac VHT20	20	1TX
5.47-5.725GHz	802.11n HT40	40	1TX
5.47-5.725GHz	802.11ac VHT40	40	1TX
5.47-5.725GHz	802.11ac VHT80	80	1TX
5.725-5.85GHz	802.11a	20	1TX
5.725-5.85GHz	802.11n HT20	20	1TX
5.725-5.85GHz	802.11ac VHT20	20	1TX
5.725-5.85GHz	802.11n HT40	40	1TX
5.725-5.85GHz	802.11ac VHT40	40	1TX
5.725-5.85GHz	802.11ac VHT80	80	1TX

Note:

- ♦ 11a, HT20 and HT40 use a combination of OFDM-BPSK, QPSK, 16QAM, 64QAM modulation.
- ♦ VHT20, VHT40, VHT80 use a combination of OFDM-BPSK, QPSK, 16QAM, 64QAM, 256QAM modulation.
- ♦ BWch is the nominal channel bandwidth.



1.1.2 Antenna Information

Ant.	Port	Brand	P/N	Antenna Type	Connector	Gain (dBi)		
						WLAN		Bluetooth
						2.4GHz	5GHz	
1	1	MAG.LAYERS	MSA-4008-25GC1-A1	PIFA	I-PEX	2.98	5.16	2.98

Note: The above information was declared by manufacturer.

For 2.4GHz function:

For IEEE 802.11b/g/n (1TX/1RX):

Only Port 1 can be used as transmitting/receiving antenna.

For 5GHz function:

For IEEE 802.11a/n/ac (1TX/1RX):

Only Port 1 can be used as transmitting/receiving antenna.

For Bluetooth function:

Only Port 1 can be used as transmitting/receiving antenna.

1.1.3 Mode Test Duty Cycle

Mode	DC	DCF(dB)	T(s)	VBW(Hz) ≥ 1/T
802.11a	0.989	0.05	n/a (DC>=0.98)	n/a (DC>=0.98)
802.11ac VHT20	0.95	0.22	1.933m	1k
802.11ac VHT40	0.909	0.41	953.75u	3k
802.11ac VHT80	0.822	0.85	461.875u	3k

Note:

- ◆ DC is Duty Cycle.
- ◆ DCF is Duty Cycle Factor.

1.1.4 EUT Operational Condition

EUT Power Type	From host system			
Beamforming Function	<input type="checkbox"/>	With beamforming	<input checked="" type="checkbox"/>	Without beamforming
Weather Band	<input checked="" type="checkbox"/>	With 5600~5650MHz	<input type="checkbox"/>	Without 5600~5650MHz
Function	<input type="checkbox"/>	Outdoor P2M	<input type="checkbox"/>	Indoor P2M
	<input type="checkbox"/>	Fixed P2P	<input checked="" type="checkbox"/>	Client
TPC Function	<input checked="" type="checkbox"/>	With TPC	<input type="checkbox"/>	Without TPC
Test Software Version	Version 7.45.173(r707987 CY WLTEST)FWID 01-6c82dde4			

Note: The above information was declared by manufacturer.



1.2 Applicable Standards

According to the specifications of the manufacturer, the EUT must comply with the requirements of the following standards:

- ◆ 47 CFR FCC Part 15
- ◆ ANSI C63.10-2013
- ◆ FCC KDB 789033 D02 v02r01

The following reference test guidance is not within the scope of accreditation of TAF.

- ◆ FCC KDB 412172 D01 v01r01
- ◆ FCC KDB 414788 D01 v01r01

1.3 Testing Location Information

Testing Location		
<input type="checkbox"/>	HWA YA	ADD : No. 52, Huaya 1st Rd., Guishan Dist., Taoyuan City, Taiwan (R.O.C.) TEL : 886-3-327-3456 FAX : 886-3-327-0973
<input checked="" type="checkbox"/>	JHUBEI	ADD : No.8, Lane 724, Bo-ai St., Jhubei City, HsinChu County 302, Taiwan, R.O.C. TEL : 886-3-656-9065 FAX : 886-3-656-9085

Test Condition	Test Site No.	Test Engineer	Test Environment	Test Date
RF Conducted	TH03-CB	Lucas Huangs	22-22.4°C / 45-47%	Mar. 25, 2020~ Jun. 02, 2020
Radiated<Below 1GHz>	03CH04-CB	Stim Sung	21.1-22.7°C / 45-47%	Mar. 25, 2020~ Apr. 29, 2020
Radiated<Above 1GHz>	03CH03-CB	Brian Sun	21.3-22.7°C / 47-49%	Mar. 19, 2020 May 29, 2020
AC Conduction	CO01-CB	Max Lin	23~24°C / 59~60%	Apr. 16, 2020

Test site Designation No. TW0006 with FCC.

Test site registered number IC 4086D with Industry Canada.

1.4 Measurement Uncertainty

ISO/IEC 17025 requires that an estimate of the measurement uncertainties associated with the emissions test results be included in the report. The measurement uncertainties given below are based on a 95% confidence level (based on a coverage factor (k=2))

Test Items	Uncertainty	Remark
Conducted Emission (150kHz ~ 30MHz)	2.0 dB	Confidence levels of 95%
Radiated Emission (30MHz ~ 1,000MHz)	4.3 dB	Confidence levels of 95%
Radiated Emission (1GHz ~ 18GHz)	4.3 dB	Confidence levels of 95%
Radiated Emission (18GHz ~ 40GHz)	5.1 dB	Confidence levels of 95%
Conducted Emission	2.4 dB	Confidence levels of 95%
Output Power Measurement	1.5 dB	Confidence levels of 95%
Power Density Measurement	2.4 dB	Confidence levels of 95%
Bandwidth Measurement	2%	Confidence levels of 95%



2 Test Configuration of EUT

2.1 Test Channel Mode

Mode	Power Setting
802.11a_Nss1,(6Mbps)_1TX	-
5180MHz	15
5200MHz	21
5240MHz	23
5260MHz	20
5300MHz	20
5320MHz	18
5500MHz	16
5580MHz	21
5700MHz	18
5745MHz	24
5785MHz	24
5825MHz	24
802.11ac VHT20_Nss1,(MCS0)_1TX	-
5180MHz	16
5200MHz	20
5240MHz	20
5260MHz	21
5300MHz	20
5320MHz	19
5500MHz	16
5580MHz	21
5700MHz	19
5745MHz	24
5785MHz	24
5825MHz	24
802.11ac VHT40_Nss1,(MCS0)_1TX	-
5190MHz	13
5230MHz	19
5270MHz	20
5310MHz	12
5510MHz	14
5550MHz	20
5670MHz	19
5755MHz	18
5795MHz	24



Mode	Power Setting
802.11ac VHT80_Nss1,(MCS0)_1TX	-
5210MHz	13
5290MHz	12.5
5530MHz	13.5
5610MHz	21
5690MHz Straddle 5.47-5.725GHz	21
5690MHz Straddle 5.725-5.85GHz	21
5775MHz	17

Note:

- ♦ VHT20/VHT40 covers HT20/HT40, due to same modulation. The power setting for 802.11n HT20 and HT40 are the same or lower than 802.11ac VHT20 and VHT40.



2.2 The Worst Case Measurement Configuration

The Worst Case Mode for Following Conformance Tests	
Tests Item	AC power-line conducted emissions
Condition	AC power-line conducted measurement for line and neutral
Operating Mode	Normal Link
1	EUT + 2.4GHz + Bluetooth with Ant.
2	EUT + 5GHz + Bluetooth with Ant.
For operating mode 1 is the worst case and it was record in this test report.	

The Worst Case Mode for Following Conformance Tests	
Tests Item	Emission Bandwidth Maximum Conducted Output Power Peak Power Spectral Density Unwanted Emissions
Test Condition	Conducted measurement at transmit chains

The Worst Case Mode for Following Conformance Tests	
Tests Item	Unwanted Emissions
Test Condition	Radiated measurement If EUT consist of multiple antenna assembly (multiple antenna are used in EUT regardless of spatial multiplexing MIMO configuration), the radiated test should be performed with highest antenna gain of each antenna type.
Operating Mode < 1GHz	Normal Link
1	EUT in Z axis + 2.4GHz + Bluetooth with Ant.
2	EUT in Z axis + 5GHz + Bluetooth with Ant.
For operating mode 2 is the worst case and it was record in this test report.	
Operating Mode > 1GHz	CTX
The EUT was performed at X axis, Y axis and Z axis position test, and the worst case was found at X axis So the measurement will follow this same test configuration.	
1	EUT in X axis + Ant.



The Worst Case Mode for Following Conformance Tests	
Tests Item	Simultaneous Transmission Analysis - Radiated Emission Co-location
Test Condition	Radiated measurement
Operating Mode	Normal Link
1	EUT in Z axis: Bluetooth+WLAN 2.4GHz
2	EUT in Z axis: Bluetooth+WLAN 5GHz
For operating mode 1 was the worst case and it was record in this test report.	
Refer to Appendix F for Radiated Emission Co-location.	

The Worst Case Mode for Following Conformance Tests	
Tests Item	Simultaneous Transmission Analysis - Co-location RF Exposure Evaluation
Operating Mode	
1	Bluetooth+WLAN 2.4GHz
2	Bluetooth+WLAN 5GHz
Refer to Sporton Test Report No.: FA030609 for Co-location RF Exposure Evaluation.	

2.3 EUT Operation during Test

For CTX Mode:

The EUT was programmed to be in continuously transmitting mode.

For Normal Link:

During the test, the EUT operation to normal function.

2.4 Accessories

N/A



2.5 Support Equipment

For AC Conduction:

Support Equipment				
No.	Equipment	Brand Name	Model Name	FCC ID
A	Fixture	AzureWave	CK77 94V-0	N/A
B	Notebook	DELL	E6430	N/A
C	Earphone	e-Power	S90W	N/A
D	Mouse	HP	FM100	N/A
E	Smart phone	Samsung	Galaxy J2	A3LSMJ200F
F	AP	ASUS	RP-N53	MSQ-RPN53

For Radiated (below 1GHz):

Support Equipment				
No.	Equipment	Brand Name	Model Name	FCC ID
A	Notebook	DELL	E4300	N/A
B	WLAN AP	ASUS	RT-AX88U	MSQ-RTAXHP00
C	Smart phone	Samsung	Galaxy J2	A3LSMJ200F
D	Fixture	AzureWave	CK77 94V-0	N/A
E	Earphone	e-Power	S90W	N/A
F	Mouse	HP	FM100	N/A

For Radiated (above 1GHz):

Support Equipment				
No.	Equipment	Brand Name	Model Name	FCC ID
A	Notebook	DELL	E4300	N/A
B	Fixture	AzureWave	CK77 94V-0	N/A

For RF Conducted:

Support Equipment				
No.	Equipment	Brand Name	Model Name	FCC ID
A	Notebook	DELL	E4300	N/A
B	Fixture	AzureWave	CK77 94V-0	N/A

2.6 Test Setup Diagram

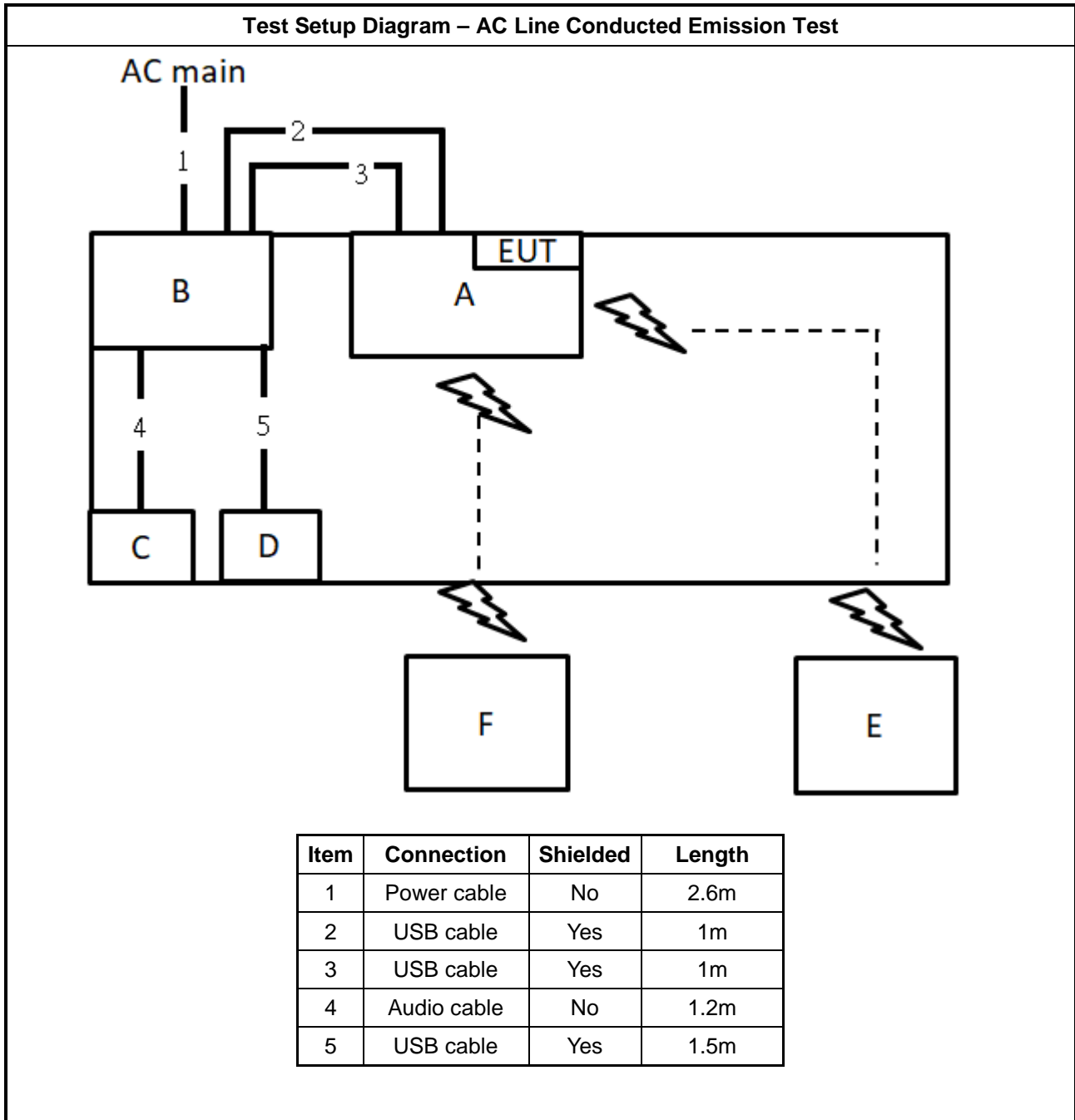

Test Setup Diagram - Radiated Test < 1GHz

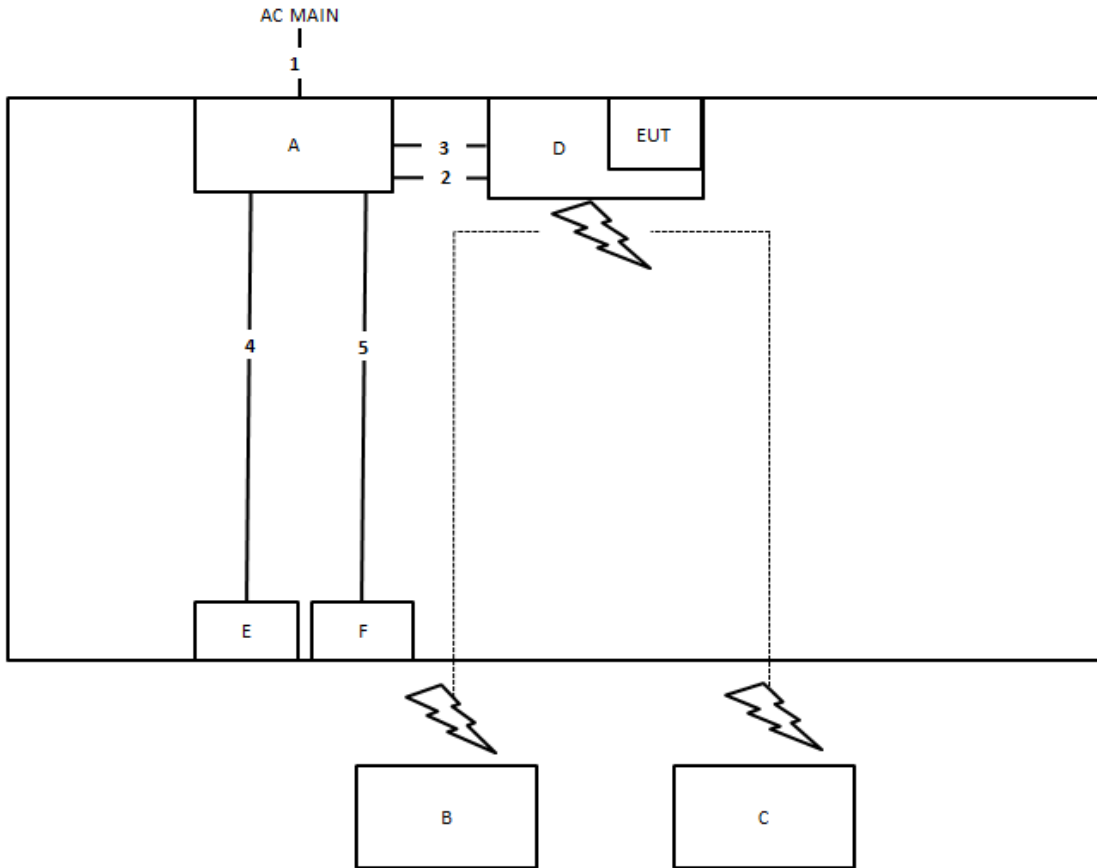

Item	Connection	Shielded	Length
1	Power cable	No	2.6m
2	USB cable	Yes	1m
3	USB cable	Yes	1m
4	Audio cable	No	1.2m
5	USB cable	Yes	1.5m

Test Setup Diagram - Radiated Test > 1GHz

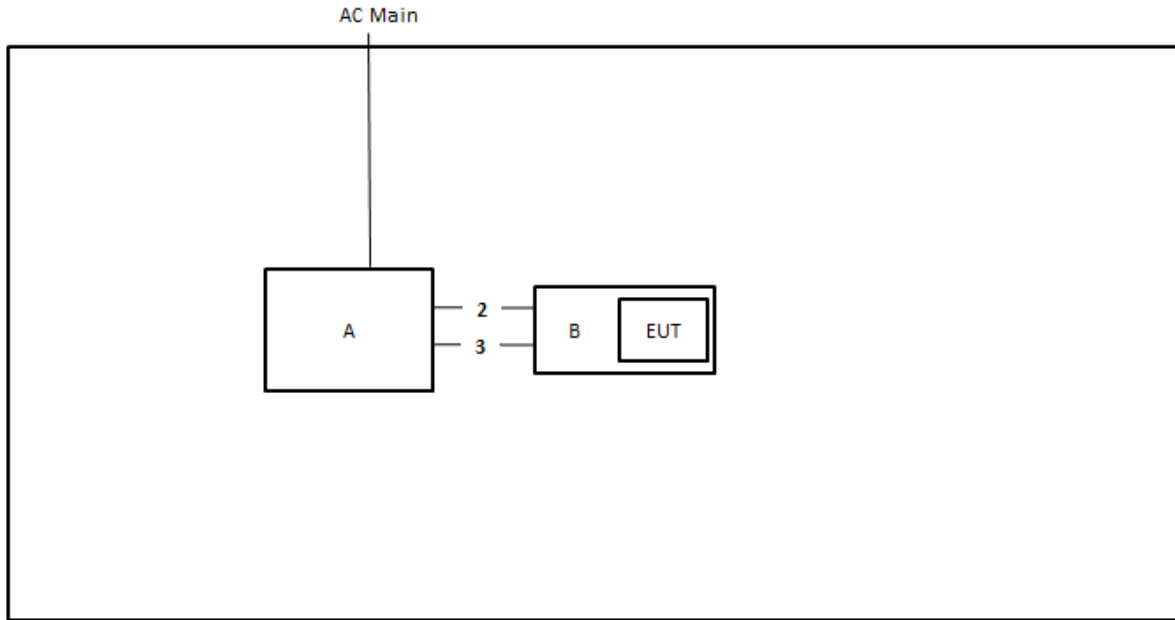

Item	Connection	Shielded	Length
1	USB cable	No	1m
2	USB cable	No	1m



3 Transmitter Test Result

3.1 AC Power-line Conducted Emissions

3.1.1 AC Power-line Conducted Emissions Limit

AC Power-line Conducted Emissions Limit		
Frequency Emission (MHz)	Quasi-Peak	Average
0.15-0.5	66 - 56 *	56 - 46 *
0.5-5	56	46
5-30	60	50

Note 1: * Decreases with the logarithm of the frequency.

3.1.2 Measuring Instruments

Refer a test equipment and calibration data table in this test report.

3.1.3 Test Procedures

Test Method
<input checked="" type="checkbox"/> Refer as ANSI C63.10-2013, clause 6.2 for AC power-line conducted emissions.

3.1.4 Test Setup

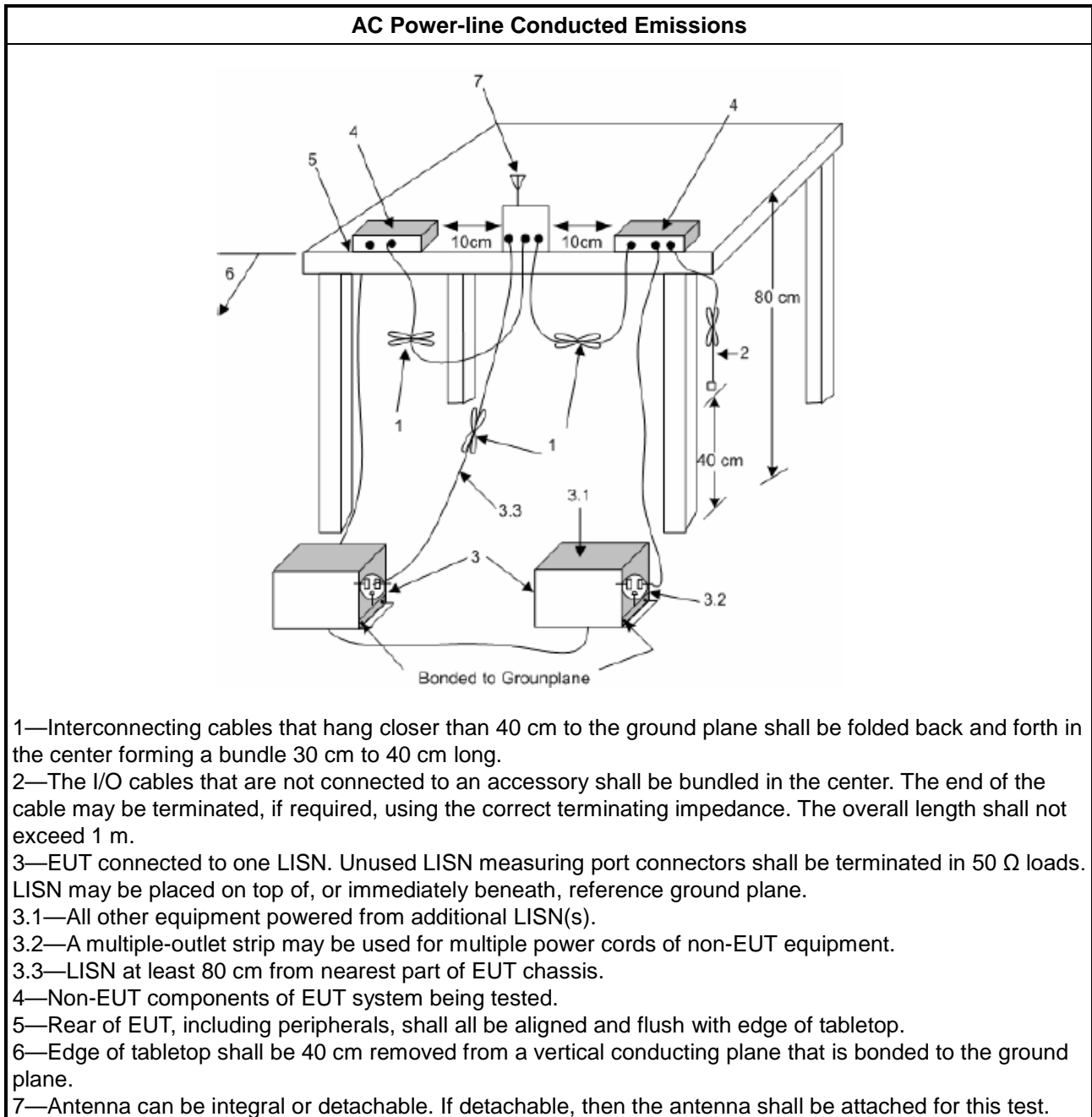

3.1.5 Test Result of AC Power-line Conducted Emissions

Refer as Appendix A



3.2 Emission Bandwidth

3.2.1 Emission Bandwidth Limit

Emission Bandwidth Limit	
UNII Devices	
<input checked="" type="checkbox"/>	For the 5.15-5.25 GHz band, N/A
<input checked="" type="checkbox"/>	For the 5.25-5.35 GHz band, the maximum conducted output power shall not exceed the lesser of 250 mW or 11 dBm + 10 log B, where B is the 26 dB emission bandwidth in MHz.
<input checked="" type="checkbox"/>	For the 5.47-5.725 GHz band, the maximum conducted output power shall not exceed the lesser of 250 mW or 11 dBm + 10 log B, where B is the 26 dB emission bandwidth in MHz.
<input checked="" type="checkbox"/>	For the 5.725-5.85 GHz band, 6 dB emission bandwidth ≥ 500kHz.
LE-LAN Devices	
<input type="checkbox"/>	For the band 5.15-5.25 GHz, the maximum e.i.r.p. shall not exceed 200 mW or 10 + 10 log B, dBm, whichever power is less. B is the 99% emission bandwidth in MHz.
<input type="checkbox"/>	For the 5.25-5.35 GHz band, the maximum e.i.r.p. shall not exceed 1.0 W or 17 + 10 log B, dBm, whichever power is less. B is the 99% emission bandwidth in MHz
<input type="checkbox"/>	For the 5.47-5.6 GHz band and 5.65-5.725 GHz band, the maximum e.i.r.p. shall not exceed 1.0 W or 17 + 10 log B, dBm, whichever power is less. B is the 99% emission bandwidth in MHz
<input type="checkbox"/>	For the 5.725-5.85 GHz band, 6 dB emission bandwidth ≥ 500kHz.

3.2.2 Measuring Instruments

Refer a test equipment and calibration data table in this test report.

3.2.3 Test Procedures

Test Method	
▪ For the emission bandwidth shall be measured using one of the options below:	
<input checked="" type="checkbox"/>	Refer as FCC KDB 789033, clause C for EBW and clause D for OBW measurement.
<input type="checkbox"/>	Refer as ANSI C63.10, clause 6.9.1 for occupied bandwidth testing.
<input type="checkbox"/>	Refer as IC RSS-Gen, clause 4.6 for bandwidth testing.

3.2.4 Test Setup

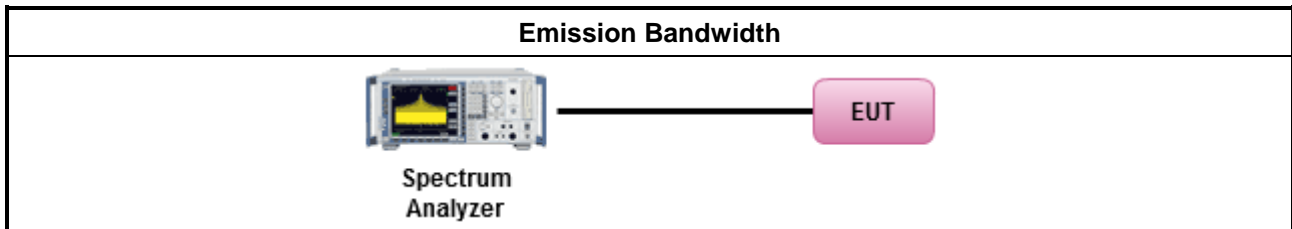

3.2.5 Test Result of Emission Bandwidth

Refer as Appendix B



3.3 Maximum Conducted Output Power

3.3.1 Maximum Conducted Output Power Limit

Maximum Conducted Output Power Limit	
UNII Devices	
<input checked="" type="checkbox"/> For the 5.15-5.25 GHz band:	
<input type="checkbox"/>	<ul style="list-style-type: none"> Outdoor AP: the maximum conducted output power (P_{Out}) shall not exceed the lesser of 1 W. If $G_{TX} > 6$ dBi, then $P_{Out} = 30 - (G_{TX} - 6)$. e.i.r.p. at any elevation angle above 30 degrees $\leq 125mW$ [21dBm] Indoor AP: the maximum conducted output power (P_{Out}) shall not exceed the lesser of 1 W. If $G_{TX} > 6$ dBi, then $P_{Out} = 30 - (G_{TX} - 6)$ Point-to-point AP: the maximum conducted output power (P_{Out}) shall not exceed the lesser of 1 W. If $G_{TX} > 23$ dBi, then $P_{Out} = 30 - (G_{TX} - 23)$. Mobile or Portable Client: the maximum conducted output power (P_{Out}) shall not exceed the lesser of 250 mW. If $G_{TX} > 6$ dBi, then $P_{Out} = 24 - (G_{TX} - 6)$.
<input checked="" type="checkbox"/> For the 5.25-5.35 GHz band, the maximum conducted output power (P_{Out}) shall not exceed the lesser of 250 mW or $11 \text{ dBm} + 10 \log B$, where B is the 26 dB emission bandwidth in MHz. If $G_{TX} > 6$ dBi, then $P_{Out} = 24 - (G_{TX} - 6)$.	
<input checked="" type="checkbox"/> For the 5.47-5.725 GHz band, the maximum conducted output power (P_{Out}) shall not exceed the lesser of 250 mW or $11 \text{ dBm} + 10 \log B$, where B is the 26 dB emission bandwidth in MHz. If $G_{TX} > 6$ dBi, then $P_{Out} = 24 - (G_{TX} - 6)$.	
<input checked="" type="checkbox"/> For the 5.725-5.85 GHz band:	
<input type="checkbox"/>	<ul style="list-style-type: none"> Point-to-multipoint systems (P2M): the maximum conducted output power (P_{Out}) shall not exceed the lesser of 1 W. If $G_{TX} > 6$ dBi, then $P_{Out} = 30 - (G_{TX} - 6)$. Point-to-point systems (P2P): the maximum conducted output power (P_{Out}) shall not exceed the lesser of 1 W.
LE-LAN Devices	
<input type="checkbox"/> For the 5.15-5.25 GHz band, the maximum e.i.r.p. shall not exceed 200 mW or $10 + 10 \log B$, dBm, whichever power is less. B is the 99% emission bandwidth in MHz.	
<input type="checkbox"/> For the 5.25-5.35 GHz band, the maximum e.i.r.p. shall not exceed 1.0 W or $17 + 10 \log B$, dBm, whichever power is less. B is the 99% emission bandwidth in MHz	
<input type="checkbox"/> For the 5.47-5.6 GHz band and 5.65-5.725 GHz band, the maximum e.i.r.p. shall not exceed 1.0 W or $17 + 10 \log B$, dBm, whichever power is less. B is the 99% emission bandwidth in MHz	
<input type="checkbox"/> For the 5.725-5.85 GHz band:	
<input type="checkbox"/>	<ul style="list-style-type: none"> Point-to-multipoint systems (P2M): the maximum conducted output power (P_{Out}) shall not exceed the lesser of 1 W. If $G_{TX} > 6$ dBi, then $P_{Out} = 30 - (G_{TX} - 6)$. Point-to-point systems (P2P): the maximum conducted output power (P_{Out}) shall not exceed the lesser of 1 W.
P_{Out} = maximum conducted output power in dBm, G_{TX} = the maximum transmitting antenna directional gain in dBi.	

3.3.2 Measuring Instruments

Refer a test equipment and calibration data table in this test report.

3.3.3 Test Procedures

Test Method	
<ul style="list-style-type: none"> Maximum Conducted Output Power 	
Average over on/off periods with duty factor	
<input checked="" type="checkbox"/>	Refer as FCC KDB 789033, clause E Method SA-2 (spectral trace averaging).
<input type="checkbox"/>	Refer as FCC KDB 789033, clause E Method SA-2 Alt. (RMS detection with slow sweep speed)
Wideband RF power meter and average over on/off periods with duty factor	
<input checked="" type="checkbox"/>	Refer as FCC KDB 789033, clause E Method PM-G (using an RF average power meter).
<ul style="list-style-type: none"> For conducted measurement. 	
<ul style="list-style-type: none"> If the EUT supports multiple transmit chains using options given below: Refer as FCC KDB 662911, In-band power measurements. Using the measure-and-sum approach, measured all transmit ports individually. Sum the power (in linear power units e.g., mW) of all ports for each individual sample and save them. 	
<ul style="list-style-type: none"> If multiple transmit chains, EIRP calculation could be following as methods: $P_{total} = P_1 + P_2 + \dots + P_n$ (calculated in linear unit [mW] and transfer to log unit [dBm]) $EIRP_{total} = P_{total} + DG$ 	

3.3.4 Test Setup

For straddle channel:

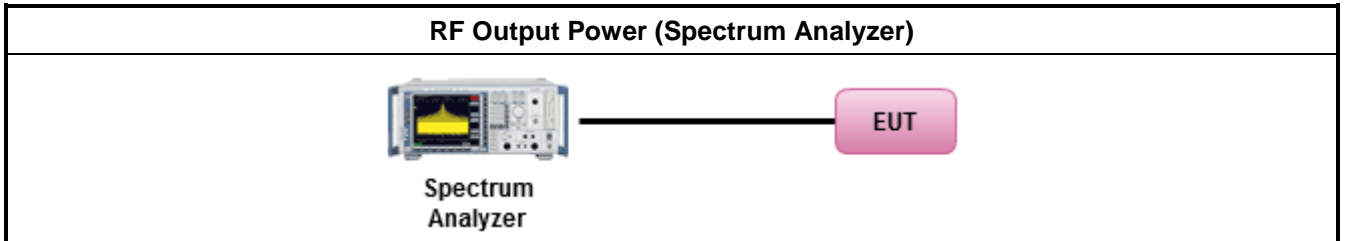

For others channel:

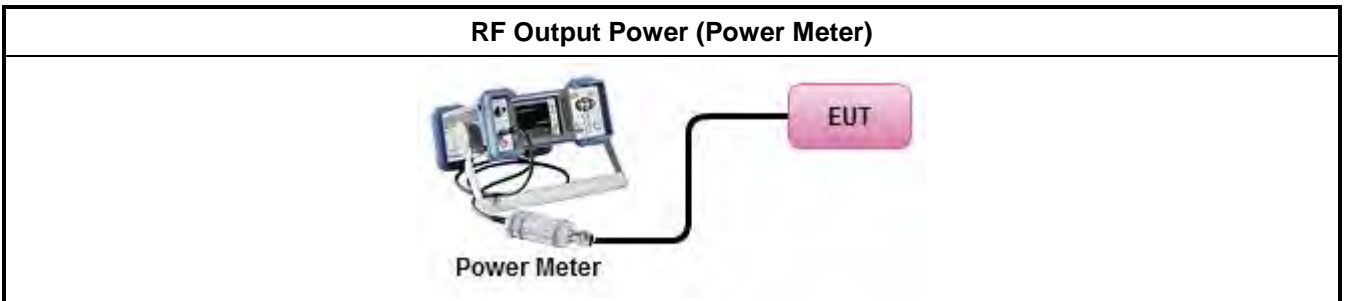

3.3.5 Test Result of Maximum Conducted Output Power

Refer as Appendix C



3.4 Peak Power Spectral Density

3.4.1 Peak Power Spectral Density Limit

Peak Power Spectral Density Limit	
UNII Devices	
<input checked="" type="checkbox"/>	For the 5.15-5.25 GHz band:
	<ul style="list-style-type: none"> ▪ Outdoor AP: the peak power spectral density (PPSD) shall not exceed the lesser of 17dBm/MHz. If $G_{TX} > 6$ dBi, then $P_{Out} = 17 - (G_{TX} - 6)$. ▪ Indoor AP: the peak power spectral density (PPSD) shall not exceed the lesser of 17dBm/MHz. If $G_{TX} > 6$ dBi, then $P_{Out} = 17 - (G_{TX} - 6)$. ▪ Point-to-point AP: the peak power spectral density (PPSD) shall not exceed the lesser of 17dBm/MHz. If $G_{TX} > 23$ dBi, then $P_{Out} = 17 - (G_{TX} - 23)$. ▪ Mobile or Portable Client: the peak power spectral density (PPSD) ≤ 11 dBm/MHz. If $G_{TX} > 6$ dBi, then $PPSD = 11 - (G_{TX} - 6)$.
<input checked="" type="checkbox"/>	For the 5.25-5.35 GHz band, the peak power spectral density (PPSD) ≤ 11 dBm/MHz. If $G_{TX} > 6$ dBi, then $PPSD = 11 - (G_{TX} - 6)$.
<input checked="" type="checkbox"/>	For the 5.47-5.725 GHz band, the peak power spectral density (PPSD) ≤ 11 dBm/MHz. If $G_{TX} > 6$ dBi, then $PPSD = 11 - (G_{TX} - 6)$.
<input checked="" type="checkbox"/>	For the 5.725-5.85 GHz band:
	<ul style="list-style-type: none"> ▪ Point-to-multipoint systems (P2M): the peak power spectral density (PPSD) ≤ 30 dBm/500kHz. If $G_{TX} > 6$ dBi, then $PPSD = 30 - (G_{TX} - 6)$. ▪ Point-to-point systems (P2P): the peak power spectral density (PPSD) ≤ 30 dBm/500kHz.
LE-LAN Devices	
<input type="checkbox"/>	For the 5.15-5.25 GHz band, the e.i.r.p. peak power spectral density (PPSD) ≤ 10 dBm/MHz.
<input type="checkbox"/>	For the 5.25-5.35 GHz band, the peak power spectral density (PPSD) ≤ 11 dBm/MHz.
	<ul style="list-style-type: none"> ▪ e.i.r.p. greater than 200 mW shall comply with the following e.i.r.p. at different elevations, where θ is the angle above the local horizontal plane (of the Earth) as shown below: -13 dBW/MHz for $0^\circ \leq \theta < 8^\circ$; -13 - 0.716 (θ-8) dBW/MHz for $8^\circ \leq \theta < 40^\circ$ -35.9 - 1.22 (θ-40) dBW/MHz for $40^\circ \leq \theta \leq 45^\circ$; -42 dBW/MHz for $\theta > 45^\circ$
<input type="checkbox"/>	For the 5.47-5.6 GHz band and 5.65-5.725 GHz band, the peak power spectral density (PPSD) ≤ 11 dBm/MHz.
<input type="checkbox"/>	For the 5.725-5.85 GHz band:
	<ul style="list-style-type: none"> ▪ Point-to-multipoint systems (P2M): the peak power spectral density (PPSD) ≤ 30 dBm/500kHz. If $G_{TX} > 6$ dBi, then $PPSD = 30 - (G_{TX} - 6)$. ▪ Point-to-point systems (P2P): the peak power spectral density (PPSD) ≤ 30 dBm/500kHz.
PPSD = peak power spectral density that he same method as used to determine the conducted output power shall be used to determine the power spectral density. And power spectral density in dBm/MHz G_{TX} = the maximum transmitting antenna directional gain in dBi.	

3.4.2 Measuring Instruments

Refer a test equipment and calibration data table in this test report.



3.4.3 Test Procedures

Test Method	
<ul style="list-style-type: none"> ▪ Peak power spectral density procedures that the same method as used to determine the conducted output power shall be used to determine the peak power spectral density and use the peak search function on the spectrum analyzer to find the peak of the spectrum. For the peak power spectral density shall be measured using below options: 	
<input type="checkbox"/>	Refer as FCC KDB 789033, F5) power spectral density can be measured using resolution bandwidths < 1 MHz provided that the results are integrated over 1 MHz bandwidth
[duty cycle ≥ 98% or external video / power trigger]	
<input checked="" type="checkbox"/>	Refer as FCC KDB 789033, clause E Method SA-1 (spectral trace averaging).
<input type="checkbox"/>	Refer as FCC KDB 789033, clause E Method SA-1 Alt. (RMS detection with slow sweep speed)
duty cycle < 98% and average over on/off periods with duty factor	
<input checked="" type="checkbox"/>	Refer as FCC KDB 789033, clause E Method SA-2 (spectral trace averaging).
<input type="checkbox"/>	Refer as FCC KDB 789033, clause E Method SA-2 Alt. (RMS detection with slow sweep speed)
<ul style="list-style-type: none"> ▪ For conducted measurement. 	
<ul style="list-style-type: none"> ▪ If the EUT supports multiple transmit chains using options given below: 	
<input type="checkbox"/>	Option 1: Measure and sum the spectra across the outputs. Refer as FCC KDB 662911, In-band power spectral density (PSD). Sample all transmit ports simultaneously using a spectrum analyzer for each transmit port. Where the trace bin-by-bin of each transmit port summing can be performed. (i.e., in the first spectral bin of output 1 is summed with that in the first spectral bin of output 2 and that from the first spectral bin of output 3, and so on up to the NTX output to obtain the value for the first frequency bin of the summed spectrum.). Add up the amplitude (power) values for the different transmit chains and use this as the new data trace.
<input type="checkbox"/>	Option 2: Measure and sum spectral maxima across the outputs. With this technique, spectra are measured at each output of the device at the required resolution bandwidth. The maximum value (peak) of each spectrum is determined. These maximum values are then summed mathematically in linear power units across the outputs. These operations shall be performed separately over frequency spans that have different out-of-band or spurious emission limits,
<input type="checkbox"/>	Option 3: Measure and add 10 log(N) dB, where N is the number of transmit chains. Refer as FCC KDB 662911, In-band power spectral density (PSD). Performed at each transmit chains and each transmit chains shall be compared with the limit have been reduced with 10 log(N). Or each transmit chains shall be add 10 log(N) to compared with the limit.
<ul style="list-style-type: none"> ▪ If multiple transmit chains, EIRP PPSD calculation could be following as methods: $PPSD_{total} = PPSD_1 + PPSD_2 + \dots + PPSD_n$ (calculated in linear unit [mW] and transfer to log unit [dBm]) $EIRP_{total} = PPSD_{total} + DG$ 	

3.4.4 Test Setup

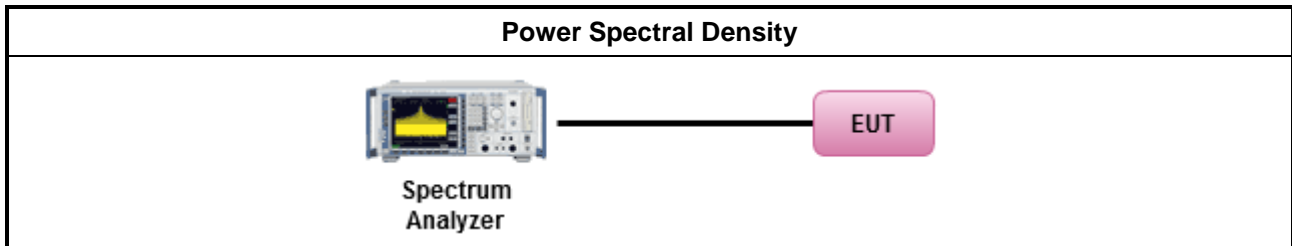

3.4.5 Test Result of Peak Power Spectral Density

Refer as Appendix D



3.5 Unwanted Emissions

3.5.1 Transmitter Unwanted Emissions Limit

Unwanted emissions below 1 GHz and restricted band emissions above 1GHz limit			
Frequency Range (MHz)	Field Strength (uV/m)	Field Strength (dBuV/m)	Measure Distance (m)
0.009~0.490	2400/F(kHz)	48.5 - 13.8	300
0.490~1.705	24000/F(kHz)	33.8 - 23	30
1.705~30.0	30	29	30
30~88	100	40	3
88~216	150	43.5	3
216~960	200	46	3
Above 960	500	54	3

Note 1: Test distance for frequencies at or above 30 MHz, measurements may be performed at a distance other than the limit distance provided they are not performed in the near field and the emissions to be measured can be detected by the measurement equipment. When performing measurements at a distance other than that specified, the results shall be extrapolated to the specified distance using an extrapolation factor of 20 dB/decade (inverse of linear distance for field-strength measurements, inverse of linear distance-squared for power-density measurements).

Note 2: Test distance for frequencies at below 30 MHz, measurements may be performed at a distance closer than the EUT limit distance; however, an attempt should be made to avoid making measurements in the near field. When performing measurements below 30 MHz at a closer distance than the limit distance, the results shall be extrapolated to the specified distance by either making measurements at a minimum of two or more distances on at least one radial to determine the proper extrapolation factor or by using the square of an inverse linear distance extrapolation factor (40 dB/decade). The test report shall specify the extrapolation method used to determine compliance of the EUT.

Note 3: Using the distance of 1m during the test for above 18 GHz, and the test value to correct for the distance factor at 3m.

Un-restricted band emissions above 1GHz Limit	
Operating Band	Limit
<input checked="" type="checkbox"/> 5.15 - 5.25 GHz	e.i.r.p. -27 dBm [68.2 dBuV/m @3m]
<input checked="" type="checkbox"/> 5.25 - 5.35 GHz	e.i.r.p. -27 dBm [68.2 dBuV/m @3m]
<input checked="" type="checkbox"/> 5.47 - 5.725 GHz	e.i.r.p. -27 dBm [68.2 dBuV/m @3m]
<input checked="" type="checkbox"/> 5.725 - 5.85 GHz	all emissions shall be limited to a level of -27 dBm/MHz at 75 MHz or more above or below the band edge increasing linearly to 10 dBm/MHz at 25 MHz above or below the band edge, and from 25 MHz above or below the band edge increasing linearly to a level of 15.6 dBm/MHz at 5 MHz above or below the band edge, and from 5 MHz above or below the band edge increasing linearly to a level of 27 dBm/MHz at the band edge.

Note 1: Measurements may be performed at a distance other than the limit distance provided they are not performed in the near field and the emissions to be measured can be detected by the measurement equipment. When performing measurements at a distance other than that specified, the results shall be extrapolated to the specified distance using an extrapolation factor of 20 dB/decade (inverse of



linear distance for field-strength measurements, inverse of linear distance-squared for power-density measurements).

3.5.2 Measuring Instruments

Refer a test equipment and calibration data table in this test report.

3.5.3 Test Procedures

Test Method	
	<ul style="list-style-type: none"> ▪ Measurements may be performed at a distance other than the limit distance provided they are not performed in the near field and the emissions to be measured can be detected by the measurement equipment. Measurements shall not be performed at a distance greater than 30 m for frequencies above 30 MHz, unless it can be further demonstrated that measurements at a distance of 30 m or less are impractical. When performing measurements at a distance other than that specified, the results shall be extrapolated to the specified distance using an extrapolation factor of 20 dB/decade (inverse of linear distance for field-strength measurements, inverse of linear distance-squared for power-density measurements).
	<ul style="list-style-type: none"> ▪ The average emission levels shall be measured in [duty cycle ≥ 98 or duty factor].
	<ul style="list-style-type: none"> ▪ For the transmitter unwanted emissions shall be measured using following options below: <ul style="list-style-type: none"> ▪ Refer as FCC KDB 789033, clause G)2) for unwanted emissions into non-restricted bands. ▪ Refer as FCC KDB 789033, clause G)1) for unwanted emissions into restricted bands. <ul style="list-style-type: none"> <input type="checkbox"/> Refer as FCC KDB 789033, G)6) Method AD (Trace Averaging). <input checked="" type="checkbox"/> Refer as FCC KDB 789033, G)6) Method VB (Reduced VBW). <input type="checkbox"/> Refer as ANSI C63.10, clause 11.12.2.5.3 (Reduced VBW). VBW ≥ 1/T, where T is pulse time. <input type="checkbox"/> Refer as ANSI C63.10, clause 7.5 average value of pulsed emissions. <input checked="" type="checkbox"/> Refer as FCC KDB 789033, clause G)5) measurement procedure peak limit. <input type="checkbox"/> Refer as ANSI C63.10, clause 4.1.4.2.2 measurement procedure peak limit.
	<ul style="list-style-type: none"> ▪ For radiated measurement. <ul style="list-style-type: none"> ▪ Refer as ANSI C63.10, clause 6.4 for radiated emissions below 30 MHz and test distance is 3m. ▪ Refer as ANSI C63.10, clause 6.5 for radiated emissions 30 MHz to 1 GHz and test distance is 3m. ▪ Refer as ANSI C63.10, clause 6.6 for radiated emissions above 1GHz.
	<ul style="list-style-type: none"> ▪ The any unwanted emissions level shall not exceed the fundamental emission level.
	<ul style="list-style-type: none"> ▪ All amplitude of spurious emissions that are attenuated by more than 20 dB below the permissible value has no need to be reported.

3.5.4 Test Setup

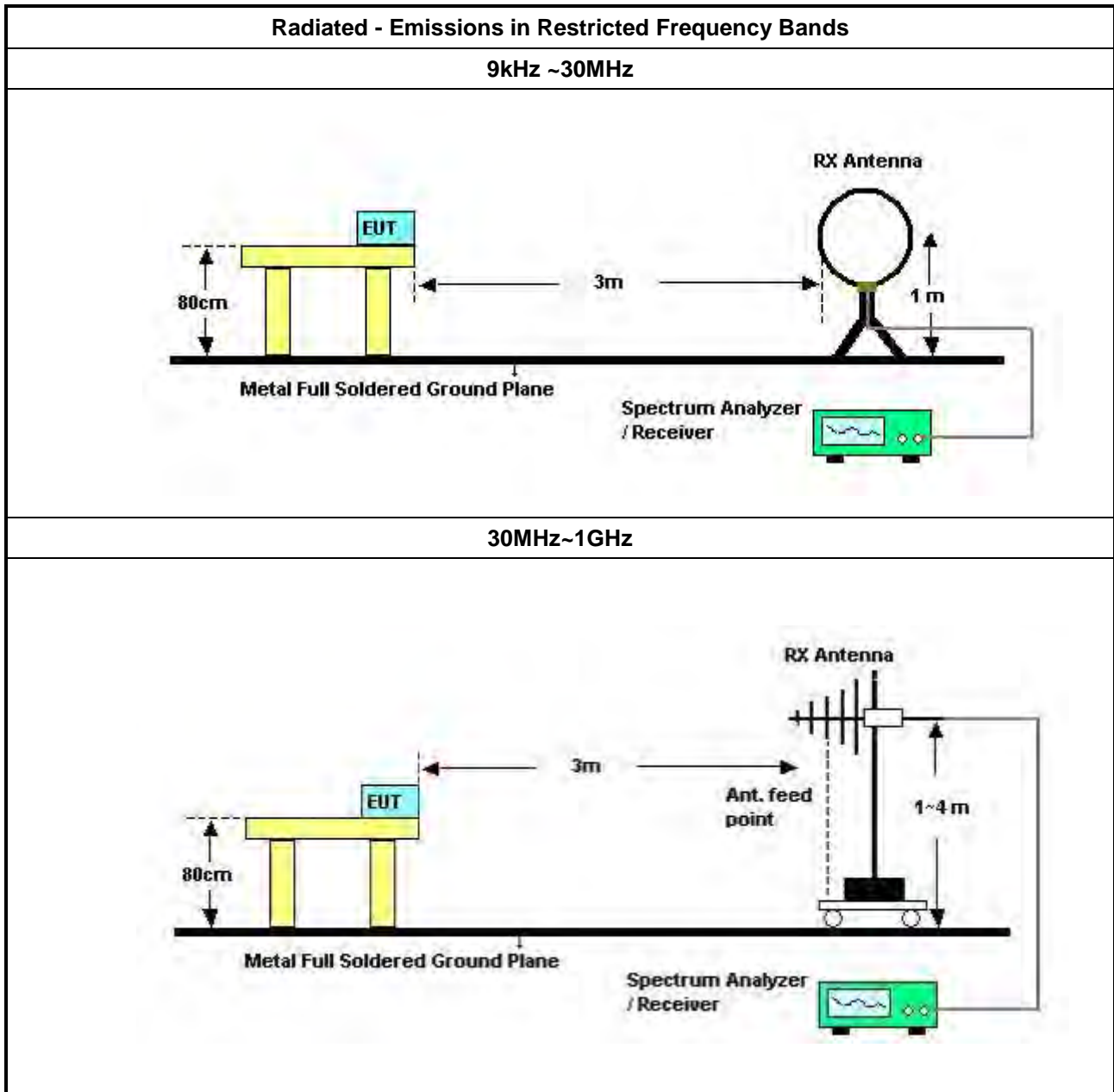



4 Test Equipment and Calibration Data

Instrument	Manufacturer	Model No.	Serial No.	Characteristics	Calibration Date	Calibration Due Date	Remark
EMI Receiver	Agilent	N9038A	My52260123	9kHz ~ 8.45GHz	Feb. 26, 2020	Feb. 25, 2021	Conduction (CO01-CB)
LISN	F.C.C.	FCC-LISN-50-16-2	04083	150kHz ~ 100MHz	Dec. 25, 2019	Dec. 24, 2020	Conduction (CO01-CB)
LISN	Schwarzbeck	NSLK 8127	8127647	9kHz ~ 30MHz	Feb. 25, 2020	Feb. 24, 2021	Conduction (CO01-CB)
COND Cable	Woken	Cable	Low cable-CO01	9kHz ~ 30MHz	May 21, 2019	May 20, 2020	Conduction (CO01-CB)
Software	Audix	E3	6.120210n	-	N.C.R.	N.C.R.	Conduction (CO01-CB)
Loop Antenna	Teseq	HLA 6120	24155	9kHz - 30 MHz	Mar. 29, 2019	Mar. 28, 2020	Radiation (03CH04-CB)
Loop Antenna	Teseq	HLA 6120	24155	9kHz - 30 MHz	Apr. 13, 2020	Apr. 12, 2021	Radiation (03CH04-CB)
BILOG ANTENNA with 6 dB attenuator	Schaffner & EMCI	CBL6112B & N-6-06	22021&AT-N06 07	30MHz ~ 1GHz	Oct. 12, 2019	Oct. 11, 2020	Radiation (03CH04-CB)
Pre-Amplifier	Agilent	310N	187291	0.1MHz ~ 1GHz	Mar. 19, 2020	Mar. 18, 2021	Radiation (03CH04-CB)
Spectrum Analyzer	R&S	FSP40	100142	9kHz~40GHz	Dec. 18, 2019	Dec. 17, 2020	Radiation (03CH04-CB)
EMI Test Receiver	R&S	ESCS	826547/017	9kHz ~ 2.75GHz	May 15, 2019	May 14, 2020	Radiation (03CH04-CB)
RF Cable-low	Woken	RG402	Low Cable-03+22	30MHz ~ 1GHz	Oct. 07, 2019	Oct. 06, 2020	Radiation (03CH04-CB)
Horn Antenna	ETS · Lindgren	3115	6821	750MHz~18GHz	Jan. 20, 2020	Jan. 19, 2021	Radiation (03CH03-CB)
Horn Antenna	Schwarzbeck	BBHA 9170	BBHA9170252	15GHz ~ 40GHz	Jun. 27, 2019	Jun. 26, 2020	Radiation (03CH03-CB)
Pre-Amplifier	Agilent	8449B	3008A02097	1GHz ~ 26.5GHz	Dec. 19, 2019	Dec. 18, 2020	Radiation (03CH03-CB)
Pre-Amplifier	MITEQ	TTA1840-35-H G	1864479	18GHz ~ 40GHz	Jul. 03, 2019	Jul. 02, 2020	Radiation (03CH03-CB)
Spectrum Analyzer	R&S	FSP40	100019	9kHz ~ 40GHz	Jun. 19, 2019	Jun. 18, 2020	Radiation (03CH03-CB)
RF Cable-high	Woken	RG402	High Cable-20+27	1GHz ~ 18GHz	Oct. 07, 2019	Oct. 06, 2020	Radiation (03CH03-CB)



Instrument	Manufacturer	Model No.	Serial No.	Characteristics	Calibration Date	Calibration Due Date	Remark
RF Cable-high	Woken	RG402	High Cable-27	1GHz ~ 18GHz	Oct. 07, 2019	Oct. 06, 2020	Radiation (03CH03-CB)
RF Cable-high	Woken	RG402	High Cable-40G#1	18GHz ~ 40 GHz	Jul. 24, 2019	Jul. 23, 2020	Radiation (03CH03-CB)
RF Cable-high	Woken	RG402	High Cable-40G#2	18GHz ~ 40 GHz	Jul. 24, 2019	Jul. 23, 2020	Radiation (03CH03-CB)
Spectrum analyzer	R&S	FSV40	101028	9kHz~40GHz	Nov. 01, 2019	Oct. 31, 2020	Conducted (TH03-CB)
Power Sensor	Anritsu	MA2411B	1726195	300MHz~40GHz	Aug. 13, 2019	Aug. 12, 2020	Conducted (TH03-CB)
Power Meter	Anritsu	ML2495A	1035008	300MHz~40GHz	Aug. 13, 2019	Aug. 12, 2020	Conducted (TH03-CB)
RF Cable-high	Woken	RG402	High Cable-11	1 GHz – 26.5 GHz	Oct. 07, 2019	Oct. 06, 2020	Conducted (TH03-CB)
RF Cable-high	Woken	RG402	High Cable-12	1 GHz – 26.5 GHz	Oct. 07, 2019	Oct. 06, 2020	Conducted (TH03-CB)
RF Cable-high	Woken	RG402	High Cable-13	1 GHz – 26.5 GHz	Oct. 07, 2019	Oct. 06, 2020	Conducted (TH03-CB)
RF Cable-high	Woken	RG402	High Cable-14	1 GHz – 26.5 GHz	Oct. 07, 2019	Oct. 06, 2020	Conducted (TH03-CB)
RF Cable-high	Woken	RG402	High Cable-15	1 GHz – 26.5 GHz	Oct. 07, 2019	Oct. 06, 2020	Conducted (TH03-CB)

Note: Calibration Interval of instruments listed above is one year.

NCR means Non-Calibration required.



AC Power-line Conducted Emissions Result

Appendix A

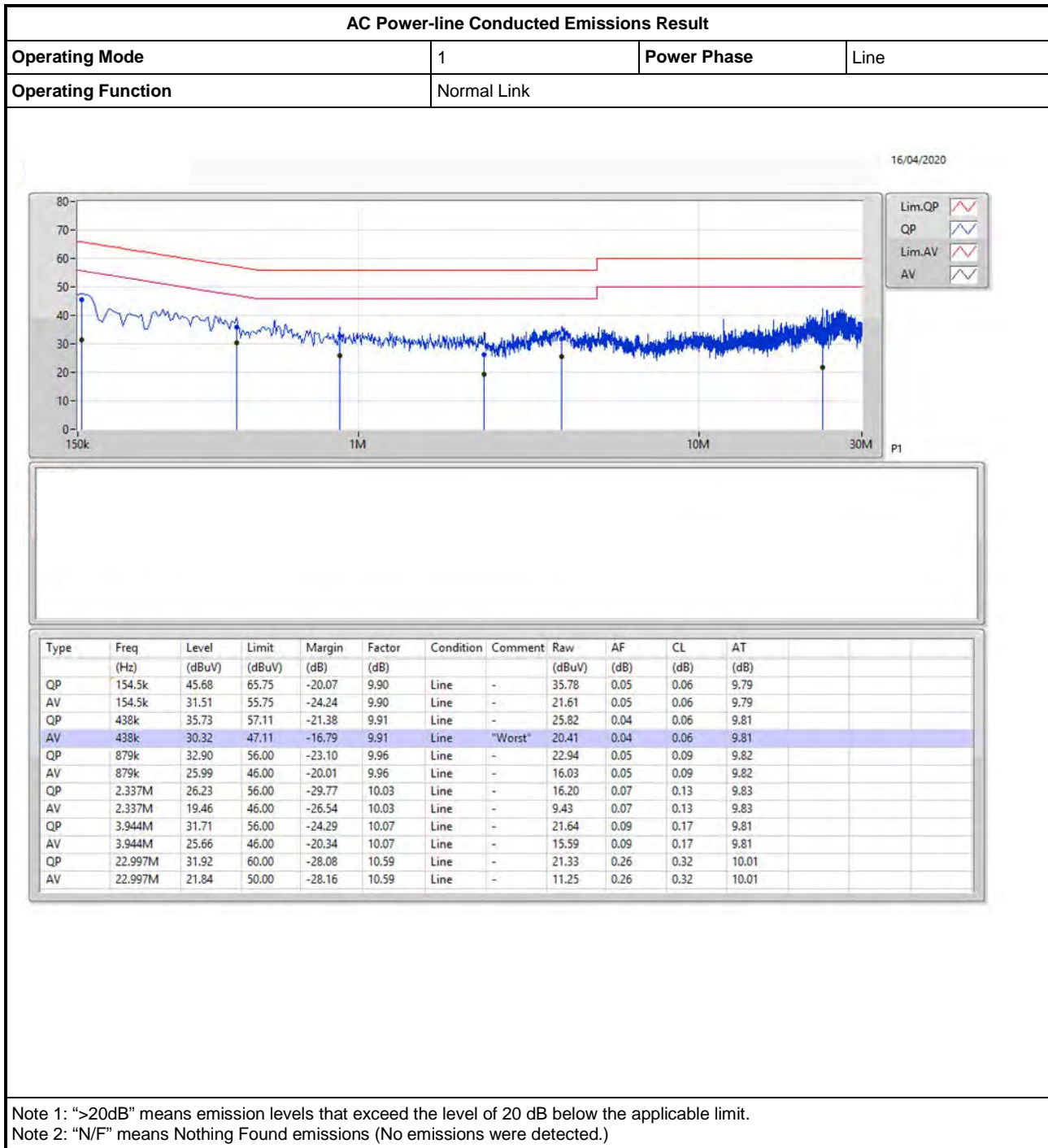



AC Power-line Conducted Emissions Result

Appendix A

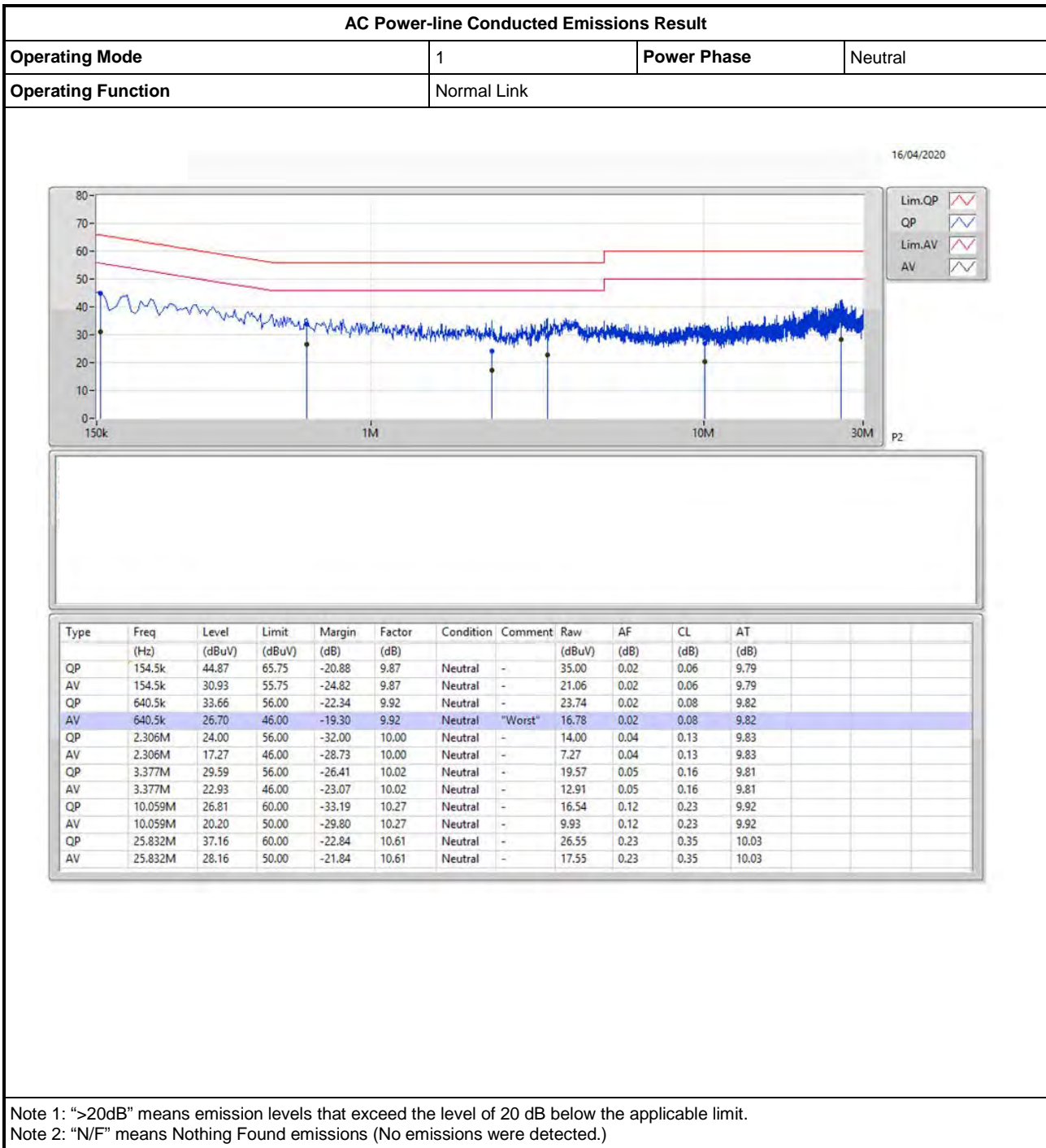

Summary

Mode	Max-N dB (Hz)	Max-OBW (Hz)	ITU-Code	Min-N dB (Hz)	Min-OBW (Hz)
5.15-5.25GHz	-	-	-	-	-
802.11a_Nss1,(6Mbps)_1TX	33.96M	20.69M	20M7D1D	21.18M	16.702M
802.11ac VHT20_Nss1,(MCS0)_1TX	31.86M	18.681M	18M7D1D	22.56M	17.841M
802.11ac VHT40_Nss1,(MCS0)_1TX	64.02M	37.061M	37M1D1D	39.9M	36.342M
802.11ac VHT80_Nss1,(MCS0)_1TX	81.36M	75.562M	75M6D1D	81.36M	75.562M
5.25-5.35GHz	-	-	-	-	-
802.11a_Nss1,(6Mbps)_1TX	31.68M	18.231M	18M2D1D	23.91M	17.001M
802.11ac VHT20_Nss1,(MCS0)_1TX	34.89M	19.31M	19M3D1D	27.93M	18.081M
802.11ac VHT40_Nss1,(MCS0)_1TX	73.8M	38.321M	38M3D1D	40.14M	36.342M
802.11ac VHT80_Nss1,(MCS0)_1TX	81.72M	75.562M	75M6D1D	81.72M	75.562M
5.47-5.725GHz	-	-	-	-	-
802.11a_Nss1,(6Mbps)_1TX	33.15M	19.01M	19M0D1D	21.12M	16.702M
802.11ac VHT20_Nss1,(MCS0)_1TX	33.57M	18.771M	18M8D1D	21.96M	17.841M
802.11ac VHT40_Nss1,(MCS0)_1TX	72.54M	37.481M	37M5D1D	40.08M	36.402M
802.11ac VHT80_Nss1,(MCS0)_1TX	150.12M	76.882M	76M9D1D	81.72M	73.123M
5.725-5.85GHz	-	-	-	-	-
802.11a_Nss1,(6Mbps)_1TX	16.32M	30.555M	30M6D1D	15.42M	29.655M
802.11ac VHT20_Nss1,(MCS0)_1TX	17.22M	33.163M	33M2D1D	16.68M	31.994M
802.11ac VHT40_Nss1,(MCS0)_1TX	36.24M	66.087M	66M1D1D	35.1M	60.03M
802.11ac VHT80_Nss1,(MCS0)_1TX	75.24M	77.121M	77M1D1D	2.685M	27.301M

Max-N dB = Maximum 6dB down bandwidth for 5.725-5.85GHz band / Maximum 26dB down bandwidth for other band;

Max-OBW = Maximum 99% occupied bandwidth;

Min-N dB = Minimum 6dB down bandwidth for 5.725-5.85GHz band / Maximum 26dB down bandwidth for other band;

Min-OBW = Minimum 99% occupied bandwidth;



Result

Mode	Result	Limit (Hz)	Port 1-N dB (Hz)	Port 1-OBW (Hz)
802.11a_Nss1,(6Mbps)_1TX	-	-	-	-
5180MHz	Pass	Inf	21.18M	16.702M
5200MHz	Pass	Inf	33.96M	20.69M
5240MHz	Pass	Inf	32.07M	18.501M
5260MHz	Pass	Inf	31.02M	18.231M
5300MHz	Pass	Inf	31.68M	18.111M
5320MHz	Pass	Inf	23.91M	17.001M
5500MHz	Pass	Inf	21.12M	16.702M
5580MHz	Pass	Inf	33.15M	19.01M
5700MHz	Pass	Inf	22.77M	16.852M
5745MHz	Pass	500k	15.42M	30.555M
5785MHz	Pass	500k	15.78M	29.655M
5825MHz	Pass	500k	16.32M	29.835M
802.11ac VHT20_Nss1,(MCS0)_1TX	-	-	-	-
5180MHz	Pass	Inf	22.56M	17.841M
5200MHz	Pass	Inf	31.86M	18.681M
5240MHz	Pass	Inf	31.56M	18.621M
5260MHz	Pass	Inf	34.89M	19.31M
5300MHz	Pass	Inf	30.9M	18.531M
5320MHz	Pass	Inf	27.93M	18.081M
5500MHz	Pass	Inf	21.96M	17.841M
5580MHz	Pass	Inf	33.57M	18.771M
5700MHz	Pass	Inf	27.21M	18.021M
5745MHz	Pass	500k	17.22M	33.163M
5785MHz	Pass	500k	16.98M	32.114M
5825MHz	Pass	500k	16.68M	31.994M
802.11ac VHT40_Nss1,(MCS0)_1TX	-	-	-	-
5190MHz	Pass	Inf	39.9M	36.342M
5230MHz	Pass	Inf	64.02M	37.061M
5270MHz	Pass	Inf	73.8M	38.321M
5310MHz	Pass	Inf	40.14M	36.342M
5510MHz	Pass	Inf	40.08M	36.402M
5550MHz	Pass	Inf	72.54M	37.481M
5670MHz	Pass	Inf	62.1M	36.822M
5755MHz	Pass	500k	36.24M	60.03M
5795MHz	Pass	500k	35.1M	66.087M
802.11ac VHT80_Nss1,(MCS0)_1TX	-	-	-	-
5210MHz	Pass	Inf	81.36M	75.562M
5290MHz	Pass	Inf	81.72M	75.562M
5530MHz	Pass	Inf	81.72M	75.562M
5610MHz	Pass	Inf	150.12M	76.882M



Mode	Result	Limit (Hz)	Port 1-N dB (Hz)	Port 1-OBW (Hz)
5690MHz Straddle 5.47-5.725GHz	Pass	Inf	117.955M	73.123M
5690MHz Straddle 5.725-5.85GHz	Pass	500k	2.685M	27.301M
5775MHz	Pass	500k	75.24M	77.121M

Port X-N dB = Port X 6dB down bandwidth for 5.725-5.85GHz band / 26dB down bandwidth for other band
Port X-OBW = Port X 99% occupied bandwidth;

802.11a_Nss1,(6Mbps)_1TX

EBW

5180MHz

25/03/2020

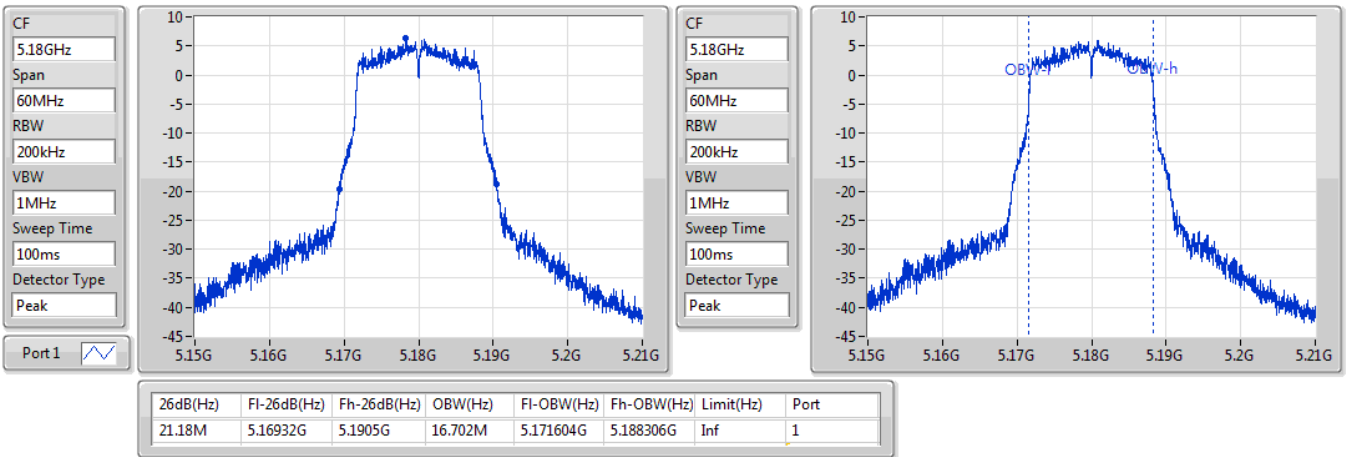

802.11a_Nss1,(6Mbps)_1TX

EBW

5200MHz

25/03/2020

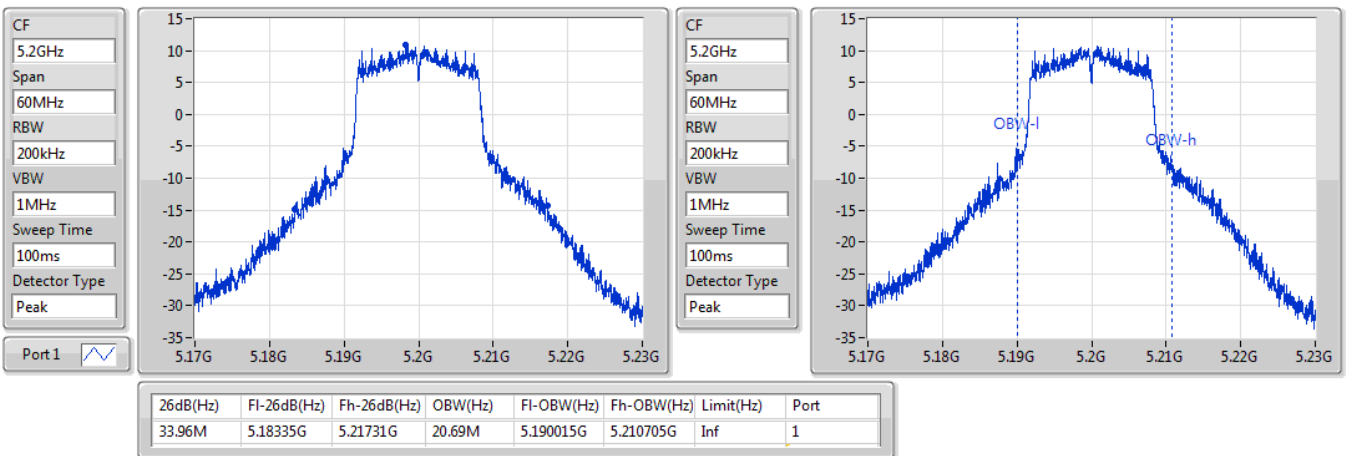

802.11a_Nss1,(6Mbps)_1TX

EBW

5240MHz

25/03/2020

CF: 5.24GHz
 Span: 60MHz
 RBW: 200kHz
 VBW: 1MHz
 Sweep Time: 100ms
 Detector Type: Peak
 Port 1

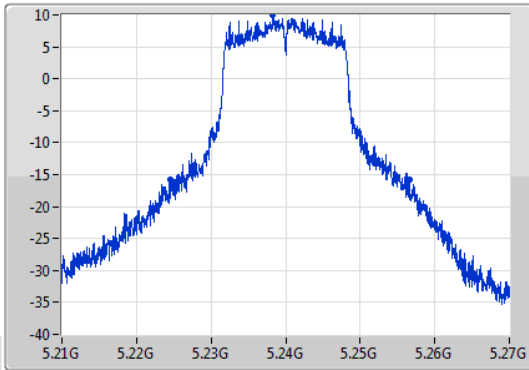

CF: 5.24GHz
 Span: 60MHz
 RBW: 200kHz
 VBW: 1MHz
 Sweep Time: 100ms
 Detector Type: Peak

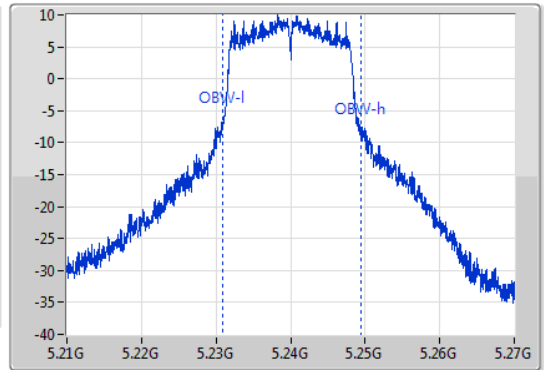

26dB(Hz)	Fl-26dB(Hz)	Fh-26dB(Hz)	OBW(Hz)	Fl-OBW(Hz)	Fh-OBW(Hz)	Limit(Hz)	Port
32.07M	5.22452G	5.25659G	18.501M	5.230975G	5.249475G	Inf	1

802.11a_Nss1,(6Mbps)_1TX

EBW

5260MHz

25/03/2020

CF: 5.26GHz
 Span: 60MHz
 RBW: 200kHz
 VBW: 1MHz
 Sweep Time: 100ms
 Detector Type: Peak
 Port 1

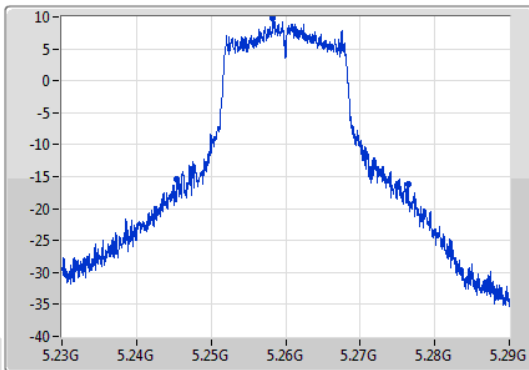

CF: 5.26GHz
 Span: 60MHz
 RBW: 200kHz
 VBW: 1MHz
 Sweep Time: 100ms
 Detector Type: Peak

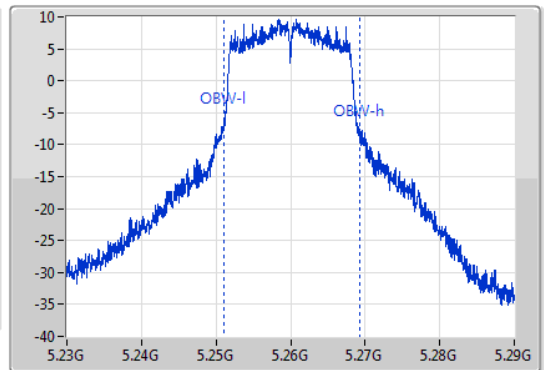

26dB(Hz)	Fl-26dB(Hz)	Fh-26dB(Hz)	OBW(Hz)	Fl-OBW(Hz)	Fh-OBW(Hz)	Limit(Hz)	Port
31.02M	5.24545G	5.27647G	18.231M	5.251004G	5.269235G	Inf	1

802.11a_Nss1,(6Mbps)_1TX

EBW

5300MHz

25/03/2020

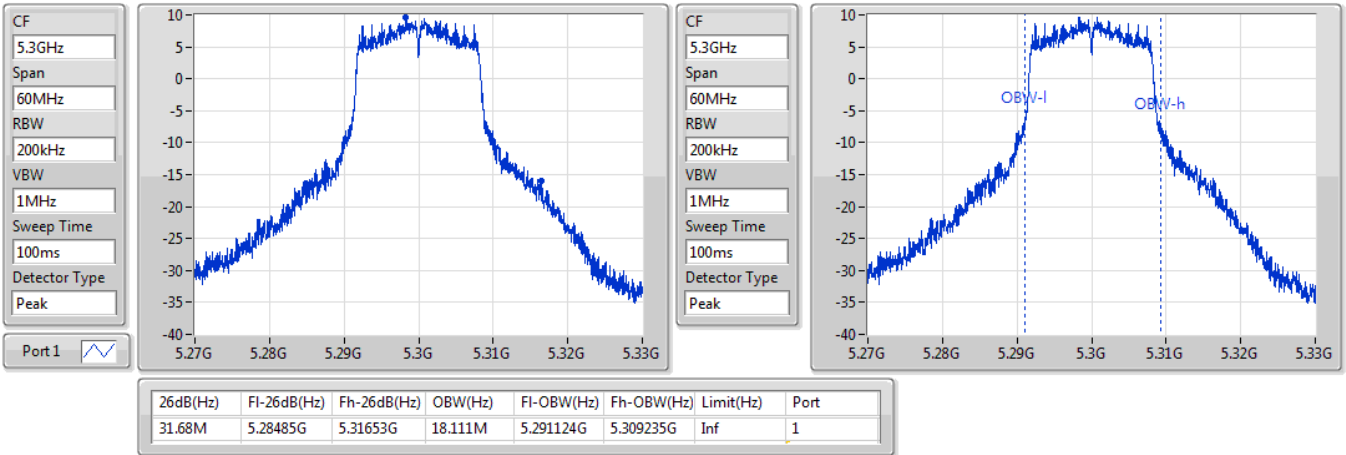

802.11a_Nss1,(6Mbps)_1TX

EBW

5320MHz

25/03/2020

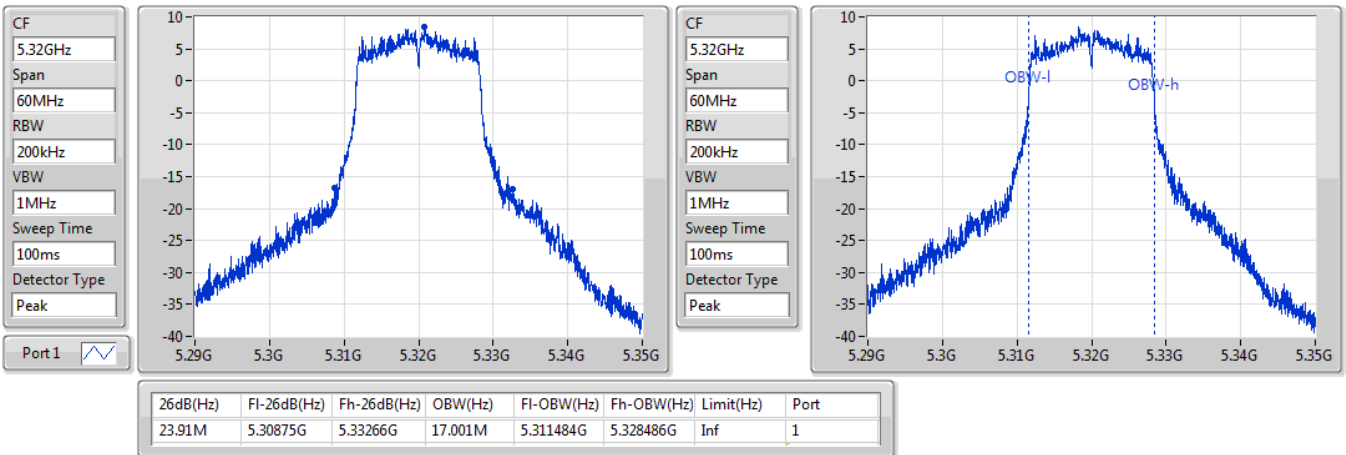

802.11a_Nss1,(6Mbps)_1TX

EBW

5500MHz

25/03/2020

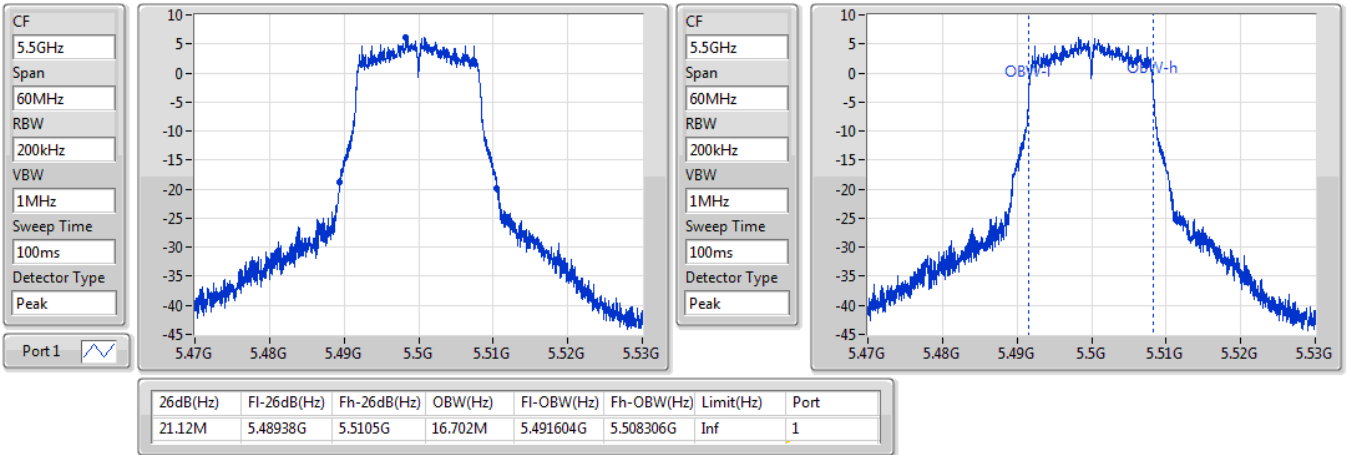

802.11a_Nss1,(6Mbps)_1TX

EBW

5580MHz

25/03/2020

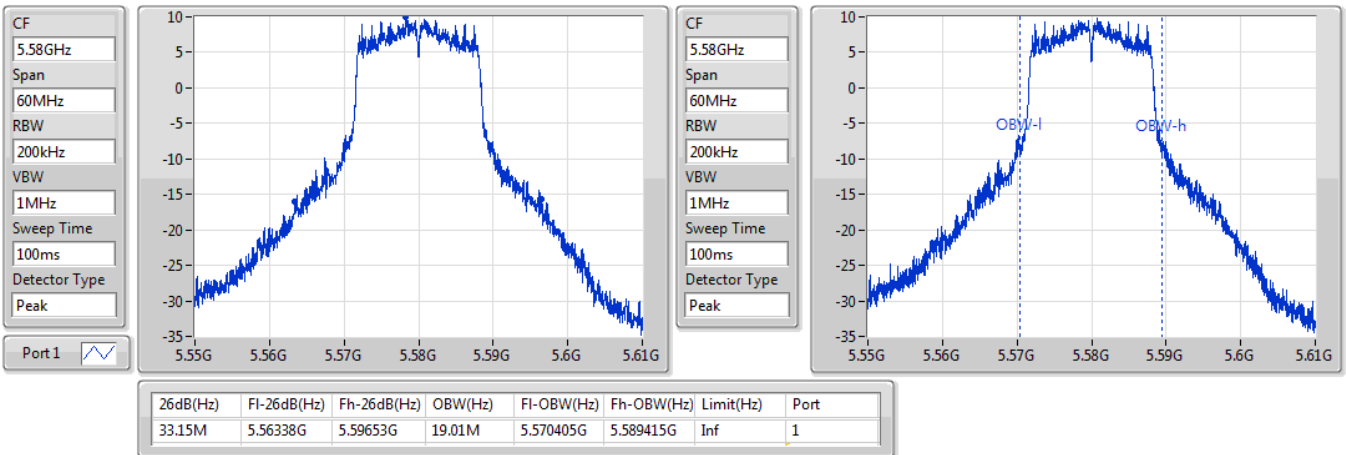

802.11a_Nss1,(6Mbps)_1TX

EBW

5700MHz

25/03/2020

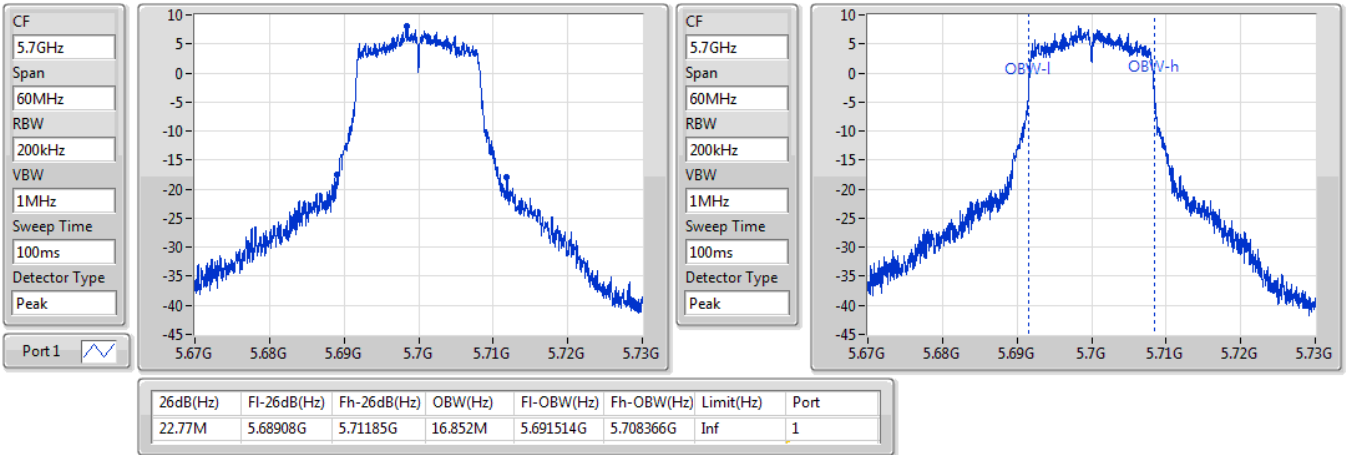

802.11a_Nss1,(6Mbps)_1TX

EBW

5745MHz

25/03/2020

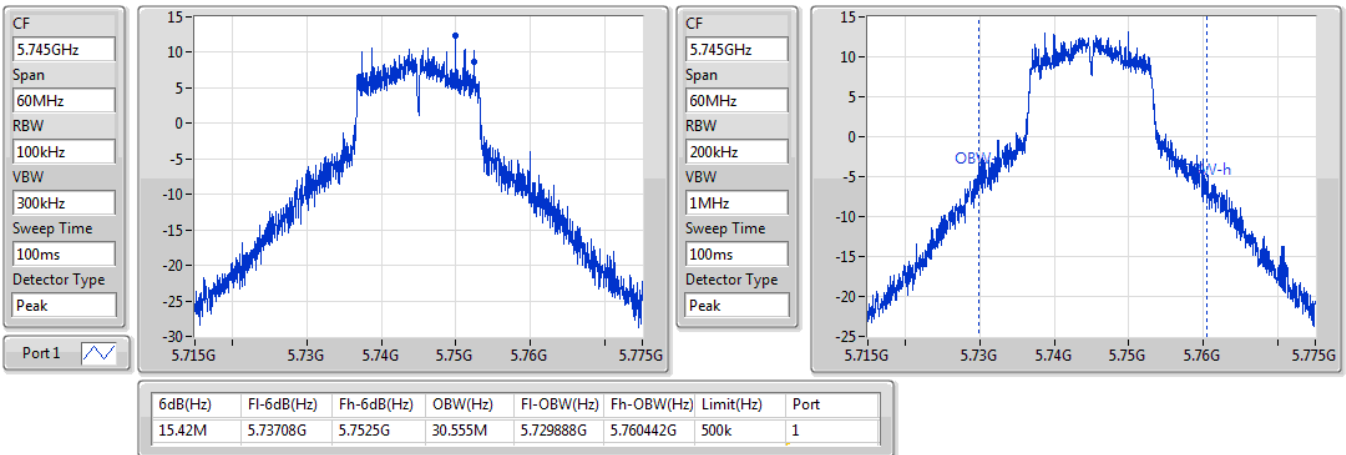

802.11a_Nss1,(6Mbps)_1TX

EBW

5785MHz

25/03/2020

CF
5.785GHz
Span
60MHz
RBW
100kHz
VBW
300kHz
Sweep Time
100ms
Detector Type
Peak
Port 1

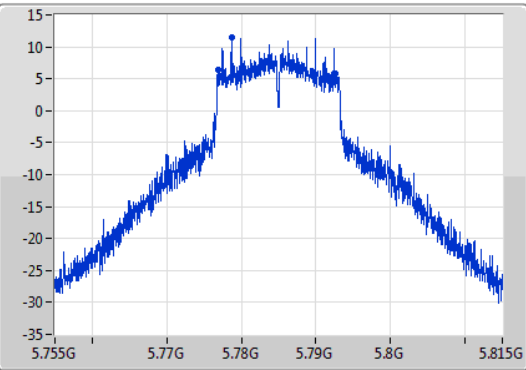

CF
5.785GHz
Span
60MHz
RBW
200kHz
VBW
1MHz
Sweep Time
100ms
Detector Type
Peak

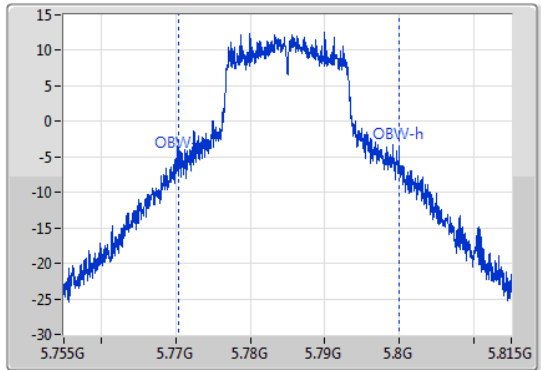

6dB(Hz)	Fl-6dB(Hz)	Fh-6dB(Hz)	OBW(Hz)	Fl-OBW(Hz)	Fh-OBW(Hz)	Limit(Hz)	Port
15.78M	5.77684G	5.79262G	29.655M	5.770307G	5.799963G	500k	1

802.11a_Nss1,(6Mbps)_1TX

EBW

5825MHz

25/03/2020

CF
5.825GHz
Span
60MHz
RBW
100kHz
VBW
300kHz
Sweep Time
100ms
Detector Type
Peak
Port 1

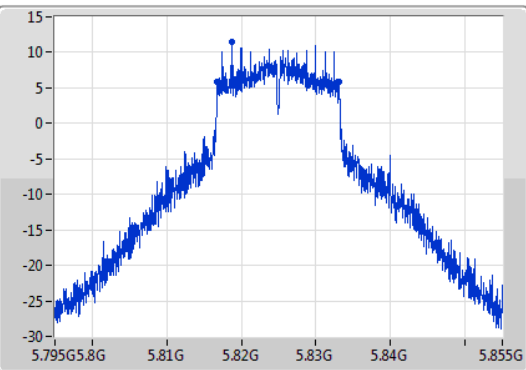

CF
5.825GHz
Span
60MHz
RBW
200kHz
VBW
1MHz
Sweep Time
100ms
Detector Type
Peak

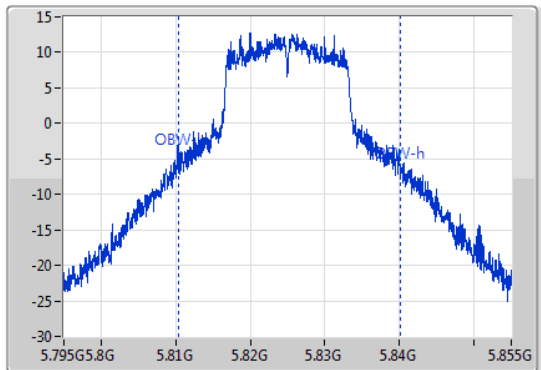

6dB(Hz)	Fl-6dB(Hz)	Fh-6dB(Hz)	OBW(Hz)	Fl-OBW(Hz)	Fh-OBW(Hz)	Limit(Hz)	Port
16.32M	5.81681G	5.83313G	29.835M	5.810307G	5.840142G	500k	1

802.11ac VHT20_Nss1,(MCS0)_1TX

EBW

5180MHz

25/03/2020

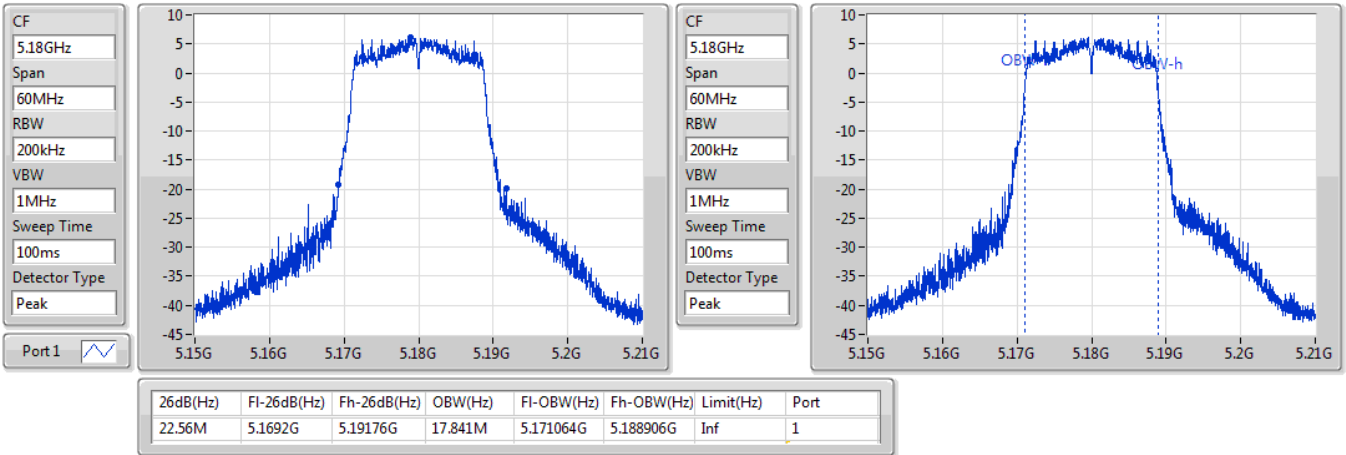

802.11ac VHT20_Nss1,(MCS0)_1TX

EBW

5200MHz

25/03/2020

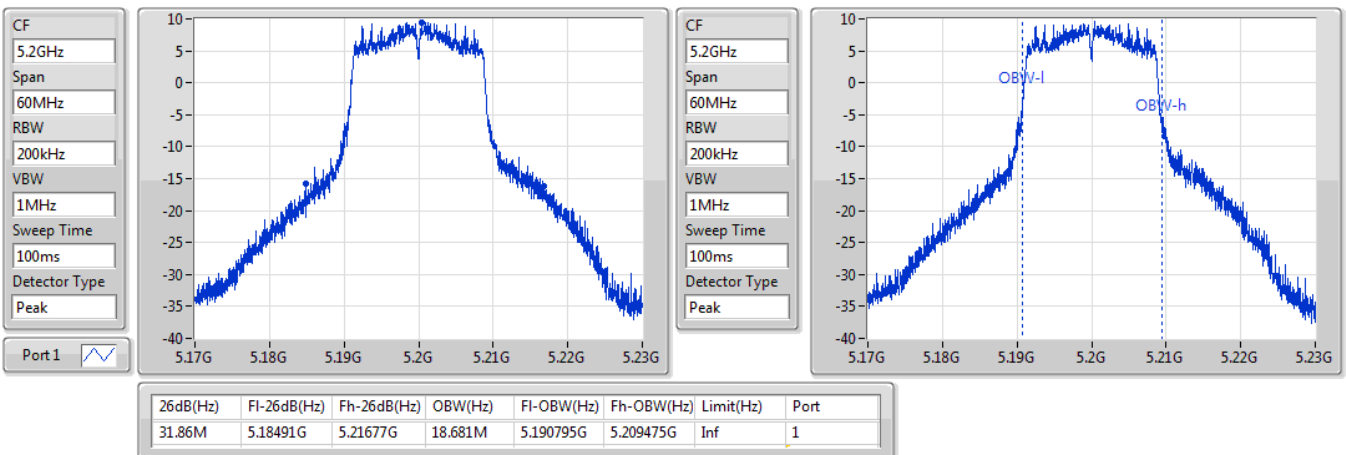

802.11ac VHT20_Nss1,(MCS0)_1TX

EBW

5240MHz

25/03/2020

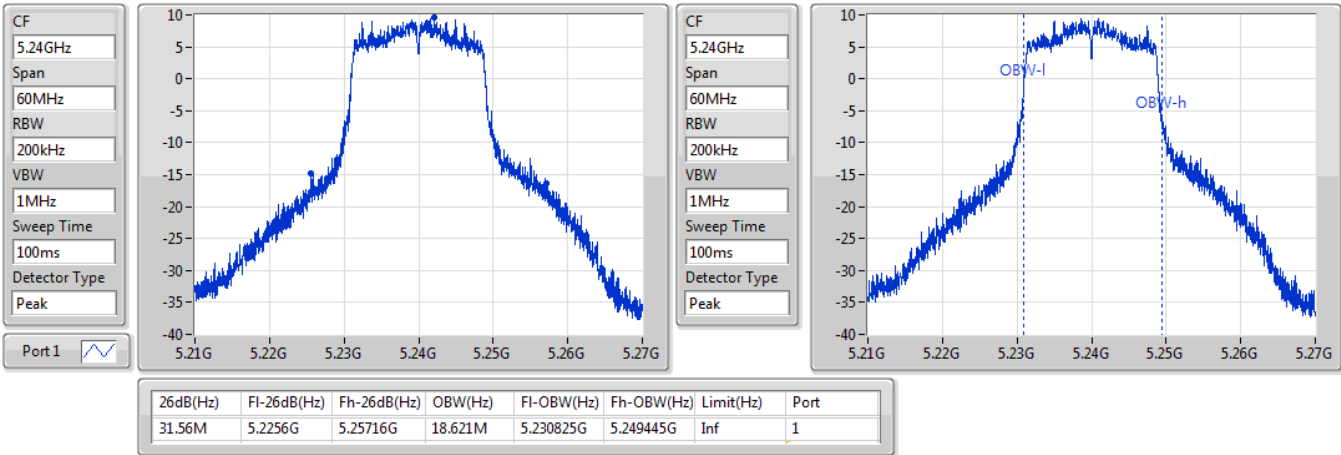

802.11ac VHT20_Nss1,(MCS0)_1TX

EBW

5260MHz

25/03/2020

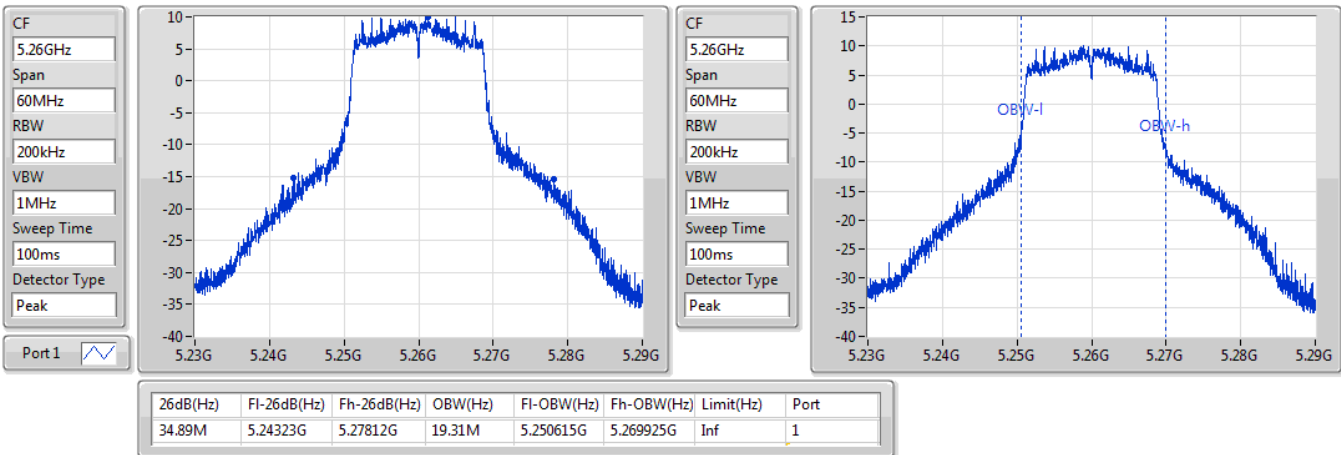

802.11ac VHT20_Nss1,(MCS0)_1TX

EBW

5300MHz

25/03/2020

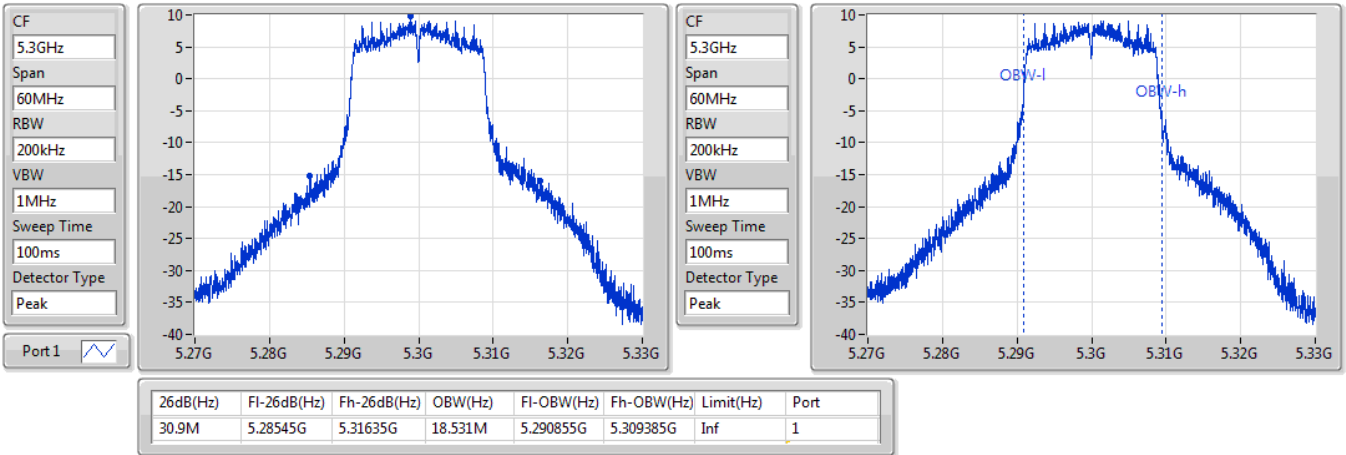

802.11ac VHT20_Nss1,(MCS0)_1TX

EBW

5320MHz

25/03/2020

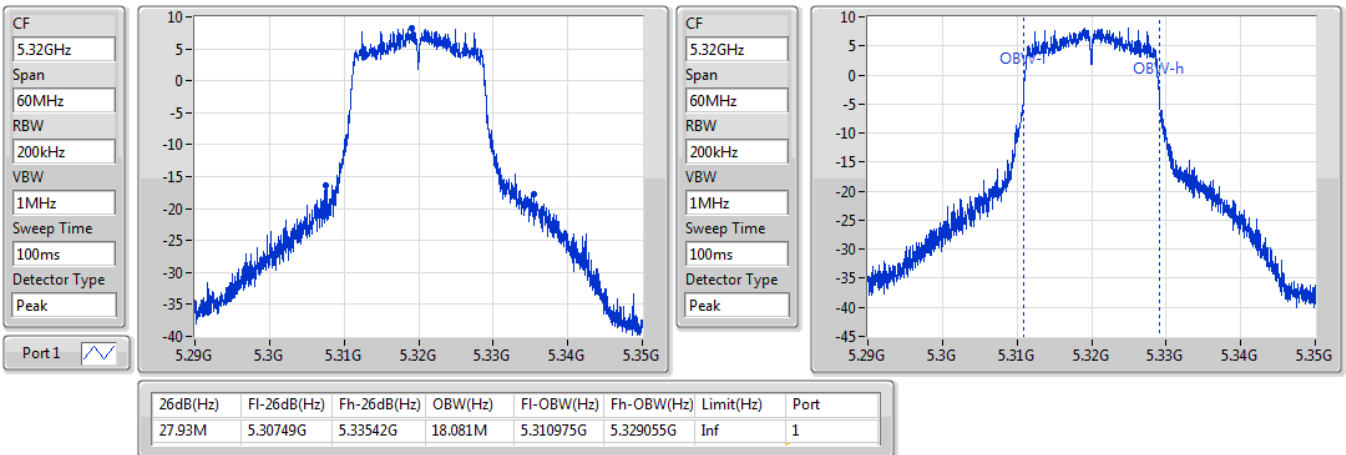

802.11ac VHT20_Nss1,(MCS0)_1TX

EBW

5500MHz

25/03/2020

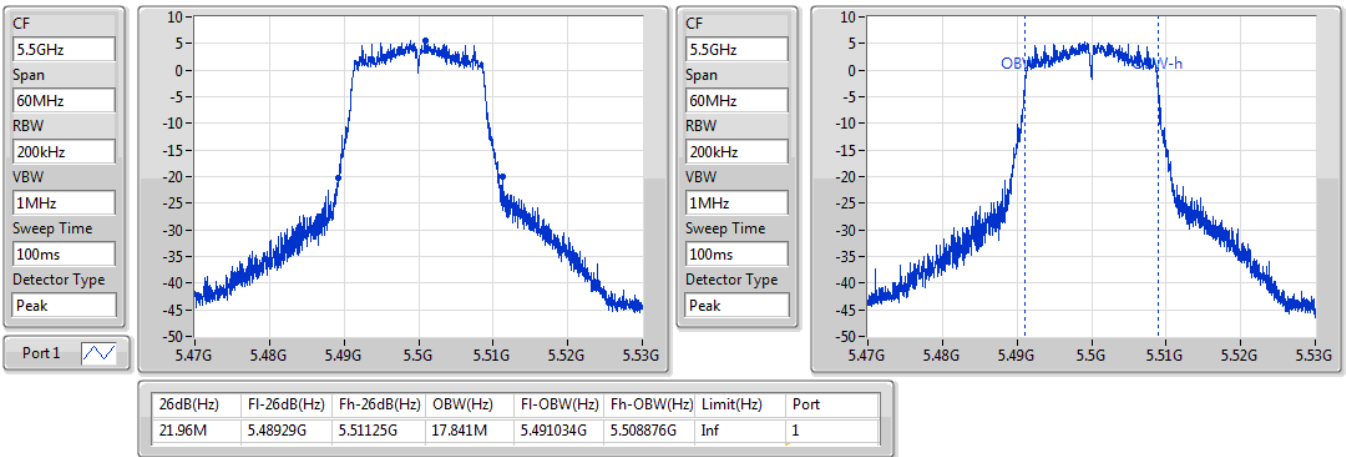

802.11ac VHT20_Nss1,(MCS0)_1TX

EBW

5580MHz

25/03/2020

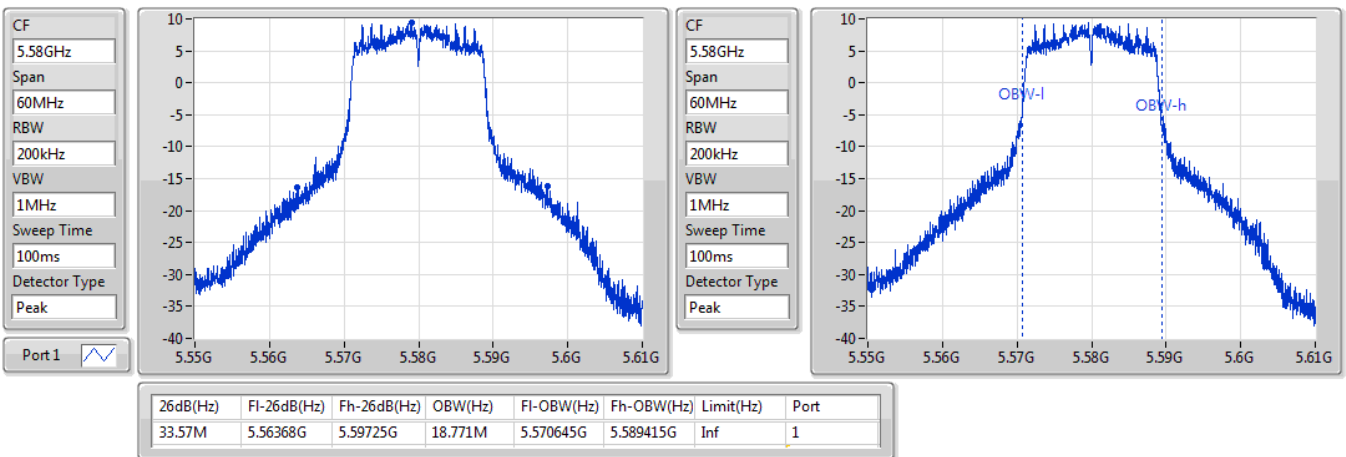

802.11ac VHT20_Nss1,(MCS0)_1TX

EBW

5700MHz

25/03/2020

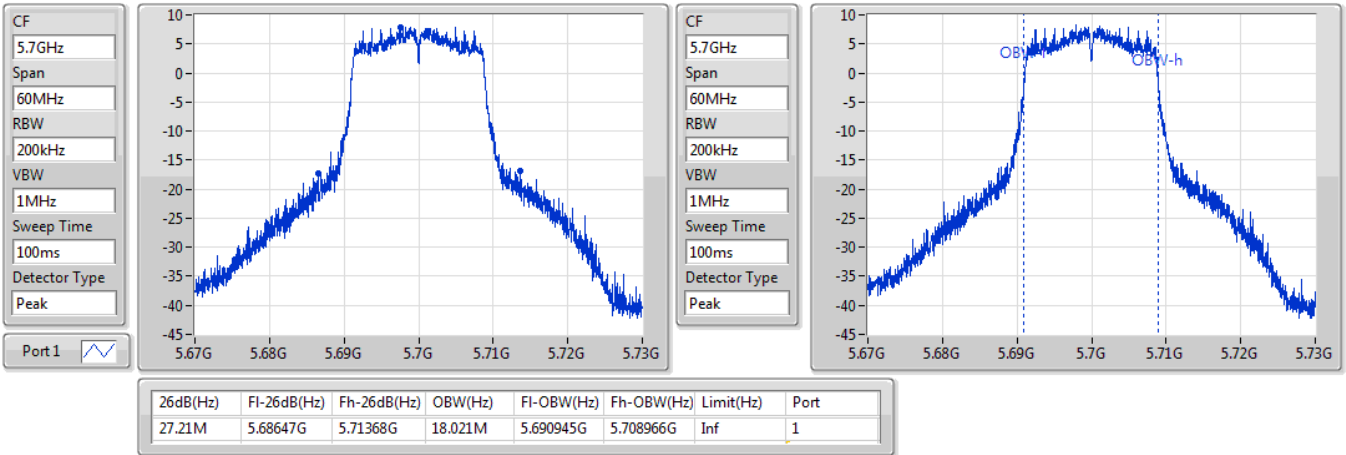

802.11ac VHT20_Nss1,(MCS0)_1TX

EBW

5745MHz

25/03/2020

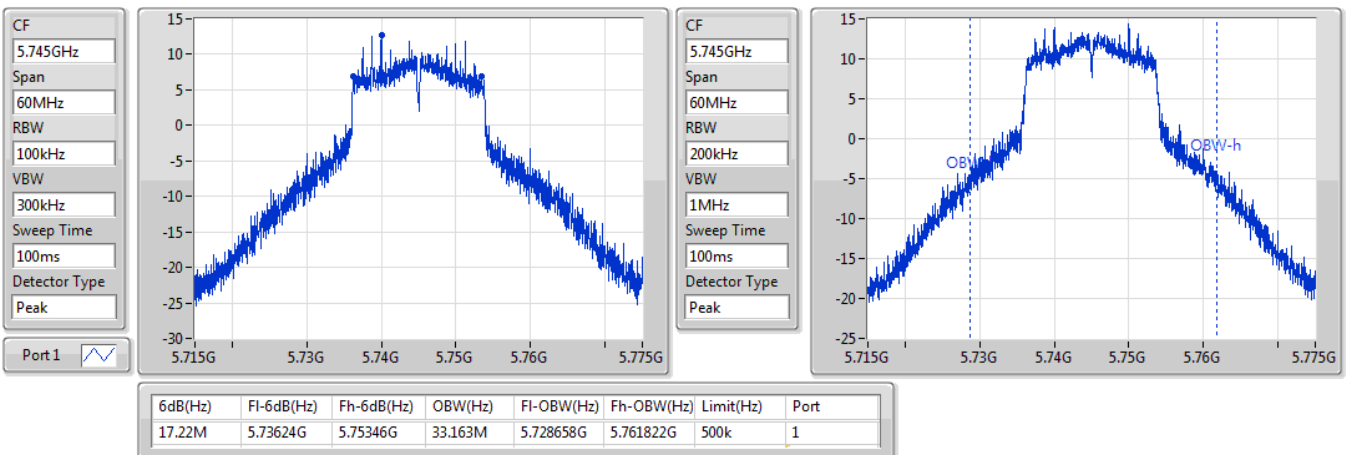

802.11ac VHT20_Nss1,(MCS0)_1TX

EBW

5785MHz

25/03/2020

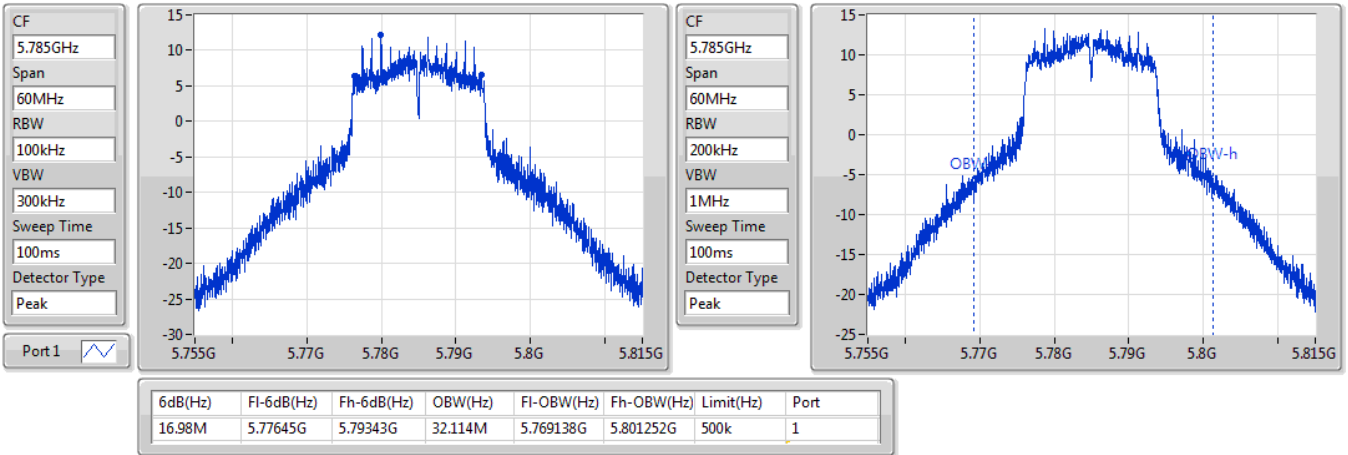

802.11ac VHT20_Nss1,(MCS0)_1TX

EBW

5825MHz

25/03/2020

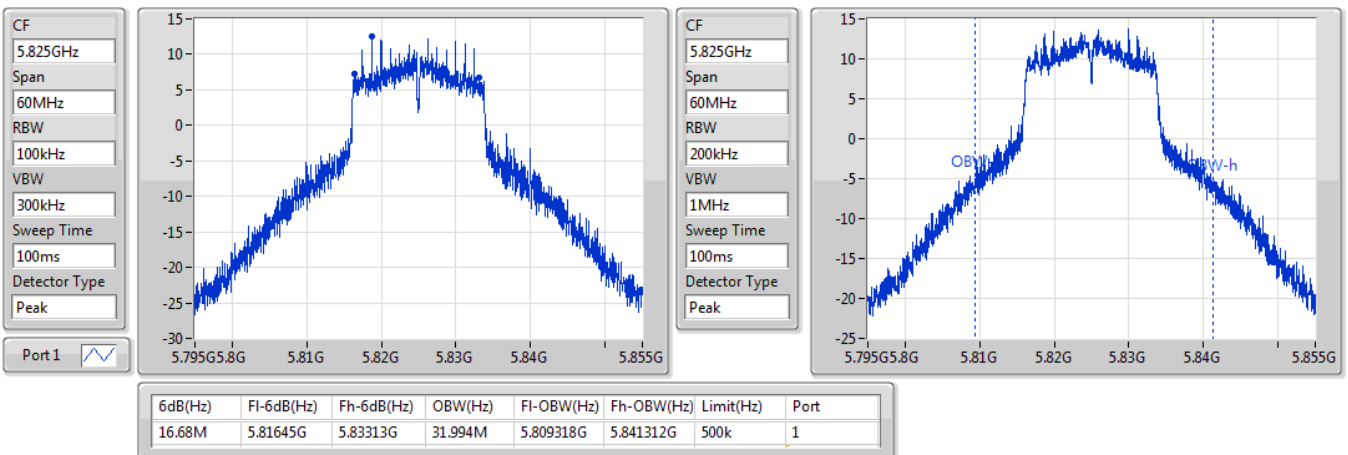

802.11ac VHT40_Nss1,(MCS0)_1TX

EBW

5190MHz

25/03/2020

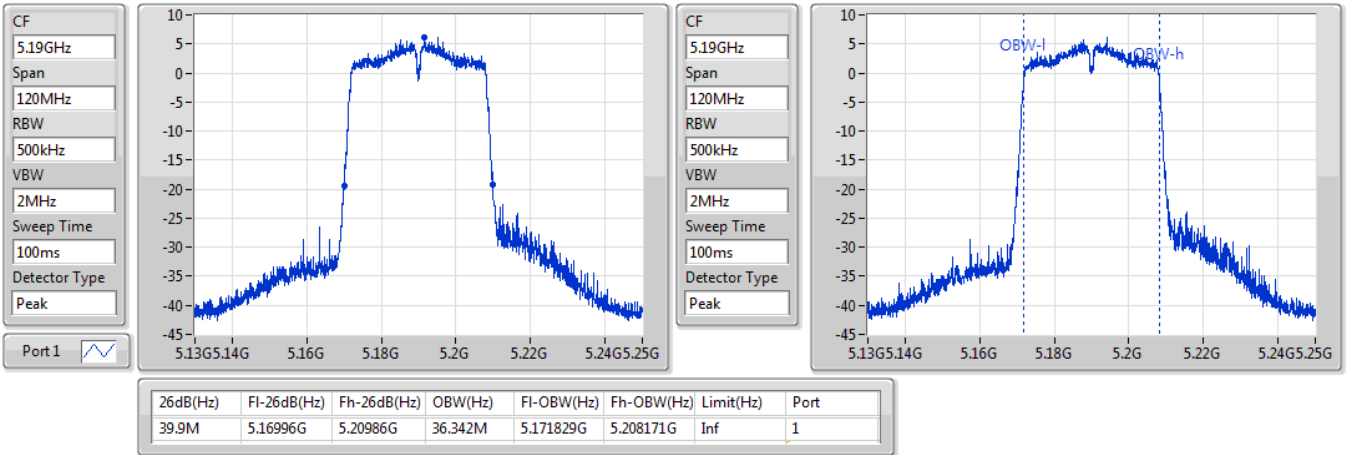

802.11ac VHT40_Nss1,(MCS0)_1TX

EBW

5230MHz

25/03/2020

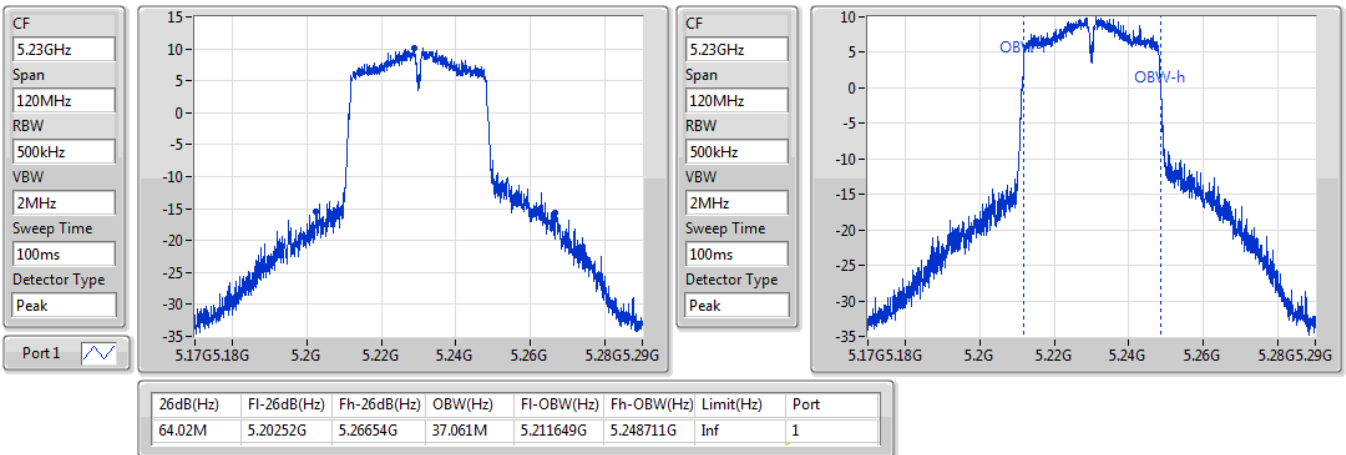

802.11ac VHT40_Nss1,(MCS0)_1TX

EBW

5270MHz

25/03/2020

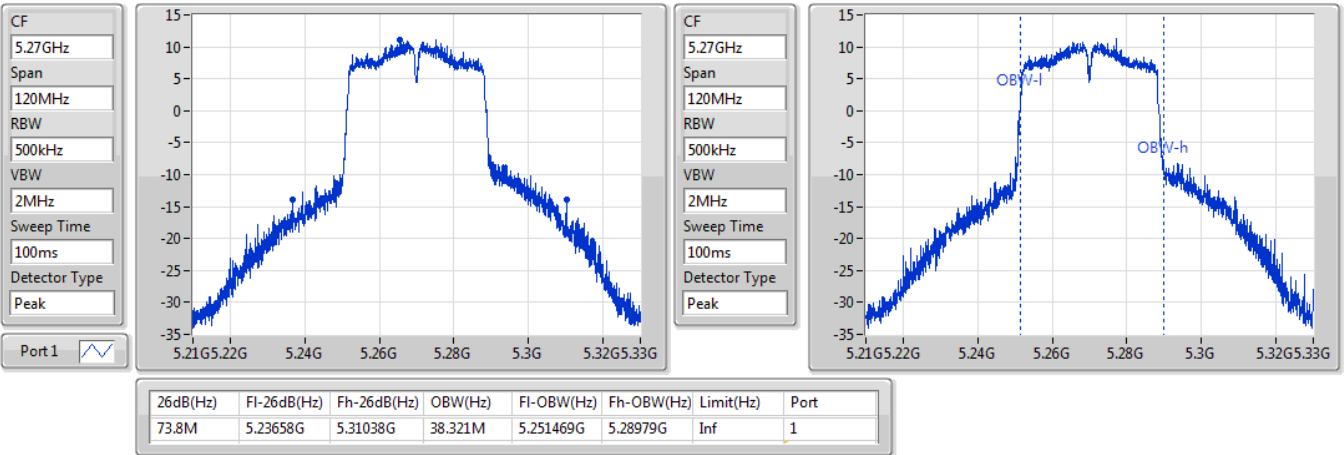

802.11ac VHT40_Nss1,(MCS0)_1TX

EBW

5310MHz

25/03/2020

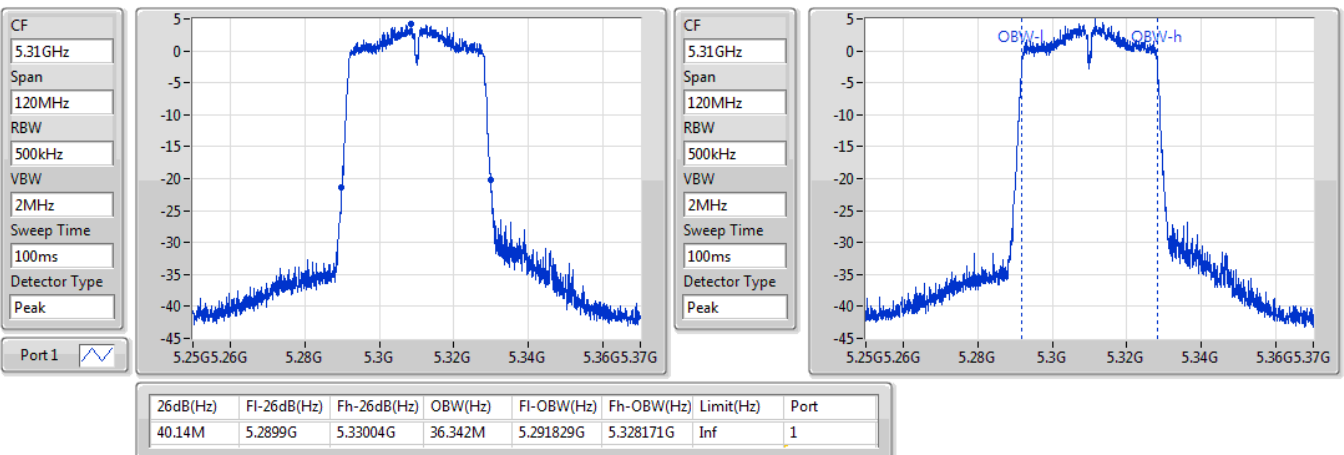

802.11ac VHT40_Nss1,(MCS0)_1TX

EBW

5510MHz

25/03/2020

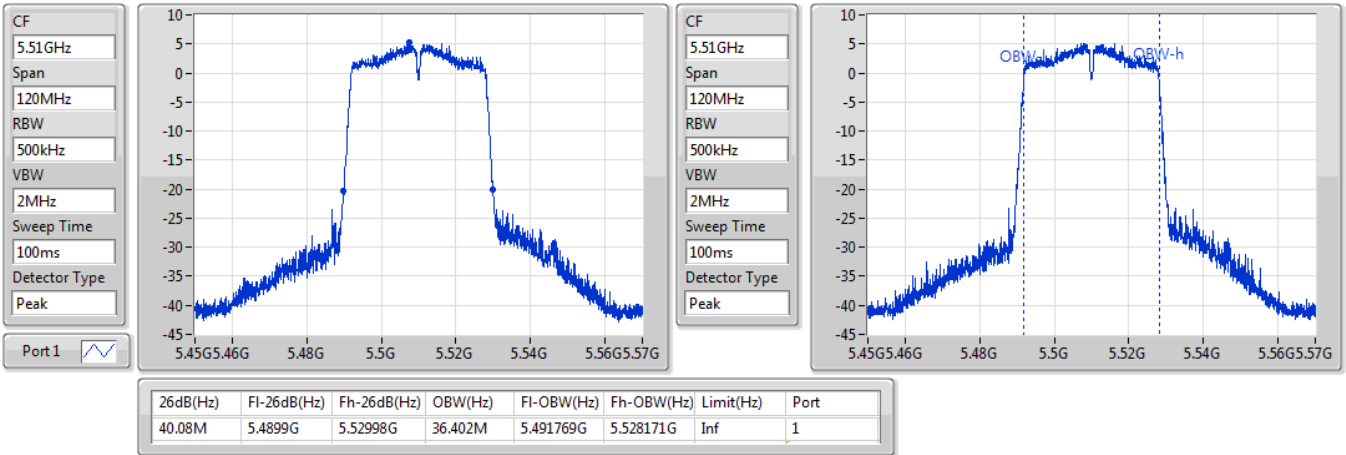

802.11ac VHT40_Nss1,(MCS0)_1TX

EBW

5550MHz

25/03/2020

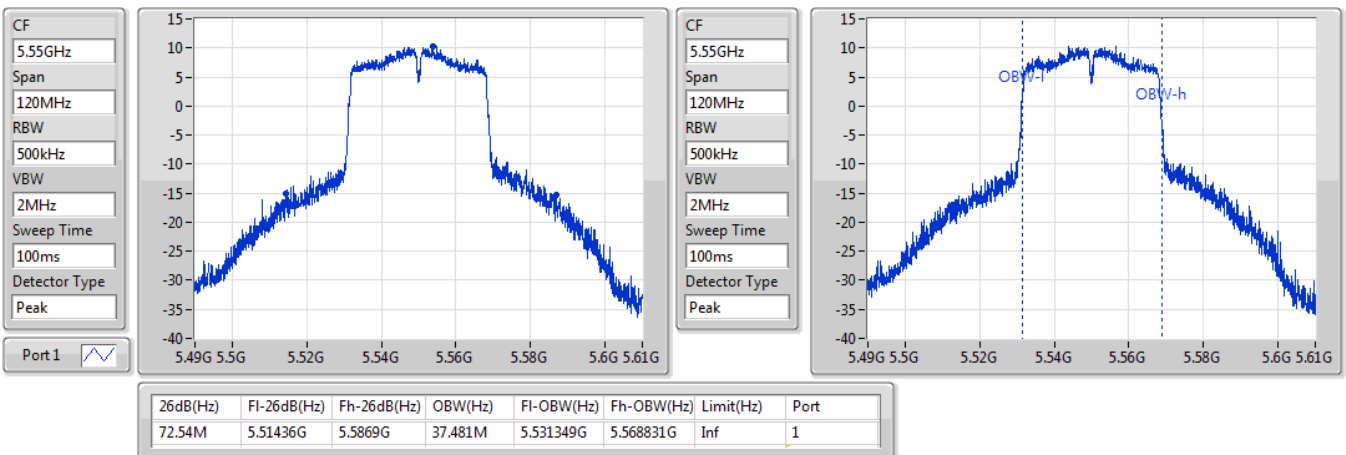

802.11ac VHT40_Nss1,(MCS0)_1TX

EBW

5670MHz

25/03/2020

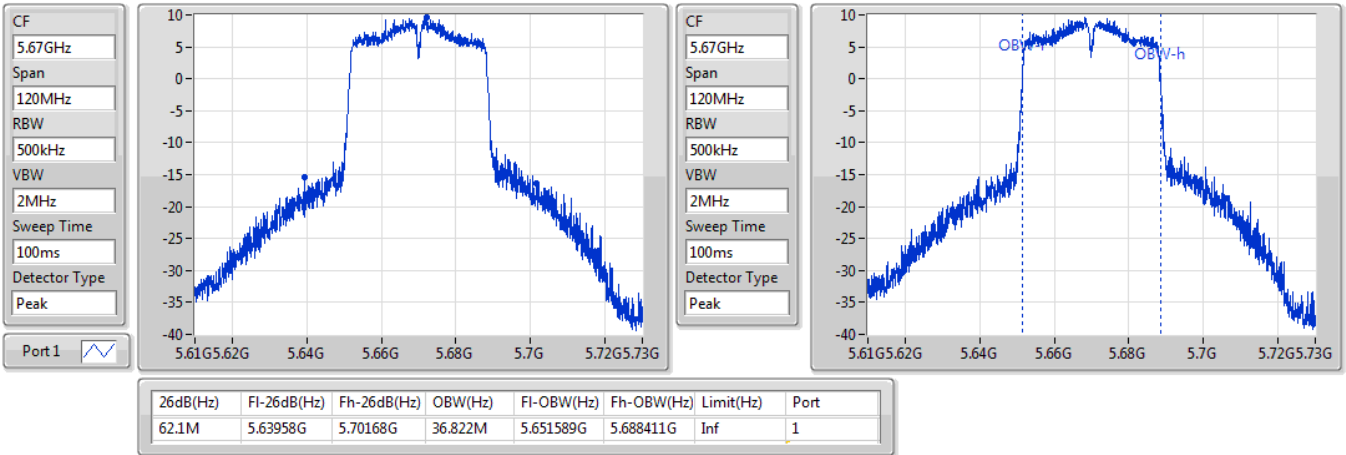

802.11ac VHT40_Nss1,(MCS0)_1TX

EBW

5755MHz

25/03/2020

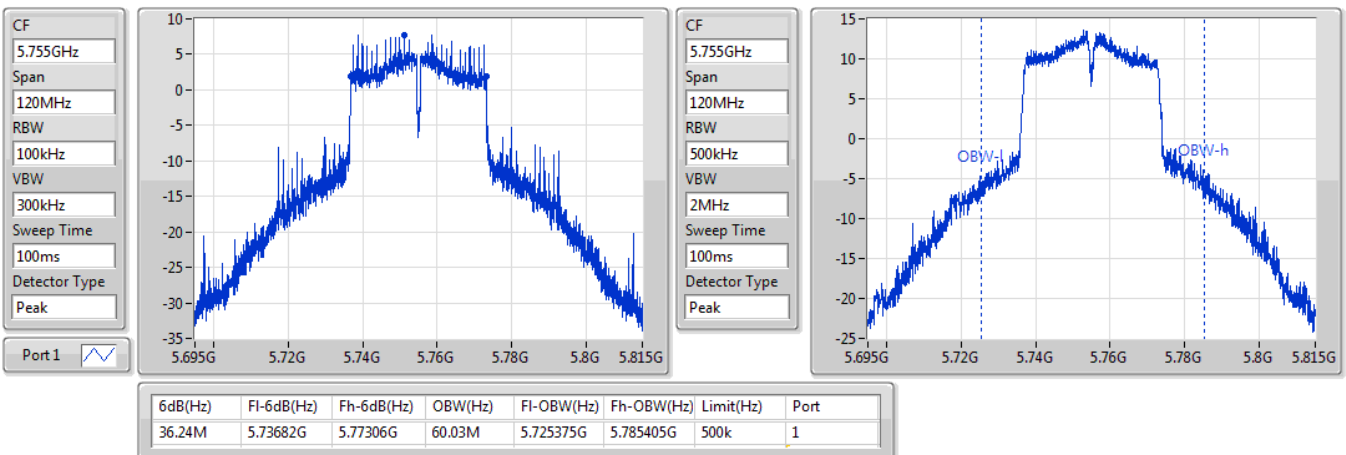

802.11ac VHT40_Nss1,(MCS0)_1TX

EBW

5795MHz

25/03/2020

CF
5.795GHz
Span
120MHz
RBW
100kHz
VBW
300kHz
Sweep Time
100ms
Detector Type
Peak
Port 1

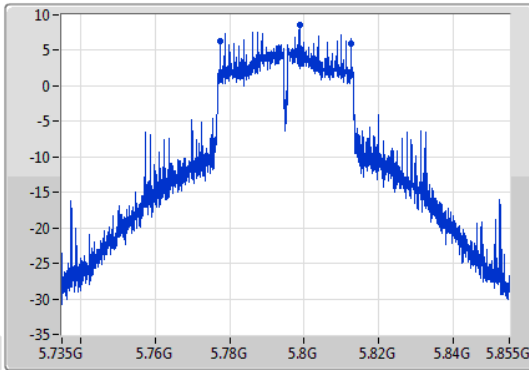

CF
5.795GHz
Span
120MHz
RBW
500kHz
VBW
2MHz
Sweep Time
100ms
Detector Type
Peak

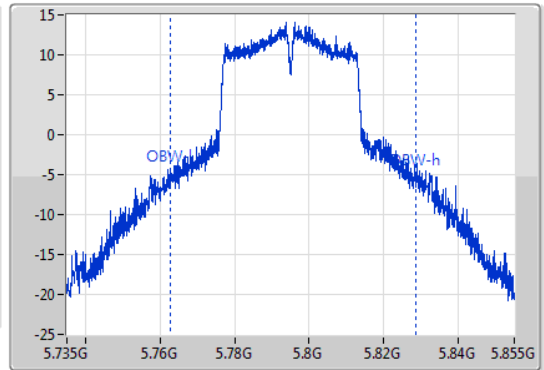

6dB(Hz)	Fl-6dB(Hz)	Fh-6dB(Hz)	OBW(Hz)	Fl-OBW(Hz)	Fh-OBW(Hz)	Limit(Hz)	Port
35.1M	5.77742G	5.81252G	66.087M	5.762616G	5.828703G	500k	1

802.11ac VHT80_Nss1,(MCS0)_1TX

EBW

5210MHz

02/06/2020

CF
5.21GHz
Span
240MHz
RBW
1MHz
VBW
3MHz
Sweep Time
100ms
Detector Type
Peak
Port 1

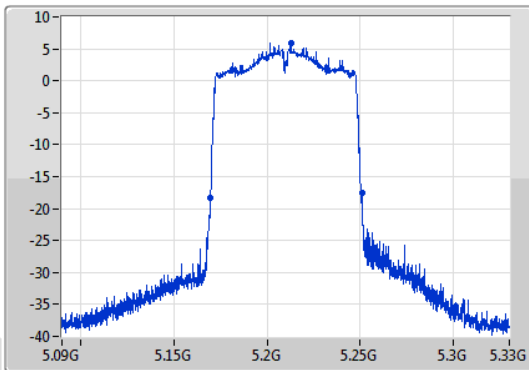

CF
5.21GHz
Span
240MHz
RBW
1MHz
VBW
3MHz
Sweep Time
100ms
Detector Type
Peak

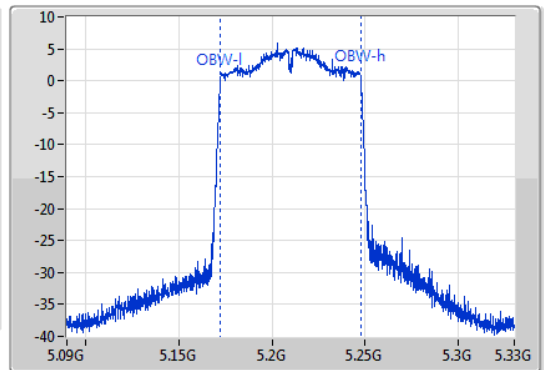

26dB(Hz)	Fl-26dB(Hz)	Fh-26dB(Hz)	OBW(Hz)	Fl-OBW(Hz)	Fh-OBW(Hz)	Limit(Hz)	Port
81.36M	5.16944G	5.2508G	75.562M	5.172219G	5.247781G	Inf	1

802.11ac VHT80_Nss1,(MCS0)_1TX

EBW

5290MHz

02/06/2020

CF
5.29GHz
Span
240MHz
RBW
1MHz
VBW
3MHz
Sweep Time
100ms
Detector Type
Peak
Port 1

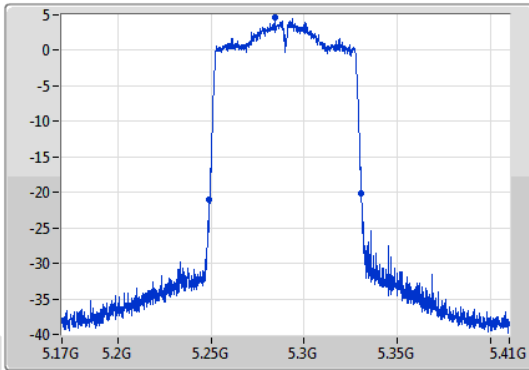

CF
5.29GHz
Span
240MHz
RBW
1MHz
VBW
3MHz
Sweep Time
100ms
Detector Type
Peak

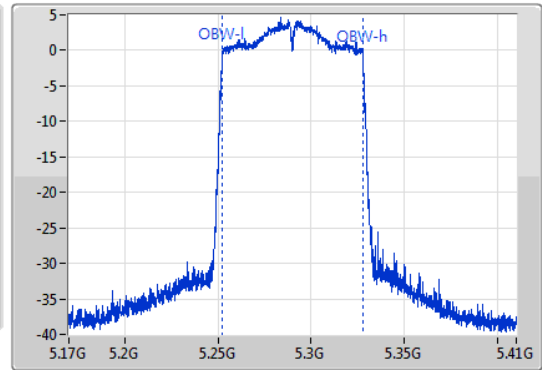

26dB(Hz)	Fl-26dB(Hz)	Fh-26dB(Hz)	OBW(Hz)	Fl-OBW(Hz)	Fh-OBW(Hz)	Limit(Hz)	Port
81.72M	5.24896G	5.33068G	75.562M	5.252219G	5.327781G	Inf	1

802.11ac VHT80_Nss1,(MCS0)_1TX

EBW

5530MHz

02/06/2020

CF
5.53GHz
Span
240MHz
RBW
1MHz
VBW
3MHz
Sweep Time
100ms
Detector Type
Peak
Port 1

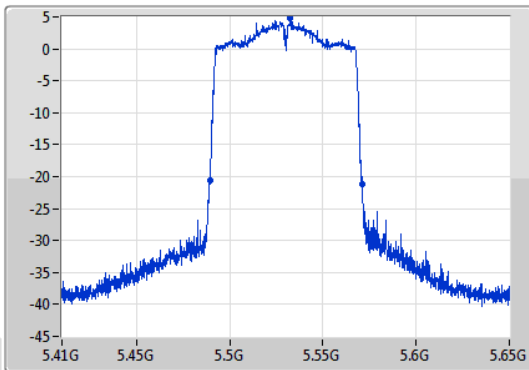

CF
5.53GHz
Span
240MHz
RBW
1MHz
VBW
3MHz
Sweep Time
100ms
Detector Type
Peak

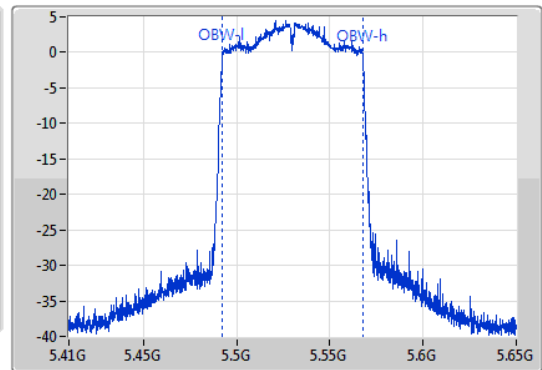

26dB(Hz)	Fl-26dB(Hz)	Fh-26dB(Hz)	OBW(Hz)	Fl-OBW(Hz)	Fh-OBW(Hz)	Limit(Hz)	Port
81.72M	5.48932G	5.57104G	75.562M	5.492219G	5.567781G	Inf	1

802.11ac VHT80_Nss1,(MCS0)_1TX

EBW

5610MHz

25/03/2020

CF
5.61GHz
Span
240MHz
RBW
1MHz
VBW
3MHz
Sweep Time
100ms
Detector Type
Peak
Port 1

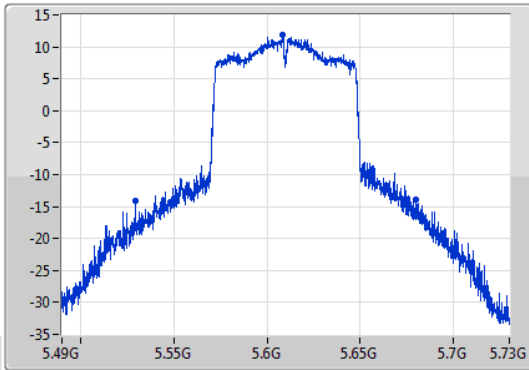

CF
5.61GHz
Span
240MHz
RBW
1MHz
VBW
3MHz
Sweep Time
100ms
Detector Type
Peak

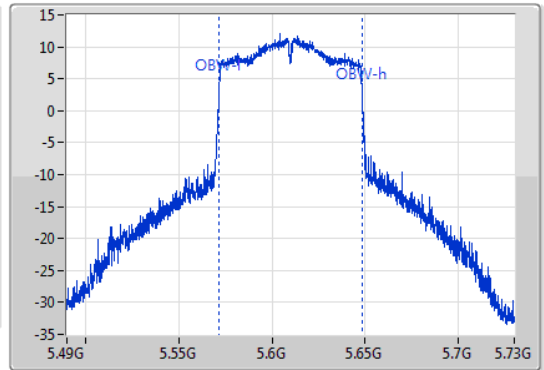

26dB(Hz)	Fl-26dB(Hz)	Fh-26dB(Hz)	OBW(Hz)	Fl-OBW(Hz)	Fh-OBW(Hz)	Limit(Hz)	Port
150.12M	5.52948G	5.6796G	76.882M	5.571619G	5.648501G	Inf	1

802.11ac VHT80_Nss1,(MCS0)_1TX

EBW

5690MHz Straddle 5.47-5.725GHz

25/03/2020

CF
5.6475GHz
Span
155MHz
RBW
1MHz
VBW
3MHz
Sweep Time
100ms
Detector Type
Peak
Port 1

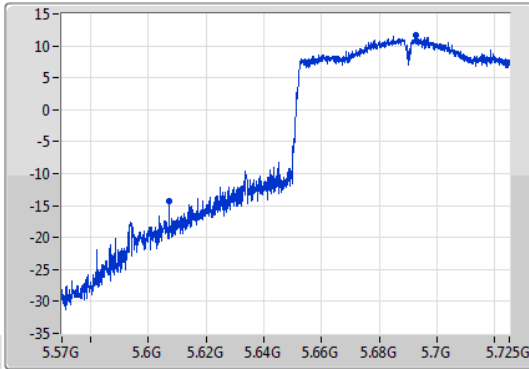

CF
5.6475GHz
Span
155MHz
RBW
1MHz
VBW
3MHz
Sweep Time
100ms
Detector Type
Peak

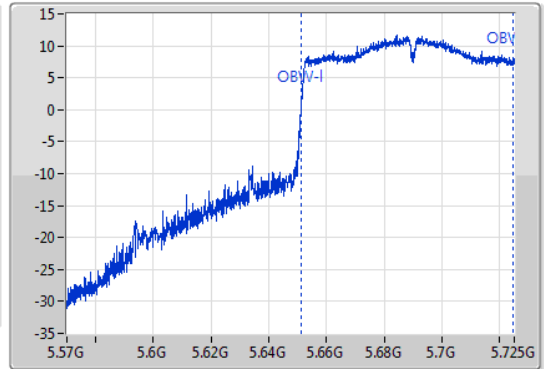

26dB(Hz)	Fl-26dB(Hz)	Fh-26dB(Hz)	OBW(Hz)	Fl-OBW(Hz)	Fh-OBW(Hz)	Limit(Hz)	Port
117.955M	5.607045G	5.725G	73.123M	5.651373G	5.724497G	Inf	1

802.11ac VHT80_Nss1,(MCS0)_1TX

EBW

5690MHz Straddle 5.725-5.85GHz

25/03/2020

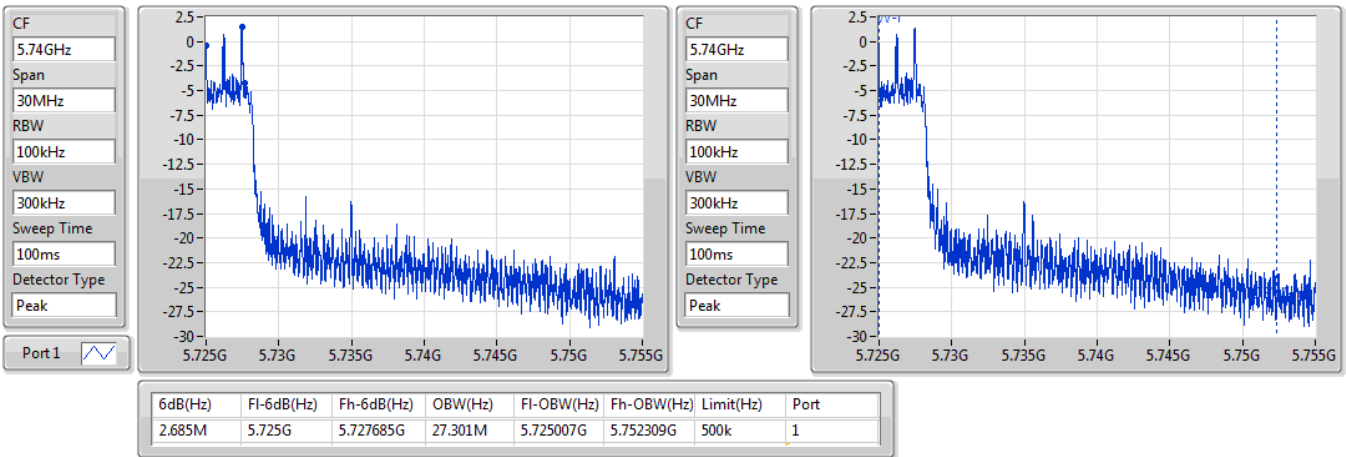

802.11ac VHT80_Nss1,(MCS0)_1TX

EBW

5775MHz

25/03/2020

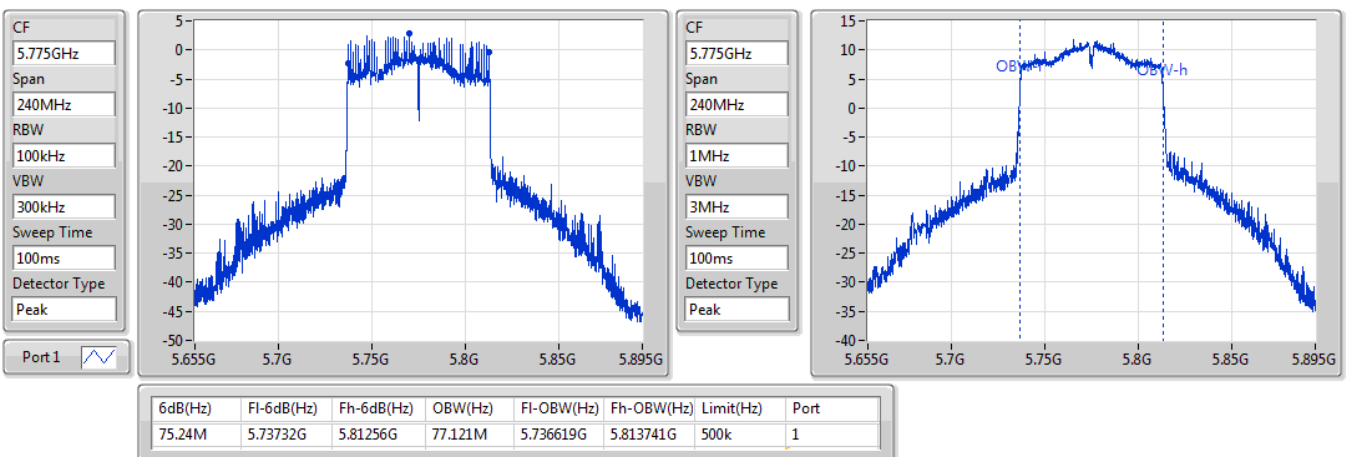



Summary

Mode	Total Power (dBm)	Total Power (W)
5.15-5.25GHz	-	-
802.11a_Nss1,(6Mbps)_1TX	20.19	0.10447
802.11ac VHT20_Nss1,(MCS0)_1TX	19.10	0.08128
802.11ac VHT40_Nss1,(MCS0)_1TX	18.68	0.07379
802.11ac VHT80_Nss1,(MCS0)_1TX	13.37	0.02173
5.25-5.35GHz	-	-
802.11a_Nss1,(6Mbps)_1TX	19.01	0.07962
802.11ac VHT20_Nss1,(MCS0)_1TX	19.55	0.09016
802.11ac VHT40_Nss1,(MCS0)_1TX	19.03	0.07998
802.11ac VHT80_Nss1,(MCS0)_1TX	12.25	0.01679
5.47-5.725GHz	-	-
802.11a_Nss1,(6Mbps)_1TX	19.22	0.08356
802.11ac VHT20_Nss1,(MCS0)_1TX	18.99	0.07925
802.11ac VHT40_Nss1,(MCS0)_1TX	18.54	0.07145
802.11ac VHT80_Nss1,(MCS0)_1TX	19.24	0.08395
5.725-5.85GHz	-	-
802.11a_Nss1,(6Mbps)_1TX	22.15	0.16406
802.11ac VHT20_Nss1,(MCS0)_1TX	22.73	0.18750
802.11ac VHT40_Nss1,(MCS0)_1TX	21.73	0.14894
802.11ac VHT80_Nss1,(MCS0)_1TX	18.71	0.07430



Result

Mode	Result	DG (dBi)	Port 1 (dBm)	Total Power (dBm)	Power Limit (dBm)
802.11a_Nss1,(6Mbps)_1TX	-	-	-	-	-
5180MHz	Pass	5.16	15.55	15.55	23.98
5200MHz	Pass	5.16	20.19	20.19	23.98
5240MHz	Pass	5.16	19.29	19.29	23.98
5260MHz	Pass	5.16	19.01	19.01	23.98
5300MHz	Pass	5.16	18.83	18.83	23.98
5320MHz	Pass	5.16	17.32	17.32	23.98
5500MHz	Pass	5.16	15.40	15.40	23.98
5580MHz	Pass	5.16	19.22	19.22	23.98
5700MHz	Pass	5.16	17.27	17.27	23.98
5745MHz	Pass	5.16	22.15	22.15	30.00
5785MHz	Pass	5.16	21.70	21.70	30.00
5825MHz	Pass	5.16	21.81	21.81	30.00
802.11ac_VHT20_Nss1,(MCS0)_1TX	-	-	-	-	-
5180MHz	Pass	5.16	16.01	16.01	23.98
5200MHz	Pass	5.16	19.10	19.10	23.98
5240MHz	Pass	5.16	18.99	18.99	23.98
5260MHz	Pass	5.16	19.55	19.55	23.98
5300MHz	Pass	5.16	18.55	18.55	23.98
5320MHz	Pass	5.16	17.85	17.85	23.98
5500MHz	Pass	5.16	15.02	15.02	23.98
5580MHz	Pass	5.16	18.99	18.99	23.98
5700MHz	Pass	5.16	17.75	17.75	23.98
5745MHz	Pass	5.16	22.73	22.73	30.00
5785MHz	Pass	5.16	22.22	22.22	30.00
5825MHz	Pass	5.16	22.20	22.20	30.00
802.11ac_VHT40_Nss1,(MCS0)_1TX	-	-	-	-	-
5190MHz	Pass	5.16	13.84	13.84	23.98
5230MHz	Pass	5.16	18.68	18.68	23.98
5270MHz	Pass	5.16	19.03	19.03	23.98
5310MHz	Pass	5.16	12.38	12.38	23.98
5510MHz	Pass	5.16	13.50	13.50	23.98
5550MHz	Pass	5.16	18.54	18.54	23.98
5670MHz	Pass	5.16	17.72	17.72	23.98
5755MHz	Pass	5.16	21.52	21.52	30.00
5795MHz	Pass	5.16	21.73	21.73	30.00
802.11ac_VHT80_Nss1,(MCS0)_1TX	-	-	-	-	-
5210MHz	Pass	5.16	13.37	13.37	23.98
5290MHz	Pass	5.16	12.25	12.25	23.98
5530MHz	Pass	5.16	12.60	12.60	23.98
5610MHz	Pass	5.16	18.68	18.68	23.98



Average Power

Appendix C

Mode	Result	DG (dBi)	Port 1 (dBm)	Total Power (dBm)	Power Limit (dBm)
5690MHz Straddle 5.47-5.725GHz	Pass	5.16	19.24	19.24	23.98
5690MHz Straddle 5.725-5.85GHz	Pass	5.16	4.27	4.27	30.00
5775MHz	Pass	5.16	18.71	18.71	30.00

DG = Directional Gain; **Port X** = Port X output power

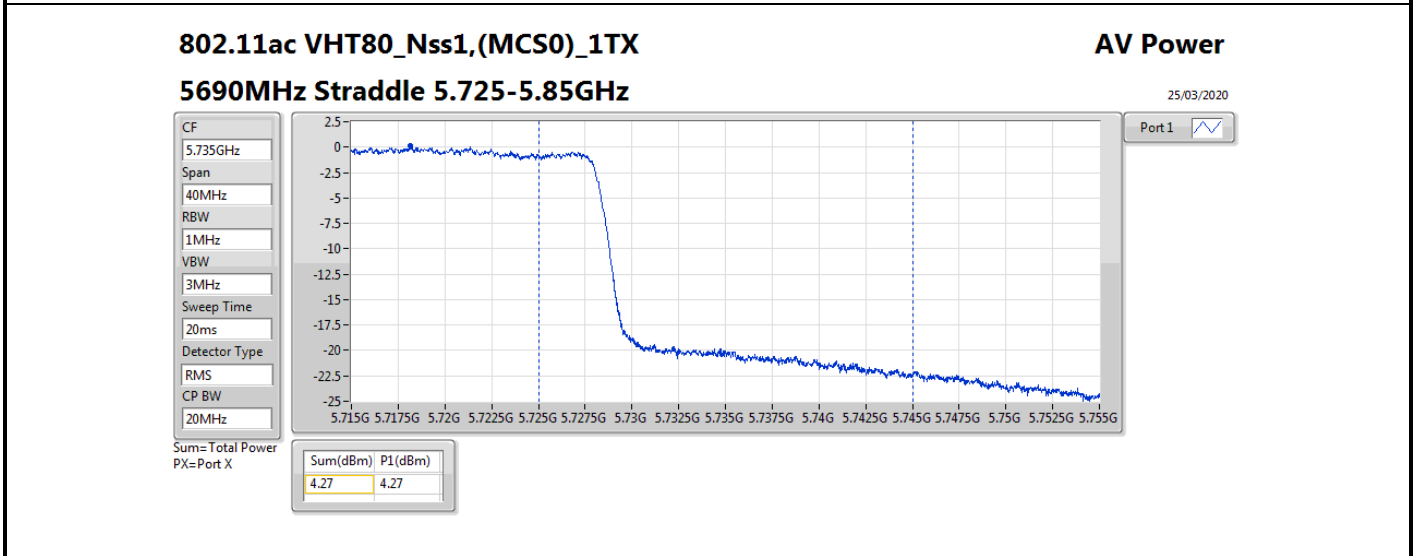
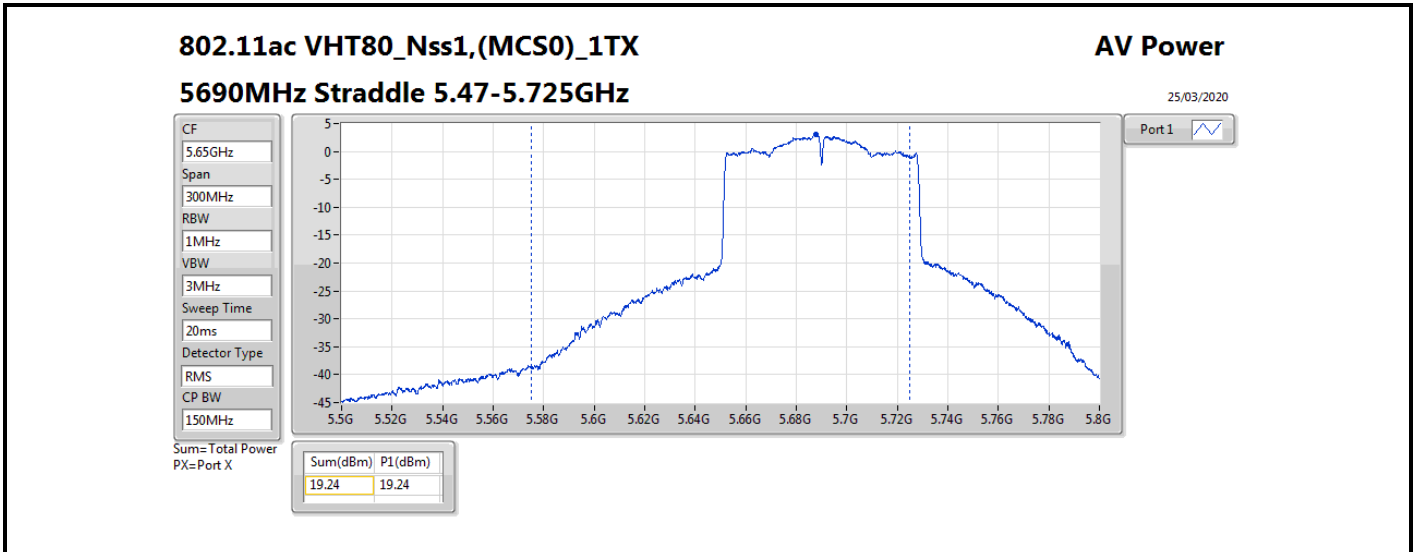

Summary

Mode	PD (dBm/RBW)
5.15-5.25GHz	-
802.11a_Nss1,(6Mbps)_1TX	8.63
802.11ac VHT20_Nss1,(MCS0)_1TX	7.36
802.11ac VHT40_Nss1,(MCS0)_1TX	3.94
802.11ac VHT80_Nss1,(MCS0)_1TX	-4.65
5.25-5.35GHz	-
802.11a_Nss1,(6Mbps)_1TX	7.50
802.11ac VHT20_Nss1,(MCS0)_1TX	7.80
802.11ac VHT40_Nss1,(MCS0)_1TX	4.57
802.11ac VHT80_Nss1,(MCS0)_1TX	-5.66
5.47-5.725GHz	-
802.11a_Nss1,(6Mbps)_1TX	7.66
802.11ac VHT20_Nss1,(MCS0)_1TX	7.15
802.11ac VHT40_Nss1,(MCS0)_1TX	4.08
802.11ac VHT80_Nss1,(MCS0)_1TX	1.55
5.725-5.85GHz	-
802.11a_Nss1,(6Mbps)_1TX	9.01
802.11ac VHT20_Nss1,(MCS0)_1TX	9.74
802.11ac VHT40_Nss1,(MCS0)_1TX	5.68
802.11ac VHT80_Nss1,(MCS0)_1TX	-0.24

RBW = 500 kHz for 5.725-5.85GHz band / 1MHz for other band;



Result

Mode	Result	DG (dBi)	Port 1 (dBm/RBW)	PD (dBm/RBW)	PD Limit (dBm/RBW)
802.11a_Nss1,(6Mbps)_1TX	-	-	-	-	-
5180MHz	Pass	5.16	3.99	3.99	11.00
5200MHz	Pass	5.16	8.63	8.63	11.00
5240MHz	Pass	5.16	7.74	7.74	11.00
5260MHz	Pass	5.16	7.50	7.50	11.00
5300MHz	Pass	5.16	7.30	7.30	11.00
5320MHz	Pass	5.16	6.02	6.02	11.00
5500MHz	Pass	5.16	3.88	3.88	11.00
5580MHz	Pass	5.16	7.66	7.66	11.00
5700MHz	Pass	5.16	5.55	5.55	11.00
5745MHz	Pass	5.16	9.01	9.01	30.00
5785MHz	Pass	5.16	8.63	8.63	30.00
5825MHz	Pass	5.16	8.71	8.71	30.00
802.11ac VHT20_Nss1,(MCS0)_1TX	-	-	-	-	-
5180MHz	Pass	5.16	4.09	4.09	11.00
5200MHz	Pass	5.16	7.36	7.36	11.00
5240MHz	Pass	5.16	7.15	7.15	11.00
5260MHz	Pass	5.16	7.80	7.80	11.00
5300MHz	Pass	5.16	7.08	7.08	11.00
5320MHz	Pass	5.16	6.10	6.10	11.00
5500MHz	Pass	5.16	3.31	3.31	11.00
5580MHz	Pass	5.16	7.15	7.15	11.00
5700MHz	Pass	5.16	6.05	6.05	11.00
5745MHz	Pass	5.16	9.74	9.74	30.00
5785MHz	Pass	5.16	9.02	9.02	30.00
5825MHz	Pass	5.16	9.19	9.19	30.00
802.11ac VHT40_Nss1,(MCS0)_1TX	-	-	-	-	-
5190MHz	Pass	5.16	-0.85	-0.85	11.00
5230MHz	Pass	5.16	3.94	3.94	11.00
5270MHz	Pass	5.16	4.57	4.57	11.00
5310MHz	Pass	5.16	-2.22	-2.22	11.00
5510MHz	Pass	5.16	-0.97	-0.97	11.00
5550MHz	Pass	5.16	4.08	4.08	11.00
5670MHz	Pass	5.16	3.18	3.18	11.00
5755MHz	Pass	5.16	5.21	5.21	30.00
5795MHz	Pass	5.16	5.68	5.68	30.00
802.11ac VHT80_Nss1,(MCS0)_1TX	-	-	-	-	-
5210MHz	Pass	5.16	-4.65	-4.65	11.00
5290MHz	Pass	5.16	-5.66	-5.66	11.00
5530MHz	Pass	5.16	-5.30	-5.30	11.00
5610MHz	Pass	5.16	1.55	1.55	11.00



Mode	Result	DG (dBi)	Port 1 (dBm/RBW)	PD (dBm/RBW)	PD Limit (dBm/RBW)
5690MHz Straddle 5.47-5.725GHz	Pass	5.16	1.31	1.31	11.00
5690MHz Straddle 5.725-5.85GHz	Pass	5.16	-3.23	-3.23	30.00
5775MHz	Pass	5.16	-0.24	-0.24	30.00

DG = Directional Gain; **RBW** = 500 kHz for 5.725-5.85GHz band / 1MHz for other band;

PD = trace bin-by-bin of each transmits port summing can be performed maximum power density; **Port X** = Port X power density;

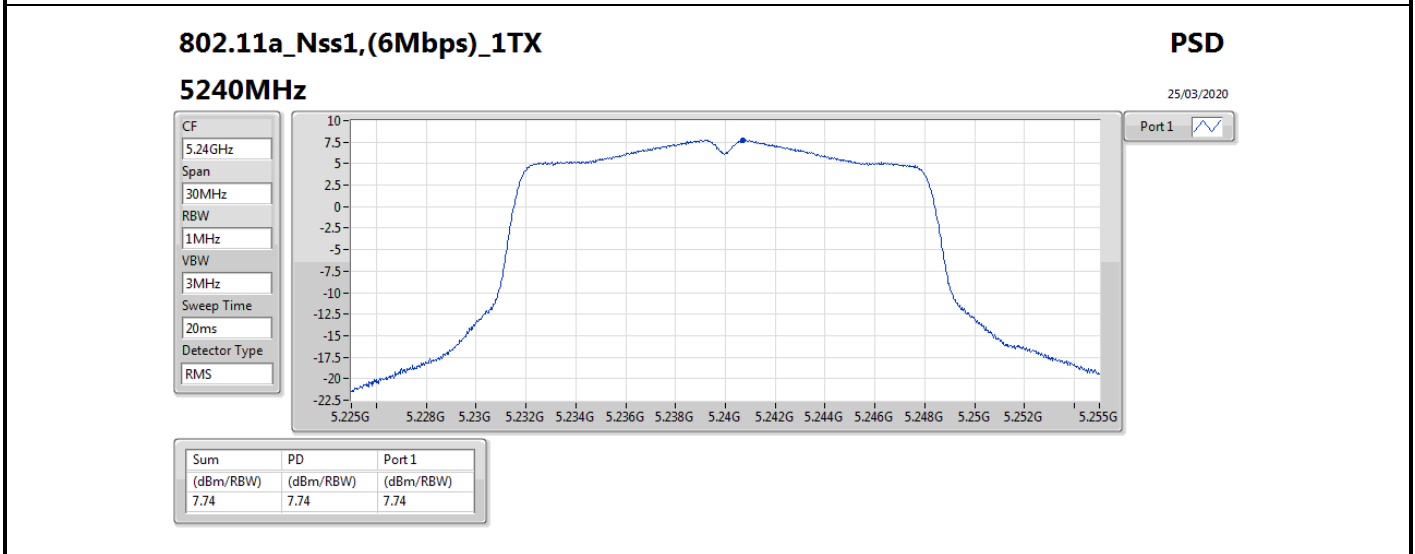
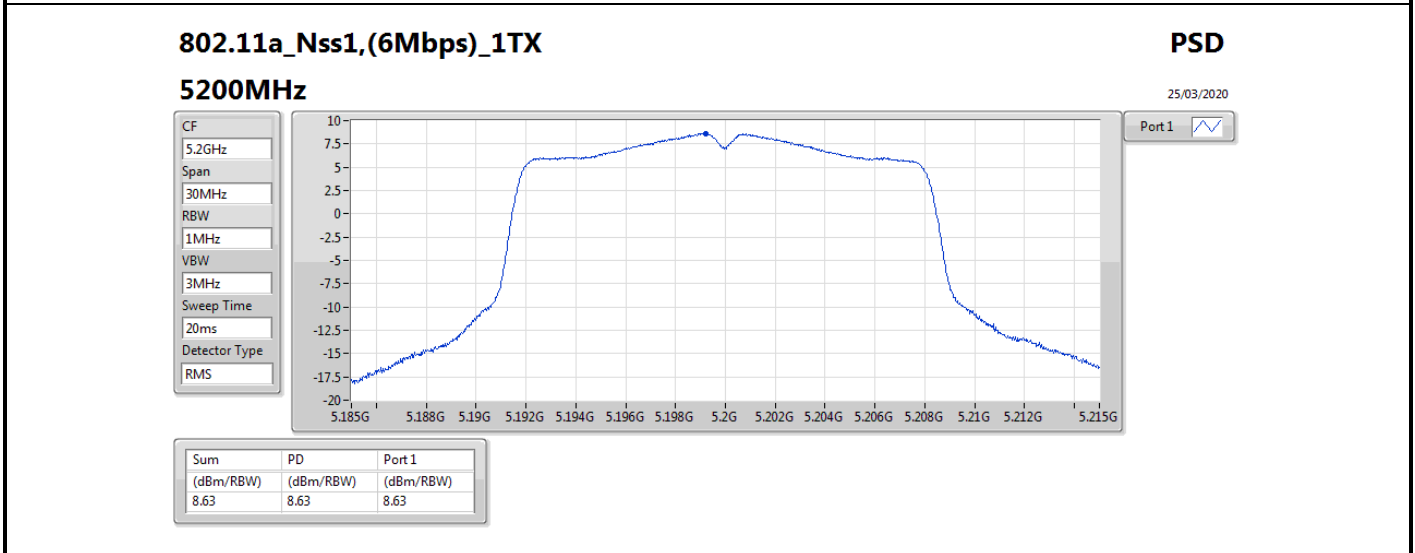
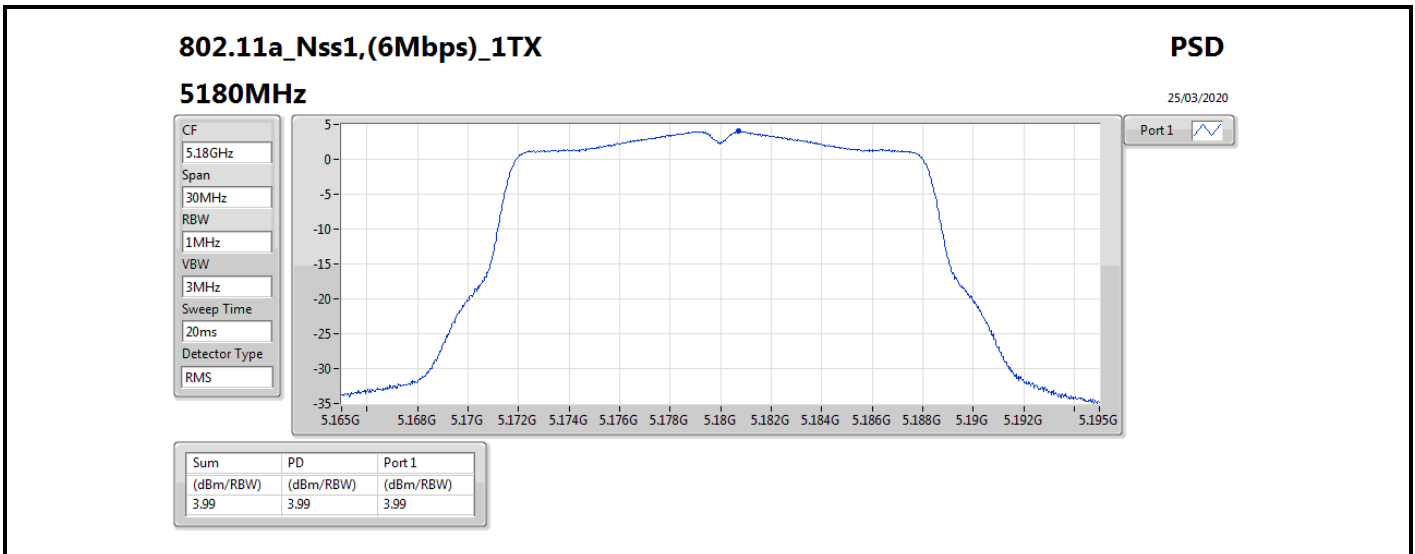

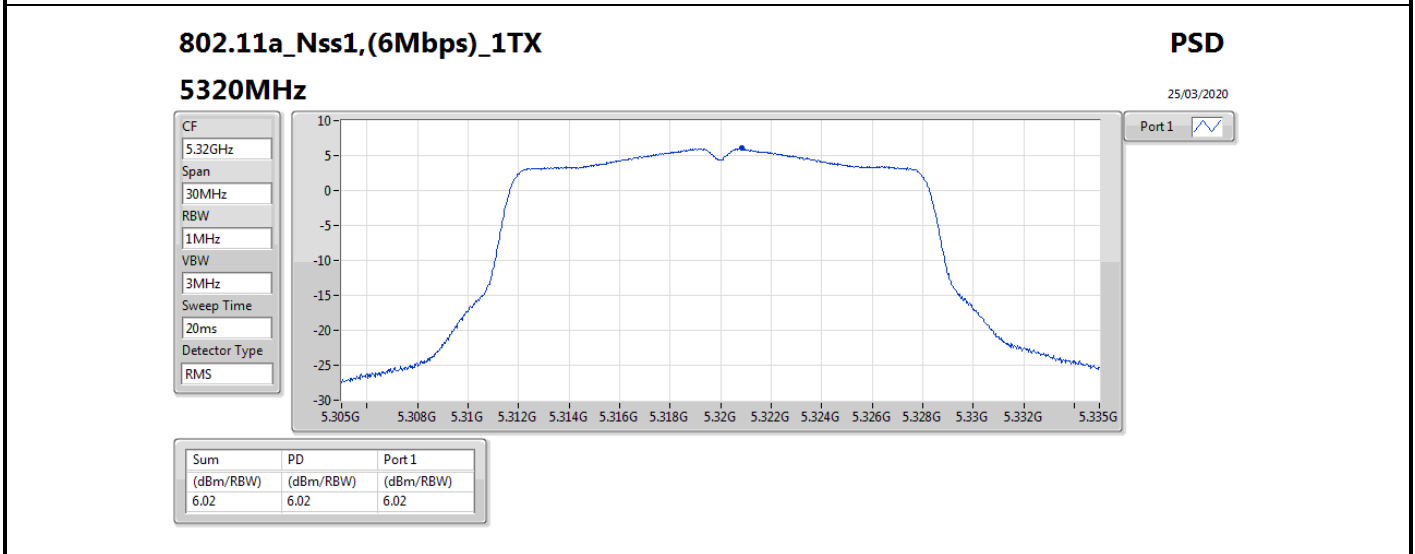
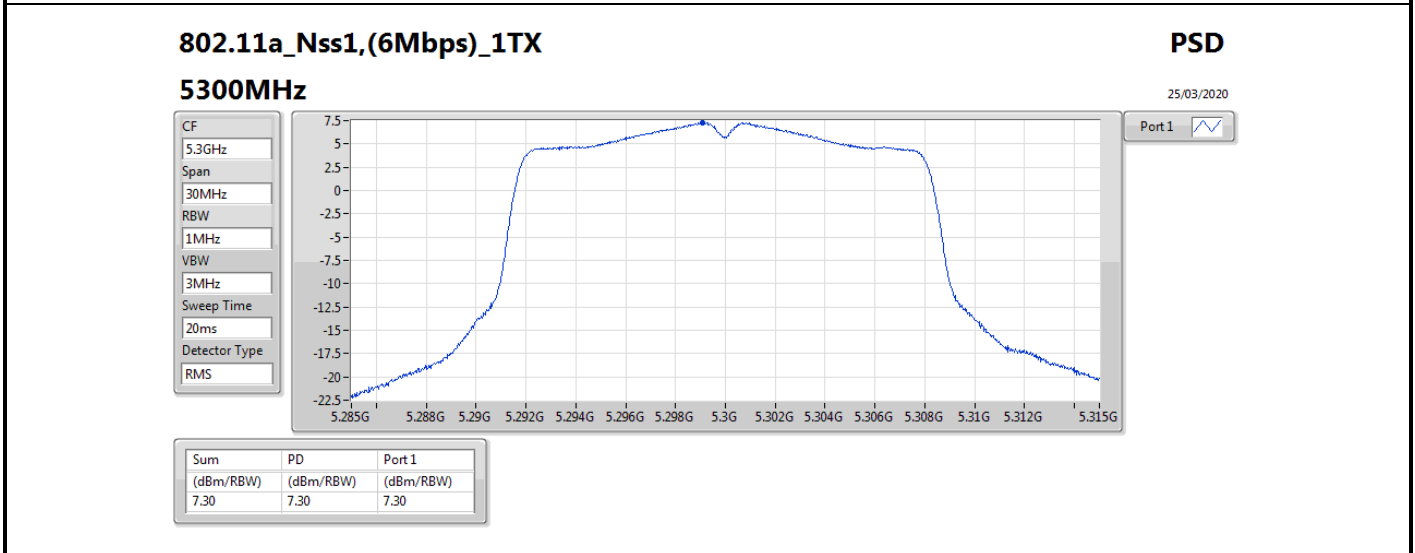
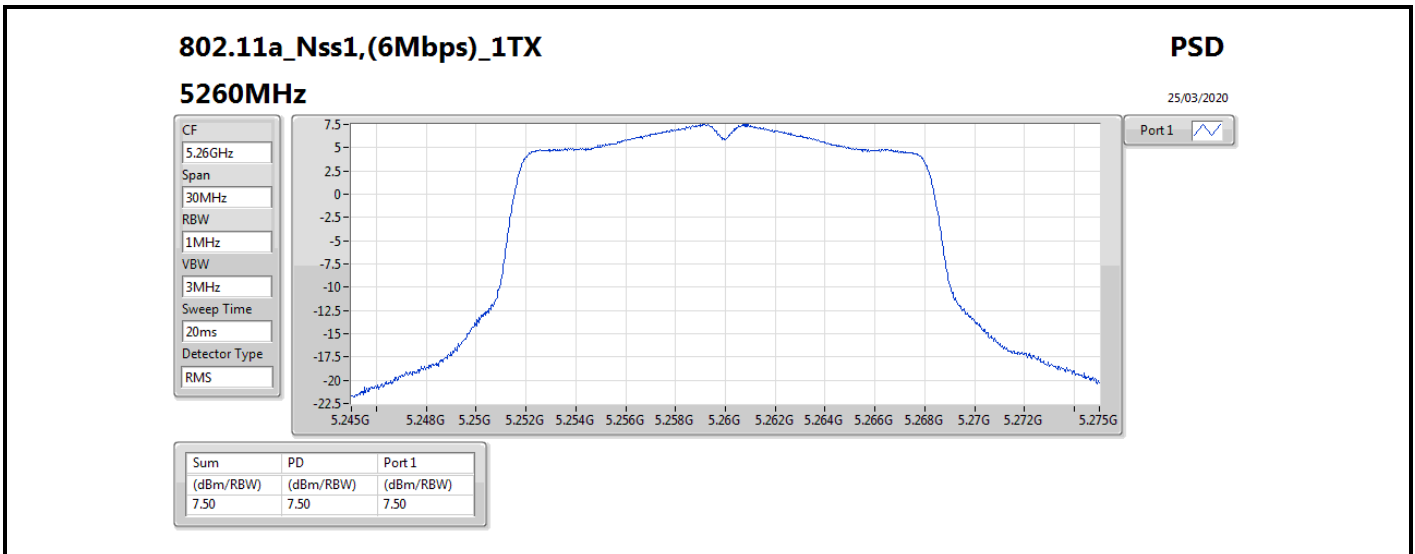

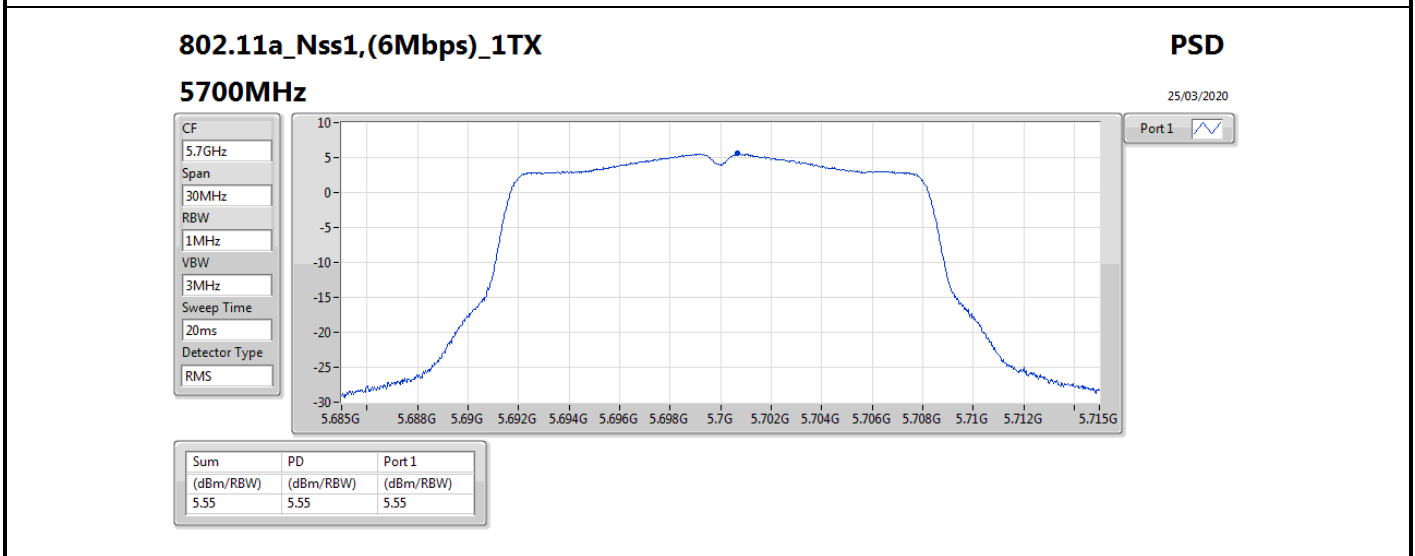
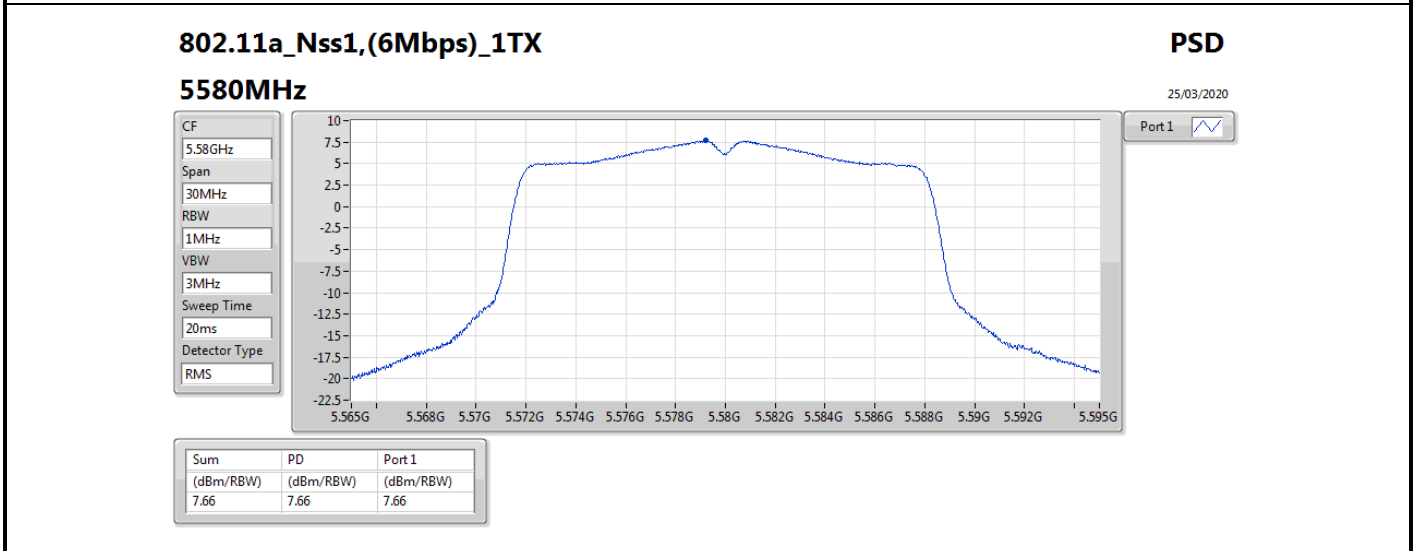
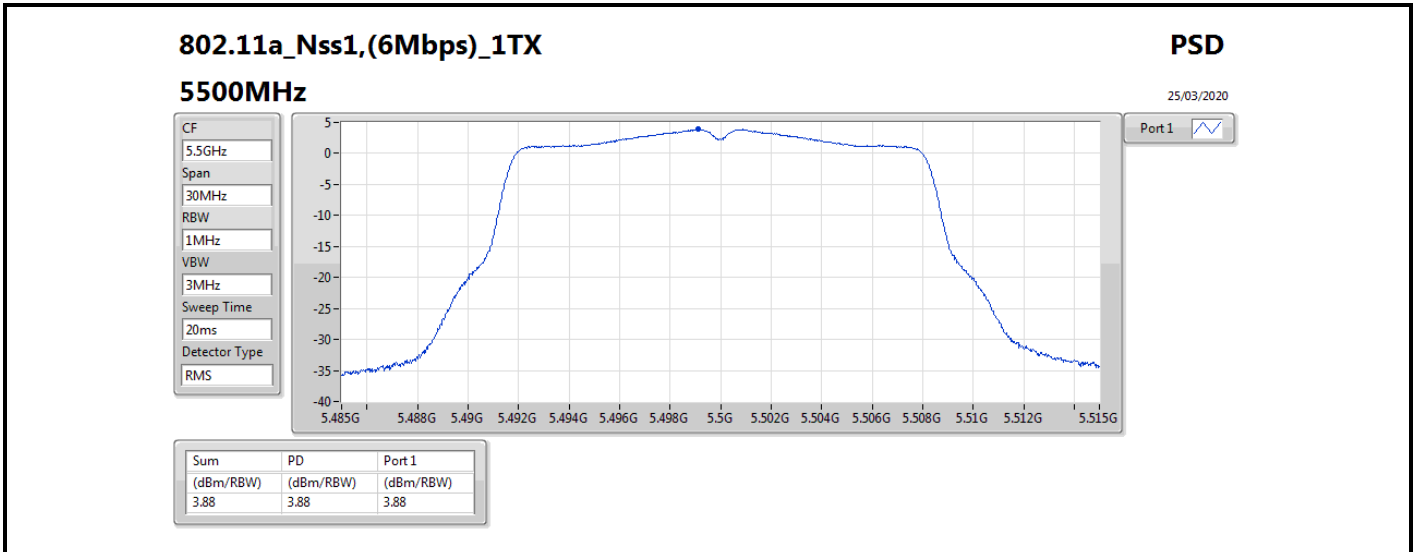

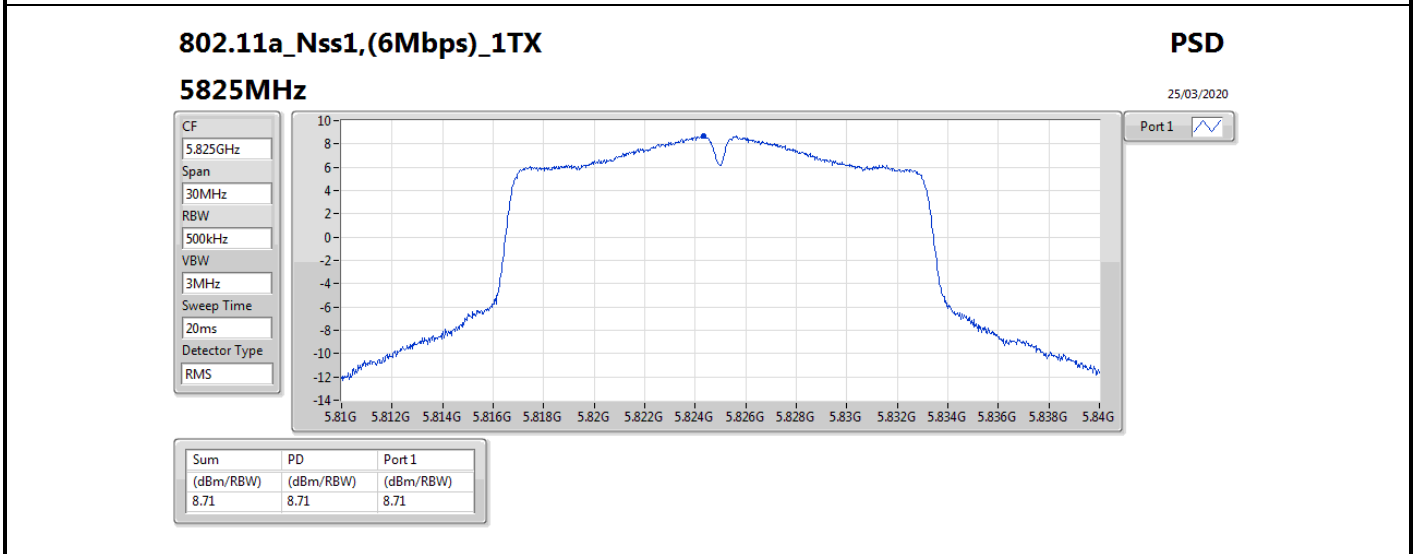
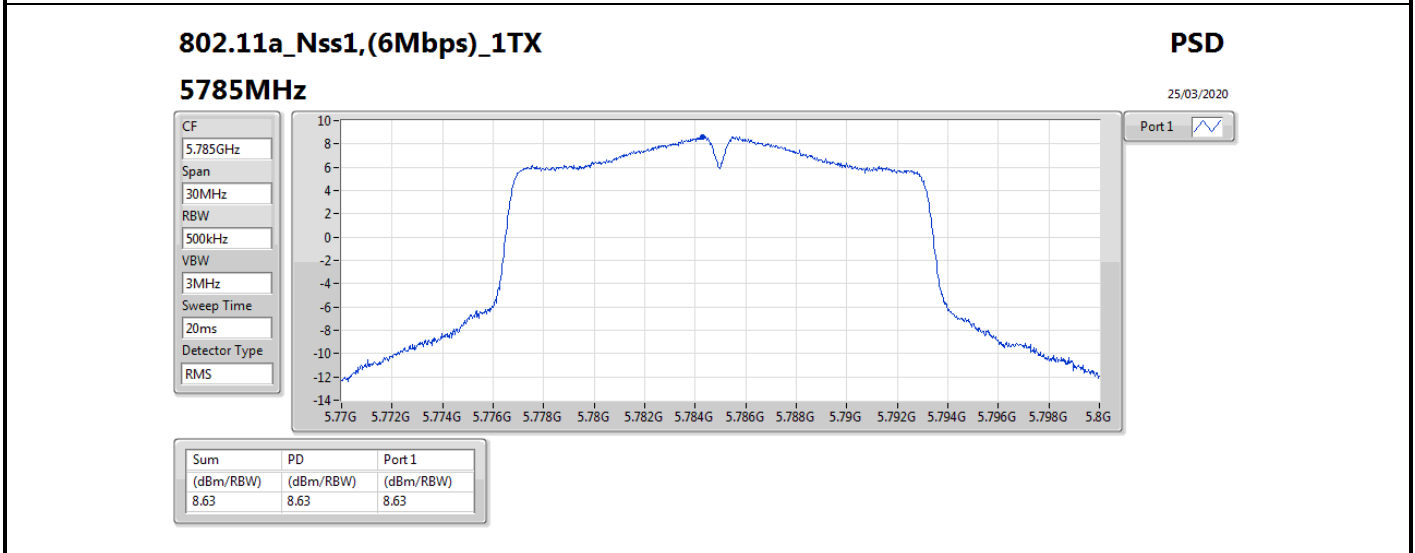
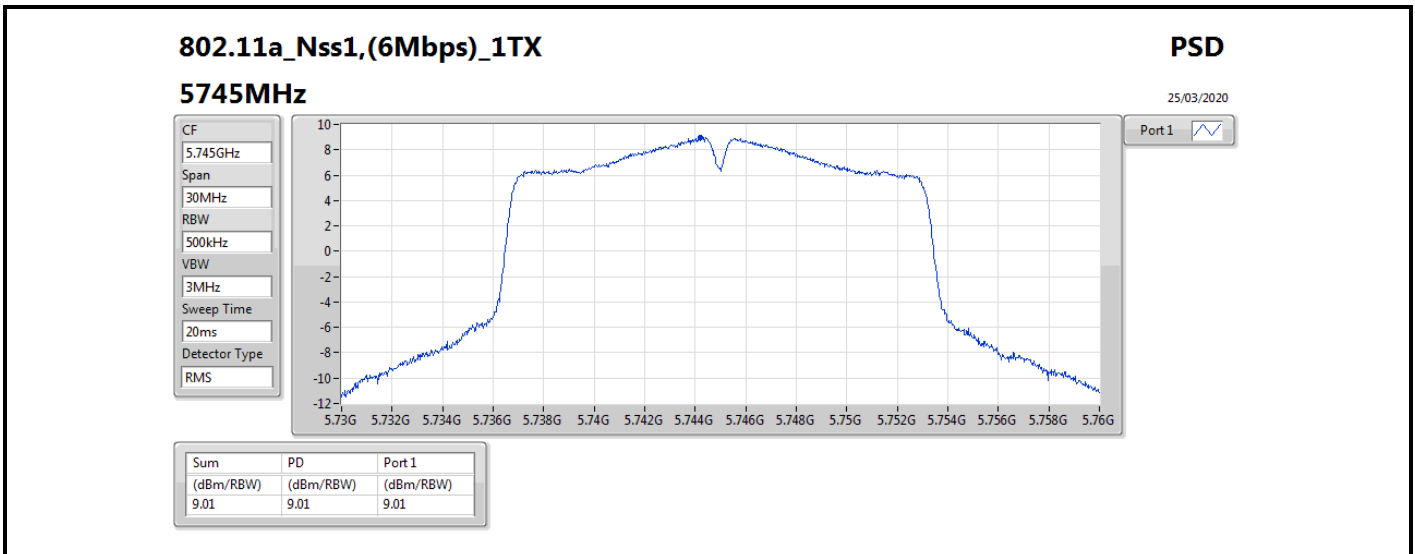

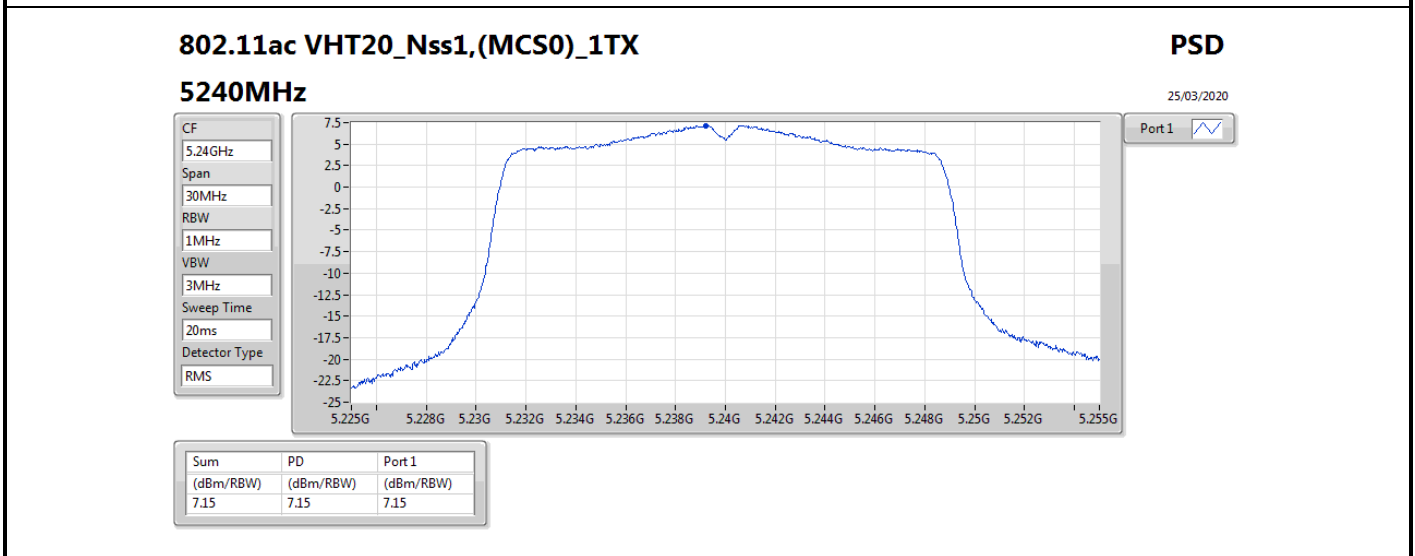
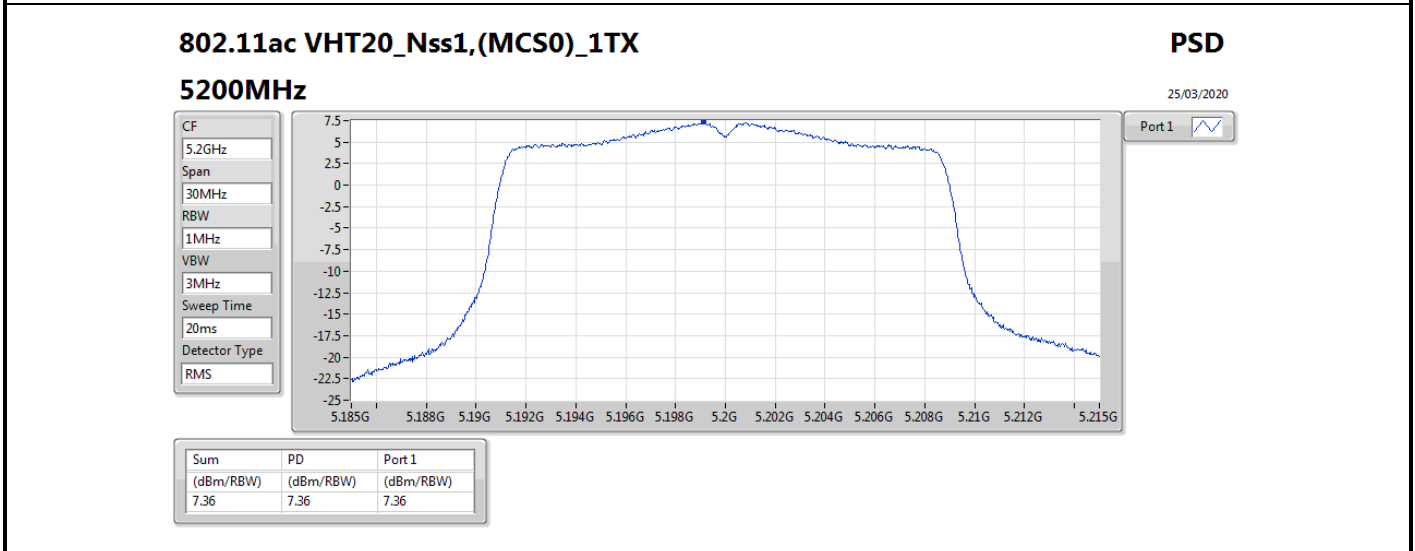
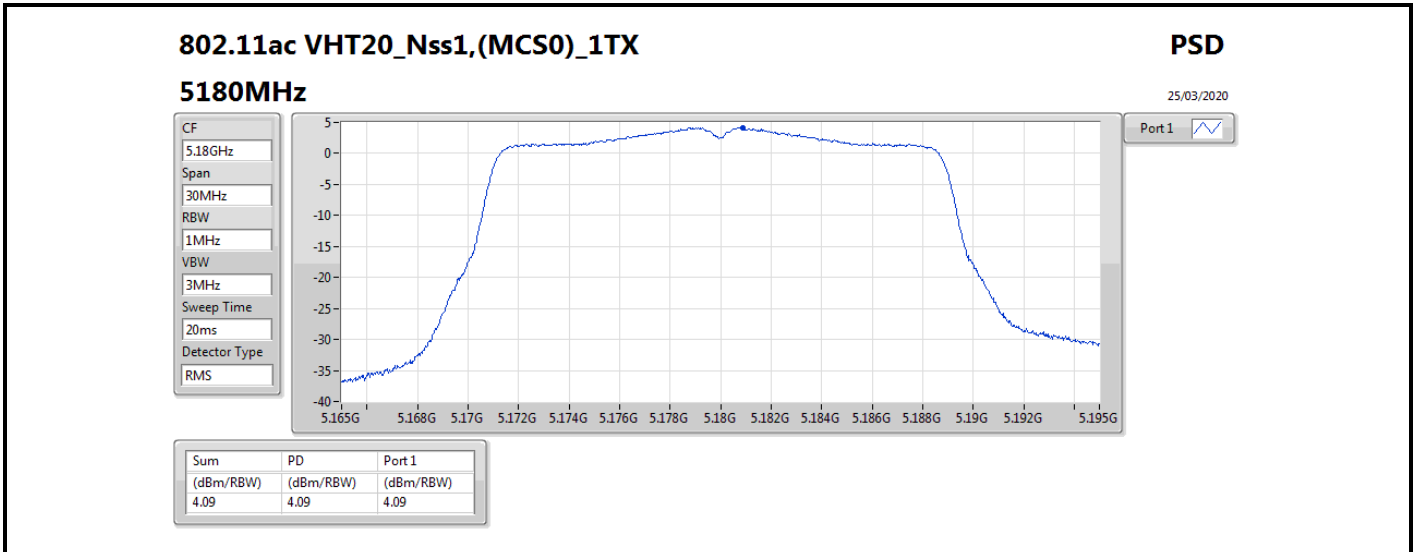

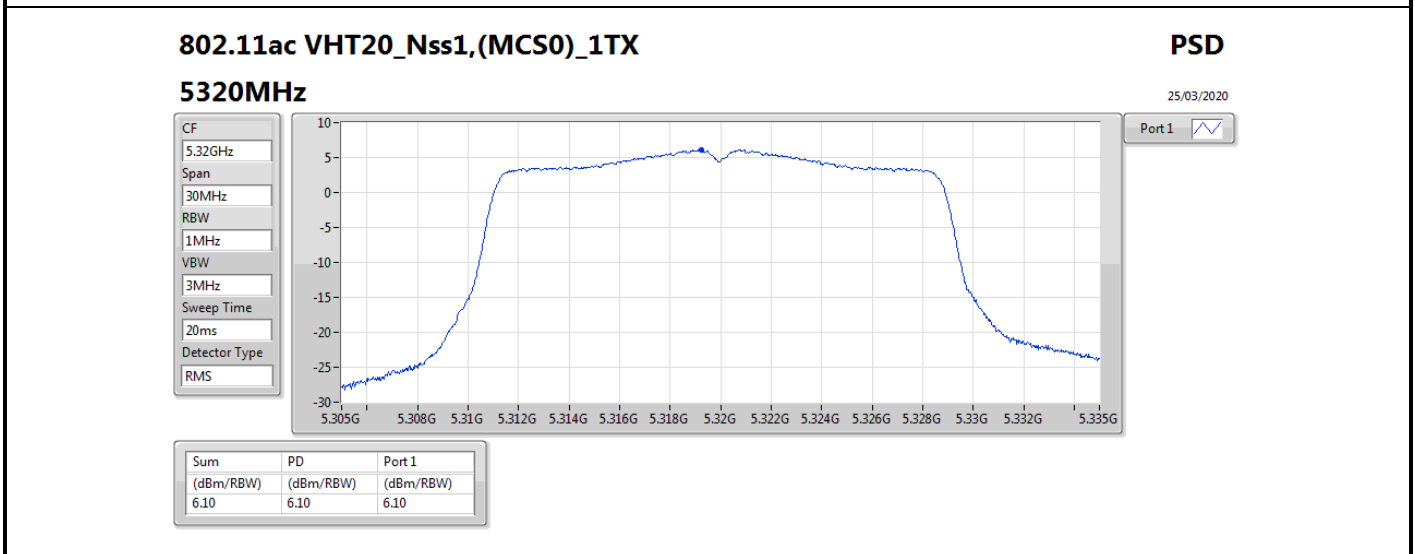
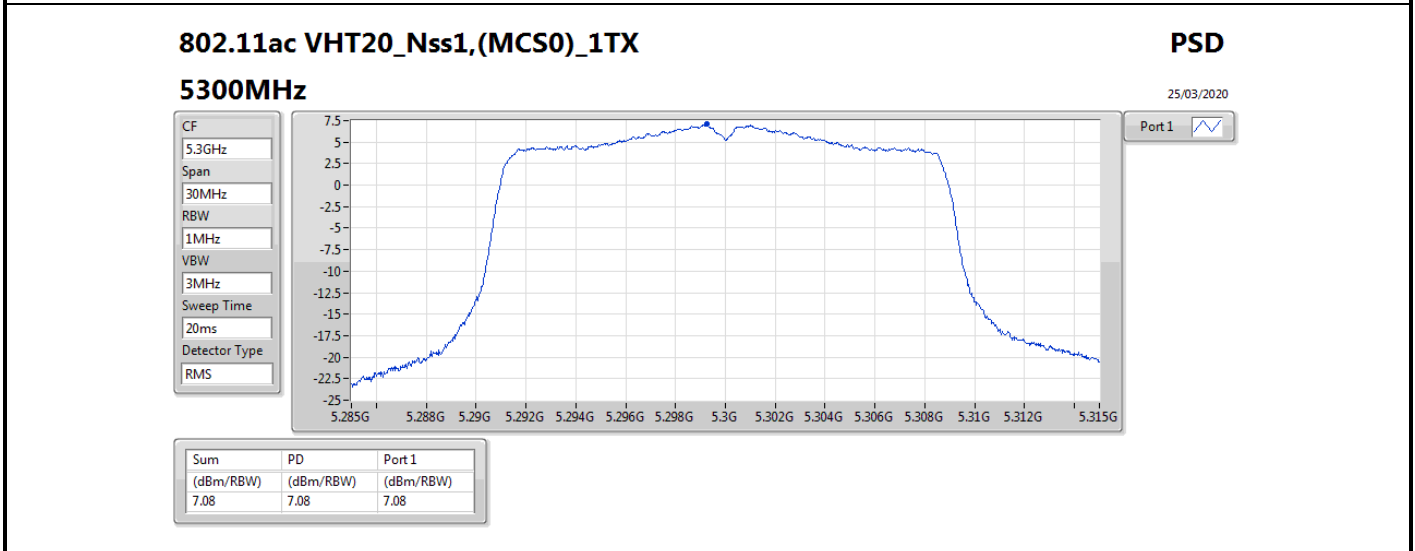
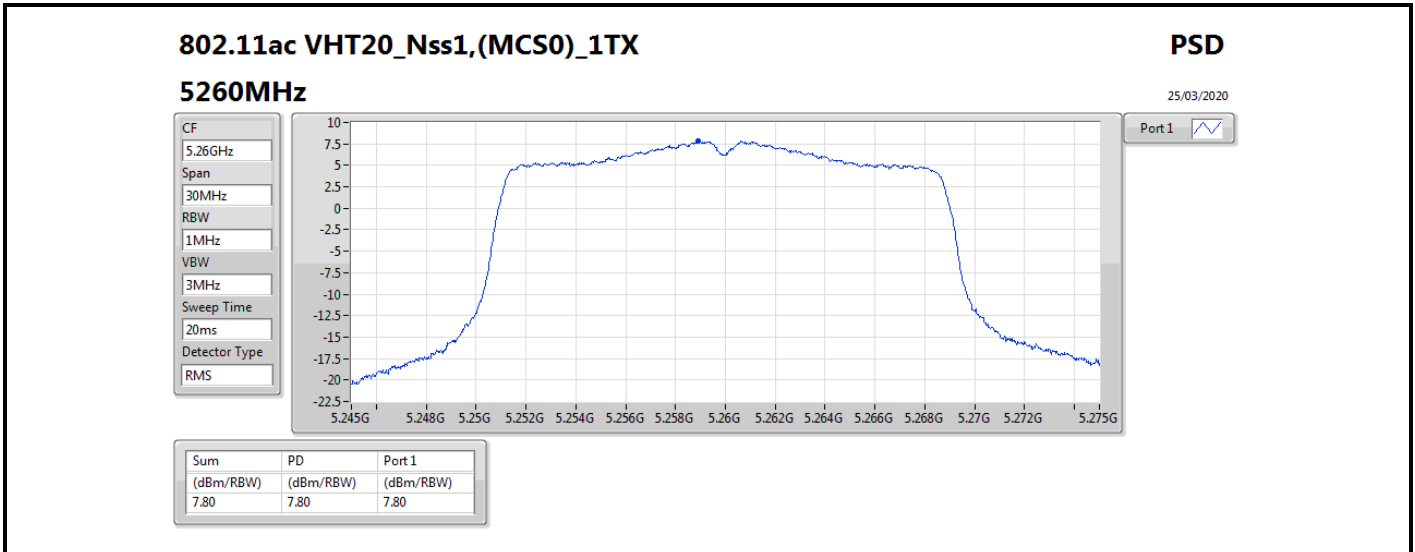

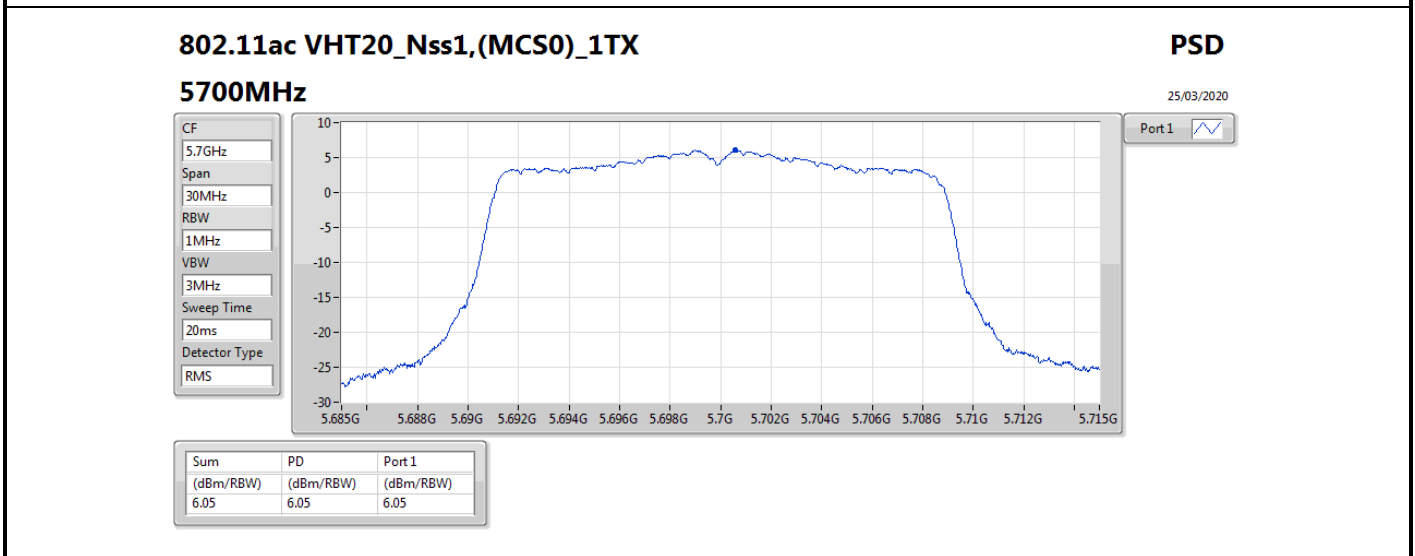
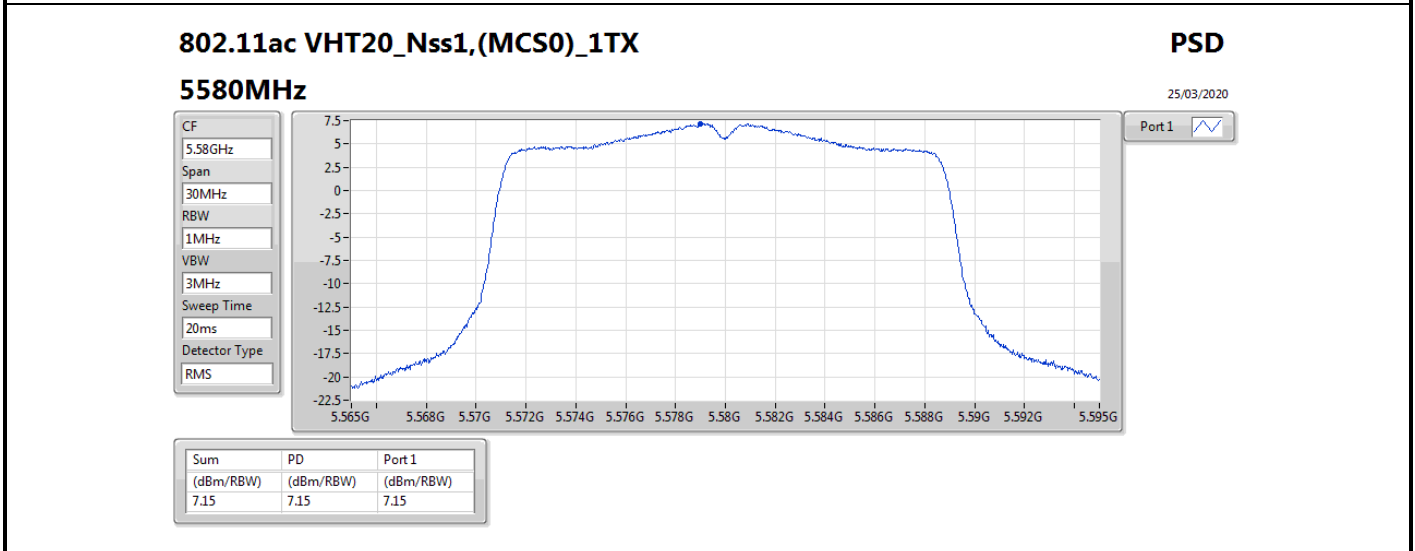
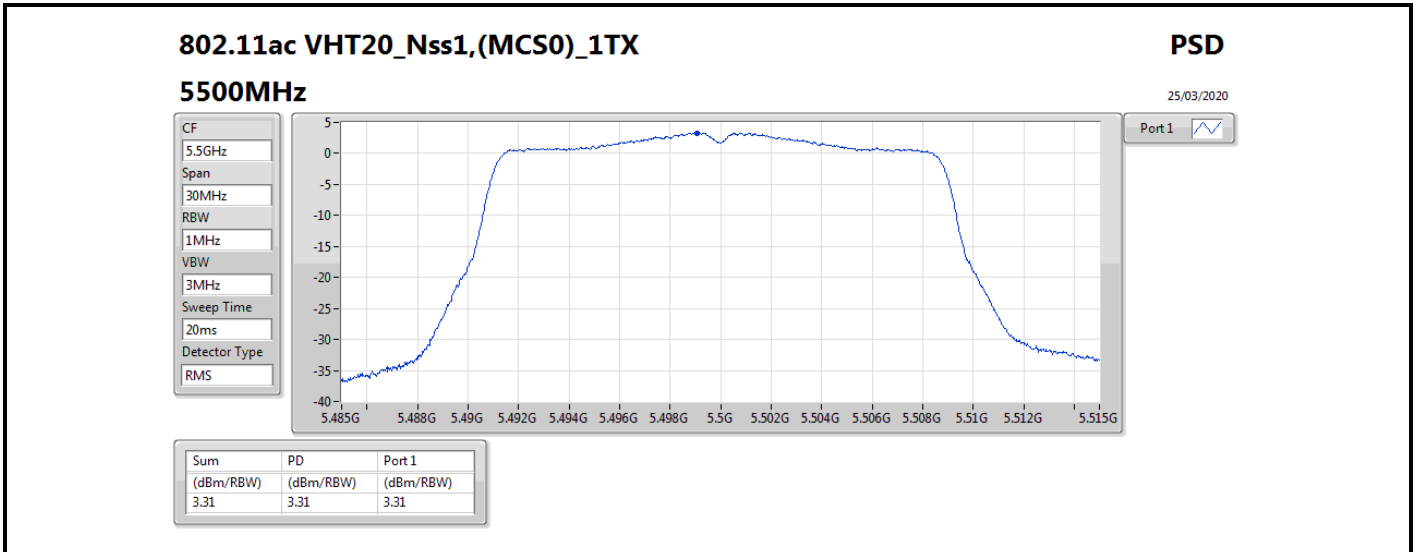

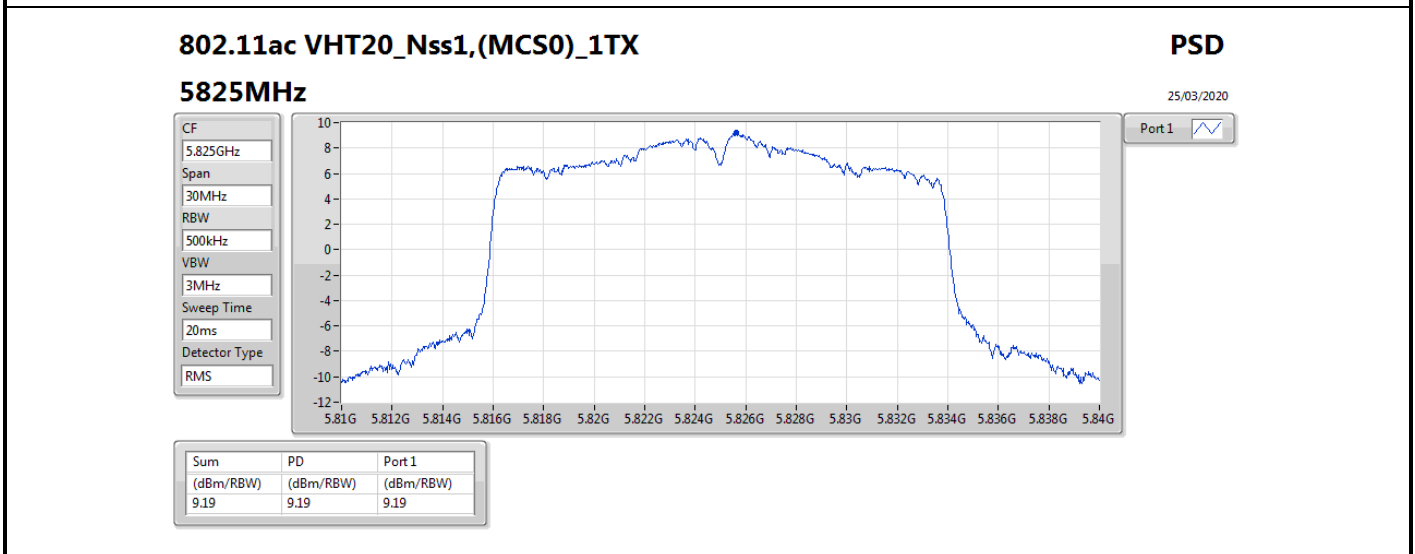
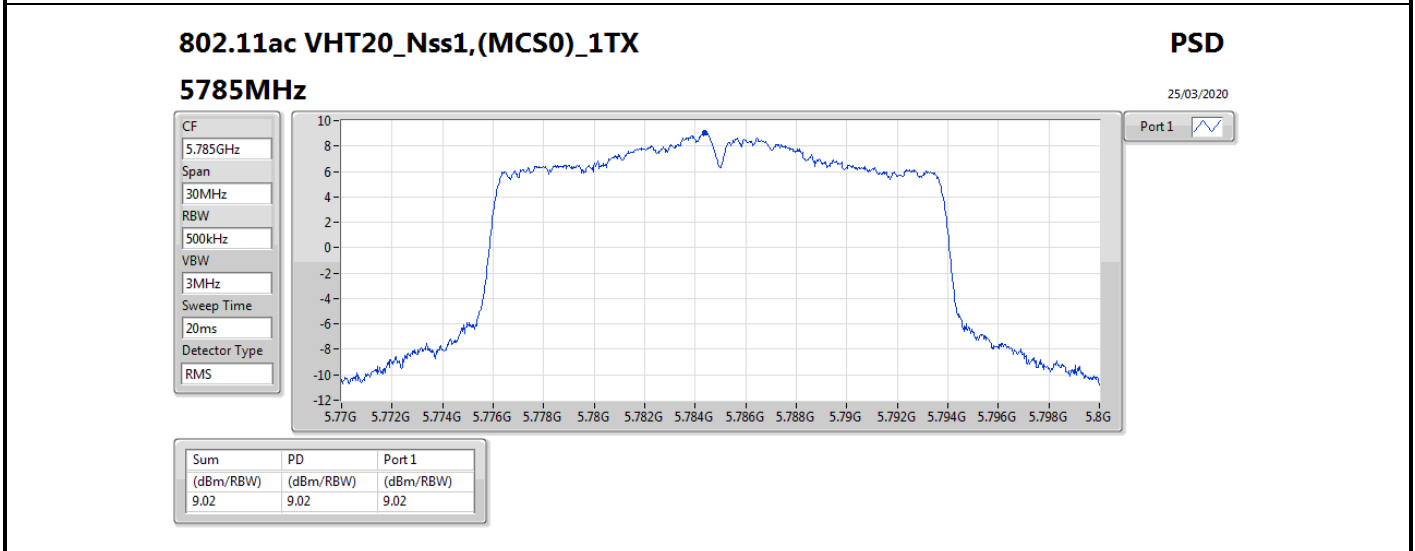
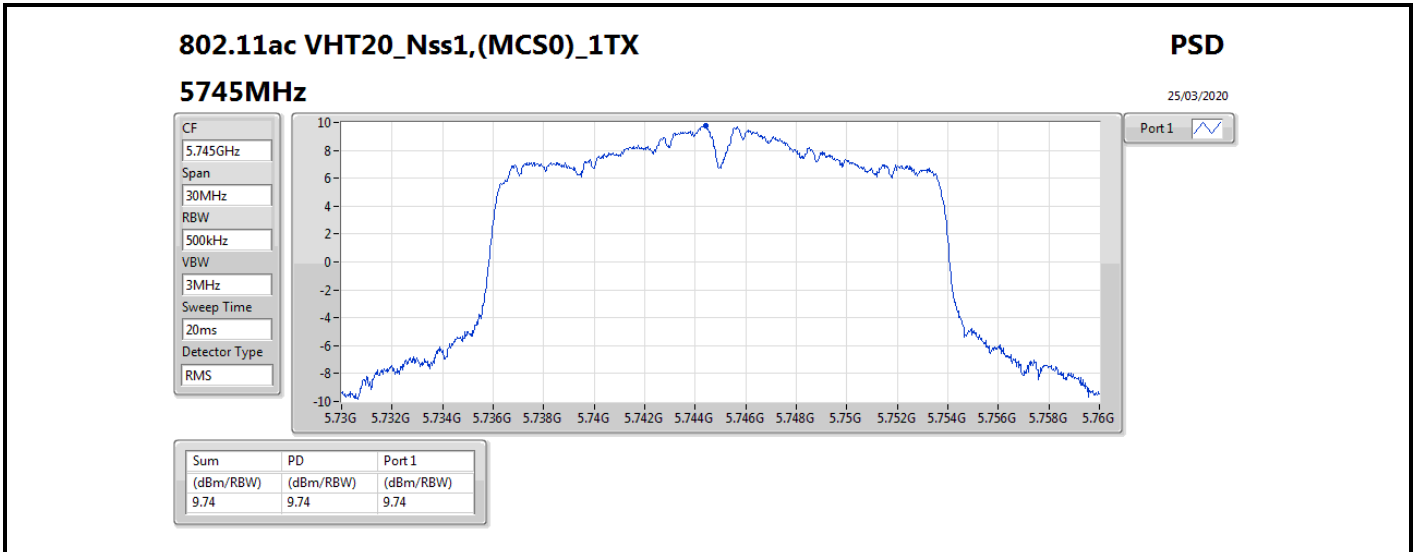

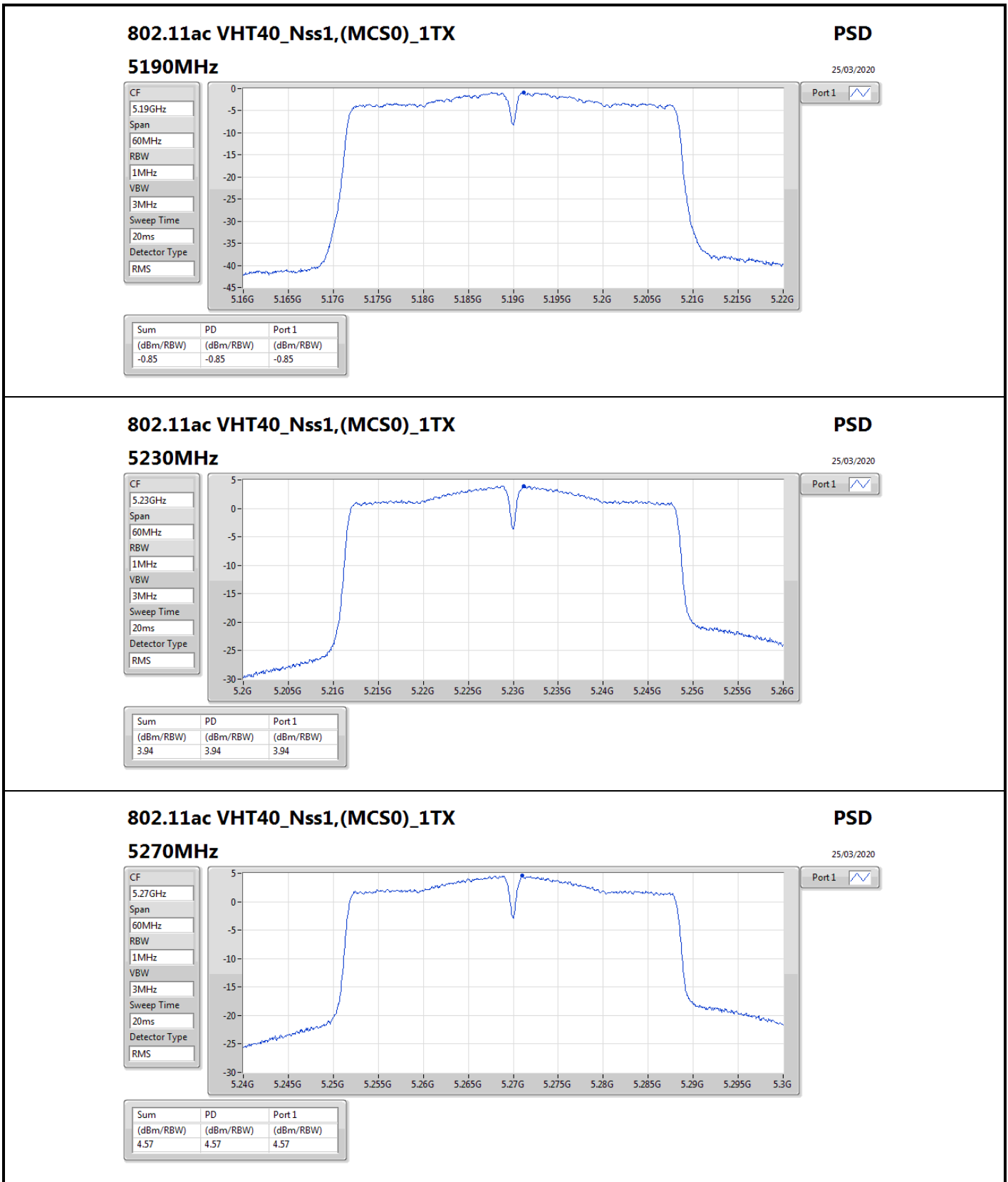

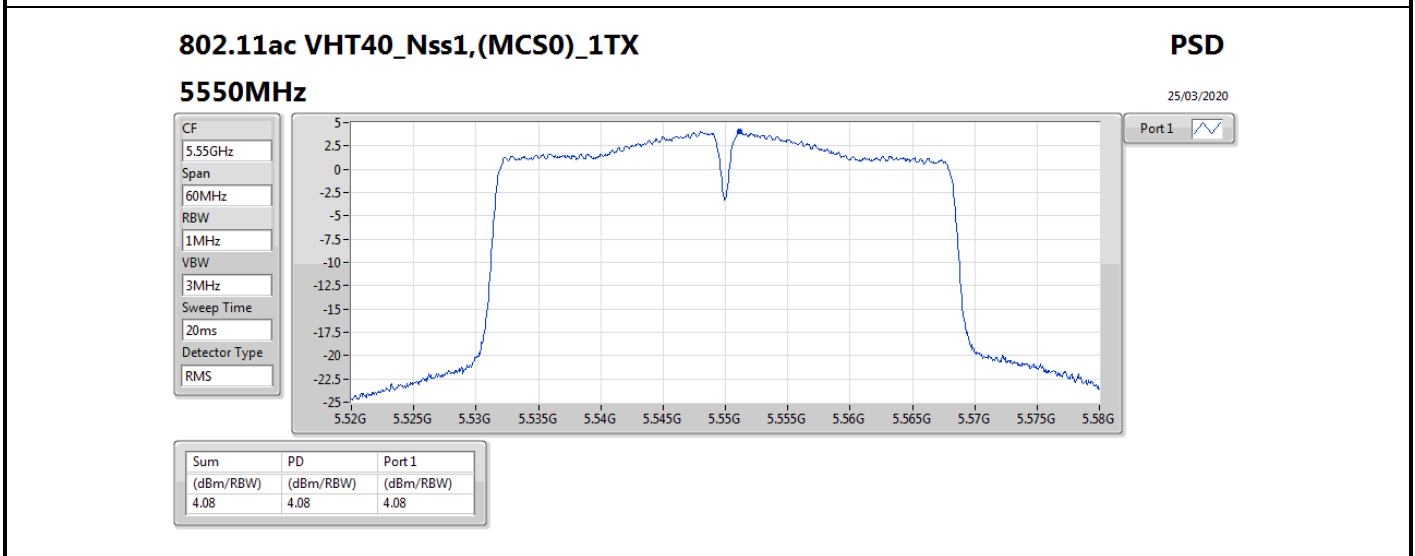
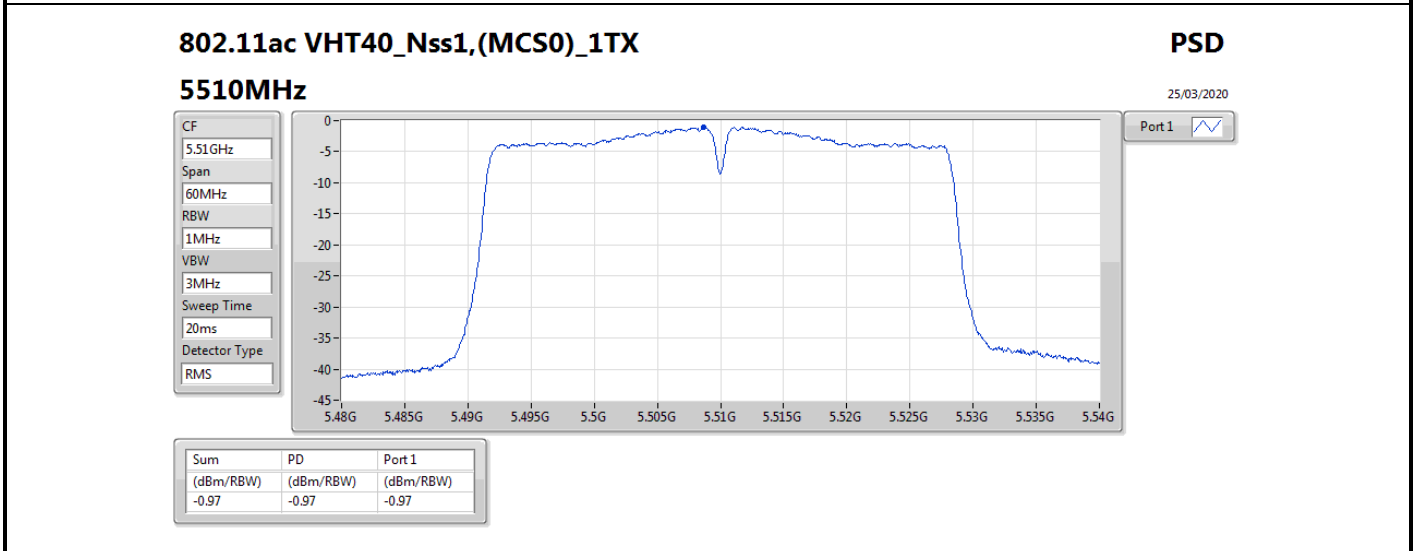
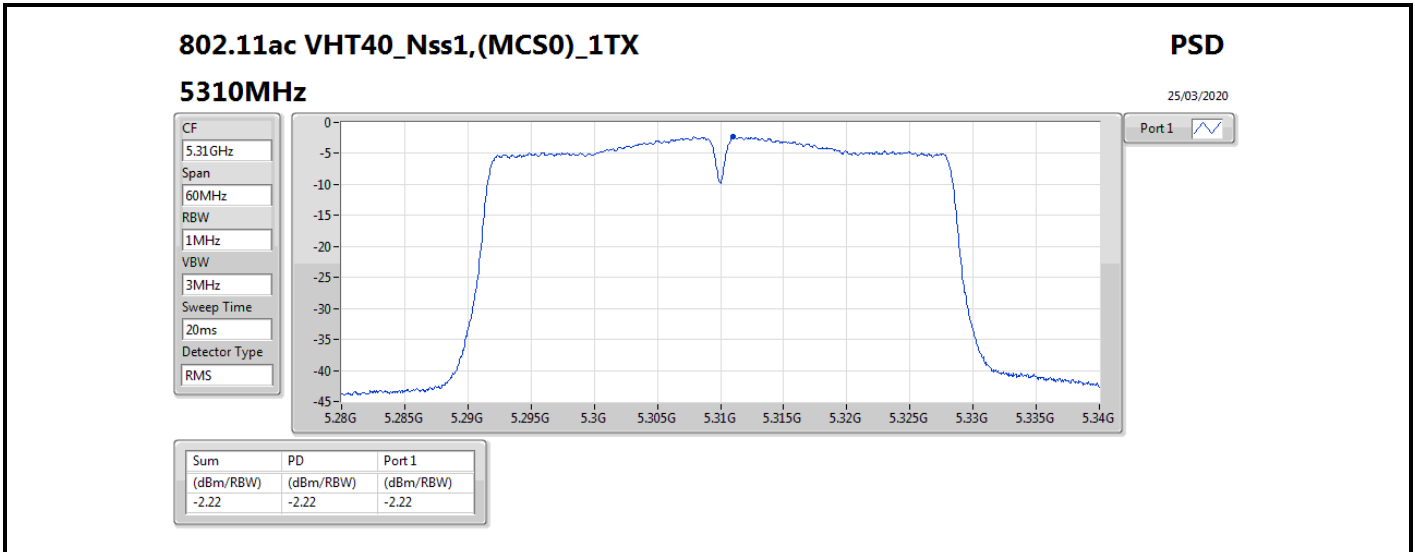

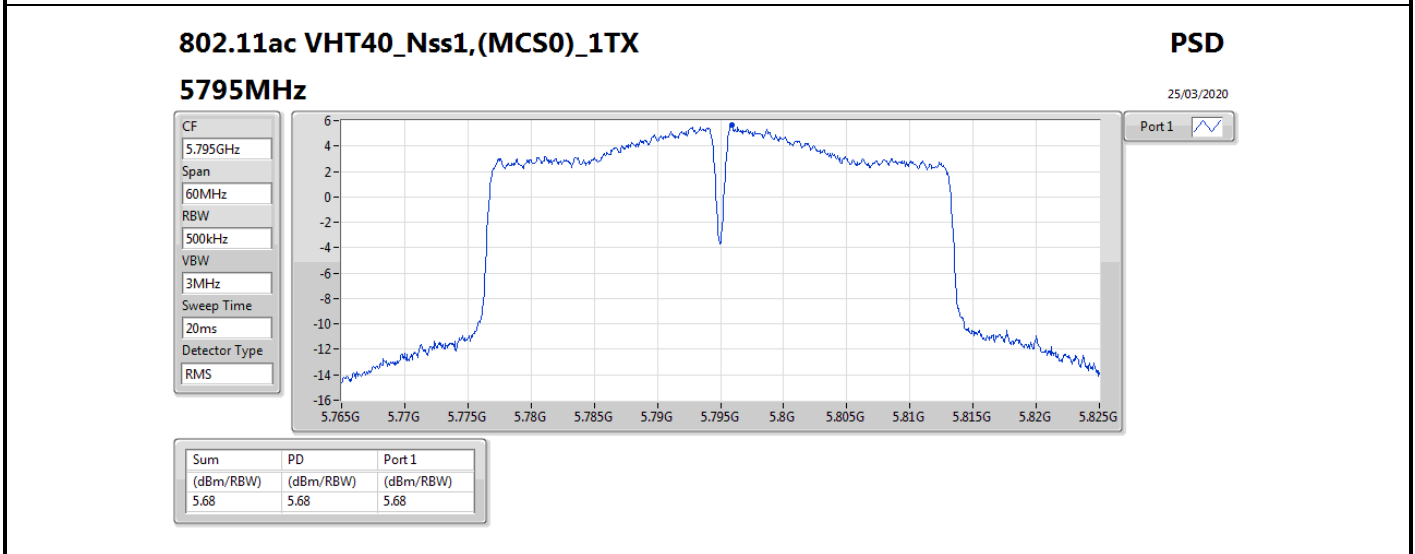
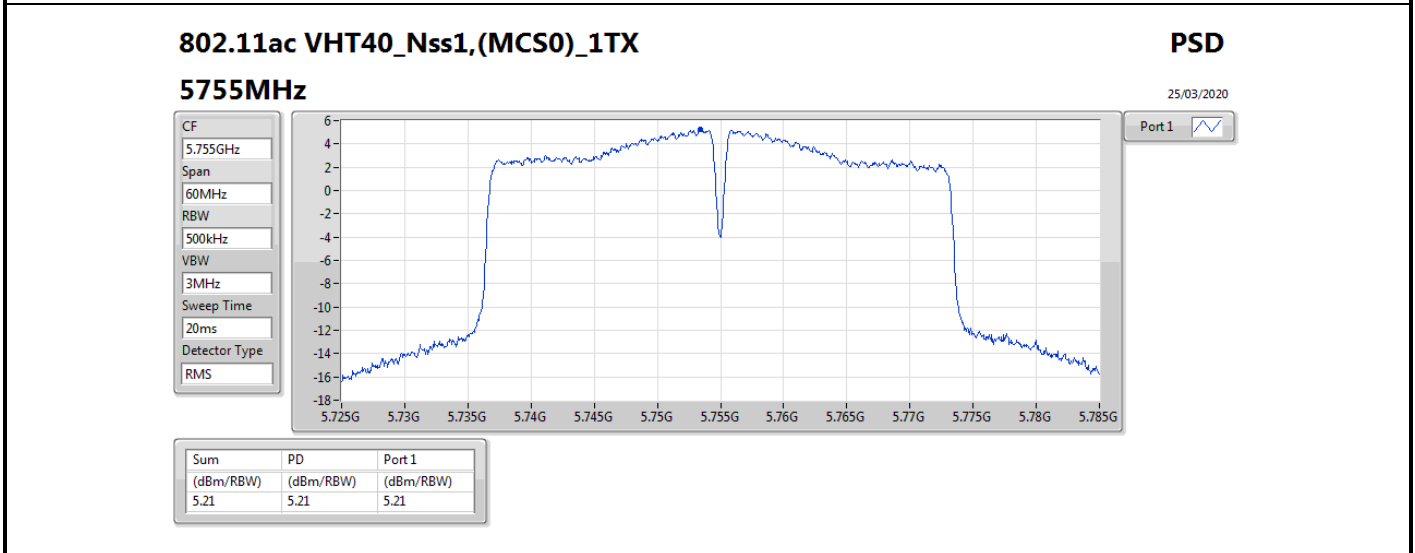
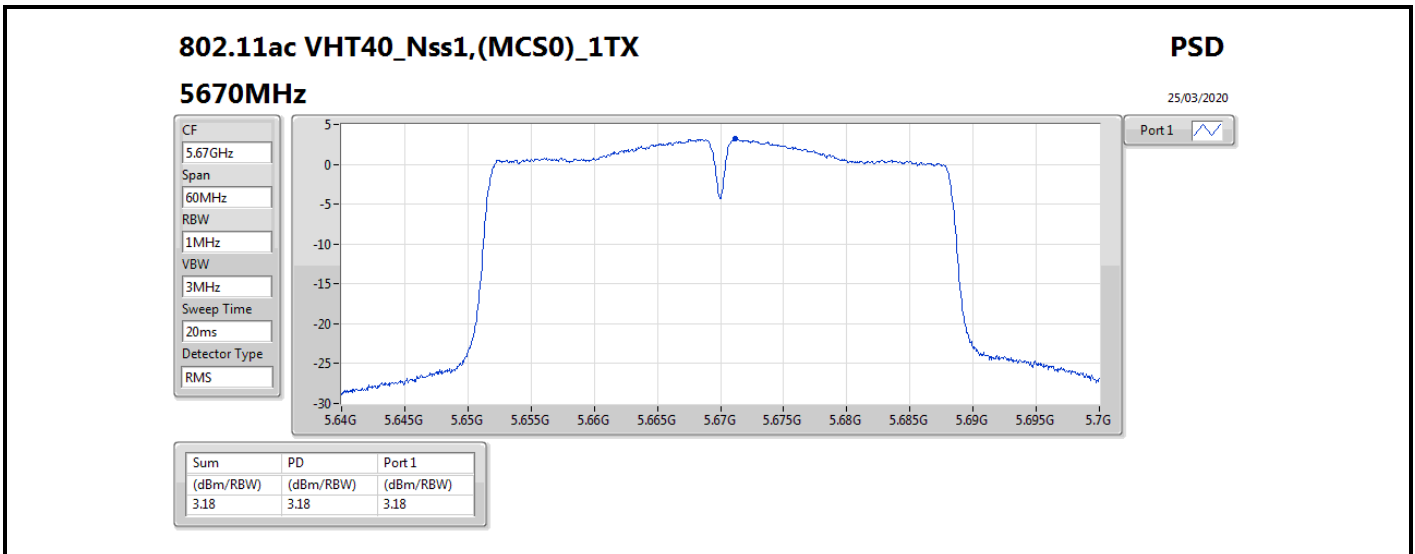

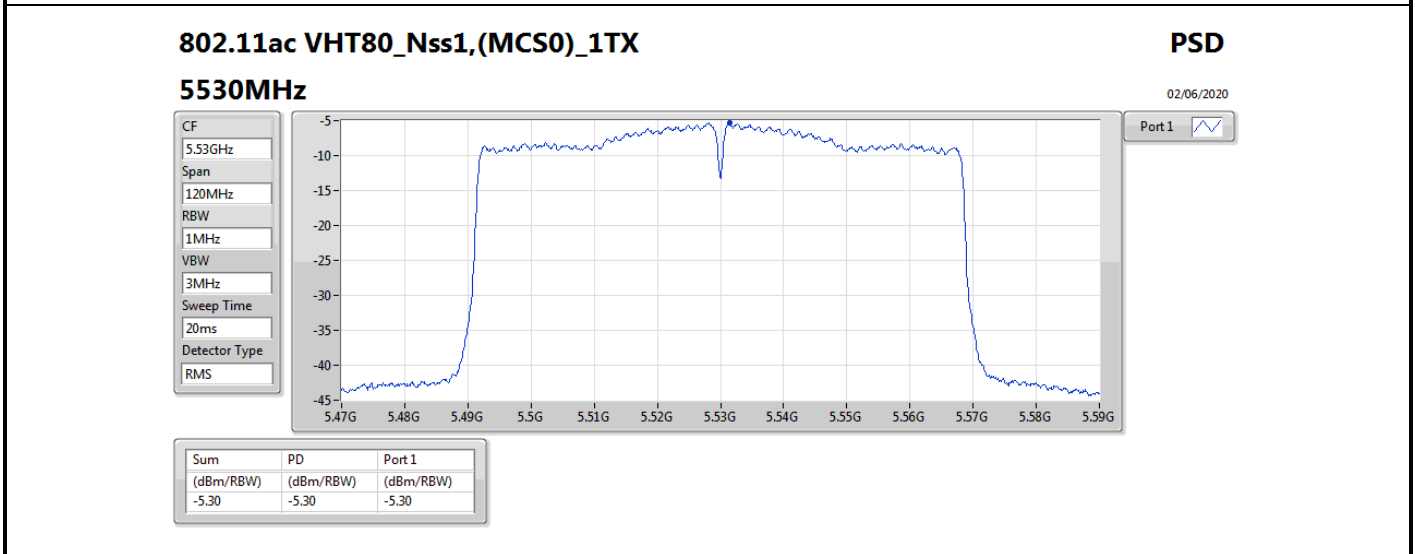
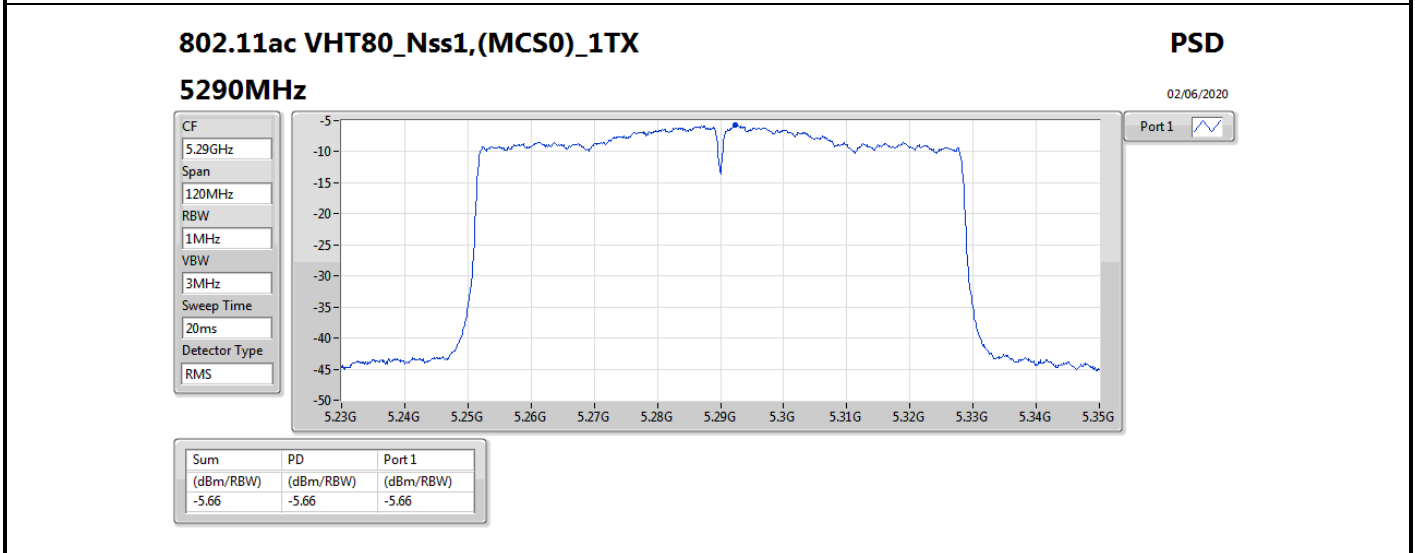
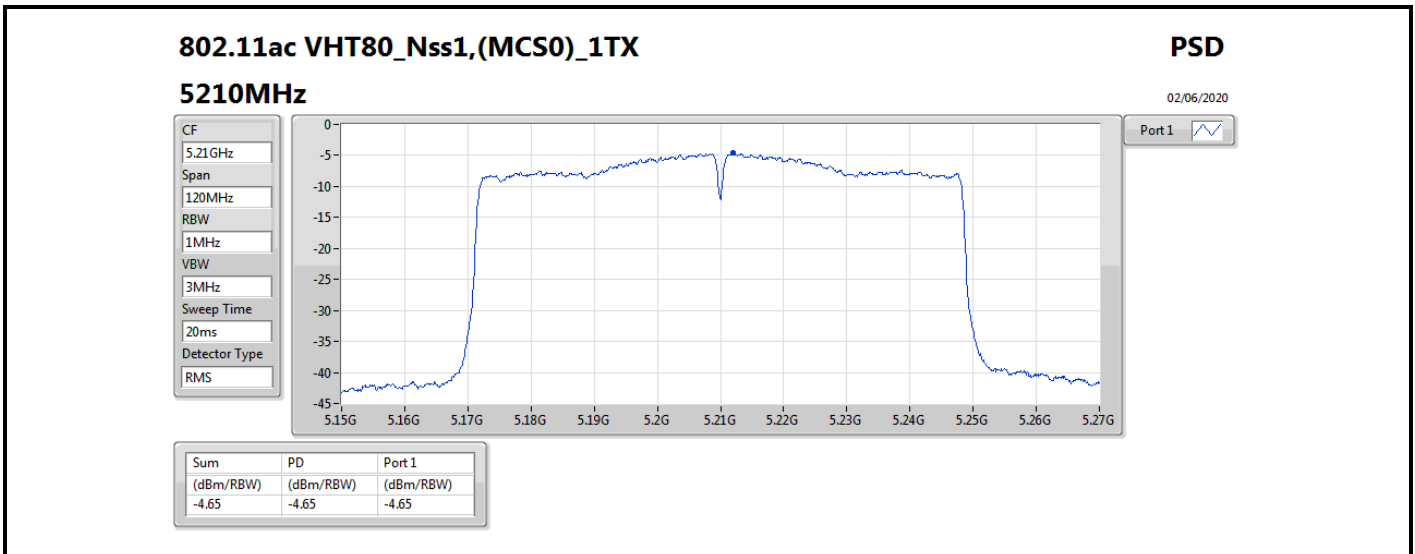

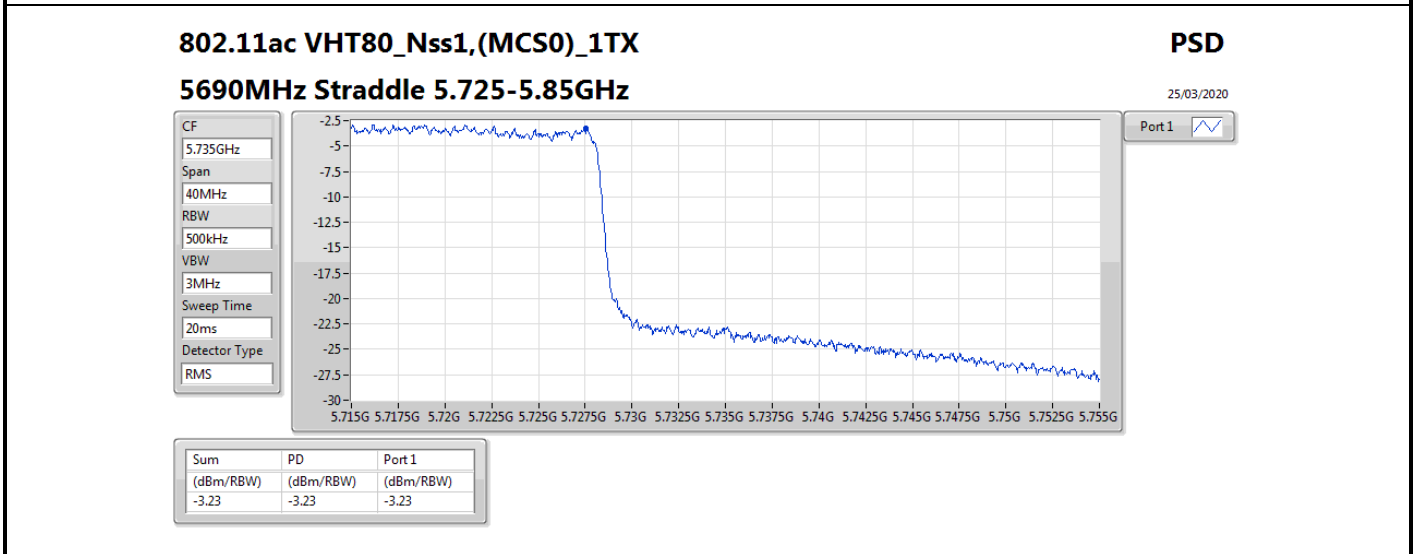
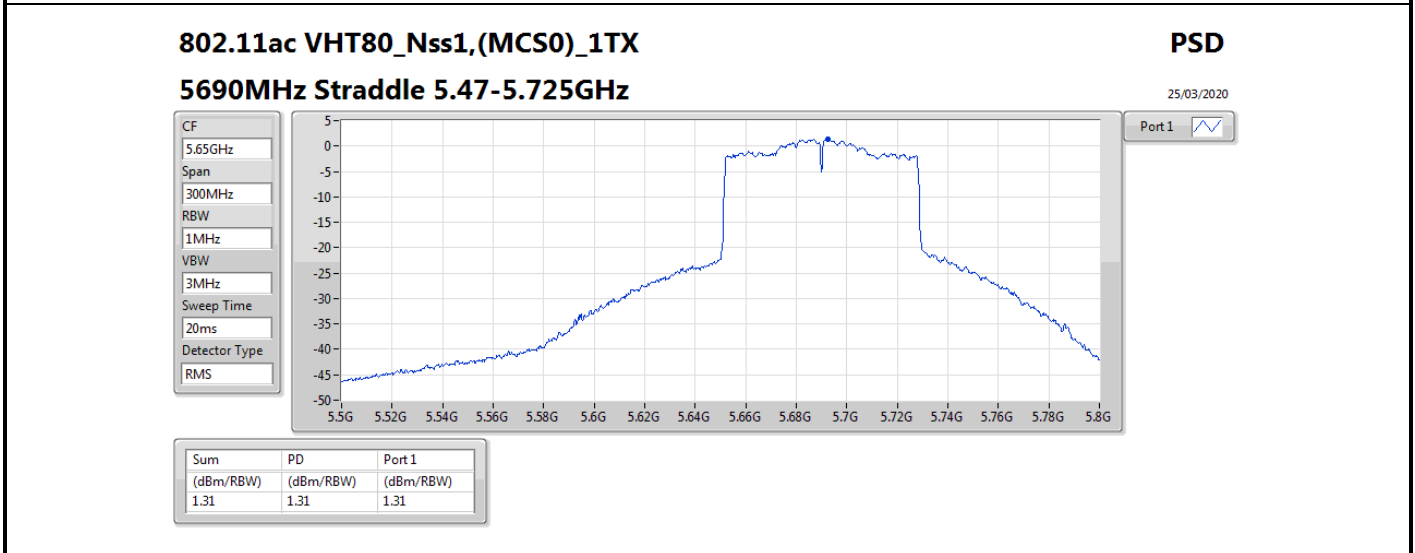
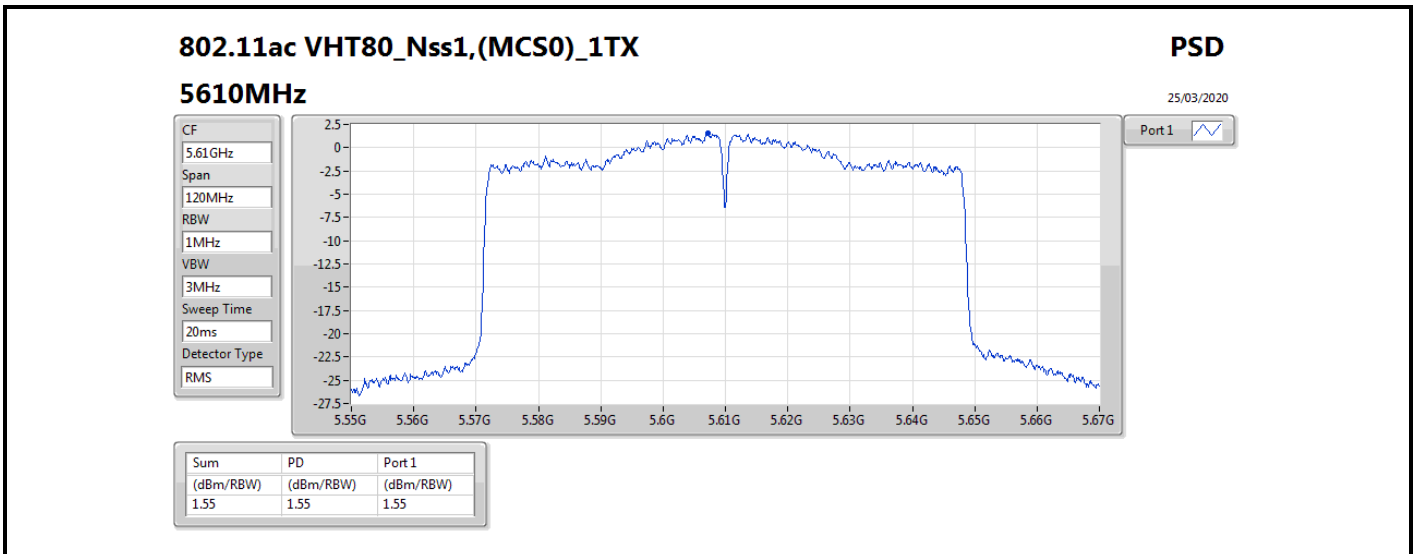

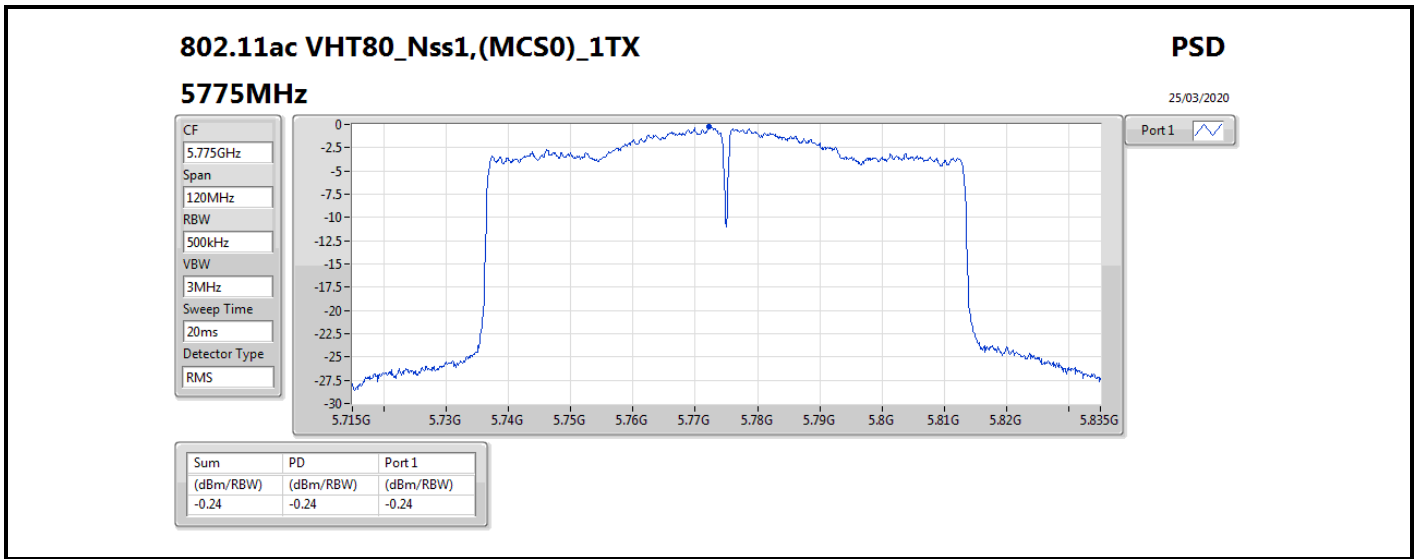

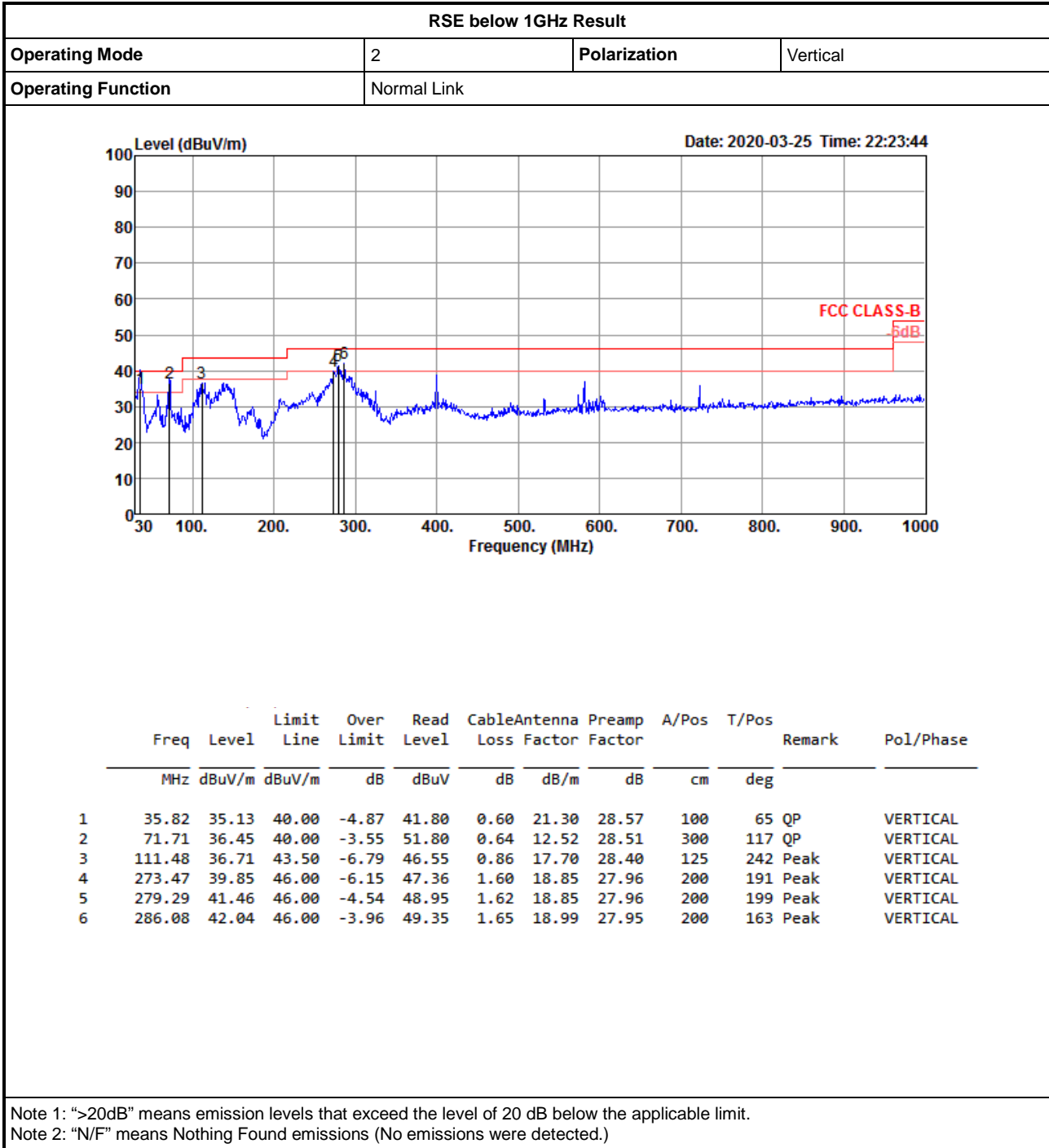



RSE below 1GHz Result

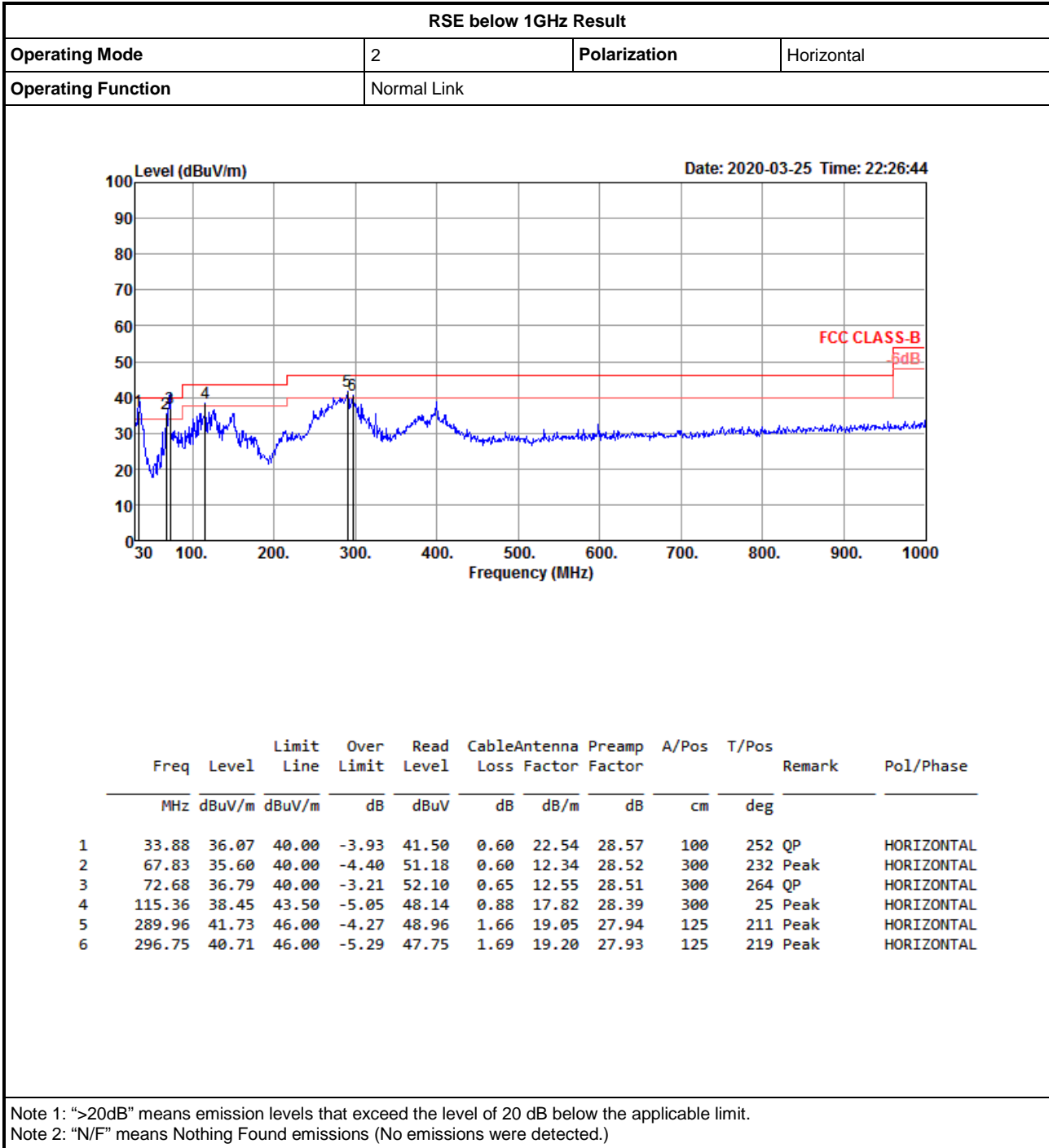



Summary

Mode	Result	Type	Freq (Hz)	Level (dBuV/m)	Limit (dBuV/m)	Margin (dB)	Dist (m)	Condition	Azimuth (°)	Height (m)	Comments
5.15-5.25GHz	-	-	-	-	-	-	-	-	-	-	-
802.11ac_VHT40_Nss1,(MCS0)_1TX	Pass	AV	5.1496G	52.94	54.00	-1.06	3	Horizontal	0	1.01	-

802.11a_Nss1,(6Mbps)_1TX

21/03/2020

5180MHz_TX

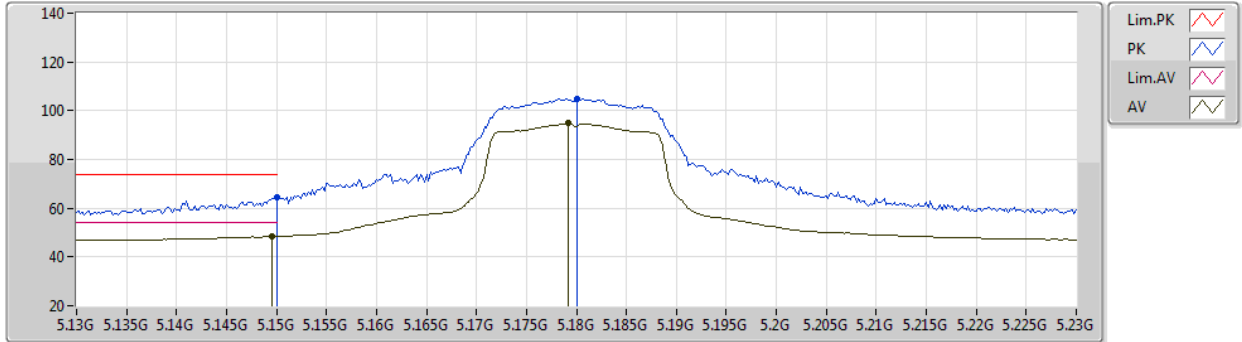

EUT X_1TX
Setting 15
02-D-E-4-10

Type	Freq (Hz)	Level (dBuV/m)	Limit (dBuV/m)	Margin (dB)	Raw (dBuV)	Dist (m)	Condition	Azimuth (°)	Height (m)	Comment	AF (dB)	CL (dB)	PA (dB)
PK	5.15G	64.40	74.00	-9.60	55.26	3	Vertical	22	2.43	-	33.55	5.97	30.38
AV	5.1496G	48.42	54.00	-5.58	39.28	3	Vertical	22	2.43	-	33.55	5.97	30.38
PK	5.18G	105.04	Inf	-Inf	95.86	3	Vertical	22	2.43	-	33.58	5.99	30.39
AV	5.1792G	94.77	Inf	-Inf	85.59	3	Vertical	22	2.43	-	33.58	5.99	30.39

802.11a_Nss1,(6Mbps)_1TX

21/03/2020

5180MHz_TX

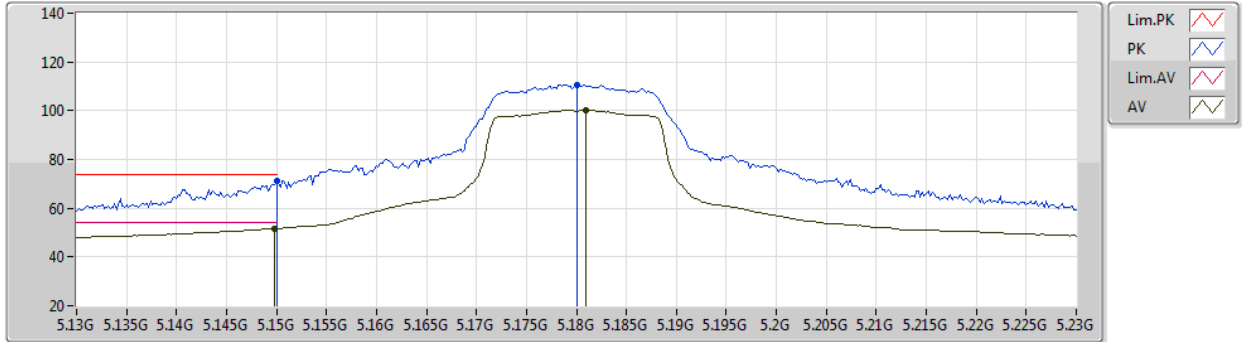

EUT X_1TX
Setting 15
02-D-E-4-10

Type	Freq (Hz)	Level (dBuV/m)	Limit (dBuV/m)	Margin (dB)	Raw (dBuV)	Dist (m)	Condition	Azimuth (°)	Height (m)	Comment	AF (dB)	CL (dB)	PA (dB)
PK	5.15G	71.13	74.00	-2.87	61.99	3	Horizontal	0	1.03	-	33.55	5.97	30.38
AV	5.1498G	51.68	54.00	-2.32	42.54	3	Horizontal	0	1.03	-	33.55	5.97	30.38
PK	5.18G	110.58	Inf	-Inf	101.40	3	Horizontal	0	1.03	-	33.58	5.99	30.39
AV	5.181G	100.36	Inf	-Inf	91.18	3	Horizontal	0	1.03	-	33.58	5.99	30.39

802.11a_Nss1,(6Mbps)_1TX

23/03/2020

5180MHz_TX

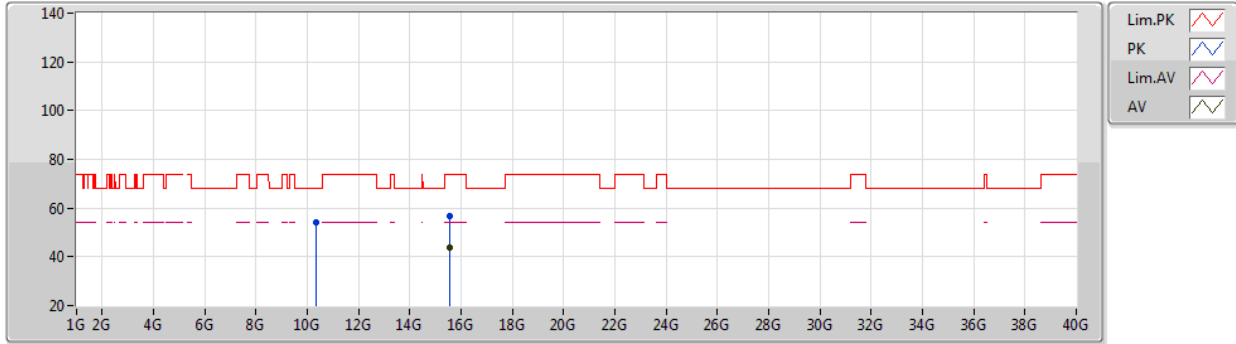

EUT X_1TX
Setting 15
02-D-J-7

Type	Freq (Hz)	Level (dBuV/m)	Limit (dBuV/m)	Margin (dB)	Raw (dBuV)	Dist (m)	Condition	Azimuth (°)	Height (m)	Comment	AF (dB)	CL (dB)	PA (dB)
PK	10.36386G	54.39	68.20	-13.81	38.52	3	Vertical	72	2.52	-	38.85	8.51	31.49
PK	15.54376G	56.96	74.00	-17.04	40.97	3	Vertical	89	2.24	-	38.72	9.25	31.98
AV	15.542G	43.78	54.00	-10.22	27.78	3	Vertical	89	2.24	-	38.73	9.25	31.98

802.11a_Nss1,(6Mbps)_1TX

23/03/2020

5180MHz_TX

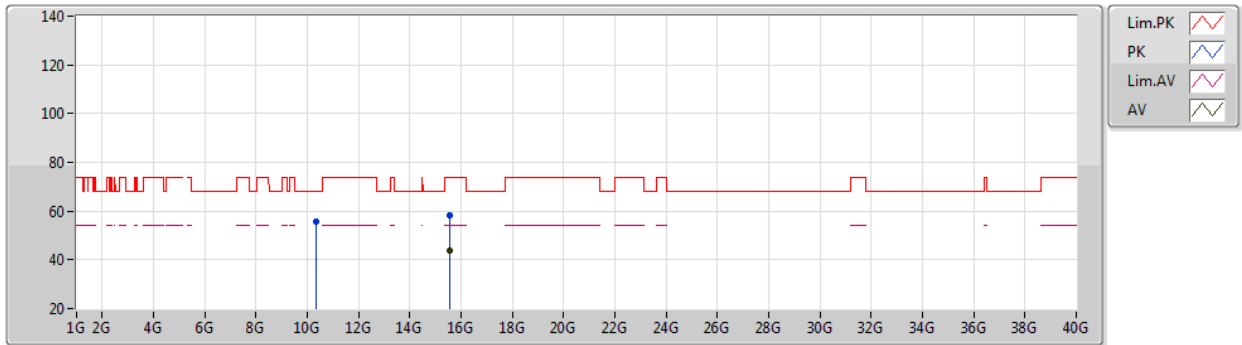

EUT X_1TX
Setting 15
02-D-J-7

Type	Freq (Hz)	Level (dBuV/m)	Limit (dBuV/m)	Margin (dB)	Raw (dBuV)	Dist (m)	Condition	Azimuth (°)	Height (m)	Comment	AF (dB)	CL (dB)	PA (dB)
PK	10.35924G	55.57	68.20	-12.63	39.70	3	Horizontal	198	1.10	-	38.85	8.51	31.49
PK	15.53522G	58.37	74.00	-15.63	42.35	3	Horizontal	266	1.12	-	38.75	9.25	31.98
AV	15.5433G	44.00	54.00	-10.00	28.01	3	Horizontal	266	1.12	-	38.72	9.25	31.98

802.11a_Nss1,(6Mbps)_1TX

23/03/2020

5200MHz_TX

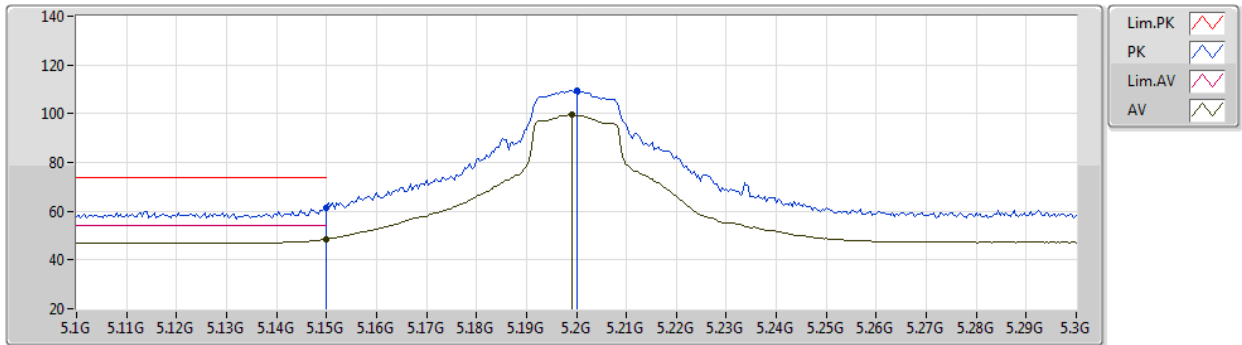

EUT X_1TX
Setting 21
02-D-J-7-10

Type	Freq (Hz)	Level (dBuV/m)	Limit (dBuV/m)	Margin (dB)	Raw (dBuV)	Dist (m)	Condition	Azimuth (°)	Height (m)	Comment	AF (dB)	CL (dB)	PA (dB)
PK	5.15G	61.49	74.00	-12.51	52.35	3	Vertical	21	2.65	-	33.55	5.97	30.38
AV	5.15G	48.42	54.00	-5.58	39.28	3	Vertical	21	2.65	-	33.55	5.97	30.38
PK	5.2G	109.58	Inf	-Inf	100.38	3	Vertical	21	2.65	-	33.60	6.00	30.40
AV	5.1992G	99.73	Inf	-Inf	90.53	3	Vertical	21	2.65	-	33.60	6.00	30.40

802.11a_Nss1,(6Mbps)_1TX

23/03/2020

5200MHz_TX

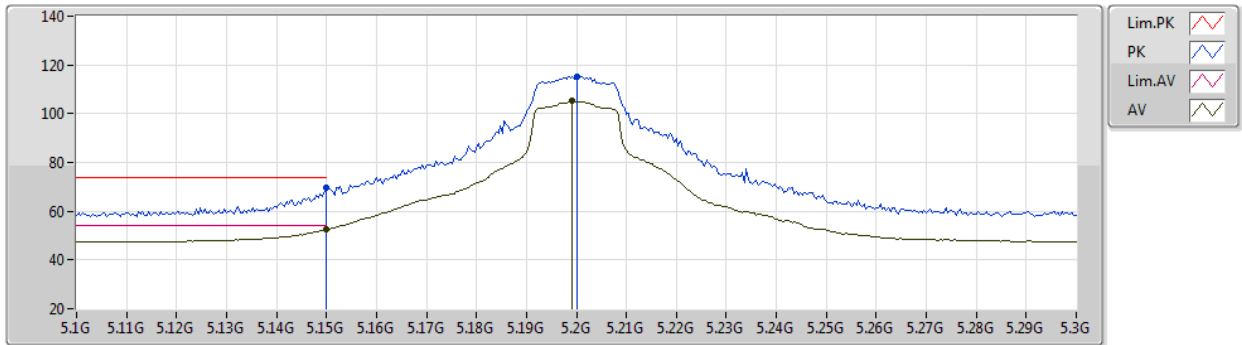

EUT X_1TX
Setting 21
02-D-J-7-10

Type	Freq (Hz)	Level (dBuV/m)	Limit (dBuV/m)	Margin (dB)	Raw (dBuV)	Dist (m)	Condition	Azimuth (°)	Height (m)	Comment	AF (dB)	CL (dB)	PA (dB)
PK	5.15G	69.73	74.00	-4.27	60.59	3	Horizontal	0	1.00	-	33.55	5.97	30.38
AV	5.15G	52.34	54.00	-1.66	43.20	3	Horizontal	0	1.00	-	33.55	5.97	30.38
PK	5.2G	115.24	Inf	-Inf	106.04	3	Horizontal	0	1.00	-	33.60	6.00	30.40
AV	5.1992G	105.14	Inf	-Inf	95.94	3	Horizontal	0	1.00	-	33.60	6.00	30.40

802.11a_Nss1,(6Mbps)_1TX

23/03/2020

5200MHz_TX

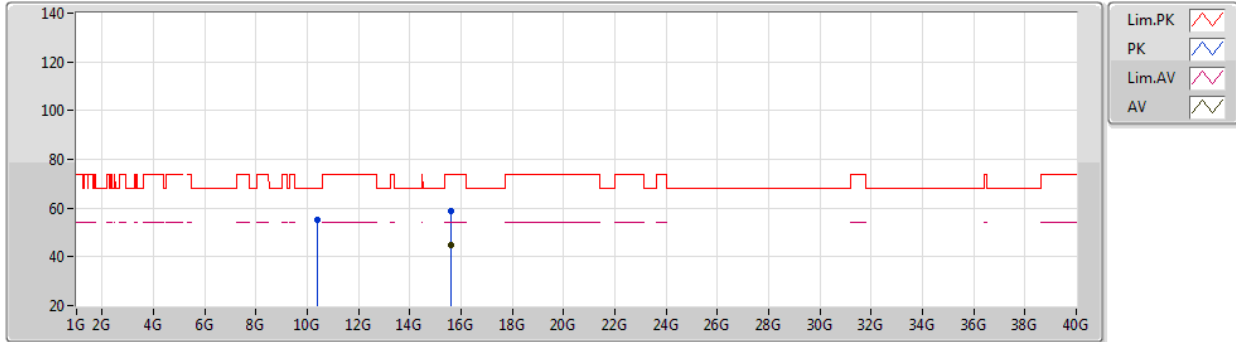

EUT X_1TX
Setting 21
02-D-J-7

Type	Freq (Hz)	Level (dBuV/m)	Limit (dBuV/m)	Margin (dB)	Raw (dBuV)	Dist (m)	Condition	Azimuth (°)	Height (m)	Comment	AF (dB)	CL (dB)	PA (dB)
PK	10.4002G	55.06	68.20	-13.14	39.21	3	Vertical	347	1.16	-	38.82	8.52	31.49
PK	15.60054G	58.59	74.00	-15.41	42.75	3	Vertical	236	2.75	-	38.56	9.27	31.99
AV	15.59935G	44.62	54.00	-9.38	28.78	3	Vertical	236	2.75	-	38.56	9.27	31.99

802.11a_Nss1,(6Mbps)_1TX

23/03/2020

5200MHz_TX

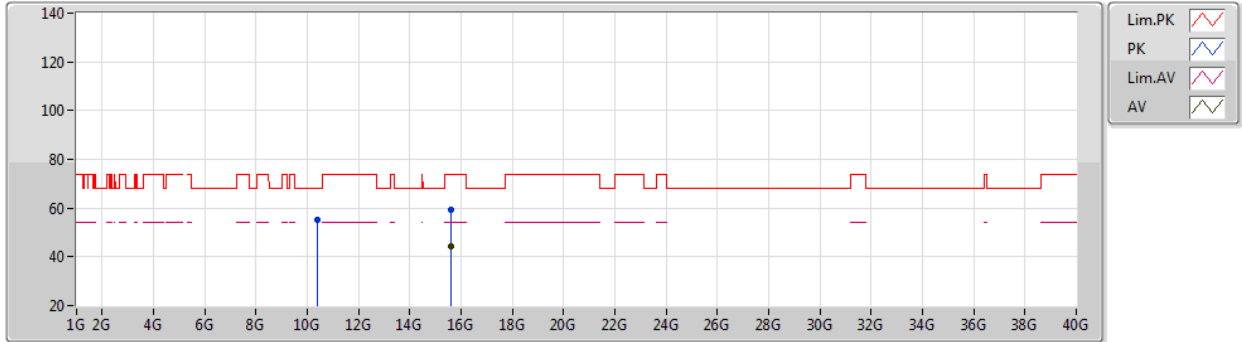

EUT X_1TX
Setting 21
02-D-J-7

Type	Freq (Hz)	Level (dBuV/m)	Limit (dBuV/m)	Margin (dB)	Raw (dBuV)	Dist (m)	Condition	Azimuth (°)	Height (m)	Comment	AF (dB)	CL (dB)	PA (dB)
PK	10.39994G	54.98	68.20	-13.22	39.13	3	Horizontal	228	1.86	-	38.82	8.52	31.49
PK	15.60005G	59.47	74.00	-14.53	43.63	3	Horizontal	87	1.00	-	38.56	9.27	31.99
AV	15.59957G	44.42	54.00	-9.58	28.58	3	Horizontal	87	1.00	-	38.56	9.27	31.99

802.11a_Nss1,(6Mbps)_1TX

23/03/2020

5240MHz_TX

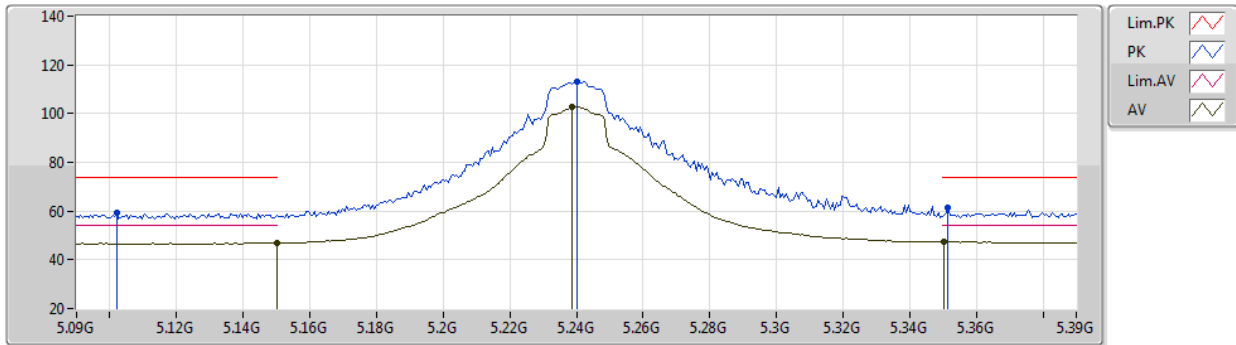

EUT X_1TX
Setting 24
02-D-J-7-10

Type	Freq (Hz)	Level (dBuV/m)	Limit (dBuV/m)	Margin (dB)	Raw (dBuV)	Dist (m)	Condition	Azimuth (°)	Height (m)	Comment	AF (dB)	CL (dB)	PA (dB)
PK	5.102G	59.17	74.00	-14.83	50.09	3	Vertical	341	1.00	-	33.50	5.95	30.37
AV	5.15G	46.92	54.00	-7.08	37.78	3	Vertical	341	1.00	-	33.55	5.97	30.38
PK	5.24G	113.33	Inf	-Inf	104.05	3	Vertical	341	1.00	-	33.68	6.02	30.42
AV	5.2388G	102.69	Inf	-Inf	93.41	3	Vertical	341	1.00	-	33.68	6.02	30.42
PK	5.3516G	61.14	74.00	-12.86	51.67	3	Vertical	341	1.00	-	33.85	6.08	30.46
AV	5.3504G	47.35	54.00	-6.65	37.88	3	Vertical	341	1.00	-	33.85	6.08	30.46

802.11a_Nss1,(6Mbps)_1TX

23/03/2020

5240MHz_TX

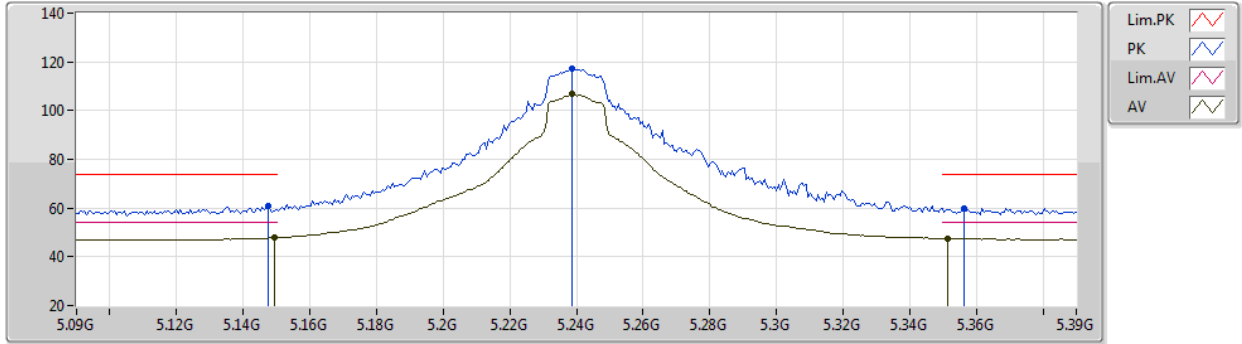

EUT X_1TX
Setting 24
02-D-J-7-10

Type	Freq (Hz)	Level (dBuV/m)	Limit (dBuV/m)	Margin (dB)	Raw (dBuV)	Dist (m)	Condition	Azimuth (°)	Height (m)	Comment	AF (dB)	CL (dB)	PA (dB)
PK	5.1476G	60.92	74.00	-13.08	51.78	3	Horizontal	0	1.00	-	33.55	5.97	30.38
AV	5.1494G	47.91	54.00	-6.09	38.77	3	Horizontal	0	1.00	-	33.55	5.97	30.38
PK	5.2388G	117.07	Inf	-Inf	107.79	3	Horizontal	0	1.00	-	33.68	6.02	30.42
AV	5.2388G	106.81	Inf	-Inf	97.53	3	Horizontal	0	1.00	-	33.68	6.02	30.42
PK	5.3564G	60.03	74.00	-13.97	50.55	3	Horizontal	0	1.00	-	33.86	6.08	30.46
AV	5.3516G	47.48	54.00	-6.52	38.01	3	Horizontal	0	1.00	-	33.85	6.08	30.46

802.11a_Nss1,(6Mbps)_1TX

23/03/2020

5240MHz_TX

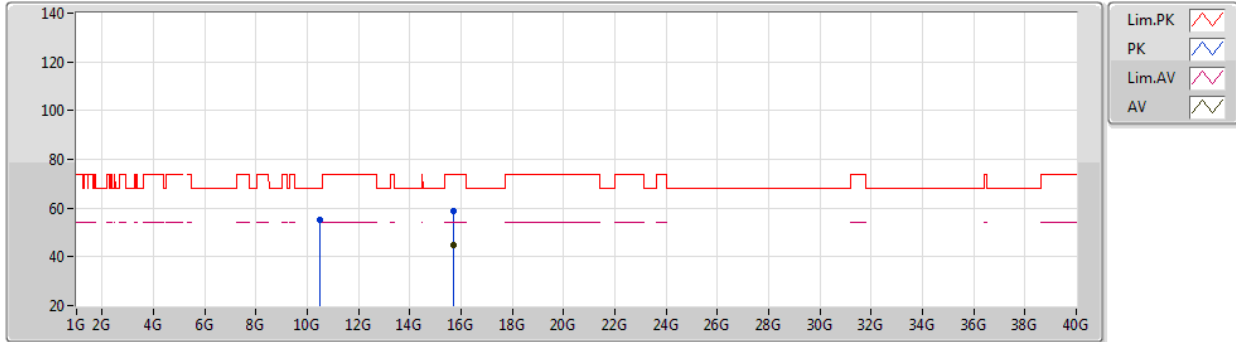

EUT X_1TX
Setting 24
02-D-J-7

Type	Freq (Hz)	Level (dBuV/m)	Limit (dBuV/m)	Margin (dB)	Raw (dBuV)	Dist (m)	Condition	Azimuth (°)	Height (m)	Comment	AF (dB)	CL (dB)	PA (dB)
PK	10.47929G	55.20	68.20	-13.00	39.38	3	Vertical	48	1.97	-	38.76	8.55	31.49
PK	15.72097G	58.86	74.00	-15.14	43.36	3	Vertical	300	2.35	-	38.21	9.31	32.02
AV	15.71913G	44.74	54.00	-9.26	29.24	3	Vertical	300	2.35	-	38.21	9.31	32.02

802.11a_Nss1,(6Mbps)_1TX

23/03/2020

5240MHz_TX

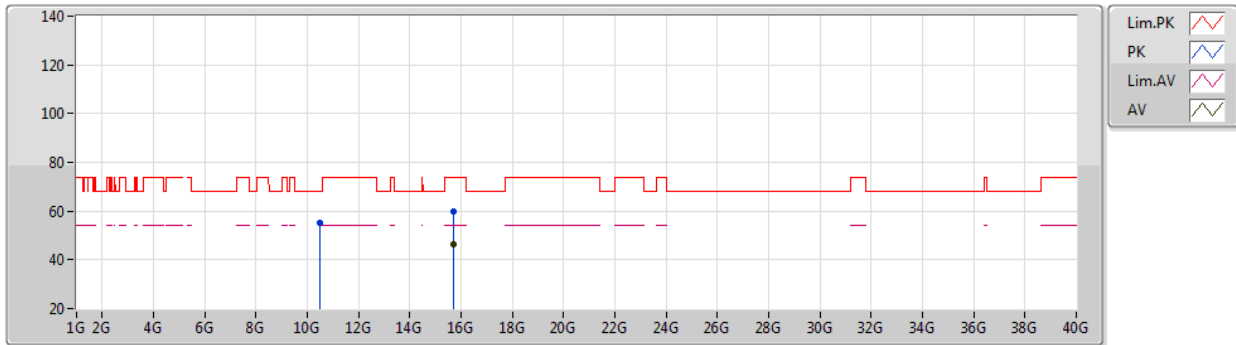

EUT X_1TX
Setting 24
02-D-J-7

Type	Freq (Hz)	Level (dBuV/m)	Limit (dBuV/m)	Margin (dB)	Raw (dBuV)	Dist (m)	Condition	Azimuth (°)	Height (m)	Comment	AF (dB)	CL (dB)	PA (dB)
PK	10.48368G	55.43	68.20	-12.77	39.61	3	Horizontal	148	2.89	-	38.76	8.55	31.49
PK	15.7111G	59.81	74.00	-14.19	44.29	3	Horizontal	360	1.66	-	38.24	9.30	32.02
AV	15.7164G	46.53	54.00	-7.47	31.02	3	Horizontal	360	1.66	-	38.22	9.31	32.02

802.11a_Nss1,(6Mbps)_1TX

23/03/2020

5260MHz_TX

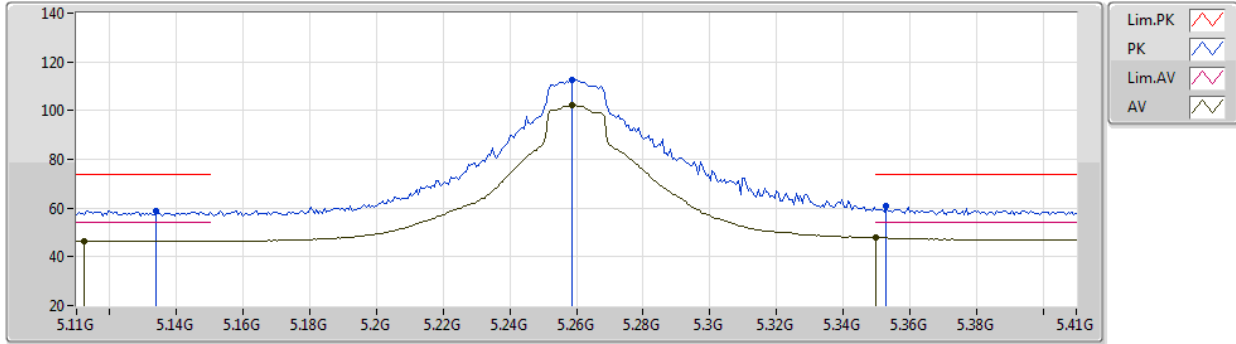

EUT X_1TX
Setting 24
02-D-J-7-10

Type	Freq (Hz)	Level (dBuV/m)	Limit (dBuV/m)	Margin (dB)	Raw (dBuV)	Dist (m)	Condition	Azimuth (°)	Height (m)	Comment	AF (dB)	CL (dB)	PA (dB)
PK	5.134G	58.84	74.00	-15.16	49.72	3	Vertical	339	1.05	-	33.53	5.97	30.38
AV	5.1124G	46.63	54.00	-7.37	37.53	3	Vertical	339	1.05	-	33.51	5.96	30.37
PK	5.2588G	112.34	Inf	-Inf	103.01	3	Vertical	339	1.05	-	33.72	6.03	30.42
AV	5.2588G	102.27	Inf	-Inf	92.94	3	Vertical	339	1.05	-	33.72	6.03	30.42
PK	5.353G	60.63	74.00	-13.37	51.16	3	Vertical	339	1.05	-	33.85	6.08	30.46
AV	5.35G	47.75	54.00	-6.25	38.28	3	Vertical	339	1.05	-	33.85	6.07	30.45

802.11a_Nss1,(6Mbps)_1TX

23/03/2020

5260MHz_TX

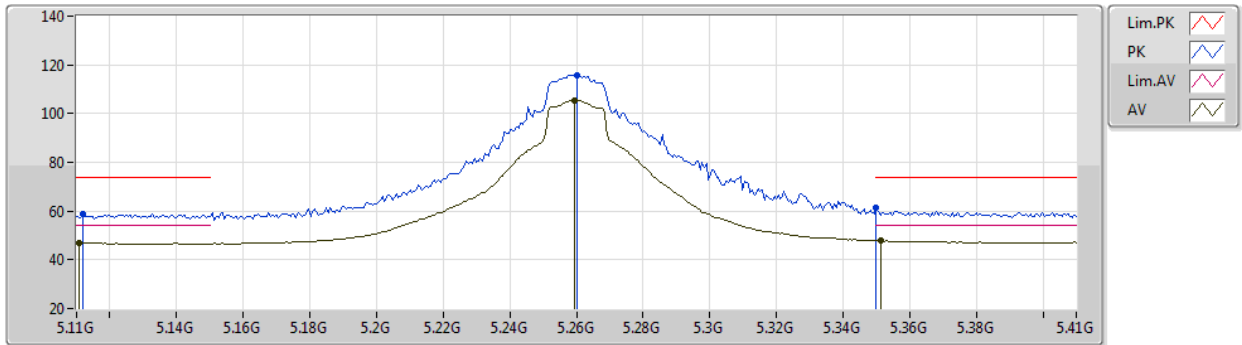

EUT X_1TX
Setting 24
02-D-J-7-10

Type	Freq (Hz)	Level (dBuV/m)	Limit (dBuV/m)	Margin (dB)	Raw (dBuV)	Dist (m)	Condition	Azimuth (°)	Height (m)	Comment	AF (dB)	CL (dB)	PA (dB)
PK	5.1118G	58.79	74.00	-15.21	49.69	3	Horizontal	329	2.37	-	33.51	5.96	30.37
AV	5.1106G	46.89	54.00	-7.11	37.79	3	Horizontal	329	2.37	-	33.51	5.96	30.37
PK	5.26G	115.83	Inf	-Inf	106.50	3	Horizontal	329	2.37	-	33.72	6.03	30.42
AV	5.2594G	105.40	Inf	-Inf	96.07	3	Horizontal	329	2.37	-	33.72	6.03	30.42
PK	5.35G	61.24	74.00	-12.76	51.77	3	Horizontal	329	2.37	-	33.85	6.07	30.45
AV	5.3512G	47.78	54.00	-6.22	38.31	3	Horizontal	329	2.37	-	33.85	6.08	30.46

802.11a_Nss1,(6Mbps)_1TX

23/03/2020

5260MHz_TX

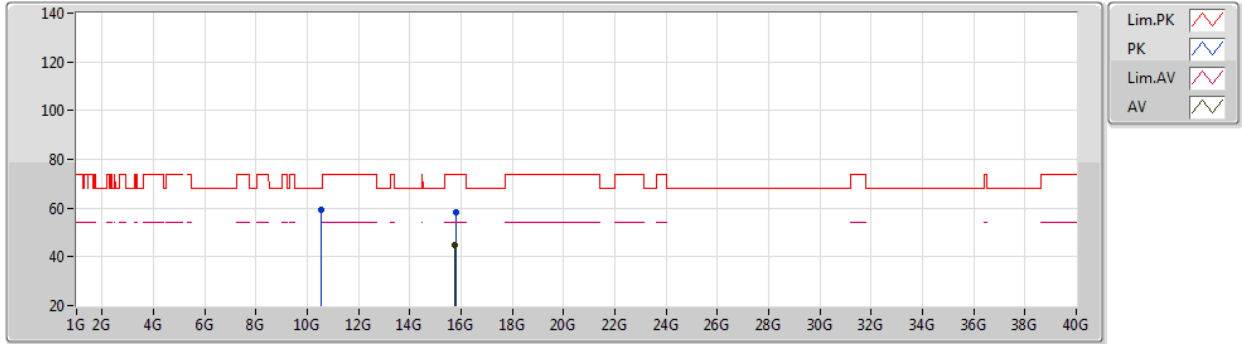

EUT X_1TX
Setting 24
02-D-J-7

Type	Freq (Hz)	Level (dBuV/m)	Limit (dBuV/m)	Margin (dB)	Raw (dBuV)	Dist (m)	Condition	Azimuth (°)	Height (m)	Comment	AF (dB)	CL (dB)	PA (dB)
PK	10.52276G	59.39	68.20	-8.81	43.58	3	Vertical	257	1.25	-	38.73	8.56	31.48
PK	15.77974G	58.32	74.00	-15.68	42.98	3	Vertical	1	2.75	-	38.04	9.33	32.03
AV	15.77752G	44.74	54.00	-9.26	29.39	3	Vertical	1	2.75	-	38.05	9.33	32.03

802.11a_Nss1,(6Mbps)_1TX

23/03/2020

5260MHz_TX

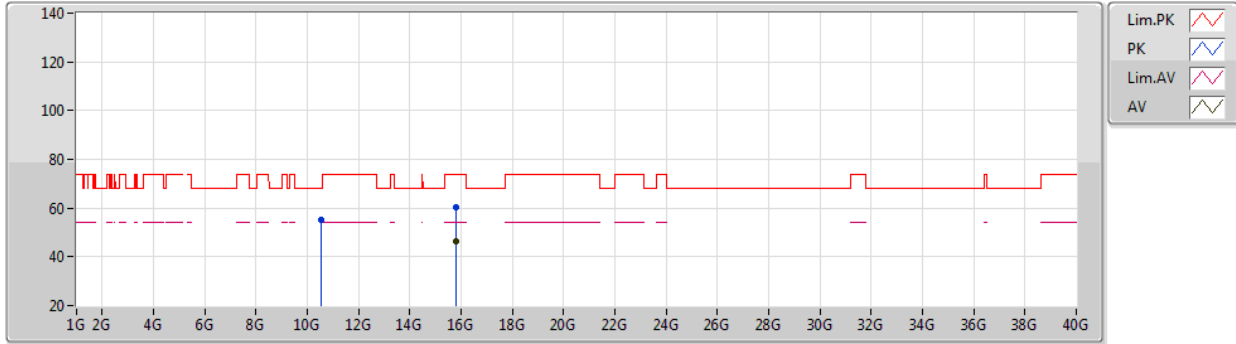

EUT X_1TX
Setting 24
02-D-J-7

Type	Freq (Hz)	Level (dBuV/m)	Limit (dBuV/m)	Margin (dB)	Raw (dBuV)	Dist (m)	Condition	Azimuth (°)	Height (m)	Comment	AF (dB)	CL (dB)	PA (dB)
PK	10.51792G	55.19	68.20	-13.01	39.37	3	Horizontal	99	2.98	-	38.74	8.56	31.48
PK	15.78048G	60.29	74.00	-13.71	44.95	3	Horizontal	359	2.05	-	38.04	9.33	32.03
AV	15.78032G	46.31	54.00	-7.69	30.97	3	Horizontal	359	2.05	-	38.04	9.33	32.03

802.11a_Nss1,(6Mbps)_1TX

23/03/2020

5300MHz_TX

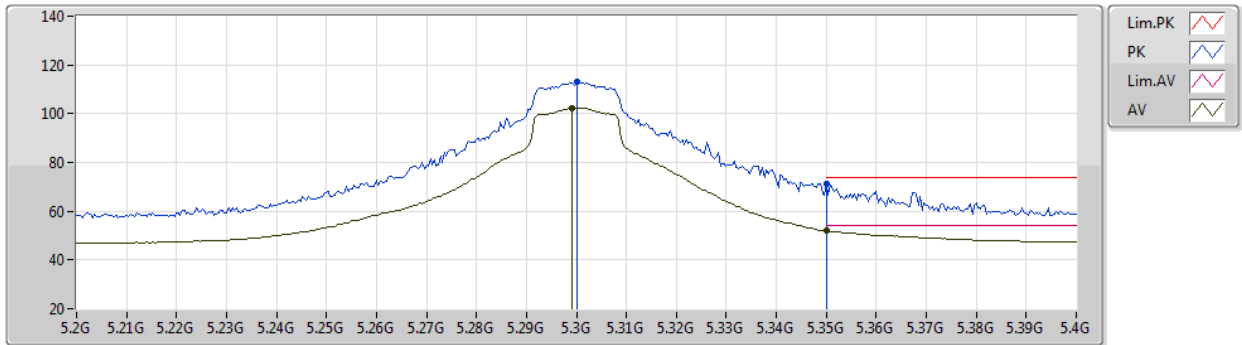

EUT X_1TX
Setting 24
02-D-J-7-10

Type	Freq (Hz)	Level (dBuV/m)	Limit (dBuV/m)	Margin (dB)	Raw (dBuV)	Dist (m)	Condition	Azimuth (°)	Height (m)	Comment	AF (dB)	CL (dB)	PA (dB)
PK	5.3G	113.03	Inf	-Inf	103.62	3	Vertical	345	1.00	-	33.80	6.05	30.44
AV	5.2992G	102.43	Inf	-Inf	93.02	3	Vertical	345	1.00	-	33.80	6.05	30.44
PK	5.35G	71.26	74.00	-2.74	61.79	3	Vertical	345	1.00	-	33.85	6.07	30.45
AV	5.35G	51.96	54.00	-2.04	42.49	3	Vertical	345	1.00	-	33.85	6.07	30.45

802.11a_Nss1,(6Mbps)_1TX

23/03/2020

5300MHz_TX

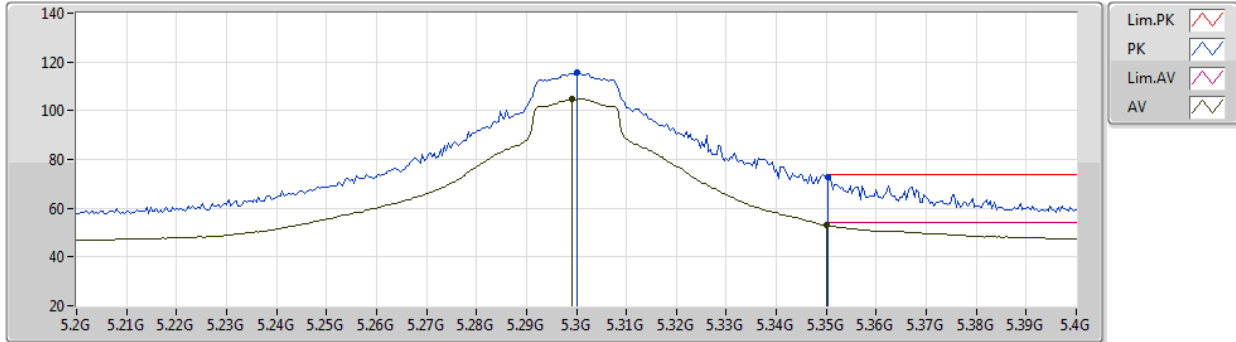

EUT X_1TX
Setting 24
02-D-J-7-10

Type	Freq (Hz)	Level (dBuV/m)	Limit (dBuV/m)	Margin (dB)	Raw (dBuV)	Dist (m)	Condition	Azimuth (°)	Height (m)	Comment	AF (dB)	CL (dB)	PA (dB)
PK	5.3G	115.47	Inf	-Inf	106.06	3	Horizontal	359	2.23	-	33.80	6.05	30.44
AV	5.2992G	104.87	Inf	-Inf	95.46	3	Horizontal	359	2.23	-	33.80	6.05	30.44
PK	5.3504G	72.52	74.00	-1.48	63.05	3	Horizontal	359	2.23	-	33.85	6.08	30.46
AV	5.35G	52.93	54.00	-1.07	43.46	3	Horizontal	359	2.23	-	33.85	6.07	30.45

802.11a_Nss1,(6Mbps)_1TX

23/03/2020

5300MHz_TX

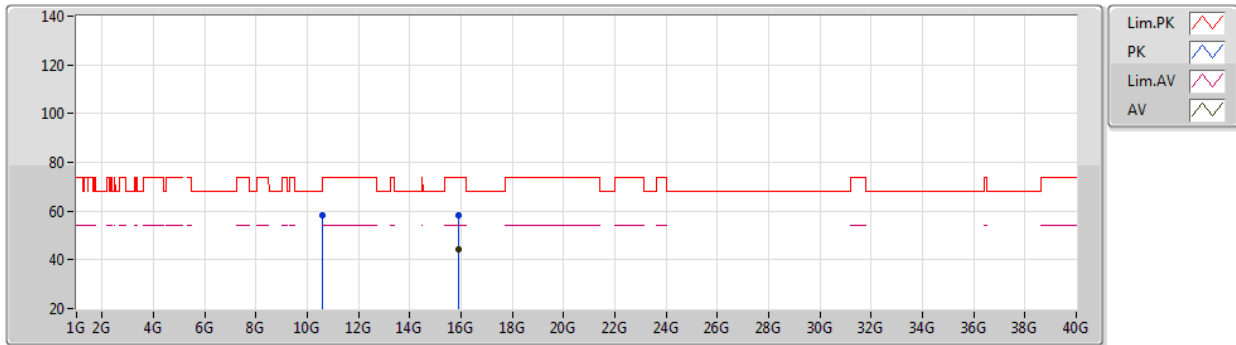

EUT X_1TX
Setting 24
02-D-J-7

Type	Freq (Hz)	Level (dBuV/m)	Limit (dBuV/m)	Margin (dB)	Raw (dBuV)	Dist (m)	Condition	Azimuth (°)	Height (m)	Comment	AF (dB)	CL (dB)	PA (dB)
PK	10.59946G	58.25	68.20	-9.95	42.46	3	Vertical	334	1.15	-	38.68	8.59	31.48
PK	15.89746G	58.52	74.00	-15.48	43.51	3	Vertical	225	2.65	-	37.70	9.37	32.06
AV	15.89758G	44.31	54.00	-9.69	29.30	3	Vertical	225	2.65	-	37.70	9.37	32.06

802.11a_Nss1,(6Mbps)_1TX

23/03/2020

5300MHz_TX

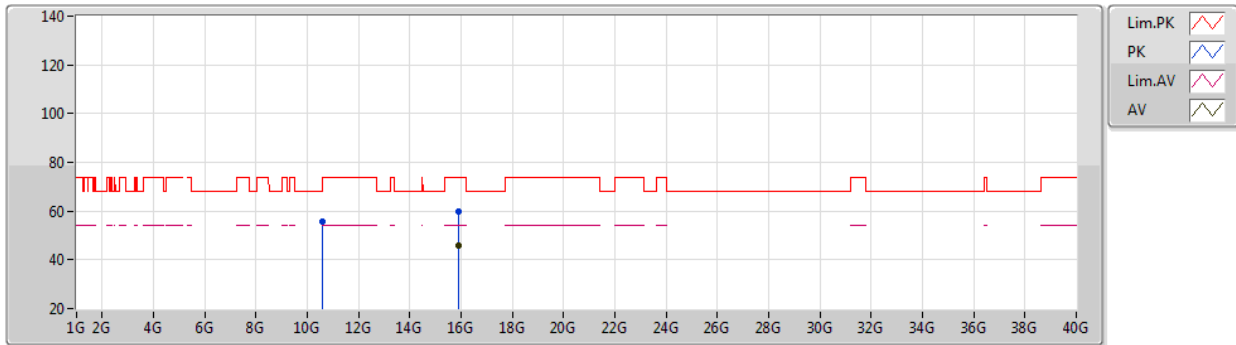

EUT X_1TX
Setting 24
02-D-J-7

Type	Freq (Hz)	Level (dBuV/m)	Limit (dBuV/m)	Margin (dB)	Raw (dBuV)	Dist (m)	Condition	Azimuth (°)	Height (m)	Comment	AF (dB)	CL (dB)	PA (dB)
PK	10.59774G	55.58	68.20	-12.62	39.79	3	Horizontal	303	1.38	-	38.68	8.59	31.48
PK	15.9027G	59.94	74.00	-14.06	44.95	3	Horizontal	74	2.75	-	37.68	9.37	32.06
AV	15.90048G	45.92	54.00	-8.08	30.92	3	Horizontal	74	2.75	-	37.69	9.37	32.06

802.11a_Nss1,(6Mbps)_1TX

23/03/2020

5320MHz_TX

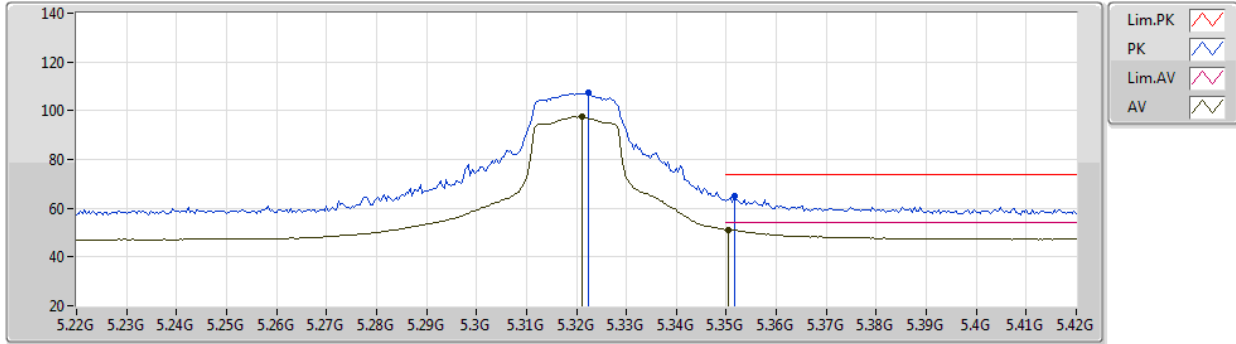

EUT X_1TX
Setting 18
02-D-J-7-10

Type	Freq (Hz)	Level (dBuV/m)	Limit (dBuV/m)	Margin (dB)	Raw (dBuV)	Dist (m)	Condition	Azimuth (°)	Height (m)	Comment	AF (dB)	CL (dB)	PA (dB)
PK	5.3224G	107.45	Inf	-Inf	98.02	3	Vertical	338	1.04	-	33.82	6.06	30.45
AV	5.3212G	97.52	Inf	-Inf	88.09	3	Vertical	338	1.04	-	33.82	6.06	30.45
PK	5.3516G	65.17	74.00	-8.83	55.70	3	Vertical	338	1.04	-	33.85	6.08	30.46
AV	5.3504G	51.24	54.00	-2.76	41.77	3	Vertical	338	1.04	-	33.85	6.08	30.46

802.11a_Nss1,(6Mbps)_1TX

23/03/2020

5320MHz_TX

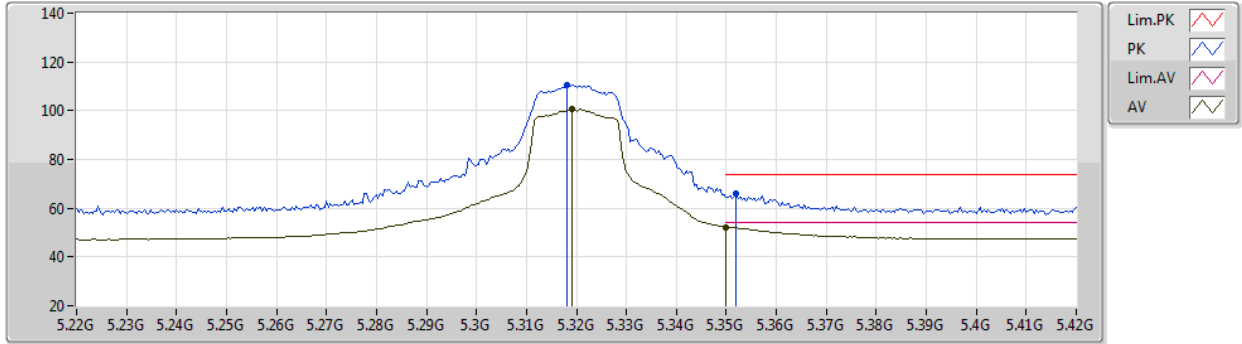

EUT X_1TX
Setting 18
02-D-J-7-10

Type	Freq (Hz)	Level (dBuV/m)	Limit (dBuV/m)	Margin (dB)	Raw (dBuV)	Dist (m)	Condition	Azimuth (°)	Height (m)	Comment	AF (dB)	CL (dB)	PA (dB)
PK	5.318G	110.42	Inf	-Inf	100.99	3	Horizontal	355	1.16	-	33.82	6.06	30.45
AV	5.3192G	100.50	Inf	-Inf	91.07	3	Horizontal	355	1.16	-	33.82	6.06	30.45
PK	5.352G	65.78	74.00	-8.22	56.31	3	Horizontal	355	1.16	-	33.85	6.08	30.46
AV	5.35G	52.22	54.00	-1.78	42.75	3	Horizontal	355	1.16	-	33.85	6.07	30.45

802.11a_Nss1,(6Mbps)_1TX

23/03/2020

5320MHz_TX

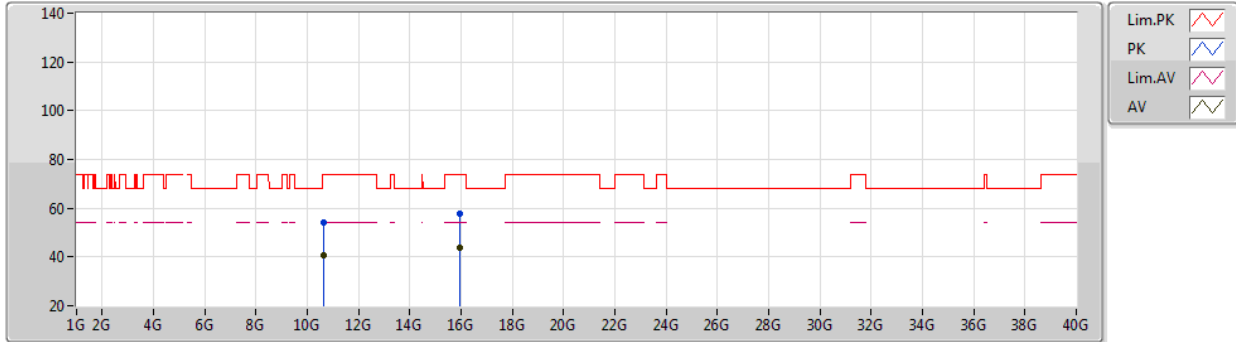

EUT X_1TX
Setting 18
02-D-J-7

Type	Freq (Hz)	Level (dBuV/m)	Limit (dBuV/m)	Margin (dB)	Raw (dBuV)	Dist (m)	Condition	Azimuth (°)	Height (m)	Comment	AF (dB)	CL (dB)	PA (dB)
PK	10.63758G	54.35	74.00	-19.65	38.58	3	Vertical	138	2.40	-	38.65	8.60	31.48
AV	10.63948G	40.93	54.00	-13.07	25.16	3	Vertical	138	2.40	-	38.65	8.60	31.48
PK	15.9608G	57.83	74.00	-16.17	43.00	3	Vertical	192	1.56	-	37.51	9.39	32.07
AV	15.95574G	43.91	54.00	-10.09	29.06	3	Vertical	192	1.56	-	37.53	9.39	32.07

802.11a_Nss1,(6Mbps)_1TX

23/03/2020

5320MHz_TX

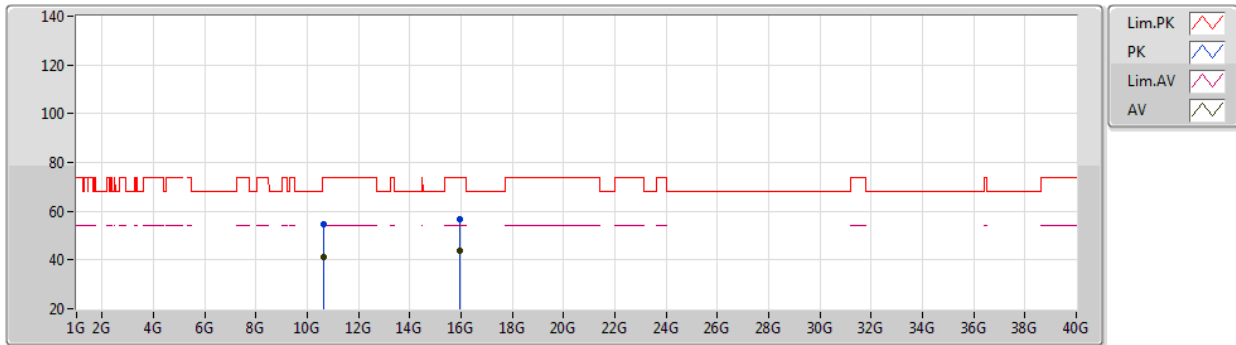

EUT X_1TX
Setting 18
02-D-J-7

Type	Freq (Hz)	Level (dBuV/m)	Limit (dBuV/m)	Margin (dB)	Raw (dBuV)	Dist (m)	Condition	Azimuth (°)	Height (m)	Comment	AF (dB)	CL (dB)	PA (dB)
PK	10.63806G	54.73	74.00	-19.27	38.96	3	Horizontal	232	1.44	-	38.65	8.60	31.48
AV	10.64222G	40.97	54.00	-13.03	25.20	3	Horizontal	232	1.44	-	38.65	8.60	31.48
PK	15.9574G	56.98	74.00	-17.02	42.14	3	Horizontal	121	1.88	-	37.52	9.39	32.07
AV	15.95584G	43.90	54.00	-10.10	29.05	3	Horizontal	121	1.88	-	37.53	9.39	32.07

802.11a_Nss1,(6Mbps)_1TX

23/03/2020

5500MHz_TX

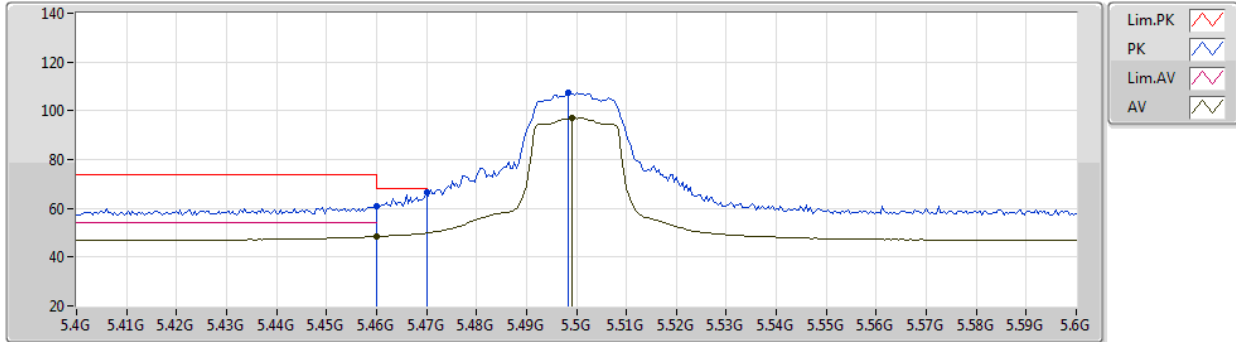

EUT X_1TX
Setting 16
02-D-J-7-10

Type	Freq (Hz)	Level (dBuV/m)	Limit (dBuV/m)	Margin (dB)	Raw (dBuV)	Dist (m)	Condition	Azimuth (°)	Height (m)	Comment	AF (dB)	CL (dB)	PA (dB)
PK	5.46G	61.11	74.00	-12.89	51.53	3	Vertical	334	1.02	-	33.90	6.17	30.49
AV	5.46G	48.34	54.00	-5.66	38.76	3	Vertical	334	1.02	-	33.90	6.17	30.49
PK	5.47G	66.33	68.20	-1.87	56.75	3	Vertical	334	1.02	-	33.90	6.18	30.50
PK	5.4984G	107.26	Inf	-Inf	97.66	3	Vertical	334	1.02	-	33.90	6.21	30.51
AV	5.4992G	97.12	Inf	-Inf	87.52	3	Vertical	334	1.02	-	33.90	6.21	30.51

802.11a_Nss1,(6Mbps)_1TX

23/03/2020

5500MHz_TX

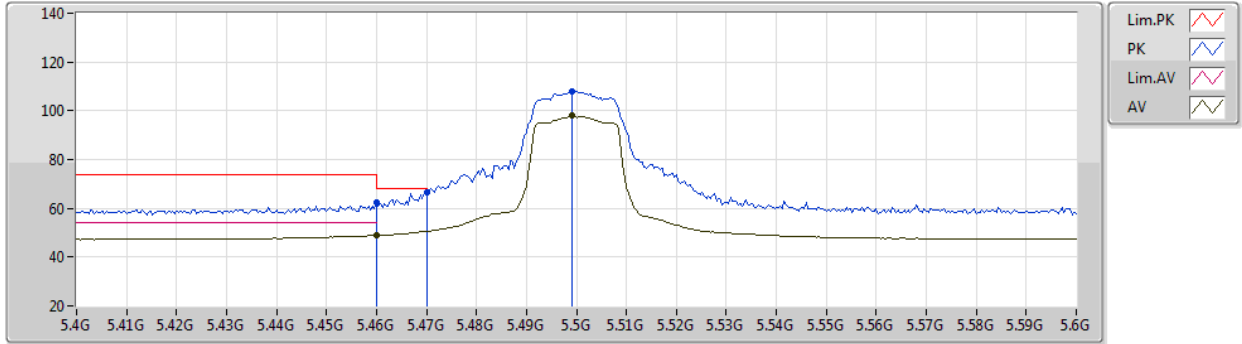

EUT X_1TX
Setting 16
02-D-J-7-10

Type	Freq (Hz)	Level (dBuV/m)	Limit (dBuV/m)	Margin (dB)	Raw (dBuV)	Dist (m)	Condition	Azimuth (°)	Height (m)	Comment	AF (dB)	CL (dB)	PA (dB)
PK	5.46G	62.40	74.00	-11.60	52.82	3	Horizontal	347	1.01	-	33.90	6.17	30.49
AV	5.46G	48.93	54.00	-5.07	39.35	3	Horizontal	347	1.01	-	33.90	6.17	30.49
PK	5.47G	66.41	68.20	-1.79	56.83	3	Horizontal	347	1.01	-	33.90	6.18	30.50
PK	5.4992G	107.78	Inf	-Inf	98.18	3	Horizontal	347	1.01	-	33.90	6.21	30.51
AV	5.4992G	97.90	Inf	-Inf	88.30	3	Horizontal	347	1.01	-	33.90	6.21	30.51

802.11a_Nss1,(6Mbps)_1TX

23/03/2020

5500MHz_TX

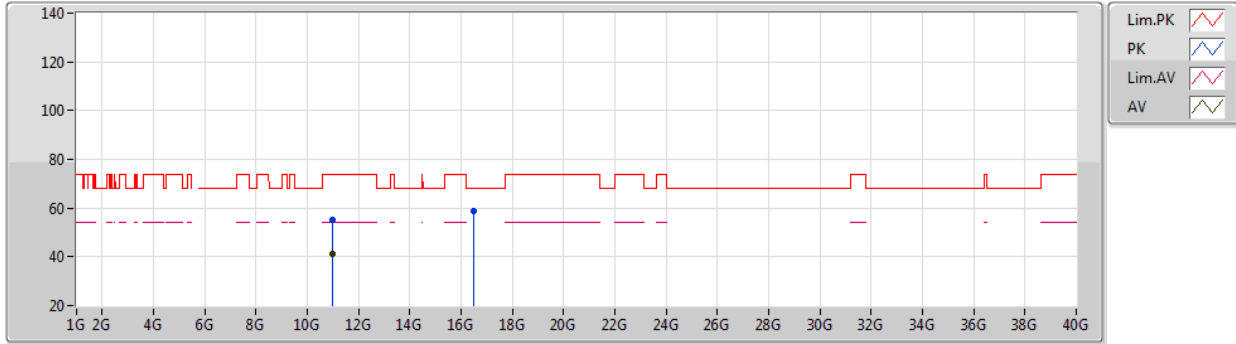

EUT X_1TX
Setting 16
02-D-J-7

Type	Freq (Hz)	Level (dBuV/m)	Limit (dBuV/m)	Margin (dB)	Raw (dBuV)	Dist (m)	Condition	Azimuth (°)	Height (m)	Comment	AF (dB)	CL (dB)	PA (dB)
PK	10.99736G	55.16	74.00	-18.84	39.50	3	Vertical	114	2.76	-	38.40	8.71	31.45
AV	11.00274G	41.19	54.00	-12.81	25.53	3	Vertical	114	2.76	-	38.40	8.71	31.45
PK	16.4977G	58.65	68.20	-9.55	41.57	3	Vertical	347	1.45	-	39.29	9.70	31.91

802.11a_Nss1,(6Mbps)_1TX

23/03/2020

5500MHz_TX

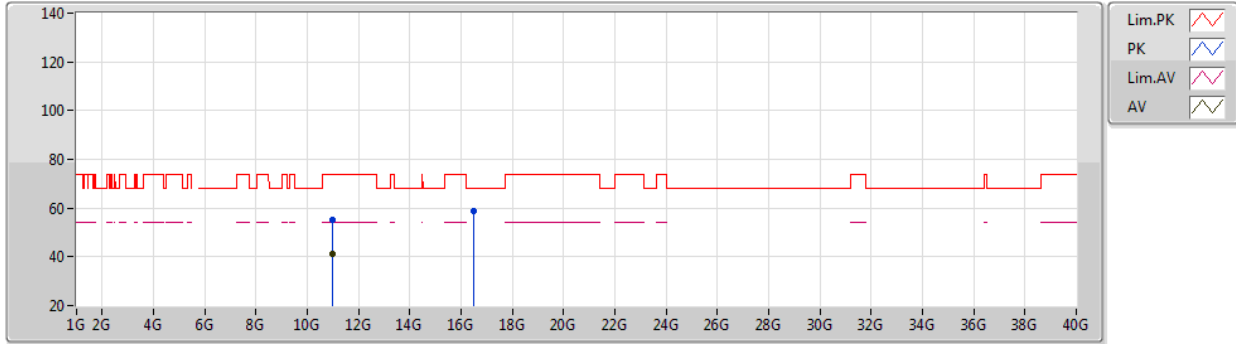

EUT X_1TX
Setting 16
02-D-J-7

Type	Freq (Hz)	Level (dBuV/m)	Limit (dBuV/m)	Margin (dB)	Raw (dBuV)	Dist (m)	Condition	Azimuth (°)	Height (m)	Comment	AF (dB)	CL (dB)	PA (dB)
PK	10.99654G	55.03	74.00	-18.97	39.37	3	Horizontal	283	1.80	-	38.40	8.71	31.45
AV	11.0043G	40.97	54.00	-13.03	25.31	3	Horizontal	283	1.80	-	38.40	8.71	31.45
PK	16.5003G	58.89	68.20	-9.31	41.79	3	Horizontal	316	1.81	-	39.30	9.71	31.91

802.11a_Nss1,(6Mbps)_1TX

23/03/2020

5580MHz_TX

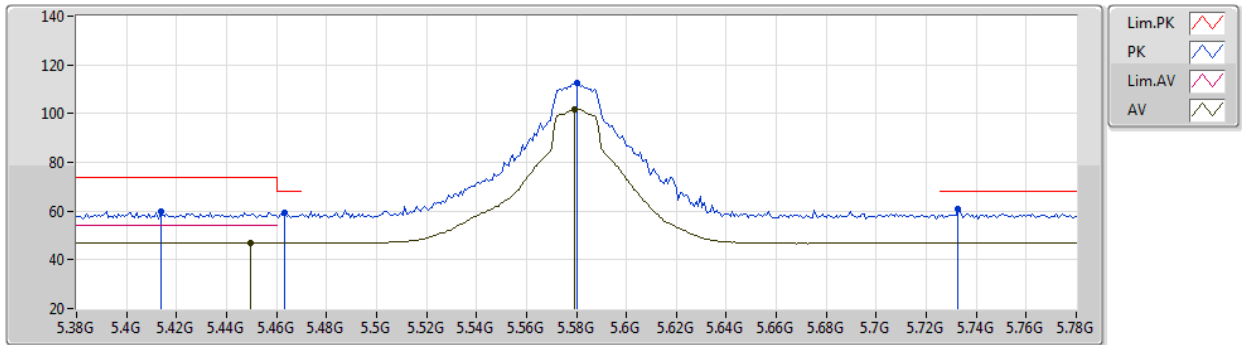

EUT X_1TX
Setting 24
02-D-J-7-10

Type	Freq (Hz)	Level (dBuV/m)	Limit (dBuV/m)	Margin (dB)	Raw (dBuV)	Dist (m)	Condition	Azimuth (°)	Height (m)	Comment	AF (dB)	CL (dB)	PA (dB)
PK	5.4136G	59.79	74.00	-14.21	50.26	3	Vertical	7	2.46	-	33.90	6.11	30.48
PK	5.4632G	59.19	68.20	-9.01	49.62	3	Vertical	7	2.46	-	33.90	6.17	30.50
AV	5.4496G	47.10	54.00	-6.90	37.54	3	Vertical	7	2.46	-	33.90	6.15	30.49
PK	5.58G	112.47	Inf	-Inf	102.74	3	Vertical	7	2.46	-	33.98	6.28	30.53
AV	5.5792G	101.82	Inf	-Inf	92.09	3	Vertical	7	2.46	-	33.98	6.28	30.53
PK	5.7328G	60.72	68.20	-7.48	51.12	3	Vertical	7	2.46	-	33.80	6.37	30.57

802.11a_Nss1,(6Mbps)_1TX

23/03/2020

5580MHz_TX

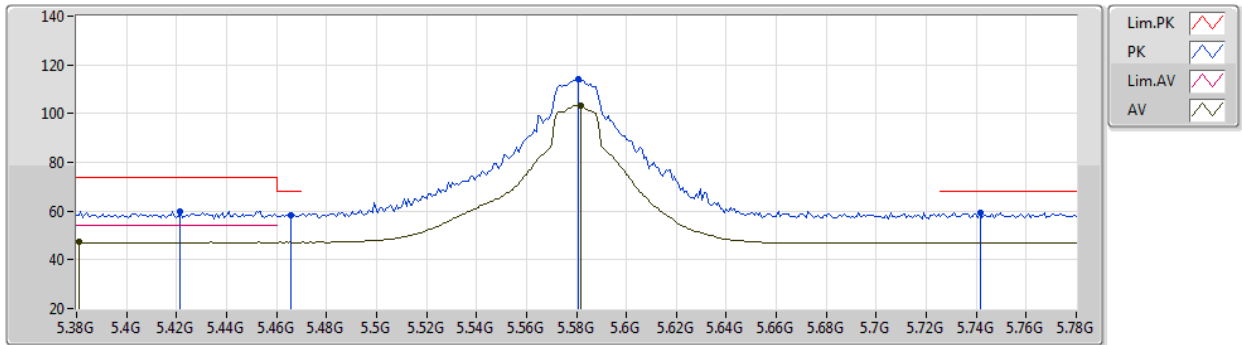

EUT X_1TX
Setting 24
02-D-J-7-10

Type	Freq (Hz)	Level (dBuV/m)	Limit (dBuV/m)	Margin (dB)	Raw (dBuV)	Dist (m)	Condition	Azimuth (°)	Height (m)	Comment	AF (dB)	CL (dB)	PA (dB)
PK	5.4216G	59.99	74.00	-14.01	50.45	3	Horizontal	355	2.13	-	33.90	6.12	30.48
AV	5.3808G	47.20	54.00	-6.80	37.69	3	Horizontal	355	2.13	-	33.88	6.09	30.46
PK	5.4656G	58.45	68.20	-9.75	48.88	3	Horizontal	355	2.13	-	33.90	6.17	30.50
PK	5.5808G	113.89	Inf	-Inf	104.16	3	Horizontal	355	2.13	-	33.98	6.28	30.53
AV	5.5816G	103.43	Inf	-Inf	93.70	3	Horizontal	355	2.13	-	33.98	6.28	30.53
PK	5.7416G	59.35	68.20	-8.85	49.75	3	Horizontal	355	2.13	-	33.80	6.37	30.57

802.11a_Nss1,(6Mbps)_1TX

23/03/2020

5580MHz_TX

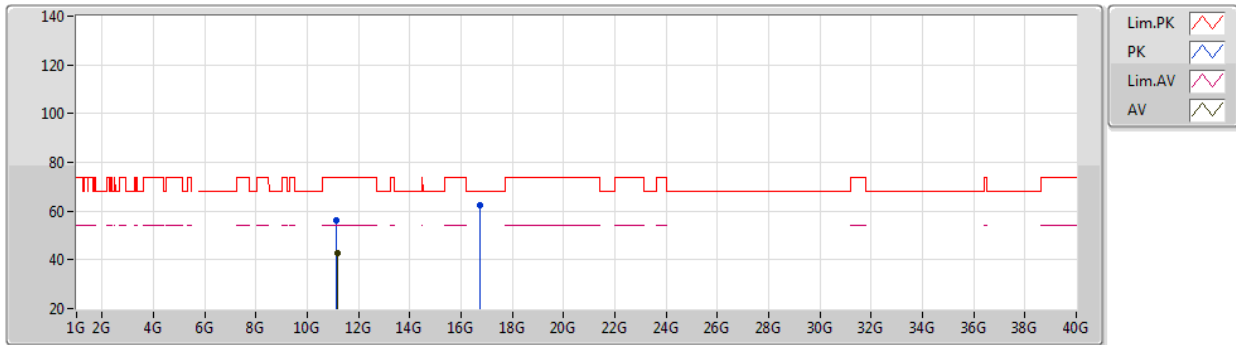

EUT X_1TX
Setting 24
02-D-J-7

Type	Freq (Hz)	Level (dBuV/m)	Limit (dBuV/m)	Margin (dB)	Raw (dBuV)	Dist (m)	Condition	Azimuth (°)	Height (m)	Comment	AF (dB)	CL (dB)	PA (dB)
PK	11.1551G	56.40	74.00	-17.60	40.63	3	Vertical	57	1.63	-	38.52	8.75	31.50
AV	11.16132G	42.92	54.00	-11.08	27.13	3	Vertical	57	1.63	-	38.53	8.76	31.50
PK	16.74216G	62.61	68.20	-5.59	44.37	3	Vertical	295	1.16	-	40.22	9.85	31.83

802.11a_Nss1,(6Mbps)_1TX

23/03/2020

5580MHz_TX

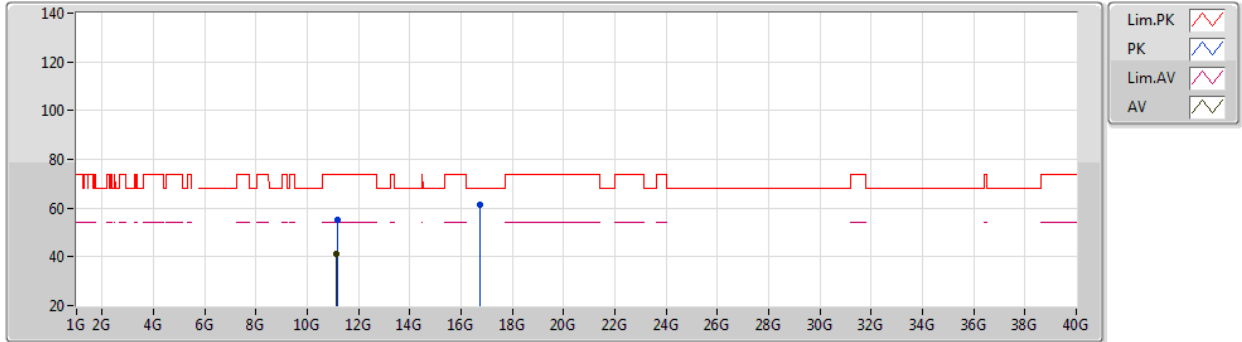

EUT X_1TX
Setting 24
02-D-J-7

Type	Freq (Hz)	Level (dBuV/m)	Limit (dBuV/m)	Margin (dB)	Raw (dBuV)	Dist (m)	Condition	Azimuth (°)	Height (m)	Comment	AF (dB)	CL (dB)	PA (dB)
PK	11.16306G	55.28	74.00	-18.72	39.49	3	Horizontal	338	1.31	-	38.53	8.76	31.50
AV	11.15568G	41.21	54.00	-12.79	25.43	3	Horizontal	338	1.31	-	38.52	8.76	31.50
PK	16.74026G	61.56	68.20	-6.64	43.33	3	Horizontal	331	1.15	-	40.21	9.85	31.83

802.11a_Nss1,(6Mbps)_1TX

23/03/2020

5700MHz_TX

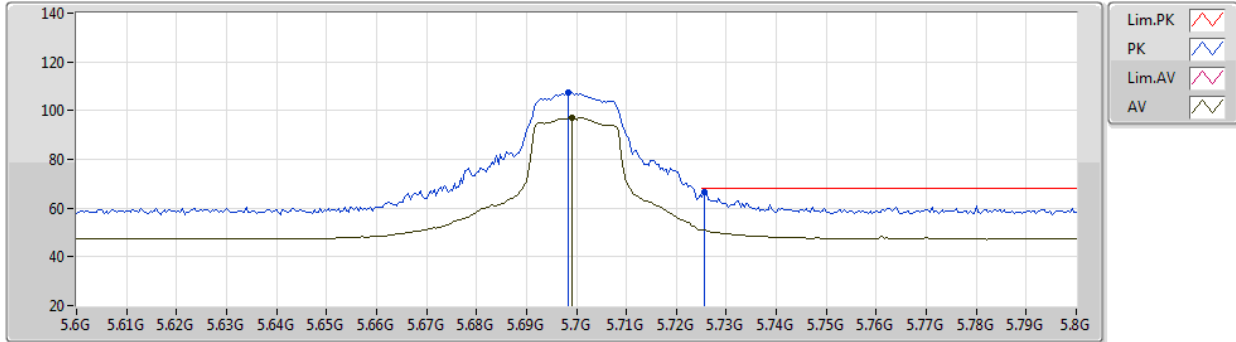

EUT X_1TX
Setting 18
02-D-J-7-10

Type	Freq (Hz)	Level (dBuV/m)	Limit (dBuV/m)	Margin (dB)	Raw (dBuV)	Dist (m)	Condition	Azimuth (°)	Height (m)	Comment	AF (dB)	CL (dB)	PA (dB)
PK	5.6984G	107.44	Inf	-Inf	97.85	3	Vertical	343	2.09	-	33.80	6.35	30.56
AV	5.6992G	97.28	Inf	-Inf	87.69	3	Vertical	343	2.09	-	33.80	6.35	30.56
PK	5.7256G	66.68	68.20	-1.52	57.09	3	Vertical	343	2.09	-	33.80	6.36	30.57

802.11a_Nss1,(6Mbps)_1TX

23/03/2020

5700MHz_TX

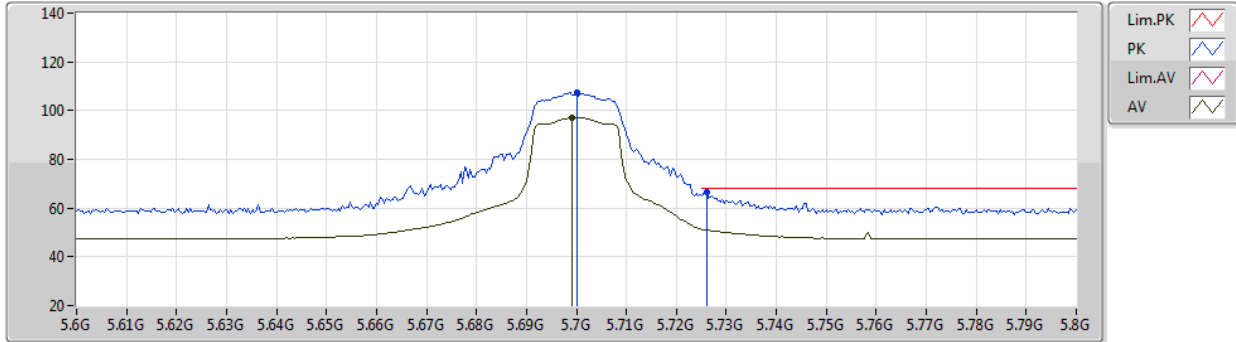

EUT X_1TX
Setting 18
02-D-J-7-10

Type	Freq (Hz)	Level (dBuV/m)	Limit (dBuV/m)	Margin (dB)	Raw (dBuV)	Dist (m)	Condition	Azimuth (°)	Height (m)	Comment	AF (dB)	CL (dB)	PA (dB)
PK	5.7G	107.42	Inf	-Inf	97.83	3	Horizontal	26	1.00	-	33.80	6.35	30.56
AV	5.6992G	97.30	Inf	-Inf	87.71	3	Horizontal	26	1.00	-	33.80	6.35	30.56
PK	5.726G	66.65	68.20	-1.55	57.06	3	Horizontal	26	1.00	-	33.80	6.36	30.57

802.11a_Nss1,(6Mbps)_1TX

23/03/2020

5700MHz_TX

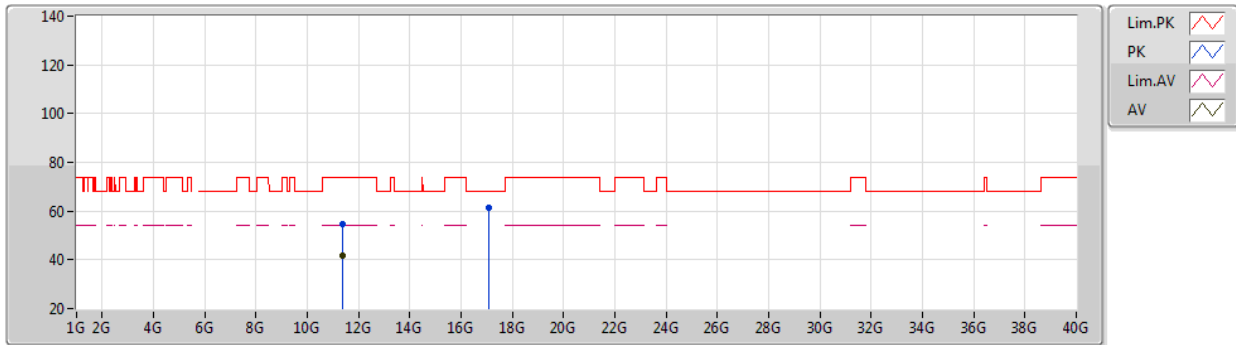

EUT X_1TX
Setting 18
02-D-J-7

Type	Freq (Hz)	Level (dBuV/m)	Limit (dBuV/m)	Margin (dB)	Raw (dBuV)	Dist (m)	Condition	Azimuth (°)	Height (m)	Comment	AF (dB)	CL (dB)	PA (dB)
PK	11.39724G	54.43	74.00	-19.57	38.45	3	Vertical	304	2.70	-	38.72	8.83	31.57
AV	11.3997G	41.53	54.00	-12.47	25.55	3	Vertical	304	2.70	-	38.72	8.83	31.57
PK	17.10432G	61.24	68.20	-6.96	41.19	3	Vertical	130	1.11	-	41.75	10.07	31.77

802.11a_Nss1,(6Mbps)_1TX

23/03/2020

5700MHz_TX

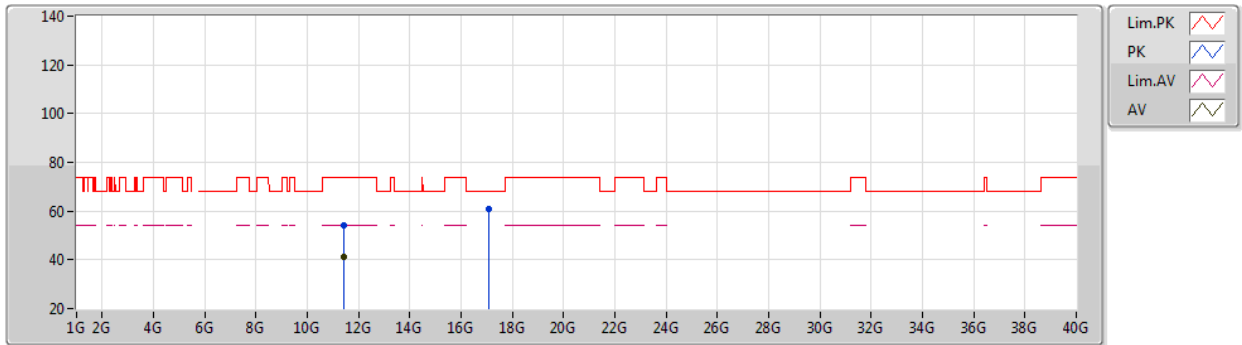

EUT X_1TX
Setting 18
02-D-J-7

Type	Freq (Hz)	Level (dBuV/m)	Limit (dBuV/m)	Margin (dB)	Raw (dBuV)	Dist (m)	Condition	Azimuth (°)	Height (m)	Comment	AF (dB)	CL (dB)	PA (dB)
PK	11.40326G	54.23	74.00	-19.77	38.26	3	Horizontal	219	2.62	-	38.72	8.83	31.58
AV	11.4019G	41.18	54.00	-12.82	25.20	3	Horizontal	219	2.62	-	38.72	8.83	31.57
PK	17.0972G	61.06	68.20	-7.14	41.04	3	Horizontal	114	2.79	-	41.72	10.07	31.77

802.11a_Nss1,(6Mbps)_1TX

23/03/2020

5745MHz_TX

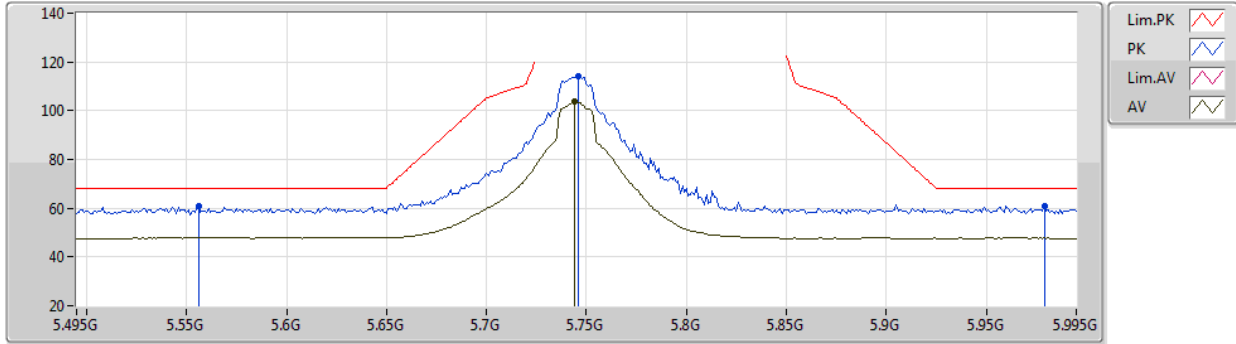

EUT X_1TX
Setting 24
02-D-J-7-10

Type	Freq (Hz)	Level (dBuV/m)	Limit (dBuV/m)	Margin (dB)	Raw (dBuV)	Dist (m)	Condition	Azimuth (°)	Height (m)	Comment	AF (dB)	CL (dB)	PA (dB)
PK	5.556G	60.80	68.20	-7.40	51.10	3	Vertical	344	2.06	-	33.96	6.26	30.52
PK	5.746G	114.03	Inf	-Inf	104.43	3	Vertical	344	2.06	-	33.80	6.37	30.57
AV	5.744G	103.60	Inf	-Inf	94.00	3	Vertical	344	2.06	-	33.80	6.37	30.57
PK	5.979G	60.70	68.20	-7.50	50.86	3	Vertical	344	2.06	-	34.16	6.31	30.63

802.11a_Nss1,(6Mbps)_1TX

23/03/2020

5745MHz_TX

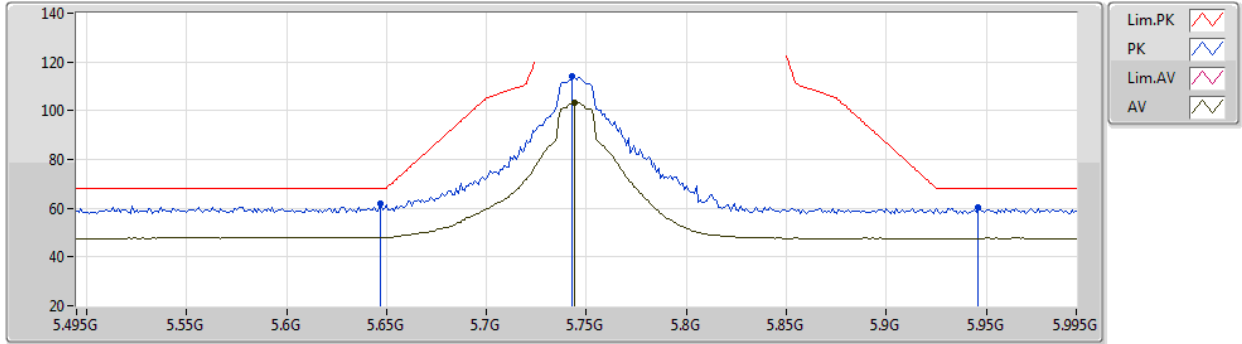

EUT X_1TX
Setting 24
02-D-J-7-10

Type	Freq (Hz)	Level (dBuV/m)	Limit (dBuV/m)	Margin (dB)	Raw (dBuV)	Dist (m)	Condition	Azimuth (°)	Height (m)	Comment	AF (dB)	CL (dB)	PA (dB)
PK	5.647G	61.99	68.20	-6.21	52.30	3	Horizontal	34	1.99	-	33.91	6.32	30.54
PK	5.743G	114.00	Inf	-Inf	104.40	3	Horizontal	34	1.99	-	33.80	6.37	30.57
AV	5.744G	103.27	Inf	-Inf	93.67	3	Horizontal	34	1.99	-	33.80	6.37	30.57
PK	5.946G	60.26	68.20	-7.94	50.46	3	Horizontal	34	1.99	-	34.09	6.33	30.62

802.11a_Nss1,(6Mbps)_1TX

23/03/2020

5745MHz_TX

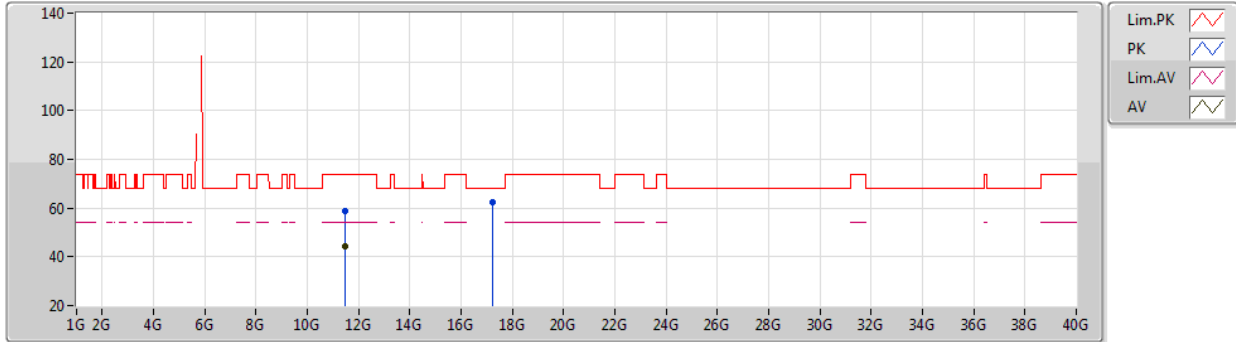

EUT X_1TX
Setting 24
02-D-J-7

Type	Freq (Hz)	Level (dBuV/m)	Limit (dBuV/m)	Margin (dB)	Raw (dBuV)	Dist (m)	Condition	Azimuth (°)	Height (m)	Comment	AF (dB)	CL (dB)	PA (dB)
PK	11.49206G	58.70	74.00	-15.30	42.66	3	Vertical	275	2.09	-	38.79	8.85	31.60
AV	11.48994G	44.53	54.00	-9.47	28.49	3	Vertical	275	2.09	-	38.79	8.85	31.60
PK	17.23644G	62.46	68.20	-5.74	41.67	3	Vertical	128	1.03	-	42.45	10.15	31.81

802.11a_Nss1,(6Mbps)_1TX

23/03/2020

5745MHz_TX

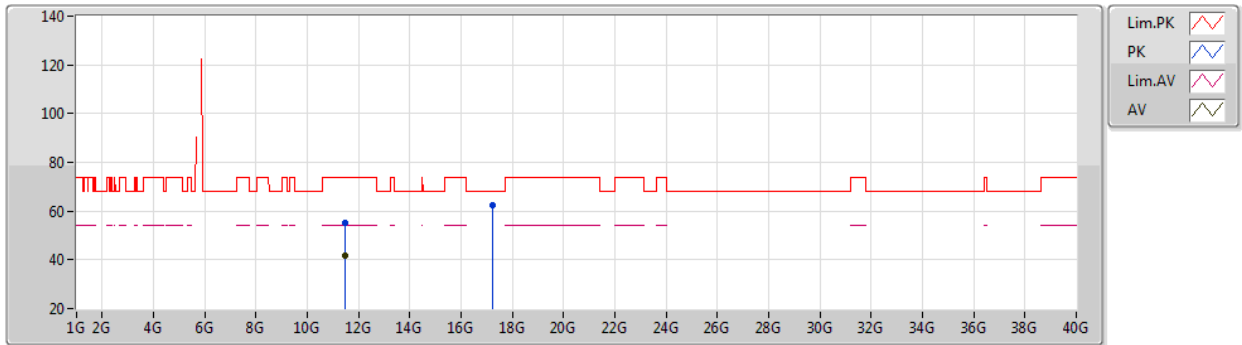

EUT X_1TX
Setting 24
02-D-J-7

Type	Freq (Hz)	Level (dBuV/m)	Limit (dBuV/m)	Margin (dB)	Raw (dBuV)	Dist (m)	Condition	Azimuth (°)	Height (m)	Comment	AF (dB)	CL (dB)	PA (dB)
PK	11.48618G	55.25	74.00	-18.75	39.21	3	Horizontal	138	1.33	-	38.79	8.85	31.60
AV	11.4877G	41.73	54.00	-12.27	25.69	3	Horizontal	138	1.33	-	38.79	8.85	31.60
PK	17.23526G	62.47	68.20	-5.73	41.68	3	Horizontal	51	1.59	-	42.45	10.15	31.81

802.11a_Nss1,(6Mbps)_1TX

23/03/2020

5785MHz_TX

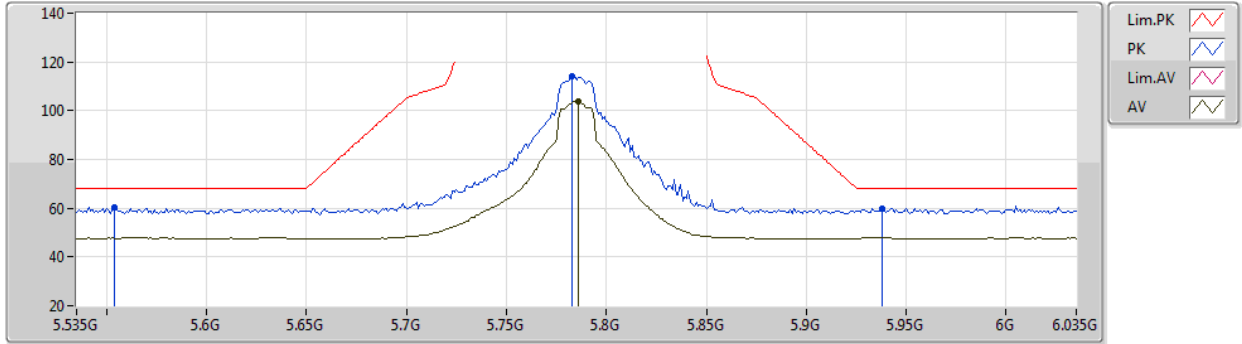

EUT X_1TX
Setting 24
02-D-J-7-10

Type	Freq (Hz)	Level (dBuV/m)	Limit (dBuV/m)	Margin (dB)	Raw (dBuV)	Dist (m)	Condition	Azimuth (°)	Height (m)	Comment	AF (dB)	CL (dB)	PA (dB)
PK	5.554G	60.57	68.20	-7.63	50.88	3	Vertical	346	2.13	-	33.95	6.26	30.52
PK	5.783G	114.11	Inf	-Inf	104.50	3	Vertical	346	2.13	-	33.80	6.39	30.58
AV	5.786G	103.61	Inf	-Inf	94.00	3	Vertical	346	2.13	-	33.80	6.39	30.58
PK	5.938G	59.91	68.20	-8.29	50.12	3	Vertical	346	2.13	-	34.08	6.33	30.62

802.11a_Nss1,(6Mbps)_1TX

23/03/2020

5785MHz_TX

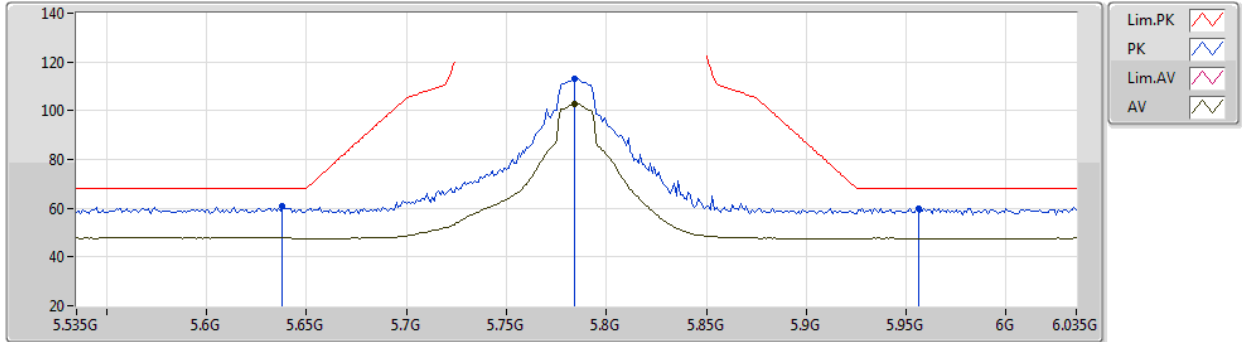

EUT X_1TX
Setting 24
02-D-J-7-10

Type	Freq (Hz)	Level (dBuV/m)	Limit (dBuV/m)	Margin (dB)	Raw (dBuV)	Dist (m)	Condition	Azimuth (°)	Height (m)	Comment	AF (dB)	CL (dB)	PA (dB)
PK	5.638G	60.61	68.20	-7.59	50.91	3	Horizontal	31	1.01	-	33.92	6.32	30.54
PK	5.784G	113.16	Inf	-Inf	103.55	3	Horizontal	31	1.01	-	33.80	6.39	30.58
AV	5.784G	102.81	Inf	-Inf	93.20	3	Horizontal	31	1.01	-	33.80	6.39	30.58
PK	5.956G	59.94	68.20	-8.26	50.13	3	Horizontal	31	1.01	-	34.11	6.32	30.62

802.11a_Nss1,(6Mbps)_1TX

23/03/2020

5785MHz_TX

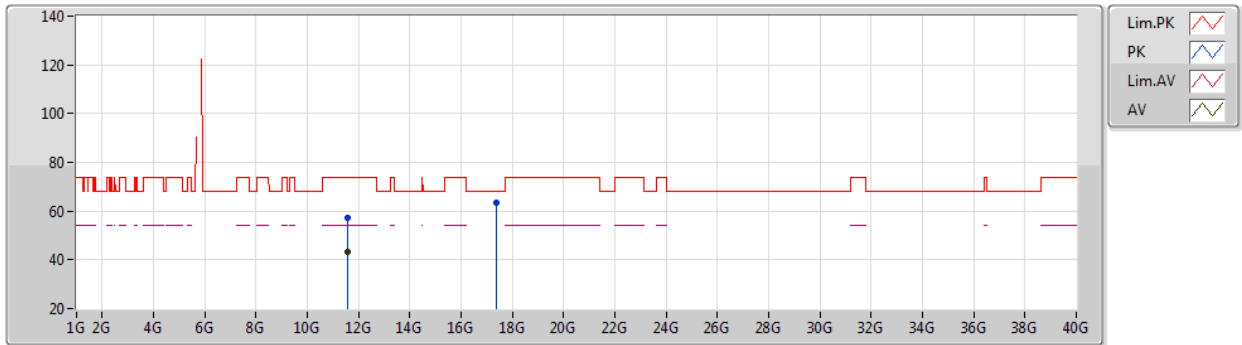

EUT X_1TX
Setting 24
02-D-J-7

Type	Freq (Hz)	Level (dBuV/m)	Limit (dBuV/m)	Margin (dB)	Raw (dBuV)	Dist (m)	Condition	Azimuth (°)	Height (m)	Comment	AF (dB)	CL (dB)	PA (dB)
PK	11.56874G	57.45	74.00	-16.55	41.36	3	Vertical	240	2.38	-	38.85	8.87	31.63
AV	11.5699G	43.43	54.00	-10.57	27.32	3	Vertical	240	2.38	-	38.86	8.88	31.63
PK	17.35842G	63.55	68.20	-4.65	42.07	3	Vertical	45	1.22	-	43.10	10.22	31.84

802.11a_Nss1,(6Mbps)_1TX

23/03/2020

5785MHz_TX

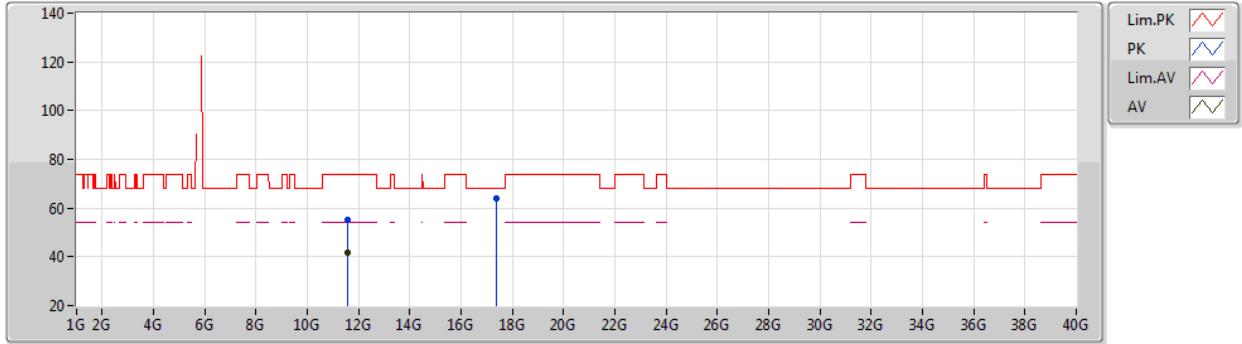

EUT X_1TX
Setting 24
02-D-J-7

Type	Freq (Hz)	Level (dBuV/m)	Limit (dBuV/m)	Margin (dB)	Raw (dBuV)	Dist (m)	Condition	Azimuth (°)	Height (m)	Comment	AF (dB)	CL (dB)	PA (dB)
PK	11.5707G	55.38	74.00	-18.62	39.27	3	Horizontal	335	1.55	-	38.86	8.88	31.63
AV	11.56984G	41.81	54.00	-12.19	25.70	3	Horizontal	335	1.55	-	38.86	8.88	31.63
PK	17.3559G	63.88	68.20	-4.32	42.41	3	Horizontal	20	2.41	-	43.09	10.22	31.84

802.11a_Nss1,(6Mbps)_1TX

23/03/2020

5825MHz_TX

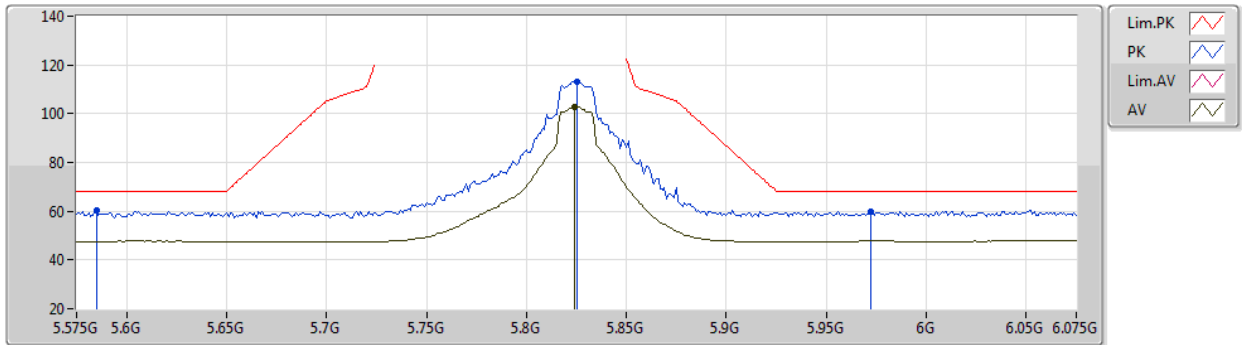

EUT X_1TX
Setting 24
02-D-J-7-10

Type	Freq (Hz)	Level (dBuV/m)	Limit (dBuV/m)	Margin (dB)	Raw (dBuV)	Dist (m)	Condition	Azimuth (°)	Height (m)	Comment	AF (dB)	CL (dB)	PA (dB)
PK	5.585G	60.35	68.20	-7.85	50.61	3	Vertical	345	2.03	-	33.98	6.29	30.53
PK	5.825G	113.29	Inf	-Inf	103.64	3	Vertical	345	2.03	-	33.85	6.39	30.59
AV	5.824G	102.86	Inf	-Inf	93.21	3	Vertical	345	2.03	-	33.85	6.39	30.59
PK	5.972G	59.96	68.20	-8.24	50.13	3	Vertical	345	2.03	-	34.14	6.31	30.62

802.11a_Nss1,(6Mbps)_1TX

23/03/2020

5825MHz_TX

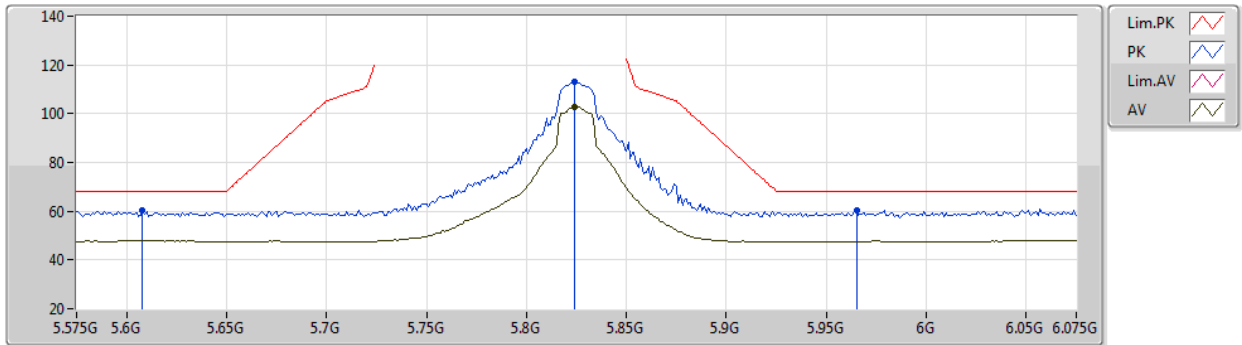

EUT X_1TX
Setting 24
02-D-J-7-10

Type	Freq (Hz)	Level (dBuV/m)	Limit (dBuV/m)	Margin (dB)	Raw (dBuV)	Dist (m)	Condition	Azimuth (°)	Height (m)	Comment	AF (dB)	CL (dB)	PA (dB)
PK	5.608G	60.47	68.20	-7.73	50.72	3	Horizontal	33	1.00	-	33.98	6.30	30.53
PK	5.824G	113.32	Inf	-Inf	103.67	3	Horizontal	33	1.00	-	33.85	6.39	30.59
AV	5.824G	102.91	Inf	-Inf	93.26	3	Horizontal	33	1.00	-	33.85	6.39	30.59
PK	5.965G	60.11	68.20	-8.09	50.28	3	Horizontal	33	1.00	-	34.13	6.32	30.62

802.11a_Nss1,(6Mbps)_1TX

23/03/2020

5825MHz_TX

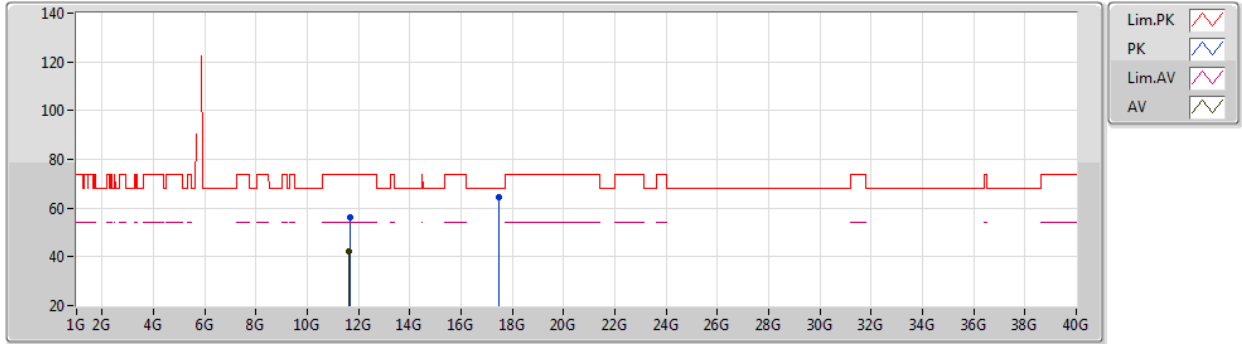

EUT X_1TX
Setting 24
02-D-J-7

Type	Freq (Hz)	Level (dBuV/m)	Limit (dBuV/m)	Margin (dB)	Raw (dBuV)	Dist (m)	Condition	Azimuth (°)	Height (m)	Comment	AF (dB)	CL (dB)	PA (dB)
PK	11.64986G	56.15	74.00	-17.85	39.98	3	Vertical	217	2.94	-	38.92	8.90	31.65
AV	11.64542G	42.08	54.00	-11.92	25.91	3	Vertical	217	2.94	-	38.92	8.90	31.65
PK	17.47344G	64.61	68.20	-3.59	42.48	3	Vertical	96	1.61	-	43.71	10.29	31.87

802.11a_Nss1,(6Mbps)_1TX

23/03/2020

5825MHz_TX

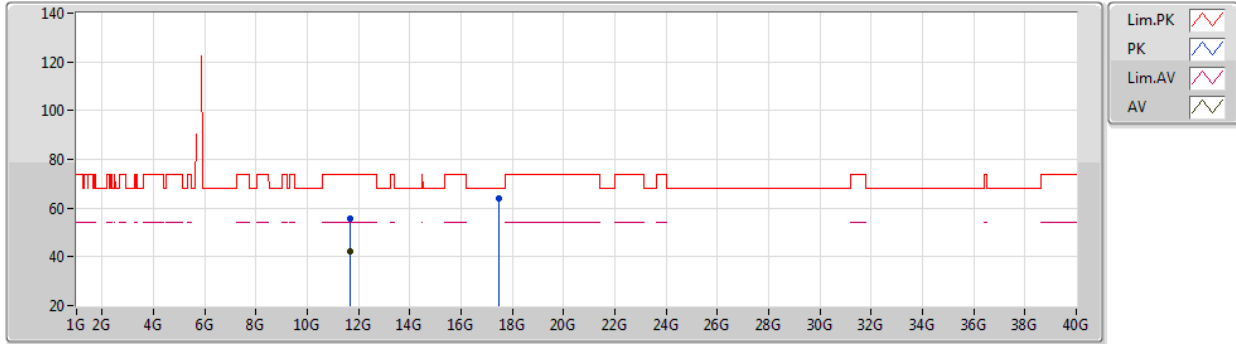

EUT X_1TX
Setting 24
02-D-J-7

Type	Freq (Hz)	Level (dBuV/m)	Limit (dBuV/m)	Margin (dB)	Raw (dBuV)	Dist (m)	Condition	Azimuth (°)	Height (m)	Comment	AF (dB)	CL (dB)	PA (dB)
PK	11.65001G	55.86	74.00	-18.14	39.69	3	Horizontal	185	1.60	-	38.92	8.90	31.65
AV	11.64986G	42.04	54.00	-11.96	25.87	3	Horizontal	185	1.60	-	38.92	8.90	31.65
PK	17.47742G	64.22	68.20	-3.98	42.07	3	Horizontal	83	1.92	-	43.73	10.29	31.87

802.11ac VHT20_Nss1,(MCS0)_1TX

23/03/2020

5180MHz_TX

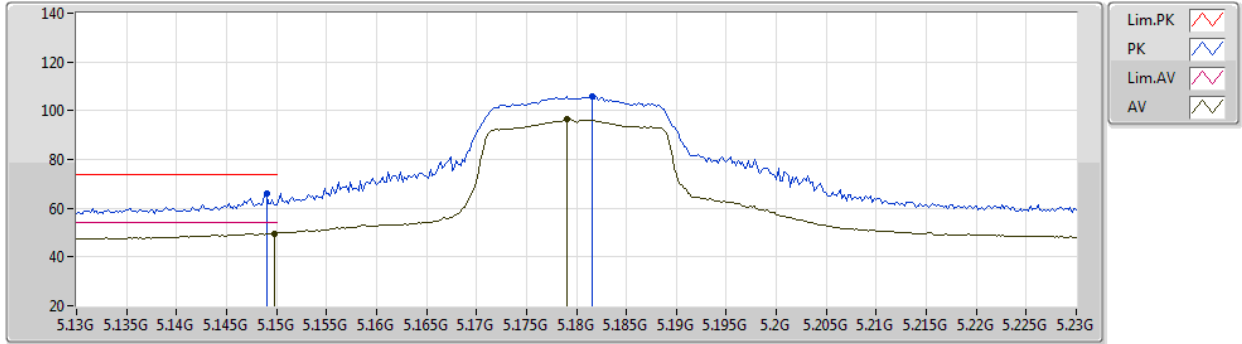

EUT X_1TX
Setting 16
02-D-J-7-10

Type	Freq (Hz)	Level (dBuV/m)	Limit (dBuV/m)	Margin (dB)	Raw (dBuV)	Dist (m)	Condition	Azimuth (°)	Height (m)	Comment	AF (dB)	CL (dB)	PA (dB)
PK	5.149G	65.87	74.00	-8.13	56.73	3	Vertical	21	2.41	-	33.55	5.97	30.38
AV	5.1498G	49.68	54.00	-4.32	40.54	3	Vertical	21	2.41	-	33.55	5.97	30.38
PK	5.1816G	105.74	Inf	-Inf	96.56	3	Vertical	21	2.41	-	33.58	5.99	30.39
AV	5.179G	96.71	Inf	-Inf	87.53	3	Vertical	21	2.41	-	33.58	5.99	30.39

802.11ac VHT20_Nss1,(MCS0)_1TX

23/03/2020

5180MHz_TX

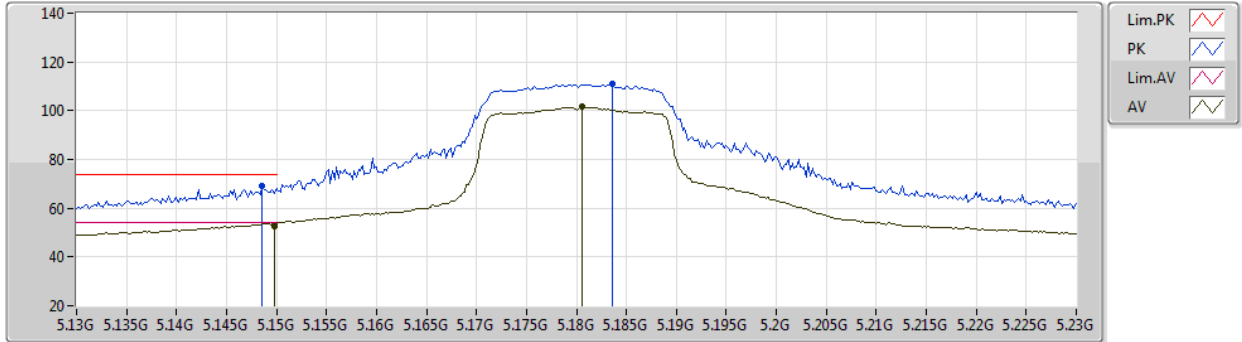

EUT X_1TX
Setting 16
02-D-J-7-10

Type	Freq (Hz)	Level (dBuV/m)	Limit (dBuV/m)	Margin (dB)	Raw (dBuV)	Dist (m)	Condition	Azimuth (°)	Height (m)	Comment	AF (dB)	CL (dB)	PA (dB)
PK	5.1486G	69.18	74.00	-4.82	60.04	3	Horizontal	359	1.00	-	33.55	5.97	30.38
AV	5.1498G	52.84	54.00	-1.16	43.70	3	Horizontal	359	1.00	-	33.55	5.97	30.38
PK	5.1836G	111.06	Inf	-Inf	101.89	3	Horizontal	359	1.00	-	33.58	5.99	30.40
AV	5.1806G	101.53	Inf	-Inf	92.35	3	Horizontal	359	1.00	-	33.58	5.99	30.39

802.11ac VHT20_Nss1,(MCS0)_1TX

23/03/2020

5180MHz_TX

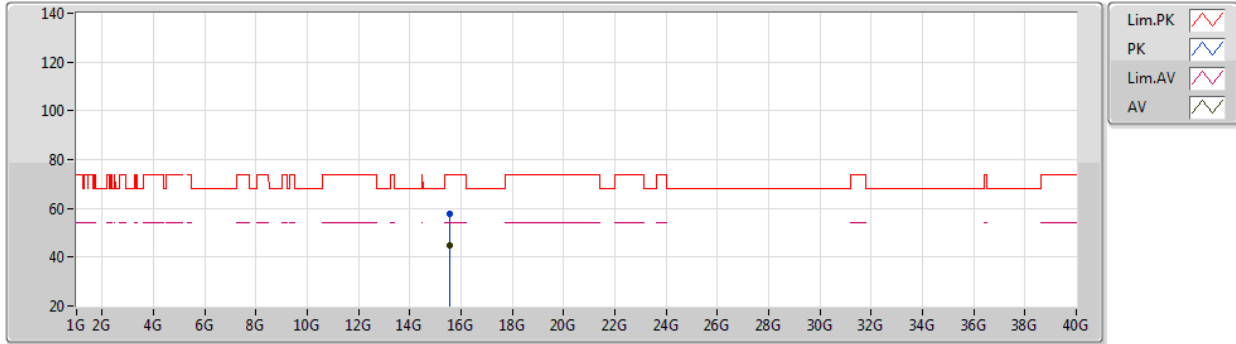

EUT X_1TX
Setting 16
02-D-B-2

Type	Freq (Hz)	Level (dBuV/m)	Limit (dBuV/m)	Margin (dB)	Raw (dBuV)	Dist (m)	Condition	Azimuth (°)	Height (m)	Comment	AF (dB)	CL (dB)	PA (dB)
PK	15.54088G	57.73	74.00	-16.27	41.73	3	Vertical	332	1.80	-	38.73	9.25	31.98
AV	15.539G	44.94	54.00	-9.06	28.93	3	Vertical	332	1.80	-	38.74	9.25	31.98

802.11ac VHT20_Nss1,(MCS0)_1TX

23/03/2020

5180MHz_TX

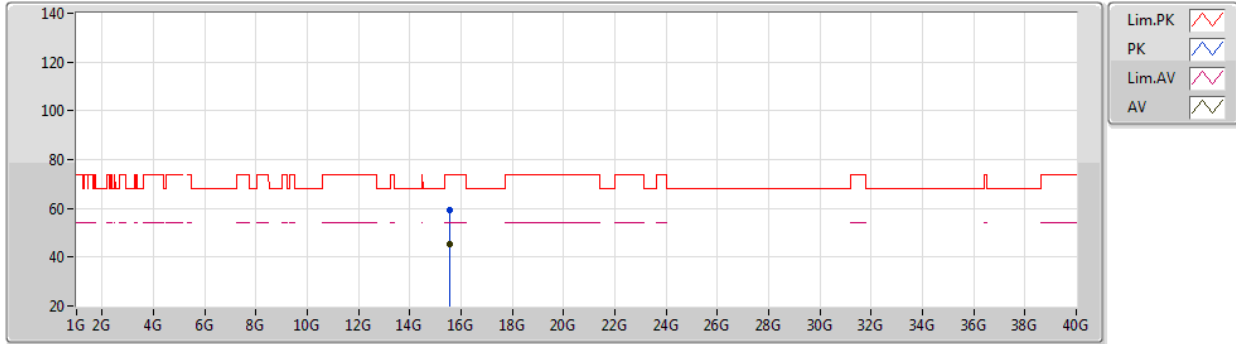

EUT X_1TX
Setting 16
02-D-B-2

Type	Freq (Hz)	Level (dBuV/m)	Limit (dBuV/m)	Margin (dB)	Raw (dBuV)	Dist (m)	Condition	Azimuth (°)	Height (m)	Comment	AF (dB)	CL (dB)	PA (dB)
PK	15.54322G	59.27	74.00	-14.73	43.28	3	Horizontal	355	2.09	-	38.72	9.25	31.98
AV	15.54236G	45.56	54.00	-8.44	29.56	3	Horizontal	355	2.09	-	38.73	9.25	31.98

802.11ac VHT20_Nss1,(MCS0)_1TX

23/03/2020

5200MHz_TX

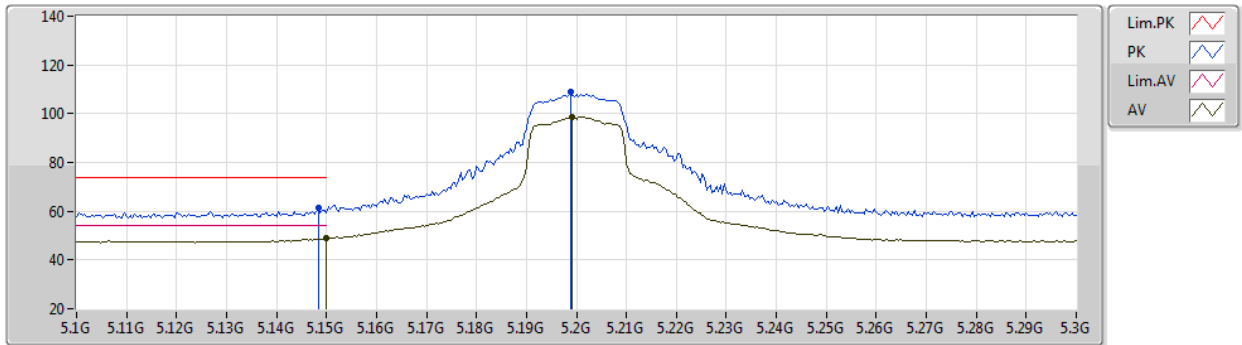

EUT X_1TX
Setting 20
02-D-J-7-10

Type	Freq (Hz)	Level (dBuV/m)	Limit (dBuV/m)	Margin (dB)	Raw (dBuV)	Dist (m)	Condition	Azimuth (°)	Height (m)	Comment	AF (dB)	CL (dB)	PA (dB)
PK	5.1484G	61.39	74.00	-12.61	52.25	3	Vertical	343	1.14	-	33.55	5.97	30.38
AV	5.15G	48.80	54.00	-5.20	39.66	3	Vertical	343	1.14	-	33.55	5.97	30.38
PK	5.1988G	108.91	Inf	-Inf	99.71	3	Vertical	343	1.14	-	33.60	6.00	30.40
AV	5.1992G	98.72	Inf	-Inf	89.52	3	Vertical	343	1.14	-	33.60	6.00	30.40

802.11ac VHT20_Nss1,(MCS0)_1TX

23/03/2020

5200MHz_TX

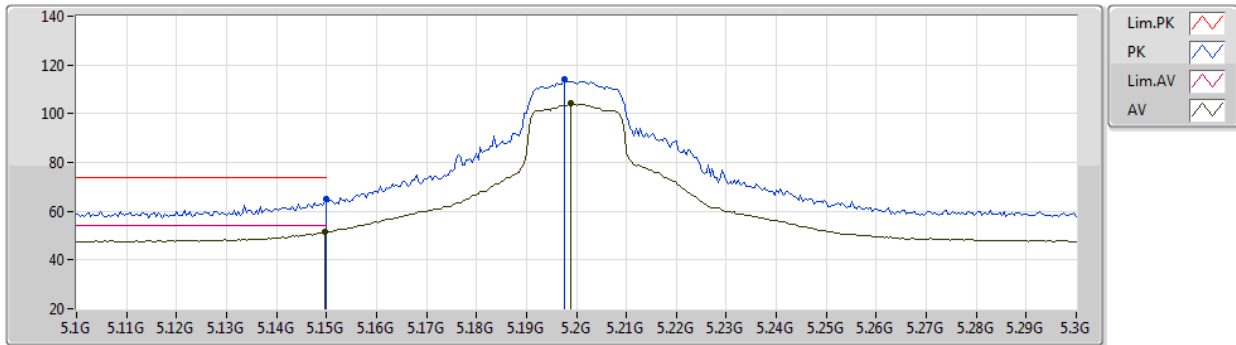

EUT X_1TX
Setting 20
02-D-J-7-10

Type	Freq (Hz)	Level (dBuV/m)	Limit (dBuV/m)	Margin (dB)	Raw (dBuV)	Dist (m)	Condition	Azimuth (°)	Height (m)	Comment	AF (dB)	CL (dB)	PA (dB)
PK	5.15G	64.77	74.00	-9.23	55.63	3	Horizontal	359	1.00	-	33.55	5.97	30.38
AV	5.1496G	51.50	54.00	-2.50	42.36	3	Horizontal	359	1.00	-	33.55	5.97	30.38
PK	5.1976G	114.05	Inf	-Inf	104.85	3	Horizontal	359	1.00	-	33.60	6.00	30.40
AV	5.1988G	104.06	Inf	-Inf	94.86	3	Horizontal	359	1.00	-	33.60	6.00	30.40

802.11ac VHT20_Nss1,(MCS0)_1TX

23/03/2020

5200MHz_TX

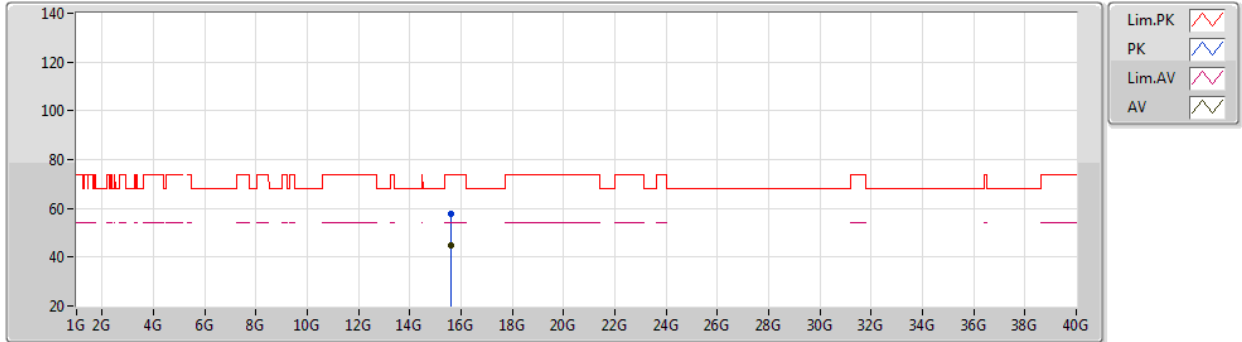

EUT X_1TX
Setting 20
02-D-B-2

Type	Freq (Hz)	Level (dBuV/m)	Limit (dBuV/m)	Margin (dB)	Raw (dBuV)	Dist (m)	Condition	Azimuth (°)	Height (m)	Comment	AF (dB)	CL (dB)	PA (dB)
PK	15.59896G	57.93	74.00	-16.07	42.09	3	Vertical	265	1.80	-	38.56	9.27	31.99
AV	15.59924G	44.83	54.00	-9.17	28.99	3	Vertical	265	1.80	-	38.56	9.27	31.99

802.11ac VHT20_Nss1,(MCS0)_1TX

23/03/2020

5200MHz_TX

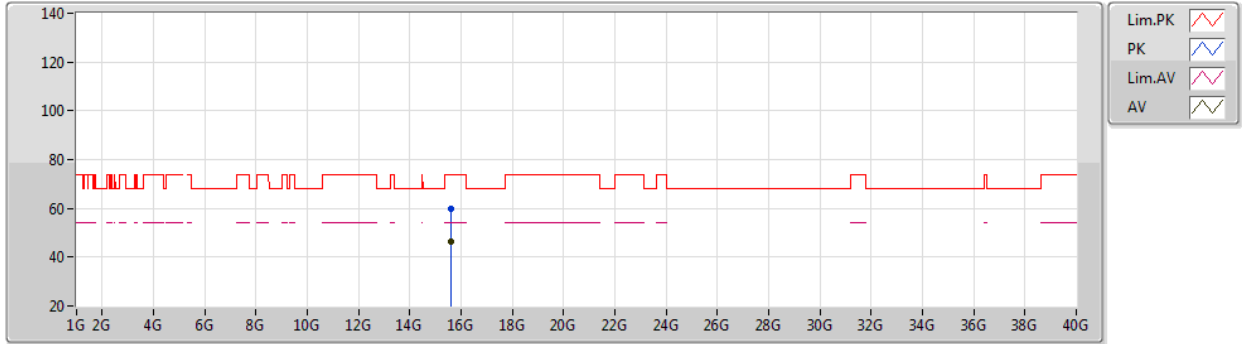

EUT X_1TX
Setting 20
02-D-B-2

Type	Freq (Hz)	Level (dBuV/m)	Limit (dBuV/m)	Margin (dB)	Raw (dBuV)	Dist (m)	Condition	Azimuth (°)	Height (m)	Comment	AF (dB)	CL (dB)	PA (dB)
PK	15.59772G	59.99	74.00	-14.01	44.14	3	Horizontal	349	2.43	-	38.57	9.27	31.99
AV	15.59862G	46.33	54.00	-7.67	30.49	3	Horizontal	349	2.43	-	38.56	9.27	31.99

802.11ac VHT20_Nss1,(MCS0)_1TX

23/03/2020

5240MHz_TX

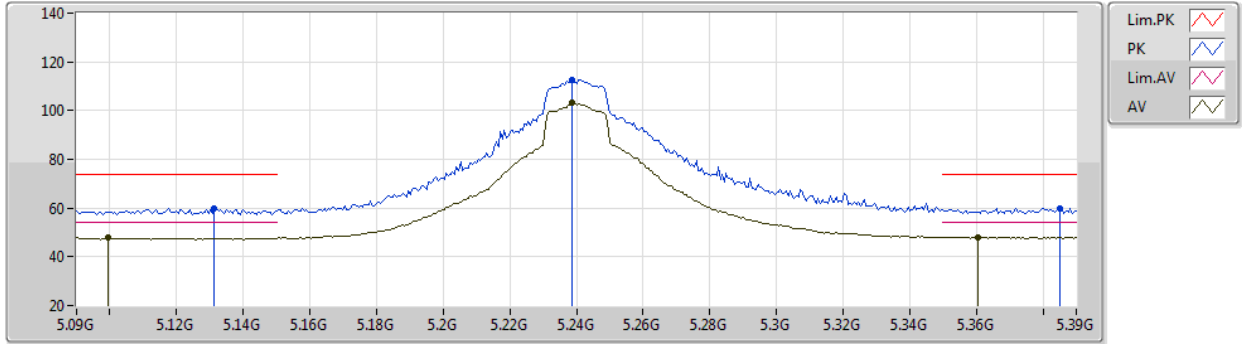

EUT X_1TX
Setting 24
02-D-J-7-10

Type	Freq (Hz)	Level (dBuV/m)	Limit (dBuV/m)	Margin (dB)	Raw (dBuV)	Dist (m)	Condition	Azimuth (°)	Height (m)	Comment	AF (dB)	CL (dB)	PA (dB)
PK	5.1314G	60.05	74.00	-13.95	50.93	3	Vertical	340	1.01	-	33.53	5.97	30.38
AV	5.0996G	47.77	54.00	-6.23	38.69	3	Vertical	340	1.01	-	33.50	5.95	30.37
PK	5.2388G	112.63	Inf	-Inf	103.35	3	Vertical	340	1.01	-	33.68	6.02	30.42
AV	5.2388G	103.09	Inf	-Inf	93.81	3	Vertical	340	1.01	-	33.68	6.02	30.42
PK	5.3852G	59.82	74.00	-14.18	50.31	3	Vertical	340	1.01	-	33.89	6.09	30.47
AV	5.3606G	48.11	54.00	-5.89	38.63	3	Vertical	340	1.01	-	33.86	6.08	30.46

802.11ac VHT20_Nss1,(MCS0)_1TX

23/03/2020

5240MHz_TX

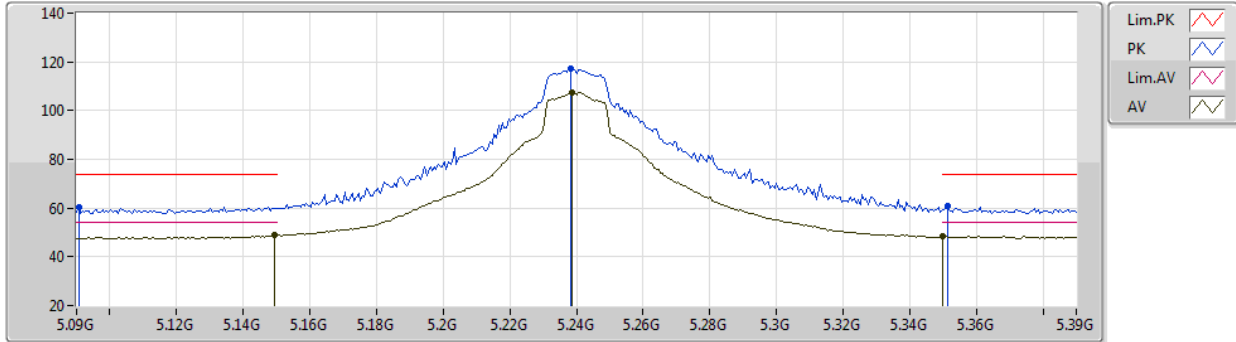

EUT X_1TX
Setting 24
02-D-J-7-10

Type	Freq (Hz)	Level (dBuV/m)	Limit (dBuV/m)	Margin (dB)	Raw (dBuV)	Dist (m)	Condition	Azimuth (°)	Height (m)	Comment	AF (dB)	CL (dB)	PA (dB)
PK	5.0906G	60.56	74.00	-13.44	51.50	3	Horizontal	0	1.00	-	33.48	5.95	30.37
AV	5.1494G	48.97	54.00	-5.03	39.83	3	Horizontal	0	1.00	-	33.55	5.97	30.38
PK	5.2382G	117.24	Inf	-Inf	107.96	3	Horizontal	0	1.00	-	33.68	6.02	30.42
AV	5.2388G	107.64	Inf	-Inf	98.36	3	Horizontal	0	1.00	-	33.68	6.02	30.42
PK	5.3516G	61.10	74.00	-12.90	51.63	3	Horizontal	0	1.00	-	33.85	6.08	30.46
AV	5.35G	48.28	54.00	-5.72	38.81	3	Horizontal	0	1.00	-	33.85	6.08	30.46

802.11ac VHT20_Nss1,(MCS0)_1TX

23/03/2020

5240MHz_TX

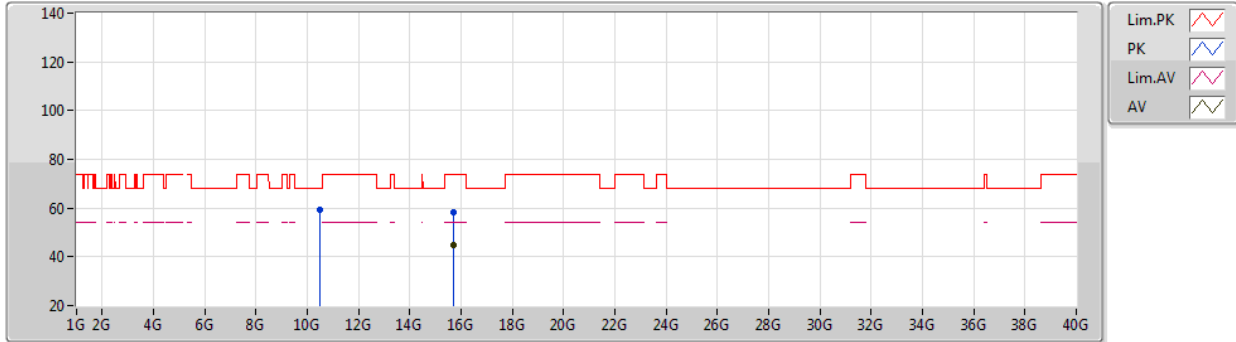

EUT X_1TX
Setting 24
02-D-B-2

Type	Freq (Hz)	Level (dBuV/m)	Limit (dBuV/m)	Margin (dB)	Raw (dBuV)	Dist (m)	Condition	Azimuth (°)	Height (m)	Comment	AF (dB)	CL (dB)	PA (dB)
PK	10.47908G	59.35	68.20	-8.85	43.53	3	Vertical	358	2.59	-	38.76	8.55	31.49
PK	15.71812G	58.47	74.00	-15.53	42.96	3	Vertical	359	1.00	-	38.22	9.31	32.02
AV	15.72108G	45.07	54.00	-8.93	29.57	3	Vertical	359	1.00	-	38.21	9.31	32.02

802.11ac VHT20_Nss1,(MCS0)_1TX

23/03/2020

5240MHz_TX

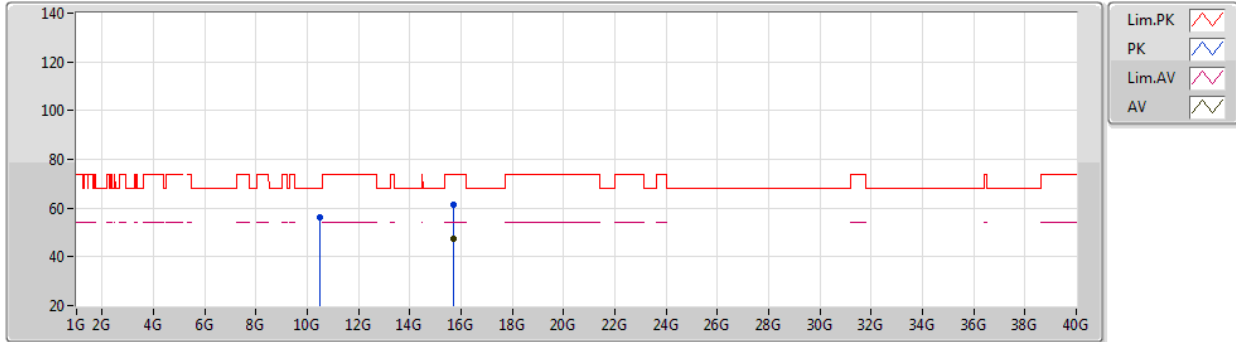

EUT X_1TX
Setting 24
02-D-B-2

Type	Freq (Hz)	Level (dBuV/m)	Limit (dBuV/m)	Margin (dB)	Raw (dBuV)	Dist (m)	Condition	Azimuth (°)	Height (m)	Comment	AF (dB)	CL (dB)	PA (dB)
PK	10.48816G	55.99	68.20	-12.21	40.17	3	Horizontal	300	3.00	-	38.76	8.55	31.49
PK	15.7209G	61.22	74.00	-12.78	45.72	3	Horizontal	359	2.07	-	38.21	9.31	32.02
AV	15.72076G	47.58	54.00	-6.42	32.08	3	Horizontal	359	2.07	-	38.21	9.31	32.02

802.11ac VHT20_Nss1,(MCS0)_1TX

23/03/2020

5260MHz_TX

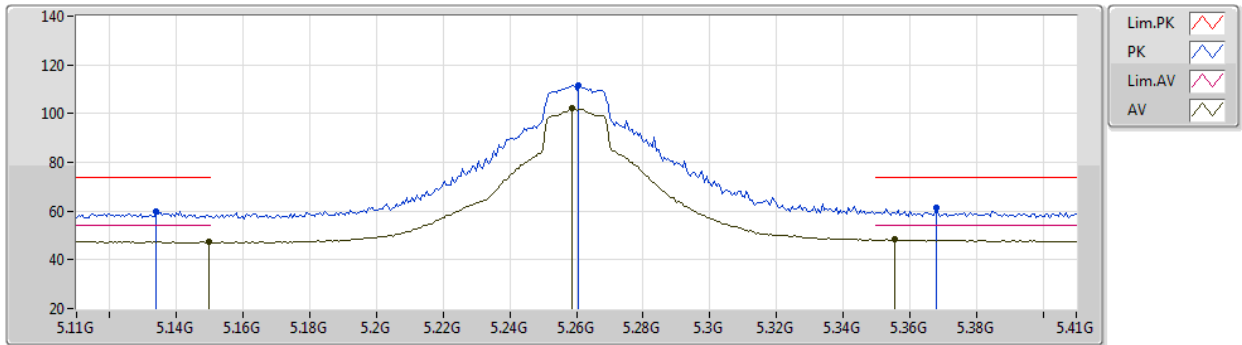

EUT X_1TX
Setting 24
02-D-J-7-10

Type	Freq (Hz)	Level (dBuV/m)	Limit (dBuV/m)	Margin (dB)	Raw (dBuV)	Dist (m)	Condition	Azimuth (°)	Height (m)	Comment	AF (dB)	CL (dB)	PA (dB)
PK	5.134G	59.87	74.00	-14.13	50.75	3	Vertical	15	2.16	-	33.53	5.97	30.38
AV	5.1496G	47.47	54.00	-6.53	38.33	3	Vertical	15	2.16	-	33.55	5.97	30.38
PK	5.2606G	111.41	Inf	-Inf	102.08	3	Vertical	15	2.16	-	33.72	6.03	30.42
AV	5.2588G	102.10	Inf	-Inf	92.77	3	Vertical	15	2.16	-	33.72	6.03	30.42
PK	5.368G	61.50	74.00	-12.50	52.01	3	Vertical	15	2.16	-	33.87	6.08	30.46
AV	5.3554G	48.29	54.00	-5.71	38.81	3	Vertical	15	2.16	-	33.86	6.08	30.46

802.11ac VHT20_Nss1,(MCS0)_1TX

23/03/2020

5260MHz_TX

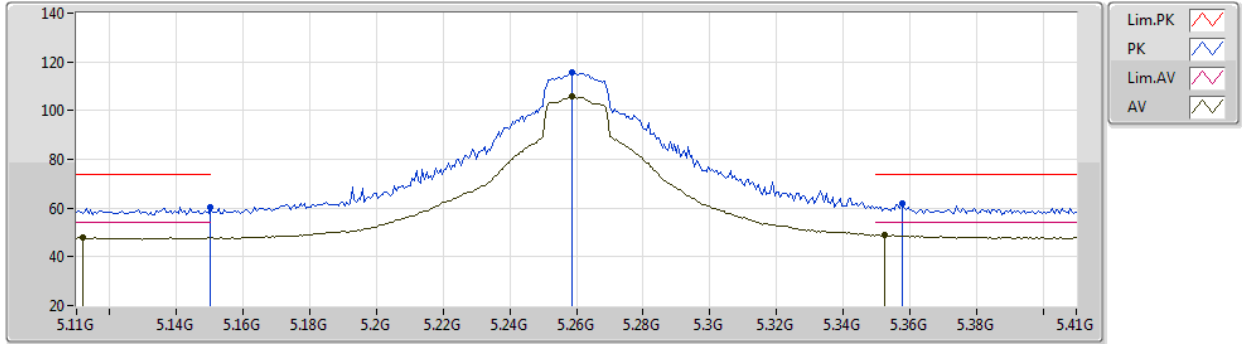

EUT X_1TX
Setting 24
02-D-J-7-10

Type	Freq (Hz)	Level (dBuV/m)	Limit (dBuV/m)	Margin (dB)	Raw (dBuV)	Dist (m)	Condition	Azimuth (°)	Height (m)	Comment	AF (dB)	CL (dB)	PA (dB)
PK	5.15G	60.56	74.00	-13.44	51.42	3	Horizontal	0	1.03	-	33.55	5.97	30.38
AV	5.1118G	47.96	54.00	-6.04	38.86	3	Horizontal	0	1.03	-	33.51	5.96	30.37
PK	5.2588G	115.44	Inf	-Inf	106.11	3	Horizontal	0	1.03	-	33.72	6.03	30.42
AV	5.2588G	105.88	Inf	-Inf	96.55	3	Horizontal	0	1.03	-	33.72	6.03	30.42
PK	5.3578G	61.99	74.00	-12.01	52.51	3	Horizontal	0	1.03	-	33.86	6.08	30.46
AV	5.3524G	48.97	54.00	-5.03	39.50	3	Horizontal	0	1.03	-	33.85	6.08	30.46

802.11ac VHT20_Nss1,(MCS0)_1TX

23/03/2020

5260MHz_TX

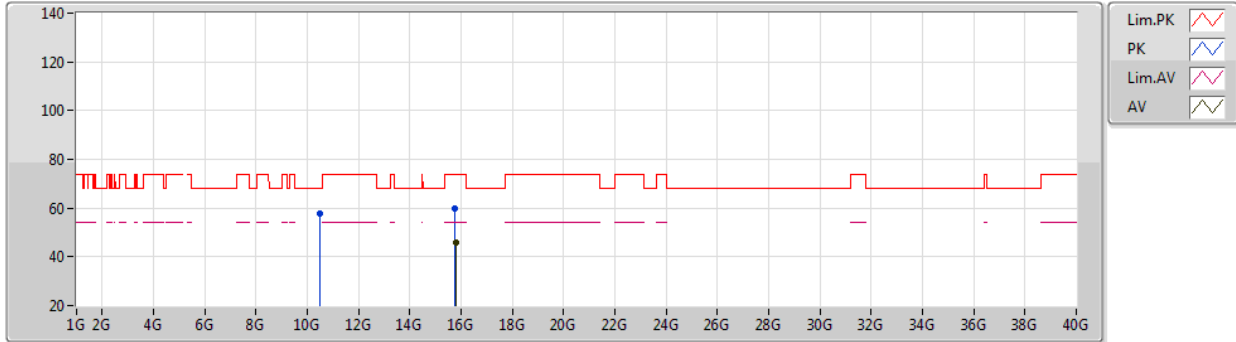

EUT X_1TX
Setting 24
02-D-B-2

Type	Freq (Hz)	Level (dBuV/m)	Limit (dBuV/m)	Margin (dB)	Raw (dBuV)	Dist (m)	Condition	Azimuth (°)	Height (m)	Comment	AF (dB)	CL (dB)	PA (dB)
PK	10.51596G	57.77	68.20	-10.43	41.95	3	Vertical	360	2.08	-	38.74	8.56	31.48
PK	15.77514G	59.68	74.00	-14.32	44.33	3	Vertical	8	1.75	-	38.05	9.33	32.03
AV	15.78318G	45.82	54.00	-8.18	30.49	3	Vertical	8	1.75	-	38.03	9.33	32.03

802.11ac VHT20_Nss1,(MCS0)_1TX

23/03/2020

5260MHz_TX

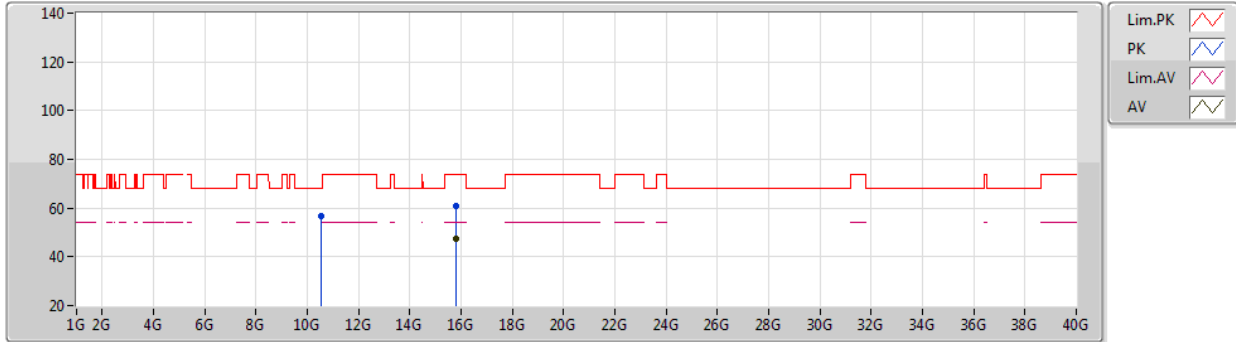

EUT X_1TX
Setting 24
02-D-B-2

Type	Freq (Hz)	Level (dBuV/m)	Limit (dBuV/m)	Margin (dB)	Raw (dBuV)	Dist (m)	Condition	Azimuth (°)	Height (m)	Comment	AF (dB)	CL (dB)	PA (dB)
PK	10.51894G	56.59	68.20	-11.61	40.77	3	Horizontal	319	1.03	-	38.74	8.56	31.48
PK	15.7831G	60.61	74.00	-13.39	45.28	3	Horizontal	359	1.80	-	38.03	9.33	32.03
AV	15.77884G	47.26	54.00	-6.74	31.92	3	Horizontal	359	1.80	-	38.04	9.33	32.03

802.11ac VHT20_Nss1,(MCS0)_1TX

23/03/2020

5300MHz_TX

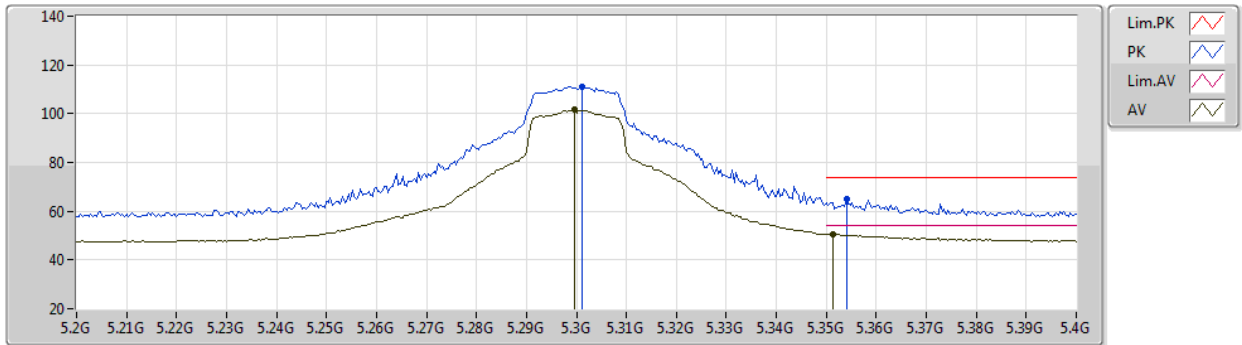

EUT X_1TX
Setting 23
02-D-J-7-10

Type	Freq (Hz)	Level (dBuV/m)	Limit (dBuV/m)	Margin (dB)	Raw (dBuV)	Dist (m)	Condition	Azimuth (°)	Height (m)	Comment	AF (dB)	CL (dB)	PA (dB)
PK	5.3012G	111.19	Inf	-Inf	101.78	3	Vertical	337	1.00	-	33.80	6.05	30.44
AV	5.2996G	101.49	Inf	-Inf	92.08	3	Vertical	337	1.00	-	33.80	6.05	30.44
PK	5.354G	64.78	74.00	-9.22	55.31	3	Vertical	337	1.00	-	33.85	6.08	30.46
AV	5.3512G	50.69	54.00	-3.31	41.22	3	Vertical	337	1.00	-	33.85	6.08	30.46

802.11ac VHT20_Nss1,(MCS0)_1TX

23/03/2020

5300MHz_TX

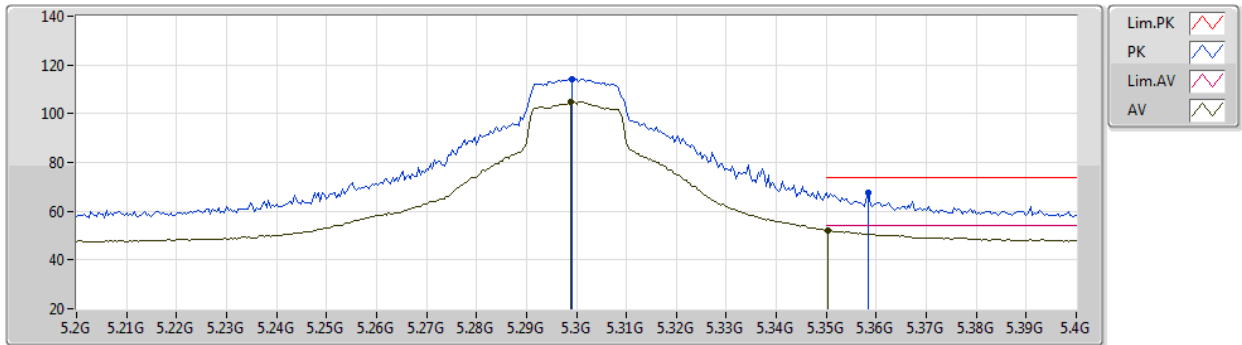

EUT X_1TX
Setting 23
02-D-J-7-10

Type	Freq (Hz)	Level (dBuV/m)	Limit (dBuV/m)	Margin (dB)	Raw (dBuV)	Dist (m)	Condition	Azimuth (°)	Height (m)	Comment	AF (dB)	CL (dB)	PA (dB)
PK	5.2992G	114.21	Inf	-Inf	104.80	3	Horizontal	353	1.00	-	33.80	6.05	30.44
AV	5.2988G	105.02	Inf	-Inf	95.61	3	Horizontal	353	1.00	-	33.80	6.05	30.44
PK	5.3584G	67.78	74.00	-6.22	58.30	3	Horizontal	353	1.00	-	33.86	6.08	30.46
AV	5.3504G	52.27	54.00	-1.73	42.80	3	Horizontal	353	1.00	-	33.85	6.08	30.46

802.11ac VHT20_Nss1,(MCS0)_1TX

23/03/2020

5300MHz_TX

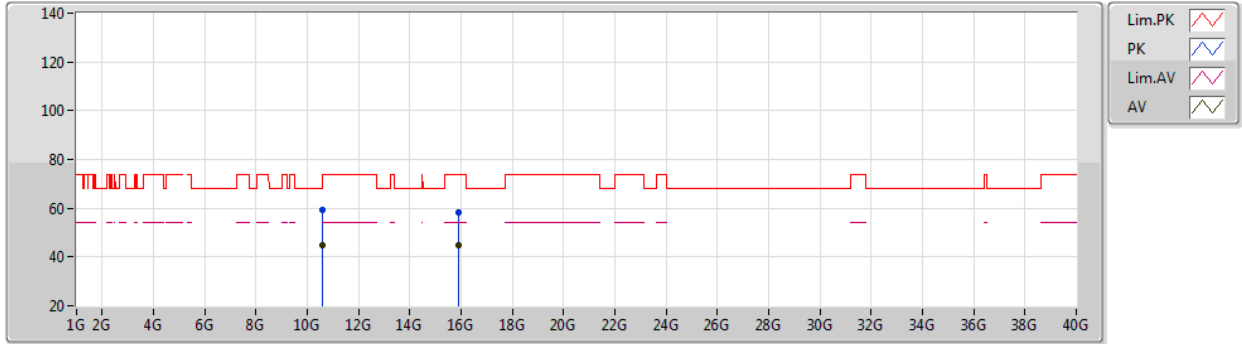

EUT X_1TX
Setting 23
02-D-J-7

Type	Freq (Hz)	Level (dBuV/m)	Limit (dBuV/m)	Margin (dB)	Raw (dBuV)	Dist (m)	Condition	Azimuth (°)	Height (m)	Comment	AF (dB)	CL (dB)	PA (dB)
PK	10.60772G	59.15	68.20	-9.05	43.36	3	Vertical	20	1.79	-	38.68	8.59	31.48
AV	10.60092G	44.85	54.00	-9.15	29.06	3	Vertical	20	1.79	-	38.68	8.59	31.48
PK	15.8964G	58.42	74.00	-15.58	43.41	3	Vertical	305	1.80	-	37.70	9.37	32.06
AV	15.89768G	44.96	54.00	-9.04	29.95	3	Vertical	305	1.80	-	37.70	9.37	32.06

802.11ac VHT20_Nss1,(MCS0)_1TX

23/03/2020

5300MHz_TX

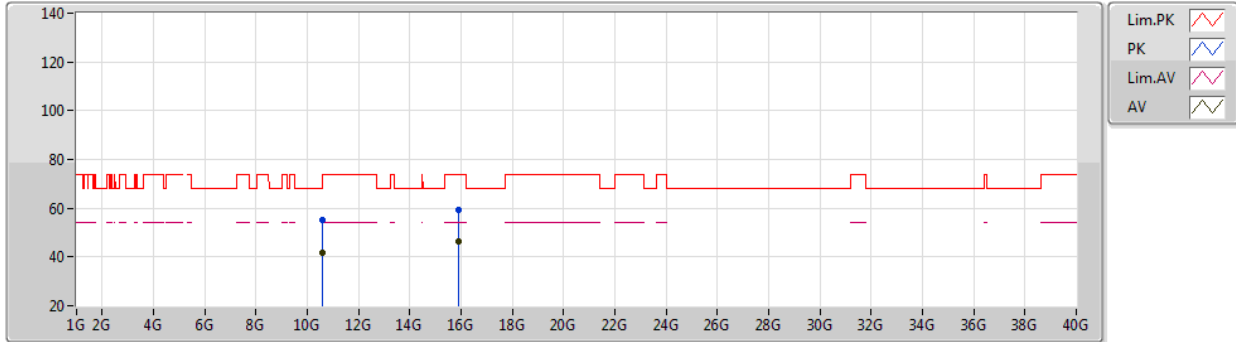

EUT X_1TX
Setting 23
02-D-J-7

Type	Freq (Hz)	Level (dBuV/m)	Limit (dBuV/m)	Margin (dB)	Raw (dBuV)	Dist (m)	Condition	Azimuth (°)	Height (m)	Comment	AF (dB)	CL (dB)	PA (dB)
PK	10.60746G	55.36	74.00	-18.64	39.58	3	Horizontal	357	2.13	-	38.67	8.59	31.48
AV	10.60564G	41.92	54.00	-12.08	26.13	3	Horizontal	357	2.13	-	38.68	8.59	31.48
PK	15.9004G	59.40	74.00	-14.60	44.40	3	Horizontal	360	2.13	-	37.69	9.37	32.06
AV	15.90066G	46.21	54.00	-7.79	31.21	3	Horizontal	360	2.13	-	37.69	9.37	32.06

802.11ac VHT20_Nss1,(MCS0)_1TX

23/03/2020

5320MHz_TX

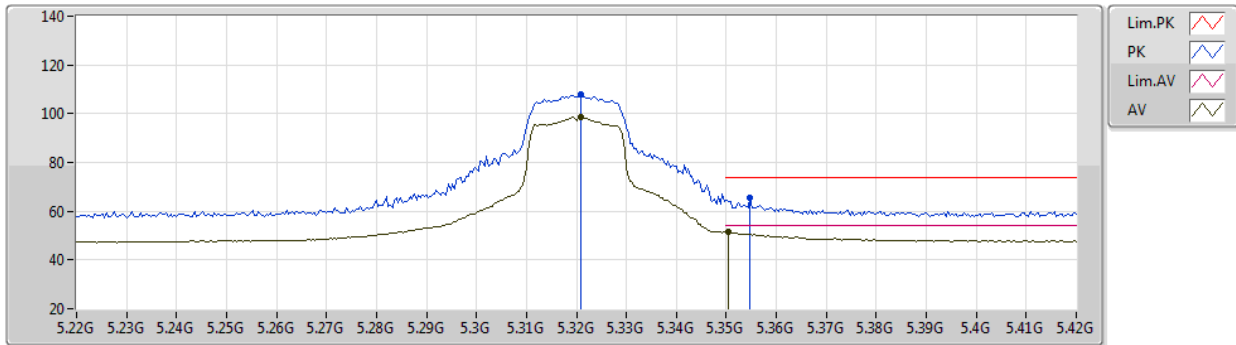

EUT X_1TX
Setting 19
02-D-J-7-10

Type	Freq (Hz)	Level (dBuV/m)	Limit (dBuV/m)	Margin (dB)	Raw (dBuV)	Dist (m)	Condition	Azimuth (°)	Height (m)	Comment	AF (dB)	CL (dB)	PA (dB)
PK	5.3208G	107.74	Inf	-Inf	98.31	3	Vertical	338	1.04	-	33.82	6.06	30.45
AV	5.3208G	98.40	Inf	-Inf	88.97	3	Vertical	338	1.04	-	33.82	6.06	30.45
PK	5.3548G	65.46	74.00	-8.54	55.99	3	Vertical	338	1.04	-	33.85	6.08	30.46
AV	5.3504G	51.42	54.00	-2.58	41.95	3	Vertical	338	1.04	-	33.85	6.08	30.46

802.11ac VHT20_Nss1,(MCS0)_1TX

23/03/2020

5320MHz_TX

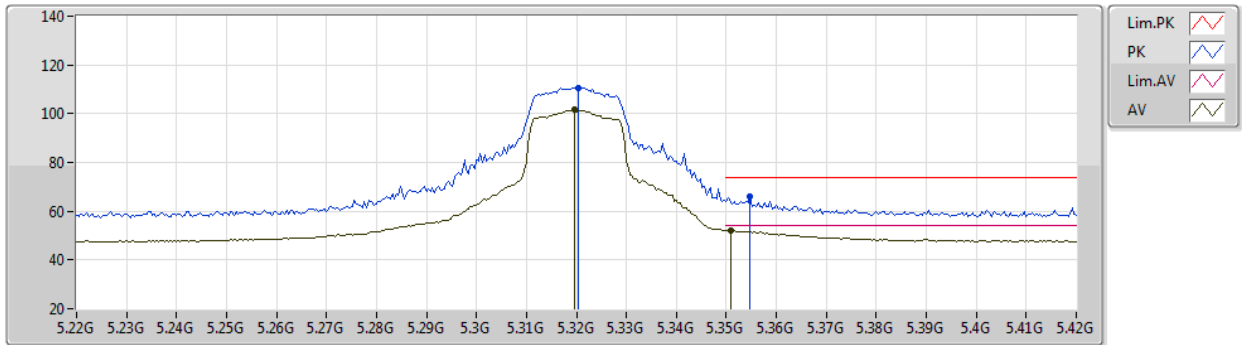

EUT X_1TX
Setting 19
02-D-J-7-10

Type	Freq (Hz)	Level (dBuV/m)	Limit (dBuV/m)	Margin (dB)	Raw (dBuV)	Dist (m)	Condition	Azimuth (°)	Height (m)	Comment	AF (dB)	CL (dB)	PA (dB)
PK	5.3204G	110.76	Inf	-Inf	101.33	3	Horizontal	355	1.17	-	33.82	6.06	30.45
AV	5.3196G	101.54	Inf	-Inf	92.11	3	Horizontal	355	1.17	-	33.82	6.06	30.45
PK	5.3548G	65.87	74.00	-8.13	56.40	3	Horizontal	355	1.17	-	33.85	6.08	30.46
AV	5.3508G	52.18	54.00	-1.82	42.71	3	Horizontal	355	1.17	-	33.85	6.08	30.46

802.11ac VHT20_Nss1,(MCS0)_1TX

23/03/2020

5320MHz_TX

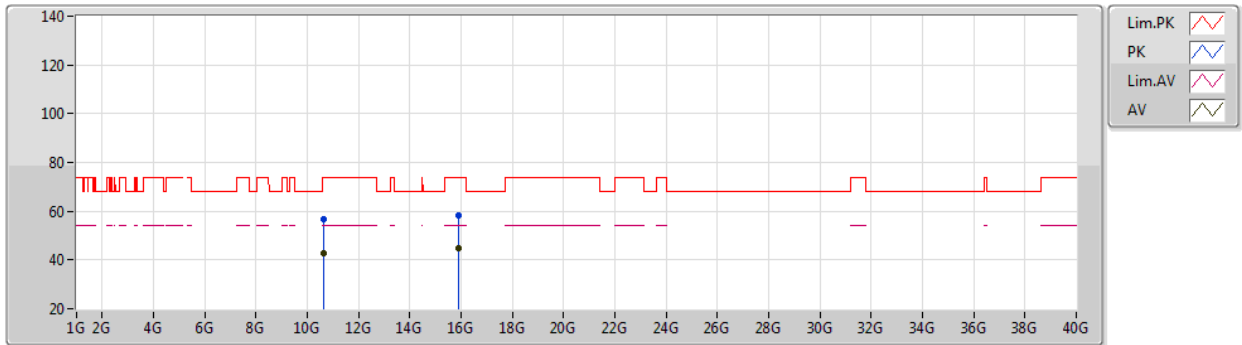

EUT X_1TX
Setting 19
02-D-J-7

Type	Freq (Hz)	Level (dBuV/m)	Limit (dBuV/m)	Margin (dB)	Raw (dBuV)	Dist (m)	Condition	Azimuth (°)	Height (m)	Comment	AF (dB)	CL (dB)	PA (dB)
PK	10.63884G	56.90	74.00	-17.10	41.13	3	Vertical	0	2.84	-	38.65	8.60	31.48
AV	10.63832G	42.53	54.00	-11.47	26.76	3	Vertical	0	2.84	-	38.65	8.60	31.48
PK	15.9025G	58.36	74.00	-15.64	43.37	3	Vertical	40	1.16	-	37.68	9.37	32.06
AV	15.90066G	44.77	54.00	-9.23	29.77	3	Vertical	40	1.16	-	37.69	9.37	32.06

802.11ac VHT20_Nss1,(MCS0)_1TX

23/03/2020

5320MHz_TX



EUT X_1TX
Setting 19
02-D-J-7

Type	Freq (Hz)	Level (dBuV/m)	Limit (dBuV/m)	Margin (dB)	Raw (dBuV)	Dist (m)	Condition	Azimuth (°)	Height (m)	Comment	AF (dB)	CL (dB)	PA (dB)
PK	10.6351G	54.99	74.00	-19.01	39.21	3	Horizontal	52	2.90	-	38.66	8.60	31.48
AV	10.6383G	41.74	54.00	-12.26	25.97	3	Horizontal	52	2.90	-	38.65	8.60	31.48
PK	15.9561G	57.46	74.00	-16.54	42.61	3	Horizontal	351	2.98	-	37.53	9.39	32.07
AV	15.95558G	44.22	54.00	-9.78	29.37	3	Horizontal	351	2.98	-	37.53	9.39	32.07

802.11ac VHT20_Nss1,(MCS0)_1TX

23/03/2020

5500MHz_TX

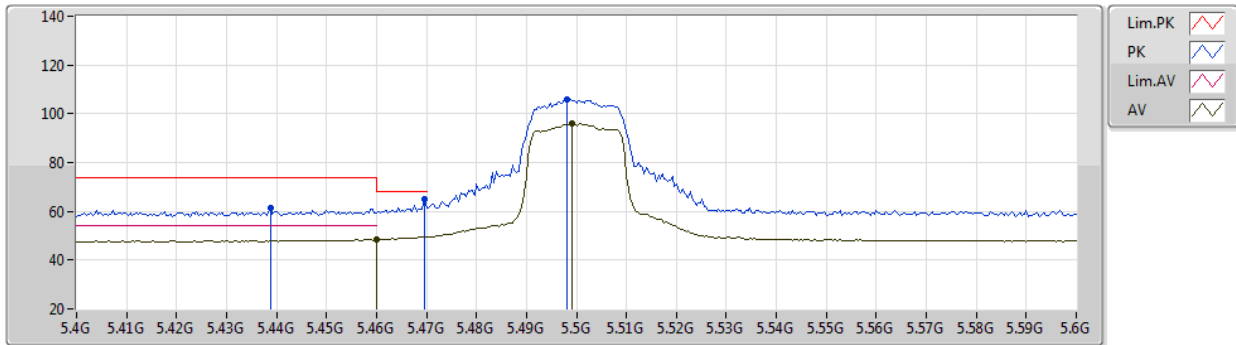

EUT X_1TX
Setting 16
02-D-J-7-10

Type	Freq (Hz)	Level (dBuV/m)	Limit (dBuV/m)	Margin (dB)	Raw (dBuV)	Dist (m)	Condition	Azimuth (°)	Height (m)	Comment	AF (dB)	CL (dB)	PA (dB)
PK	5.4388G	61.22	74.00	-12.78	51.67	3	Vertical	13	2.20	-	33.90	6.14	30.49
PK	5.4696G	65.02	68.20	-3.18	55.44	3	Vertical	13	2.20	-	33.90	6.18	30.50
AV	5.46G	48.45	54.00	-5.55	38.87	3	Vertical	13	2.20	-	33.90	6.17	30.49
PK	5.498G	105.88	Inf	-Inf	96.28	3	Vertical	13	2.20	-	33.90	6.21	30.51
AV	5.4992G	96.15	Inf	-Inf	86.55	3	Vertical	13	2.20	-	33.90	6.21	30.51

802.11ac VHT20_Nss1,(MCS0)_1TX

23/03/2020

5500MHz_TX

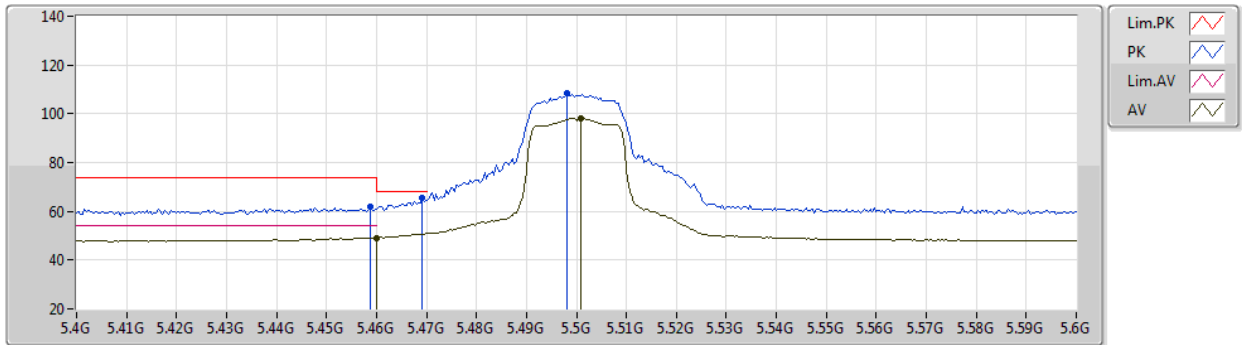

EUT X_1TX
Setting 16
02-D-J-7-10

Type	Freq (Hz)	Level (dBuV/m)	Limit (dBuV/m)	Margin (dB)	Raw (dBuV)	Dist (m)	Condition	Azimuth (°)	Height (m)	Comment	AF (dB)	CL (dB)	PA (dB)
PK	5.4588G	61.77	74.00	-12.23	52.20	3	Horizontal	354	1.93	-	33.90	6.16	30.49
AV	5.46G	49.03	54.00	-4.97	39.45	3	Horizontal	354	1.93	-	33.90	6.17	30.49
PK	5.4692G	65.38	68.20	-2.82	55.80	3	Horizontal	354	1.93	-	33.90	6.18	30.50
PK	5.498G	108.32	Inf	-Inf	98.72	3	Horizontal	354	1.93	-	33.90	6.21	30.51
AV	5.5008G	98.15	Inf	-Inf	88.55	3	Horizontal	354	1.93	-	33.90	6.21	30.51

802.11ac VHT20_Nss1,(MCS0)_1TX

23/03/2020

5500MHz_TX

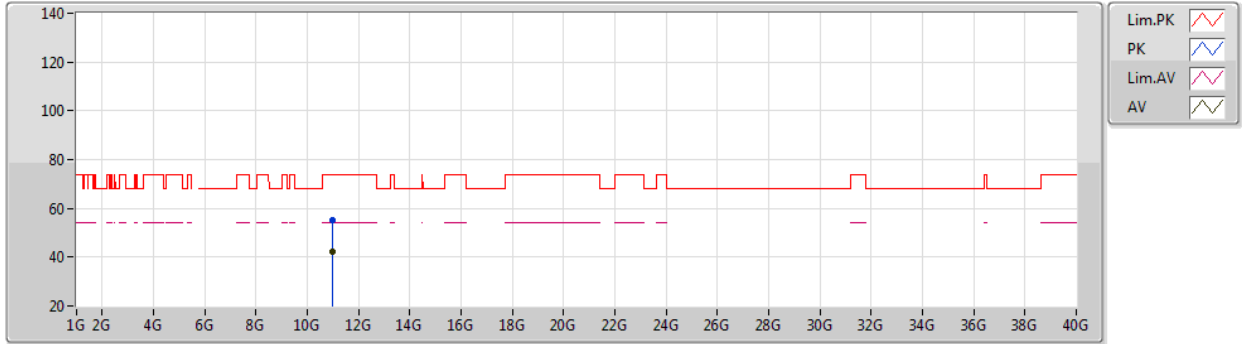

EUT X_1TX
Setting 16
02-D-B-2

Type	Freq (Hz)	Level (dBuV/m)	Limit (dBuV/m)	Margin (dB)	Raw (dBuV)	Dist (m)	Condition	Azimuth (°)	Height (m)	Comment	AF (dB)	CL (dB)	PA (dB)
PK	10.99518G	55.21	74.00	-18.79	39.55	3	Vertical	138	1.32	-	38.40	8.71	31.45
AV	10.99884G	42.00	54.00	-12.00	26.34	3	Vertical	138	1.32	-	38.40	8.71	31.45

802.11ac VHT20_Nss1,(MCS0)_1TX

23/03/2020

5500MHz_TX

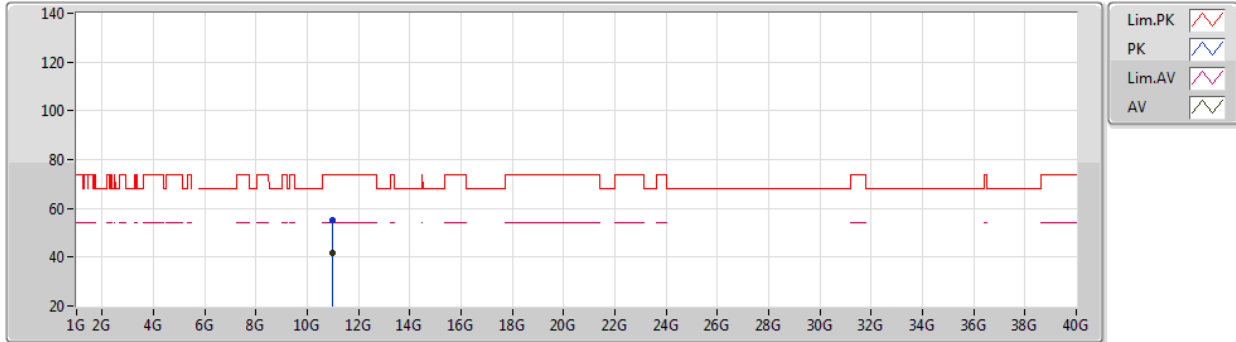

EUT X_1TX
Setting 16
02-D-B-2

Type	Freq (Hz)	Level (dBuV/m)	Limit (dBuV/m)	Margin (dB)	Raw (dBuV)	Dist (m)	Condition	Azimuth (°)	Height (m)	Comment	AF (dB)	CL (dB)	PA (dB)
PK	10.99512G	55.39	74.00	-18.61	39.73	3	Horizontal	241	1.06	-	38.40	8.71	31.45
AV	10.99876G	41.77	54.00	-12.23	26.11	3	Horizontal	241	1.06	-	38.40	8.71	31.45

802.11ac VHT20_Nss1,(MCS0)_1TX

23/03/2020

5580MHz_TX

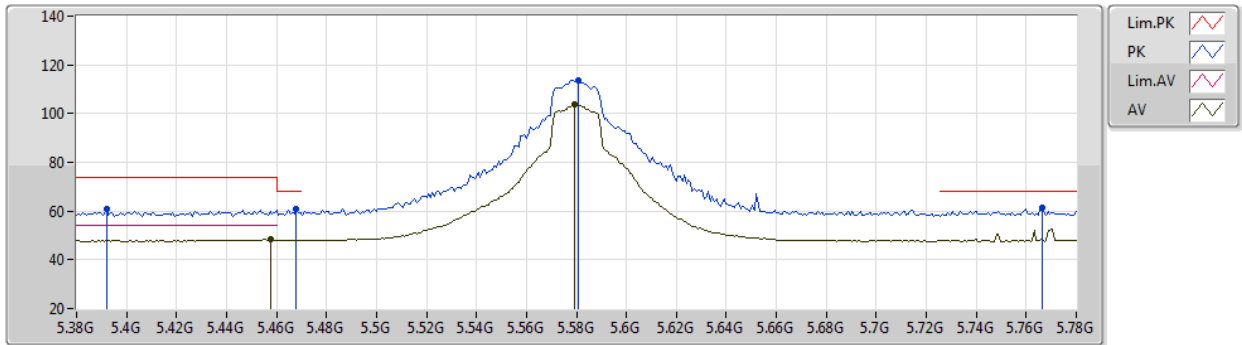

EUT X_1TX
Setting 24
02-D-J-7-10

Type	Freq (Hz)	Level (dBuV/m)	Limit (dBuV/m)	Margin (dB)	Raw (dBuV)	Dist (m)	Condition	Azimuth (°)	Height (m)	Comment	AF (dB)	CL (dB)	PA (dB)
PK	5.392G	61.04	74.00	-12.96	51.52	3	Vertical	331	1.00	-	33.89	6.10	30.47
PK	5.468G	60.90	68.20	-7.30	51.33	3	Vertical	331	1.00	-	33.90	6.17	30.50
AV	5.4576G	48.21	54.00	-5.79	38.64	3	Vertical	331	1.00	-	33.90	6.16	30.49
PK	5.5808G	113.70	Inf	-Inf	103.97	3	Vertical	331	1.00	-	33.98	6.28	30.53
AV	5.5792G	103.60	Inf	-Inf	93.87	3	Vertical	331	1.00	-	33.98	6.28	30.53
PK	5.7664G	61.54	68.20	-6.66	51.93	3	Vertical	331	1.00	-	33.80	6.38	30.57

802.11ac VHT20_Nss1,(MCS0)_1TX

23/03/2020

5580MHz_TX

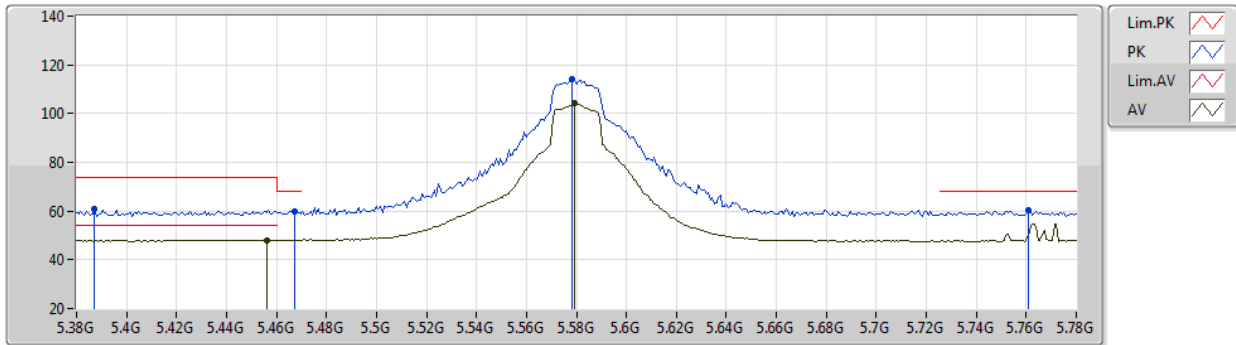

EUT X_1TX
Setting 24
02-D-J-7-10

Type	Freq (Hz)	Level (dBuV/m)	Limit (dBuV/m)	Margin (dB)	Raw (dBuV)	Dist (m)	Condition	Azimuth (°)	Height (m)	Comment	AF (dB)	CL (dB)	PA (dB)
PK	5.3872G	60.73	74.00	-13.27	51.22	3	Horizontal	352	2.00	-	33.89	6.09	30.47
PK	5.4672G	59.88	68.20	-8.32	50.31	3	Horizontal	352	2.00	-	33.90	6.17	30.50
AV	5.456G	48.15	54.00	-5.85	38.58	3	Horizontal	352	2.00	-	33.90	6.16	30.49
PK	5.5784G	114.26	Inf	-Inf	104.53	3	Horizontal	352	2.00	-	33.98	6.28	30.53
AV	5.5792G	104.07	Inf	-Inf	94.34	3	Horizontal	352	2.00	-	33.98	6.28	30.53
PK	5.7608G	60.09	68.20	-8.11	50.48	3	Horizontal	352	2.00	-	33.80	6.38	30.57

802.11ac VHT20_Nss1,(MCS0)_1TX

23/03/2020

5580MHz_TX

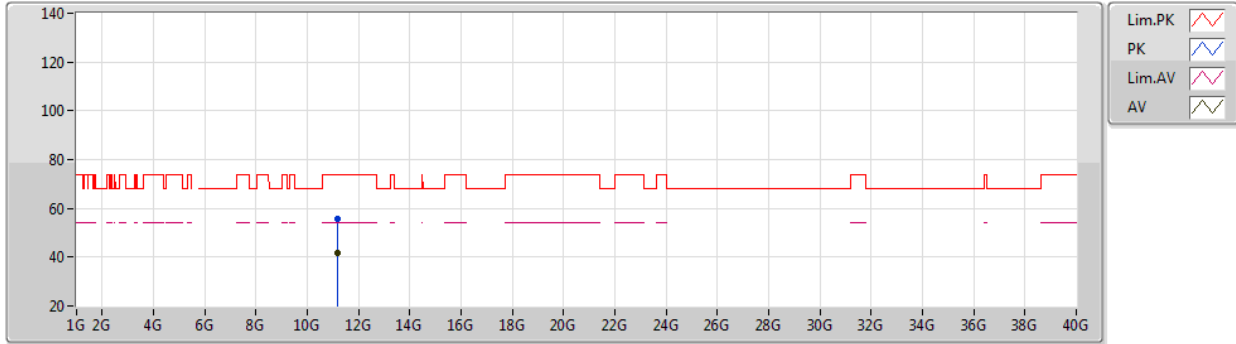

EUT X_1TX
Setting 24
02-D-B-2

Type	Freq (Hz)	Level (dBuV/m)	Limit (dBuV/m)	Margin (dB)	Raw (dBuV)	Dist (m)	Condition	Azimuth (°)	Height (m)	Comment	AF (dB)	CL (dB)	PA (dB)
PK	11.16286G	55.90	74.00	-18.10	40.11	3	Vertical	66	2.87	-	38.53	8.76	31.50
AV	11.16198G	41.93	54.00	-12.07	26.14	3	Vertical	66	2.87	-	38.53	8.76	31.50

802.11ac VHT20_Nss1,(MCS0)_1TX

23/03/2020

5580MHz_TX

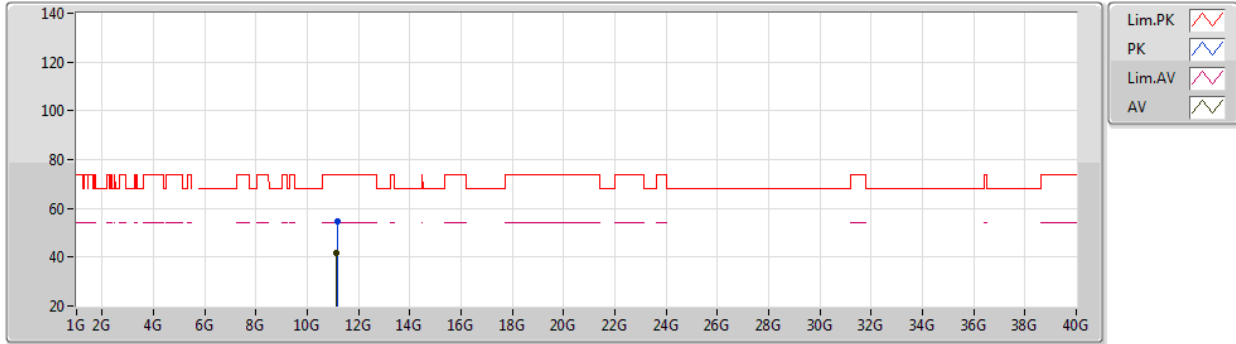

EUT X_1TX
Setting 24
02-D-B-2

Type	Freq (Hz)	Level (dBuV/m)	Limit (dBuV/m)	Margin (dB)	Raw (dBuV)	Dist (m)	Condition	Azimuth (°)	Height (m)	Comment	AF (dB)	CL (dB)	PA (dB)
PK	11.16492G	54.85	74.00	-19.15	39.06	3	Horizontal	161	1.36	-	38.53	8.76	31.50
AV	11.1556G	41.76	54.00	-12.24	25.98	3	Horizontal	161	1.36	-	38.52	8.76	31.50

802.11ac VHT20_Nss1,(MCS0)_1TX

23/03/2020

5700MHz_TX

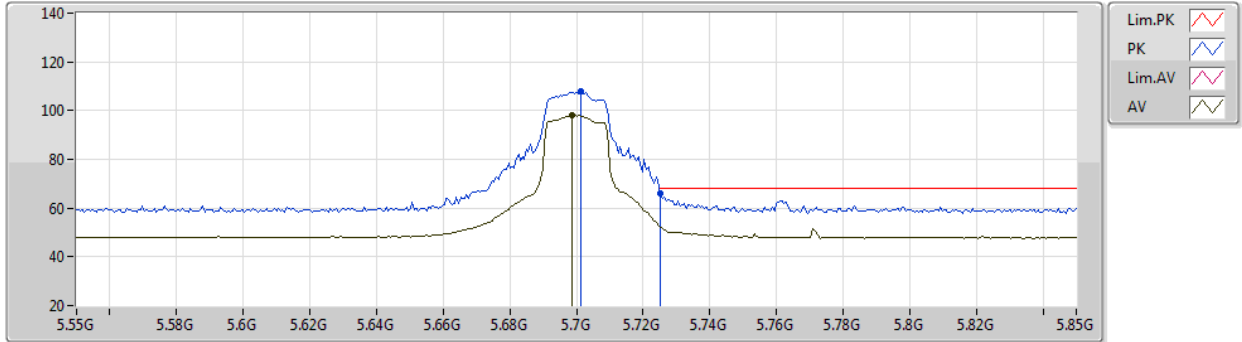

EUT X_1TX
Setting 19
02-D-J-7-10

Type	Freq (Hz)	Level (dBuV/m)	Limit (dBuV/m)	Margin (dB)	Raw (dBuV)	Dist (m)	Condition	Azimuth (°)	Height (m)	Comment	AF (dB)	CL (dB)	PA (dB)
PK	5.7012G	107.98	Inf	-Inf	98.39	3	Vertical	343	2.09	-	33.80	6.35	30.56
AV	5.6988G	98.26	Inf	-Inf	88.67	3	Vertical	343	2.09	-	33.80	6.35	30.56
PK	5.7252G	66.05	68.20	-2.15	56.46	3	Vertical	343	2.09	-	33.80	6.36	30.57

802.11ac VHT20_Nss1,(MCS0)_1TX

23/03/2020

5700MHz_TX

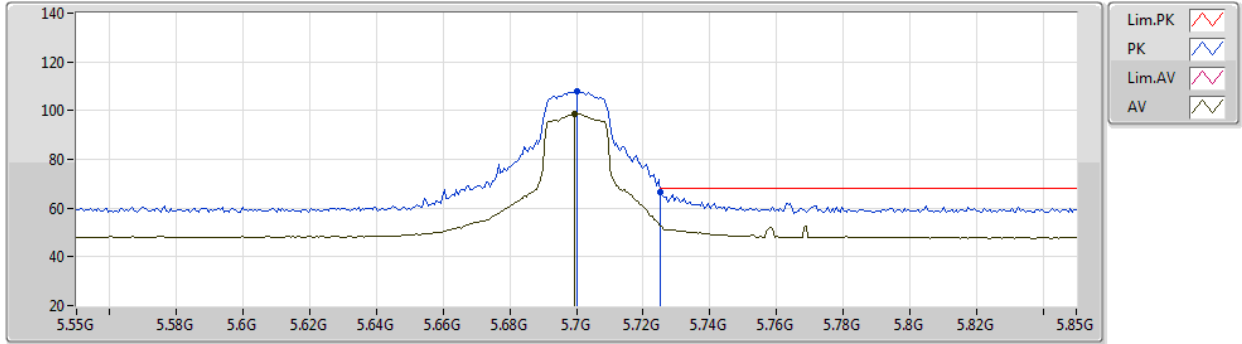

EUT X_1TX
Setting 19
02-D-J-7-10

Type	Freq (Hz)	Level (dBuV/m)	Limit (dBuV/m)	Margin (dB)	Raw (dBuV)	Dist (m)	Condition	Azimuth (°)	Height (m)	Comment	AF (dB)	CL (dB)	PA (dB)
PK	5.7G	108.03	Inf	-Inf	98.44	3	Horizontal	32	1.00	-	33.80	6.35	30.56
AV	5.6994G	98.71	Inf	-Inf	89.12	3	Horizontal	32	1.00	-	33.80	6.35	30.56
PK	5.7252G	66.67	68.20	-1.53	57.08	3	Horizontal	32	1.00	-	33.80	6.36	30.57

802.11ac VHT20_Nss1,(MCS0)_1TX

23/03/2020

5700MHz_TX

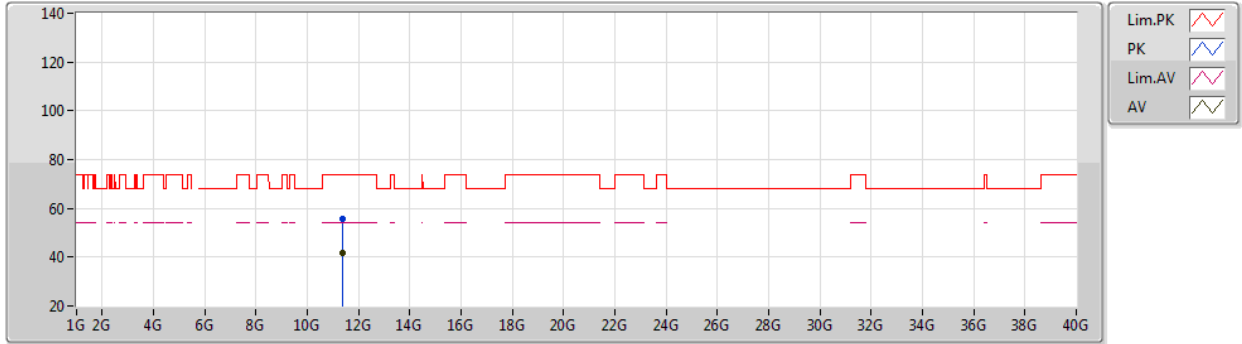

EUT X_1TX
Setting 19
02-D-B-2

Type	Freq (Hz)	Level (dBuV/m)	Limit (dBuV/m)	Margin (dB)	Raw (dBuV)	Dist (m)	Condition	Azimuth (°)	Height (m)	Comment	AF (dB)	CL (dB)	PA (dB)
PK	11.39856G	55.45	74.00	-18.55	39.47	3	Vertical	278	1.68	-	38.72	8.83	31.57
AV	11.40076G	41.95	54.00	-12.05	25.97	3	Vertical	278	1.68	-	38.72	8.83	31.57

802.11ac VHT20_Nss1,(MCS0)_1TX

23/03/2020

5700MHz_TX

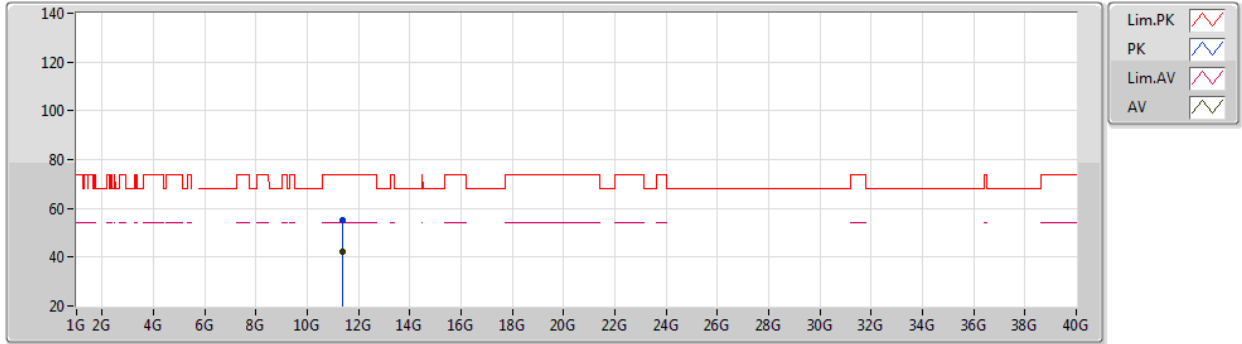

EUT X_1TX
Setting 19
02-D-B-2

Type	Freq (Hz)	Level (dBuV/m)	Limit (dBuV/m)	Margin (dB)	Raw (dBuV)	Dist (m)	Condition	Azimuth (°)	Height (m)	Comment	AF (dB)	CL (dB)	PA (dB)
PK	11.39672G	55.03	74.00	-18.97	39.05	3	Horizontal	25	1.61	-	38.72	8.83	31.57
AV	11.39786G	42.04	54.00	-11.96	26.06	3	Horizontal	25	1.61	-	38.72	8.83	31.57

802.11ac VHT20_Nss1,(MCS0)_1TX

23/03/2020

5745MHz_TX

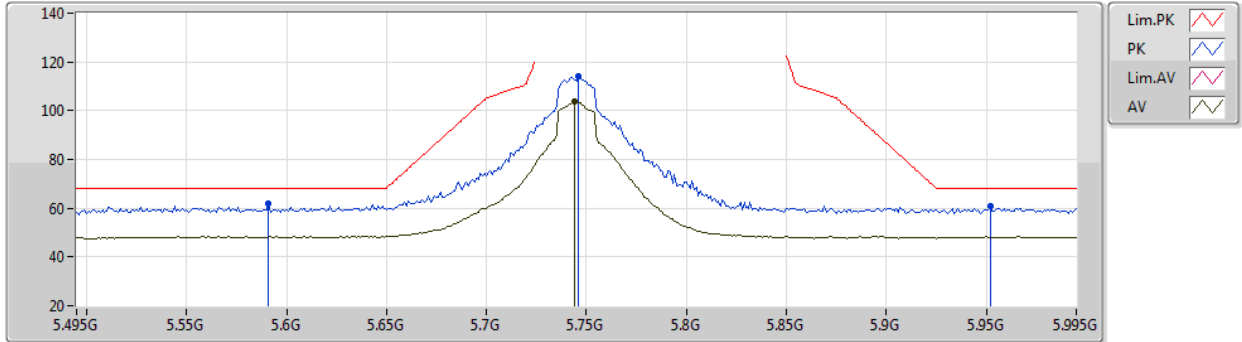

EUT X_1TX
Setting 24
02-D-J-7-10

Type	Freq (Hz)	Level (dBuV/m)	Limit (dBuV/m)	Margin (dB)	Raw (dBuV)	Dist (m)	Condition	Azimuth (°)	Height (m)	Comment	AF (dB)	CL (dB)	PA (dB)
PK	5.591G	61.76	68.20	-6.44	52.01	3	Vertical	344	2.05	-	33.99	6.29	30.53
PK	5.746G	114.23	Inf	-Inf	104.63	3	Vertical	344	2.05	-	33.80	6.37	30.57
AV	5.744G	103.88	Inf	-Inf	94.28	3	Vertical	344	2.05	-	33.80	6.37	30.57
PK	5.952G	60.69	68.20	-7.51	50.89	3	Vertical	344	2.05	-	34.10	6.32	30.62

802.11ac VHT20_Nss1,(MCS0)_1TX

23/03/2020

5745MHz_TX

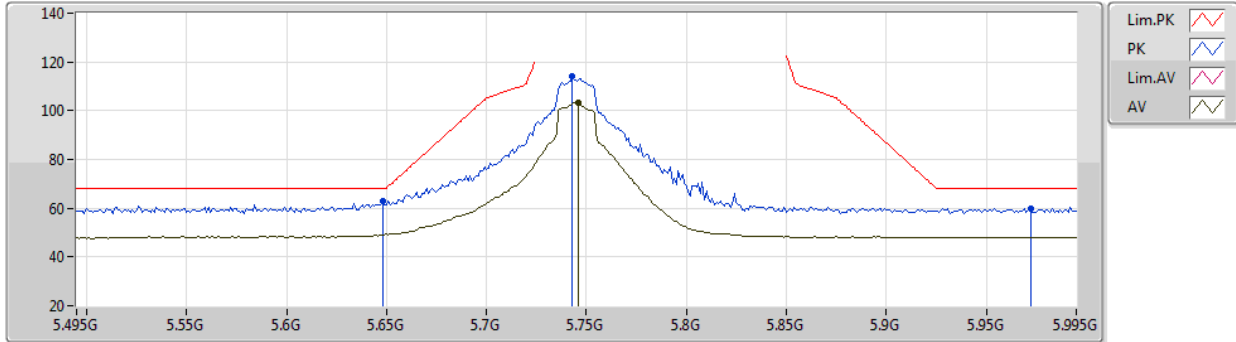

EUT X_1TX
Setting 24
02-D-J-7-10

Type	Freq (Hz)	Level (dBuV/m)	Limit (dBuV/m)	Margin (dB)	Raw (dBuV)	Dist (m)	Condition	Azimuth (°)	Height (m)	Comment	AF (dB)	CL (dB)	PA (dB)
PK	5.648G	62.73	68.20	-5.47	53.05	3	Horizontal	32	1.01	-	33.90	6.32	30.54
PK	5.743G	113.92	Inf	-Inf	104.32	3	Horizontal	32	1.01	-	33.80	6.37	30.57
AV	5.746G	103.12	Inf	-Inf	93.52	3	Horizontal	32	1.01	-	33.80	6.37	30.57
PK	5.972G	59.87	68.20	-8.33	50.04	3	Horizontal	32	1.01	-	34.14	6.31	30.62

802.11ac VHT20_Nss1,(MCS0)_1TX

23/03/2020

5745MHz_TX

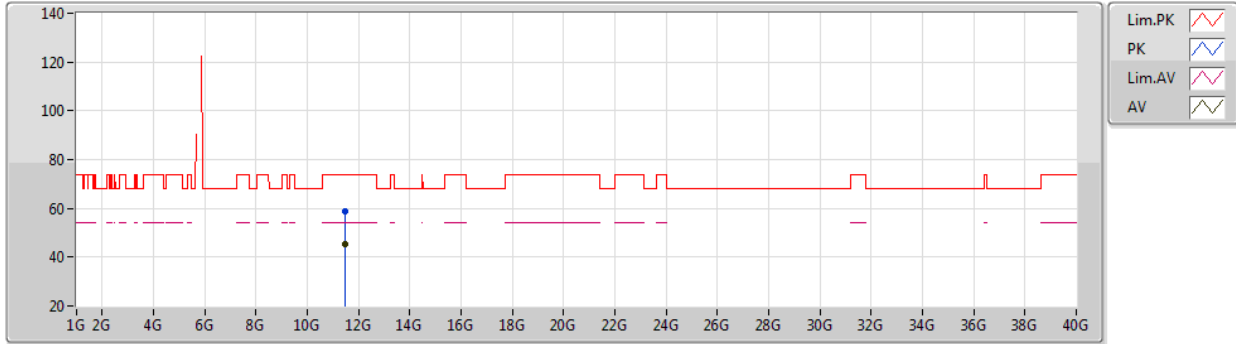

EUT X_1TX
Setting 24
02-D-B-2

Type	Freq (Hz)	Level (dBuV/m)	Limit (dBuV/m)	Margin (dB)	Raw (dBuV)	Dist (m)	Condition	Azimuth (°)	Height (m)	Comment	AF (dB)	CL (dB)	PA (dB)
PK	11.49168G	58.96	74.00	-15.04	42.92	3	Vertical	350	1.80	-	38.79	8.85	31.60
AV	11.4898G	45.20	54.00	-8.80	29.16	3	Vertical	350	1.80	-	38.79	8.85	31.60

802.11ac VHT20_Nss1,(MCS0)_1TX

23/03/2020

5745MHz_TX

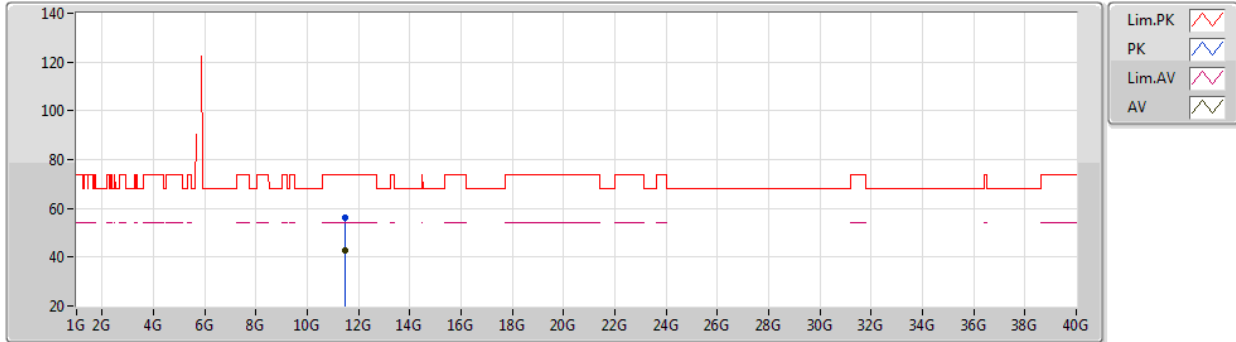

EUT X_1TX
Setting 24
02-D-B-2

Type	Freq (Hz)	Level (dBuV/m)	Limit (dBuV/m)	Margin (dB)	Raw (dBuV)	Dist (m)	Condition	Azimuth (°)	Height (m)	Comment	AF (dB)	CL (dB)	PA (dB)
PK	11.49326G	56.23	74.00	-17.77	40.19	3	Horizontal	23	1.80	-	38.79	8.85	31.60
AV	11.49294G	42.89	54.00	-11.11	26.85	3	Horizontal	23	1.80	-	38.79	8.85	31.60

802.11ac VHT20_Nss1,(MCS0)_1TX

23/03/2020

5785MHz_TX

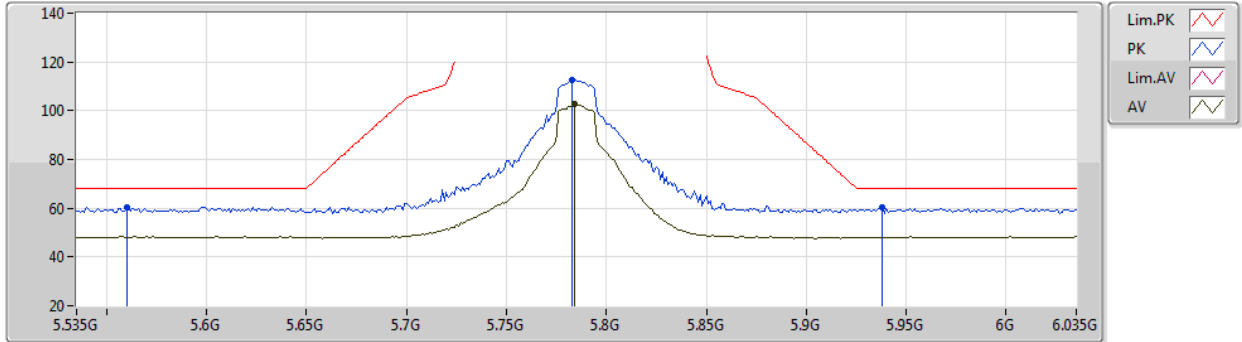

EUT X_1TX
Setting 24
02-D-J-7-10

Type	Freq (Hz)	Level (dBuV/m)	Limit (dBuV/m)	Margin (dB)	Raw (dBuV)	Dist (m)	Condition	Azimuth (°)	Height (m)	Comment	AF (dB)	CL (dB)	PA (dB)
PK	5.56G	60.38	68.20	-7.82	50.68	3	Vertical	350	2.03	-	33.96	6.26	30.52
PK	5.783G	112.51	Inf	-Inf	102.90	3	Vertical	350	2.03	-	33.80	6.39	30.58
AV	5.784G	102.70	Inf	-Inf	93.09	3	Vertical	350	2.03	-	33.80	6.39	30.58
PK	5.938G	60.30	68.20	-7.90	50.51	3	Vertical	350	2.03	-	34.08	6.33	30.62

802.11ac VHT20_Nss1,(MCS0)_1TX

23/03/2020

5785MHz_TX

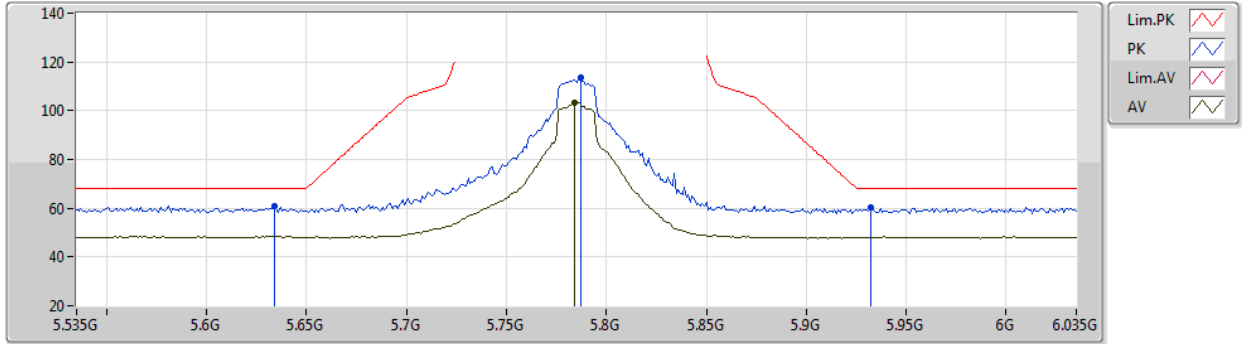

EUT X_1TX
Setting 24
02-D-J-7-10

Type	Freq (Hz)	Level (dBuV/m)	Limit (dBuV/m)	Margin (dB)	Raw (dBuV)	Dist (m)	Condition	Azimuth (°)	Height (m)	Comment	AF (dB)	CL (dB)	PA (dB)
PK	5.634G	60.90	68.20	-7.30	51.19	3	Horizontal	33	1.01	-	33.93	6.32	30.54
PK	5.787G	113.59	Inf	-Inf	103.98	3	Horizontal	33	1.01	-	33.80	6.39	30.58
AV	5.784G	103.35	Inf	-Inf	93.74	3	Horizontal	33	1.01	-	33.80	6.39	30.58
PK	5.932G	60.26	68.20	-7.94	50.49	3	Horizontal	33	1.01	-	34.06	6.33	30.62

802.11ac VHT20_Nss1,(MCS0)_1TX

23/03/2020

5785MHz_TX

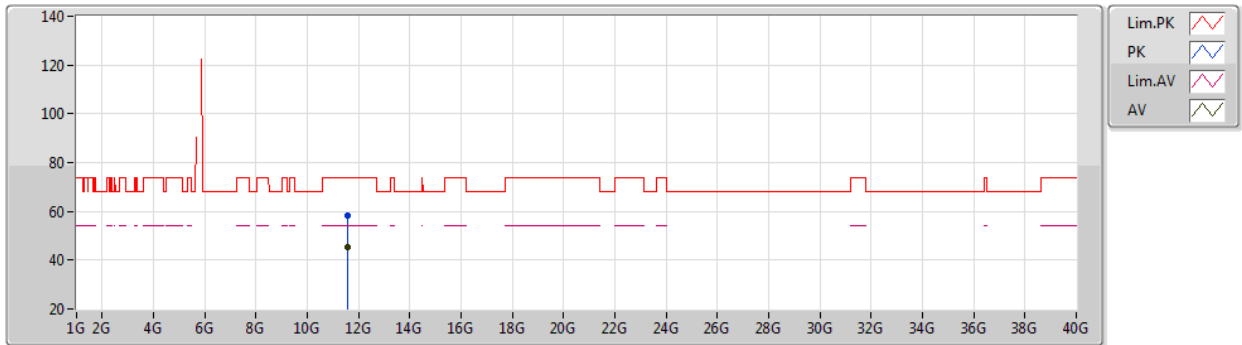

EUT X_1TX
Setting 24
02-D-J-7

Type	Freq (Hz)	Level (dBuV/m)	Limit (dBuV/m)	Margin (dB)	Raw (dBuV)	Dist (m)	Condition	Azimuth (°)	Height (m)	Comment	AF (dB)	CL (dB)	PA (dB)
PK	11.5689G	58.42	74.00	-15.58	42.32	3	Vertical	348	1.69	-	38.86	8.87	31.63
AV	11.5703G	45.30	54.00	-8.70	29.19	3	Vertical	348	1.69	-	38.86	8.88	31.63

802.11ac VHT20_Nss1,(MCS0)_1TX

23/03/2020

5785MHz_TX

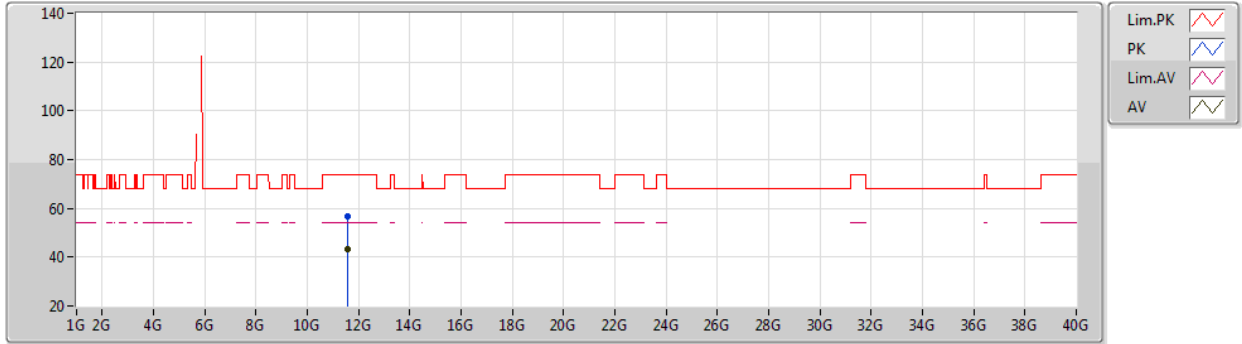

EUT X_1TX
Setting 24
02-D-J-7

Type	Freq (Hz)	Level (dBuV/m)	Limit (dBuV/m)	Margin (dB)	Raw (dBuV)	Dist (m)	Condition	Azimuth (°)	Height (m)	Comment	AF (dB)	CL (dB)	PA (dB)
PK	11.57288G	56.66	74.00	-17.34	40.55	3	Horizontal	28	1.80	-	38.86	8.88	31.63
AV	11.56916G	43.38	54.00	-10.62	27.27	3	Horizontal	28	1.80	-	38.86	8.88	31.63

802.11ac VHT20_Nss1,(MCS0)_1TX

23/03/2020

5825MHz_TX

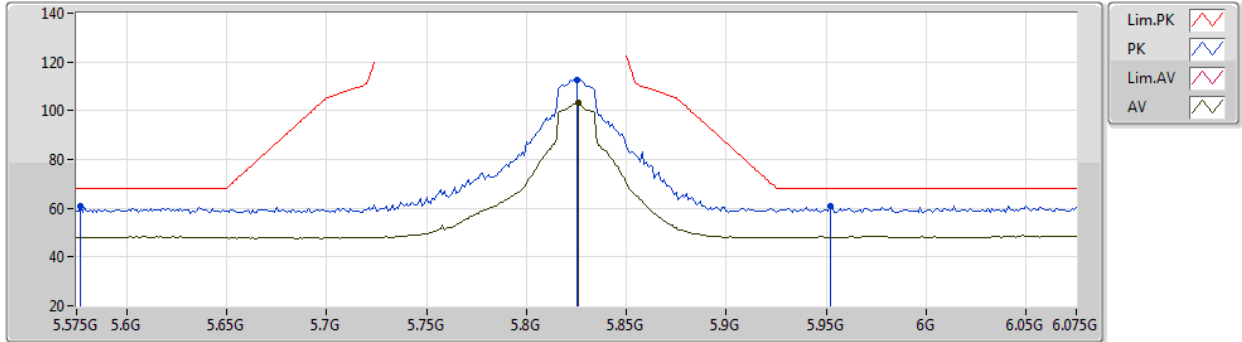

EUT X_1TX
Setting 24
02-D-J-7-10

Type	Freq (Hz)	Level (dBuV/m)	Limit (dBuV/m)	Margin (dB)	Raw (dBuV)	Dist (m)	Condition	Azimuth (°)	Height (m)	Comment	AF (dB)	CL (dB)	PA (dB)
PK	5.577G	60.61	68.20	-7.59	50.88	3	Vertical	342	1.93	-	33.98	6.28	30.53
PK	5.825G	112.82	Inf	-Inf	103.17	3	Vertical	342	1.93	-	33.85	6.39	30.59
AV	5.826G	103.10	Inf	-Inf	93.45	3	Vertical	342	1.93	-	33.85	6.39	30.59
PK	5.952G	61.08	68.20	-7.12	51.28	3	Vertical	342	1.93	-	34.10	6.32	30.62

802.11ac VHT20_Nss1,(MCS0)_1TX

23/03/2020

5825MHz_TX

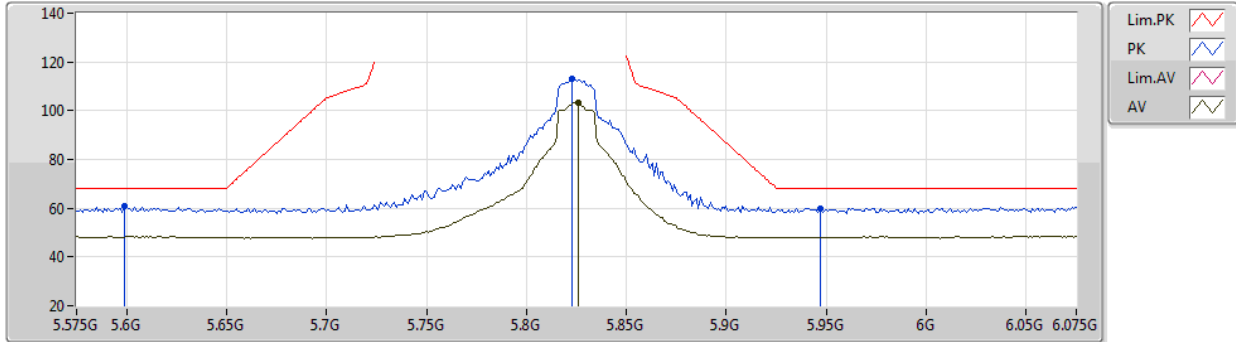

EUT X_1TX
Setting 24
02-D-J-7-10

Type	Freq (Hz)	Level (dBuV/m)	Limit (dBuV/m)	Margin (dB)	Raw (dBuV)	Dist (m)	Condition	Azimuth (°)	Height (m)	Comment	AF (dB)	CL (dB)	PA (dB)
PK	5.599G	60.62	68.20	-7.58	50.85	3	Horizontal	30	1.00	-	34.00	6.30	30.53
PK	5.823G	113.11	Inf	-Inf	103.46	3	Horizontal	30	1.00	-	33.85	6.39	30.59
AV	5.826G	103.20	Inf	-Inf	93.55	3	Horizontal	30	1.00	-	33.85	6.39	30.59
PK	5.947G	60.07	68.20	-8.13	50.27	3	Horizontal	30	1.00	-	34.09	6.33	30.62

802.11ac VHT20_Nss1,(MCS0)_1TX

23/03/2020

5825MHz_TX

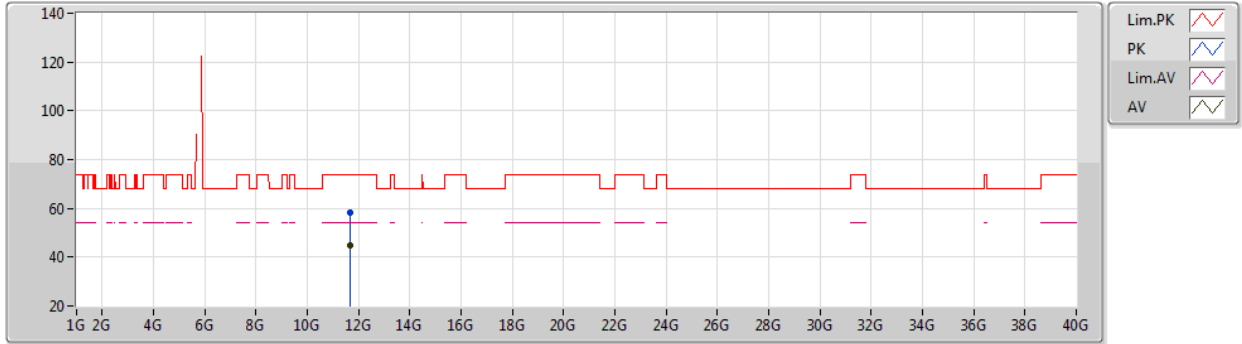

EUT X_1TX
Setting 24
02-D-B-2

Type	Freq (Hz)	Level (dBuV/m)	Limit (dBuV/m)	Margin (dB)	Raw (dBuV)	Dist (m)	Condition	Azimuth (°)	Height (m)	Comment	AF (dB)	CL (dB)	PA (dB)
PK	11.6491G	58.40	74.00	-15.60	42.23	3	Vertical	353	2.66	-	38.92	8.90	31.65
AV	11.64832G	44.62	54.00	-9.38	28.45	3	Vertical	353	2.66	-	38.92	8.90	31.65

802.11ac VHT20_Nss1,(MCS0)_1TX

23/03/2020

5825MHz_TX

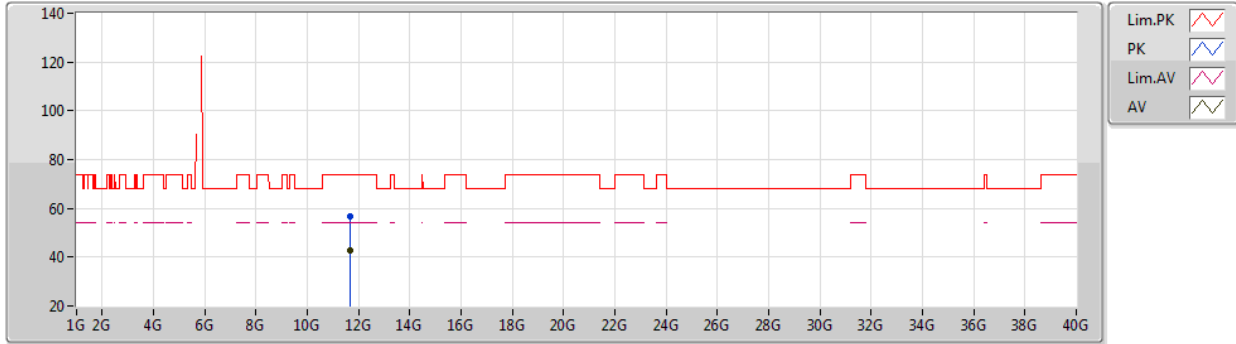

EUT X_1TX
Setting 24
02-D-B-2

Type	Freq (Hz)	Level (dBuV/m)	Limit (dBuV/m)	Margin (dB)	Raw (dBuV)	Dist (m)	Condition	Azimuth (°)	Height (m)	Comment	AF (dB)	CL (dB)	PA (dB)
PK	11.6522G	56.66	74.00	-17.34	40.49	3	Horizontal	20	2.23	-	38.92	8.90	31.65
AV	11.65106G	42.93	54.00	-11.07	26.76	3	Horizontal	20	2.23	-	38.92	8.90	31.65

802.11ac VHT40_Nss1,(MCS0)_1TX

23/03/2020

5190MHz_TX

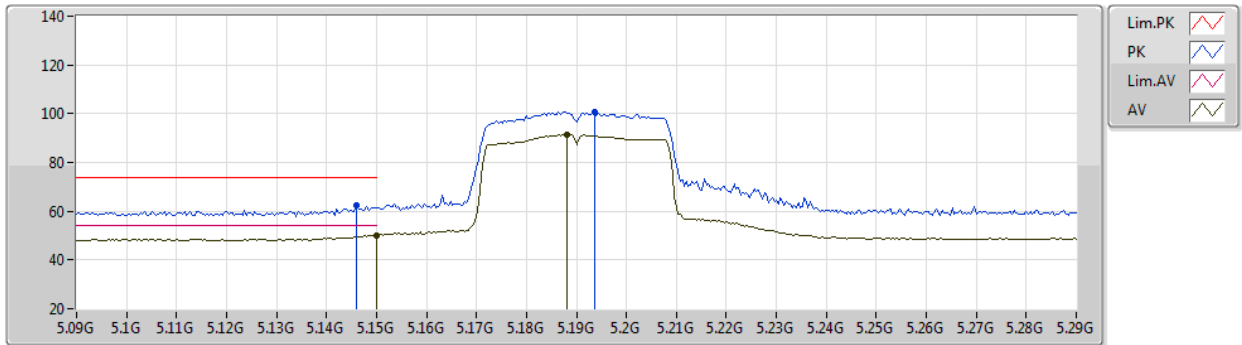

EUT X_1TX
Setting 13
02-D-B-2-10

Type	Freq (Hz)	Level (dBuV/m)	Limit (dBuV/m)	Margin (dB)	Raw (dBuV)	Dist (m)	Condition	Azimuth (°)	Height (m)	Comment	AF (dB)	CL (dB)	PA (dB)
PK	5.146G	62.22	74.00	-11.78	53.08	3	Vertical	342	1.03	-	33.55	5.97	30.38
AV	5.15G	50.17	54.00	-3.83	41.03	3	Vertical	342	1.03	-	33.55	5.97	30.38
PK	5.1936G	100.90	Inf	-Inf	91.71	3	Vertical	342	1.03	-	33.59	6.00	30.40
AV	5.188G	91.45	Inf	-Inf	82.27	3	Vertical	342	1.03	-	33.59	5.99	30.40

802.11ac VHT40_Nss1,(MCS0)_1TX

23/03/2020

5190MHz_TX

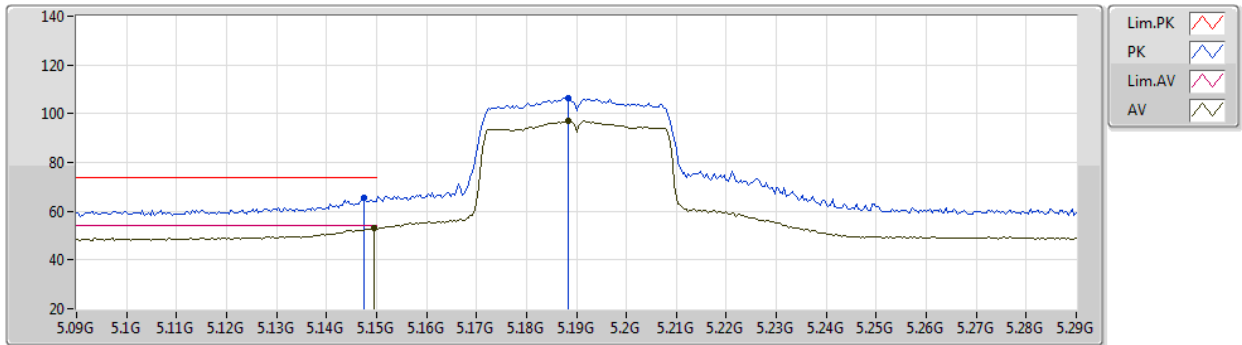

EUT X_1TX
Setting 13
02-D-B-2-10

Type	Freq (Hz)	Level (dBuV/m)	Limit (dBuV/m)	Margin (dB)	Raw (dBuV)	Dist (m)	Condition	Azimuth (°)	Height (m)	Comment	AF (dB)	CL (dB)	PA (dB)
PK	5.1476G	65.66	74.00	-8.34	56.52	3	Horizontal	0	1.01	-	33.55	5.97	30.38
AV	5.1496G	52.94	54.00	-1.06	43.80	3	Horizontal	0	1.01	-	33.55	5.97	30.38
PK	5.1884G	106.51	Inf	-Inf	97.33	3	Horizontal	0	1.01	-	33.59	5.99	30.40
AV	5.1884G	96.91	Inf	-Inf	87.73	3	Horizontal	0	1.01	-	33.59	5.99	30.40

802.11ac VHT40_Nss1,(MCS0)_1TX

23/03/2020

5190MHz_TX

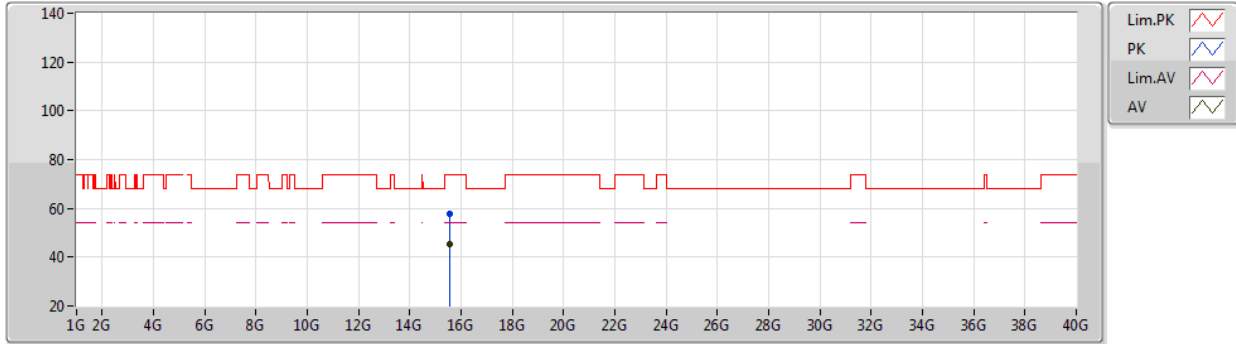

EUT X_1TX
Setting 13
02-D-B-2

Type	Freq (Hz)	Level (dBuV/m)	Limit (dBuV/m)	Margin (dB)	Raw (dBuV)	Dist (m)	Condition	Azimuth (°)	Height (m)	Comment	AF (dB)	CL (dB)	PA (dB)
PK	15.57142G	57.81	74.00	-16.19	41.90	3	Vertical	311	2.13	-	38.64	9.26	31.99
AV	15.57142G	45.42	54.00	-8.58	29.51	3	Vertical	311	2.13	-	38.64	9.26	31.99

802.11ac VHT40_Nss1,(MCS0)_1TX

23/03/2020

5190MHz_TX

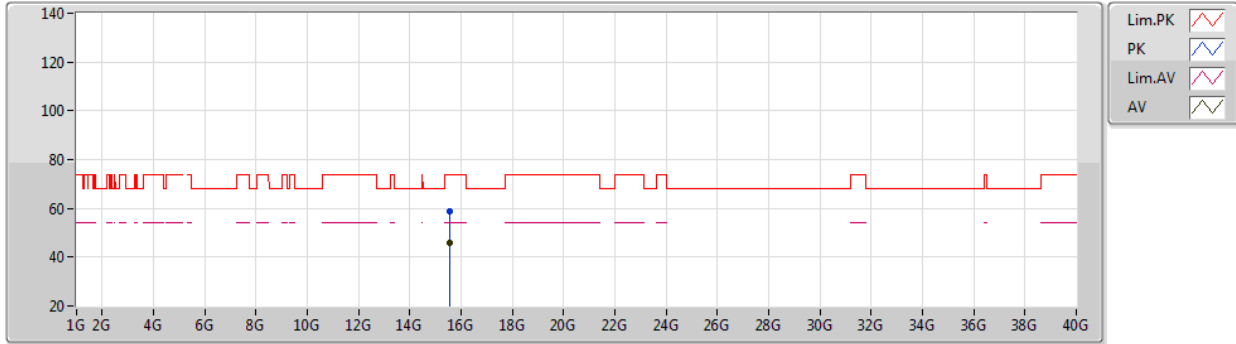

EUT X_1TX
Setting 13
02-D-B-2

Type	Freq (Hz)	Level (dBuV/m)	Limit (dBuV/m)	Margin (dB)	Raw (dBuV)	Dist (m)	Condition	Azimuth (°)	Height (m)	Comment	AF (dB)	CL (dB)	PA (dB)
PK	15.57162G	58.66	74.00	-15.34	42.75	3	Horizontal	74	2.04	-	38.64	9.26	31.99
AV	15.57112G	45.66	54.00	-8.34	29.75	3	Horizontal	74	2.04	-	38.64	9.26	31.99

802.11ac VHT40_Nss1,(MCS0)_1TX

23/03/2020

5230MHz_TX

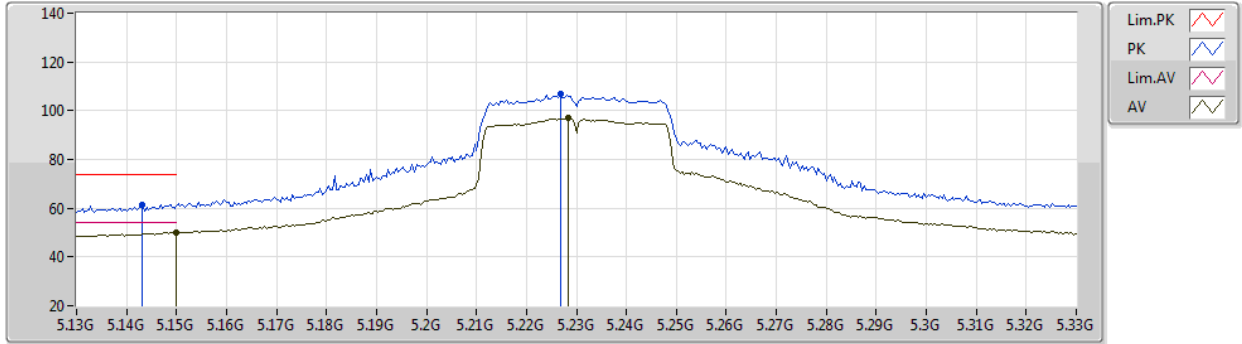

EUT X_1TX
Setting 19
02-D-B-2-10

Type	Freq (Hz)	Level (dBuV/m)	Limit (dBuV/m)	Margin (dB)	Raw (dBuV)	Dist (m)	Condition	Azimuth (°)	Height (m)	Comment	AF (dB)	CL (dB)	PA (dB)
PK	5.1432G	61.32	74.00	-12.68	52.19	3	Vertical	342	1.03	-	33.54	5.97	30.38
AV	5.15G	50.25	54.00	-3.75	41.11	3	Vertical	342	1.03	-	33.55	5.97	30.38
PK	5.2268G	106.66	Inf	-Inf	97.41	3	Vertical	342	1.03	-	33.65	6.01	30.41
AV	5.2284G	97.04	Inf	-Inf	87.78	3	Vertical	342	1.03	-	33.66	6.01	30.41

802.11ac VHT40_Nss1,(MCS0)_1TX

23/03/2020

5230MHz_TX

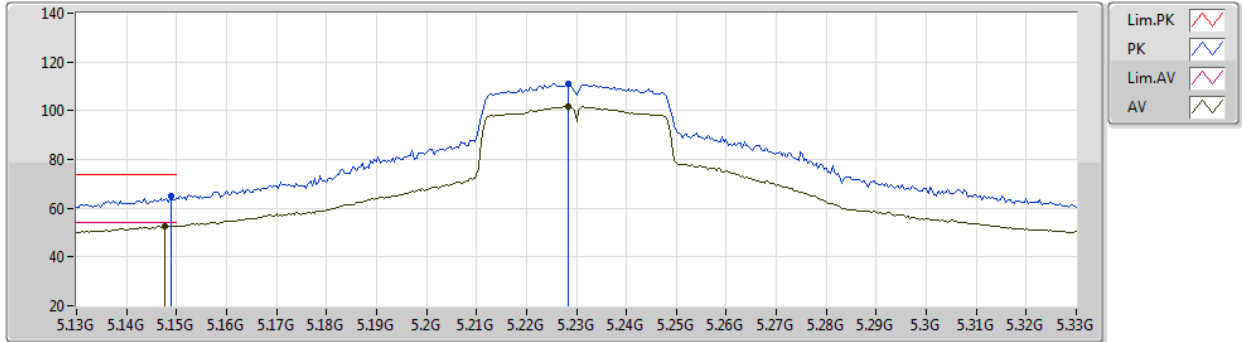

EUT X_1TX
Setting 19
02-D-B-2-10

Type	Freq (Hz)	Level (dBuV/m)	Limit (dBuV/m)	Margin (dB)	Raw (dBuV)	Dist (m)	Condition	Azimuth (°)	Height (m)	Comment	AF (dB)	CL (dB)	PA (dB)
PK	5.1488G	65.02	74.00	-8.98	55.88	3	Horizontal	0	1.01	-	33.55	5.97	30.38
AV	5.1476G	52.82	54.00	-1.18	43.68	3	Horizontal	0	1.01	-	33.55	5.97	30.38
PK	5.2284G	110.99	Inf	-Inf	101.73	3	Horizontal	0	1.01	-	33.66	6.01	30.41
AV	5.2284G	101.85	Inf	-Inf	92.59	3	Horizontal	0	1.01	-	33.66	6.01	30.41

802.11ac VHT40_Nss1,(MCS0)_1TX

23/03/2020

5230MHz_TX

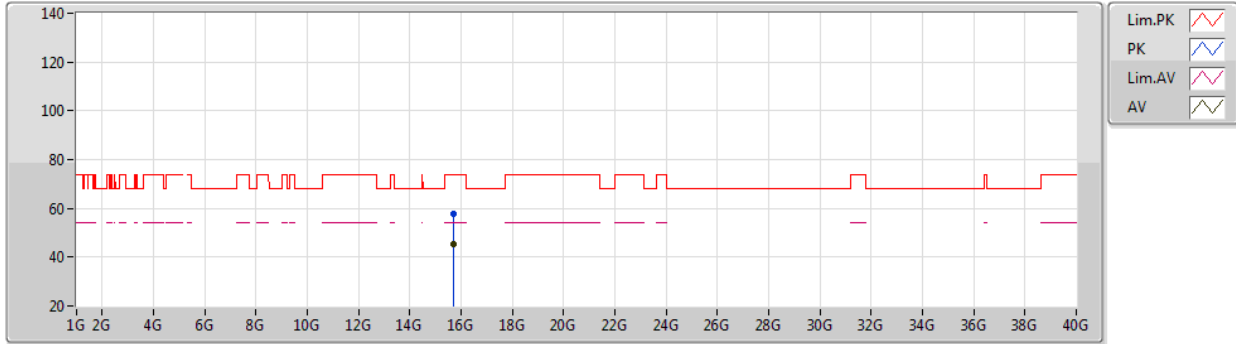

EUT X_1TX
Setting 19
02-D-B-2

Type	Freq (Hz)	Level (dBuV/m)	Limit (dBuV/m)	Margin (dB)	Raw (dBuV)	Dist (m)	Condition	Azimuth (°)	Height (m)	Comment	AF (dB)	CL (dB)	PA (dB)
PK	15.68614G	57.61	74.00	-16.39	42.01	3	Vertical	109	1.97	-	38.31	9.30	32.01
AV	15.69126G	45.54	54.00	-8.46	29.95	3	Vertical	109	1.97	-	38.30	9.30	32.01

802.11ac VHT40_Nss1,(MCS0)_1TX

23/03/2020

5230MHz_TX

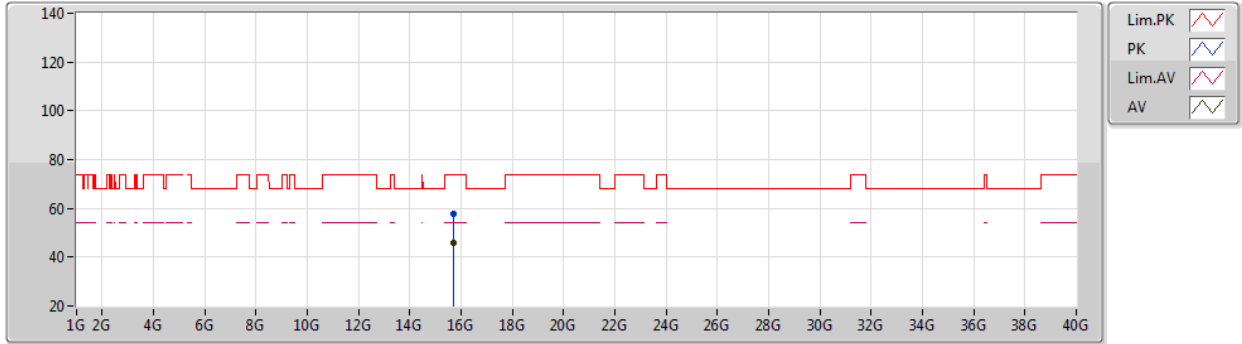

EUT X_1TX
Setting 19
02-D-B-2

Type	Freq (Hz)	Level (dBuV/m)	Limit (dBuV/m)	Margin (dB)	Raw (dBuV)	Dist (m)	Condition	Azimuth (°)	Height (m)	Comment	AF (dB)	CL (dB)	PA (dB)
PK	15.694G	58.01	74.00	-15.99	42.43	3	Horizontal	256	2.75	-	38.29	9.30	32.01
AV	15.68922G	45.68	54.00	-8.32	30.09	3	Horizontal	256	2.75	-	38.30	9.30	32.01

802.11ac VHT40_Nss1,(MCS0)_1TX

23/03/2020

5270MHz_TX

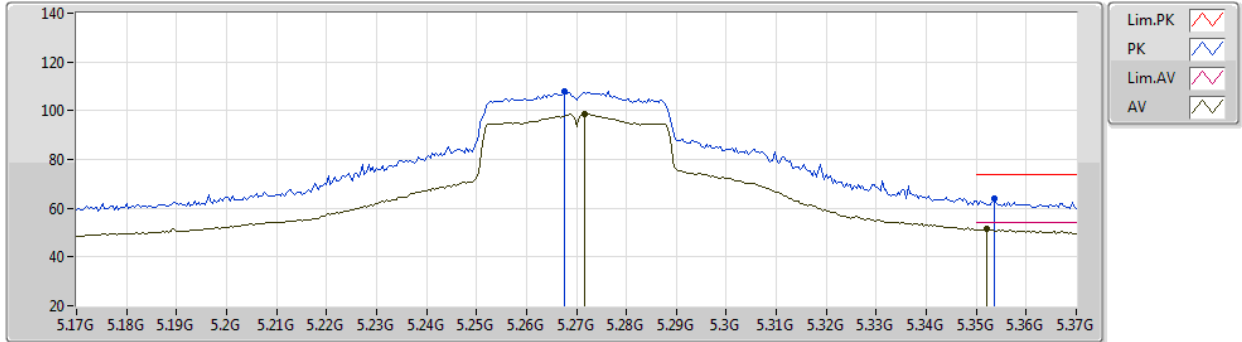

EUT X_1TX
Setting 20
02-D-B-2-10

Type	Freq (Hz)	Level (dBuV/m)	Limit (dBuV/m)	Margin (dB)	Raw (dBuV)	Dist (m)	Condition	Azimuth (°)	Height (m)	Comment	AF (dB)	CL (dB)	PA (dB)
PK	5.2676G	107.96	Inf	-Inf	98.62	3	Vertical	348	1.01	-	33.74	6.03	30.43
AV	5.2716G	98.45	Inf	-Inf	89.10	3	Vertical	348	1.01	-	33.74	6.04	30.43
PK	5.3536G	63.79	74.00	-10.21	54.32	3	Vertical	348	1.01	-	33.85	6.08	30.46
AV	5.352G	51.48	54.00	-2.52	42.01	3	Vertical	348	1.01	-	33.85	6.08	30.46

802.11ac VHT40_Nss1,(MCS0)_1TX

23/03/2020

5270MHz_TX

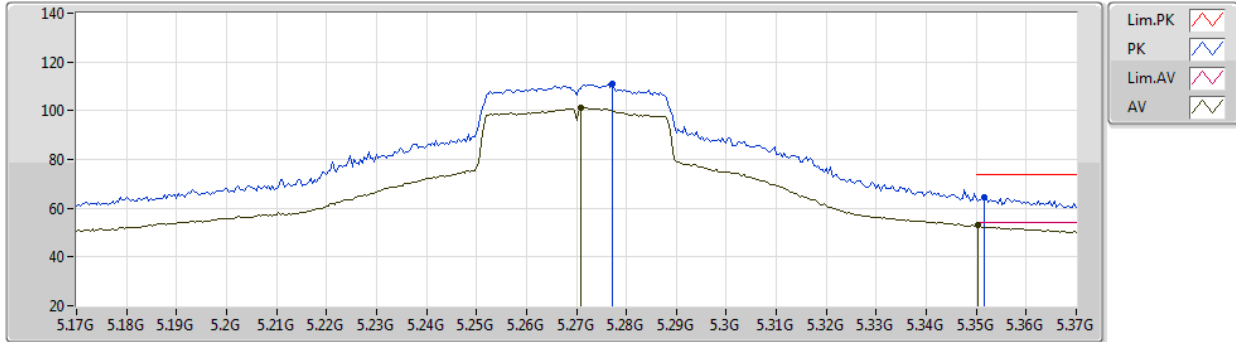

EUT X_1TX
Setting 20
02-D-B-2-10

Type	Freq (Hz)	Level (dBuV/m)	Limit (dBuV/m)	Margin (dB)	Raw (dBuV)	Dist (m)	Condition	Azimuth (°)	Height (m)	Comment	AF (dB)	CL (dB)	PA (dB)
PK	5.2772G	111.28	Inf	-Inf	101.92	3	Horizontal	0	1.01	-	33.75	6.04	30.43
AV	5.2708G	101.26	Inf	-Inf	91.91	3	Horizontal	0	1.01	-	33.74	6.04	30.43
PK	5.3516G	64.46	74.00	-9.54	54.99	3	Horizontal	0	1.01	-	33.85	6.08	30.46
AV	5.3504G	52.86	54.00	-1.14	43.39	3	Horizontal	0	1.01	-	33.85	6.08	30.46

802.11ac VHT40_Nss1,(MCS0)_1TX

23/03/2020

5270MHz_TX

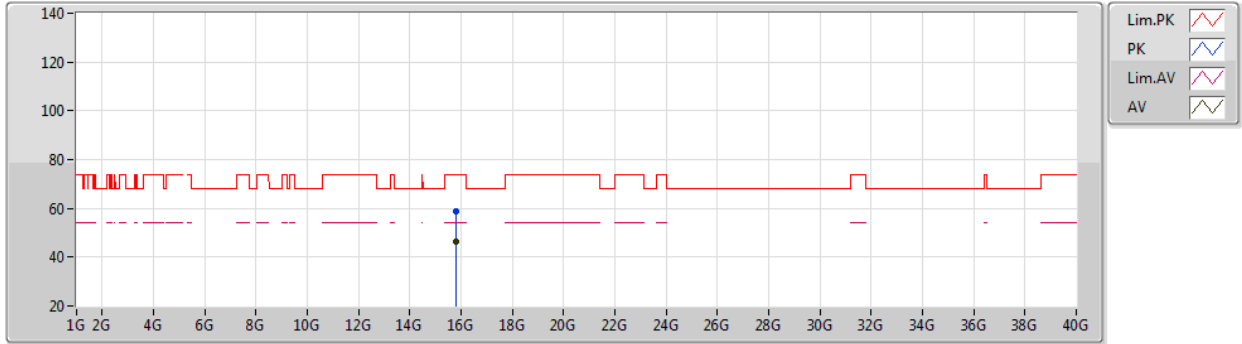

EUT X_1TX
Setting 20
02-D-B-2

Type	Freq (Hz)	Level (dBuV/m)	Limit (dBuV/m)	Margin (dB)	Raw (dBuV)	Dist (m)	Condition	Azimuth (°)	Height (m)	Comment	AF (dB)	CL (dB)	PA (dB)
PK	15.81162G	58.93	74.00	-15.07	43.68	3	Vertical	266	2.95	-	37.95	9.34	32.04
AV	15.81036G	46.19	54.00	-7.81	30.94	3	Vertical	266	2.95	-	37.95	9.34	32.04

802.11ac VHT40_Nss1,(MCS0)_1TX

23/03/2020

5270MHz_TX

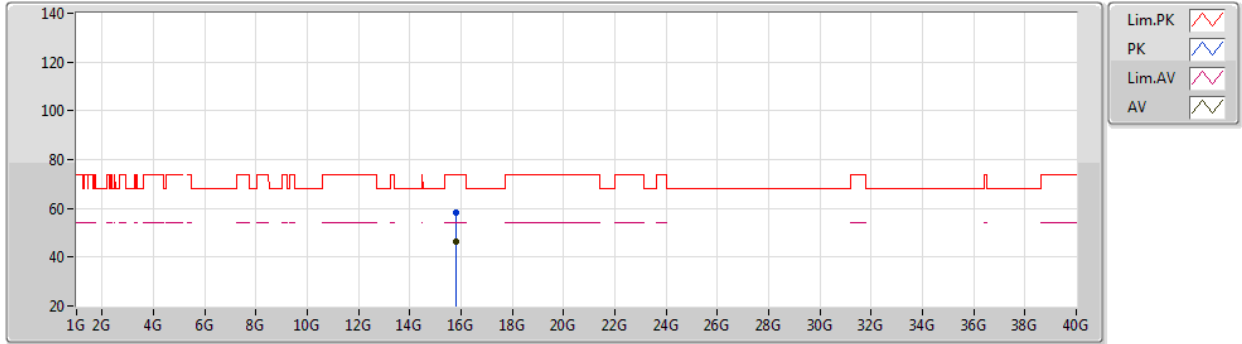

EUT X_1TX
Setting 20
02-D-B-2

Type	Freq (Hz)	Level (dBuV/m)	Limit (dBuV/m)	Margin (dB)	Raw (dBuV)	Dist (m)	Condition	Azimuth (°)	Height (m)	Comment	AF (dB)	CL (dB)	PA (dB)
PK	15.81386G	58.26	74.00	-15.74	43.02	3	Horizontal	331	2.23	-	37.94	9.34	32.04
AV	15.81296G	46.61	54.00	-7.39	31.37	3	Horizontal	331	2.23	-	37.94	9.34	32.04

802.11ac VHT40_Nss1,(MCS0)_1TX

23/03/2020

5310MHz_TX

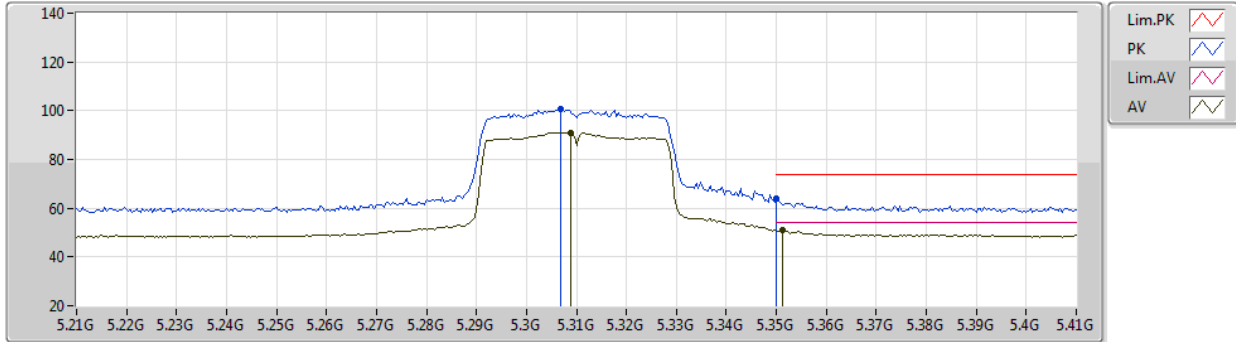

EUT X_1TX
Setting 12
02-D-B-2-10

Type	Freq (Hz)	Level (dBuV/m)	Limit (dBuV/m)	Margin (dB)	Raw (dBuV)	Dist (m)	Condition	Azimuth (°)	Height (m)	Comment	AF (dB)	CL (dB)	PA (dB)
PK	5.3068G	100.51	Inf	-Inf	91.09	3	Vertical	345	1.00	-	33.81	6.05	30.44
AV	5.3088G	91.12	Inf	-Inf	81.70	3	Vertical	345	1.00	-	33.81	6.05	30.44
PK	5.35G	63.98	74.00	-10.02	54.51	3	Vertical	345	1.00	-	33.85	6.07	30.45
AV	5.3512G	50.79	54.00	-3.21	41.32	3	Vertical	345	1.00	-	33.85	6.08	30.46

802.11ac VHT40_Nss1,(MCS0)_1TX

23/03/2020

5310MHz_TX

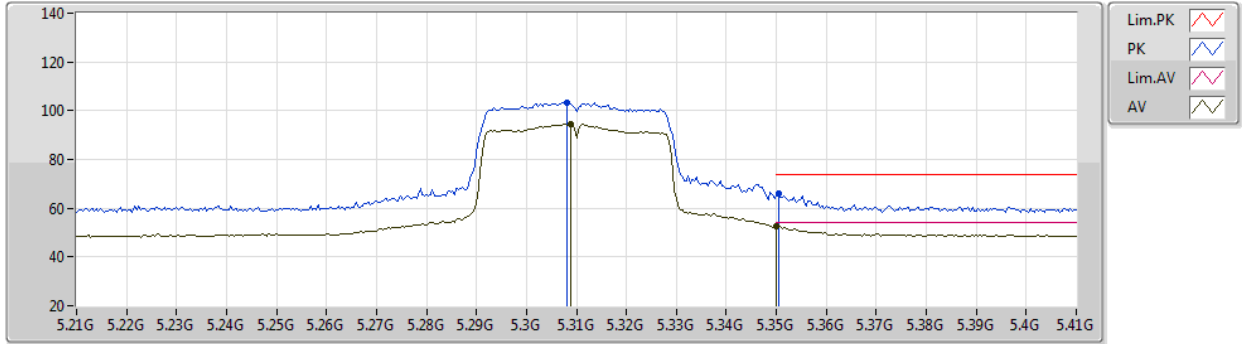

EUT X_1TX
Setting 12
02-D-B-2-10

Type	Freq (Hz)	Level (dBuV/m)	Limit (dBuV/m)	Margin (dB)	Raw (dBuV)	Dist (m)	Condition	Azimuth (°)	Height (m)	Comment	AF (dB)	CL (dB)	PA (dB)
PK	5.308G	103.26	Inf	-Inf	93.84	3	Horizontal	354	1.00	-	33.81	6.05	30.44
AV	5.3088G	94.33	Inf	-Inf	84.91	3	Horizontal	354	1.00	-	33.81	6.05	30.44
PK	5.3504G	65.79	74.00	-8.21	56.32	3	Horizontal	354	1.00	-	33.85	6.08	30.46
AV	5.35G	52.56	54.00	-1.44	43.09	3	Horizontal	354	1.00	-	33.85	6.07	30.45

802.11ac VHT40_Nss1,(MCS0)_1TX

23/03/2020

5310MHz_TX

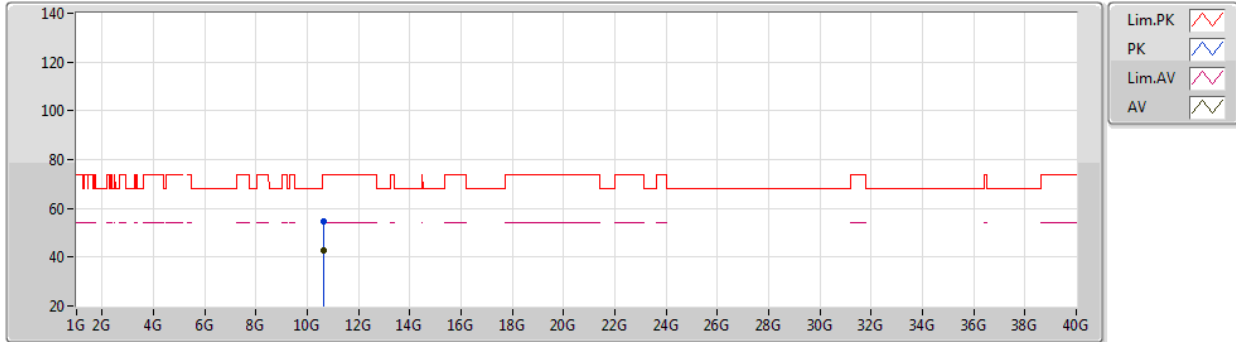

EUT X_1TX
Setting 12
02-D-B-2

Type	Freq (Hz)	Level (dBuV/m)	Limit (dBuV/m)	Margin (dB)	Raw (dBuV)	Dist (m)	Condition	Azimuth (°)	Height (m)	Comment	AF (dB)	CL (dB)	PA (dB)
PK	10.62056G	54.71	74.00	-19.29	38.93	3	Vertical	184	2.86	-	38.67	8.59	31.48
AV	10.6183G	42.71	54.00	-11.29	26.93	3	Vertical	184	2.86	-	38.67	8.59	31.48

802.11ac VHT40_Nss1,(MCS0)_1TX

23/03/2020

5310MHz_TX

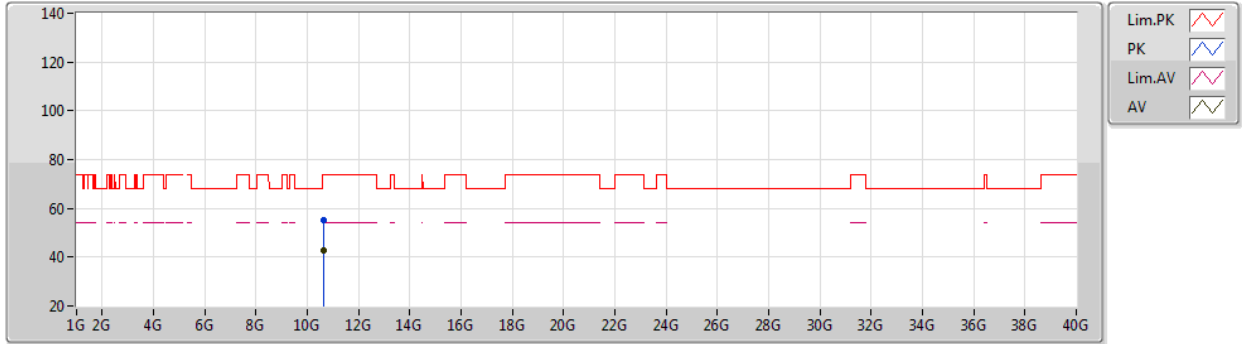

EUT X_1TX
Setting 12
02-D-B-2

Type	Freq (Hz)	Level (dBuV/m)	Limit (dBuV/m)	Margin (dB)	Raw (dBuV)	Dist (m)	Condition	Azimuth (°)	Height (m)	Comment	AF (dB)	CL (dB)	PA (dB)
PK	10.61824G	55.00	74.00	-19.00	39.22	3	Horizontal	298	1.00	-	38.67	8.59	31.48
AV	10.62348G	42.61	54.00	-11.39	26.84	3	Horizontal	298	1.00	-	38.66	8.59	31.48

802.11ac VHT40_Nss1,(MCS0)_1TX

23/03/2020

5510MHz_TX

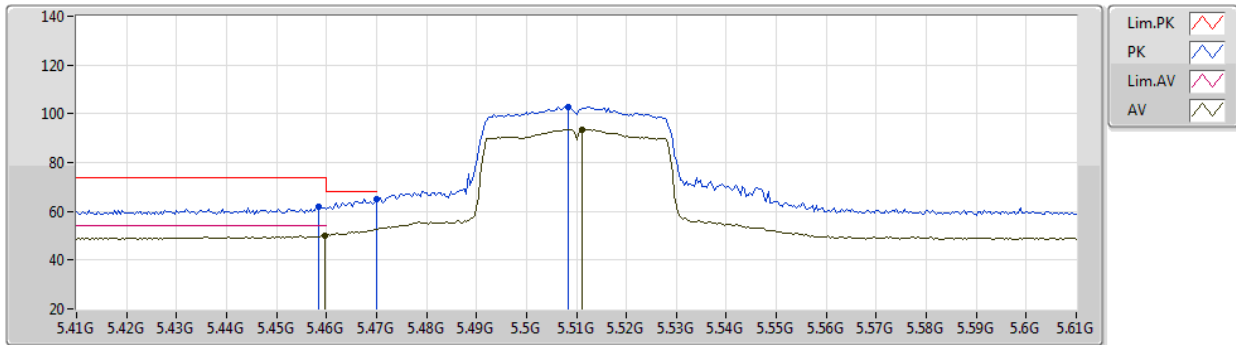

EUT X_1TX
Setting 14
02-D-B-2-10

Type	Freq (Hz)	Level (dBuV/m)	Limit (dBuV/m)	Margin (dB)	Raw (dBuV)	Dist (m)	Condition	Azimuth (°)	Height (m)	Comment	AF (dB)	CL (dB)	PA (dB)
PK	5.4584G	61.77	74.00	-12.23	52.20	3	Vertical	19	2.10	-	33.90	6.16	30.49
AV	5.4596G	49.93	54.00	-4.07	40.35	3	Vertical	19	2.10	-	33.90	6.17	30.49
PK	5.47G	64.90	68.20	-3.30	55.32	3	Vertical	19	2.10	-	33.90	6.18	30.50
PK	5.5084G	102.99	Inf	-Inf	93.37	3	Vertical	19	2.10	-	33.91	6.22	30.51
AV	5.5112G	93.64	Inf	-Inf	84.02	3	Vertical	19	2.10	-	33.91	6.22	30.51

802.11ac VHT40_Nss1,(MCS0)_1TX

23/03/2020

5510MHz_TX

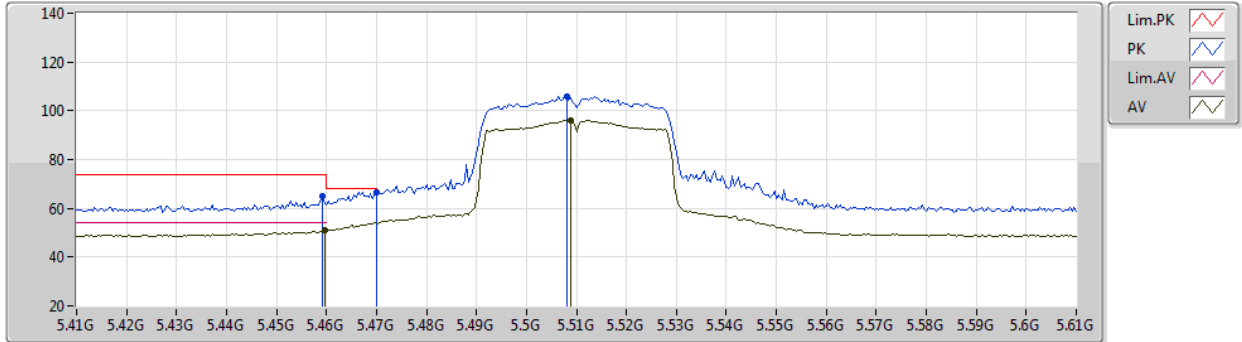

EUT X_1TX
Setting 14
02-D-B-2-10

Type	Freq (Hz)	Level (dBuV/m)	Limit (dBuV/m)	Margin (dB)	Raw (dBuV)	Dist (m)	Condition	Azimuth (°)	Height (m)	Comment	AF (dB)	CL (dB)	PA (dB)
PK	5.4592G	64.76	74.00	-9.24	55.18	3	Horizontal	357	2.31	-	33.90	6.17	30.49
AV	5.4596G	50.78	54.00	-3.22	41.20	3	Horizontal	357	2.31	-	33.90	6.17	30.49
PK	5.47G	66.72	68.20	-1.48	57.14	3	Horizontal	357	2.31	-	33.90	6.18	30.50
PK	5.508G	105.94	Inf	-Inf	96.32	3	Horizontal	357	2.31	-	33.91	6.22	30.51
AV	5.5088G	96.03	Inf	-Inf	86.41	3	Horizontal	357	2.31	-	33.91	6.22	30.51

802.11ac VHT40_Nss1,(MCS0)_1TX

23/03/2020

5510MHz_TX

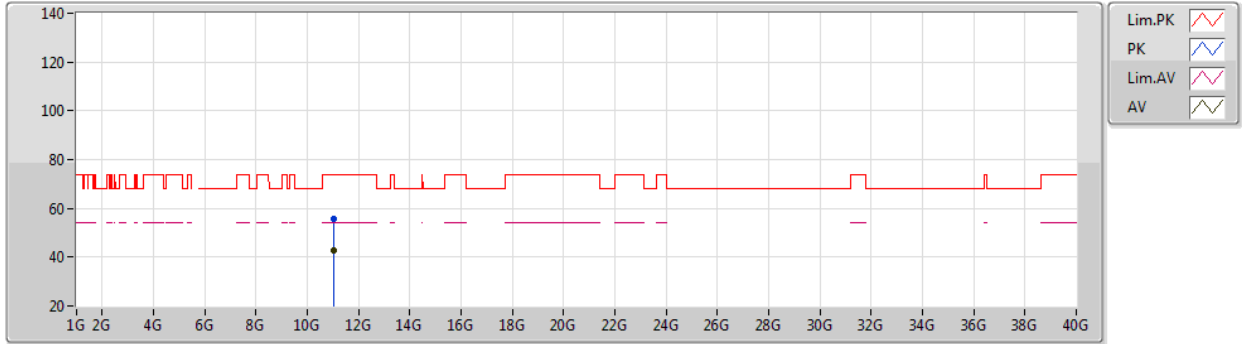

EUT X_1TX
Setting 14
02-D-B-2

Type	Freq (Hz)	Level (dBuV/m)	Limit (dBuV/m)	Margin (dB)	Raw (dBuV)	Dist (m)	Condition	Azimuth (°)	Height (m)	Comment	AF (dB)	CL (dB)	PA (dB)
PK	11.01942G	55.45	74.00	-18.55	39.77	3	Vertical	347	1.98	-	38.42	8.72	31.46
AV	11.02186G	42.81	54.00	-11.19	27.13	3	Vertical	347	1.98	-	38.42	8.72	31.46

802.11ac VHT40_Nss1,(MCS0)_1TX

23/03/2020

5510MHz_TX

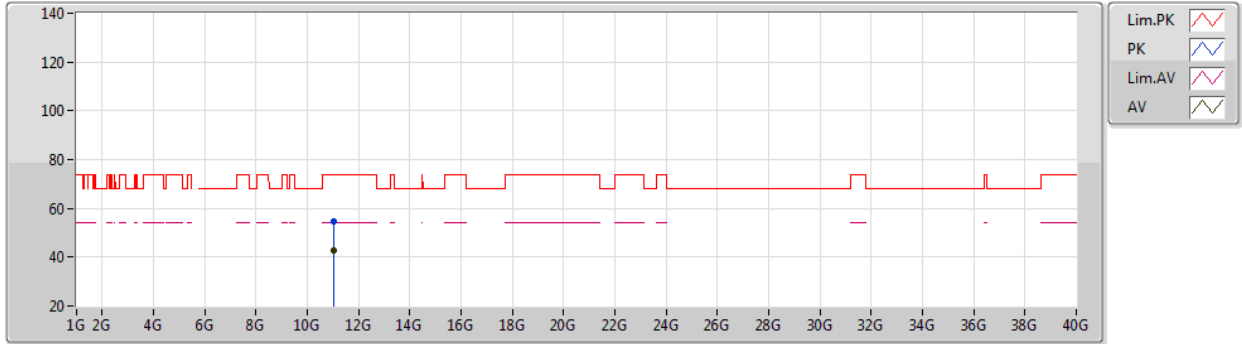

EUT X_1TX
Setting 14
02-D-B-2

Type	Freq (Hz)	Level (dBuV/m)	Limit (dBuV/m)	Margin (dB)	Raw (dBuV)	Dist (m)	Condition	Azimuth (°)	Height (m)	Comment	AF (dB)	CL (dB)	PA (dB)
PK	11.02438G	54.89	74.00	-19.11	39.21	3	Horizontal	185	2.04	-	38.42	8.72	31.46
AV	11.0208G	42.93	54.00	-11.07	27.25	3	Horizontal	185	2.04	-	38.42	8.72	31.46

802.11ac VHT40_Nss1,(MCS0)_1TX

23/03/2020

5550MHz_TX

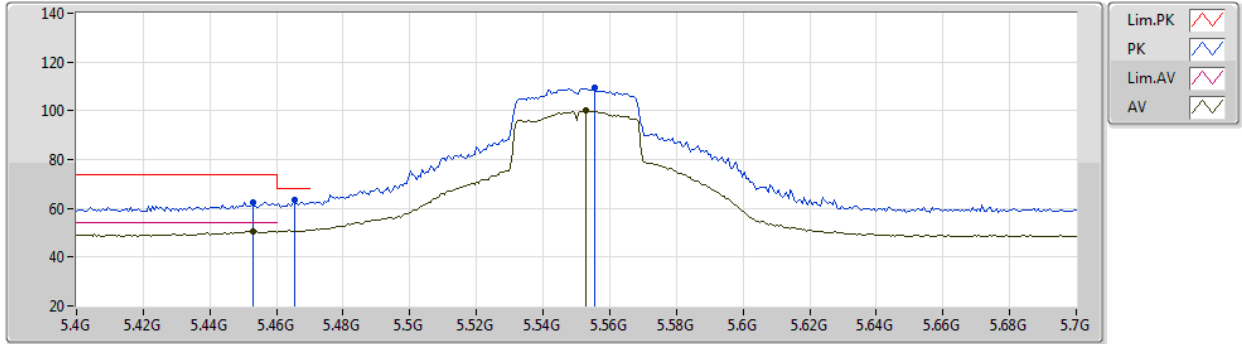

EUT X_1TX
Setting 21
02-D-B-2-10

Type	Freq (Hz)	Level (dBuV/m)	Limit (dBuV/m)	Margin (dB)	Raw (dBuV)	Dist (m)	Condition	Azimuth (°)	Height (m)	Comment	AF (dB)	CL (dB)	PA (dB)
PK	5.4528G	62.36	74.00	-11.64	52.79	3	Vertical	16	2.48	-	33.90	6.16	30.49
AV	5.4528G	50.77	54.00	-3.23	41.20	3	Vertical	16	2.48	-	33.90	6.16	30.49
PK	5.4654G	63.37	68.20	-4.83	53.80	3	Vertical	16	2.48	-	33.90	6.17	30.50
PK	5.5554G	109.32	Inf	-Inf	99.62	3	Vertical	16	2.48	-	33.96	6.26	30.52
AV	5.553G	99.95	Inf	-Inf	90.26	3	Vertical	16	2.48	-	33.95	6.26	30.52

802.11ac VHT40_Nss1,(MCS0)_1TX

23/03/2020

5550MHz_TX

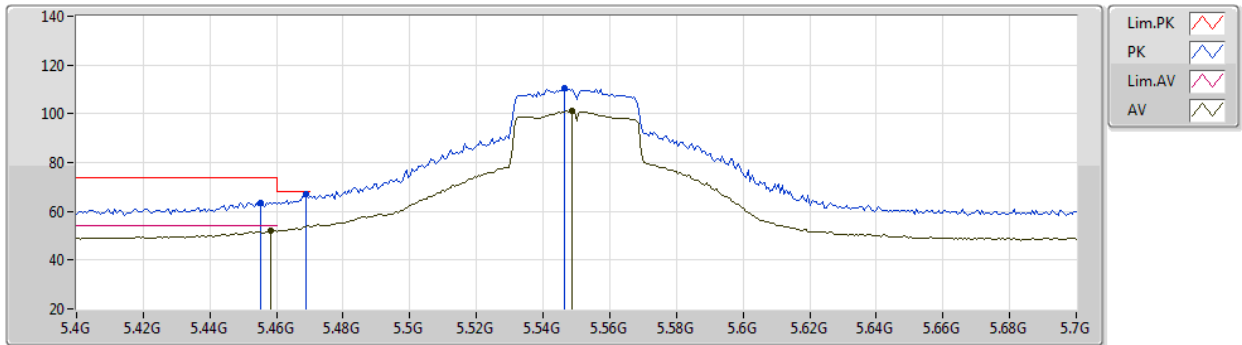

EUT X_1TX
Setting 21
02-D-B-2-10

Type	Freq (Hz)	Level (dBuV/m)	Limit (dBuV/m)	Margin (dB)	Raw (dBuV)	Dist (m)	Condition	Azimuth (°)	Height (m)	Comment	AF (dB)	CL (dB)	PA (dB)
PK	5.4552G	63.66	74.00	-10.34	54.09	3	Horizontal	352	2.02	-	33.90	6.16	30.49
AV	5.4582G	51.91	54.00	-2.09	42.34	3	Horizontal	352	2.02	-	33.90	6.16	30.49
PK	5.469G	66.97	68.20	-1.23	57.39	3	Horizontal	352	2.02	-	33.90	6.18	30.50
PK	5.5464G	110.34	Inf	-Inf	100.66	3	Horizontal	352	2.02	-	33.95	6.25	30.52
AV	5.5488G	101.27	Inf	-Inf	91.59	3	Horizontal	352	2.02	-	33.95	6.25	30.52

802.11ac VHT40_Nss1,(MCS0)_1TX

23/03/2020

5550MHz_TX

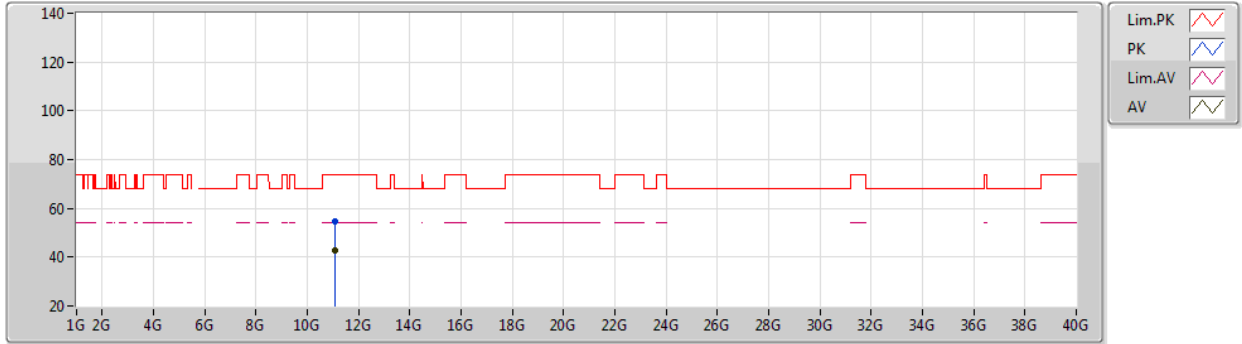

EUT X_1TX
Setting 21
02-D-B-2

Type	Freq (Hz)	Level (dBuV/m)	Limit (dBuV/m)	Margin (dB)	Raw (dBuV)	Dist (m)	Condition	Azimuth (°)	Height (m)	Comment	AF (dB)	CL (dB)	PA (dB)
PK	11.0977G	54.58	74.00	-19.42	38.84	3	Vertical	284	2.90	-	38.48	8.74	31.48
AV	11.1031G	42.88	54.00	-11.12	27.14	3	Vertical	284	2.90	-	38.48	8.74	31.48

802.11ac VHT40_Nss1,(MCS0)_1TX

23/03/2020

5550MHz_TX

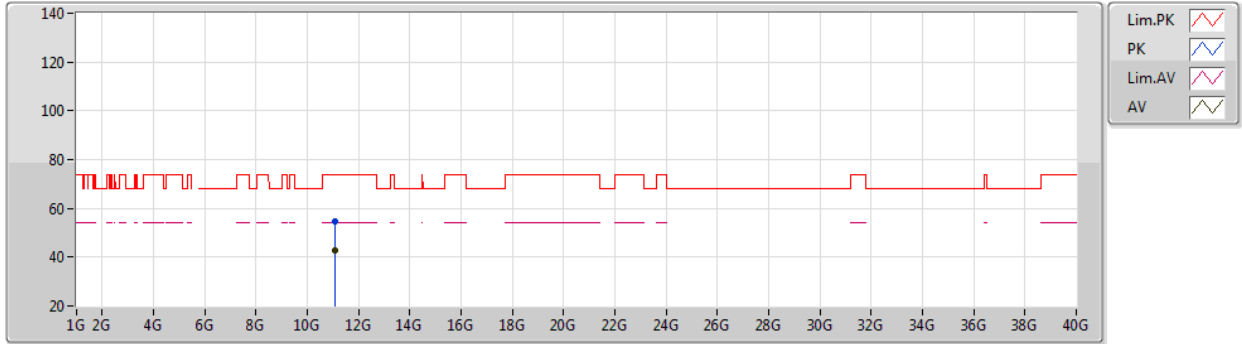

EUT X_1TX
Setting 21
02-D-B-2

Type	Freq (Hz)	Level (dBuV/m)	Limit (dBuV/m)	Margin (dB)	Raw (dBuV)	Dist (m)	Condition	Azimuth (°)	Height (m)	Comment	AF (dB)	CL (dB)	PA (dB)
PK	11.09726G	54.48	74.00	-19.52	38.74	3	Horizontal	44	1.91	-	38.48	8.74	31.48
AV	11.10424G	42.83	54.00	-11.17	27.09	3	Horizontal	44	1.91	-	38.48	8.74	31.48



802.11ac VHT40_Nss1,(MCS0)_1TX

23/03/2020

5670MHz_TX

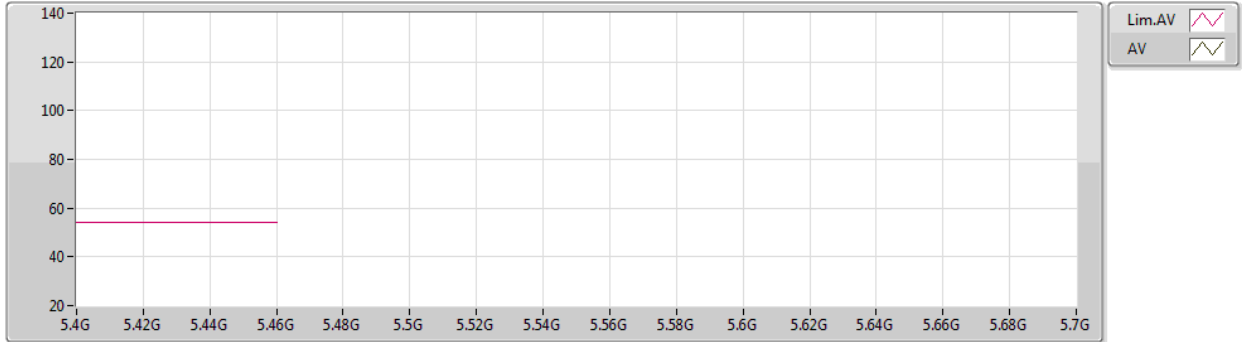

EUT X_1TX
Setting 21
02-D-B-2-10

Type	Freq	Level	Limit	Margin	Raw	Dist	Condition	Azimuth	Height	Comment	AF	CL	PA
	(Hz)	(dBuV/m)	(dBuV/m)	(dB)	(dBuV)	(m)		(°)	(m)		(dB)	(dB)	(dB)

802.11ac VHT40_Nss1,(MCS0)_1TX

23/03/2020

5670MHz_TX

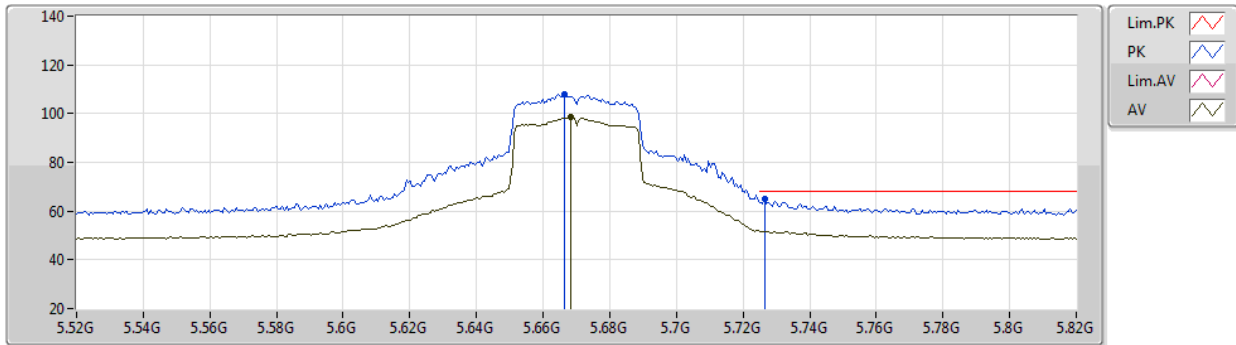

EUT X_1TX
Setting 21
02-D-B-2-10

Type	Freq (Hz)	Level (dBuV/m)	Limit (dBuV/m)	Margin (dB)	Raw (dBuV)	Dist (m)	Condition	Azimuth (°)	Height (m)	Comment	AF (dB)	CL (dB)	PA (dB)
PK	5.6664G	107.81	Inf	-Inf	98.16	3	Horizontal	30	1.00	-	33.87	6.33	30.55
AV	5.6682G	98.41	Inf	-Inf	88.77	3	Horizontal	30	1.00	-	33.86	6.33	30.55
PK	5.7264G	64.88	68.20	-3.32	55.29	3	Horizontal	30	1.00	-	33.80	6.36	30.57

802.11ac VHT40_Nss1,(MCS0)_1TX

23/03/2020

5670MHz_TX

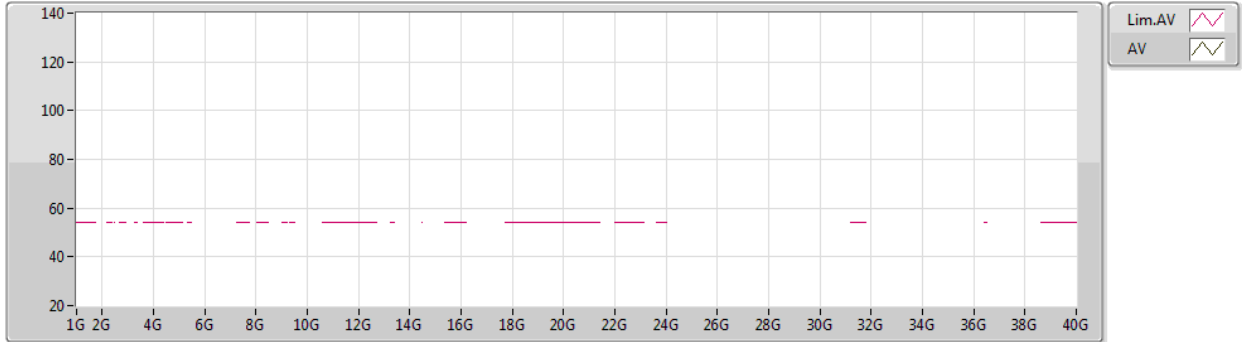

EUT X_1TX
Setting 21
02-D-B-2

Type	Freq	Level	Limit	Margin	Raw	Dist	Condition	Azimuth	Height	Comment	AF	CL	PA
	(Hz)	(dBuV/m)	(dBuV/m)	(dB)	(dBuV)	(m)		(°)	(m)		(dB)	(dB)	(dB)



802.11ac VHT40_Nss1,(MCS0)_1TX

23/03/2020

5670MHz_TX

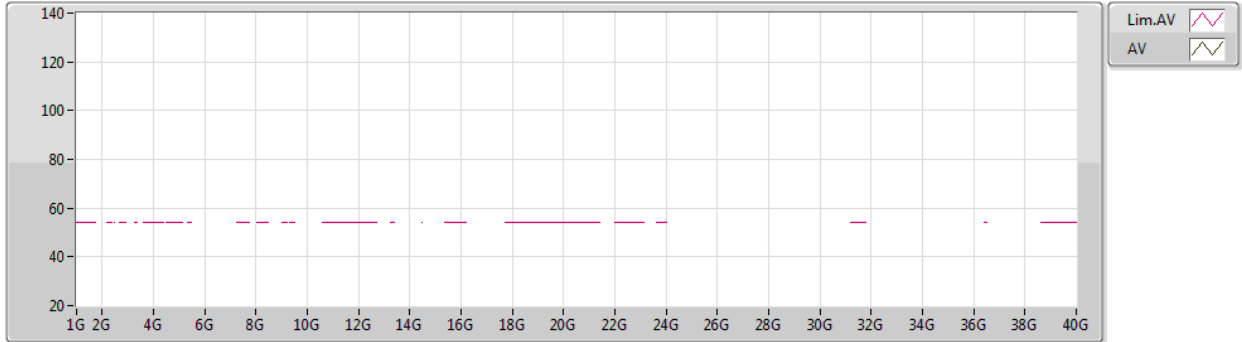

EUT X_1TX
Setting 21
02-D-B-2

Type	Freq	Level	Limit	Margin	Raw	Dist	Condition	Azimuth	Height	Comment	AF	CL	PA
	(Hz)	(dBuV/m)	(dBuV/m)	(dB)	(dBuV)	(m)		(°)	(m)		(dB)	(dB)	(dB)

802.11ac VHT40_Nss1,(MCS0)_1TX

24/03/2020

5755MHz_TX

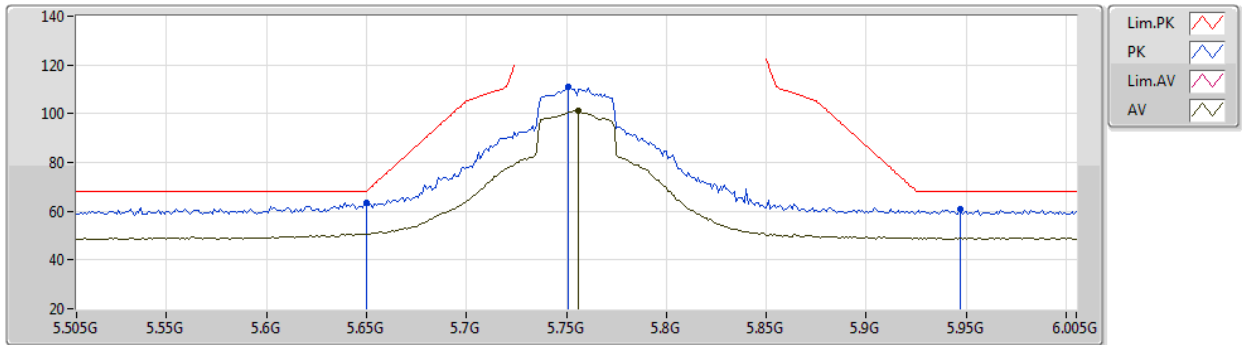

EUT X_1TX
Setting 18
02-D-B-2-10

Type	Freq (Hz)	Level (dBuV/m)	Limit (dBuV/m)	Margin (dB)	Raw (dBuV)	Dist (m)	Condition	Azimuth (°)	Height (m)	Comment	AF (dB)	CL (dB)	PA (dB)
PK	5.65G	63.40	68.20	-4.80	53.73	3	Vertical	355	2.45	-	33.90	6.32	30.55
PK	5.751G	111.23	Inf	-Inf	101.62	3	Vertical	355	2.45	-	33.80	6.38	30.57
AV	5.756G	101.10	Inf	-Inf	91.49	3	Vertical	355	2.45	-	33.80	6.38	30.57
PK	5.947G	60.66	68.20	-7.54	50.86	3	Vertical	355	2.45	-	34.09	6.33	30.62

802.11ac VHT40_Nss1,(MCS0)_1TX

24/03/2020

5755MHz_TX

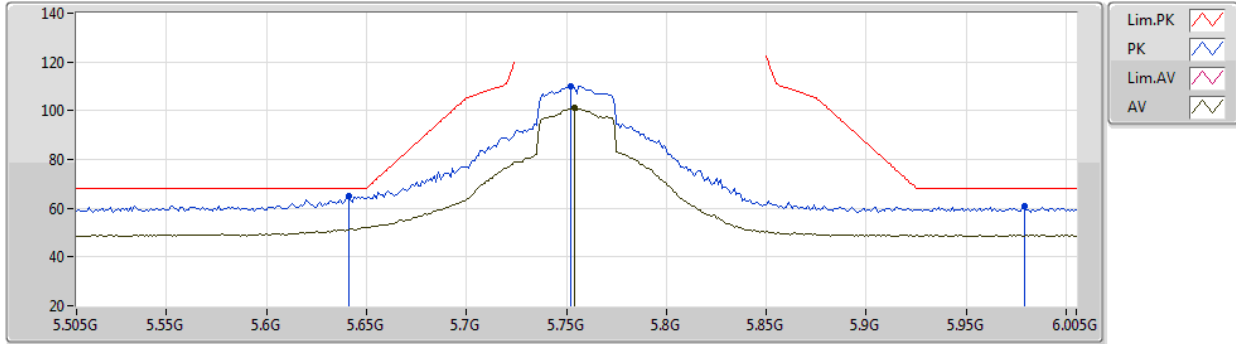

EUT X_1TX
Setting 18
02-D-B-2-10

Type	Freq (Hz)	Level (dBuV/m)	Limit (dBuV/m)	Margin (dB)	Raw (dBuV)	Dist (m)	Condition	Azimuth (°)	Height (m)	Comment	AF (dB)	CL (dB)	PA (dB)
PK	5.641G	64.82	68.20	-3.38	55.12	3	Horizontal	33	2.18	-	33.92	6.32	30.54
PK	5.752G	110.12	Inf	-Inf	100.51	3	Horizontal	33	2.18	-	33.80	6.38	30.57
AV	5.754G	101.03	Inf	-Inf	91.42	3	Horizontal	33	2.18	-	33.80	6.38	30.57
PK	5.979G	60.92	68.20	-7.28	51.08	3	Horizontal	33	2.18	-	34.16	6.31	30.63

802.11ac VHT40_Nss1,(MCS0)_1TX

24/03/2020

5755MHz_TX

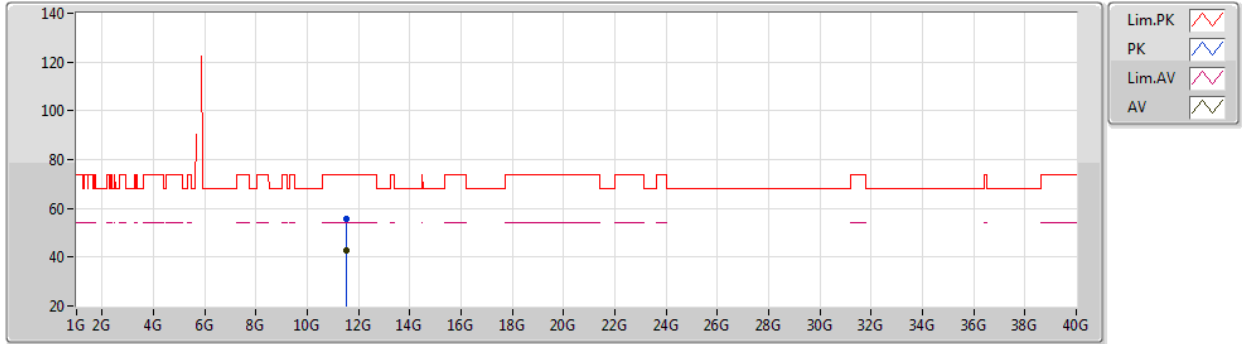

EUT X_1TX
Setting 18
02-D-B-2

Type	Freq (Hz)	Level (dBuV/m)	Limit (dBuV/m)	Margin (dB)	Raw (dBuV)	Dist (m)	Condition	Azimuth (°)	Height (m)	Comment	AF (dB)	CL (dB)	PA (dB)
PK	11.51128G	55.65	74.00	-18.35	39.59	3	Vertical	28	1.21	-	38.81	8.86	31.61
AV	11.51078G	42.81	54.00	-11.19	26.75	3	Vertical	28	1.21	-	38.81	8.86	31.61

802.11ac VHT40_Nss1,(MCS0)_1TX

24/03/2020

5755MHz_TX

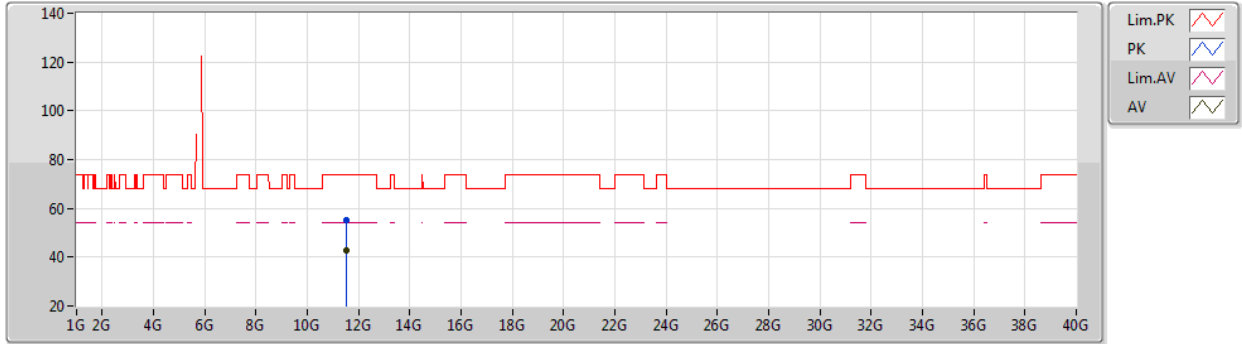

EUT X_1TX
Setting 18
02-D-B-2

Type	Freq (Hz)	Level (dBuV/m)	Limit (dBuV/m)	Margin (dB)	Raw (dBuV)	Dist (m)	Condition	Azimuth (°)	Height (m)	Comment	AF (dB)	CL (dB)	PA (dB)
PK	11.51382G	55.09	74.00	-18.91	39.03	3	Horizontal	173	1.75	-	38.81	8.86	31.61
AV	11.51124G	42.77	54.00	-11.23	26.71	3	Horizontal	173	1.75	-	38.81	8.86	31.61

802.11ac VHT40_Nss1,(MCS0)_1TX

24/03/2020

5795MHz_TX

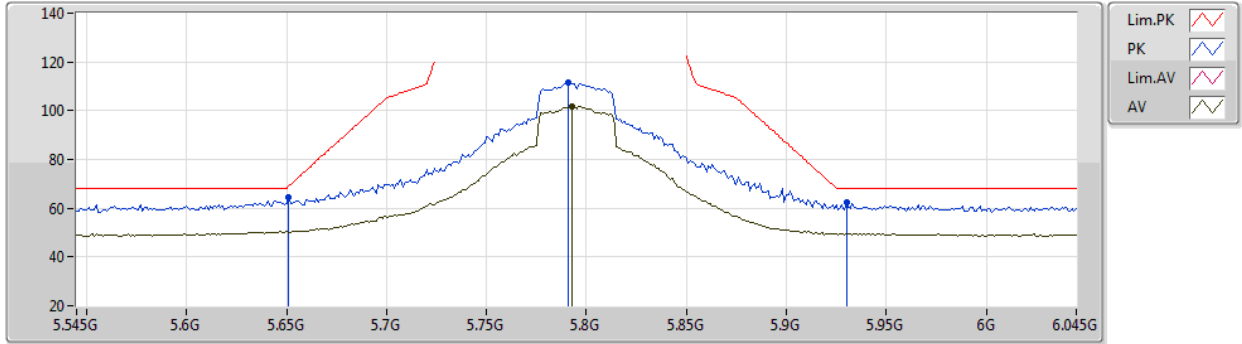

EUT X_1TX
Setting 24
02-D-B-2-10

Type	Freq (Hz)	Level (dBuV/m)	Limit (dBuV/m)	Margin (dB)	Raw (dBuV)	Dist (m)	Condition	Azimuth (°)	Height (m)	Comment	AF (dB)	CL (dB)	PA (dB)
PK	5.651G	64.27	68.94	-4.67	54.59	3	Vertical	347	2.14	-	33.90	6.33	30.55
PK	5.791G	111.36	Inf	-Inf	101.74	3	Vertical	347	2.14	-	33.80	6.40	30.58
AV	5.793G	101.92	Inf	-Inf	92.30	3	Vertical	347	2.14	-	33.80	6.40	30.58
PK	5.93G	62.45	68.20	-5.75	52.68	3	Vertical	347	2.14	-	34.06	6.33	30.62

802.11ac VHT40_Nss1,(MCS0)_1TX

24/03/2020

5795MHz_TX

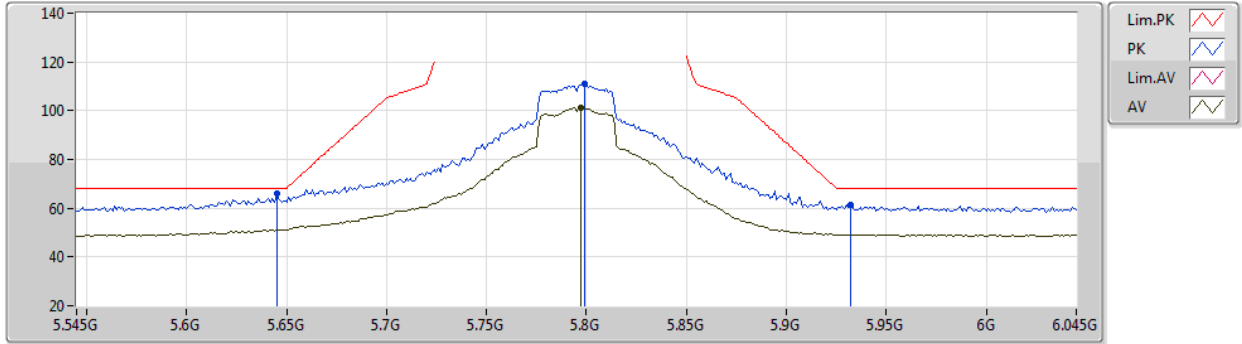

EUT X_1TX
Setting 24
02-D-B-2-10

Type	Freq (Hz)	Level (dBuV/m)	Limit (dBuV/m)	Margin (dB)	Raw (dBuV)	Dist (m)	Condition	Azimuth (°)	Height (m)	Comment	AF (dB)	CL (dB)	PA (dB)
PK	5.645G	66.07	68.20	-2.13	56.38	3	Horizontal	32	1.96	-	33.91	6.32	30.54
PK	5.799G	110.90	Inf	-Inf	101.28	3	Horizontal	32	1.96	-	33.80	6.40	30.58
AV	5.797G	101.19	Inf	-Inf	91.57	3	Horizontal	32	1.96	-	33.80	6.40	30.58
PK	5.932G	61.42	68.20	-6.78	51.65	3	Horizontal	32	1.96	-	34.06	6.33	30.62

802.11ac VHT40_Nss1,(MCS0)_1TX

24/03/2020

5795MHz_TX

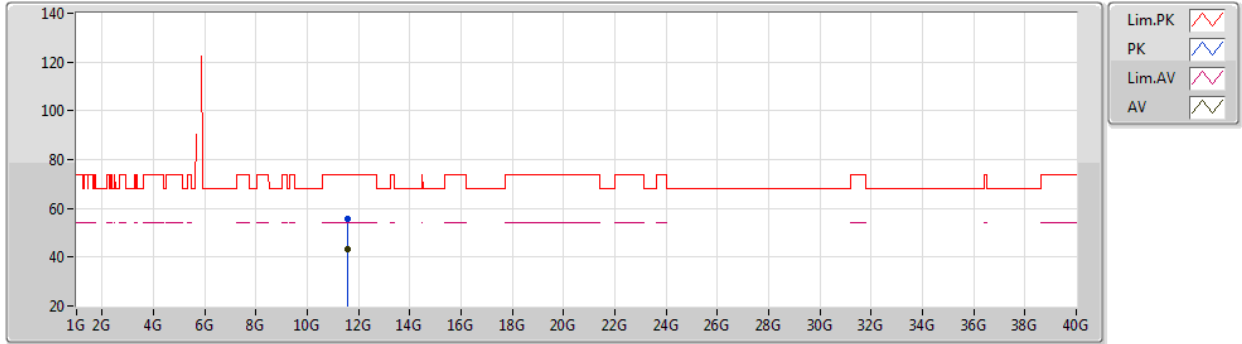

EUT X_1TX
Setting 24
02-D-B-2

Type	Freq (Hz)	Level (dBuV/m)	Limit (dBuV/m)	Margin (dB)	Raw (dBuV)	Dist (m)	Condition	Azimuth (°)	Height (m)	Comment	AF (dB)	CL (dB)	PA (dB)
PK	11.58878G	55.50	74.00	-18.50	39.38	3	Vertical	331	1.20	-	38.87	8.88	31.63
AV	11.58884G	43.23	54.00	-10.77	27.11	3	Vertical	331	1.20	-	38.87	8.88	31.63

802.11ac VHT40_Nss1,(MCS0)_1TX

24/03/2020

5795MHz_TX

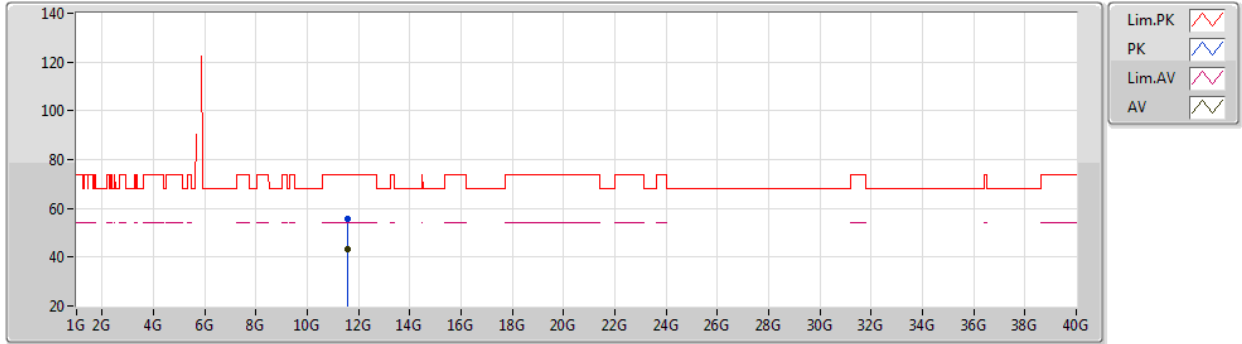

EUT X_1TX
Setting 24
02-D-B-2

Type	Freq (Hz)	Level (dBuV/m)	Limit (dBuV/m)	Margin (dB)	Raw (dBuV)	Dist (m)	Condition	Azimuth (°)	Height (m)	Comment	AF (dB)	CL (dB)	PA (dB)
PK	11.58866G	55.54	74.00	-18.46	39.42	3	Horizontal	309	1.85	-	38.87	8.88	31.63
AV	11.59398G	43.07	54.00	-10.93	26.94	3	Horizontal	309	1.85	-	38.88	8.88	31.63

802.11ac VHT80_Nss1,(MCS0)_1TX

24/03/2020

5210MHz_TX

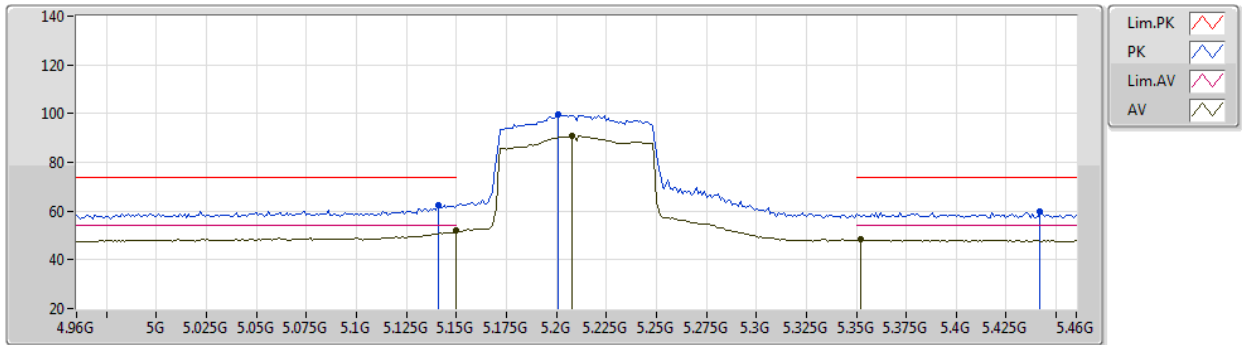

EUT X_1TX
Setting 13
06-H-5-5-10

Type	Freq (Hz)	Level (dBuV/m)	Limit (dBuV/m)	Margin (dB)	Raw (dBuV)	Dist (m)	Condition	Azimuth (°)	Height (m)	Comment	AF (dB)	CL (dB)	PA (dB)
PK	5.141G	62.49	74.00	-11.51	56.72	3	Vertical	8	1.04	-	31.80	5.60	31.63
AV	5.15G	51.95	54.00	-2.05	46.23	3	Vertical	8	1.04	-	31.75	5.60	31.63
PK	5.201G	99.60	Inf	-Inf	94.16	3	Vertical	8	1.04	-	31.50	5.60	31.66
AV	5.208G	90.97	Inf	-Inf	85.55	3	Vertical	8	1.04	-	31.47	5.61	31.66
PK	5.442G	59.67	74.00	-14.33	53.97	3	Vertical	8	1.04	-	31.68	5.80	31.78
AV	5.352G	48.26	54.00	-5.74	42.89	3	Vertical	8	1.04	-	31.36	5.75	31.74

802.11ac VHT80_Nss1,(MCS0)_1TX

24/03/2020

5210MHz_TX

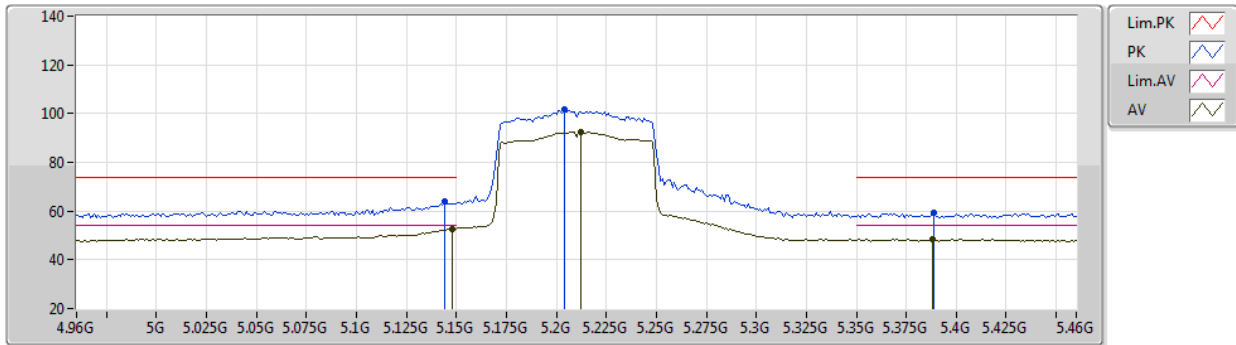

EUT X_1TX
Setting 13
06-H-S-5-10

Type	Freq (Hz)	Level (dBuV/m)	Limit (dBuV/m)	Margin (dB)	Raw (dBuV)	Dist (m)	Condition	Azimuth (°)	Height (m)	Comment	AF (dB)	CL (dB)	PA (dB)
PK	5.144G	64.08	74.00	-9.92	58.33	3	Horizontal	303	2.23	-	31.78	5.60	31.63
AV	5.148G	52.77	54.00	-1.23	47.04	3	Horizontal	303	2.23	-	31.76	5.60	31.63
PK	5.204G	101.70	Inf	-Inf	96.28	3	Horizontal	303	2.23	-	31.48	5.60	31.66
AV	5.212G	92.59	Inf	-Inf	87.20	3	Horizontal	303	2.23	-	31.45	5.61	31.67
PK	5.389G	59.18	74.00	-14.82	53.59	3	Horizontal	303	2.23	-	31.55	5.79	31.75
AV	5.388G	48.33	54.00	-5.67	42.75	3	Horizontal	303	2.23	-	31.54	5.79	31.75

802.11ac VHT80_Nss1,(MCS0)_1TX

29/05/2020

5210MHz_TX

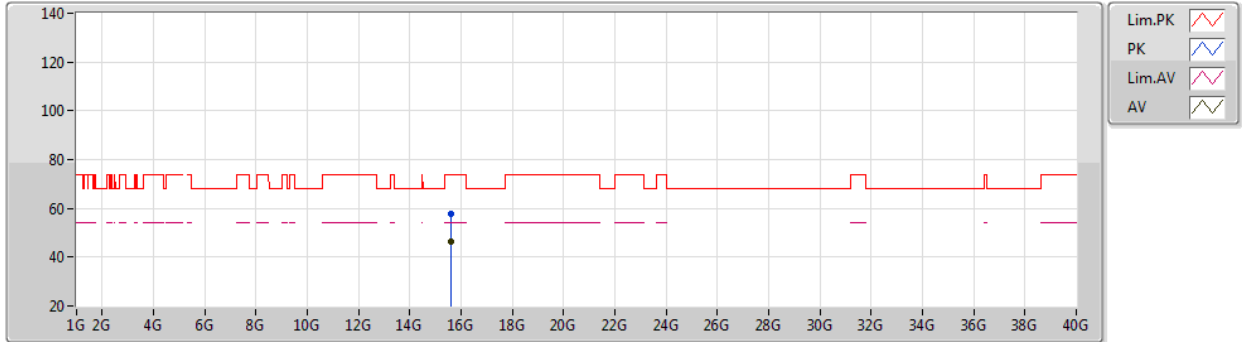

EUT X_1TX
Setting 13
06-H-S-5

Type	Freq (Hz)	Level (dBuV/m)	Limit (dBuV/m)	Margin (dB)	Raw (dBuV)	Dist (m)	Condition	Azimuth (°)	Height (m)	Comment	AF (dB)	CL (dB)	PA (dB)
PK	15.6256G	57.66	74.00	-16.34	43.84	3	Vertical	35	1.80	-	38.81	8.74	33.73
AV	15.62092G	46.28	54.00	-7.72	32.44	3	Vertical	35	1.80	-	38.83	8.74	33.73

802.11ac VHT80_Nss1,(MCS0)_1TX

29/05/2020

5210MHz_TX

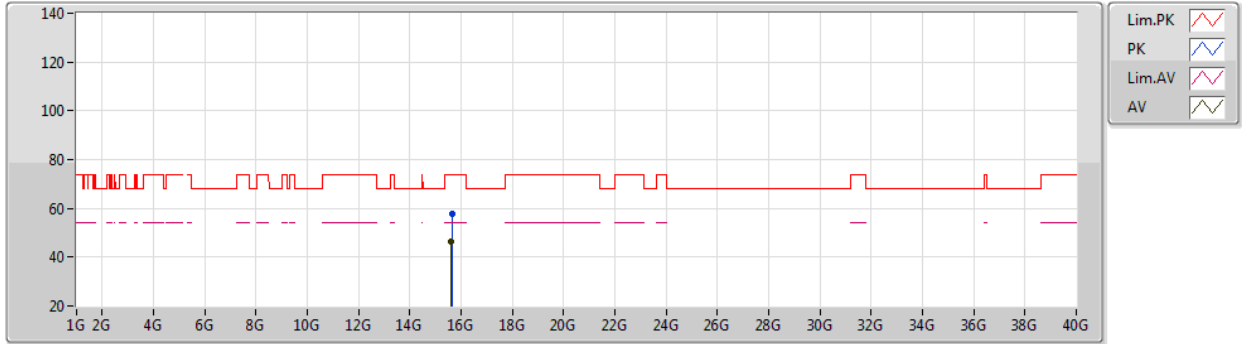

EUT X_1TX
Setting 13
06-H-S-5

Type	Freq (Hz)	Level (dBuV/m)	Limit (dBuV/m)	Margin (dB)	Raw (dBuV)	Dist (m)	Condition	Azimuth (°)	Height (m)	Comment	AF (dB)	CL (dB)	PA (dB)
PK	15.63308G	57.70	74.00	-16.30	43.91	3	Horizontal	359	1.80	-	38.78	8.74	33.73
AV	15.6298G	46.21	54.00	-7.79	32.40	3	Horizontal	359	1.80	-	38.80	8.74	33.73

802.11ac VHT80_Nss1,(MCS0)_1TX

24/03/2020

5290MHz_TX

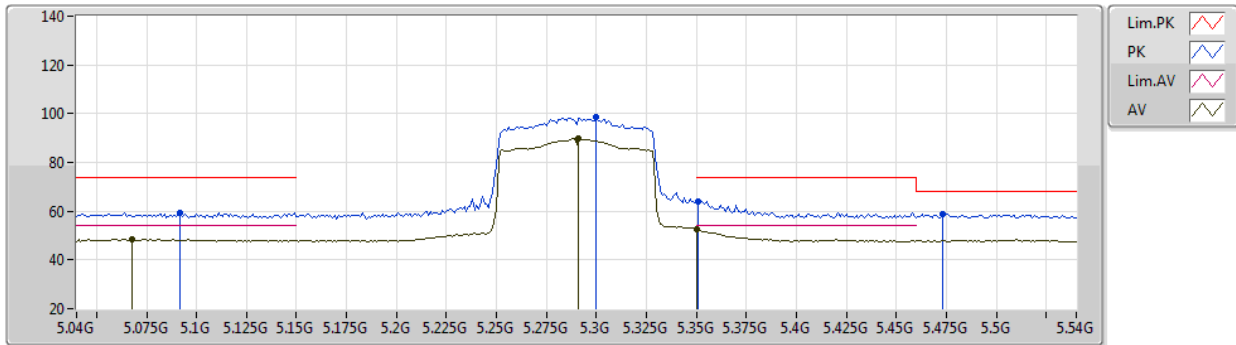

EUT X_1TX
Setting 12.5
06-H-S-5-10

Type	Freq (Hz)	Level (dBuV/m)	Limit (dBuV/m)	Margin (dB)	Raw (dBuV)	Dist (m)	Condition	Azimuth (°)	Height (m)	Comment	AF (dB)	CL (dB)	PA (dB)
PK	5.092G	59.47	74.00	-14.53	53.52	3	Vertical	0	2.06	-	31.96	5.60	31.61
AV	5.068G	48.52	54.00	-5.48	42.67	3	Vertical	0	2.06	-	31.84	5.60	31.59
PK	5.3G	98.47	Inf	-Inf	93.38	3	Vertical	0	2.06	-	31.10	5.70	31.71
AV	5.291G	89.62	Inf	-Inf	84.50	3	Vertical	0	2.06	-	31.14	5.69	31.71
PK	5.351G	64.10	74.00	-9.90	58.73	3	Vertical	0	2.06	-	31.36	5.75	31.74
AV	5.35G	52.63	54.00	-1.37	47.26	3	Vertical	0	2.06	-	31.35	5.75	31.73
PK	5.473G	58.74	68.20	-9.46	52.99	3	Vertical	0	2.06	-	31.75	5.80	31.80

802.11ac VHT80_Nss1,(MCS0)_1TX

24/03/2020

5290MHz_TX

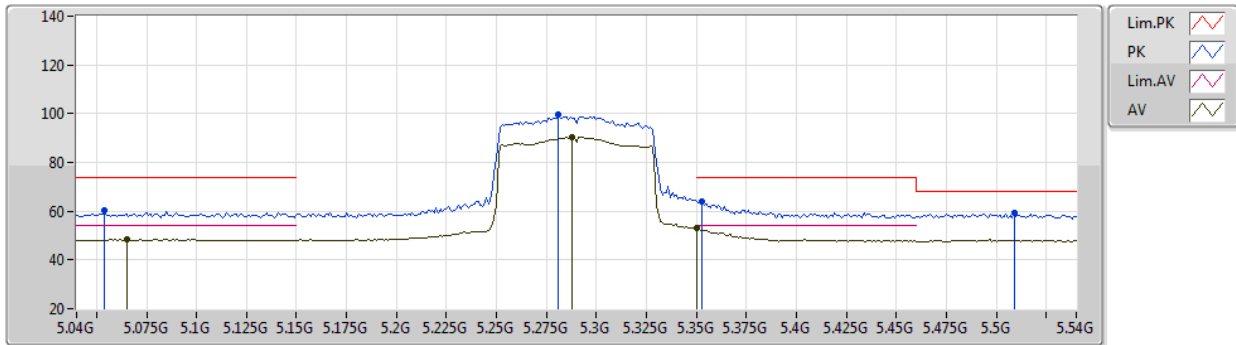

EUT X_1TX
Setting 12.5
06-H-5-5-10

Type	Freq (Hz)	Level (dBuV/m)	Limit (dBuV/m)	Margin (dB)	Raw (dBuV)	Dist (m)	Condition	Azimuth (°)	Height (m)	Comment	AF (dB)	CL (dB)	PA (dB)
PK	5.054G	60.10	74.00	-13.90	54.32	3	Horizontal	299	2.28	-	31.77	5.60	31.59
AV	5.065G	48.70	54.00	-5.30	42.87	3	Horizontal	299	2.28	-	31.82	5.60	31.59
PK	5.281G	99.58	Inf	-Inf	94.42	3	Horizontal	299	2.28	-	31.18	5.68	31.70
AV	5.288G	90.55	Inf	-Inf	85.41	3	Horizontal	299	2.28	-	31.15	5.69	31.70
PK	5.353G	63.86	74.00	-10.14	58.48	3	Horizontal	299	2.28	-	31.37	5.75	31.74
AV	5.35G	52.91	54.00	-1.09	47.54	3	Horizontal	299	2.28	-	31.35	5.75	31.73
PK	5.509G	59.07	68.20	-9.13	53.30	3	Horizontal	299	2.28	-	31.78	5.80	31.81

802.11ac VHT80_Nss1,(MCS0)_1TX

29/05/2020

5290MHz_TX

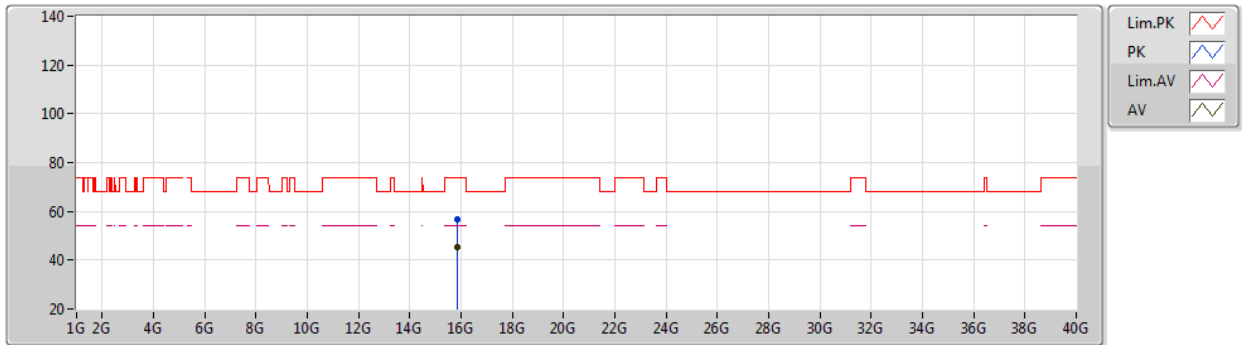

EUT X_1TX
Setting 12.5
06-H-S-5-10

Type	Freq (Hz)	Level (dBuV/m)	Limit (dBuV/m)	Margin (dB)	Raw (dBuV)	Dist (m)	Condition	Azimuth (°)	Height (m)	Comment	AF (dB)	CL (dB)	PA (dB)
PK	15.86256G	56.64	74.00	-17.36	43.73	3	Vertical	90	1.46	-	37.98	8.71	33.78
AV	15.86152G	45.30	54.00	-8.70	32.39	3	Vertical	90	1.46	-	37.98	8.71	33.78

802.11ac VHT80_Nss1,(MCS0)_1TX

29/05/2020

5290MHz_TX

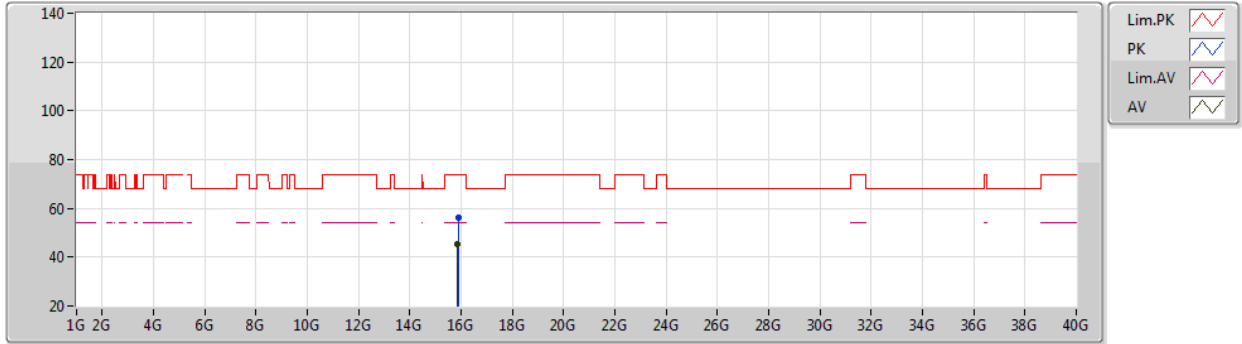

EUT X_1TX
Setting 12.5
06-H-S-5-10

Type	Freq (Hz)	Level (dBuV/m)	Limit (dBuV/m)	Margin (dB)	Raw (dBuV)	Dist (m)	Condition	Azimuth (°)	Height (m)	Comment	AF (dB)	CL (dB)	PA (dB)
PK	15.87936G	56.45	74.00	-17.55	43.60	3	Horizontal	195	1.52	-	37.92	8.71	33.78
AV	15.86536G	45.33	54.00	-8.67	32.43	3	Horizontal	195	1.52	-	37.97	8.71	33.78

802.11ac VHT80_Nss1,(MCS0)_1TX

24/03/2020

5530MHz_TX

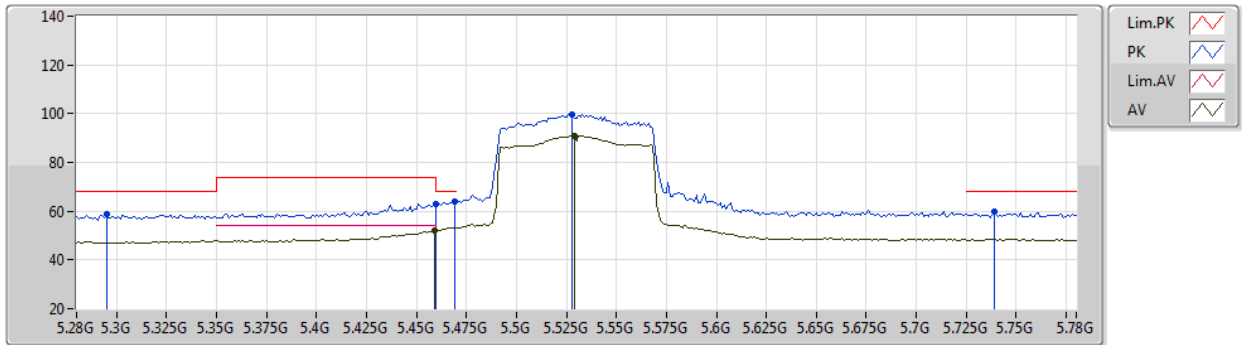

EUT X_1TX
Setting 13.5
06-H-S-5-10

Type	Freq (Hz)	Level (dBuV/m)	Limit (dBuV/m)	Margin (dB)	Raw (dBuV)	Dist (m)	Condition	Azimuth (°)	Height (m)	Comment	AF (dB)	CL (dB)	PA (dB)
PK	5.295G	58.78	68.20	-9.42	53.67	3	Vertical	5	1.96	-	31.12	5.70	31.71
PK	5.46G	62.99	74.00	-11.01	57.26	3	Vertical	5	1.96	-	31.72	5.80	31.79
AV	5.459G	51.88	54.00	-2.12	46.15	3	Vertical	5	1.96	-	31.72	5.80	31.79
PK	5.469G	63.88	68.20	-4.32	58.13	3	Vertical	5	1.96	-	31.74	5.80	31.79
PK	5.528G	99.89	Inf	-Inf	94.17	3	Vertical	5	1.96	-	31.74	5.80	31.82
AV	5.529G	91.08	Inf	-Inf	85.36	3	Vertical	5	1.96	-	31.74	5.80	31.82
PK	5.739G	59.78	68.20	-8.42	53.90	3	Vertical	5	1.96	-	31.86	5.93	31.91

802.11ac VHT80_Nss1,(MCS0)_1TX

24/03/2020

5530MHz_TX

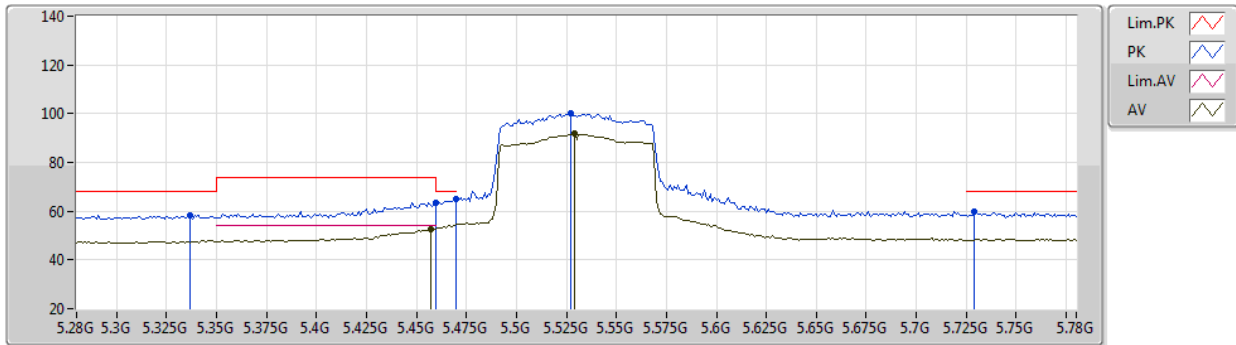

EUT X_1TX
Setting 13.5
06-H-S-5-10

Type	Freq (Hz)	Level (dBuV/m)	Limit (dBuV/m)	Margin (dB)	Raw (dBuV)	Dist (m)	Condition	Azimuth (°)	Height (m)	Comment	AF (dB)	CL (dB)	PA (dB)
PK	5.337G	58.21	68.20	-9.99	52.91	3	Horizontal	298	2.45	-	31.29	5.74	31.73
PK	5.46G	63.67	74.00	-10.33	57.94	3	Horizontal	298	2.45	-	31.72	5.80	31.79
AV	5.457G	52.78	54.00	-1.22	47.06	3	Horizontal	298	2.45	-	31.71	5.80	31.79
PK	5.47G	64.82	68.20	-3.38	59.07	3	Horizontal	298	2.45	-	31.74	5.80	31.79
PK	5.527G	100.20	Inf	-Inf	94.47	3	Horizontal	298	2.45	-	31.75	5.80	31.82
AV	5.529G	91.66	Inf	-Inf	85.94	3	Horizontal	298	2.45	-	31.74	5.80	31.82
PK	5.729G	59.88	68.20	-8.32	54.04	3	Horizontal	298	2.45	-	31.82	5.92	31.90

802.11ac VHT80_Nss1,(MCS0)_1TX

24/03/2020

5530MHz_TX

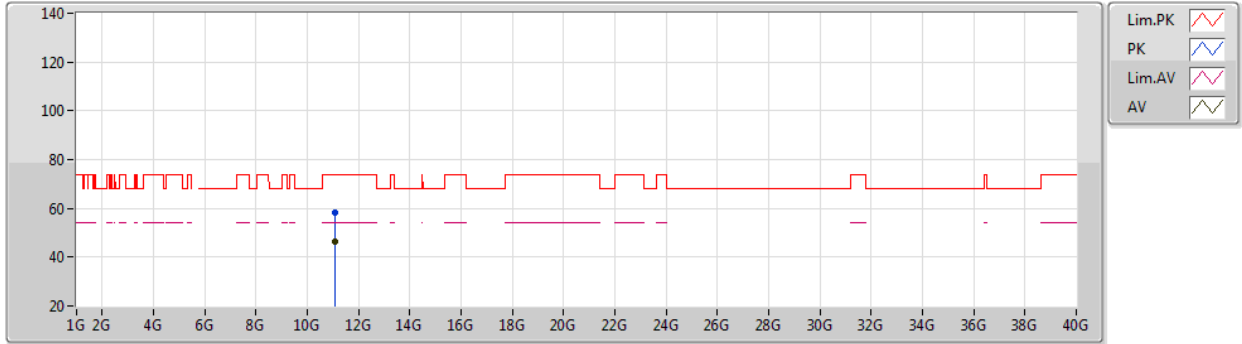

EUT X_1TX
Setting 13.5
06-H-S-5

Type	Freq (Hz)	Level (dBuV/m)	Limit (dBuV/m)	Margin (dB)	Raw (dBuV)	Dist (m)	Condition	Azimuth (°)	Height (m)	Comment	AF (dB)	CL (dB)	PA (dB)
PK	11.06972G	58.02	74.00	-15.98	43.40	3	Vertical	360	1.80	-	40.30	7.97	33.65
AV	11.05984G	46.54	54.00	-7.46	31.91	3	Vertical	360	1.80	-	40.31	7.97	33.65

802.11ac VHT80_Nss1,(MCS0)_1TX

24/03/2020

5530MHz_TX

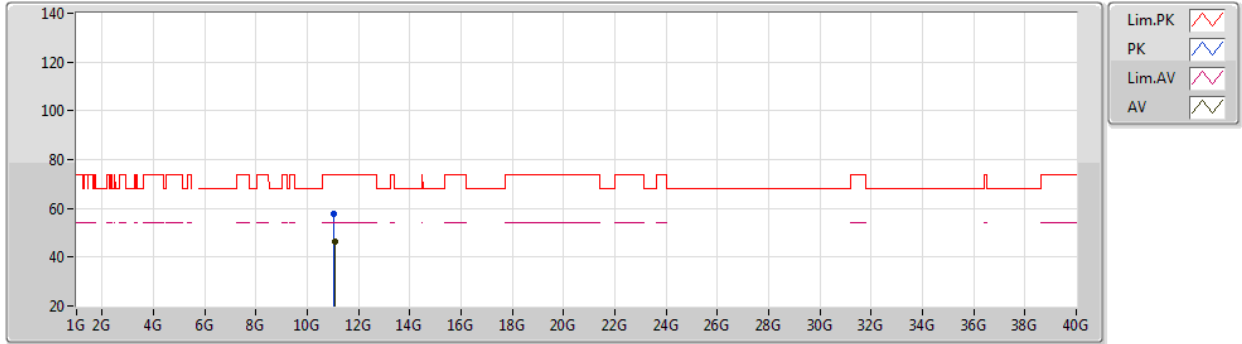

EUT X_1TX
Setting 13.5
06-H-S-5

Type	Freq (Hz)	Level (dBuV/m)	Limit (dBuV/m)	Margin (dB)	Raw (dBuV)	Dist (m)	Condition	Azimuth (°)	Height (m)	Comment	AF (dB)	CL (dB)	PA (dB)
PK	11.05172G	57.89	74.00	-16.11	43.24	3	Horizontal	215	1.80	-	40.32	7.97	33.64
AV	11.06344G	46.47	54.00	-7.53	31.85	3	Horizontal	215	1.80	-	40.30	7.97	33.65

802.11ac VHT80_Nss1,(MCS0)_1TX

24/03/2020

5610MHz_TX

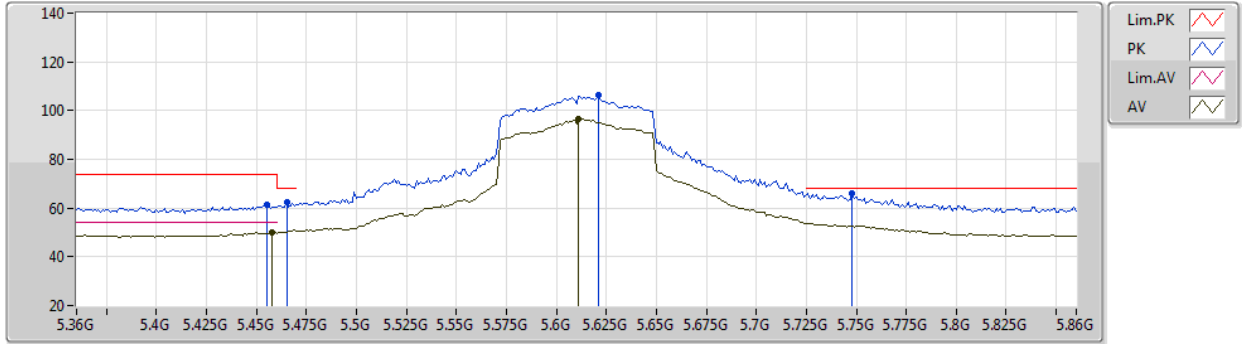

EUT X_1TX
Setting 22
02-D-B-2-10

Type	Freq (Hz)	Level (dBuV/m)	Limit (dBuV/m)	Margin (dB)	Raw (dBuV)	Dist (m)	Condition	Azimuth (°)	Height (m)	Comment	AF (dB)	CL (dB)	PA (dB)
PK	5.455G	61.23	74.00	-12.77	51.66	3	Vertical	0	2.77	-	33.90	6.16	30.49
AV	5.458G	50.22	54.00	-3.78	40.65	3	Vertical	0	2.77	-	33.90	6.16	30.49
PK	5.465G	62.55	68.20	-5.65	52.98	3	Vertical	0	2.77	-	33.90	6.17	30.50
PK	5.621G	106.41	Inf	-Inf	96.68	3	Vertical	0	2.77	-	33.96	6.31	30.54
AV	5.611G	96.35	Inf	-Inf	86.59	3	Vertical	0	2.77	-	33.98	6.31	30.53
PK	5.748G	66.22	68.20	-1.98	56.62	3	Vertical	0	2.77	-	33.80	6.37	30.57

802.11ac VHT80_Nss1,(MCS0)_1TX

24/03/2020

5610MHz_TX

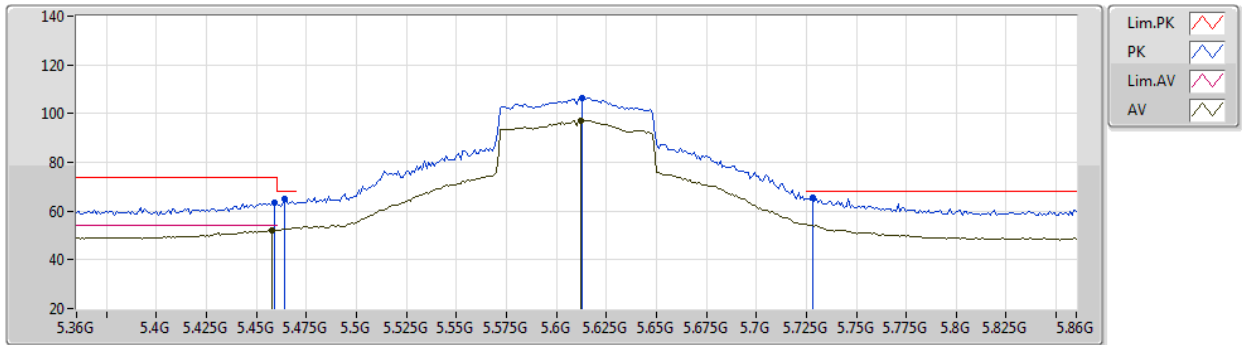

EUT X_1TX
Setting 22
02-D-B-2-10

Type	Freq (Hz)	Level (dBuV/m)	Limit (dBuV/m)	Margin (dB)	Raw (dBuV)	Dist (m)	Condition	Azimuth (°)	Height (m)	Comment	AF (dB)	CL (dB)	PA (dB)
PK	5.459G	63.24	74.00	-10.76	53.67	3	Horizontal	352	2.21	-	33.90	6.16	30.49
AV	5.458G	52.32	54.00	-1.68	42.75	3	Horizontal	352	2.21	-	33.90	6.16	30.49
PK	5.464G	65.10	68.20	-3.10	55.53	3	Horizontal	352	2.21	-	33.90	6.17	30.50
PK	5.613G	106.39	Inf	-Inf	96.64	3	Horizontal	352	2.21	-	33.97	6.31	30.53
AV	5.612G	97.27	Inf	-Inf	87.51	3	Horizontal	352	2.21	-	33.98	6.31	30.53
PK	5.728G	65.64	68.20	-2.56	56.05	3	Horizontal	352	2.21	-	33.80	6.36	30.57

802.11ac VHT80_Nss1,(MCS0)_1TX

24/03/2020

5610MHz_TX

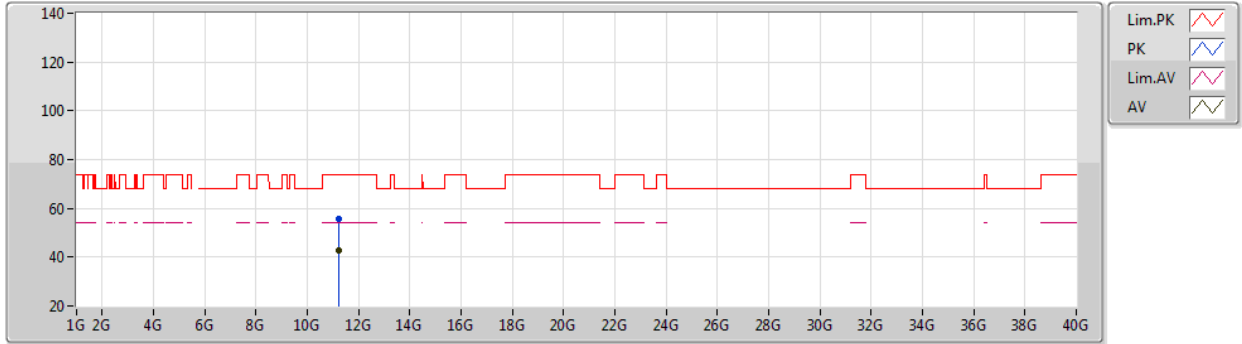

EUT X_1TX
Setting 22
02-D-B-2

Type	Freq (Hz)	Level (dBuV/m)	Limit (dBuV/m)	Margin (dB)	Raw (dBuV)	Dist (m)	Condition	Azimuth (°)	Height (m)	Comment	AF (dB)	CL (dB)	PA (dB)
PK	11.22416G	55.59	74.00	-18.41	39.75	3	Vertical	230	2.36	-	38.58	8.78	31.52
AV	11.21542G	43.01	54.00	-10.99	27.19	3	Vertical	230	2.36	-	38.57	8.77	31.52

802.11ac VHT80_Nss1,(MCS0)_1TX

24/03/2020

5610MHz_TX

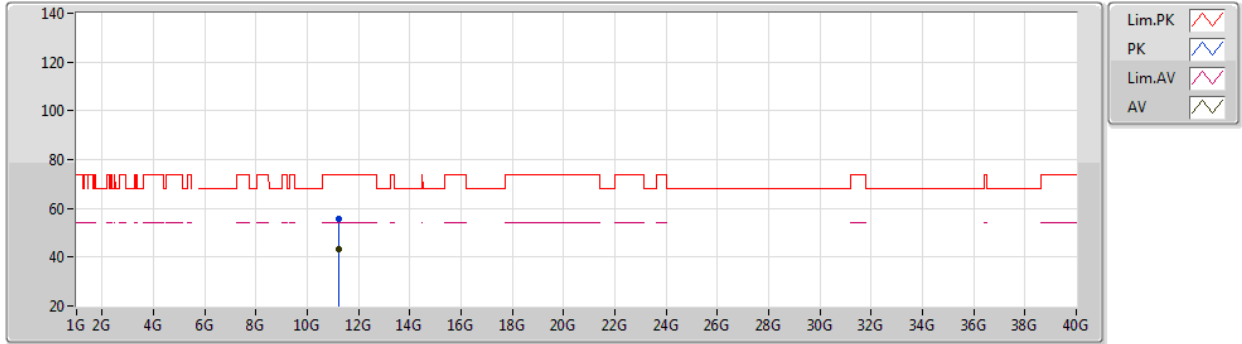

EUT X_1TX
Setting 22
02-D-B-2

Type	Freq (Hz)	Level (dBuV/m)	Limit (dBuV/m)	Margin (dB)	Raw (dBuV)	Dist (m)	Condition	Azimuth (°)	Height (m)	Comment	AF (dB)	CL (dB)	PA (dB)
PK	11.21974G	55.84	74.00	-18.16	40.01	3	Horizontal	163	2.63	-	38.58	8.77	31.52
AV	11.22212G	43.24	54.00	-10.76	27.41	3	Horizontal	163	2.63	-	38.58	8.77	31.52

802.11ac VHT80_Nss1,(MCS0)_1TX

24/03/2020

5690MHz Straddle 5.47-5.725GHz_TX

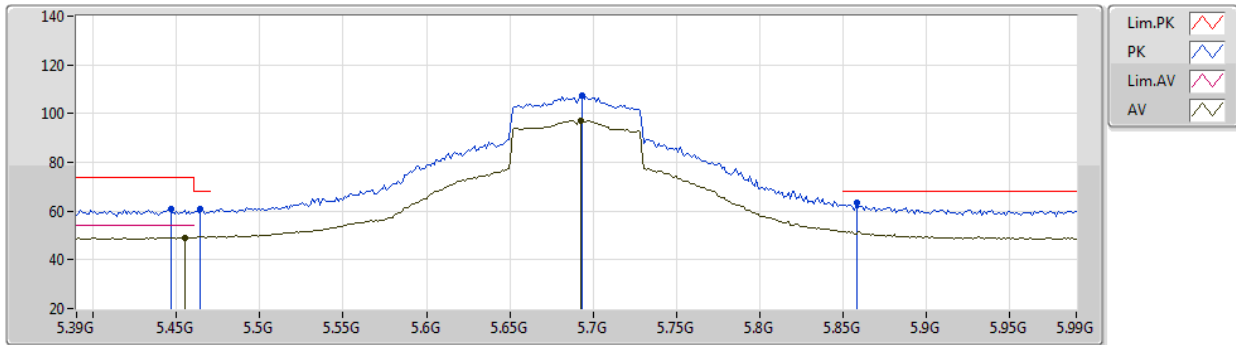

EUT X_1TX
Setting 23
02-D-B-2-10

Type	Freq (Hz)	Level (dBuV/m)	Limit (dBuV/m)	Margin (dB)	Raw (dBuV)	Dist (m)	Condition	Azimuth (°)	Height (m)	Comment	AF (dB)	CL (dB)	PA (dB)
PK	5.4464G	60.65	74.00	-13.35	51.09	3	Vertical	333	1.02	-	33.90	6.15	30.49
AV	5.4548G	49.20	54.00	-4.80	39.63	3	Vertical	333	1.02	-	33.90	6.16	30.49
PK	5.4644G	61.00	68.20	-7.20	51.43	3	Vertical	333	1.02	-	33.90	6.17	30.50
PK	5.6936G	107.23	Inf	-Inf	97.63	3	Vertical	333	1.02	-	33.81	6.35	30.56
AV	5.6924G	96.88	Inf	-Inf	87.27	3	Vertical	333	1.02	-	33.82	6.35	30.56
PK	5.858G	63.48	68.20	-4.72	53.79	3	Vertical	333	1.02	-	33.92	6.37	30.60

802.11ac VHT80_Nss1,(MCS0)_1TX

24/03/2020

5690MHz Straddle 5.47-5.725GHz_TX

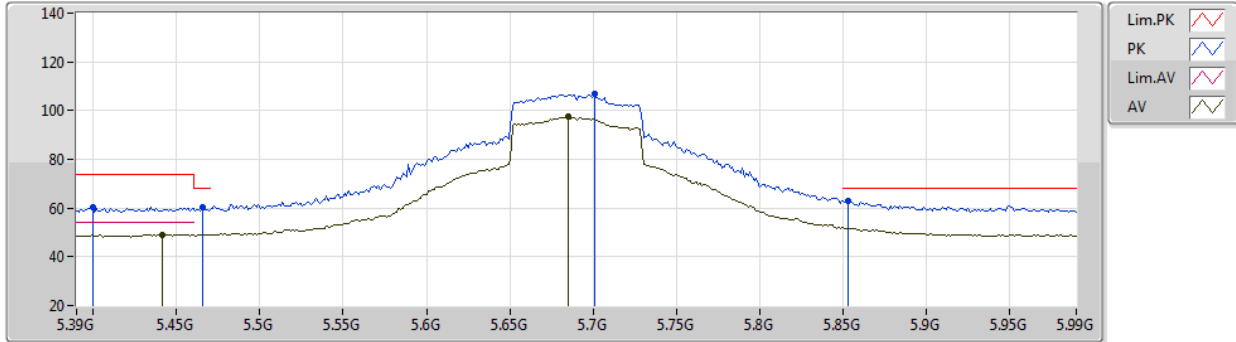

EUT X_1TX
Setting 23
02-D-B-2-10

Type	Freq (Hz)	Level (dBuV/m)	Limit (dBuV/m)	Margin (dB)	Raw (dBuV)	Dist (m)	Condition	Azimuth (°)	Height (m)	Comment	AF (dB)	CL (dB)	PA (dB)
PK	5.3996G	60.23	74.00	-13.77	50.70	3	Horizontal	34	1.00	-	33.90	6.10	30.47
PK	5.4656G	60.21	68.20	-7.99	50.64	3	Horizontal	34	1.00	-	33.90	6.17	30.50
AV	5.4416G	49.18	54.00	-4.82	39.62	3	Horizontal	34	1.00	-	33.90	6.15	30.49
PK	5.7008G	106.83	Inf	-Inf	97.24	3	Horizontal	34	1.00	-	33.80	6.35	30.56
AV	5.6852G	97.38	Inf	-Inf	87.77	3	Horizontal	34	1.00	-	33.83	6.34	30.56
PK	5.8532G	63.09	68.20	-5.11	53.41	3	Horizontal	34	1.00	-	33.91	6.37	30.60

802.11ac VHT80_Nss1,(MCS0)_1TX

24/03/2020

5690MHz Straddle 5.47-5.725GHz_TX

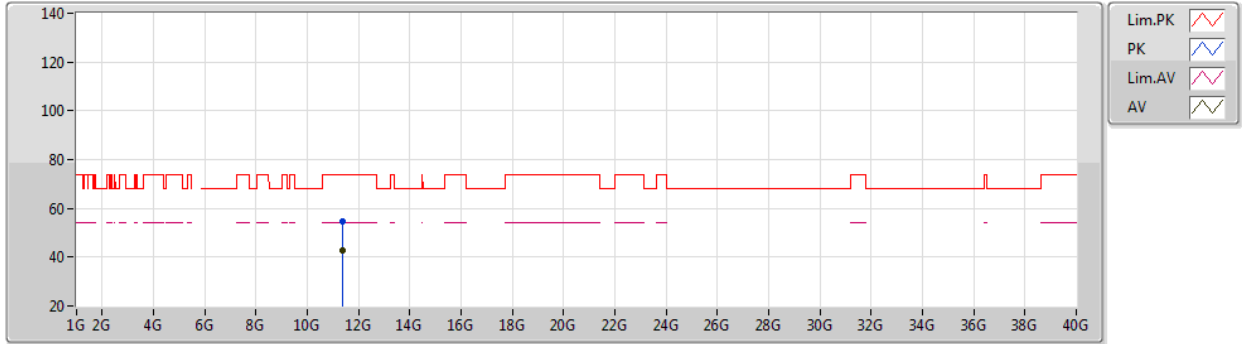

EUT X_1TX
Setting 23
02-D-B-2

Type	Freq (Hz)	Level (dBuV/m)	Limit (dBuV/m)	Margin (dB)	Raw (dBuV)	Dist (m)	Condition	Azimuth (°)	Height (m)	Comment	AF (dB)	CL (dB)	PA (dB)
PK	11.3842G	54.90	74.00	-19.10	38.94	3	Vertical	84	2.67	-	38.71	8.82	31.57
AV	11.38368G	42.92	54.00	-11.08	26.96	3	Vertical	84	2.67	-	38.71	8.82	31.57

802.11ac VHT80_Nss1,(MCS0)_1TX

24/03/2020

5690MHz Straddle 5.47-5.725GHz_TX

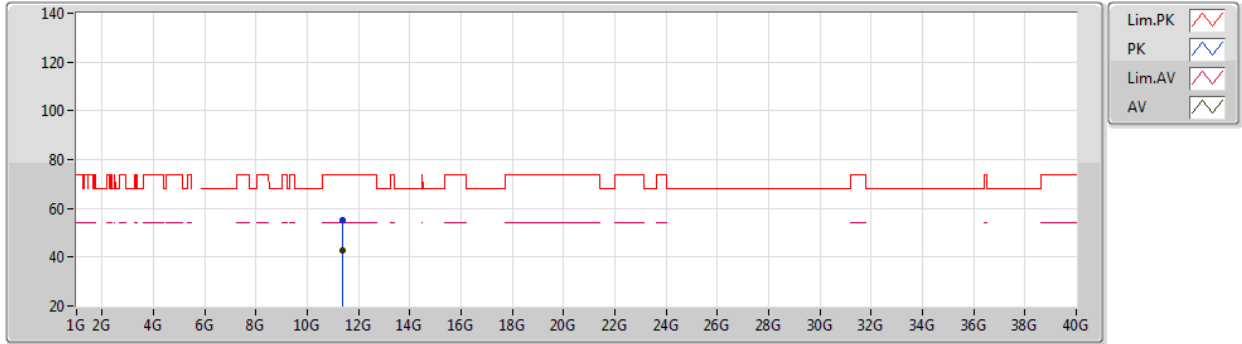

EUT X_1TX
Setting 23
02-D-B-2

Type	Freq (Hz)	Level (dBuV/m)	Limit (dBuV/m)	Margin (dB)	Raw (dBuV)	Dist (m)	Condition	Azimuth (°)	Height (m)	Comment	AF (dB)	CL (dB)	PA (dB)
PK	11.38372G	55.10	74.00	-18.90	39.14	3	Horizontal	179	2.80	-	38.71	8.82	31.57
AV	11.38044G	42.88	54.00	-11.12	26.93	3	Horizontal	179	2.80	-	38.70	8.82	31.57

802.11ac VHT80_Nss1,(MCS0)_1TX

24/03/2020

5775MHz_TX

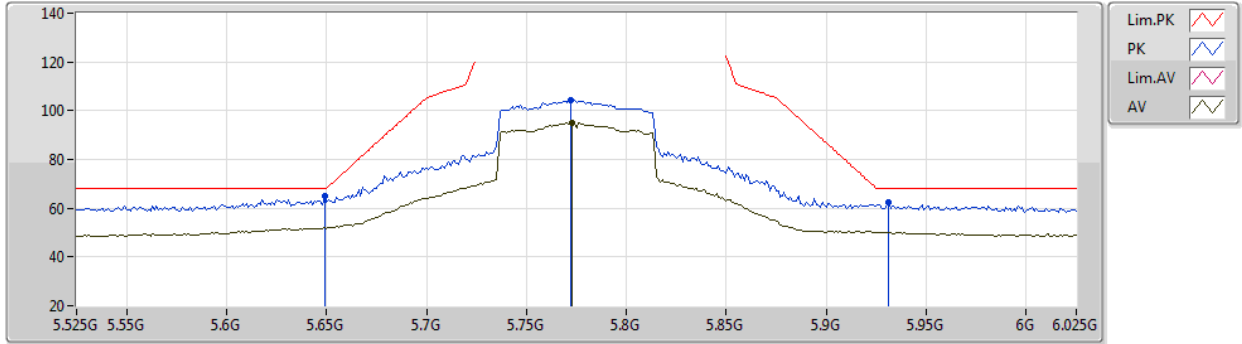

EUT X_1TX
Setting 17
02-D-B-2-10

Type	Freq (Hz)	Level (dBuV/m)	Limit (dBuV/m)	Margin (dB)	Raw (dBuV)	Dist (m)	Condition	Azimuth (°)	Height (m)	Comment	AF (dB)	CL (dB)	PA (dB)
PK	5.649G	64.96	68.20	-3.24	55.28	3	Vertical	339	2.04	-	33.90	6.32	30.54
PK	5.772G	104.41	Inf	-Inf	94.79	3	Vertical	339	2.04	-	33.80	6.39	30.57
AV	5.773G	95.18	Inf	-Inf	85.56	3	Vertical	339	2.04	-	33.80	6.39	30.57
PK	5.931G	62.28	68.20	-5.92	52.51	3	Vertical	339	2.04	-	34.06	6.33	30.62

802.11ac VHT80_Nss1,(MCS0)_1TX

24/03/2020

5775MHz_TX

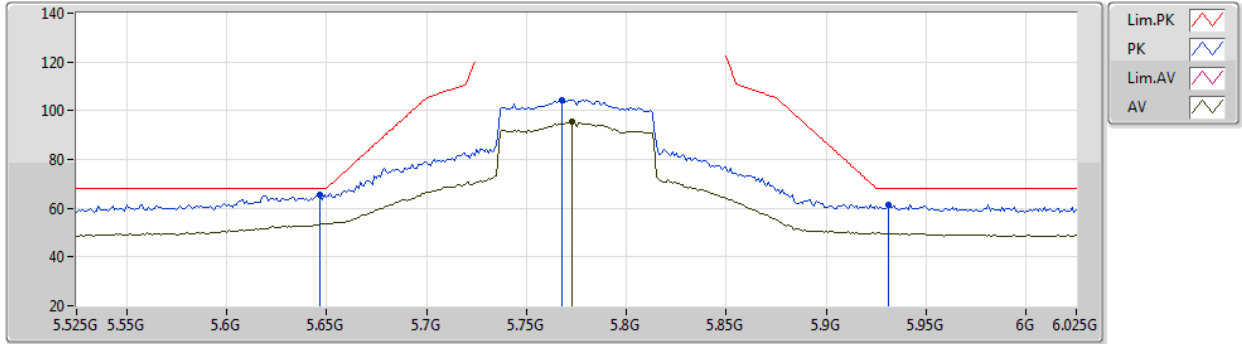

EUT X_1TX
Setting 17
02-D-B-2-10

Type	Freq (Hz)	Level (dBuV/m)	Limit (dBuV/m)	Margin (dB)	Raw (dBuV)	Dist (m)	Condition	Azimuth (°)	Height (m)	Comment	AF (dB)	CL (dB)	PA (dB)
PK	5.647G	65.61	68.20	-2.59	55.92	3	Horizontal	32	1.00	-	33.91	6.32	30.54
PK	5.768G	104.38	Inf	-Inf	94.77	3	Horizontal	32	1.00	-	33.80	6.38	30.57
AV	5.773G	95.28	Inf	-Inf	85.66	3	Horizontal	32	1.00	-	33.80	6.39	30.57
PK	5.931G	61.39	68.20	-6.81	51.62	3	Horizontal	32	1.00	-	34.06	6.33	30.62

802.11ac VHT80_Nss1,(MCS0)_1TX

24/03/2020

5775MHz_TX

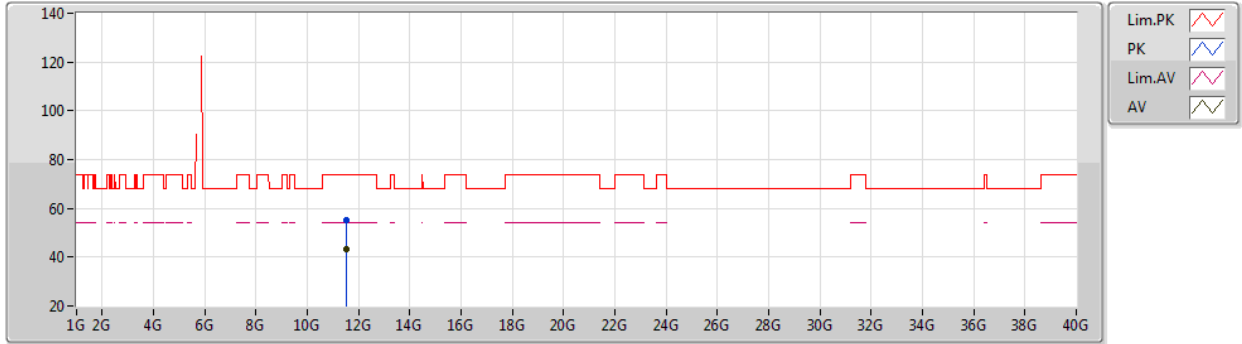

EUT X_1TX
Setting 17
02-D-B-2

Type	Freq (Hz)	Level (dBuV/m)	Limit (dBuV/m)	Margin (dB)	Raw (dBuV)	Dist (m)	Condition	Azimuth (°)	Height (m)	Comment	AF (dB)	CL (dB)	PA (dB)
PK	11.54568G	55.34	74.00	-18.66	39.25	3	Vertical	161	1.34	-	38.84	8.87	31.62
AV	11.5467G	43.21	54.00	-10.79	27.12	3	Vertical	161	1.34	-	38.84	8.87	31.62

802.11ac VHT80_Nss1,(MCS0)_1TX

24/03/2020

5775MHz_TX

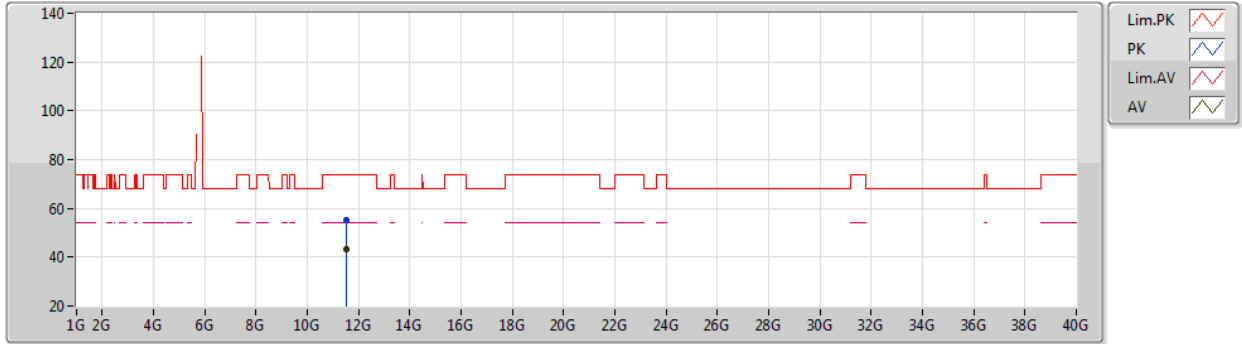

EUT X_1TX
Setting 17
02-D-B-2

Type	Freq (Hz)	Level (dBuV/m)	Limit (dBuV/m)	Margin (dB)	Raw (dBuV)	Dist (m)	Condition	Azimuth (°)	Height (m)	Comment	AF (dB)	CL (dB)	PA (dB)
PK	11.54826G	55.14	74.00	-18.86	39.05	3	Horizontal	60	1.95	-	38.84	8.87	31.62
AV	11.54826G	43.05	54.00	-10.95	26.96	3	Horizontal	60	1.95	-	38.84	8.87	31.62

