

FCC Test Report

Report No.: RF190527E01-1

FCC ID: TLZ-CM382

Test Model: AW-CM382

Received Date: May 27, 2019

Test Date: June 06 to 21, 2019

Issued Date: July 10, 2019

Applicant: AzureWave Technologies, Inc.

Address: 8F., No.94, Baozhong Rd. , Xindian Dist., New Taipei City , Taiwan 231

Issued By: Bureau Veritas Consumer Products Services (H.K.) Ltd., Taoyuan Branch
Hsin Chu Laboratory

Lab Address: E-2, No.1, Li Hsin 1st Road, Hsinchu Science Park, Hsinchu City 300,
Taiwan R.O.C.

Test Location: E-2, No.1, Li Hsin 1st Road, Hsinchu Science Park, Hsinchu City 300,
Taiwan R.O.C.

**FCC Registration /
Designation Number:** 723255 / TW2022



This report is for your exclusive use. Any copying or replication of this report to or for any other person or entity, or use of our name or trademark, is permitted only with our prior written permission. This report sets forth our findings solely with respect to the test samples identified herein. The results set forth in this report are not indicative or representative of the quality or characteristics of the lot from which a test sample was taken or any similar or identical product unless specifically and expressly noted. Our report includes all of the tests requested by you and the results thereof based upon the information that you provided to us. You have 60 days from date of issuance of this report to notify us of any material error or omission caused by our negligence, provided, however, that such notice shall be in writing and shall specifically address the issue you wish to raise. A failure to raise such issue within the prescribed time shall constitute your unqualified acceptance of the completeness of this report, the tests conducted and the correctness of the report contents. Unless specific mention, the uncertainty of measurement has been explicitly taken into account to declare the compliance or non-compliance to the specification. The report must not be used by the client to claim product certification, approval, or endorsement by TAF or any government agencies.

Table of Contents

Release Control Record	4
1 Certificate of Conformity	5
2 Summary of Test Results	6
2.1 Measurement Uncertainty	6
2.2 Modification Record	6
3 General Information	7
3.1 General Description of EUT	7
3.2 Description of Test Modes	9
3.2.1 Test Mode Applicability and Tested Channel Detail	11
3.3 Duty Cycle of Test Signal	13
3.4 Description of Support Units	14
3.4.1 Configuration of System under Test	14
3.5 General Description of Applied Standard	15
4 Test Types and Results	16
4.1 Radiated Emission and Bandedge Measurement	16
4.1.1 Limits of Radiated Emission and Bandedge Measurement	16
4.1.2 Test Instruments	17
4.1.3 Test Procedure	19
4.1.4 Deviation from Test Standard	20
4.1.5 Test Setup	20
4.1.6 EUT Operating Condition	21
4.1.7 Test Results	22
4.2 Conducted Emission Measurement	62
4.2.1 Limits of Conducted Emission Measurement	62
4.2.2 Test Instruments	62
4.2.3 Test Procedure	63
4.2.4 Deviation from Test Standard	63
4.2.5 Test Setup	63
4.2.6 EUT Operating Condition	63
4.2.7 Test Results	64
4.3 Transmit Power Measurement	66
4.3.1 Limits of Transmit Power Measurement	66
4.3.2 Test Setup	66
4.3.3 Test Instruments	66
4.3.4 Test Procedure	67
4.3.5 Deviation from Test Standard	67
4.3.6 EUT Operating Condition	67
4.3.7 Test Result	68
4.4 Occupied Bandwidth Measurement	73
4.4.1 Test Setup	73
4.4.2 Test Instruments	73
4.4.3 Test Procedure	73
4.4.4 Test Results	74
4.5 Peak Power Spectral Density Measurement	79
4.5.1 Limits of Peak Power Spectral Density Measurement	79
4.5.2 Test Setup	79
4.5.3 Test Instruments	79
4.5.4 Test Procedure	79
4.5.5 Deviation from Test Standard	80
4.5.6 EUT Operating Condition	80
4.5.7 Test Results	81
4.6 Frequency Stability Measurement	86
4.6.1 Limits of Frequency Stability Measurement	86

4.6.2	Test Setup.....	86
4.6.3	Test Instruments	86
4.6.4	Test Procedure	86
4.6.5	Deviation from Test Standard	86
4.6.6	EUT Operating Condition	86
4.6.7	Test Results	87
4.7	6dB Bandwidth Measurement	88
4.7.1	Limits of 6dB Bandwidth Measurement.....	88
4.7.2	Test Setup.....	88
4.7.3	Test Instruments	88
4.7.4	Test Procedure	88
4.7.5	Deviation from Test Standard	88
4.7.6	EUT Operating Condition	88
4.7.7	Test Results	89
5	Pictures of Test Arrangements.....	91
	Annex A- Radiated Out of Band Emission (OOBE) Measurement (For U-NII-3 band).....	92
	Appendix – Information of the Testing Laboratories	95

Release Control Record

Issue No.	Description	Date Issued
RF190527E01-1	Original release.	July 10, 2019

1 Certificate of Conformity

Product: IEEE 802.11 a/b/g/n/ac MAC/baseband/radio and Bluetooth 5.0 Module

Brand: AzureWave

Test Model: AW-CM382

Sample Status: ENGINEERING SAMPLE

Applicant: AzureWave Technologies, Inc.

Test Date: June 06 to 21, 2019

Standard: 47 CFR FCC Part 15, Subpart E (Section 15.407)
ANSI C63.10: 2013

The above equipment has been tested by **Bureau Veritas Consumer Products Services (H.K.) Ltd., Taoyuan Branch**, and found compliance with the requirement of the above standards. The test record, data evaluation & Equipment Under Test (EUT) configurations represented herein are true and accurate accounts of the measurements of the sample's EMC characteristics under the conditions specified in this report.

Prepared by : Wendy Wu , **Date:** July 10, 2019
Wendy Wu / Specialist

Approved by : May Chen , **Date:** July 10, 2019
May Chen / Manager

2 Summary of Test Results

47 CFR FCC Part 15, Subpart E (Section 15.407)			
FCC Clause	Test Item	Result	Remarks
15.407(b)(6)	AC Power Conducted Emissions	Pass	Meet the requirement of limit. Minimum passing margin is -7.74dB at 0.48984MHz.
15.407(b) (1/2/3/4(i/ii)/6)	Radiated Emissions & Band Edge Measurement*	Pass	Meet the requirement of limit. Minimum passing margin is -0.3dB at 5150.00MHz.
15.407(a)(1/2/3)	Max Average Transmit Power	Pass	Meet the requirement of limit.
---	Occupied Bandwidth Measurement	-	Reference only.
15.407(a)(1/2/3)	Peak Power Spectral Density	Pass	Meet the requirement of limit.
15.407(e)	6dB bandwidth	Pass	Meet the requirement of limit. (U-NII-3 Band only)
15.407(g)	Frequency Stability	Pass	Meet the requirement of limit.
15.203	Antenna Requirement	Pass	No antenna connector is used.

*For U-NII-3 band compliance with rule part 15.407(b)(4)(i), the OOB test plots were recorded in Annex A.

Note:

Determining compliance based on the results of the compliance measurement, not taking into account measurement instrumentation uncertainty.

2.1 Measurement Uncertainty

Where relevant, the following measurement uncertainty levels have been estimated for tests performed on the EUT as specified in CISPR 16-4-2:

Measurement	Frequency	Expanded Uncertainty (k=2) (±)
Conducted Emissions at mains ports	150kHz ~ 30MHz	1.8 dB
Radiated Emissions up to 1 GHz	30MHz ~ 1GHz	4.9 dB
Radiated Emissions above 1 GHz	1GHz ~ 6GHz	5.1 dB
	6GHz ~ 18GHz	4.9 dB
	18GHz ~ 40GHz	5.2 dB

2.2 Modification Record

There were no modifications required for compliance.

3 General Information

3.1 General Description of EUT

Product	IEEE 802.11 a/b/g/n/ac MAC/baseband/radio and Bluetooth 5.0 Module
Brand	AzureWave
Test Model	AW-CM382
Status of EUT	ENGINEERING SAMPLE
Power Supply Rating	5Vdc from host equipment
Modulation Type	CCK, DQPSK, DBPSK for DSSS 64QAM, 16QAM, QPSK, BPSK for OFDM 256QAM for OFDM in 11ac mode only
Modulation Technology	DSSS, OFDM
Transfer Rate	802.11b: up to 11Mbps 802.11a/g: up to 54Mbps 802.11n: up to 150Mbps 802.11ac: up to 433.3Mbps
Operating Frequency	2.4GHz: 2.412 ~ 2.462GHz 5GHz: 5.18 ~ 5.24GHz, 5.26 ~ 5.32GHz, 5.50 ~ 5.70GHz, 5.745 ~ 5.825GHz
Number of Channel	2.4GHz: 802.11b, 802.11g, 802.11n (HT20): 11 802.11n (HT40): 7 5GHz: 802.11a, 802.11n (HT20), 802.11ac (VHT20): 24 802.11n (HT40), 802.11ac (VHT40): 11 802.11ac (VHT80): 5
Output Power	2.4GHz: 301.301 mW 5.18 ~ 5.24GHz: 77.625 mW 5.26 ~ 5.32GHz: 82.035 mW 5.50 ~ 5.70GHz: 76.384 mW 5.745 ~ 5.825GHz: 81.846 mW
Antenna Type	Refer to Note
Antenna Connector	Refer to Note
Accessory Device	NA
Data Cable Supplied	NA

Note:

1. The device of WLAN and Bluetooth technology can't transmit simultaneously, it was used timely shared coexistence technology.
2. The EUT incorporates a SISO function.

2.4GHz Band		
Modulation Mode	TX & RX Configuration	
802.11b	1TX Diversity	1RX
802.11g	1TX Diversity	1RX
802.11n (HT20)	1TX Diversity	1RX
802.11n (HT40)	1TX Diversity	1RX
5GHz Band		
Modulation Mode	TX & RX Configuration	
802.11a	1TX Diversity	1RX
802.11n (HT20)	1TX Diversity	1RX
802.11n (HT40)	1TX Diversity	1RX
802.11ac (VHT20)	1TX Diversity	1RX
802.11ac (VHT40)	1TX Diversity	1RX
802.11ac (VHT80)	1TX Diversity	1RX

Note: The modulation and bandwidth are similar for 802.11n mode for 20MHz (40MHz) and 802.11ac mode for 20MHz (40MHz), therefore investigated worst case to representative mode in test report.

3. The antennas provided to the EUT, please refer to the following table:

Ant. Set	Transmitter Circuit	Antenna Gain (dBi)	Frequency range (GHz ~ GHz)	Antenna Type	Connector Type
1	Chain 0 (Main)	1	2.4~2.4835	PIFA	None
		6	5.15~5.85		
	Chain 1 (Aux)	1	2.4~2.4835	PIFA	None
		6	5.15~5.85		

Note:

1. From the above Chain 0 and Chain 1 port, The worse case was found in Chain 0. Therefore only the test data of the mode was recorded in this report.
2. For Bluetooth will fix transmission on Chain 0.
4. The above EUT information is declared by manufacturer and for more detailed features description, please refers to the manufacturer's specifications or user's manual.

3.2 Description of Test Modes

FOR 5180 ~ 5240MHz

4 channels are provided for 802.11a, 802.11n (HT20), 802.11ac (VHT20):

Channel	Frequency	Channel	Frequency
36	5180 MHz	44	5220 MHz
40	5200 MHz	48	5240 MHz

2 channels are provided for 802.11n (HT40), 802.11ac (VHT40):

Channel	Frequency	Channel	Frequency
38	5190 MHz	46	5230 MHz

1 channel is provided for 802.11ac (VHT80):

Channel	Frequency
42	5210MHz

FOR 5260 ~ 5320MHz

4 channels are provided for 802.11a, 802.11n (HT20), 802.11ac (VHT20):

Channel	Frequency	Channel	Frequency
52	5260 MHz	60	5300 MHz
56	5280 MHz	64	5320 MHz

2 channels are provided for 802.11n (HT40), 802.11ac (VHT40):

Channel	Frequency	Channel	Frequency
54	5270 MHz	62	5310 MHz

1 channel is provided for 802.11ac (VHT80):

Channel	Frequency
58	5290MHz

FOR 5500 ~ 5700MHz

11 channels are provided for 802.11a, 802.11n (HT20), 802.11ac (VHT20):

Channel	Frequency	Channel	Frequency
100	5500 MHz	124	5620 MHz
104	5520 MHz	128	5640 MHz
108	5540 MHz	132	5660 MHz
112	5560 MHz	136	5680 MHz
116	5580 MHz	140	5700 MHz
120	5600 MHz		

5 channels are provided for 802.11n (HT40), 802.11ac (VHT40):

Channel	Frequency	Channel	Frequency
102	5510 MHz	126	5630 MHz
110	5550 MHz	134	5670 MHz
118	5590 MHz		

2 channels are provided for 802.11ac (VHT80):

Channel	Frequency	Channel	Frequency
106	5530MHz	122	5610 MHz

FOR 5745 ~ 5825MHz:

5 channels are provided for 802.11a, 802.11n (HT20), 802.11ac (VHT20):

Channel	Frequency	Channel	Frequency
149	5745MHz	161	5805MHz
153	5765MHz	165	5825MHz
157	5785MHz		

2 channels are provided for 802.11n (HT40), 802.11ac (VHT40):

Channel	Frequency	Channel	Frequency
151	5755MHz	159	5795MHz

1 channel is provided for 802.11ac (VHT80):

Channel	Frequency
155	5775MHz

3.2.1 Test Mode Applicability and Tested Channel Detail

EUT Configure Mode	Applicable To				Description
	RE \geq 1G	RE $<$ 1G	PLC	APCM	
-	√	√	√	√	-

Where **RE \geq 1G**: Radiated Emission above 1GHz

RE $<$ 1G: Radiated Emission below 1GHz

PLC: Power Line Conducted Emission

APCM: Antenna Port Conducted Measurement

NOTE: The EUT had been pre-tested on the positioned of each 3 axis. The worst case was found when positioned on **X-plane (below 1GHz) & Z-plane (above 1GHz)**.

Radiated Emission Test (Above 1GHz):

- Pre-Scan has been conducted to determine the worst-case mode from all possible combinations between available modulations, data rates and antenna ports (if EUT with antenna diversity architecture).
- Following channel(s) was (were) selected for the final test as listed below.

Mode	FREQ. Band (MHz)	Available Channel	Tested Channel	Modulation Technology	Modulation Type	Data Rate (Mbps)
802.11a	5180-5240	36 to 48	36, 40, 48	OFDM	BPSK	6
802.11ac (VHT20)		36 to 48	36, 40, 48	OFDM	BPSK	6.5
802.11ac (VHT40)		38 to 46	38, 46	OFDM	BPSK	13.5
802.11ac (VHT80)		42	42	OFDM	BPSK	29.3
802.11a	5260-5320	52 to 64	52, 60, 64	OFDM	BPSK	6
802.11ac (VHT20)		52 to 64	52, 60, 64	OFDM	BPSK	6.5
802.11ac (VHT40)		54 to 62	54, 62	OFDM	BPSK	13.5
802.11ac (VHT80)		58	58	OFDM	BPSK	29.3
802.11a	5500-5700	100 to 140	100, 116, 140	OFDM	BPSK	6
802.11ac (VHT20)		100 to 140	100, 116, 140	OFDM	BPSK	6.5
802.11ac (VHT40)		102 to 134	102, 110, 134	OFDM	BPSK	13.5
802.11ac (VHT80)		106 to 122	106, 122	OFDM	BPSK	29.3
802.11a	5745-5825	149 to 165	149, 157, 165	OFDM	BPSK	6
802.11ac (VHT20)		149 to 165	149, 157, 165	OFDM	BPSK	6.5
802.11ac (VHT40)		151 to 159	151, 159	OFDM	BPSK	13.5
802.11ac (VHT80)		155	155	OFDM	BPSK	29.3

Radiated Emission Test (Below 1GHz):

- Pre-Scan has been conducted to determine the worst-case mode from all possible combinations between available modulations, data rates and antenna ports (if EUT with antenna diversity architecture).
- Following channel(s) was (were) selected for the final test as listed below.

Mode	FREQ. Band (MHz)	Available Channel	Tested Channel	Modulation Technology	Modulation Type	Data Rate (Mbps)
802.11ac (VHT40)	5180-5240	38 to 46	54	OFDM	BPSK	13.5
	5260-5320	54 to 62				
	5500-5700	102 to 134				
	5745-5825	151 to 159				

Power Line Conducted Emission Test:

- Pre-Scan has been conducted to determine the worst-case mode from all possible combinations between available modulations, data rates and antenna ports (if EUT with antenna diversity architecture).
- Following channel(s) was (were) selected for the final test as listed below.

Mode	FREQ. Band (MHz)	Available Channel	Tested Channel	Modulation Technology	Modulation Type	Data Rate (Mbps)
802.11ac (VHT40)	5180-5240	38 to 46	54	OFDM	BPSK	13.5
	5260-5320	54 to 62				
	5500-5700	102 to 134				
	5745-5825	151 to 159				

Antenna Port Conducted Measurement:

- This item includes all test value of each mode, but only includes spectrum plot of worst value of each mode.
- Pre-Scan has been conducted to determine the worst-case mode from all possible combinations between available modulations, data rates and antenna ports (if EUT with antenna diversity architecture).
- Following channel(s) was (were) selected for the final test as listed below.

Mode	FREQ. Band (MHz)	Available Channel	Tested Channel	Modulation Technology	Modulation Type	Data Rate (Mbps)
802.11a	5180-5240	36 to 48	36, 40, 48	OFDM	BPSK	6
802.11ac (VHT20)		36 to 48	36, 40, 48	OFDM	BPSK	6.5
802.11ac (VHT40)		38 to 46	38, 46	OFDM	BPSK	13.5
802.11ac (VHT80)		42	42	OFDM	BPSK	29.3
802.11a	5260-5320	52 to 64	52, 60, 64	OFDM	BPSK	6
802.11ac (VHT20)		52 to 64	52, 60, 64	OFDM	BPSK	6.5
802.11ac (VHT40)		54 to 62	54, 62	OFDM	BPSK	13.5
802.11ac (VHT80)		58	58	OFDM	BPSK	29.3
802.11a	5500-5700	100 to 140	100, 116, 140	OFDM	BPSK	6
802.11ac (VHT20)		100 to 140	100, 116, 140	OFDM	BPSK	6.5
802.11ac (VHT40)		102 to 134	102, 110, 134	OFDM	BPSK	13.5
802.11ac (VHT80)		106 to 122	106, 122	OFDM	BPSK	29.3
802.11a	5745-5825	149 to 165	149, 157, 165	OFDM	BPSK	6
802.11ac (VHT20)		149 to 165	149, 157, 165	OFDM	BPSK	6.5
802.11ac (VHT40)		151 to 159	151, 159	OFDM	BPSK	13.5
802.11ac (VHT80)		155	155	OFDM	BPSK	29.3

Test Condition:

APPLICABLE TO	ENVIRONMENTAL CONDITIONS	INPUT POWER (System)	TESTED BY
RE \geq 1G	20deg. C, 69%RH	120Vac, 60Hz	Adair Peng
RE $<$ 1G	20deg. C, 64%RH	120Vac, 60Hz	Ryan Du
PLC	23deg. C, 75%RH	120Vac, 60Hz	Andy Ho
APCM	23deg. C, 67%RH	120Vac, 60Hz	Jyunchun Lin

3.3 Duty Cycle of Test Signal

Duty cycle of test signal is < 98 %, duty factor shall be considered.

802.11a: Duty cycle = 0.727 ms/1.029 ms = 0.707, Duty factor = $10 * \log(1/\text{Duty cycle}) = 1.51$

802.11ac (VHT20): Duty cycle = 0.698 ms/1.001 ms = 0.697, Duty factor = $10 * \log(1/\text{Duty cycle}) = 1.57$

802.11ac (VHT40): Duty cycle = 0.36 ms/0.66 ms = 0.545, Duty factor = $10 * \log(1/\text{Duty cycle}) = 2.63$

802.11ac (VHT80): Duty cycle = 0.189ms/0.489 ms = 0.387, Duty factor = $10 * \log(1/\text{Duty cycle}) = 4.13$

802.11a

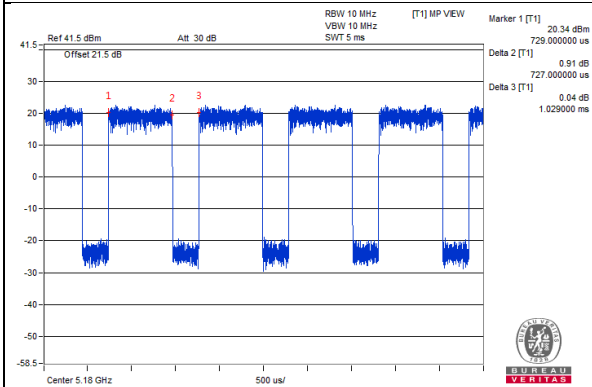

802.11ac (VHT20)

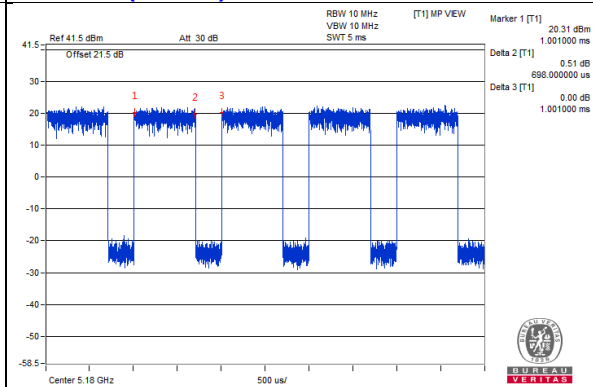

802.11ac (VHT40)

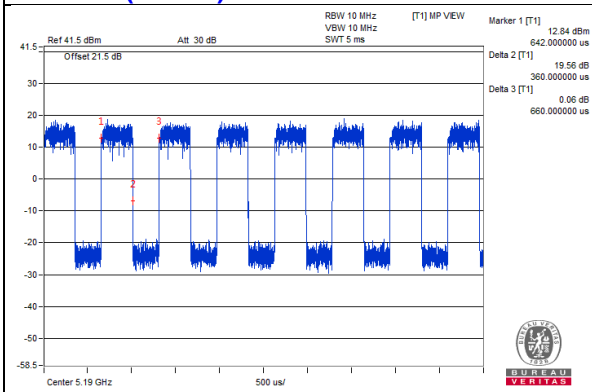

802.11ac (VHT80)

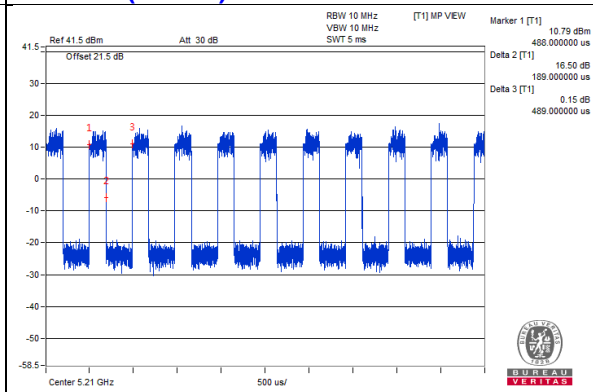

3.4 Description of Support Units

The EUT has been tested as an independent unit together with other necessary accessories or support units. The following support units or accessories were used to form a representative test configuration during the tests.

ID	Product	Brand	Model No.	Serial No.	FCC ID	Remarks
A.	Test Tool	AzureWave	NA	NA	NA	Supplied by client
B.	PC	lenovo	NA	NA	NA	Provided by Lab
C.	Monitor	Panasonic	TH-L26K10W	9540684	NA	Provided by Lab
D.	Keyboard	SGI	SK-2502U	M990511754	GYUR58SK	Provided by Lab
E.	Mouse	DEXIN	A2U800A	71001832	NIYA2U800A	Provided by Lab

Note:

1. All power cords of the above support units are non-shielded (1.8m).

ID	Descriptions	Qty.	Length (m)	Shielding (Yes/No)	Cores (Qty.)	Remarks
1.	USB Cable	1	1.7	Yes	0	Provided by Lab
2.	VGA Cable	1	1.8	Yes	2	Provided by Lab
3.	USB Cable	1	1.5	Yes	0	Provided by Lab
4.	USB Cable	1	1.8	Yes	0	Provided by Lab

3.4.1 Configuration of System under Test

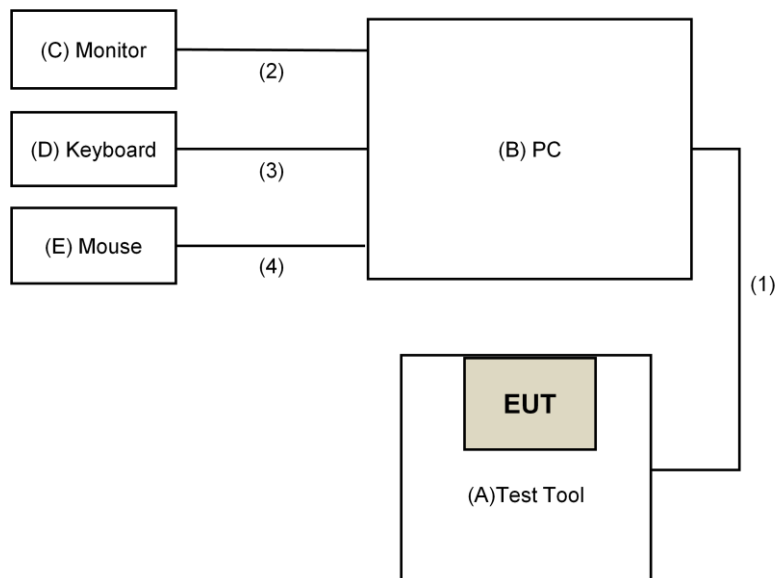

3.5 General Description of Applied Standard

The EUT is a RF Product. According to the specifications of the manufacturer, it must comply with the requirements of the following standards:

FCC Part 15, Subpart E (15.407)
KDB 789033 D02 General UNII Test Procedure New Rules v02r01
ANSI C63.10-2013

All test items have been performed and recorded as per the above standards.

4 Test Types and Results

4.1 Radiated Emission and Bandedge Measurement

4.1.1 Limits of Radiated Emission and Bandedge Measurement

Radiated emissions which fall in the restricted bands must comply with the radiated emission limits specified as below table.

Frequencies (MHz)	Field Strength (microvolts/meter)	Measurement Distance (meters)
0.009 ~ 0.490	2400/F(kHz)	300
0.490 ~ 1.705	24000/F(kHz)	30
1.705 ~ 30.0	30	30
30 ~ 88	100	3
88 ~ 216	150	3
216 ~ 960	200	3
Above 960	500	3

NOTE:

1. The lower limit shall apply at the transition frequencies.
2. Emission level (dBuV/m) = 20 log Emission level (uV/m).
3. For frequencies above 1000MHz, the field strength limits are based on average detector, however, the peak field strength of any emission shall not exceed the maximum permitted average limits, specified above by more than 20dB under any condition of modulation.

Limits of unwanted emission out of the restricted bands

Applicable To		Limit	
789033 D02 General UNII Test Procedure New Rules v02r01		Field Strength at 3m	
		PK:74 (dBuV/m)	AV:54 (dBuV/m)
Frequency Band	Applicable To	EIRP Limit	Equivalent Field Strength at 3m
5150~5250 MHz	15.407(b)(1)	PK:-27 (dBm/MHz)	PK:68.2(dBuV/m)
5250~5350 MHz	15.407(b)(2)		
5470~5725 MHz	15.407(b)(3)		
5725~5850 MHz	<input checked="" type="checkbox"/> 15.407(b)(4)(i)	PK:-27 (dBm/MHz) ^{*1} PK:10 (dBm/MHz) ^{*2} PK:15.6 (dBm/MHz) ^{*3} PK:27 (dBm/MHz) ^{*4}	PK: 68.2(dBuV/m) ^{*1} PK:105.2 (dBuV/m) ^{*2} PK: 110.8(dBuV/m) ^{*3} PK:122.2 (dBuV/m) ^{*4}
	<input type="checkbox"/> 15.407(b)(4)(ii)	Emission limits in section 15.247(d)	
^{*1} beyond 75 MHz or more above of the band edge.		^{*2} below the band edge increasing linearly to 10 dBm/MHz at 25 MHz above.	
^{*3} below the band edge increasing linearly to a level of 15.6 dBm/MHz at 5 MHz above.		^{*4} from 5 MHz above or below the band edge increasing linearly to a level of 27 dBm/MHz at the band edge.	

Note:

The following formula is used to convert the equipment isotropic radiated power (eirp) to field strength:

$$E = \frac{1000000\sqrt{30P}}{3} \mu\text{V/m, where } P \text{ is the eirp (Watts).}$$

4.1.2 Test Instruments

For Radiated Emission test:

DESCRIPTION & MANUFACTURER	MODEL NO.	SERIAL NO.	CALIBRATED DATE	CALIBRATED UNTIL
Test Receiver Keysight	N9038A	MY54450088	July 05, 2018	July 04, 2019
Pre-Amplifier EMCI	EMC001340	980142	Jan. 25, 2019	Jan. 24, 2020
Loop Antenna Electro-Metrics	EM-6879	269	Sep. 07, 2018	Sep. 06, 2019
RF Cable	NA	LOOPCAB-001	Jan. 14, 2019	Jan. 13, 2020
RF Cable	NA	LOOPCAB-002	Jan. 14, 2019	Jan. 13, 2020
Pre-Amplifier Mini-Circuits	ZFL-1000VH2B	AMP-ZFL-01	Oct. 30, 2018	Oct. 29, 2019
Trilog Broadband Antenna SCHWARZBECK	VULB 9168	9168-406	Nov. 22, 2018	Nov. 21, 2019
RF Cable	8D	966-4-1	Mar. 19, 2019	Mar. 18, 2020
RF Cable	8D	966-4-2	Mar. 19, 2019	Mar. 18, 2020
RF Cable	8D	966-4-3	Mar. 19, 2019	Mar. 18, 2020
Fixed attenuator Mini-Circuits	UNAT-5+	PAD-3m-4-01	Sep. 27, 2018	Sep. 26, 2019
Horn_Antenna SCHWARZBECK	BBHA 9120D	9120D-783	Nov. 25, 2018	Nov. 24, 2019
Pre-Amplifier EMCI	EMC12630SE	980385	Aug. 16, 2018	Aug. 15, 2019
RF Cable	EMC104-SM-SM-1200	160923	Jan. 28, 2019	Jan. 27, 2020
RF Cable	104 RF cable	131215	Jan. 10, 2019	Jan. 09, 2020
RF Cable	EMC104-SM-SM-6000	180418	May 03, 2019	May 02, 2020
Pre-Amplifier EMCI	EMC184045SE	980387	Jan. 28, 2019	Jan. 27, 2020
Horn_Antenna SCHWARZBECK	BBHA 9170	BBHA9170519	Nov. 25, 2018	Nov. 24, 2019
RF Cable	EMC102-KM-KM-1200	160924	Jan. 28, 2019	Jan. 27, 2020
RF Cable	EMC102-KM-KM-1200	160925	Jan. 28, 2019	Jan. 27, 2020
Software	ADT_Radiated_V8.7.08	NA	NA	NA
Boresight Antenna Tower & Turn Table Max-Full	MF-7802BS	MF780208530	NA	NA

Note:

1. The calibration interval of the above test instruments is 12 months and the calibrations are traceable to NML/ROC and NIST/USA.
2. The test was performed in 966 Chamber No. 4.
3. Loop antenna was used for all emissions below 30 MHz.
4. Tested Date: June 06 to 21, 2019

For other test:

DESCRIPTION & MANUFACTURER	MODEL NO.	SERIAL NO.	CALIBRATED DATE	CALIBRATED UNTIL
Spectrum Analyzer R&S	FSV40	100964	June 20, 2018	June 19, 2019
Power meter Anritsu	ML2495A	1014008	May 13, 2019	May 12, 2020
Power sensor Anritsu	MA2411B	0917122	May 13, 2019	May 12, 2020
DC Power Supply Topward	6603D	795558	NA	NA
Temperature & Humidity Chamber Giant Force	GTH-150-40-SP- AR	MAA0812-008	Jan. 09, 2019	Jan. 08, 2020
True RMS Clamp Meter FLUKE	325	31130711WS	May 21, 2019	May 20, 2020

- NOTE:**
1. The test was performed in Oven room 2.
 2. The calibration interval of the above test instruments is 12 months and the calibrations are traceable to NML/ROC and NIST/USA.
 3. Tested Date: June 11, 2019

4.1.3 Test Procedure

For Radiated emission below 30MHz

- a. The EUT was placed on the top of a rotating table 0.8 meters above the ground at a 3 meter chamber room. The table was rotated 360 degrees to determine the position of the highest radiation.
- b. The EUT was set 3 meters away from the interference-receiving antenna, which was mounted on the top of a variable-height antenna tower.
- c. Parallel, perpendicular, and ground-parallel orientations of the antenna are set to make the measurement.
- d. For each suspected emission, the EUT was arranged to its worst case and the rotatable table was turned from 0 degrees to 360 degrees to find the maximum reading.
- e. The test-receiver system was set to Quasi-Peak Detect Function and Specified Bandwidth with Maximum Hold Mode.

NOTE:

1. The resolution bandwidth and video bandwidth of test receiver/spectrum analyzer is 9kHz at frequency below 30MHz.

For Radiated emission above 30MHz

- a. The EUT was placed on the top of a rotating table 0.8 meters (for 30MHz ~ 1GHz) / 1.5 meters (for above 1GHz) above the ground at 3 meter chamber room for test. The table was rotated 360 degrees to determine the position of the highest radiation.
- b. The EUT was set 3 meters away from the interference-receiving antenna, which was mounted on the top of a variable-height antenna tower.
- c. The height of antenna is varied from one meter to four meters above the ground to determine the maximum value of the field strength. Both horizontal and vertical polarizations of the antenna are set to make the measurement.
- d. For each suspected emission, the EUT was arranged to its worst case and then the antenna was tuned to heights from 1 meter to 4 meters and the rotatable table was turned from 0 degrees to 360 degrees to find the maximum reading.
- e. The test-receiver system was set to quasi-peak detect function and specified bandwidth with maximum hold mode when the test frequency is below 1 GHz.
- f. The test-receiver system was set to peak and average detects function and specified bandwidth with maximum hold mode when the test frequency is above 1 GHz. If the peak reading value also meets average limit, measurement with the average detector is unnecessary.

Note:

1. The resolution bandwidth and video bandwidth of test receiver/spectrum analyzer is 120kHz for Quasi-peak detection (QP) at frequency below 1GHz.
2. The resolution bandwidth of test receiver/spectrum analyzer is 1 MHz and the video bandwidth is 3 MHz for Peak detection (PK) at frequency above 1GHz.
3. The resolution bandwidth of test receiver/spectrum analyzer is 1MHz and the video bandwidth is $\geq 1/T$ (Duty cycle < 98%) or 10Hz (Duty cycle $\geq 98\%$) for Average detection (AV) at frequency above 1GHz.
4. All modes of operation were investigated and the worst-case emissions are reported.

4.1.4 Deviation from Test Standard

No deviation.

4.1.5 Test Setup

For Radiated emission below 30MHz

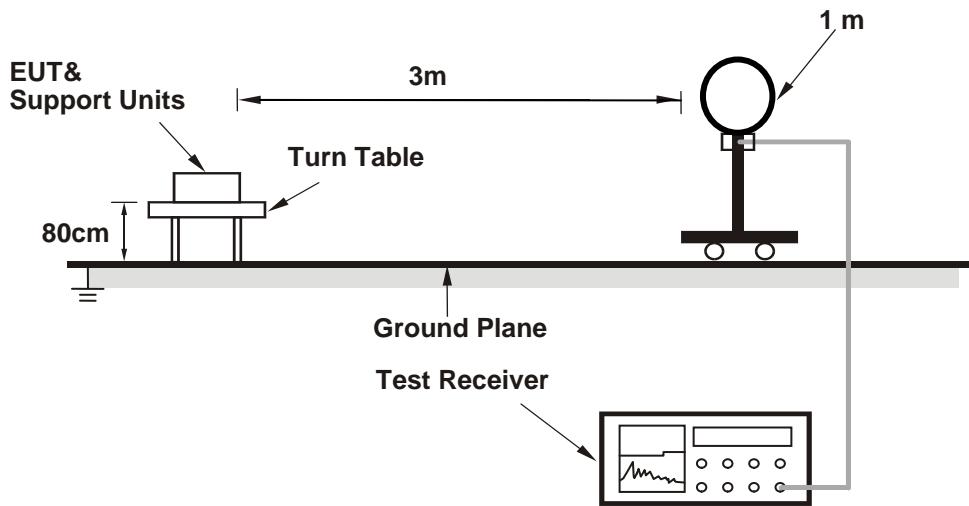

For Radiated emission 30MHz to 1GHz

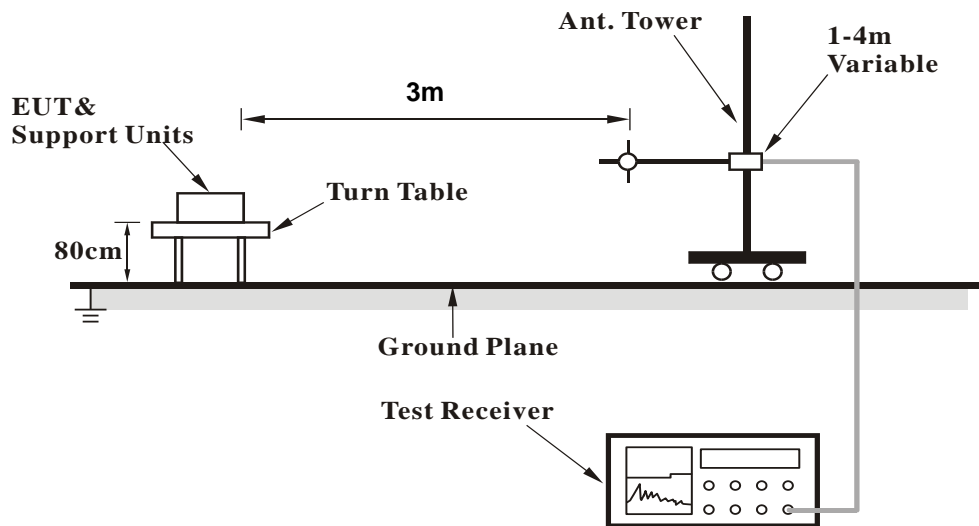

For Radiated emission above 1GHz

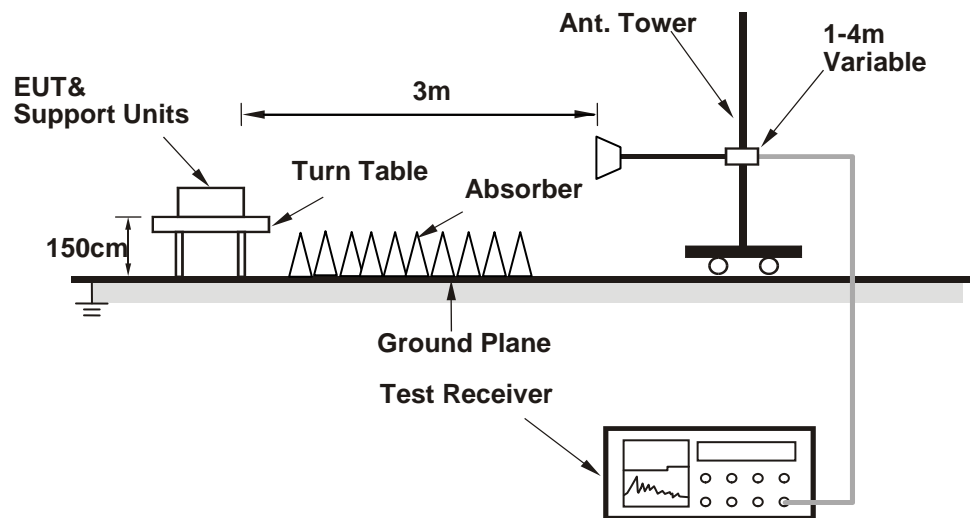

For the actual test configuration, please refer to the attached file (Test Setup Photo).

4.1.6 EUT Operating Condition

- a. Placed the EUT on the testing table
- b. Controlling software (Terminal paste "RF command has been activated to set the EUT under transmission condition continuously at specific channel frequency).

4.1.7 Test Results

Above 1GHz Data:

802.11a

CHANNEL	TX Channel 36	DETECTOR FUNCTION	Peak (PK)
FREQUENCY RANGE	1GHz ~ 40GHz		Average (AV)

ANTENNA POLARITY & TEST DISTANCE: HORIZONTAL AT 3 M

NO.	FREQ. (MHz)	EMISSION LEVEL (dBuV/m)	LIMIT (dBuV/m)	MARGIN (dB)	ANTENNA HEIGHT (m)	TABLE ANGLE (Degree)	RAW VALUE (dBuV)	CORRECTION FACTOR (dB/m)
1	5150.00	68.5 PK	74.0	-5.5	1.18 H	152	65.0	3.5
2	5150.00	52.9 AV	54.0	-1.1	1.18 H	152	49.4	3.5
3	*5180.00	107.3 PK			1.18 H	152	103.9	3.4
4	*5180.00	97.4 AV			1.18 H	152	94.0	3.4
5	#10360.00	47.7 PK	68.2	-20.5	1.44 H	170	34.6	13.1
6	15540.00	41.1 PK	74.0	-32.9	1.93 H	229	27.5	13.6
7	15540.00	28.9 AV	54.0	-25.1	1.93 H	229	15.3	13.6

ANTENNA POLARITY & TEST DISTANCE: VERTICAL AT 3 M

NO.	FREQ. (MHz)	EMISSION LEVEL (dBuV/m)	LIMIT (dBuV/m)	MARGIN (dB)	ANTENNA HEIGHT (m)	TABLE ANGLE (Degree)	RAW VALUE (dBuV)	CORRECTION FACTOR (dB/m)
1	5150.00	70.4 PK	74.0	-3.6	2.19 V	71	66.9	3.5
2	5150.00	53.7 AV	54.0	-0.3	2.19 V	71	50.2	3.5
3	*5180.00	108.1 PK			2.19 V	71	104.7	3.4
4	*5180.00	99.0 AV			2.19 V	71	95.6	3.4
5	#10360.00	49.2 PK	68.2	-19.0	1.22 V	100	36.1	13.1
6	15540.00	42.0 PK	74.0	-32.0	1.55 V	324	28.4	13.6
7	15540.00	30.6 AV	54.0	-23.4	1.55 V	324	17.0	13.6

REMARKS:

1. Emission Level(dBuV/m) = Raw Value(dBuV) + Correction Factor(dB/m)
2. Correction Factor(dB/m) = Antenna Factor(dB/m) + Cable Factor(dB) – Pre-Amplifier Factor(dB)
3. Margin value = Emission Level – Limit value
4. The other emission levels were very low against the limit.
5. " * ": Fundamental frequency.
6. " # ": The radiated frequency is out of the restricted band.

CHANNEL	TX Channel 40	DETECTOR FUNCTION	Peak (PK)
FREQUENCY RANGE	1GHz ~ 40GHz		Average (AV)

ANTENNA POLARITY & TEST DISTANCE: HORIZONTAL AT 3 M

NO.	FREQ. (MHz)	EMISSION LEVEL (dBuV/m)	LIMIT (dBuV/m)	MARGIN (dB)	ANTENNA HEIGHT (m)	TABLE ANGLE (Degree)	RAW VALUE (dBuV)	CORRECTION FACTOR (dB/m)
1	*5200.00	108.0 PK			1.15 H	146	104.6	3.4
2	*5200.00	97.7 AV			1.15 H	146	94.3	3.4
3	#10400.00	47.4 PK	68.2	-20.8	1.41 H	163	34.0	13.4
4	15600.00	41.1 PK	74.0	-32.9	1.98 H	224	27.7	13.4
5	15600.00	28.8 AV	54.0	-25.2	1.98 H	224	15.4	13.4

ANTENNA POLARITY & TEST DISTANCE: VERTICAL AT 3 M

NO.	FREQ. (MHz)	EMISSION LEVEL (dBuV/m)	LIMIT (dBuV/m)	MARGIN (dB)	ANTENNA HEIGHT (m)	TABLE ANGLE (Degree)	RAW VALUE (dBuV)	CORRECTION FACTOR (dB/m)
1	*5200.00	108.8 PK			2.55 V	89	105.4	3.4
2	*5200.00	99.4 AV			2.55 V	89	96.0	3.4
3	#10400.00	50.1 PK	68.2	-18.1	1.43 V	109	36.7	13.4
4	15600.00	42.5 PK	74.0	-31.5	1.65 V	331	29.1	13.4
5	15600.00	31.3 AV	54.0	-22.7	1.65 V	331	17.9	13.4

REMARKS:

1. Emission Level(dBuV/m) = Raw Value(dBuV) + Correction Factor(dB/m)
2. Correction Factor(dB/m) = Antenna Factor(dB/m) + Cable Factor(dB) – Pre-Amplifier Factor(dB)
3. Margin value = Emission Level – Limit value
4. The other emission levels were very low against the limit.
5. " * ": Fundamental frequency.
6. " # ": The radiated frequency is out of the restricted band.

CHANNEL	TX Channel 48	DETECTOR FUNCTION	Peak (PK)
FREQUENCY RANGE	1GHz ~ 40GHz		Average (AV)

ANTENNA POLARITY & TEST DISTANCE: HORIZONTAL AT 3 M

NO.	FREQ. (MHz)	EMISSION LEVEL (dBuV/m)	LIMIT (dBuV/m)	MARGIN (dB)	ANTENNA HEIGHT (m)	TABLE ANGLE (Degree)	RAW VALUE (dBuV)	CORRECTION FACTOR (dB/m)
1	*5240.00	108.3 PK			1.21 H	134	105.3	3.0
2	*5240.00	98.1 AV			1.21 H	134	95.1	3.0
3	5350.00	47.8 PK	74.0	-26.2	1.21 H	134	44.5	3.3
4	5350.00	36.9 AV	54.0	-17.1	1.21 H	134	33.6	3.3
5	#10480.00	47.9 PK	68.2	-20.3	1.37 H	169	34.4	13.5
6	15720.00	41.4 PK	74.0	-32.6	2.03 H	214	28.6	12.8
7	15720.00	28.6 AV	54.0	-25.4	2.03 H	214	15.8	12.8

ANTENNA POLARITY & TEST DISTANCE: VERTICAL AT 3 M

NO.	FREQ. (MHz)	EMISSION LEVEL (dBuV/m)	LIMIT (dBuV/m)	MARGIN (dB)	ANTENNA HEIGHT (m)	TABLE ANGLE (Degree)	RAW VALUE (dBuV)	CORRECTION FACTOR (dB/m)
1	*5240.00	108.7 PK			2.46 V	78	105.7	3.0
2	*5240.00	99.3 AV			2.46 V	78	96.3	3.0
3	5350.00	48.5 PK	74.0	-25.5	2.46 V	78	45.2	3.3
4	5350.00	37.1 AV	54.0	-16.9	2.46 V	78	33.8	3.3
5	#10480.00	49.9 PK	68.2	-18.3	1.39 V	98	36.4	13.5
6	15720.00	42.7 PK	74.0	-31.3	1.61 V	329	29.9	12.8
7	15720.00	31.5 AV	54.0	-22.5	1.61 V	329	18.7	12.8

REMARKS:

1. Emission Level(dBuV/m) = Raw Value(dBuV) + Correction Factor(dB/m)
2. Correction Factor(dB/m) = Antenna Factor(dB/m) + Cable Factor(dB) – Pre-Amplifier Factor(dB)
3. Margin value = Emission Level – Limit value
4. The other emission levels were very low against the limit.
5. " * ": Fundamental frequency.
6. " # ": The radiated frequency is out of the restricted band.

CHANNEL	TX Channel 52	DETECTOR FUNCTION	Peak (PK)
FREQUENCY RANGE	1GHz ~ 40GHz		Average (AV)

ANTENNA POLARITY & TEST DISTANCE: HORIZONTAL AT 3 M

NO.	FREQ. (MHz)	EMISSION LEVEL (dBuV/m)	LIMIT (dBuV/m)	MARGIN (dB)	ANTENNA HEIGHT (m)	TABLE ANGLE (Degree)	RAW VALUE (dBuV)	CORRECTION FACTOR (dB/m)
1	5150.00	48.2 PK	74.0	-25.8	1.17 H	121	44.7	3.5
2	5150.00	37.1 AV	54.0	-16.9	1.17 H	121	33.6	3.5
3	*5260.00	108.7 PK			1.17 H	121	105.7	3.0
4	*5260.00	98.3 AV			1.17 H	121	95.3	3.0
5	#10520.00	48.4 PK	68.2	-19.8	1.41 H	160	34.7	13.7
6	15780.00	41.5 PK	74.0	-32.5	1.99 H	227	28.6	12.9
7	15780.00	28.2 AV	54.0	-25.8	1.99 H	227	15.3	12.9

ANTENNA POLARITY & TEST DISTANCE: VERTICAL AT 3 M

NO.	FREQ. (MHz)	EMISSION LEVEL (dBuV/m)	LIMIT (dBuV/m)	MARGIN (dB)	ANTENNA HEIGHT (m)	TABLE ANGLE (Degree)	RAW VALUE (dBuV)	CORRECTION FACTOR (dB/m)
1	5150.00	49.0 PK	74.0	-25.0	2.41 V	79	45.5	3.5
2	5150.00	37.7 AV	54.0	-16.3	2.41 V	79	34.2	3.5
3	*5260.00	109.1 PK			2.41 V	79	106.1	3.0
4	*5260.00	99.4 AV			2.41 V	79	96.4	3.0
5	#10520.00	50.1 PK	68.2	-18.1	1.51 V	101	36.4	13.7
6	15780.00	43.0 PK	74.0	-31.0	1.59 V	320	30.1	12.9
7	15780.00	31.7 AV	54.0	-22.3	1.59 V	320	18.8	12.9

REMARKS:

1. Emission Level(dBuV/m) = Raw Value(dBuV) + Correction Factor(dB/m)
2. Correction Factor(dB/m) = Antenna Factor(dB/m) + Cable Factor(dB) – Pre-Amplifier Factor(dB)
3. Margin value = Emission Level – Limit value
4. The other emission levels were very low against the limit.
5. " * ": Fundamental frequency.
6. " # ": The radiated frequency is out of the restricted band.

CHANNEL	TX Channel 60	DETECTOR FUNCTION	Peak (PK)
FREQUENCY RANGE	1GHz ~ 40GHz		Average (AV)

ANTENNA POLARITY & TEST DISTANCE: HORIZONTAL AT 3 M

NO.	FREQ. (MHz)	EMISSION LEVEL (dBuV/m)	LIMIT (dBuV/m)	MARGIN (dB)	ANTENNA HEIGHT (m)	TABLE ANGLE (Degree)	RAW VALUE (dBuV)	CORRECTION FACTOR (dB/m)
1	*5300.00	108.6 PK			1.11 H	133	105.5	3.1
2	*5300.00	98.4 AV			1.11 H	133	95.3	3.1
3	10600.00	48.2 PK	74.0	-25.8	1.44 H	151	34.6	13.6
4	10600.00	37.7 AV	54.0	-16.3	1.44 H	151	24.1	13.6
5	15900.00	43.6 PK	74.0	-30.4	1.95 H	231	30.3	13.3
6	15900.00	28.1 AV	54.0	-25.9	1.95 H	231	14.8	13.3

ANTENNA POLARITY & TEST DISTANCE: VERTICAL AT 3 M

NO.	FREQ. (MHz)	EMISSION LEVEL (dBuV/m)	LIMIT (dBuV/m)	MARGIN (dB)	ANTENNA HEIGHT (m)	TABLE ANGLE (Degree)	RAW VALUE (dBuV)	CORRECTION FACTOR (dB/m)
1	*5300.00	109.3 PK			2.49 V	83	106.2	3.1
2	*5300.00	99.6 AV			2.49 V	83	96.5	3.1
3	10600.00	50.3 PK	74.0	-23.7	1.47 V	109	36.7	13.6
4	10600.00	39.8 AV	54.0	-14.2	1.47 V	109	26.2	13.6
5	15900.00	44.1 PK	74.0	-29.9	1.69 V	341	30.8	13.3
6	15900.00	31.8 AV	54.0	-22.2	1.69 V	341	18.5	13.3

REMARKS:

1. Emission Level(dBuV/m) = Raw Value(dBuV) + Correction Factor(dB/m)
2. Correction Factor(dB/m) = Antenna Factor(dB/m) + Cable Factor(dB) – Pre-Amplifier Factor(dB)
3. Margin value = Emission Level – Limit value
4. The other emission levels were very low against the limit.
5. " * ": Fundamental frequency.

CHANNEL	TX Channel 64	DETECTOR FUNCTION	Peak (PK)
FREQUENCY RANGE	1GHz ~ 40GHz		Average (AV)

ANTENNA POLARITY & TEST DISTANCE: HORIZONTAL AT 3 M

NO.	FREQ. (MHz)	EMISSION LEVEL (dBuV/m)	LIMIT (dBuV/m)	MARGIN (dB)	ANTENNA HEIGHT (m)	TABLE ANGLE (Degree)	RAW VALUE (dBuV)	CORRECTION FACTOR (dB/m)
1	*5320.00	108.5 PK			1.11 H	148	105.3	3.2
2	*5320.00	98.3 AV			1.11 H	148	95.1	3.2
3	5350.00	63.6 PK	74.0	-10.4	1.11 H	148	60.3	3.3
4	5350.00	48.6 AV	54.0	-5.4	1.11 H	148	45.3	3.3
5	10640.00	47.6 PK	74.0	-26.4	1.48 H	143	33.9	13.7
6	10640.00	37.3 AV	54.0	-16.7	1.48 H	143	23.6	13.7
7	15960.00	43.8 PK	74.0	-30.2	1.90 H	239	30.3	13.5
8	15960.00	28.1 AV	54.0	-25.9	1.90 H	239	14.6	13.5

ANTENNA POLARITY & TEST DISTANCE: VERTICAL AT 3 M

NO.	FREQ. (MHz)	EMISSION LEVEL (dBuV/m)	LIMIT (dBuV/m)	MARGIN (dB)	ANTENNA HEIGHT (m)	TABLE ANGLE (Degree)	RAW VALUE (dBuV)	CORRECTION FACTOR (dB/m)
1	*5320.00	108.9 PK			2.41 V	89	105.7	3.2
2	*5320.00	99.3 AV			2.41 V	89	96.1	3.2
3	5350.00	65.0 PK	74.0	-9.0	2.41 V	89	61.7	3.3
4	5350.00	50.9 AV	54.0	-3.1	2.41 V	89	47.6	3.3
5	10640.00	50.1 PK	74.0	-23.9	1.58 V	98	36.4	13.7
6	10640.00	39.9 AV	54.0	-14.1	1.58 V	98	26.2	13.7
7	15960.00	44.7 PK	74.0	-29.3	1.70 V	330	31.2	13.5
8	15960.00	32.1 AV	54.0	-21.9	1.70 V	330	18.6	13.5

REMARKS:

1. Emission Level(dBuV/m) = Raw Value(dBuV) + Correction Factor(dB/m)
2. Correction Factor(dB/m) = Antenna Factor(dB/m) + Cable Factor(dB) – Pre-Amplifier Factor(dB)
3. Margin value = Emission Level – Limit value
4. The other emission levels were very low against the limit.
5. " * ": Fundamental frequency.

CHANNEL	TX Channel 100	DETECTOR FUNCTION	Peak (PK)
FREQUENCY RANGE	1GHz ~ 40GHz		Average (AV)

ANTENNA POLARITY & TEST DISTANCE: HORIZONTAL AT 3 M

NO.	FREQ. (MHz)	EMISSION LEVEL (dBuV/m)	LIMIT (dBuV/m)	MARGIN (dB)	ANTENNA HEIGHT (m)	TABLE ANGLE (Degree)	RAW VALUE (dBuV)	CORRECTION FACTOR (dB/m)
1	5460.00	57.0 PK	74.0	-17.0	1.12 H	139	53.3	3.7
2	5460.00	41.4 AV	54.0	-12.6	1.12 H	139	37.7	3.7
3	#5470.00	65.8 PK	68.2	-2.4	1.12 H	139	62.1	3.7
4	*5500.00	104.8 PK			1.12 H	139	101.2	3.6
5	*5500.00	94.5 AV			1.12 H	139	90.9	3.6
6	11000.00	43.8 PK	74.0	-30.2	1.48 H	142	29.4	14.4
7	11000.00	30.2 AV	54.0	-23.8	1.48 H	142	15.8	14.4
8	#16500.00	43.1 PK	68.2	-25.1	1.86 H	241	27.5	15.6

ANTENNA POLARITY & TEST DISTANCE: VERTICAL AT 3 M

NO.	FREQ. (MHz)	EMISSION LEVEL (dBuV/m)	LIMIT (dBuV/m)	MARGIN (dB)	ANTENNA HEIGHT (m)	TABLE ANGLE (Degree)	RAW VALUE (dBuV)	CORRECTION FACTOR (dB/m)
1	5460.00	59.1 PK	74.0	-14.9	2.36 V	78	55.4	3.7
2	5460.00	43.5 AV	54.0	-10.5	2.36 V	78	39.8	3.7
3	#5470.00	67.7 PK	68.2	-0.5	2.36 V	78	64.0	3.7
4	*5500.00	105.3 PK			2.36 V	78	101.7	3.6
5	*5500.00	95.6 AV			2.36 V	78	92.0	3.6
6	11000.00	44.5 PK	74.0	-29.5	1.63 V	110	30.1	14.4
7	11000.00	33.1 AV	54.0	-20.9	1.63 V	110	18.7	14.4
8	#16500.00	43.3 PK	68.2	-24.9	1.81 V	343	27.7	15.6

REMARKS:

1. Emission Level(dBuV/m) = Raw Value(dBuV) + Correction Factor(dB/m)
2. Correction Factor(dB/m) = Antenna Factor(dB/m) + Cable Factor(dB) – Pre-Amplifier Factor(dB)
3. Margin value = Emission Level – Limit value
4. The other emission levels were very low against the limit.
5. " * ": Fundamental frequency.
6. " # ": The radiated frequency is out of the restricted band.

CHANNEL	TX Channel 116	DETECTOR FUNCTION	Peak (PK)
FREQUENCY RANGE	1GHz ~ 40GHz		Average (AV)

ANTENNA POLARITY & TEST DISTANCE: HORIZONTAL AT 3 M

NO.	FREQ. (MHz)	EMISSION LEVEL (dBuV/m)	LIMIT (dBuV/m)	MARGIN (dB)	ANTENNA HEIGHT (m)	TABLE ANGLE (Degree)	RAW VALUE (dBuV)	CORRECTION FACTOR (dB/m)
1	*5580.00	105.9 PK			1.12 H	135	102.2	3.7
2	*5580.00	97.2 AV			1.12 H	135	93.5	3.7
3	11160.00	45.3 PK	74.0	-28.7	1.47 H	144	31.3	14.0
4	11160.00	33.1 AV	54.0	-20.9	1.47 H	144	19.1	14.0
5	#16740.00	44.2 PK	68.2	-24.0	1.87 H	253	27.1	17.1

ANTENNA POLARITY & TEST DISTANCE: VERTICAL AT 3 M

NO.	FREQ. (MHz)	EMISSION LEVEL (dBuV/m)	LIMIT (dBuV/m)	MARGIN (dB)	ANTENNA HEIGHT (m)	TABLE ANGLE (Degree)	RAW VALUE (dBuV)	CORRECTION FACTOR (dB/m)
1	*5580.00	108.0 PK			2.31 V	85	104.3	3.7
2	*5580.00	98.7 AV			2.31 V	85	95.0	3.7
3	11160.00	47.5 PK	74.0	-26.5	1.55 V	109	33.5	14.0
4	11160.00	35.5 AV	54.0	-18.5	1.55 V	109	21.5	14.0
5	#16740.00	45.6 PK	68.2	-22.6	1.77 V	327	28.5	17.1

REMARKS:

1. Emission Level(dBuV/m) = Raw Value(dBuV) + Correction Factor(dB/m)
2. Correction Factor(dB/m) = Antenna Factor(dB/m) + Cable Factor(dB) – Pre-Amplifier Factor(dB)
3. Margin value = Emission Level – Limit value
4. The other emission levels were very low against the limit.
5. " * ": Fundamental frequency.
6. " # ": The radiated frequency is out of the restricted band.

CHANNEL	TX Channel 140	DETECTOR FUNCTION	Peak (PK)
FREQUENCY RANGE	1GHz ~ 40GHz		Average (AV)

ANTENNA POLARITY & TEST DISTANCE: HORIZONTAL AT 3 M

NO.	FREQ. (MHz)	EMISSION LEVEL (dBuV/m)	LIMIT (dBuV/m)	MARGIN (dB)	ANTENNA HEIGHT (m)	TABLE ANGLE (Degree)	RAW VALUE (dBuV)	CORRECTION FACTOR (dB/m)
1	*5700.00	116.2 PK			1.34 H	166	112.3	3.9
2	*5700.00	95.6 AV			1.34 H	166	91.7	3.9
3	#5725.00	66.0 PK	68.2	-2.2	1.34 H	166	62.2	3.8
4	11400.00	44.2 PK	74.0	-29.8	1.42 H	126	30.0	14.2
5	11400.00	32.1 AV	54.0	-21.9	1.42 H	126	17.9	14.2
6	#17100.00	44.8 PK	68.2	-23.4	2.31 H	311	27.9	16.9

ANTENNA POLARITY & TEST DISTANCE: VERTICAL AT 3 M

NO.	FREQ. (MHz)	EMISSION LEVEL (dBuV/m)	LIMIT (dBuV/m)	MARGIN (dB)	ANTENNA HEIGHT (m)	TABLE ANGLE (Degree)	RAW VALUE (dBuV)	CORRECTION FACTOR (dB/m)
1	*5700.00	106.8 PK			2.65 V	98	102.9	3.9
2	*5700.00	97.0 AV			2.65 V	98	93.1	3.9
3	#5725.00	67.4 PK	68.2	-0.8	2.65 V	98	63.6	3.8
4	11400.00	45.1 PK	74.0	-28.9	1.55 V	101	30.9	14.2
5	11400.00	33.8 AV	54.0	-20.2	1.55 V	101	19.6	14.2
6	#17100.00	44.7 PK	68.2	-23.5	1.81 V	343	27.8	16.9

REMARKS:

1. Emission Level(dBuV/m) = Raw Value(dBuV) + Correction Factor(dB/m)
2. Correction Factor(dB/m) = Antenna Factor(dB/m) + Cable Factor(dB) – Pre-Amplifier Factor(dB)
3. Margin value = Emission Level – Limit value
4. The other emission levels were very low against the limit.
5. " * ": Fundamental frequency.
6. " # ": The radiated frequency is out of the restricted band.

CHANNEL	TX Channel 149	DETECTOR FUNCTION	Peak (PK)
FREQUENCY RANGE	1GHz ~ 40GHz		Average (AV)

ANTENNA POLARITY & TEST DISTANCE: HORIZONTAL AT 3 M

NO.	FREQ. (MHz)	EMISSION LEVEL (dBuV/m)	LIMIT (dBuV/m)	MARGIN (dB)	ANTENNA HEIGHT (m)	TABLE ANGLE (Degree)	RAW VALUE (dBuV)	CORRECTION FACTOR (dB/m)
1	#5647.80	51.0 PK	68.2	-17.2	1.27 H	143	47.4	3.6
2	*5745.00	107.9 PK			1.27 H	143	104.0	3.9
3	*5745.00	98.4 AV			1.27 H	143	94.5	3.9
4	#5953.92	50.2 PK	68.2	-18.0	1.27 H	143	45.8	4.4
5	11490.00	44.8 PK	74.0	-29.2	1.37 H	116	30.6	14.2
6	11490.00	33.2 AV	54.0	-20.8	1.37 H	116	19.0	14.2
7	#17235.00	44.6 PK	68.2	-23.6	2.36 H	314	27.3	17.3

ANTENNA POLARITY & TEST DISTANCE: VERTICAL AT 3 M

NO.	FREQ. (MHz)	EMISSION LEVEL (dBuV/m)	LIMIT (dBuV/m)	MARGIN (dB)	ANTENNA HEIGHT (m)	TABLE ANGLE (Degree)	RAW VALUE (dBuV)	CORRECTION FACTOR (dB/m)
1	#5649.01	51.6 PK	68.2	-16.6	2.69 V	85	48.0	3.6
2	*5745.00	109.8 PK			2.69 V	85	105.9	3.9
3	*5745.00	100.7 AV			2.69 V	85	96.8	3.9
4	#5987.25	49.6 PK	68.2	-18.6	2.69 V	85	45.2	4.4
5	11490.00	46.5 PK	74.0	-27.5	1.51 V	99	32.3	14.2
6	11490.00	35.9 AV	54.0	-18.1	1.51 V	99	21.7	14.2
7	#17235.00	45.1 PK	68.2	-23.1	1.75 V	339	27.8	17.3

REMARKS:

1. Emission Level(dBuV/m) = Raw Value(dBuV) + Correction Factor(dB/m)
2. Correction Factor(dB/m) = Antenna Factor(dB/m) + Cable Factor(dB) – Pre-Amplifier Factor(dB)
3. Margin value = Emission Level – Limit value
4. The other emission levels were very low against the limit.
5. " * ": Fundamental frequency.
6. " # ": The radiated frequency is out of the restricted band.

CHANNEL	TX Channel 157	DETECTOR FUNCTION	Peak (PK)
FREQUENCY RANGE	1GHz ~ 40GHz		Average (AV)

ANTENNA POLARITY & TEST DISTANCE: HORIZONTAL AT 3 M

NO.	FREQ. (MHz)	EMISSION LEVEL (dBuV/m)	LIMIT (dBuV/m)	MARGIN (dB)	ANTENNA HEIGHT (m)	TABLE ANGLE (Degree)	RAW VALUE (dBuV)	CORRECTION FACTOR (dB/m)
1	#5627.75	50.4 PK	68.2	-17.8	1.23 H	147	46.8	3.6
2	*5785.00	108.0 PK			1.23 H	147	104.0	4.0
3	*5785.00	99.1 AV			1.23 H	147	95.1	4.0
4	#5933.90	50.5 PK	68.2	-17.7	1.23 H	147	46.2	4.3
5	11570.00	45.3 PK	74.0	-28.7	1.43 H	138	31.1	14.2
6	11570.00	33.3 AV	54.0	-20.7	1.43 H	138	19.1	14.2
7	#17355.00	44.9 PK	68.2	-23.3	2.32 H	310	27.2	17.7

ANTENNA POLARITY & TEST DISTANCE: VERTICAL AT 3 M

NO.	FREQ. (MHz)	EMISSION LEVEL (dBuV/m)	LIMIT (dBuV/m)	MARGIN (dB)	ANTENNA HEIGHT (m)	TABLE ANGLE (Degree)	RAW VALUE (dBuV)	CORRECTION FACTOR (dB/m)
1	#5639.51	50.7 PK	68.2	-17.5	2.73 V	82	47.1	3.6
2	*5785.00	109.7 PK			2.73 V	82	105.7	4.0
3	*5785.00	100.7 AV			2.73 V	82	96.7	4.0
4	#5941.14	51.0 PK	68.2	-17.2	2.73 V	82	46.7	4.3
5	11570.00	47.0 PK	74.0	-27.0	1.59 V	105	32.8	14.2
6	11570.00	36.1 AV	54.0	-17.9	1.59 V	105	21.9	14.2
7	#17355.00	45.6 PK	68.2	-22.6	1.83 V	345	27.9	17.7

REMARKS:

- Emission Level(dBuV/m) = Raw Value(dBuV) + Correction Factor(dB/m)
- Correction Factor(dB/m) = Antenna Factor(dB/m) + Cable Factor(dB) – Pre-Amplifier Factor(dB)
- Margin value = Emission Level – Limit value
- The other emission levels were very low against the limit.
- " * ": Fundamental frequency.
- " # ": The radiated frequency is out of the restricted band.

CHANNEL	TX Channel 165	DETECTOR FUNCTION	Peak (PK)
FREQUENCY RANGE	1GHz ~ 40GHz		Average (AV)

ANTENNA POLARITY & TEST DISTANCE: HORIZONTAL AT 3 M

NO.	FREQ. (MHz)	EMISSION LEVEL (dBuV/m)	LIMIT (dBuV/m)	MARGIN (dB)	ANTENNA HEIGHT (m)	TABLE ANGLE (Degree)	RAW VALUE (dBuV)	CORRECTION FACTOR (dB/m)
1	#5604.39	50.5 PK	68.2	-17.7	1.30 H	150	46.8	3.7
2	*5825.00	107.9 PK			1.30 H	150	103.7	4.2
3	*5825.00	98.7 AV			1.30 H	150	94.5	4.2
4	#5968.20	50.8 PK	68.2	-17.4	1.30 H	150	46.4	4.4
5	11650.00	45.7 PK	74.0	-28.3	1.48 H	127	31.8	13.9
6	11650.00	33.6 AV	54.0	-20.4	1.48 H	127	19.7	13.9
7	#17475.00	44.5 PK	68.2	-23.7	2.36 H	309	25.7	18.8

ANTENNA POLARITY & TEST DISTANCE: VERTICAL AT 3 M

NO.	FREQ. (MHz)	EMISSION LEVEL (dBuV/m)	LIMIT (dBuV/m)	MARGIN (dB)	ANTENNA HEIGHT (m)	TABLE ANGLE (Degree)	RAW VALUE (dBuV)	CORRECTION FACTOR (dB/m)
1	#5603.28	49.5 PK	68.2	-18.7	2.71 V	88	45.8	3.7
2	*5825.00	109.6 PK			2.71 V	88	105.4	4.2
3	*5825.00	100.6 AV			2.71 V	88	96.4	4.2
4	#5979.32	50.1 PK	68.2	-18.1	2.71 V	88	45.7	4.4
5	11650.00	46.5 PK	74.0	-27.5	1.65 V	111	32.6	13.9
6	11650.00	35.8 AV	54.0	-18.2	1.65 V	111	21.9	13.9
7	#17475.00	45.7 PK	68.2	-22.5	1.75 V	332	26.9	18.8

REMARKS:

1. Emission Level(dBuV/m) = Raw Value(dBuV) + Correction Factor(dB/m)
2. Correction Factor(dB/m) = Antenna Factor(dB/m) + Cable Factor(dB) – Pre-Amplifier Factor(dB)
3. Margin value = Emission Level – Limit value
4. The other emission levels were very low against the limit.
5. " * ": Fundamental frequency.
6. " # ": The radiated frequency is out of the restricted band.

802.11ac (VHT20)

CHANNEL	TX Channel 36	DETECTOR FUNCTION	Peak (PK)
FREQUENCY RANGE	1GHz ~ 40GHz		Average (AV)

ANTENNA POLARITY & TEST DISTANCE: HORIZONTAL AT 3 M

NO.	FREQ. (MHz)	EMISSION LEVEL (dBuV/m)	LIMIT (dBuV/m)	MARGIN (dB)	ANTENNA HEIGHT (m)	TABLE ANGLE (Degree)	RAW VALUE (dBuV)	CORRECTION FACTOR (dB/m)
1	5150.00	66.8 PK	74.0	-7.2	1.45 H	139	63.3	3.5
2	5150.00	51.9 AV	54.0	-2.1	1.45 H	139	48.4	3.5
3	*5180.00	105.4 PK			1.45 H	139	102.0	3.4
4	*5180.00	96.2 AV			1.45 H	139	92.8	3.4
5	#10360.00	46.3 PK	68.2	-21.9	1.51 H	138	33.2	13.1
6	15540.00	41.2 PK	74.0	-32.8	2.41 H	315	27.6	13.6
7	15540.00	29.9 AV	54.0	-24.1	2.41 H	315	16.3	13.6

ANTENNA POLARITY & TEST DISTANCE: VERTICAL AT 3 M

NO.	FREQ. (MHz)	EMISSION LEVEL (dBuV/m)	LIMIT (dBuV/m)	MARGIN (dB)	ANTENNA HEIGHT (m)	TABLE ANGLE (Degree)	RAW VALUE (dBuV)	CORRECTION FACTOR (dB/m)
1	5150.00	68.1 PK	74.0	-5.9	2.25 V	77	64.6	3.5
2	5150.00	53.4 AV	54.0	-0.6	2.25 V	77	49.9	3.5
3	*5180.00	107.1 PK			2.25 V	77	103.7	3.4
4	*5180.00	97.9 AV			2.25 V	77	94.5	3.4
5	#10360.00	48.5 PK	68.2	-19.7	1.43 V	109	35.4	13.1
6	15540.00	41.5 PK	74.0	-32.5	1.61 V	331	27.9	13.6
7	15540.00	30.1 AV	54.0	-23.9	1.61 V	331	16.5	13.6

REMARKS:

1. Emission Level(dBuV/m) = Raw Value(dBuV) + Correction Factor(dB/m)
2. Correction Factor(dB/m) = Antenna Factor(dB/m) + Cable Factor(dB) – Pre-Amplifier Factor(dB)
3. Margin value = Emission Level – Limit value
4. The other emission levels were very low against the limit.
5. " * ": Fundamental frequency.
6. " # ": The radiated frequency is out of the restricted band.

CHANNEL	TX Channel 40	DETECTOR FUNCTION	Peak (PK)
FREQUENCY RANGE	1GHz ~ 40GHz		Average (AV)

ANTENNA POLARITY & TEST DISTANCE: HORIZONTAL AT 3 M

NO.	FREQ. (MHz)	EMISSION LEVEL (dBuV/m)	LIMIT (dBuV/m)	MARGIN (dB)	ANTENNA HEIGHT (m)	TABLE ANGLE (Degree)	RAW VALUE (dBuV)	CORRECTION FACTOR (dB/m)
1	*5200.00	106.9 PK			1.47 H	138	103.5	3.4
2	*5200.00	96.9 AV			1.47 H	138	93.5	3.4
3	#10400.00	47.9 PK	68.2	-20.3	1.50 H	144	34.5	13.4
4	15600.00	41.9 PK	74.0	-32.1	2.36 H	307	28.5	13.4
5	15600.00	30.6 AV	54.0	-23.4	2.36 H	307	17.2	13.4

ANTENNA POLARITY & TEST DISTANCE: VERTICAL AT 3 M

NO.	FREQ. (MHz)	EMISSION LEVEL (dBuV/m)	LIMIT (dBuV/m)	MARGIN (dB)	ANTENNA HEIGHT (m)	TABLE ANGLE (Degree)	RAW VALUE (dBuV)	CORRECTION FACTOR (dB/m)
1	*5200.00	108.2 PK			2.78 V	79	104.8	3.4
2	*5200.00	98.4 AV			2.78 V	79	95.0	3.4
3	#10400.00	50.2 PK	68.2	-18.0	1.50 V	101	36.8	13.4
4	15600.00	42.5 PK	74.0	-31.5	1.69 V	339	29.1	13.4
5	15600.00	31.5 AV	54.0	-22.5	1.69 V	339	18.1	13.4

REMARKS:

1. Emission Level(dBuV/m) = Raw Value(dBuV) + Correction Factor(dB/m)
2. Correction Factor(dB/m) = Antenna Factor(dB/m) + Cable Factor(dB) – Pre-Amplifier Factor(dB)
3. Margin value = Emission Level – Limit value
4. The other emission levels were very low against the limit.
5. " * ": Fundamental frequency.
6. " # ": The radiated frequency is out of the restricted band.

CHANNEL	TX Channel 48	DETECTOR FUNCTION	Peak (PK)
FREQUENCY RANGE	1GHz ~ 40GHz		Average (AV)

ANTENNA POLARITY & TEST DISTANCE: HORIZONTAL AT 3 M

NO.	FREQ. (MHz)	EMISSION LEVEL (dBuV/m)	LIMIT (dBuV/m)	MARGIN (dB)	ANTENNA HEIGHT (m)	TABLE ANGLE (Degree)	RAW VALUE (dBuV)	CORRECTION FACTOR (dB/m)
1	*5240.00	106.9 PK			1.52 H	142	103.9	3.0
2	*5240.00	96.8 AV			1.52 H	142	93.8	3.0
3	5350.00	46.7 PK	74.0	-27.3	1.52 H	142	43.4	3.3
4	5350.00	36.3 AV	54.0	-17.7	1.52 H	142	33.0	3.3
5	#10480.00	48.2 PK	68.2	-20.0	1.47 H	157	34.7	13.5
6	15720.00	42.2 PK	74.0	-31.8	2.39 H	292	29.4	12.8
7	15720.00	30.7 AV	54.0	-23.3	2.39 H	292	17.9	12.8

ANTENNA POLARITY & TEST DISTANCE: VERTICAL AT 3 M

NO.	FREQ. (MHz)	EMISSION LEVEL (dBuV/m)	LIMIT (dBuV/m)	MARGIN (dB)	ANTENNA HEIGHT (m)	TABLE ANGLE (Degree)	RAW VALUE (dBuV)	CORRECTION FACTOR (dB/m)
1	*5240.00	108.0 PK			2.69 V	81	105.0	3.0
2	*5240.00	98.3 AV			2.69 V	81	95.3	3.0
3	5350.00	47.1 PK	74.0	-26.9	2.69 V	81	43.8	3.3
4	5350.00	36.5 AV	54.0	-17.5	2.69 V	81	33.2	3.3
5	#10480.00	49.4 PK	68.2	-18.8	1.44 V	99	35.9	13.5
6	15720.00	43.1 PK	74.0	-30.9	1.66 V	323	30.3	12.8
7	15720.00	32.1 AV	54.0	-21.9	1.66 V	323	19.3	12.8

REMARKS:

- Emission Level(dBuV/m) = Raw Value(dBuV) + Correction Factor(dB/m)
- Correction Factor(dB/m) = Antenna Factor(dB/m) + Cable Factor(dB) – Pre-Amplifier Factor(dB)
- Margin value = Emission Level – Limit value
- The other emission levels were very low against the limit.
- " * ": Fundamental frequency.
- " # ": The radiated frequency is out of the restricted band.

CHANNEL	TX Channel 52	DETECTOR FUNCTION	Peak (PK)
FREQUENCY RANGE	1GHz ~ 40GHz		Average (AV)

ANTENNA POLARITY & TEST DISTANCE: HORIZONTAL AT 3 M

NO.	FREQ. (MHz)	EMISSION LEVEL (dBuV/m)	LIMIT (dBuV/m)	MARGIN (dB)	ANTENNA HEIGHT (m)	TABLE ANGLE (Degree)	RAW VALUE (dBuV)	CORRECTION FACTOR (dB/m)
1	5150.00	49.6 PK	74.0	-24.4	1.77 H	120	46.1	3.5
2	5150.00	37.7 AV	54.0	-16.3	1.77 H	120	34.2	3.5
3	*5260.00	107.5 PK			1.77 H	120	104.5	3.0
4	*5260.00	97.7 AV			1.77 H	120	94.7	3.0
5	#10520.00	47.9 PK	68.2	-20.3	1.44 H	144	34.2	13.7
6	15780.00	42.6 PK	74.0	-31.4	2.35 H	293	29.7	12.9
7	15780.00	30.8 AV	54.0	-23.2	2.35 H	293	17.9	12.9

ANTENNA POLARITY & TEST DISTANCE: VERTICAL AT 3 M

NO.	FREQ. (MHz)	EMISSION LEVEL (dBuV/m)	LIMIT (dBuV/m)	MARGIN (dB)	ANTENNA HEIGHT (m)	TABLE ANGLE (Degree)	RAW VALUE (dBuV)	CORRECTION FACTOR (dB/m)
1	5150.00	50.1 PK	74.0	-23.9	2.53 V	79	46.6	3.5
2	5150.00	38.1 AV	54.0	-15.9	2.53 V	79	34.6	3.5
3	*5260.00	109.2 PK			2.53 V	79	106.2	3.0
4	*5260.00	99.5 AV			2.53 V	79	96.5	3.0
5	#10520.00	49.3 PK	68.2	-18.9	1.53 V	103	35.6	13.7
6	15780.00	42.9 PK	74.0	-31.1	1.59 V	339	30.0	12.9
7	15780.00	32.0 AV	54.0	-22.0	1.59 V	339	19.1	12.9

REMARKS:

1. Emission Level(dBuV/m) = Raw Value(dBuV) + Correction Factor(dB/m)
2. Correction Factor(dB/m) = Antenna Factor(dB/m) + Cable Factor(dB) – Pre-Amplifier Factor(dB)
3. Margin value = Emission Level – Limit value
4. The other emission levels were very low against the limit.
5. " * ": Fundamental frequency.
6. " # ": The radiated frequency is out of the restricted band.

CHANNEL	TX Channel 60	DETECTOR FUNCTION	Peak (PK)
FREQUENCY RANGE	1GHz ~ 40GHz		Average (AV)

ANTENNA POLARITY & TEST DISTANCE: HORIZONTAL AT 3 M

NO.	FREQ. (MHz)	EMISSION LEVEL (dBuV/m)	LIMIT (dBuV/m)	MARGIN (dB)	ANTENNA HEIGHT (m)	TABLE ANGLE (Degree)	RAW VALUE (dBuV)	CORRECTION FACTOR (dB/m)
1	*5300.00	107.8 PK			1.79 H	109	104.7	3.1
2	*5300.00	97.9 AV			1.79 H	109	94.8	3.1
3	10600.00	48.2 PK	74.0	-25.8	1.42 H	157	34.6	13.6
4	10600.00	36.9 AV	54.0	-17.1	1.42 H	157	23.3	13.6
5	15900.00	42.9 PK	74.0	-31.1	2.35 H	283	29.6	13.3
6	15900.00	37.0 AV	54.0	-17.0	2.35 H	283	23.7	13.3

ANTENNA POLARITY & TEST DISTANCE: VERTICAL AT 3 M

NO.	FREQ. (MHz)	EMISSION LEVEL (dBuV/m)	LIMIT (dBuV/m)	MARGIN (dB)	ANTENNA HEIGHT (m)	TABLE ANGLE (Degree)	RAW VALUE (dBuV)	CORRECTION FACTOR (dB/m)
1	*5300.00	109.5 PK			2.49 V	82	106.4	3.1
2	*5300.00	99.7 AV			2.49 V	82	96.6	3.1
3	10600.00	49.8 PK	74.0	-24.2	1.61 V	111	36.2	13.6
4	10600.00	38.1 AV	54.0	-15.9	1.61 V	111	24.5	13.6
5	15900.00	43.1 PK	74.0	-30.9	1.71 V	343	29.8	13.3
6	15900.00	37.9 AV	54.0	-16.1	1.71 V	343	24.6	13.3

REMARKS:

1. Emission Level(dBuV/m) = Raw Value(dBuV) + Correction Factor(dB/m)
2. Correction Factor(dB/m) = Antenna Factor(dB/m) + Cable Factor(dB) – Pre-Amplifier Factor(dB)
3. Margin value = Emission Level – Limit value
4. The other emission levels were very low against the limit.
5. " * ": Fundamental frequency.

CHANNEL	TX Channel 64	DETECTOR FUNCTION	Peak (PK)
FREQUENCY RANGE	1GHz ~ 40GHz		Average (AV)

ANTENNA POLARITY & TEST DISTANCE: HORIZONTAL AT 3 M

NO.	FREQ. (MHz)	EMISSION LEVEL (dBuV/m)	LIMIT (dBuV/m)	MARGIN (dB)	ANTENNA HEIGHT (m)	TABLE ANGLE (Degree)	RAW VALUE (dBuV)	CORRECTION FACTOR (dB/m)
1	*5320.00	107.9 PK			1.77 H	109	104.7	3.2
2	*5320.00	98.2 AV			1.77 H	109	95.0	3.2
3	5350.00	64.6 PK	74.0	-9.4	1.77 H	109	61.3	3.3
4	5350.00	48.3 AV	54.0	-5.7	1.77 H	109	45.0	3.3
5	10640.00	48.0 PK	74.0	-26.0	1.37 H	158	34.3	13.7
6	10640.00	36.5 AV	54.0	-17.5	1.37 H	158	22.8	13.7
7	15960.00	43.3 PK	74.0	-30.7	2.30 H	278	29.8	13.5
8	15960.00	37.3 AV	54.0	-16.7	2.30 H	278	23.8	13.5

ANTENNA POLARITY & TEST DISTANCE: VERTICAL AT 3 M

NO.	FREQ. (MHz)	EMISSION LEVEL (dBuV/m)	LIMIT (dBuV/m)	MARGIN (dB)	ANTENNA HEIGHT (m)	TABLE ANGLE (Degree)	RAW VALUE (dBuV)	CORRECTION FACTOR (dB/m)
1	*5320.00	109.0 PK			2.37 V	85	105.8	3.2
2	*5320.00	99.5 AV			2.37 V	85	96.3	3.2
3	5350.00	66.9 PK	74.0	-7.1	2.37 V	85	63.6	3.3
4	5350.00	51.1 AV	54.0	-2.9	2.37 V	85	47.8	3.3
5	10640.00	49.7 PK	74.0	-24.3	1.53 V	103	36.0	13.7
6	10640.00	38.3 AV	54.0	-15.7	1.53 V	103	24.6	13.7
7	15960.00	42.8 PK	74.0	-31.2	1.69 V	321	29.3	13.5
8	15960.00	38.3 AV	54.0	-15.7	1.69 V	321	24.8	13.5

REMARKS:

1. Emission Level(dBuV/m) = Raw Value(dBuV) + Correction Factor(dB/m)
2. Correction Factor(dB/m) = Antenna Factor(dB/m) + Cable Factor(dB) – Pre-Amplifier Factor(dB)
3. Margin value = Emission Level – Limit value
4. The other emission levels were very low against the limit.
5. " * ": Fundamental frequency.

CHANNEL	TX Channel 100	DETECTOR FUNCTION	Peak (PK)
FREQUENCY RANGE	1GHz ~ 40GHz		Average (AV)

ANTENNA POLARITY & TEST DISTANCE: HORIZONTAL AT 3 M

NO.	FREQ. (MHz)	EMISSION LEVEL (dBuV/m)	LIMIT (dBuV/m)	MARGIN (dB)	ANTENNA HEIGHT (m)	TABLE ANGLE (Degree)	RAW VALUE (dBuV)	CORRECTION FACTOR (dB/m)
1	5460.00	57.8 PK	74.0	-16.2	1.79 H	114	54.1	3.7
2	5460.00	42.5 AV	54.0	-11.5	1.79 H	114	38.8	3.7
3	#5470.00	65.9 PK	68.2	-2.3	1.79 H	114	62.2	3.7
4	*5500.00	103.9 PK			1.79 H	114	100.3	3.6
5	*5500.00	94.6 AV			1.79 H	114	91.0	3.6
6	11000.00	44.0 PK	74.0	-30.0	1.35 H	158	29.6	14.4
7	11000.00	33.1 AV	54.0	-20.9	1.35 H	158	18.7	14.4
8	#16500.00	43.3 PK	68.2	-24.9	2.25 H	276	27.7	15.6

ANTENNA POLARITY & TEST DISTANCE: VERTICAL AT 3 M

NO.	FREQ. (MHz)	EMISSION LEVEL (dBuV/m)	LIMIT (dBuV/m)	MARGIN (dB)	ANTENNA HEIGHT (m)	TABLE ANGLE (Degree)	RAW VALUE (dBuV)	CORRECTION FACTOR (dB/m)
1	5460.00	58.5 PK	74.0	-15.5	2.58 V	95	54.8	3.7
2	5460.00	43.8 AV	54.0	-10.2	2.58 V	95	40.1	3.7
3	#5470.00	67.8 PK	68.2	-0.4	2.58 V	95	64.1	3.7
4	*5500.00	105.2 PK			2.58 V	95	101.6	3.6
5	*5500.00	96.1 AV			2.58 V	95	92.5	3.6
6	11000.00	44.1 PK	74.0	-29.9	1.66 V	97	29.7	14.4
7	11000.00	33.3 AV	54.0	-20.7	1.66 V	97	18.9	14.4
8	#16500.00	43.5 PK	68.2	-24.7	1.75 V	330	27.9	15.6

REMARKS:

1. Emission Level(dBuV/m) = Raw Value(dBuV) + Correction Factor(dB/m)
2. Correction Factor(dB/m) = Antenna Factor(dB/m) + Cable Factor(dB) – Pre-Amplifier Factor(dB)
3. Margin value = Emission Level – Limit value
4. The other emission levels were very low against the limit.
5. " * ": Fundamental frequency.
6. " # ": The radiated frequency is out of the restricted band.

CHANNEL	TX Channel 116	DETECTOR FUNCTION	Peak (PK)
FREQUENCY RANGE	1GHz ~ 40GHz		Average (AV)

ANTENNA POLARITY & TEST DISTANCE: HORIZONTAL AT 3 M

NO.	FREQ. (MHz)	EMISSION LEVEL (dBuV/m)	LIMIT (dBuV/m)	MARGIN (dB)	ANTENNA HEIGHT (m)	TABLE ANGLE (Degree)	RAW VALUE (dBuV)	CORRECTION FACTOR (dB/m)
1	*5580.00	107.0 PK			1.77 H	113	103.3	3.7
2	*5580.00	97.1 AV			1.77 H	113	93.4	3.7
3	11160.00	44.9 PK	74.0	-29.1	1.39 H	167	30.9	14.0
4	11160.00	33.9 AV	54.0	-20.1	1.39 H	167	19.9	14.0
5	#16740.00	44.9 PK	68.2	-23.3	2.25 H	292	27.8	17.1

ANTENNA POLARITY & TEST DISTANCE: VERTICAL AT 3 M

NO.	FREQ. (MHz)	EMISSION LEVEL (dBuV/m)	LIMIT (dBuV/m)	MARGIN (dB)	ANTENNA HEIGHT (m)	TABLE ANGLE (Degree)	RAW VALUE (dBuV)	CORRECTION FACTOR (dB/m)
1	*5580.00	108.1 PK			2.55 V	89	104.4	3.7
2	*5580.00	98.8 AV			2.55 V	89	95.1	3.7
3	11160.00	46.3 PK	74.0	-27.7	1.57 V	109	32.3	14.0
4	11160.00	35.5 AV	54.0	-18.5	1.57 V	109	21.5	14.0
5	#16740.00	45.5 PK	68.2	-22.7	1.69 V	319	28.4	17.1

REMARKS:

1. Emission Level(dBuV/m) = Raw Value(dBuV) + Correction Factor(dB/m)
2. Correction Factor(dB/m) = Antenna Factor(dB/m) + Cable Factor(dB) – Pre-Amplifier Factor(dB)
3. Margin value = Emission Level – Limit value
4. The other emission levels were very low against the limit.
5. " * ": Fundamental frequency.
6. " # ": The radiated frequency is out of the restricted band.

CHANNEL	TX Channel 140	DETECTOR FUNCTION	Peak (PK)
FREQUENCY RANGE	1GHz ~ 40GHz		Average (AV)

ANTENNA POLARITY & TEST DISTANCE: HORIZONTAL AT 3 M

NO.	FREQ. (MHz)	EMISSION LEVEL (dBuV/m)	LIMIT (dBuV/m)	MARGIN (dB)	ANTENNA HEIGHT (m)	TABLE ANGLE (Degree)	RAW VALUE (dBuV)	CORRECTION FACTOR (dB/m)
1	*5700.00	104.9 PK			1.79 H	99	101.0	3.9
2	*5700.00	95.3 AV			1.79 H	99	91.4	3.9
3	#5725.00	65.1 PK	68.2	-3.1	1.79 H	99	61.3	3.8
4	11400.00	45.2 PK	74.0	-28.8	1.35 H	181	31.0	14.2
5	11400.00	34.2 AV	54.0	-19.8	1.35 H	181	20.0	14.2
6	#17100.00	44.2 PK	68.2	-24.0	2.27 H	306	27.3	16.9

ANTENNA POLARITY & TEST DISTANCE: VERTICAL AT 3 M

NO.	FREQ. (MHz)	EMISSION LEVEL (dBuV/m)	LIMIT (dBuV/m)	MARGIN (dB)	ANTENNA HEIGHT (m)	TABLE ANGLE (Degree)	RAW VALUE (dBuV)	CORRECTION FACTOR (dB/m)
1	*5700.00	106.0 PK			2.77 V	95	102.1	3.9
2	*5700.00	97.0 AV			2.77 V	95	93.1	3.9
3	#5725.00	67.6 PK	68.2	-0.6	2.77 V	95	63.8	3.8
4	11400.00	45.5 PK	74.0	-28.5	1.66 V	111	31.3	14.2
5	11400.00	34.9 AV	54.0	-19.1	1.66 V	111	20.7	14.2
6	#17100.00	44.7 PK	68.2	-23.5	1.75 V	329	27.8	16.9

REMARKS:

1. Emission Level(dBuV/m) = Raw Value(dBuV) + Correction Factor(dB/m)
2. Correction Factor(dB/m) = Antenna Factor(dB/m) + Cable Factor(dB) – Pre-Amplifier Factor(dB)
3. Margin value = Emission Level – Limit value
4. The other emission levels were very low against the limit.
5. " * ": Fundamental frequency.
6. " # ": The radiated frequency is out of the restricted band.

CHANNEL	TX Channel 149	DETECTOR FUNCTION	Peak (PK)
FREQUENCY RANGE	1GHz ~ 40GHz		Average (AV)

ANTENNA POLARITY & TEST DISTANCE: HORIZONTAL AT 3 M

NO.	FREQ. (MHz)	EMISSION LEVEL (dBuV/m)	LIMIT (dBuV/m)	MARGIN (dB)	ANTENNA HEIGHT (m)	TABLE ANGLE (Degree)	RAW VALUE (dBuV)	CORRECTION FACTOR (dB/m)
1	#5596.87	50.6 PK	68.2	-17.6	1.26 H	151	46.9	3.7
2	*5745.00	108.0 PK			1.26 H	151	104.1	3.9
3	*5745.00	98.3 AV			1.26 H	151	94.4	3.9
4	#5964.98	50.2 PK	68.2	-18.0	1.26 H	151	45.8	4.4
5	11490.00	45.4 PK	74.0	-28.6	1.39 H	184	31.2	14.2
6	11490.00	34.3 AV	54.0	-19.7	1.39 H	184	20.1	14.2
7	#17235.00	45.3 PK	68.2	-22.9	2.23 H	299	28.0	17.3

ANTENNA POLARITY & TEST DISTANCE: VERTICAL AT 3 M

NO.	FREQ. (MHz)	EMISSION LEVEL (dBuV/m)	LIMIT (dBuV/m)	MARGIN (dB)	ANTENNA HEIGHT (m)	TABLE ANGLE (Degree)	RAW VALUE (dBuV)	CORRECTION FACTOR (dB/m)
1	#5598.01	50.4 PK	68.2	-17.8	2.78 V	83	46.7	3.7
2	*5745.00	109.6 PK			2.78 V	83	105.7	3.9
3	*5745.00	100.5 AV			2.78 V	83	96.6	3.9
4	#5964.19	49.1 PK	68.2	-19.1	2.78 V	83	44.7	4.4
5	11490.00	46.2 PK	74.0	-27.8	1.69 V	105	32.0	14.2
6	11490.00	35.5 AV	54.0	-18.5	1.69 V	105	21.3	14.2
7	#17235.00	45.9 PK	68.2	-22.3	1.75 V	333	28.6	17.3

REMARKS:

1. Emission Level(dBuV/m) = Raw Value(dBuV) + Correction Factor(dB/m)
2. Correction Factor(dB/m) = Antenna Factor(dB/m) + Cable Factor(dB) – Pre-Amplifier Factor(dB)
3. Margin value = Emission Level – Limit value
4. The other emission levels were very low against the limit.
5. " * ": Fundamental frequency.
6. " # ": The radiated frequency is out of the restricted band.

CHANNEL	TX Channel 157	DETECTOR FUNCTION	Peak (PK)
FREQUENCY RANGE	1GHz ~ 40GHz		Average (AV)

ANTENNA POLARITY & TEST DISTANCE: HORIZONTAL AT 3 M

NO.	FREQ. (MHz)	EMISSION LEVEL (dBuV/m)	LIMIT (dBuV/m)	MARGIN (dB)	ANTENNA HEIGHT (m)	TABLE ANGLE (Degree)	RAW VALUE (dBuV)	CORRECTION FACTOR (dB/m)
1	#5631.98	50.5 PK	68.2	-17.7	1.20 H	143	46.9	3.6
2	*5785.00	107.2 PK			1.20 H	143	103.2	4.0
3	*5785.00	97.8 AV			1.20 H	143	93.8	4.0
4	#5938.07	50.2 PK	68.2	-18.0	1.20 H	143	45.9	4.3
5	11570.00	45.6 PK	74.0	-28.4	1.34 H	187	31.4	14.2
6	11570.00	34.9 AV	54.0	-19.1	1.34 H	187	20.7	14.2
7	#17355.00	44.6 PK	68.2	-23.6	2.27 H	302	26.9	17.7

ANTENNA POLARITY & TEST DISTANCE: VERTICAL AT 3 M

NO.	FREQ. (MHz)	EMISSION LEVEL (dBuV/m)	LIMIT (dBuV/m)	MARGIN (dB)	ANTENNA HEIGHT (m)	TABLE ANGLE (Degree)	RAW VALUE (dBuV)	CORRECTION FACTOR (dB/m)
1	#5640.83	50.9 PK	68.2	-17.3	2.83 V	89	47.3	3.6
2	*5785.00	109.7 PK			2.83 V	89	105.7	4.0
3	*5785.00	100.6 AV			2.83 V	89	96.6	4.0
4	#5926.94	50.6 PK	68.2	-17.6	2.83 V	89	46.4	4.2
5	11570.00	46.5 PK	74.0	-27.5	1.59 V	119	32.3	14.2
6	11570.00	35.7 AV	54.0	-18.3	1.59 V	119	21.5	14.2
7	#17355.00	45.4 PK	68.2	-22.8	1.71 V	329	27.7	17.7

REMARKS:

1. Emission Level(dBuV/m) = Raw Value(dBuV) + Correction Factor(dB/m)
2. Correction Factor(dB/m) = Antenna Factor(dB/m) + Cable Factor(dB) – Pre-Amplifier Factor(dB)
3. Margin value = Emission Level – Limit value
4. The other emission levels were very low against the limit.
5. " * ": Fundamental frequency.
6. " # ": The radiated frequency is out of the restricted band.

CHANNEL	TX Channel 165	DETECTOR FUNCTION	Peak (PK)
FREQUENCY RANGE	1GHz ~ 40GHz		Average (AV)

ANTENNA POLARITY & TEST DISTANCE: HORIZONTAL AT 3 M

NO.	FREQ. (MHz)	EMISSION LEVEL (dBuV/m)	LIMIT (dBuV/m)	MARGIN (dB)	ANTENNA HEIGHT (m)	TABLE ANGLE (Degree)	RAW VALUE (dBuV)	CORRECTION FACTOR (dB/m)
1	#5604.64	50.1 PK	68.2	-18.1	1.27 H	149	46.4	3.7
2	*5825.00	107.2 PK			1.27 H	149	103.0	4.2
3	*5825.00	97.7 AV			1.27 H	149	93.5	4.2
4	#5940.82	50.8 PK	68.2	-17.4	1.27 H	149	46.5	4.3
5	11650.00	45.5 PK	74.0	-28.5	1.30 H	179	31.6	13.9
6	11650.00	34.4 AV	54.0	-19.6	1.30 H	179	20.5	13.9
7	#17475.00	44.3 PK	68.2	-23.9	2.32 H	291	25.5	18.8

ANTENNA POLARITY & TEST DISTANCE: VERTICAL AT 3 M

NO.	FREQ. (MHz)	EMISSION LEVEL (dBuV/m)	LIMIT (dBuV/m)	MARGIN (dB)	ANTENNA HEIGHT (m)	TABLE ANGLE (Degree)	RAW VALUE (dBuV)	CORRECTION FACTOR (dB/m)
1	#5607.11	50.4 PK	68.2	-17.8	2.75 V	93	46.7	3.7
2	*5825.00	110.1 PK			2.75 V	93	105.9	4.2
3	*5825.00	100.9 AV			2.75 V	93	96.7	4.2
4	#5974.06	50.8 PK	68.2	-17.4	2.75 V	93	46.4	4.4
5	11650.00	46.3 PK	74.0	-27.7	1.63 V	103	32.4	13.9
6	11650.00	35.5 AV	54.0	-18.5	1.63 V	103	21.6	13.9
7	#17475.00	45.7 PK	68.2	-22.5	1.69 V	339	26.9	18.8

REMARKS:

- Emission Level(dBuV/m) = Raw Value(dBuV) + Correction Factor(dB/m)
- Correction Factor(dB/m) = Antenna Factor(dB/m) + Cable Factor(dB) – Pre-Amplifier Factor(dB)
- Margin value = Emission Level – Limit value
- The other emission levels were very low against the limit.
- " * ": Fundamental frequency.
- " # ": The radiated frequency is out of the restricted band.

802.11ac (VHT40)

CHANNEL	TX Channel 38	DETECTOR FUNCTION	Peak (PK)
FREQUENCY RANGE	1GHz ~ 40GHz		Average (AV)

ANTENNA POLARITY & TEST DISTANCE: HORIZONTAL AT 3 M

NO.	FREQ. (MHz)	EMISSION LEVEL (dBuV/m)	LIMIT (dBuV/m)	MARGIN (dB)	ANTENNA HEIGHT (m)	TABLE ANGLE (Degree)	RAW VALUE (dBuV)	CORRECTION FACTOR (dB/m)
1	5150.00	63.1 PK	74.0	-10.9	1.44 H	138	59.6	3.5
2	5150.00	50.8 AV	54.0	-3.2	1.44 H	138	47.3	3.5
3	*5190.00	99.6 PK			1.44 H	138	96.2	3.4
4	*5190.00	89.8 AV			1.44 H	138	86.4	3.4
5	5350.00	46.2 PK	74.0	-27.8	1.44 H	138	42.9	3.3
6	5350.00	35.4 AV	54.0	-18.6	1.44 H	138	32.1	3.3
7	#10380.00	44.2 PK	68.2	-24.0	1.33 H	190	30.9	13.3
8	15570.00	43.3 PK	74.0	-30.7	2.34 H	285	29.9	13.4
9	15570.00	32.2 AV	54.0	-21.8	2.34 H	285	18.8	13.4

ANTENNA POLARITY & TEST DISTANCE: VERTICAL AT 3 M

NO.	FREQ. (MHz)	EMISSION LEVEL (dBuV/m)	LIMIT (dBuV/m)	MARGIN (dB)	ANTENNA HEIGHT (m)	TABLE ANGLE (Degree)	RAW VALUE (dBuV)	CORRECTION FACTOR (dB/m)
1	5150.00	65.5 PK	74.0	-8.5	2.58 V	86	62.0	3.5
2	5150.00	53.5 AV	54.0	-0.5	2.58 V	86	50.0	3.5
3	*5190.00	101.7 PK			2.58 V	86	98.3	3.4
4	*5190.00	92.5 AV			2.58 V	86	89.1	3.4
5	5350.00	47.5 PK	74.0	-26.5	2.58 V	86	44.2	3.3
6	5350.00	36.6 AV	54.0	-17.4	2.58 V	86	33.3	3.3
7	#10380.00	44.7 PK	68.2	-23.5	1.55 V	105	31.4	13.3
8	15570.00	43.5 PK	74.0	-30.5	1.79 V	337	30.1	13.4
9	15570.00	32.5 AV	54.0	-21.5	1.79 V	337	19.1	13.4

REMARKS:

- Emission Level(dBuV/m) = Raw Value(dBuV) + Correction Factor(dB/m)
- Correction Factor(dB/m) = Antenna Factor(dB/m) + Cable Factor(dB) – Pre-Amplifier Factor(dB)
- Margin value = Emission Level – Limit value
- The other emission levels were very low against the limit.
- " * ": Fundamental frequency.
- " # ": The radiated frequency is out of the restricted band.

CHANNEL	TX Channel 46	DETECTOR FUNCTION	Peak (PK)
FREQUENCY RANGE	1GHz ~ 40GHz		Average (AV)

ANTENNA POLARITY & TEST DISTANCE: HORIZONTAL AT 3 M

NO.	FREQ. (MHz)	EMISSION LEVEL (dBuV/m)	LIMIT (dBuV/m)	MARGIN (dB)	ANTENNA HEIGHT (m)	TABLE ANGLE (Degree)	RAW VALUE (dBuV)	CORRECTION FACTOR (dB/m)
1	*5230.00	105.0 PK			1.42 H	123	101.9	3.1
2	*5230.00	94.9 AV			1.42 H	123	91.8	3.1
3	5350.00	58.7 PK	74.0	-15.3	1.42 H	123	55.4	3.3
4	5350.00	40.8 AV	54.0	-13.2	1.42 H	123	37.5	3.3
5	#10460.00	45.2 PK	68.2	-23.0	1.35 H	181	31.7	13.5
6	15690.00	44.6 PK	74.0	-29.4	2.34 H	279	31.7	12.9
7	15690.00	32.9 AV	54.0	-21.1	2.34 H	279	20.0	12.9

ANTENNA POLARITY & TEST DISTANCE: VERTICAL AT 3 M

NO.	FREQ. (MHz)	EMISSION LEVEL (dBuV/m)	LIMIT (dBuV/m)	MARGIN (dB)	ANTENNA HEIGHT (m)	TABLE ANGLE (Degree)	RAW VALUE (dBuV)	CORRECTION FACTOR (dB/m)
1	*5230.00	106.3 PK			2.41 V	79	103.2	3.1
2	*5230.00	96.6 AV			2.41 V	79	93.5	3.1
3	5350.00	59.1 PK	74.0	-14.9	2.41 V	79	55.8	3.3
4	5350.00	41.1 AV	54.0	-12.9	2.41 V	79	37.8	3.3
5	#10460.00	45.7 PK	68.2	-22.5	1.66 V	110	32.2	13.5
6	15690.00	44.8 PK	74.0	-29.2	1.75 V	342	31.9	12.9
7	15690.00	33.1 AV	54.0	-20.9	1.75 V	342	20.2	12.9

REMARKS:

1. Emission Level(dBuV/m) = Raw Value(dBuV) + Correction Factor(dB/m)
2. Correction Factor(dB/m) = Antenna Factor(dB/m) + Cable Factor(dB) – Pre-Amplifier Factor(dB)
3. Margin value = Emission Level – Limit value
4. The other emission levels were very low against the limit.
5. " * ": Fundamental frequency.
6. " # ": The radiated frequency is out of the restricted band.

CHANNEL	TX Channel 54	DETECTOR FUNCTION	Peak (PK)
FREQUENCY RANGE	1GHz ~ 40GHz		Average (AV)

ANTENNA POLARITY & TEST DISTANCE: HORIZONTAL AT 3 M

NO.	FREQ. (MHz)	EMISSION LEVEL (dBuV/m)	LIMIT (dBuV/m)	MARGIN (dB)	ANTENNA HEIGHT (m)	TABLE ANGLE (Degree)	RAW VALUE (dBuV)	CORRECTION FACTOR (dB/m)
1	5150.00	52.2 PK	74.0	-21.8	1.45 H	120	48.7	3.5
2	5150.00	40.1 AV	54.0	-13.9	1.45 H	120	36.6	3.5
3	*5270.00	104.9 PK			1.45 H	120	101.9	3.0
4	*5270.00	96.1 AV			1.45 H	120	93.1	3.0
5	#10540.00	45.9 PK	68.2	-22.3	1.30 H	173	32.2	13.7
6	15810.00	44.8 PK	74.0	-29.2	2.29 H	276	31.7	13.1
7	15810.00	33.2 AV	54.0	-20.8	2.29 H	276	20.1	13.1

ANTENNA POLARITY & TEST DISTANCE: VERTICAL AT 3 M

NO.	FREQ. (MHz)	EMISSION LEVEL (dBuV/m)	LIMIT (dBuV/m)	MARGIN (dB)	ANTENNA HEIGHT (m)	TABLE ANGLE (Degree)	RAW VALUE (dBuV)	CORRECTION FACTOR (dB/m)
1	5150.00	52.5 PK	74.0	-21.5	2.72 V	71	49.0	3.5
2	5150.00	40.3 AV	54.0	-13.7	2.72 V	71	36.8	3.5
3	*5270.00	106.0 PK			2.42 V	71	103.0	3.0
4	*5270.00	97.4 AV			2.42 V	71	94.4	3.0
5	#10540.00	46.5 PK	68.2	-21.7	1.58 V	108	32.8	13.7
6	15810.00	45.1 PK	74.0	-28.9	1.69 V	321	32.0	13.1
7	15810.00	33.5 AV	54.0	-20.5	1.69 V	321	20.4	13.1

REMARKS:

1. Emission Level(dBuV/m) = Raw Value(dBuV) + Correction Factor(dB/m)
2. Correction Factor(dB/m) = Antenna Factor(dB/m) + Cable Factor(dB) – Pre-Amplifier Factor(dB)
3. Margin value = Emission Level – Limit value
4. The other emission levels were very low against the limit.
5. " * ": Fundamental frequency.
6. " # ": The radiated frequency is out of the restricted band.

CHANNEL	TX Channel 62	DETECTOR FUNCTION	Peak (PK)
FREQUENCY RANGE	1GHz ~ 40GHz		Average (AV)

ANTENNA POLARITY & TEST DISTANCE: HORIZONTAL AT 3 M

NO.	FREQ. (MHz)	EMISSION LEVEL (dBuV/m)	LIMIT (dBuV/m)	MARGIN (dB)	ANTENNA HEIGHT (m)	TABLE ANGLE (Degree)	RAW VALUE (dBuV)	CORRECTION FACTOR (dB/m)
1	*5310.00	100.1 PK			1.44 H	120	96.9	3.2
2	*5310.00	90.4 AV			1.44 H	120	87.2	3.2
3	5350.00	62.7 PK	74.0	-11.3	1.44 H	120	59.4	3.3
4	5350.00	51.6 AV	54.0	-2.4	1.44 H	120	48.3	3.3
5	10620.00	43.9 PK	74.0	-30.1	1.27 H	164	30.3	13.6
6	10620.00	33.0 AV	54.0	-21.0	1.27 H	164	19.4	13.6
7	15930.00	43.2 PK	74.0	-30.8	2.30 H	261	29.9	13.3
8	15930.00	32.7 AV	54.0	-21.3	2.30 H	261	19.4	13.3

ANTENNA POLARITY & TEST DISTANCE: VERTICAL AT 3 M

NO.	FREQ. (MHz)	EMISSION LEVEL (dBuV/m)	LIMIT (dBuV/m)	MARGIN (dB)	ANTENNA HEIGHT (m)	TABLE ANGLE (Degree)	RAW VALUE (dBuV)	CORRECTION FACTOR (dB/m)
1	*5310.00	101.8 PK			2.49 V	79	98.6	3.2
2	*5310.00	92.4 AV			2.49 V	79	89.2	3.2
3	5350.00	64.6 PK	74.0	-9.4	2.49 V	79	61.3	3.3
4	5350.00	53.4 AV	54.0	-0.6	2.49 V	79	50.1	3.3
5	10620.00	44.1 PK	74.0	-29.9	1.61 V	110	30.5	13.6
6	10620.00	33.3 AV	54.0	-20.7	1.61 V	110	19.7	13.6
7	15930.00	43.5 PK	74.0	-30.5	1.73 V	313	30.2	13.3
8	15930.00	32.9 AV	54.0	-21.1	1.73 V	313	19.6	13.3

REMARKS:

1. Emission Level(dBuV/m) = Raw Value(dBuV) + Correction Factor(dB/m)
2. Correction Factor(dB/m) = Antenna Factor(dB/m) + Cable Factor(dB) – Pre-Amplifier Factor(dB)
3. Margin value = Emission Level – Limit value
4. The other emission levels were very low against the limit.
5. " * ": Fundamental frequency.

CHANNEL	TX Channel 102	DETECTOR FUNCTION	Peak (PK)
FREQUENCY RANGE	1GHz ~ 40GHz		Average (AV)

ANTENNA POLARITY & TEST DISTANCE: HORIZONTAL AT 3 M

NO.	FREQ. (MHz)	EMISSION LEVEL (dBuV/m)	LIMIT (dBuV/m)	MARGIN (dB)	ANTENNA HEIGHT (m)	TABLE ANGLE (Degree)	RAW VALUE (dBuV)	CORRECTION FACTOR (dB/m)
1	5460.00	59.7 PK	74.0	-14.3	1.46 H	133	56.0	3.7
2	5460.00	45.6 AV	54.0	-8.4	1.46 H	133	41.9	3.7
3	#5470.00	65.3 PK	68.2	-2.9	1.46 H	133	61.6	3.7
4	*5510.00	98.3 PK			1.46 H	133	94.7	3.6
5	*5510.00	89.3 AV			1.46 H	133	85.7	3.6
6	11020.00	42.5 PK	74.0	-31.5	1.27 H	161	28.2	14.3
7	11020.00	31.3 AV	54.0	-22.7	1.27 H	161	17.0	14.3
8	#16530.00	43.1 PK	68.2	-25.1	2.31 H	273	27.4	15.7

ANTENNA POLARITY & TEST DISTANCE: VERTICAL AT 3 M

NO.	FREQ. (MHz)	EMISSION LEVEL (dBuV/m)	LIMIT (dBuV/m)	MARGIN (dB)	ANTENNA HEIGHT (m)	TABLE ANGLE (Degree)	RAW VALUE (dBuV)	CORRECTION FACTOR (dB/m)
1	5460.00	61.5 PK	74.0	-12.5	2.75 V	96	57.8	3.7
2	5460.00	47.5 AV	54.0	-6.5	2.75 V	96	43.8	3.7
3	#5470.00	67.8 PK	68.2	-0.4	2.75 V	96	64.1	3.7
4	*5510.00	100.2 PK			2.75 V	96	96.6	3.6
5	*5510.00	91.1 AV			2.75 V	96	87.5	3.6
6	11020.00	42.9 PK	74.0	-31.1	1.53 V	101	28.6	14.3
7	11020.00	31.5 AV	54.0	-22.5	1.53 V	101	17.2	14.3
8	#16530.00	43.3 PK	68.2	-24.9	1.66 V	329	27.6	15.7

REMARKS:

1. Emission Level(dBuV/m) = Raw Value(dBuV) + Correction Factor(dB/m)
2. Correction Factor(dB/m) = Antenna Factor(dB/m) + Cable Factor(dB) – Pre-Amplifier Factor(dB)
3. Margin value = Emission Level – Limit value
4. The other emission levels were very low against the limit.
5. " * ": Fundamental frequency.
6. " # ": The radiated frequency is out of the restricted band.

CHANNEL	TX Channel 110	DETECTOR FUNCTION	Peak (PK)
FREQUENCY RANGE	1GHz ~ 40GHz		Average (AV)

ANTENNA POLARITY & TEST DISTANCE: HORIZONTAL AT 3 M

NO.	FREQ. (MHz)	EMISSION LEVEL (dBuV/m)	LIMIT (dBuV/m)	MARGIN (dB)	ANTENNA HEIGHT (m)	TABLE ANGLE (Degree)	RAW VALUE (dBuV)	CORRECTION FACTOR (dB/m)
1	*5550.00	104.5 PK			1.48 H	126	100.8	3.7
2	*5550.00	95.0 AV			1.48 H	126	91.3	3.7
3	11100.00	45.5 PK	74.0	-28.5	1.24 H	175	31.3	14.2
4	11100.00	34.6 AV	54.0	-19.4	1.24 H	175	20.4	14.2
5	#16650.00	44.4 PK	68.2	-23.8	2.34 H	278	27.9	16.5

ANTENNA POLARITY & TEST DISTANCE: VERTICAL AT 3 M

NO.	FREQ. (MHz)	EMISSION LEVEL (dBuV/m)	LIMIT (dBuV/m)	MARGIN (dB)	ANTENNA HEIGHT (m)	TABLE ANGLE (Degree)	RAW VALUE (dBuV)	CORRECTION FACTOR (dB/m)
1	*5550.00	106.2 PK			2.34 V	91	102.5	3.7
2	*5550.00	96.6 AV			2.34 V	91	92.9	3.7
3	11100.00	45.9 PK	74.0	-28.1	1.66 V	98	31.7	14.2
4	11100.00	34.9 AV	54.0	-19.1	1.66 V	98	20.7	14.2
5	#16650.00	44.7 PK	68.2	-23.5	1.81 V	340	28.2	16.5

REMARKS:

1. Emission Level(dBuV/m) = Raw Value(dBuV) + Correction Factor(dB/m)
2. Correction Factor(dB/m) = Antenna Factor(dB/m) + Cable Factor(dB) – Pre-Amplifier Factor(dB)
3. Margin value = Emission Level – Limit value
4. The other emission levels were very low against the limit.
5. " * ": Fundamental frequency.
6. " # ": The radiated frequency is out of the restricted band.

CHANNEL	TX Channel 134	DETECTOR FUNCTION	Peak (PK)
FREQUENCY RANGE	1GHz ~ 40GHz		Average (AV)

ANTENNA POLARITY & TEST DISTANCE: HORIZONTAL AT 3 M

NO.	FREQ. (MHz)	EMISSION LEVEL (dBuV/m)	LIMIT (dBuV/m)	MARGIN (dB)	ANTENNA HEIGHT (m)	TABLE ANGLE (Degree)	RAW VALUE (dBuV)	CORRECTION FACTOR (dB/m)
1	*5670.00	103.2 PK			1.59 H	133	99.5	3.7
2	*5670.00	94.1 AV			1.59 H	133	90.4	3.7
3	#5725.00	65.4 PK	68.2	-2.8	1.59 H	133	61.6	3.8
4	11340.00	44.8 PK	74.0	-29.2	1.30 H	166	30.7	14.1
5	11340.00	34.0 AV	54.0	-20.0	1.30 H	166	19.9	14.1
6	#17010.00	44.1 PK	68.2	-24.1	2.35 H	274	27.0	17.1

ANTENNA POLARITY & TEST DISTANCE: VERTICAL AT 3 M

NO.	FREQ. (MHz)	EMISSION LEVEL (dBuV/m)	LIMIT (dBuV/m)	MARGIN (dB)	ANTENNA HEIGHT (m)	TABLE ANGLE (Degree)	RAW VALUE (dBuV)	CORRECTION FACTOR (dB/m)
1	*5670.00	104.9 PK			2.55 V	97	101.2	3.7
2	*5670.00	95.9 AV			2.55 V	97	92.2	3.7
3	#5725.00	67.6 PK	68.2	-0.6	2.55 V	97	63.8	3.8
4	11340.00	45.1 PK	74.0	-28.9	1.55 V	105	31.0	14.1
5	11340.00	34.3 AV	54.0	-19.7	1.55 V	105	20.2	14.1
6	#17010.00	44.3 PK	68.2	-23.9	1.75 V	333	27.2	17.1

REMARKS:

1. Emission Level(dBuV/m) = Raw Value(dBuV) + Correction Factor(dB/m)
2. Correction Factor(dB/m) = Antenna Factor(dB/m) + Cable Factor(dB) – Pre-Amplifier Factor(dB)
3. Margin value = Emission Level – Limit value
4. The other emission levels were very low against the limit.
5. " * ": Fundamental frequency.
6. " # ": The radiated frequency is out of the restricted band.

CHANNEL	TX Channel 151	DETECTOR FUNCTION	Peak (PK)
FREQUENCY RANGE	1GHz ~ 40GHz		Average (AV)

ANTENNA POLARITY & TEST DISTANCE: HORIZONTAL AT 3 M

NO.	FREQ. (MHz)	EMISSION LEVEL (dBuV/m)	LIMIT (dBuV/m)	MARGIN (dB)	ANTENNA HEIGHT (m)	TABLE ANGLE (Degree)	RAW VALUE (dBuV)	CORRECTION FACTOR (dB/m)
1	#5638.54	61.6 PK	68.2	-6.6	1.25 H	148	58.0	3.6
2	*5755.00	105.8 PK			1.25 H	148	101.9	3.9
3	*5755.00	96.9 AV			1.25 H	148	93.0	3.9
4	#5991.85	49.1 PK	68.2	-19.1	1.25 H	148	44.7	4.4
5	11510.00	45.5 PK	74.0	-28.5	1.26 H	160	31.3	14.2
6	11510.00	34.7 AV	54.0	-19.3	1.26 H	160	20.5	14.2
7	#17265.00	44.4 PK	68.2	-23.8	2.32 H	266	27.2	17.2

ANTENNA POLARITY & TEST DISTANCE: VERTICAL AT 3 M

NO.	FREQ. (MHz)	EMISSION LEVEL (dBuV/m)	LIMIT (dBuV/m)	MARGIN (dB)	ANTENNA HEIGHT (m)	TABLE ANGLE (Degree)	RAW VALUE (dBuV)	CORRECTION FACTOR (dB/m)
1	#5646.86	61.5 PK	68.2	-6.7	2.76 V	90	57.9	3.6
2	*5755.00	107.4 PK			2.76 V	90	103.5	3.9
3	*5755.00	98.9 AV			2.76 V	90	95.0	3.9
4	#5996.50	48.8 PK	68.2	-19.4	2.76 V	90	44.4	4.4
5	11510.00	45.9 PK	74.0	-28.1	1.61 V	110	31.7	14.2
6	11510.00	35.0 AV	54.0	-19.0	1.61 V	110	20.8	14.2
7	#17265.00	44.9 PK	68.2	-23.3	1.69 V	343	27.7	17.2

REMARKS:

1. Emission Level(dBuV/m) = Raw Value(dBuV) + Correction Factor(dB/m)
2. Correction Factor(dB/m) = Antenna Factor(dB/m) + Cable Factor(dB) – Pre-Amplifier Factor(dB)
3. Margin value = Emission Level – Limit value
4. The other emission levels were very low against the limit.
5. " * ": Fundamental frequency.
6. " # ": The radiated frequency is out of the restricted band.

CHANNEL	TX Channel 159	DETECTOR FUNCTION	Peak (PK)
FREQUENCY RANGE	1GHz ~ 40GHz		Average (AV)

ANTENNA POLARITY & TEST DISTANCE: HORIZONTAL AT 3 M

NO.	FREQ. (MHz)	EMISSION LEVEL (dBuV/m)	LIMIT (dBuV/m)	MARGIN (dB)	ANTENNA HEIGHT (m)	TABLE ANGLE (Degree)	RAW VALUE (dBuV)	CORRECTION FACTOR (dB/m)
1	#5645.19	55.8 PK	68.2	-12.4	1.19 H	150	52.2	3.6
2	*5795.00	106.0 PK			1.19 H	150	102.0	4.0
3	*5795.00	97.4 AV			1.19 H	150	93.4	4.0
4	#5936.14	51.4 PK	68.2	-16.8	1.19 H	150	47.1	4.3
5	11590.00	45.2 PK	74.0	-28.8	1.25 H	172	31.0	14.2
6	11590.00	35.0 AV	54.0	-19.0	1.25 H	172	20.8	14.2
7	#17385.00	44.4 PK	68.2	-23.8	2.37 H	271	26.6	17.8

ANTENNA POLARITY & TEST DISTANCE: VERTICAL AT 3 M

NO.	FREQ. (MHz)	EMISSION LEVEL (dBuV/m)	LIMIT (dBuV/m)	MARGIN (dB)	ANTENNA HEIGHT (m)	TABLE ANGLE (Degree)	RAW VALUE (dBuV)	CORRECTION FACTOR (dB/m)
1	#5647.14	56.8 PK	68.2	-11.4	2.81 V	93	53.2	3.6
2	*5795.00	108.0 PK			2.81 V	93	104.0	4.0
3	*5795.00	99.4 AV			2.81 V	93	95.4	4.0
4	#5926.65	51.9 PK	68.2	-16.3	2.81 V	93	47.7	4.2
5	11590.00	45.5 PK	74.0	-28.5	1.60 V	112	31.3	14.2
6	11590.00	34.9 AV	54.0	-19.1	1.60 V	112	20.7	14.2
7	#17385.00	44.9 PK	68.2	-23.3	1.73 V	351	27.1	17.8

REMARKS:

1. Emission Level(dBuV/m) = Raw Value(dBuV) + Correction Factor(dB/m)
2. Correction Factor(dB/m) = Antenna Factor(dB/m) + Cable Factor(dB) – Pre-Amplifier Factor(dB)
3. Margin value = Emission Level – Limit value
4. The other emission levels were very low against the limit.
5. " * ": Fundamental frequency.
6. " # ": The radiated frequency is out of the restricted band.

802.11ac (VHT80)

CHANNEL	TX Channel 42	DETECTOR FUNCTION	Peak (PK)
FREQUENCY RANGE	1GHz ~ 40GHz		Average (AV)

ANTENNA POLARITY & TEST DISTANCE: HORIZONTAL AT 3 M

NO.	FREQ. (MHz)	EMISSION LEVEL (dBuV/m)	LIMIT (dBuV/m)	MARGIN (dB)	ANTENNA HEIGHT (m)	TABLE ANGLE (Degree)	RAW VALUE (dBuV)	CORRECTION FACTOR (dB/m)
1	5150.00	62.2 PK	74.0	-11.8	1.21 H	159	58.7	3.5
2	5150.00	51.7 AV	54.0	-2.3	1.21 H	159	48.2	3.5
3	*5210.00	96.2 PK			1.21 H	159	92.9	3.3
4	*5210.00	86.4 AV			1.21 H	159	83.1	3.3
5	5350.00	49.7 PK	74.0	-24.3	1.21 H	159	46.4	3.3
6	5350.00	39.1 AV	54.0	-14.9	1.21 H	159	35.8	3.3
7	#10420.00	46.0 PK	68.2	-22.2	1.26 H	168	32.5	13.5
8	15630.00	45.1 PK	74.0	-28.9	2.33 H	277	31.9	13.2
9	15630.00	34.0 AV	54.0	-20.0	2.33 H	277	20.8	13.2

ANTENNA POLARITY & TEST DISTANCE: VERTICAL AT 3 M

NO.	FREQ. (MHz)	EMISSION LEVEL (dBuV/m)	LIMIT (dBuV/m)	MARGIN (dB)	ANTENNA HEIGHT (m)	TABLE ANGLE (Degree)	RAW VALUE (dBuV)	CORRECTION FACTOR (dB/m)
1	5150.00	64.0 PK	74.0	-10.0	2.38 V	85	60.5	3.5
2	5150.00	53.5 AV	54.0	-0.5	2.38 V	85	50.0	3.5
3	*5210.00	98.0 PK			2.38 V	85	94.7	3.3
4	*5210.00	88.3 AV			2.38 V	85	85.0	3.3
5	5350.00	51.1 PK	74.0	-22.9	2.38 V	85	47.8	3.3
6	5350.00	40.4 AV	54.0	-13.6	2.38 V	85	37.1	3.3
7	#10420.00	46.8 PK	68.2	-21.4	1.57 V	101	33.3	13.5
8	15630.00	45.3 PK	74.0	-28.7	1.69 V	329	32.1	13.2
9	15630.00	34.2 AV	54.0	-19.8	1.69 V	329	21.0	13.2

REMARKS:

- Emission Level(dBuV/m) = Raw Value(dBuV) + Correction Factor(dB/m)
- Correction Factor(dB/m) = Antenna Factor(dB/m) + Cable Factor(dB) – Pre-Amplifier Factor(dB)
- Margin value = Emission Level – Limit value
- The other emission levels were very low against the limit.
- " * ": Fundamental frequency.
- " # ": The radiated frequency is out of the restricted band.

CHANNEL	TX Channel 58	DETECTOR FUNCTION	Peak (PK)
FREQUENCY RANGE	1GHz ~ 40GHz		Average (AV)

ANTENNA POLARITY & TEST DISTANCE: HORIZONTAL AT 3 M

NO.	FREQ. (MHz)	EMISSION LEVEL (dBuV/m)	LIMIT (dBuV/m)	MARGIN (dB)	ANTENNA HEIGHT (m)	TABLE ANGLE (Degree)	RAW VALUE (dBuV)	CORRECTION FACTOR (dB/m)
1	5150.00	51.9 PK	74.0	-22.1	1.16 H	151	48.4	3.5
2	5150.00	42.0 AV	54.0	-12.0	1.16 H	151	38.5	3.5
3	*5290.00	96.3 PK			1.16 H	151	93.2	3.1
4	*5290.00	87.7 AV			1.16 H	151	84.6	3.1
5	5350.00	62.0 PK	74.0	-12.0	1.16 H	151	58.7	3.3
6	5350.00	51.0 AV	54.0	-3.0	1.16 H	151	47.7	3.3
7	#10580.00	45.5 PK	68.2	-22.7	1.23 H	154	31.9	13.6
8	15870.00	45.0 PK	74.0	-29.0	2.39 H	289	31.8	13.2
9	15870.00	34.2 AV	54.0	-19.8	2.39 H	289	21.0	13.2

ANTENNA POLARITY & TEST DISTANCE: VERTICAL AT 3 M

NO.	FREQ. (MHz)	EMISSION LEVEL (dBuV/m)	LIMIT (dBuV/m)	MARGIN (dB)	ANTENNA HEIGHT (m)	TABLE ANGLE (Degree)	RAW VALUE (dBuV)	CORRECTION FACTOR (dB/m)
1	5150.00	53.7 PK	74.0	-20.3	2.42 V	78	50.2	3.5
2	5150.00	43.7 AV	54.0	-10.3	2.42 V	78	40.2	3.5
3	*5290.00	98.1 PK			2.42 V	78	95.0	3.1
4	*5290.00	89.5 AV			2.42 V	78	86.4	3.1
5	5350.00	63.6 PK	74.0	-10.4	2.42 V	78	60.3	3.3
6	5350.00	53.3 AV	54.0	-0.7	2.42 V	78	50.0	3.3
7	#10580.00	46.5 PK	68.2	-21.7	1.61 V	109	32.9	13.6
8	15870.00	45.5 PK	74.0	-28.5	1.69 V	321	32.3	13.2
9	15870.00	34.4 AV	54.0	-19.6	1.69 V	321	21.2	13.2

REMARKS:

1. Emission Level(dBuV/m) = Raw Value(dBuV) + Correction Factor(dB/m)
2. Correction Factor(dB/m) = Antenna Factor(dB/m) + Cable Factor(dB) – Pre-Amplifier Factor(dB)
3. Margin value = Emission Level – Limit value
4. The other emission levels were very low against the limit.
5. " * ": Fundamental frequency.
6. " # ": The radiated frequency is out of the restricted band.

CHANNEL	TX Channel 106	DETECTOR FUNCTION	Peak (PK)
FREQUENCY RANGE	1GHz ~ 40GHz		Average (AV)

ANTENNA POLARITY & TEST DISTANCE: HORIZONTAL AT 3 M

NO.	FREQ. (MHz)	EMISSION LEVEL (dBuV/m)	LIMIT (dBuV/m)	MARGIN (dB)	ANTENNA HEIGHT (m)	TABLE ANGLE (Degree)	RAW VALUE (dBuV)	CORRECTION FACTOR (dB/m)
1	5460.00	62.2 PK	74.0	-11.8	1.19 H	137	58.5	3.7
2	5460.00	51.7 AV	54.0	-2.3	1.19 H	137	48.0	3.7
3	#5470.00	63.8 PK	68.2	-4.4	1.19 H	137	60.1	3.7
4	*5530.00	94.5 PK			1.19 H	137	90.8	3.7
5	*5530.00	85.3 AV			1.19 H	137	81.6	3.7
6	#5725.00	48.0 PK	68.2	-20.2	1.19 H	137	44.2	3.8
7	11060.00	45.2 PK	74.0	-28.8	1.24 H	143	30.9	14.3
8	11060.00	34.1 AV	54.0	-19.9	1.24 H	143	19.8	14.3
9	#16590.00	44.1 PK	68.2	-24.1	2.39 H	288	28.2	15.9

ANTENNA POLARITY & TEST DISTANCE: VERTICAL AT 3 M

NO.	FREQ. (MHz)	EMISSION LEVEL (dBuV/m)	LIMIT (dBuV/m)	MARGIN (dB)	ANTENNA HEIGHT (m)	TABLE ANGLE (Degree)	RAW VALUE (dBuV)	CORRECTION FACTOR (dB/m)
1	5460.00	64.1 PK	74.0	-9.9	2.42 V	95	60.4	3.7
2	5460.00	53.4 AV	54.0	-0.6	2.42 V	95	49.7	3.7
3	#5470.00	64.5 PK	68.2	-3.7	2.42 V	95	60.8	3.7
4	*5530.00	96.8 PK			2.42 V	95	93.1	3.7
5	*5530.00	87.7 AV			2.42 V	95	84.0	3.7
6	#5725.00	48.5 PK	68.2	-19.7	2.42 V	95	44.7	3.8
7	11060.00	45.7 PK	74.0	-28.3	1.57 V	95	31.4	14.3
8	11060.00	34.5 AV	54.0	-19.5	1.57 V	95	20.2	14.3
9	#16590.00	44.3 PK	68.2	-23.9	1.73 V	335	28.4	15.9

REMARKS:

1. Emission Level(dBuV/m) = Raw Value(dBuV) + Correction Factor(dB/m)
2. Correction Factor(dB/m) = Antenna Factor(dB/m) + Cable Factor(dB) – Pre-Amplifier Factor(dB)
3. Margin value = Emission Level – Limit value
4. The other emission levels were very low against the limit.
5. " * ": Fundamental frequency.
6. " # ": The radiated frequency is out of the restricted band.

CHANNEL	TX Channel 122	DETECTOR FUNCTION	Peak (PK)
FREQUENCY RANGE	1GHz ~ 40GHz		Average (AV)

ANTENNA POLARITY & TEST DISTANCE: HORIZONTAL AT 3 M

NO.	FREQ. (MHz)	EMISSION LEVEL (dBuV/m)	LIMIT (dBuV/m)	MARGIN (dB)	ANTENNA HEIGHT (m)	TABLE ANGLE (Degree)	RAW VALUE (dBuV)	CORRECTION FACTOR (dB/m)
1	5460.00	63.3 PK	74.0	-10.7	1.15 H	126	59.6	3.7
2	5460.00	49.2 AV	54.0	-4.8	1.15 H	126	45.5	3.7
3	#5470.00	65.4 PK	68.2	-2.8	1.15 H	126	61.7	3.7
4	*5610.00	99.7 PK			1.15 H	126	96.0	3.7
5	*5610.00	91.3 AV			1.15 H	126	87.6	3.7
6	#5725.00	62.1 PK	68.2	-6.1	1.15 H	126	58.3	3.8
7	11220.00	47.4 PK	74.0	-26.6	1.28 H	151	33.6	13.8
8	11220.00	36.0 AV	54.0	-18.0	1.28 H	151	22.2	13.8
9	#16830.00	45.9 PK	68.2	-22.3	2.41 H	299	28.6	17.3

ANTENNA POLARITY & TEST DISTANCE: VERTICAL AT 3 M

NO.	FREQ. (MHz)	EMISSION LEVEL (dBuV/m)	LIMIT (dBuV/m)	MARGIN (dB)	ANTENNA HEIGHT (m)	TABLE ANGLE (Degree)	RAW VALUE (dBuV)	CORRECTION FACTOR (dB/m)
1	5460.00	65.0 PK	74.0	-9.0	2.19 V	81	61.3	3.7
2	5460.00	50.6 AV	54.0	-3.4	2.19 V	81	46.9	3.7
3	#5470.00	67.6 PK	68.2	-0.6	2.19 V	81	63.9	3.7
4	*5610.00	102.0 PK			2.19 V	81	98.3	3.7
5	*5610.00	93.6 AV			2.19 V	81	89.9	3.7
6	#5725.00	63.7 PK	68.2	-4.5	2.19 V	81	59.9	3.8
7	11220.00	48.3 PK	74.0	-25.7	1.63 V	108	34.5	13.8
8	11220.00	36.8 AV	54.0	-17.2	1.63 V	108	23.0	13.8
9	#16830.00	46.5 PK	68.2	-21.7	1.88 V	343	29.2	17.3

REMARKS:

1. Emission Level(dBuV/m) = Raw Value(dBuV) + Correction Factor(dB/m)
2. Correction Factor(dB/m) = Antenna Factor(dB/m) + Cable Factor(dB) – Pre-Amplifier Factor(dB)
3. Margin value = Emission Level – Limit value
4. The other emission levels were very low against the limit.
5. " * ": Fundamental frequency.
6. " # ": The radiated frequency is out of the restricted band.

CHANNEL	TX Channel 155	DETECTOR FUNCTION	Peak (PK)
FREQUENCY RANGE	1GHz ~ 40GHz		Average (AV)

ANTENNA POLARITY & TEST DISTANCE: HORIZONTAL AT 3 M

NO.	FREQ. (MHz)	EMISSION LEVEL (dBuV/m)	LIMIT (dBuV/m)	MARGIN (dB)	ANTENNA HEIGHT (m)	TABLE ANGLE (Degree)	RAW VALUE (dBuV)	CORRECTION FACTOR (dB/m)
1	#5636.66	63.4 PK	68.2	-4.8	1.21 H	141	59.8	3.6
2	*5775.00	101.4 PK			1.21 H	141	97.5	3.9
3	*5775.00	92.2 AV			1.21 H	141	88.3	3.9
4	#5932.74	57.9 PK	68.2	-10.3	1.21 H	141	53.6	4.3
5	11550.00	45.7 PK	74.0	-28.3	1.49 H	188	31.5	14.2
6	11550.00	33.9 AV	54.0	-20.1	1.49 H	188	19.7	14.2
7	#17325.00	45.1 PK	68.2	-23.1	2.01 H	242	27.7	17.4

ANTENNA POLARITY & TEST DISTANCE: VERTICAL AT 3 M

NO.	FREQ. (MHz)	EMISSION LEVEL (dBuV/m)	LIMIT (dBuV/m)	MARGIN (dB)	ANTENNA HEIGHT (m)	TABLE ANGLE (Degree)	RAW VALUE (dBuV)	CORRECTION FACTOR (dB/m)
1	#5647.08	67.5 PK	68.2	-0.7	2.80 V	84	63.9	3.6
2	*5775.00	103.2 PK			2.80 V	84	99.3	3.9
3	*5775.00	94.7 AV			2.80 V	84	90.8	3.9
4	#5933.11	61.8 PK	68.2	-6.4	2.80 V	84	57.5	4.3
5	11550.00	46.9 PK	74.0	-27.1	1.51 V	119	32.7	14.2
6	11550.00	35.1 AV	54.0	-18.9	1.51 V	119	20.9	14.2
7	#17325.00	45.6 PK	68.2	-22.6	1.75 V	337	28.2	17.4

REMARKS:

1. Emission Level(dBuV/m) = Raw Value(dBuV) + Correction Factor(dB/m)
2. Correction Factor(dB/m) = Antenna Factor(dB/m) + Cable Factor(dB) – Pre-Amplifier Factor(dB)
3. Margin value = Emission Level – Limit value
4. The other emission levels were very low against the limit.
5. " * ": Fundamental frequency.
6. " # ": The radiated frequency is out of the restricted band.

Below 1GHz Data:

802.11ac (VHT40)

CHANNEL	TX Channel 54	DETECTOR FUNCTION	Quasi-Peak (QP)
FREQUENCY RANGE	9kHz ~ 1GHz		

ANTENNA POLARITY & TEST DISTANCE: HORIZONTAL AT 3 M								
NO.	FREQ. (MHz)	EMISSION LEVEL (dBuV/m)	LIMIT (dBuV/m)	MARGIN (dB)	ANTENNA HEIGHT (m)	TABLE ANGLE (Degree)	RAW VALUE (dBuV)	CORRECTION FACTOR (dB/m)
1	72.92	32.1 QP	40.0	-7.9	2.00 H	266	43.2	-11.1
2	128.02	40.1 QP	43.5	-3.4	2.00 H	113	49.3	-9.2
3	147.97	36.7 QP	43.5	-6.8	1.50 H	223	44.7	-8.0
4	332.99	29.1 QP	46.0	-16.9	1.50 H	122	35.1	-6.0
5	479.99	40.3 QP	46.0	-5.7	1.00 H	233	42.5	-2.2
6	527.92	37.0 QP	46.0	-9.0	1.50 H	255	38.2	-1.2

REMARKS:

1. Emission Level(dBuV/m) = Raw Value(dBuV) + Correction Factor(dB/m)
2. Correction Factor(dB/m) = Antenna Factor(dB/m) + Cable Factor(dB) – Pre-Amplifier Factor(dB)
3. Margin value = Emission Level – Limit value
4. The other emission levels were very low against the limit of frequency range 30MHz~1000MHz.
5. The emission levels were very low against the limit of frequency range 9kHz~30MHz: the amplitude of spurious emissions attenuated more than 20 dB below the permissible value to be report.

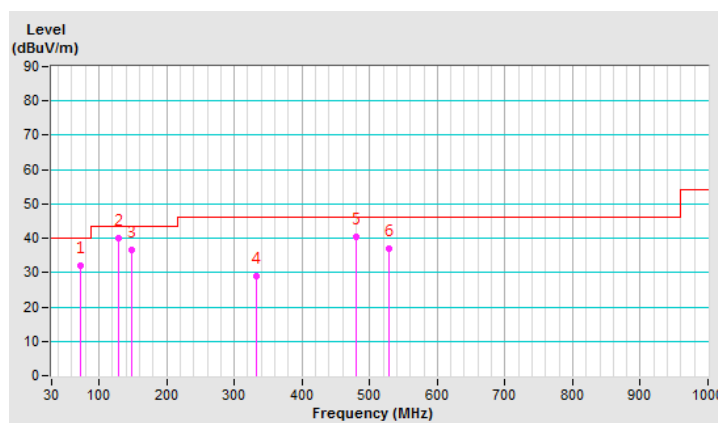

CHANNEL	TX Channel 54	DETECTOR FUNCTION	Quasi-Peak (QP)
FREQUENCY RANGE	9kHz ~ 1GHz		

ANTENNA POLARITY & TEST DISTANCE: VERTICAL AT 3 M

NO.	FREQ. (MHz)	EMISSION LEVEL (dBuV/m)	LIMIT (dBuV/m)	MARGIN (dB)	ANTENNA HEIGHT (m)	TABLE ANGLE (Degree)	RAW VALUE (dBuV)	CORRECTION FACTOR (dB/m)
1	35.80	36.4 QP	40.0	-3.6	1.00 V	311	45.4	-9.0
2	102.25	32.3 QP	43.5	-11.2	1.00 V	296	44.0	-11.7
3	127.78	29.7 QP	43.5	-13.8	1.50 V	288	38.9	-9.2
4	284.80	31.9 QP	46.0	-14.1	1.50 V	255	39.3	-7.4
5	479.99	38.6 QP	46.0	-7.4	1.50 V	199	40.8	-2.2
6	833.31	37.3 QP	46.0	-8.7	1.00 V	300	32.4	4.9

REMARKS:

1. Emission Level(dBuV/m) = Raw Value(dBuV) + Correction Factor(dB/m)
2. Correction Factor(dB/m) = Antenna Factor(dB/m) + Cable Factor(dB) – Pre-Amplifier Factor(dB)
3. Margin value = Emission Level – Limit value
4. The other emission levels were very low against the limit of frequency range 30MHz~1000MHz.
5. The emission levels were very low against the limit of frequency range 9kHz~30MHz: the amplitude of spurious emissions attenuated more than 20 dB below the permissible value to be report.

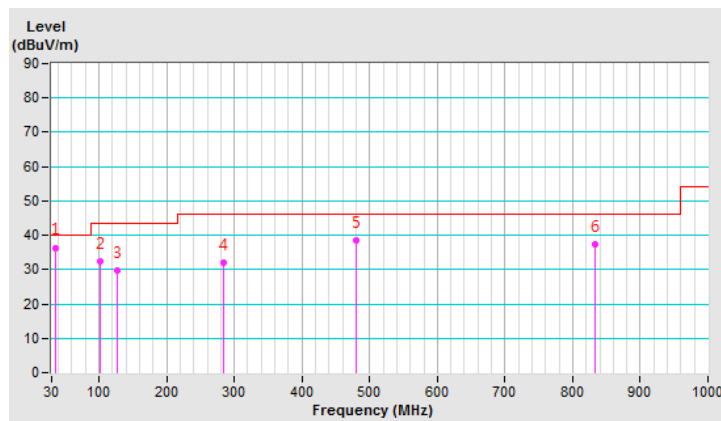

4.2 Conducted Emission Measurement

4.2.1 Limits of Conducted Emission Measurement

Frequency (MHz)	Conducted Limit (dBuV)	
	Quasi-peak	Average
0.15 - 0.5	66 - 56	56 - 46
0.50 - 5.0	56	46
5.0 - 30.0	60	50

Note: 1. The lower limit shall apply at the transition frequencies.

2. The limit decreases in line with the logarithm of the frequency in the range of 0.15 to 0.50MHz.

4.2.2 Test Instruments

DESCRIPTION & MANUFACTURER	MODEL NO.	SERIAL NO.	CALIBRATED DATE	CALIBRATED UNTIL
Test Receiver R&S	ESCS 30	847124/029	Oct. 24, 2018	Oct. 23, 2019
Line-Impedance Stabilization Network (for EUT) R&S	ESH3-Z5	848773/004	Oct. 22, 2018	Oct. 21, 2019
Line-Impedance Stabilization Network (for Peripheral) R&S	ESH3-Z5	835239/001	Mar. 17, 2019	Mar. 16, 2020
50 ohms Terminator	N/A	3	Oct. 22, 2018	Oct. 21, 2019
RF Cable	5D-FB	COCCAB-001	Sep. 28, 2018	Sep. 27, 2019
Fixed attenuator EMCI	STI02-2200-10	003	Mar. 14, 2019	Mar. 13, 2020
Software BVADT	BVADT_Cond_ V7.3.7.4	NA	NA	NA

Note:

1. The calibration interval of the above test instruments are 12 months and the calibrations are traceable to NML/ROC and NIST/USA.
2. The test was performed in Conduction 1.
3. Tested Date: June 19, 2019

4.2.3 Test Procedure

- The EUT was placed 0.4 meters from the conducting wall of the shielded room with EUT being connected to the power mains through a line impedance stabilization network (LISN). Other support units were connected to the power mains through another LISN. The two LISNs provide 50 ohm/ 50uH of coupling impedance for the measuring instrument.
- Both lines of the power mains connected to the EUT were checked for maximum conducted interference.
- The frequency range from 150kHz to 30MHz was searched. Emission levels under (Limit - 20dB) was not recorded.

NOTE: All modes of operation were investigated and the worst-case emissions are reported.

4.2.4 Deviation from Test Standard

No deviation.

4.2.5 Test Setup

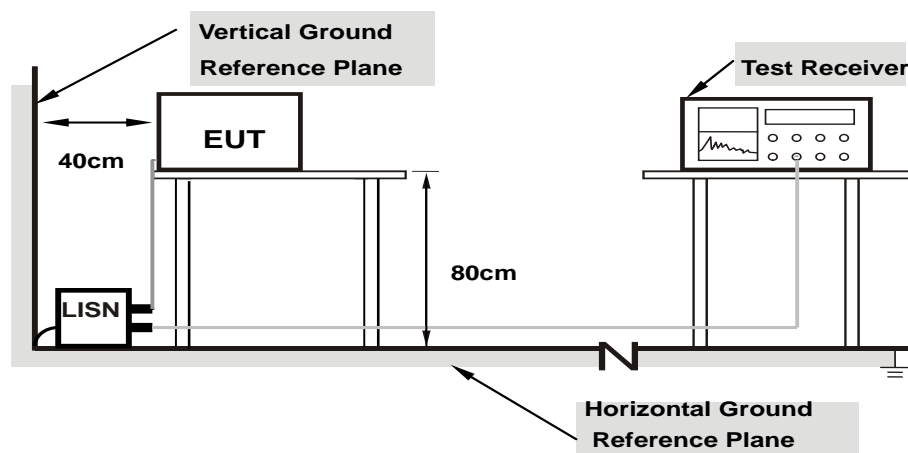

Note: 1.Support units were connected to second LISN.

For the actual test configuration, please refer to the attached file (Test Setup Photo).

4.2.6 EUT Operating Condition

Same as 4.1.6.

4.2.7 Test Results

Phase	Line (L)	Detector Function	Quasi-Peak (QP) / Average (AV)
-------	----------	-------------------	--------------------------------

No	Freq. [MHz]	Corr.	Reading Value		Emission Level		Limit		Margin	
		Factor (dB)	[dB (uV)]		[dB (uV)]		[dB (uV)]		(dB)	
		Q.P.	AV.	Q.P.	AV.	Q.P.	AV.	Q.P.	AV.	
1	0.21641	10.04	41.20	32.11	51.24	42.15	62.96	52.96	-11.72	-10.81
2	0.42344	10.07	30.25	16.69	40.32	26.76	57.38	47.38	-17.06	-20.62
3	0.58750	10.08	23.05	11.02	33.13	21.10	56.00	46.00	-22.87	-24.90
4	7.34375	10.41	22.73	21.27	33.14	31.68	60.00	50.00	-26.86	-18.32
5	12.43750	10.66	21.14	13.80	31.80	24.46	60.00	50.00	-28.20	-25.54
6	24.34766	11.14	31.15	23.18	42.29	34.32	60.00	50.00	-17.71	-15.68

REMARKS:

1. Q.P. and AV. are abbreviations of quasi-peak and average individually.
2. The emission levels of other frequencies were very low against the limit.
3. Margin value = Emission level - Limit value
4. Correction factor = Insertion loss + Cable loss
5. Emission Level = Correction Factor + Reading Value.

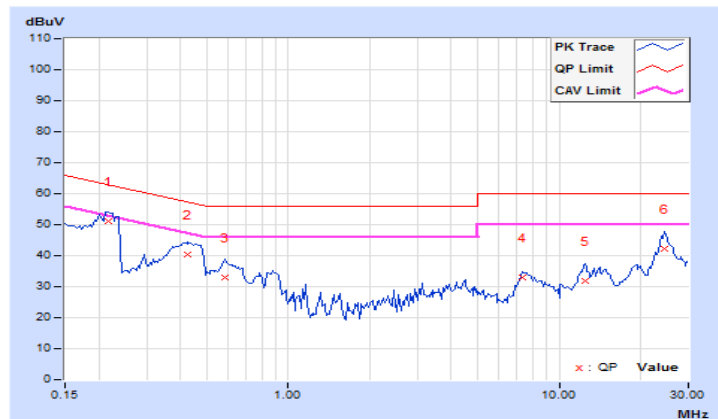

Phase	Neutral (N)	Detector Function	Quasi-Peak (QP) / Average (AV)
-------	-------------	-------------------	--------------------------------

No	Freq. [MHz]	Corr. Factor	Reading Value [dB (uV)]		Emission Level [dB (uV)]		Limit [dB (uV)]		Margin (dB)	
		(dB)	Q.P.	AV.	Q.P.	AV.	Q.P.	AV.	Q.P.	AV.
	1	0.19297	9.94	37.75	35.28	47.69	45.22	63.91	53.91	-16.22
2	0.21250	9.94	40.08	27.85	50.02	37.79	63.11	53.11	-13.09	-15.32
3	0.39219	9.96	31.07	28.59	41.03	38.55	58.02	48.02	-16.99	-9.47
4	0.48984	9.96	29.41	28.47	39.37	38.43	56.17	46.17	-16.80	-7.74
5	0.78281	9.98	28.39	27.83	38.37	37.81	56.00	46.00	-17.63	-8.19
6	24.70703	10.92	29.87	22.10	40.79	33.02	60.00	50.00	-19.21	-16.98

REMARKS:

1. Q.P. and AV. are abbreviations of quasi-peak and average individually.
2. The emission levels of other frequencies were very low against the limit.
3. Margin value = Emission level - Limit value
4. Correction factor = Insertion loss + Cable loss
5. Emission Level = Correction Factor + Reading Value.

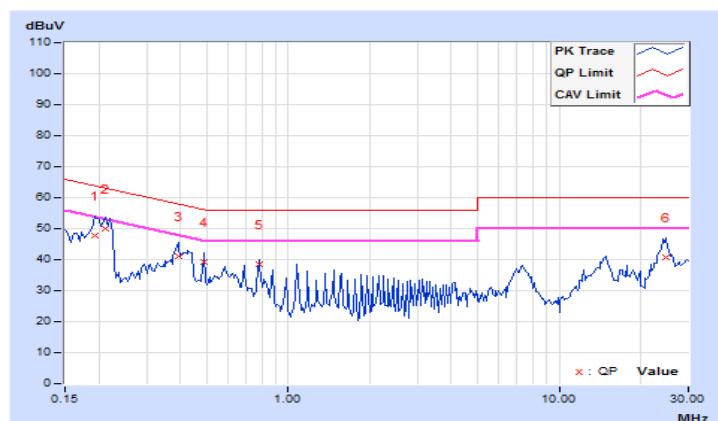

4.3 Transmit Power Measurement

4.3.1 Limits of Transmit Power Measurement

Operation Band	EUT Category		Limit
U-NII-1		Outdoor Access Point	1 Watt (30 dBm) (Max. e.i.r.p \leq 125mW(21 dBm) at any elevation angle above 30 degrees as measured from the horizon)
		Fixed point-to-point Access Point	1 Watt (30 dBm)
		Indoor Access Point	1 Watt (30 dBm)
	√	Client device	250mW (24 dBm)
U-NII-2A		√	250mW (24 dBm) or 11 dBm+10 log B*
U-NII-2C		√	250mW (24 dBm) or 11 dBm+10 log B*
U-NII-3		√	1 Watt (30 dBm)

*B is the 26 dB emission bandwidth in megahertz

4.3.2 Test Setup

FOR POWER OUTPUT MEASUREMENT

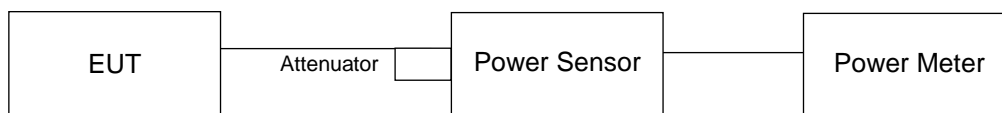

FOR 26dB OCCUPIED BANDWIDTH

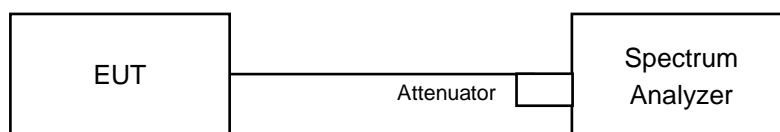

4.3.3 Test Instruments

Refer to section 4.1.2 to get information of above instrument.

4.3.4 Test Procedure

For Average Power Measurement

Method PM is used to perform output power measurement, trigger and gating function of wide band power meter is enabled to measure max output power of TX on burst. Duty factor is not added to measured value.

FOR 26dB OCCUPIED BANDWIDTH

1. Set RBW = approximately 1% of the emission bandwidth.
2. Set the VBW > RBW.
3. Detector = Peak.
4. Trace mode = max hold.
5. Measure the maximum width of the emission that is 26 dB down from the peak of the emission. Compare this with the RBW setting of the analyzer. Readjust RBW and repeat measurement as needed until the RBW/EBW ratio is approximately 1%.

4.3.5 Deviation from Test Standard

No deviation.

4.3.6 EUT Operating Condition

The software provided by client to enable the EUT under transmission condition continuously at lowest, middle and highest channel frequencies individually.

4.3.7 Test Result

802.11a

POWER OUTPUT

Channel	Channel Frequency (MHz)	Maximum Conducted Power (mW)	Maximum Conducted Power (dBm)	Power Limit (dBm)	Pass/Fail
36	5180	64.863	18.12	24.00	Pass
40	5200	68.707	18.37	24.00	Pass
48	5240	74.645	18.73	24.00	Pass
52	5260	76.384	18.83	24.00	Pass
60	5300	77.804	18.91	24.00	Pass
64	5320	80.538	19.06	24.00	Pass
100	5500	39.355	15.95	24.00	Pass
116	5580	71.779	18.56	24.00	Pass
140	5700	49.545	16.95	24.00	Pass
149	5745	75.336	18.77	30.00	Pass
157	5785	73.282	18.65	30.00	Pass
165	5825	67.764	18.31	30.00	Pass

26dB BANDWIDTH:

Channel	Frequency (MHz)	26dBc Bandwidth (MHz)
52	5260	44.77
60	5300	44.47
64	5320	42.93
100	5500	22.07
116	5580	45.16
140	5700	24.69

Note: For U_NII-2A, U_NII-2C Band output power limitation is determined based on 26dBc bandwidth

Power Limit = 11dBm + 10logB < U_NII-2A, U_NII-2C >			
Channel Number	Freq.(MHz)	Min. B(MHz)	Determined Conducted Limit (dBm)
52	5260	44.77	27.5 > 24
60	5300	44.47	27.48 > 24
64	5320	42.93	27.32 > 24
100	5500	22.07	24.43 > 24
116	5580	45.16	27.54 > 24
140	5700	24.69	24.92 > 24

802.11ac (VHT20)

POWER OUTPUT

Channel	Channel Frequency (MHz)	Maximum Conducted Power (mW)	Maximum Conducted Power (dBm)	Power Limit (dBm)	Pass/Fail
36	5180	56.105	17.49	24.00	Pass
40	5200	68.391	18.35	24.00	Pass
48	5240	74.473	18.72	24.00	Pass
52	5260	80.353	19.05	24.00	Pass
60	5300	78.886	18.97	24.00	Pass
64	5320	79.983	19.03	24.00	Pass
100	5500	36.224	15.59	24.00	Pass
116	5580	69.663	18.43	24.00	Pass
140	5700	47.534	16.77	24.00	Pass
149	5745	75.509	18.78	30.00	Pass
157	5785	69.984	18.45	30.00	Pass
165	5825	67.92	18.32	30.00	Pass

26dB BANDWIDTH:

Channel	Frequency (MHz)	26dBc Bandwidth (MHz)
52	5260	47.87
60	5300	45.93
64	5320	47.32
100	5500	22.35
116	5580	48.09
140	5700	45.86

Note: For U_NII-2A, U_NII-2C Band output power limitation is determined based on 26dBc bandwidth

Power Limit = 11dBm + 10logB < U_NII-2A, U_NII-2C >			
Channel Number	Freq.(MHz)	Min. B(MHz)	Determined Conducted Limit (dBm)
52	5260	47.87	27.8 > 24
60	5300	45.93	27.62 > 24
64	5320	47.32	27.75 > 24
100	5500	22.35	24.49 > 24
116	5580	48.09	27.82 > 24
140	5700	45.86	27.61 > 24

802.11ac (VHT40)

POWER OUTPUT

Channel	Channel Frequency (MHz)	Maximum Conducted Power (mW)	Maximum Conducted Power (dBm)	Power Limit (dBm)	Pass/Fail
38	5190	30.974	14.91	24.00	Pass
46	5230	77.625	18.90	24.00	Pass
54	5270	82.035	19.14	24.00	Pass
62	5310	30.832	14.89	24.00	Pass
102	5510	23.823	13.77	24.00	Pass
110	5550	76.384	18.83	24.00	Pass
134	5670	68.549	18.36	24.00	Pass
151	5755	81.846	19.13	30.00	Pass
159	5795	79.25	18.99	30.00	Pass

26dB BANDWIDTH:

Channel	Frequency (MHz)	26dBc Bandwidth (MHz)
54	5270	98.41
62	5310	42.09
102	5510	62.24
110	5550	99.88
134	5670	101.33

Note: For U_NII-2A, U_NII-2C Band output power limitation is determined based on 26dBc bandwidth

Power Limit = 11dBm + 10logB < U_NII-2A, U_NII-2C >			
Channel Number	Freq.(MHz)	Min. B(MHz)	Determined Conducted Limit (dBm)
54	5270	98.41	30.93 > 24
62	5310	42.09	27.24 > 24
102	5510	62.24	28.94 > 24
110	5550	99.88	30.99 > 24
134	5670	101.33	31.05 > 24

802.11ac (VHT80)

POWER OUTPUT

Channel	Channel Frequency (MHz)	Maximum Conducted Power (mW)	Maximum Conducted Power (dBm)	Power Limit (dBm)	Pass/Fail
42	5210	24.155	13.83	24.00	Pass
58	5290	27.04	14.32	24.00	Pass
106	5530	20.045	13.02	24.00	Pass
122	5610	72.778	18.62	24.00	Pass
155	5775	58.614	17.68	30.00	Pass

26dB BANDWIDTH:

Channel	Frequency (MHz)	26dBc Bandwidth (MHz)
58	5290	208.90
106	5530	83.33
122	5610	206.62

Note: For U_NII-2A, U_NII-2C Band output power limitation is determined based on 26dBc bandwidth

Power Limit = 11dBm + 10logB < U_NII-2A, U_NII-2C >			
Channel Number	Freq.(MHz)	Min. B(MHz)	Determined Conducted Limit (dBm)
58	5290	208.90	34.19 > 24
106	5530	83.33	30.2 > 24
122	5610	206.62	34.15 > 24

Spectrum Plot of Worst Value

802.11a: CH100

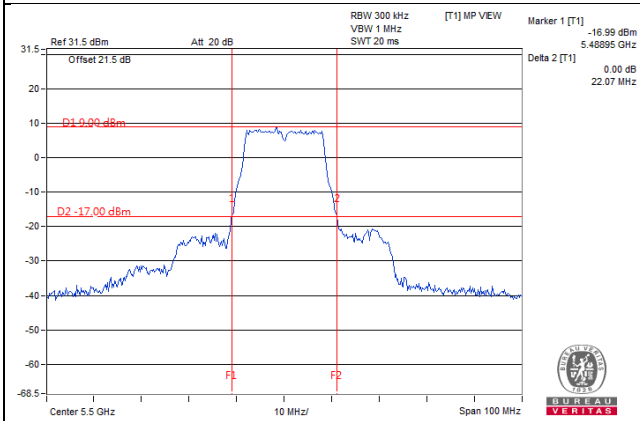

802.11ac (VHT20): CH100

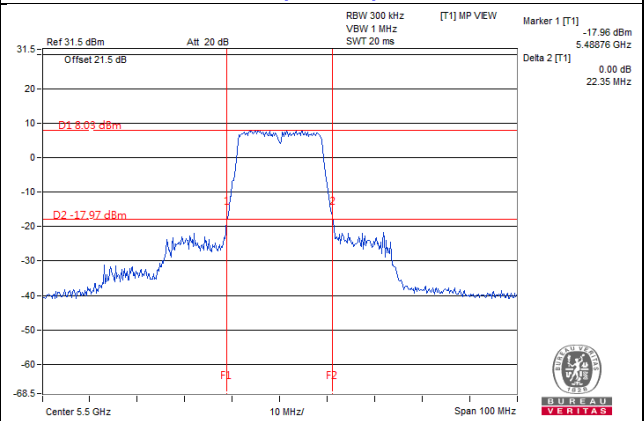

802.11ac (VHT40): CH62

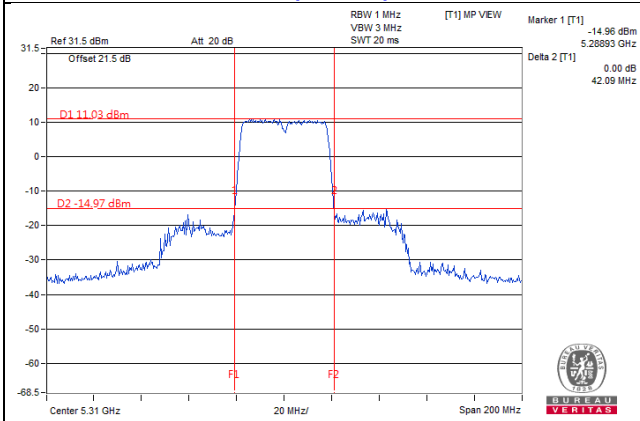

802.11ac (VHT80): CH106

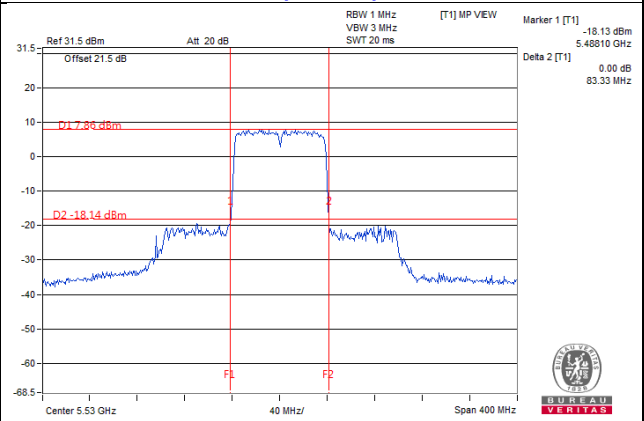

4.4 Occupied Bandwidth Measurement

4.4.1 Test Setup

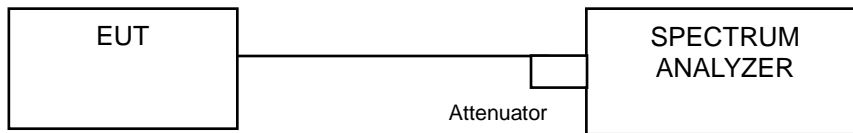

4.4.2 Test Instruments

Refer to section 4.1.2 to get information of above instrument.

4.4.3 Test Procedure

The transmitter output was connected to the spectrum analyzer through an attenuator. The bandwidth of the fundamental frequency was measured by spectrum analyzer with resolution bandwidth in the range of 1% to 5% of the anticipated emission bandwidth, and a video bandwidth at least 3x the resolution bandwidth and set the detector to SAMPLE. The width of a frequency band such that, below the lower and above the upper frequency limits, the mean powers emitted are each equal to a specified percentage 0.5 %of the total mean power of a given emission.

4.4.4 Test Results

802.11a

Channel	Channel Frequency (MHz)	Occupied Bandwidth (MHz)
36	5180	17.64
40	5200	17.88
48	5240	17.64
52	5260	17.28
60	5300	17.40
64	5320	17.40
100	5500	17.04
116	5580	17.28
140	5700	17.52
149	5745	17.88
157	5785	17.52
165	5825	17.40

802.11ac (VHT20)

Channel	Channel Frequency (MHz)	Occupied Bandwidth (MHz)
36	5180	18.36
40	5200	18.48
48	5240	18.60
52	5260	18.48
60	5300	18.36
64	5320	18.48
100	5500	18.12
116	5580	18.36
140	5700	18.12
149	5745	18.48
157	5785	18.48
165	5825	18.48

802.11ac (VHT40)

Channel	Channel Frequency (MHz)	Occupied Bandwidth (MHz)
38	5190	36.72
46	5230	38.16
54	5270	38.16
62	5310	36.96
102	5510	36.72
110	5550	37.92
134	5670	38.40
151	5755	39.36
159	5795	40.80

802.11ac (VHT80)

Channel	Channel Frequency (MHz)	Occupied Bandwidth (MHz)
42	5210	76.32
58	5290	76.32
106	5530	75.84
122	5610	76.80
155	5775	77.28

Spectrum Plot of Max. Value

802.11a: CH149

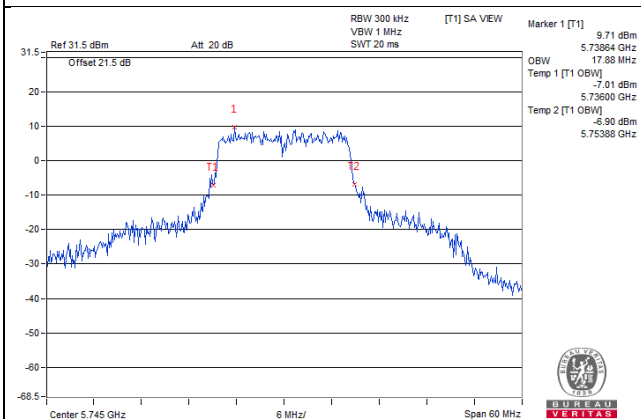

802.11ac (VHT20): CH48

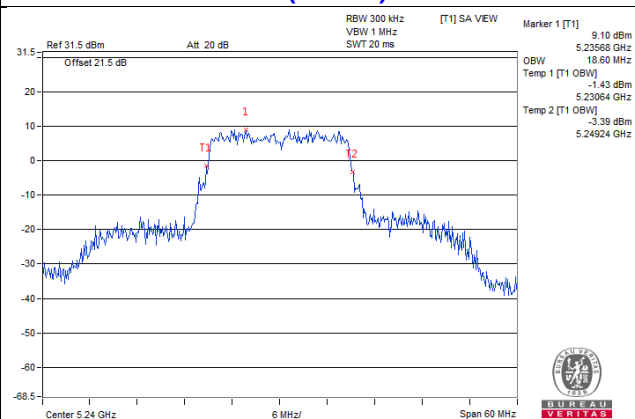

802.11ac (VHT40): CH159

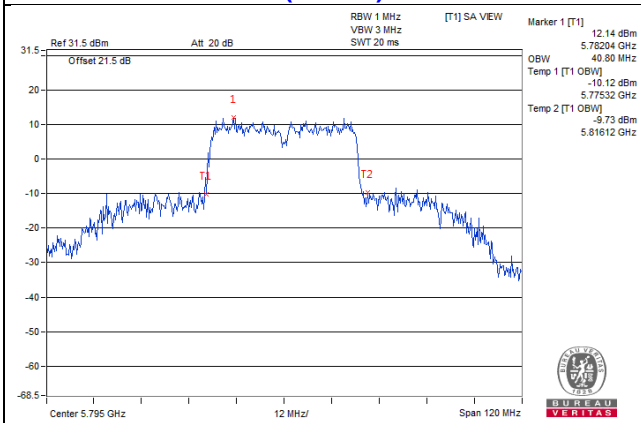

802.11ac (VHT80): CH155

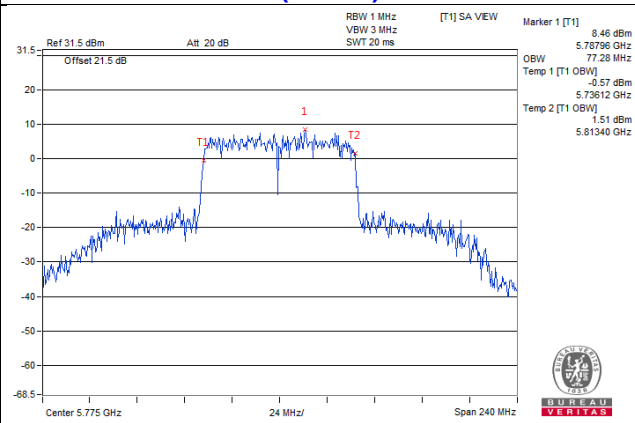

Spectrum Plot for near by DFS band (DFS is required, if 99% OCP straddle into U-NII-2A band)

802.11a / CH48

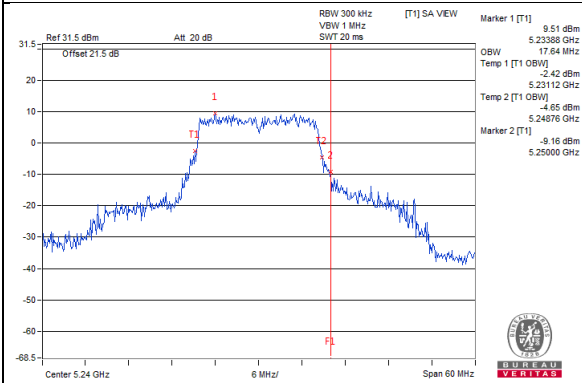

802.11a(VHT20) / CH48

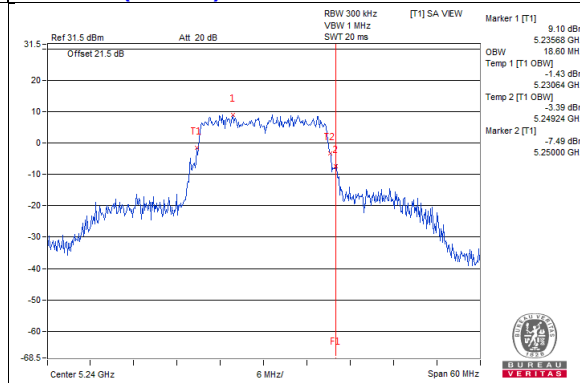

802.11ac(VHT40) / CH46

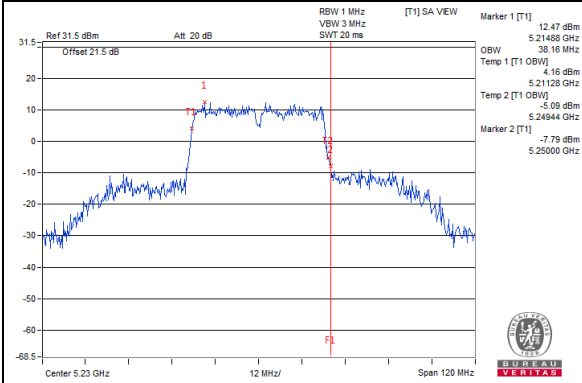

802.11ac(VHT80) / CH42

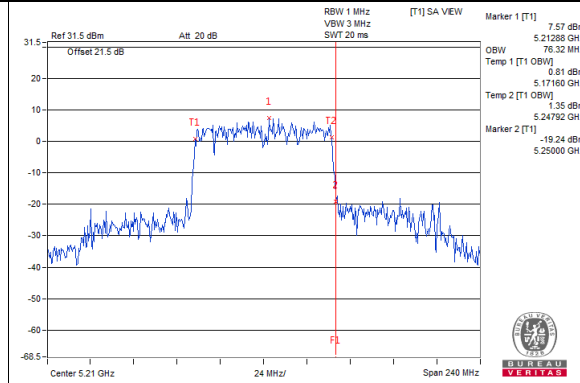

Spectrum Plot for near by DFS band (DFS is required, if 99% OCP straddle into U-NII-2C band)

802.11a / CH149

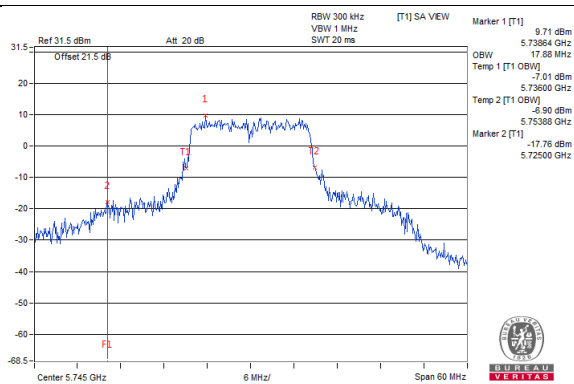

802.11ac(VHT20) / CH149

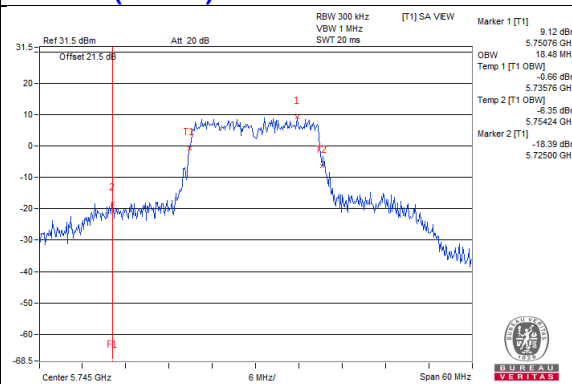

802.11ac(VHT40) / CH151

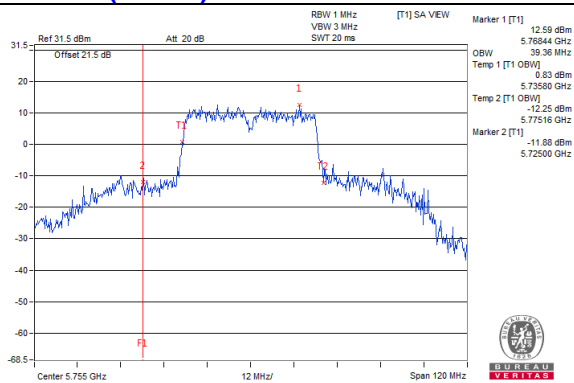

802.11ac(VHT80) / CH155

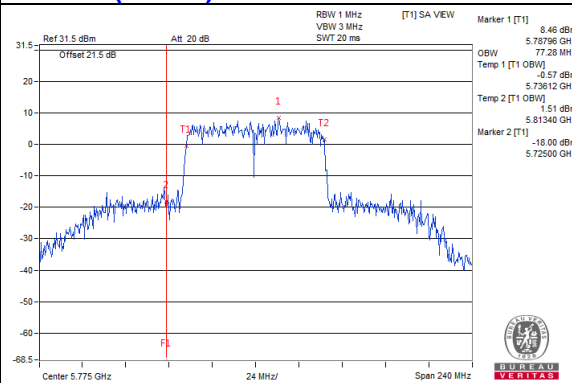

4.5 Peak Power Spectral Density Measurement

4.5.1 Limits of Peak Power Spectral Density Measurement

Operation Band	EUT Category		Limit
U-NII-1		Outdoor Access Point	17dBm/ MHz
		Fixed point-to-point Access Point	
		Indoor Access Point	
	√	Client device	11dBm/ MHz
U-NII-2A		√	11dBm/ MHz
U-NII-2C		√	11dBm/ MHz
U-NII-3		√	30dBm/ 500kHz

4.5.2 Test Setup



4.5.3 Test Instruments

Refer to section 4.1.2 to get information of above instrument.

4.5.4 Test Procedure

For U-NII-1, U-NII-2A, U-NII-2C band:

Using method SA-2

1. Set span to encompass the entire emission bandwidth (EBW) of the signal.
2. Set RBW = 1 MHz, Set VBW ≥ 3 MHz, Detector = RMS
3. Sweep time = auto, trigger set to "free run".
4. Trace average at least 100 traces in power averaging mode.
5. Record the max value and add 10 log (1/duty cycle)

For U-NII-3 band:

1. Set span to encompass the entire emission bandwidth (EBW) of the signal.
2. Set RBW = 300 kHz, Set VBW ≥ 1 MHz, Detector = RMS
3. Use the peak marker function to determine the maximum power level in any 300 kHz band segment within the fundamental EBW.
4. Scale the observed power level to an equivalent value in 500 kHz by adjusting (reducing) the measured power by a bandwidth correction factor (BWCF) where $BWCF = 10\log(500\text{ kHz}/300\text{ kHz})$
5. Sweep time = auto, trigger set to "free run".
6. Trace average at least 100 traces in power averaging mode.
7. Record the max value and add 10 log (1/duty cycle)

4.5.5 Deviation from Test Standard

No deviation.

4.5.6 EUT Operating Condition

Same as Item 4.3.6.

4.5.7 Test Results

For U-NII-1, U-NII-2A, U-NII-2C:

802.11a

Chan.	Chan. Freq. (MHz)	PSD W/O Duty Factor (dBm/MHz)	Duty Factor (dB)	PSD With Duty Factor (dBm/MHz)	MAX. Limit (dBm/MHz)	Pass / Fail
36	5180	-4.77	1.51	-3.26	11.00	Pass
40	5200	-4.19	1.51	-2.68	11.00	Pass
48	5240	0.54	1.51	2.05	11.00	Pass
52	5260	2.53	1.51	4.04	11.00	Pass
60	5300	-2.90	1.51	-1.39	11.00	Pass
64	5320	-3.76	1.51	-2.25	11.00	Pass
100	5500	-5.53	1.51	-4.02	11.00	Pass
116	5580	0.33	1.51	1.84	11.00	Pass
140	5700	-4.22	1.51	-2.71	11.00	Pass

Note: 1. Refer to section 3.3 for duty cycle spectrum plot.

802.11ac (VHT20)

Chan.	Chan. Freq. (MHz)	PSD W/O Duty Factor (dBm/MHz)	Duty Factor (dB)	PSD With Duty Factor (dBm/MHz)	MAX. Limit (dBm/MHz)	Pass / Fail
36	5180	-5.20	1.57	-3.63	11.00	Pass
40	5200	-5.65	1.57	-4.08	11.00	Pass
48	5240	-1.23	1.57	0.34	11.00	Pass
52	5260	-1.34	1.57	0.23	11.00	Pass
60	5300	-3.67	1.57	-2.10	11.00	Pass
64	5320	-4.58	1.57	-3.01	11.00	Pass
100	5500	-8.23	1.57	-6.66	11.00	Pass
116	5580	0.38	1.57	1.95	11.00	Pass
140	5700	-7.39	1.57	-5.82	11.00	Pass

Note: 1. Refer to section 3.3 for duty cycle spectrum plot.

802.11ac (VHT40)

Chan.	Chan. Freq. (MHz)	PSD W/O Duty Factor (dBm/MHz)	Duty Factor (dB)	PSD With Duty Factor (dBm/MHz)	MAX. Limit (dBm/MHz)	Pass / Fail
38	5190	-16.72	2.63	-14.09	11.00	Pass
46	5230	-7.47	2.63	-4.84	11.00	Pass
54	5270	-6.29	2.63	-3.66	11.00	Pass
62	5310	-9.18	2.63	-6.55	11.00	Pass
102	5510	-17.18	2.63	-14.55	11.00	Pass
118	5590	-9.67	2.63	-7.04	11.00	Pass
134	5670	-14.38	2.63	-11.75	11.00	Pass

Note: 1. Refer to section 3.3 for duty cycle spectrum plot.

802.11ac (VHT80)

Chan.	Chan. Freq. (MHz)	PSD W/O Duty Factor (dBm/MHz)	Duty Factor (dB)	PSD With Duty Factor (dBm/MHz)	MAX. Limit (dBm/MHz)	Pass / Fail
42	5210	-19.68	4.13	-15.55	11.00	Pass
58	5290	-16.02	4.13	-11.89	11.00	Pass
106	5530	-18.84	4.13	-14.71	11.00	Pass
122	5610	-13.22	4.13	-9.09	11.00	Pass

Note: 1. Refer to section 3.3 for duty cycle spectrum plot.

Spectrum Plot of Worst Value

802.11a: CH52

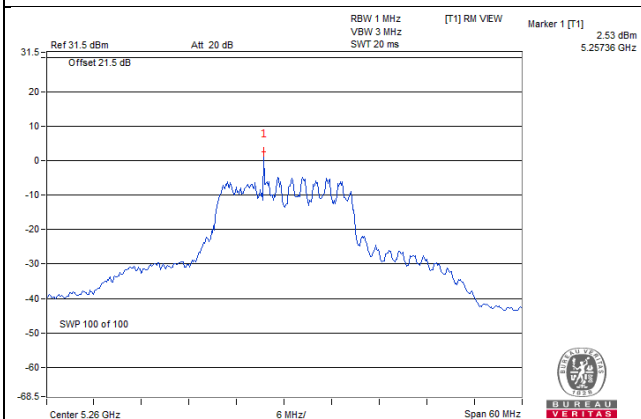

802.11ac (VHT20): CH116

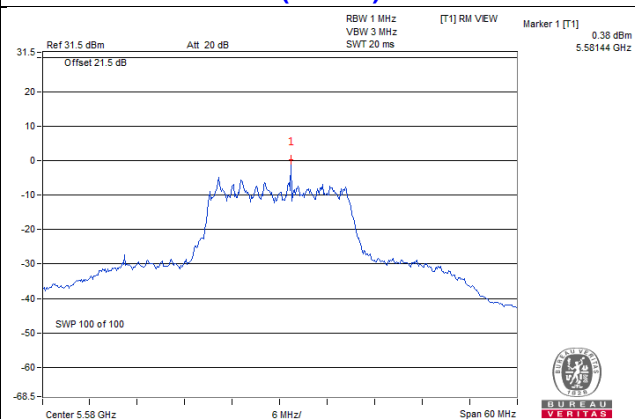

802.11ac (VHT40): CH54

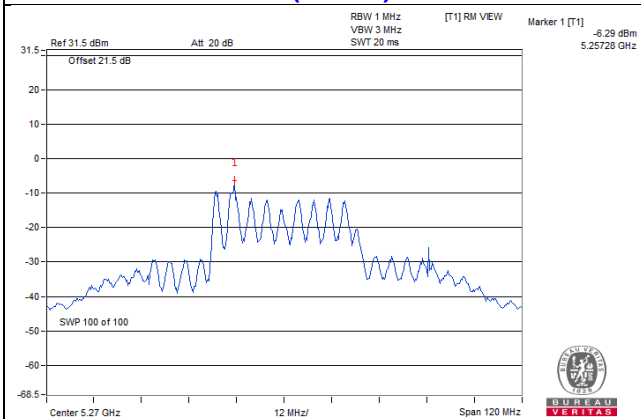

802.11ac (VHT80): CH122

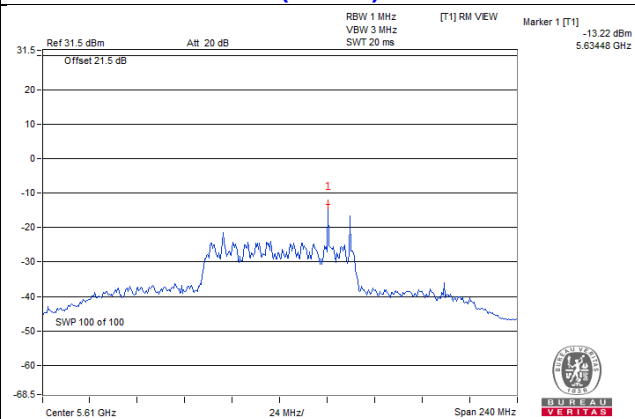

For U-NII-3:
802.11a

Chan.	Freq. (MHz)	PSD W/O Duty Factor (dBm/300kHz)	Duty Factor (dB)	PSD With Duty Factor (dBm/300kHz)	PSD (dBm/500kHz)	Limit (dBm/500kHz)	Pass /Fail
149	5745	-12.18	1.51	-10.67	-8.45	30.00	Pass
157	5785	-13.21	1.51	-11.70	-9.48	30.00	Pass
165	5825	-10.53	1.51	-9.02	-6.80	30.00	Pass

802.11ac (VHT20)

Chan.	Freq. (MHz)	PSD W/O Duty Factor (dBm/300kHz)	Duty Factor (dB)	PSD With Duty Factor (dBm/300kHz)	PSD (dBm/500kHz)	Limit (dBm/500kHz)	Pass /Fail
149	5745	-12.71	1.57	-11.14	-8.92	30.00	Pass
157	5785	-13.24	1.57	-11.67	-9.45	30.00	Pass
165	5825	-7.88	1.57	-6.31	-4.09	30.00	Pass

802.11ac (VHT40)

Chan.	Freq. (MHz)	PSD W/O Duty Factor (dBm/300kHz)	Duty Factor (dB)	PSD With Duty Factor (dBm/300kHz)	PSD (dBm/500kHz)	Limit (dBm/500kHz)	Pass /Fail
151	5755	-13.84	2.63	-11.21	-8.99	30.00	Pass
159	5795	-16.35	2.63	-13.72	-11.50	30.00	Pass

802.11ac (VHT80)

Chan.	Freq. (MHz)	PSD W/O Duty Factor (dBm/300kHz)	Duty Factor (dB)	PSD With Duty Factor (dBm/300kHz)	PSD (dBm/500kHz)	Limit (dBm/500kHz)	Pass /Fail
155	5775	-25.50	4.13	-21.37	-19.15	30.00	Pass

Spectrum Plot of Worst Value

802.11a: CH165

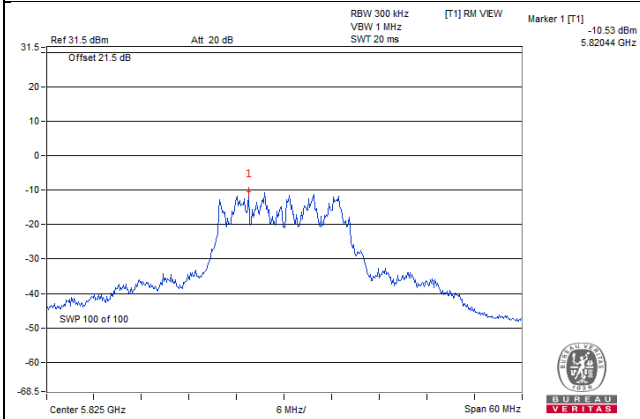

802.11ac (VHT20): CH165

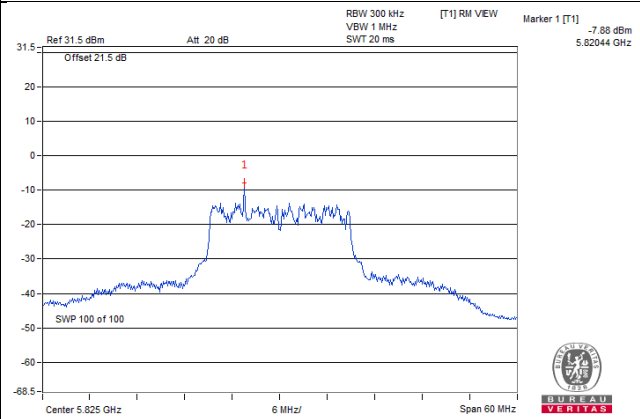

802.11ac (VHT40): CH151

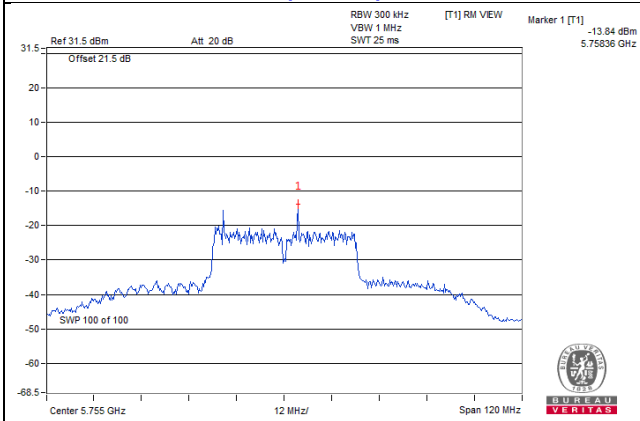

802.11ac (VHT80): CH155

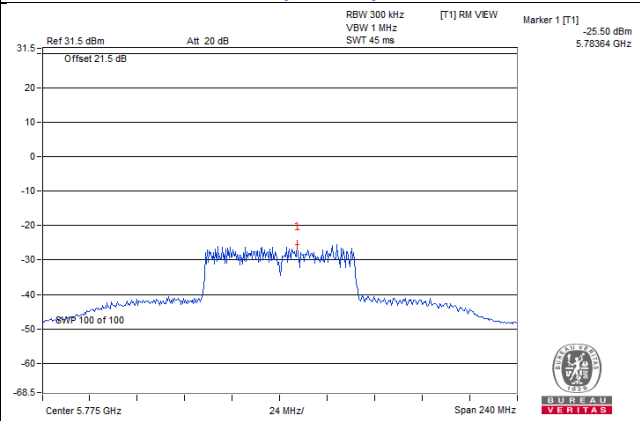

4.6 Frequency Stability Measurement

4.6.1 Limits of Frequency Stability Measurement

The frequency of the carrier signal shall be maintained within band of operation

4.6.2 Test Setup

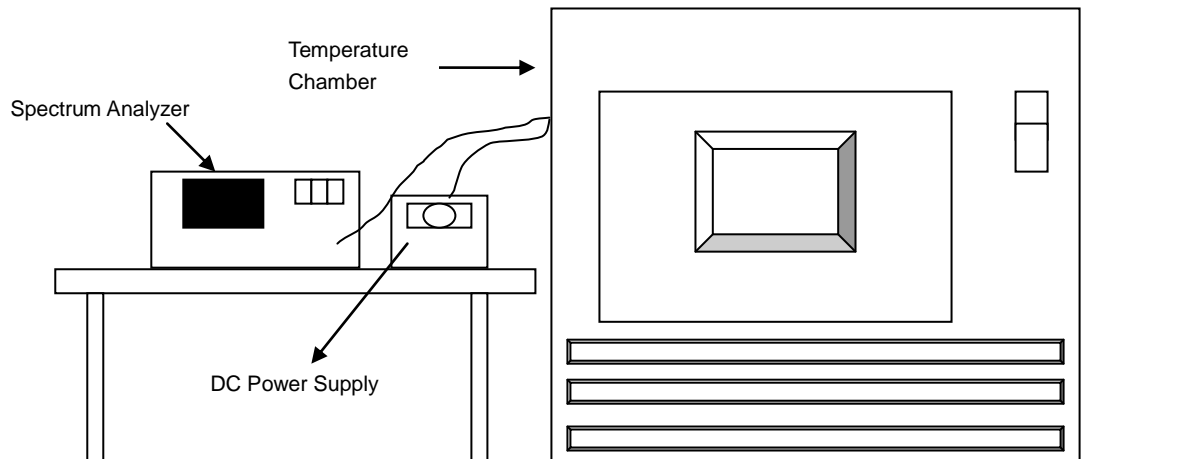

4.6.3 Test Instruments

Refer to section 4.1.2 to get information of above instrument.

4.6.4 Test Procedure

- The EUT was placed inside the environmental test chamber and powered by nominal DC voltage.
- Turn the EUT on and couple its output to a spectrum analyzer.
- Turn the EUT off and set the chamber to the highest temperature specified.
- Allow sufficient time (approximately 30 min) for the temperature of the chamber to stabilize, turn the EUT on and measure the operating frequency after 2, 5, and 10 Minutes.
- Repeat step (d) with the temperature chamber set to the next desired temperature until measurements down to the lowest specified temperature have been completed.
- The test chamber was allowed to stabilize at +20 degree C for a minimum of 30 Minutes. The supply voltage was then adjusted on the EUT from 85% to 115% and the frequency record.

4.6.5 Deviation from Test Standard

No deviation.

4.6.6 EUT Operating Condition

Set the EUT transmit at un-modulation mode to test frequency stability.

4.6.7 Test Results

Frequency Stability Versus Temp.									
Operating Frequency: 5180 MHz									
TEMP. (°C)	Power Supply (Vdc)	0 Minute		2 Minutes		5 Minutes		10 Minutes	
		Measured Frequency (MHz)	Pass/Fail	Measured Frequency (MHz)	Pass/Fail	Measured Frequency (MHz)	Pass/Fail	Measured Frequency (MHz)	Pass/Fail
60	5	5179.9877	PASS	5179.9853	PASS	5179.9836	PASS	5179.9851	PASS
50	5	5179.9869	PASS	5179.9867	PASS	5179.9847	PASS	5179.9861	PASS
40	5	5179.9921	PASS	5179.9927	PASS	5179.9922	PASS	5179.9897	PASS
30	5	5179.9803	PASS	5179.9782	PASS	5179.9818	PASS	5179.9802	PASS
20	5	5179.991	PASS	5179.9954	PASS	5179.9919	PASS	5179.991	PASS
10	5	5180.0239	PASS	5180.0269	PASS	5180.0236	PASS	5180.0256	PASS
0	5	5179.9801	PASS	5179.9767	PASS	5179.9797	PASS	5179.976	PASS
-10	5	5179.9913	PASS	5179.9894	PASS	5179.9894	PASS	5179.9873	PASS

Frequency Stability Versus Voltage									
Operating Frequency: 5180 MHz									
TEMP. (°C)	Power Supply (Vdc)	0 Minute		2 Minutes		5 Minutes		10 Minutes	
		Measured Frequency (MHz)	Pass/Fail	Measured Frequency (MHz)	Pass/Fail	Measured Frequency (MHz)	Pass/Fail	Measured Frequency (MHz)	Pass/Fail
20	5.75	5179.9911	PASS	5179.9944	PASS	5179.9912	PASS	5179.9917	PASS
	5	5179.991	PASS	5179.9954	PASS	5179.9919	PASS	5179.991	PASS
	4.25	5179.9911	PASS	5179.9946	PASS	5179.991	PASS	5179.9913	PASS

4.7 6dB Bandwidth Measurement

4.7.1 Limits of 6dB Bandwidth Measurement

The minimum of 6dB Bandwidth Measurement is 0.5MHz.

4.7.2 Test Setup

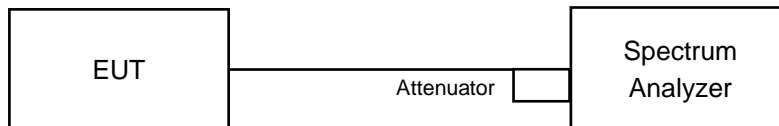

4.7.3 Test Instruments

Refer to section 4.1.2 to get information of above instrument.

4.7.4 Test Procedure

MEASUREMENT PROCEDURE REF

- a. Set resolution bandwidth (RBW) = 100kHz
- b. Set the video bandwidth (VBW) $\geq 3 \times$ RBW, Detector = Peak.
- c. Trace mode = max hold.
- d. Sweep = auto couple.
- e. Measure the maximum width of the emission that is constrained by the frequencies associated with the two amplitude points (upper and lower) that are attenuated by 6 dB relative to the maximum level measured in the fundamental emission

4.7.5 Deviation from Test Standard

No deviation.

4.7.6 EUT Operating Condition

The software provided by client to enable the EUT under transmission condition continuously at lowest, middle and highest channel frequencies individually.

4.7.7 Test Results

802.11a

Channel	Frequency (MHz)	6dB Bandwidth (MHz)	Minimum Limit (MHz)	Pass / Fail
149	5745	16.39	0.5	PASS
157	5785	16.38	0.5	PASS
165	5825	16.38	0.5	PASS

802.11ac (VHT20)

Channel	Frequency (MHz)	6dB Bandwidth (MHz)	Minimum Limit (MHz)	Pass / Fail
149	5745	17.65	0.5	PASS
157	5785	17.64	0.5	PASS
165	5825	17.60	0.5	PASS

802.11ac (VHT40)

Channel	Frequency (MHz)	6dB Bandwidth (MHz)	Minimum Limit (MHz)	Pass / Fail
151	5755	36.41	0.5	PASS
159	5795	36.37	0.5	PASS

802.11ac (VHT80)

Channel	Frequency (MHz)	6dB Bandwidth (MHz)	Minimum Limit (MHz)	Pass / Fail
155	5775	75.61	0.5	PASS

Spectrum Plot of Worst Value

802.11a: CH165

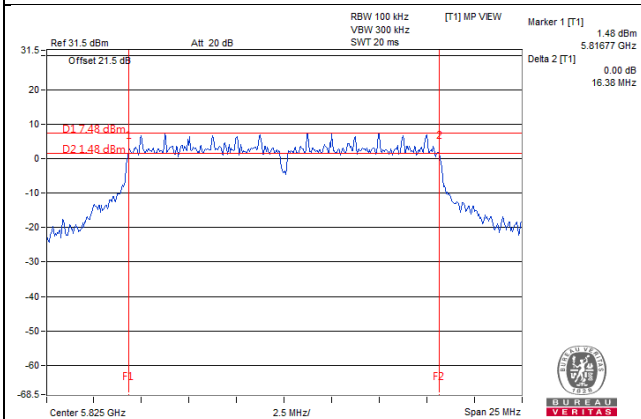

802.11a (VHT20):CH165

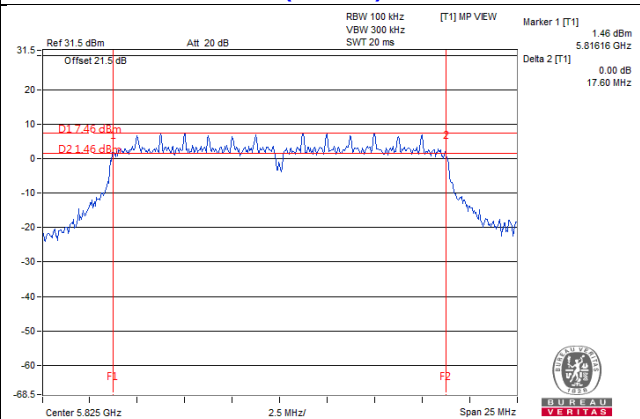

802.11ac (VHT40): CH159

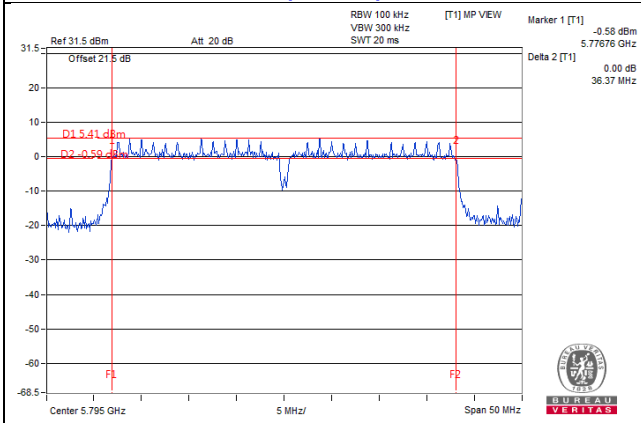

802.11ac (VHT80): CH155

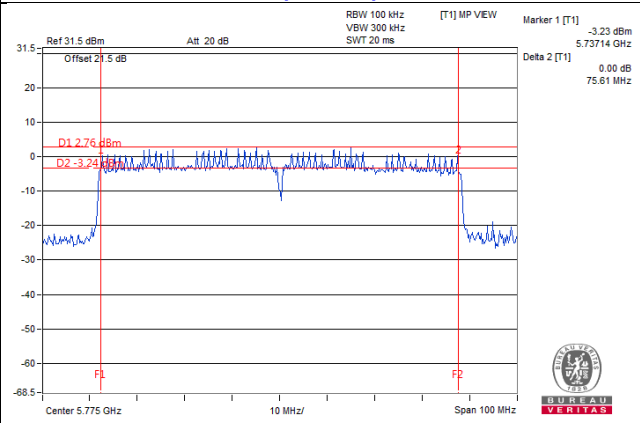

5 Pictures of Test Arrangements

Please refer to the attached file (Test Setup Photo).

Annex A- Radiated Out of Band Emission (OOBE) Measurement (For U-NII-3 band)

802.11a

CH 149 5745 MHz

Horizontal

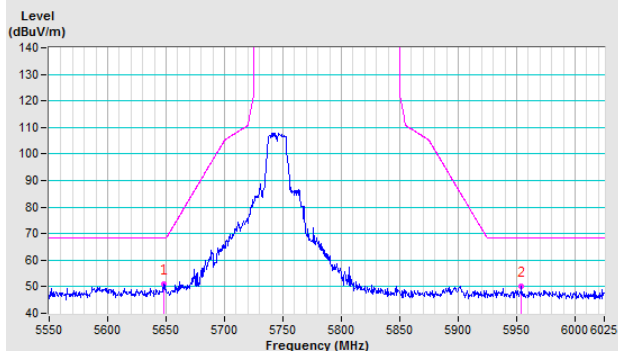

Vertical

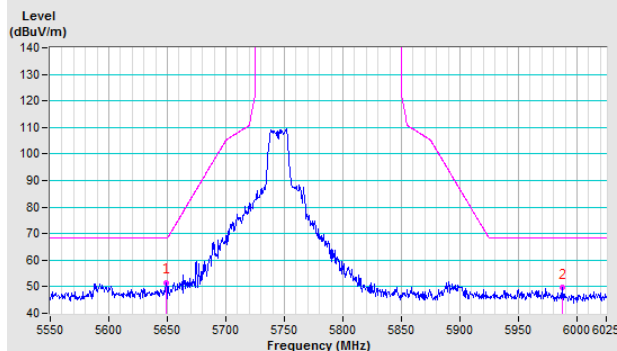

CH 157 5785 MHz

Horizontal

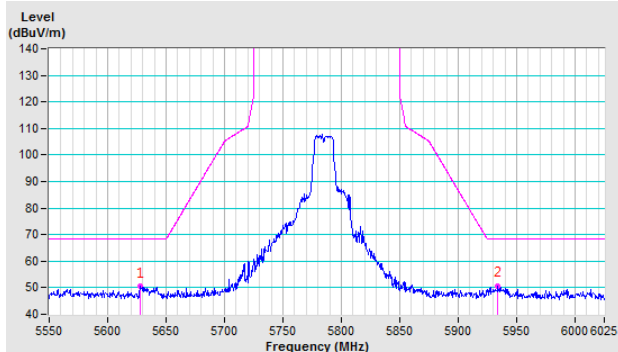

Vertical

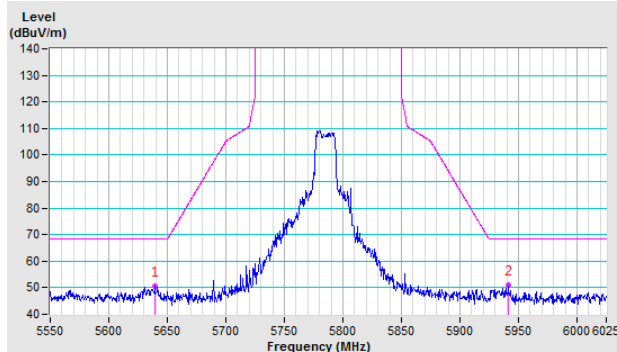

CH 165 5825 MHz

Horizontal

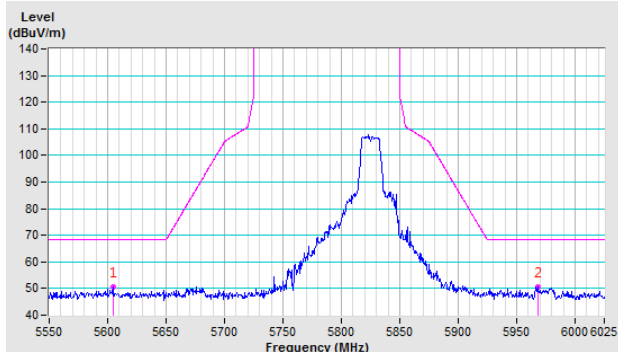

Vertical

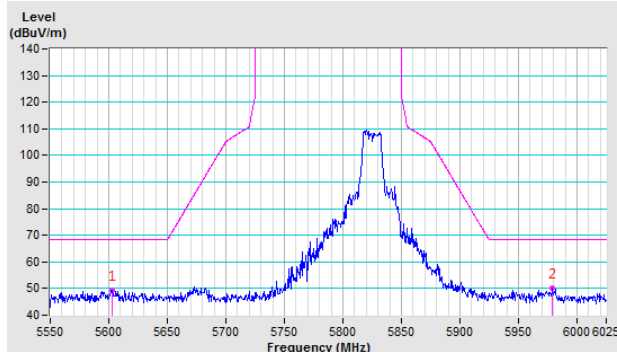

802.11ac (VHT20)

CH 149 5745 MHz

Horizontal

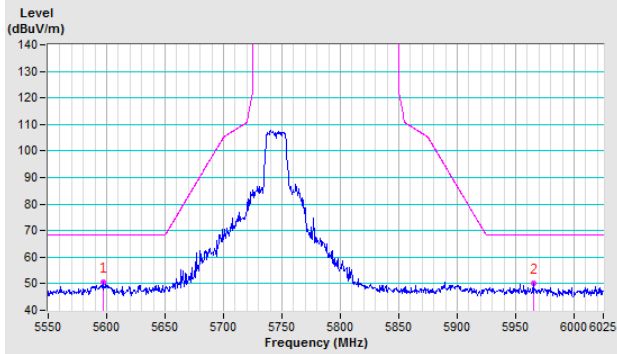

Vertical

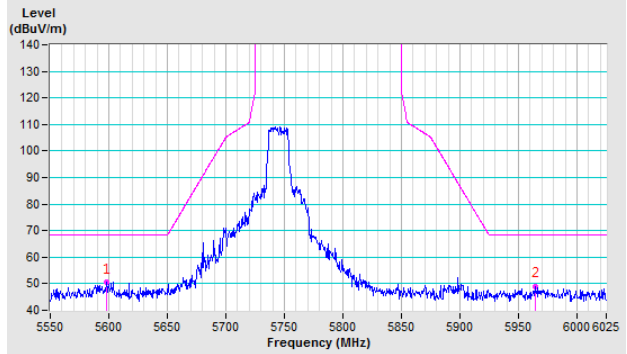

CH 157 5785 MHz

Horizontal

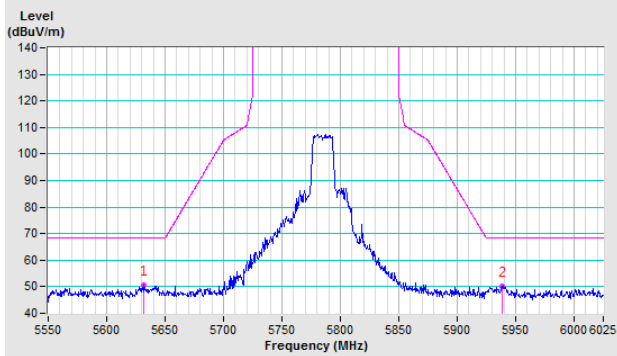

Vertical

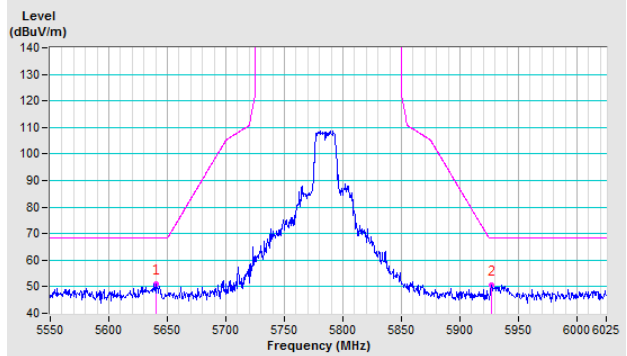

CH 165 5825 MHz

Horizontal

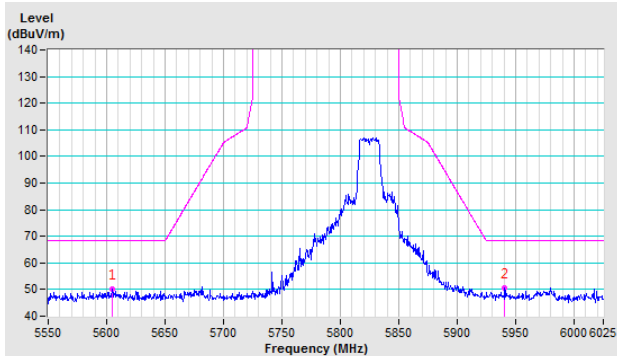

Vertical

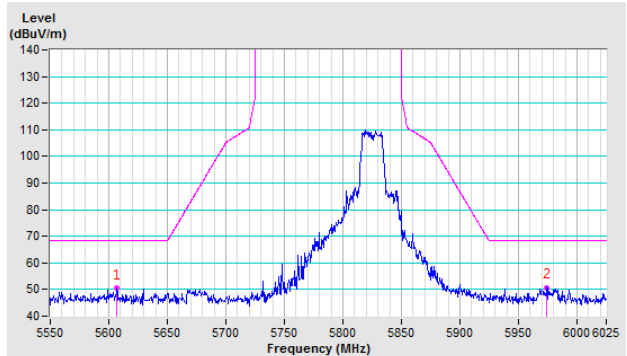

802.11ac (VHT40)

CH 151 5755 MHz

Horizontal

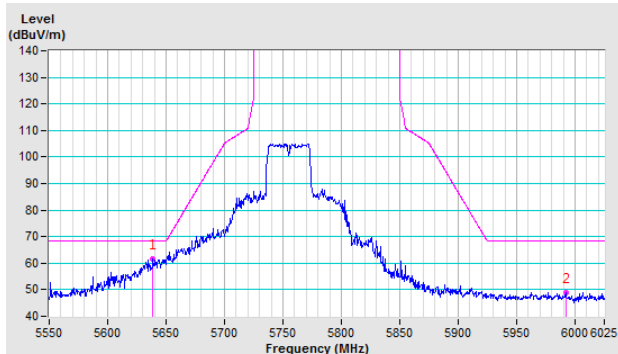

Vertical

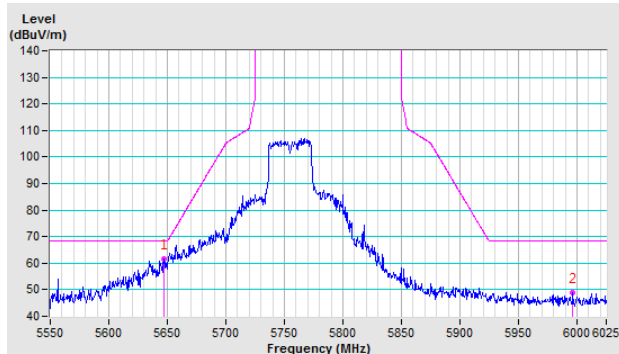

CH 159 5795 MHz

Horizontal

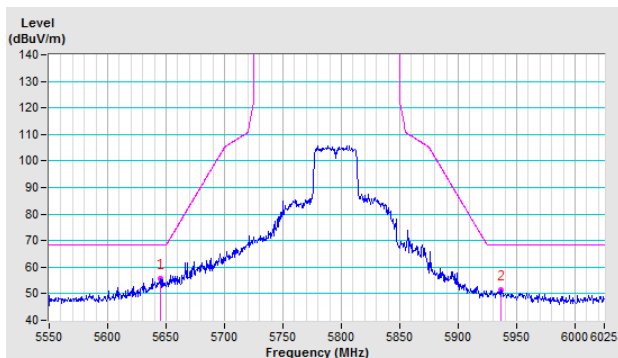

Vertical

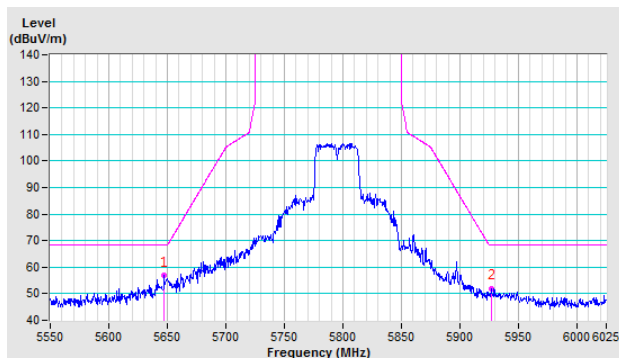

802.11ac (VHT80)

CH 155 5775 MHz

Horizontal

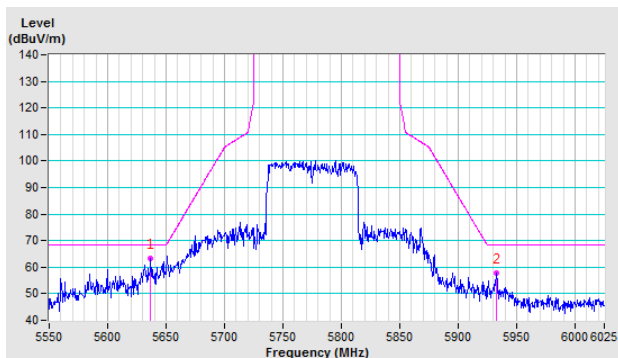

Vertical

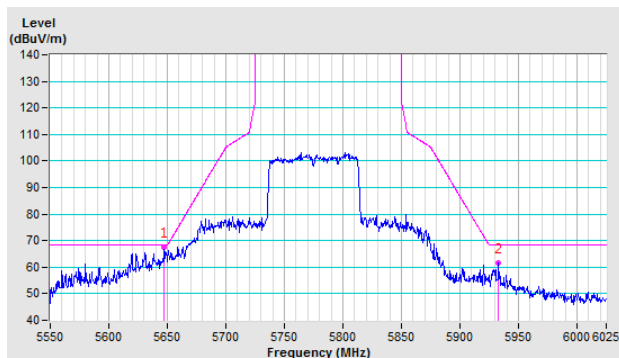

Appendix – Information of the Testing Laboratories

We, Bureau Veritas Consumer Products Services (H.K.) Ltd., Taoyuan Branch, were founded in 1988 to provide our best service in EMC, Radio, Telecom and Safety consultation. Our laboratories are FCC recognized accredited test firms and accredited according to ISO/IEC 17025.

If you have any comments, please feel free to contact us at the following:

Lin Kou EMC/RF Lab

Tel: 886-2-26052180

Fax: 886-2-26051924

Hsin Chu EMC/RF/Telecom Lab

Tel: 886-3-6668565

Fax: 886-3-6668323

Hwa Ya EMC/RF/Safety Lab

Tel: 886-3-3183232

Fax: 886-3-3270892

Email: service.adt@tw.bureauveritas.com

Web Site: www.bureauveritas-adt.com

The address and road map of all our labs can be found in our web site also.

--- END ---