

# **AW-CM358SM**

# **AW-CM358**

**IEEE 802.11a/b/g/n/ac WLAN with  
Bluetooth 5.2 Combo LGA Module**

## **Datasheet**

**Rev. C**

**B1**

**(For Standard)**

## Features

### WLAN

- ◆ 1 antennas to support 1(Transmit) × 1(Receive) technology and Bluetooth
- ◆ High speed wireless connection up to 433.3Mbps transmit/receive PHY rate using 80MHz bandwidth
- ◆ Backward compatibility with legacy 802.11 ac/n/a/g/b technology.
- ◆ 20MHz bandwidth/ channel, 40MHz bandwidth/ channel, upper/ lower 20MHz packets in 40MHz channel, 20MHz duplicate legacy packets in 40MHz channel mode operation.
- ◆ 80MHz bandwidth/ channel, 4 positions of 20MHz packets in 80MHz channel, upper/ lower 40MHz packets in 80MHz channel, 20MHz quadruplicate legacy packets in 80MHz channel mode operation.
- ◆ Dynamic frequency selection (radar detection)

### Bluetooth

- ◆ Baseband and radio BDR and EDR packet types – 1Mbps (GFSK), 2Mbps ( $\pi/4$ -DQPSK), and 3Mbps (8DPSK).
- ◆ Bluetooth 5.2 support.
- ◆ Enhanced Data Rate (EDR) compliant for both 2Mbps and 3Mbps supported.
- ◆ High speed UART and PCM for Bluetooth.
- ◆ Fully functional Bluetooth baseband-AFH, forward error correction, header error control,
- ◆ Enhanced radar detection for long and short pulse radar.
- ◆ Enhanced AGC scheme for DFS channel.
- ◆ 20/40/80Mhz coexistence with middle-packet detection (GI detection) for enhanced CCA.
- ◆ 1 spatial stream STBC reception.
- ◆ LDPC transmission and reception for both 802.11n and 802.11ac.
- ◆ 256 QAM (MCS 8, 9) modulation, optional support for 802.11ac MCS 9 in 20MHz using LDPC.
- ◆ Short guard interval.
- ◆ Temporal Key Integrity Protocol (TKIP)/ Wired Equivalent Privacy (WEP)/ Advanced Encryption Standard (AES)/ Counter-Mode/ CBC-MAC Protocol (CCMP).
- ◆ Cipher-Based Message Authentication Code (CMAC)/ WLAN Authentication and Privacy Infrastructure (WAPI).
- ◆ External Crystal frequency

access code correlation, CRC, encryption bit stream generation, and whitening.

- ◆ Adaptive Frequency Hopping (AFH) using Packet Error Rate (PER).
- ◆ SCO/ eSCO links with hardware accelerated audio signal processing and hardware supported PPEC algorithm for speech quality improvement.
- ◆ Standard Bluetooth power saving mechanisms.

- ◆ Automatic ACL packet type selection.
- ◆ Full master and slave piconet support.
- ◆ Scatternet support.
- ◆ Enhanced Power Control (EPC).
- ◆ Channel Quality Driven Data Rate (CQDDR).
- ◆ Encryption (AES) support.
- ◆ Supports link layer topology to be master and slave (connects up to 16 links).
- ◆ LE Privacy 1.2
- ◆ LE Secure Connection.
- ◆ LE Data Length Extension.
- ◆ 2 Mbps LE
- ◆ Direction Finding – Connectionless Angle of Departure (AoD).
- ◆ Direction Finding – Connection – oriented Angle of Arrival (AoA)



## Table of Contents

<b>Features</b> .....	<b>2</b>
<b>Revision History</b> .....	<b>4</b>
<b>Table of Contents</b> .....	<b>5</b>
<b>1. Introduction</b> .....	<b>6</b>
<b>1.1 Product Overview</b> .....	<b>6</b>
<b>1.2 Block Diagram</b> .....	<b>7</b>
<b>1.3 Specifications Table</b> .....	<b>8</b>
1.3.1 General .....	8
1.3.2 WLAN .....	8
1.3.3 Bluetooth.....	10
1.3.4 Operating Conditions.....	11
<b>2. Pin Definition</b> .....	<b>12</b>
<b>2.1 Pin Map</b> .....	<b>12</b>
<b>2.2 Pin Table</b> .....	<b>13</b>
<b>3. Electrical Characteristics</b> .....	<b>15</b>
<b>3.1 Absolute Maximum Ratings</b> .....	<b>15</b>
<b>3.2 Recommended Operating Conditions</b> .....	<b>15</b>
<b>3.3 Digital IO Pin DC Characteristics</b> .....	<b>15</b>
<b>3.4 Power up Timing Sequence</b> .....	<b>16</b>
3.4.1 SDIO Host Interface Specification .....	17
3.4.2 UART Interface .....	23
3.4.3 Frequency Reference.....	25
<b>3.5 Power Consumption*</b> .....	<b>26</b>
3.5.1 WLAN .....	26
3.5.2 Bluetooth.....	28
<b>4. Mechanical Information</b> .....	<b>29</b>
<b>4.1 Mechanical Drawing</b> .....	<b>29</b>
<b>5. Packaging Information</b> .....	<b>30</b>

## 1. Introduction

### 1.1 Product Overview

**AzureWave Technologies, Inc.** introduces the pioneer of the IEEE 802.11 a/b/g/n/ac WIFI with Bluetooth 5.2 combo SDIO and UART LGA Module --- **AW-CM358**. The AW-CM358 IEEE 802.11 a/b/g/n/ac WIFI with Bluetooth 5.2 combo module is a highly integrated wireless local area network (WLAN) solution to let users enjoy the digital content through the latest wireless technology without using the extra cables and cords. It combines with Bluetooth 4.2 and provides a complete 2.4GHz Bluetooth system which is fully compliant to Bluetooth 4.2 and v2.1 that supports EDR of 2Mbps and 3Mbps for data and audio communications. It enables a high performance, cost effective, low power, compact solution that easily fits onto the SDIO and UART combo LGA module. Generic interfaces include SDIO 3.0 and high-speed UART interfaces for connecting WLAN and Bluetooth technologies to the host processor.

AW-CM358 uses Direct Sequence Spread Spectrum (DSSS), Orthogonal Frequency Division Multiplexing (OFDM), BPSK, QPSK, CCK and QAM baseband modulation technologies. A high level of integration and full implementation of the power management functions specified in the IEEE 802.11 standard minimize the system power requirements by using AW-CM358. In addition to the support of **WPA/WPA2** and **WEP** 64-bit and 128-bit encryption, It also supports the **IEEE 802.11i** security standard through the implementation of **Advanced Encryption Standard (AES)/Counter Mode CBC-MAC Protocol (CCMP)**, **AES/Galois/Counter Mode Protocol (GCMP)**, Wired Equivalent Privacy (**WEP**) with Temporal Key Integrity Protocol (**TKIP**), Advanced Encryption Standard (**AES**)/Cipher-Based Message Authentication Code (**CMAC**), and WLAN Authentication and Privacy Infrastructure (**WAPI**) security mechanisms. For video, voice, and multimedia applications, 802.11e Quality of Service (QoS) is supported. The device also supports 802.11h Dynamic Frequency Selection (DFS) for detecting radar pulses when operating in the 5 GHz range.

Wireless home audio and video entertainment systems including DVT, set-top boxes, blue-ray DVD players, media servers, and gaming consoles. Mobile routers and Internet of Things (IoT) gateways. AW-CM358 module adopts NXP's latest highly-integrated WLAN & Bluetooth SoC---**88W8987**. All the other components are implemented by all means to reach the mechanical specification required.

## 1.2 Block Diagram

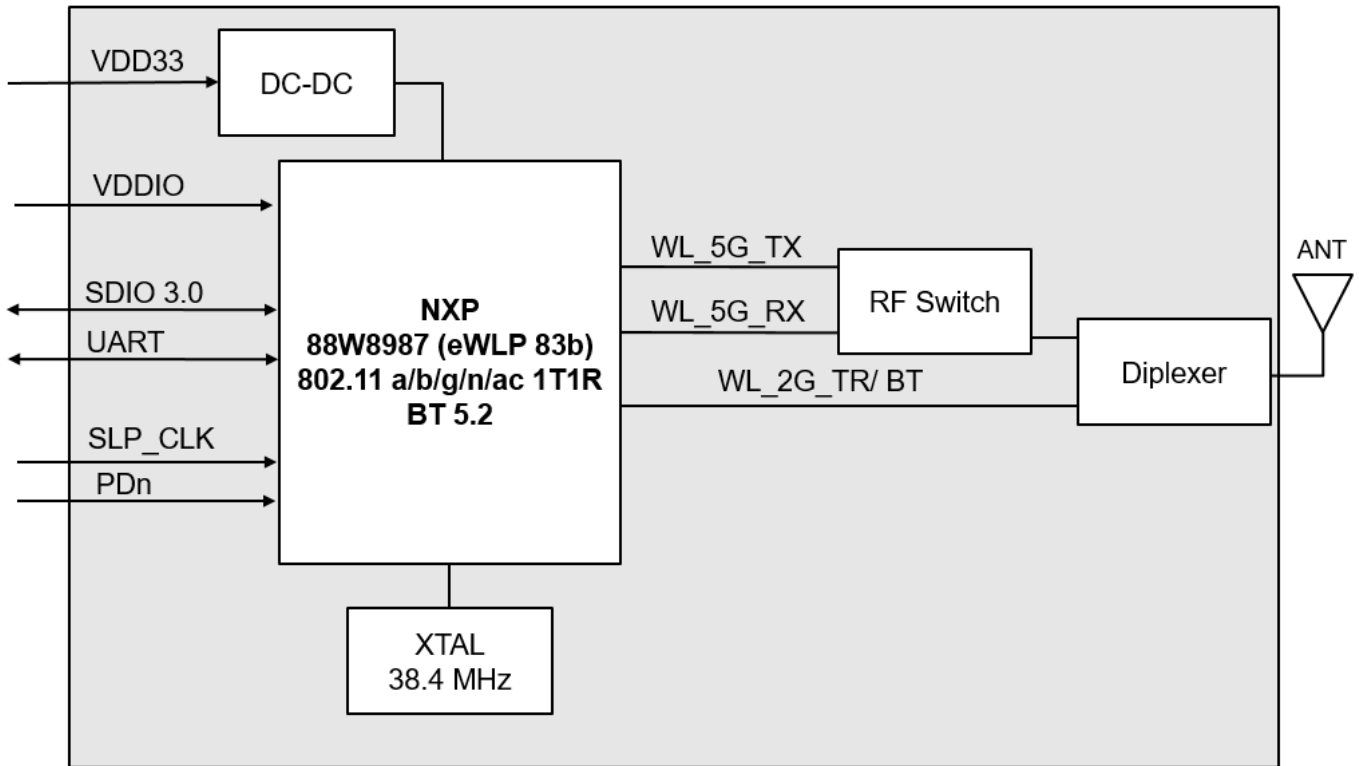

AW-CM358 BLOCK DIAGRAM

## 1.3 Specifications Table

### 1.3.1 General

Features	Description
<b>Product Description</b>	IEEE 802.11 a/b/g/n/ac Wi-Fi with Bluetooth 5.2 combo LGA module
<b>Major Chipset</b>	NXP 88W8987
<b>Host Interface</b>	Wi-Fi + BT ● SDIO + UART
<b>Dimension</b>	12 mm X 12mm x 1.8 mm (Tolerance remarked in mechanical drawing)
<b>Package</b>	LGA module, 47 pins
<b>Antenna</b>	1T1R, external
<b>Weight</b>	0.5 g

### 1.3.2 WLAN

Features	Description
<b>WLAN Standard</b>	IEEE802.11 a/b/g/n/ac
<b>WLAN VID/PID</b>	N/A
<b>WLAN SVID/SPID</b>	N/A
<b>Frequency Range</b>	2.4 GHz ISM Bands 2.412-2.472 GHz 5.15-5.25 GHz (FCC UNII-low band) for US/Canada and Europe 5.25-5.35 GHz (FCC UNII-middle band) for US/Canada and Europe 5.47-5.725 GHz for Europe 5.725-5.825 GHz (FCC UNII-high band) for US/Canada
<b>Modulation</b>	802.11a/g/n/ac: OFDM 802.11b: CCK(11, 5.5Mbps), DQPSK(2Mbps), BPSK(1Mbps)
<b>Number of Channels</b>	802.11b: USA, Canada and Taiwan – 1 ~ 11 Most European Countries – 1 ~ 13 802.11g: USA and Canada – 1 ~ 11 Most European Countries – 1 ~ 13 802.11n: USA and Canada – 1 ~ 11 Most European Countries – 1 ~ 13 802.11a:



	USA – 36, 40, 44, 48, 52, 56, 60, 64, 100, 104, 108, 112, 116, 120, 124, 128, 132, 136, 140, 149, 153, 157, 161, 165				
<b>Output Power (Board Level Limit)*</b>	<b>2.4G</b>				
		Min	Typ	Max	Unit
	11b (11Mbps) @EVM<35%	14	16	18	dBm
	11g (54Mbps) @EVM ≤ -27 dB	12	14	16	dBm
	11n (HT20 MCS7) @EVM ≤ -28 dB	11	13	15	dBm
	11n (HT40 MCS7) @EVM ≤ -28 dB	10	12	14	dBm
	<b>5G</b>				
		Min	Typ	Max	Unit
	11a (54Mbps) @EVM ≤ -27 dB	11	13	15	dBm
	11n (HT20 MCS7) @EVM ≤ -28 dB	8	10	12	dBm
	11n (HT40 MCS7) @EVM ≤ -28 dB	8	10	12	dBm
	11ac (VHT20 MCS8) @EVM ≤ -30 dB	8	10	12	dBm
	11ac (VHT40 MCS9) @EVM ≤ -32 dB	7	9	11	dBm
	11ac (VHT80 MCS9) @EVM ≤ -32 dB	6	8	10	dBm
	<b>Receiver Sensitivity</b>	<b>2.4G</b>			
		Min	Typ	Max	Unit
11b (11Mbps)			-87	-84	dBm
11g (54Mbps)			-73	-70	dBm
11n (HT20 MCS7)			-69	-66	dBm
11n (HT40 MCS7)			-67	-64	dBm
<b>5G</b>					
		Min	Typ	Max	Unit
11a (54Mbps)			-71	-68	dBm
11n (HT20 MCS7)			-67	-64	dBm
11n (HT40 MCS7)			-63	-60	dBm
11ac (VHT20 MCS8)			-67	-64	dBm
11ac (VHT40 MCS9)			-59	-56	dBm
11ac (VHT80 MCS9)			-55	-52	dBm
<b>Data Rate</b>		WLAN: 802.11b : 1, 2, 5.5, 11Mbps			

	802.11a/g : 6, 9, 12, 18, 24, 36, 48, 54Mbps 802.11ac/n : Maximum data rates up to 86.7 Mbps(20MHz channel),200 Mbps (40 MHz channel), 433 Mbps (80 MHz channel)
<b>Security</b>	<ul style="list-style-type: none"> <li>● WPA/WPA2 and WEP 64-bit and 128-bit encryption</li> <li>● Advanced Encryption Standard (AES)/Counter Mode CBC-MAC Protocol (CCMP)</li> <li>● AES/Galois/Counter Mode Protocol (GCMP)</li> <li>● Wired Equivalent Privacy (WEP) /Temporal Key Integrity Protocol (TKIP)</li> <li>● Advanced Encryption Standard (AES)/Cipher-Based Message Authentication Code (CMAC)</li> <li>● WLAN Authentication and Privacy Infrastructure (WAPI)</li> <li>● WPA3</li> </ul>

\* If you have any certification questions about output power please contact FAE directly.

### 1.3.3 Bluetooth

Features	Description				
<b>Bluetooth Standard</b>	BT4.2+Enhanced Data Rate (EDR) Bluetooth 5.2 support				
<b>Bluetooth VID/PID</b>	N/A				
<b>Frequency Range</b>	2402MHz~2483MHz				
<b>Modulation</b>	Header GFSK Payload 2M: $\pi/4$ -DQPSK Payload 3M: 8DPSK				
<b>Output Power</b>		Min	Typ	Max	Unit
	BDR	0	2	4	dBm
	EDR	0	2	4	dBm
	Low Energy	0	2	4	dBm
<b>Receiver Sensitivity</b>	BT Sensitivity (BER<0.1%)				
		Min	Typ	Max	Unit
	GFSK		-88	-86	dBm
	$\pi/4$ -DQPSK		-88	-86	dBm
8DPSK		-80	-78	dBm	

### 1.3.4 Operating Conditions

Features	Description
<b>Operating Conditions</b>	
<b>Voltage</b>	VBAT: 3.07~3.53 VIO : 1.8
<b>Operating Temperature</b>	-30°C to +85°C
<b>Operating Humidity</b>	Less than 85%R.H.
<b>Storage Temperature</b>	-40°C to +85°C
<b>Storage Humidity</b>	Less than 60%R.H.
<b>ESD Protection</b>	
<b>Human Body Model</b>	±2KV per MIL-STD-883H Method 3015.8
<b>Charged Device Model</b>	±500V per JEDEC EIA/JESD22-C101E

## 2. Pin Definition

### 2.1 Pin Map

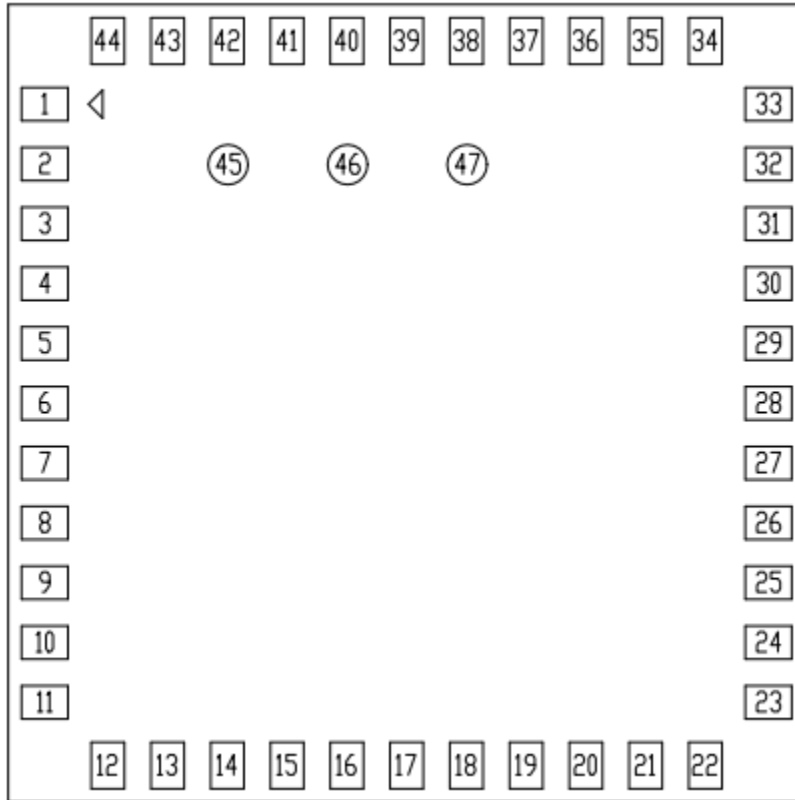

**AW-CM358 Top View Pin Map**

## 2.2 Pin Table

Pin No	Definition	Basic Description	Voltage	Type
1	GND	Ground.		GND
2	WL_BT_ANT	WLAN/BT RF TX/RX path.		RF
3	GND	Ground.		GND
4	NC	Floating Pin, No connect to anything.		Floating
5	NC	Floating Pin, No connect to anything.		Floating
6	HOST_WAKE_B T	Host wake-up Bluetooth device		I
7	BT_WAKE_HOS T	Bluetooth device to wake-up Host		O
8	NC	Floating Pin, No connect to anything.		Floating
9	VBAT	3.3V power pin	3.3V	VCC
10	NC	Floating Pin, No connect to anything.		Floating
11	NC	Floating Pin, No connect to anything.		Floating
12	PDn	Power up/ down internal regulators. 0 = full power-down mode 1 = normal mode Default pull high in module internal		I
13	WL_HOST_WAK E	WLAN to wake-up HOST		O
14	SDIO_DATA2	SDIO Data Line 2		I/O
15	SDIO_DATA3	SDIO Data Line 3		I/O
16	SDIO_CMD	SDIO Command Input		I/O
17	SDIO_CLK	SDIO Clock Input		I
18	SDIO_DATA0	SDIO Data Line 0		I/O
19	SDIO_DATA1	SDIO Data Line 1		I/O
20	GND	Ground.		GND
21	VIN_LDO_OUT	Switch Node of Internal DC-DC convertor	1.8V	VCC
22	VDDIO	1.8V VDDIO supply for WLAN and Bluetooth	1.8V	VCC

23	VIN_LDO	DC-DC convertor to supply AVDD18 of IC	1.8V	VCC
24	SUSCLK_IN	External 32K or RTC clock		I
25	BT_PCM_OUT	PCM data out		O
26	BT_PCM_CLK	PCM Clock		I/O
27	BT_PCM_IN	PCM data Input		I
28	BT_PCM_SYNC	PCM Synchronization control		O
29	NC	Floating Pin, No connect to anything.		Floating
30	NC	Floating Pin, No connect to anything.		Floating
31	GND	Ground.		GND
32	NC	Floating Pin, No connect to anything.		Floating
33	GND	Ground.		GND
34	NC	Floating Pin, No connect to anything.		Floating
35	NC	Floating Pin, No connect to anything.		Floating
36	GND	Ground.		GND
37	NC	Floating Pin, No connect to anything.		Floating
38	NC	Floating Pin, No connect to anything.		Floating
39	HOST_WL_WAKE	Host wake-up WLAN device		Floating
40	NC	Floating Pin, No connect to anything.		Floating
41	UART_RTS_N	High-Speed UART RTS		O
42	UART_TXD	High-Speed UART Data Out		O
43	UART_RXD	High-Speed UART Data In		I
44	UART_CTS_N	High-Speed UART CTS		I
45	TP1 (NC)	Floating Pin, No connect to anything.		Floating
46	TP2 (NC)	Floating Pin, No connect to anything.		Floating
47	TP3 (NC)	Floating Pin, No connect to anything.		Floating

### 3. Electrical Characteristics

#### 3.1 Absolute Maximum Ratings

Symbol	Parameter	Minimum	Typical	Maximum	Unit
<b>VDD33</b>	DC supply for the 3.3V input	2.5	3.3	4.0	V
<b>VDDIO</b>	DC supply voltage for digital I/O		1.8	2.2	V

#### 3.2 Recommended Operating Conditions

Symbol	Parameter	Minimum	Typical	Maximum	Unit
<b>VDD33</b>	DC supply for the 3.3V input	3.07	3.3	3.53	V
<b>VDDIO</b>	DC supply voltage for digital I/O	1.67	1.8	1.98	V

#### 3.3 Digital IO Pin DC Characteristics

Symbol	Parameter	Minimum	Typical	Maximum	Unit
<b>Digital I/O pins, VDDIO=1.8V</b>					
<b>V<sub>IH</sub></b>	Input high voltage	1.26	-	2.2	V
<b>V<sub>IL</sub></b>	Input low voltage	-0.4	-	0.54	V
<b>V<sub>OH</sub></b>	Output High Voltage	1.4	-	-	V
<b>V<sub>OL</sub></b>	Output Low Voltage	-	-	0.4	V

### 3.4 Power up Timing Sequence

#### Power-up Sequence

VDDIO/PDn no specific time requirement, just need to follow up the power on sequence waveform.

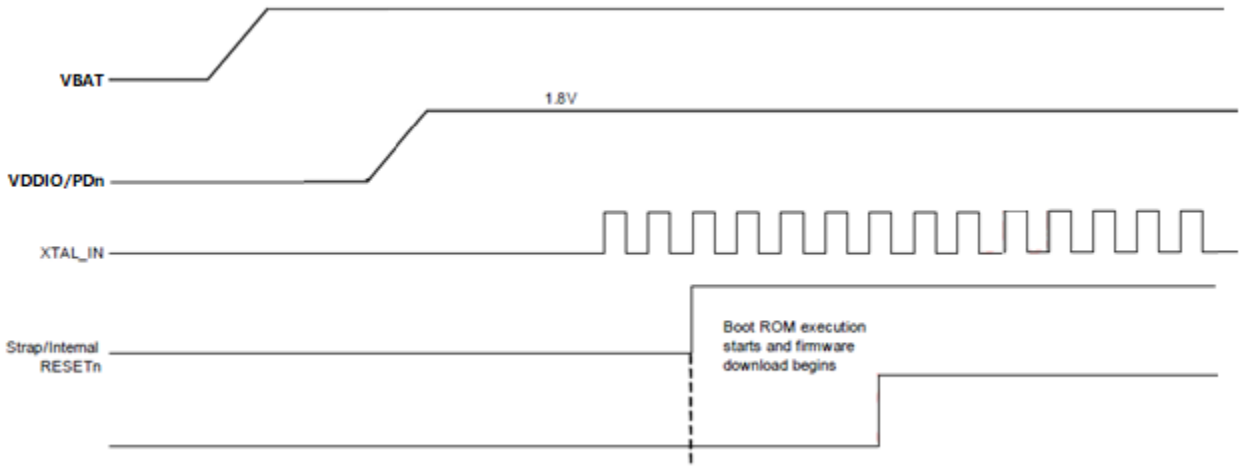

#### Power-down Sequence

The table is AW-CM358 module power down sequence, the maximum ramp-down time for PDn from VBAT assertion is 10ms. VBAT must be asserted a minimum of 100 ms to guarantee that PDn are discharged to less than 0.2V for the POR generate properly after VBAT is deasserted.

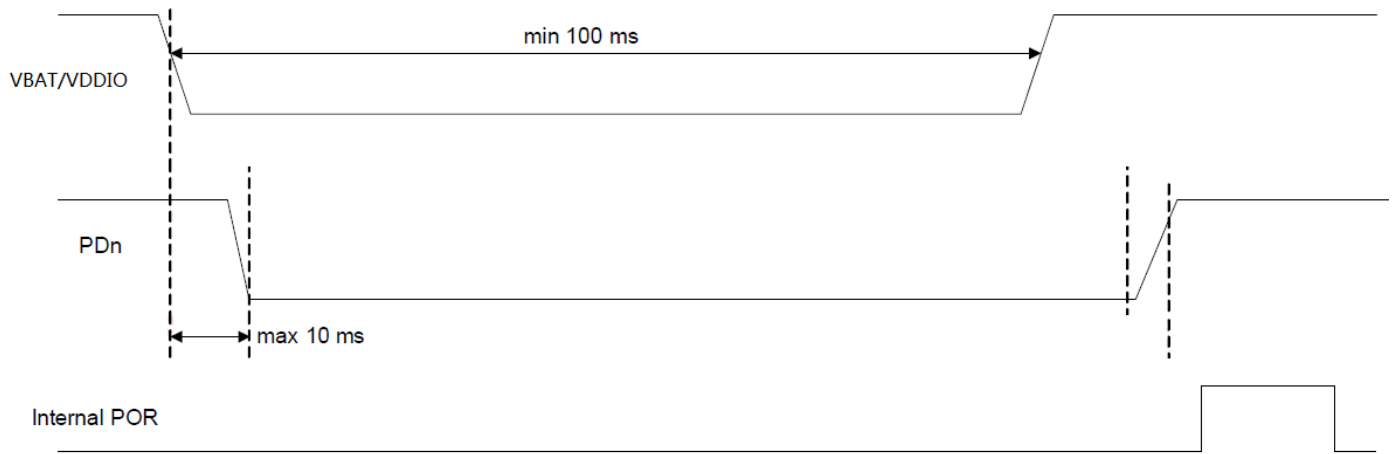



### 3.4.1 SDIO Host Interface Specification

The AW-CM358 supports a SDIO device interface that conforms to the industry SDIO Full-Speed card specification and allows a host controller using the SDIO bus protocol to access the Wireless SoC device.

The AW-CM358 acts as the device on the SDIO bus. The host unit can access registers of the SDIO interface directly and can access shared memory in the device through the use of BARs and a DMA engine.

- ◆ Support SDIO 3.0 Standard.
- ◆ On-chip memory used for CIS.
- ◆ Supports 4-bit SDIO and 1-bit SDIO transfer modes.
- ◆ Special interrupt register for information exchange.

#### SDIO Interface Signals

AW-CM358 SDIO Pin Name	Type	Description
SDIO_DATA_CLK	I	SDIO 4-bit mode: Clock SDIO 1-bit mode: Clock
SDIO_DATA_CMD	I/O	SDIO 4-bit mode: Command line SDIO 1-bit mode: Command line
SDIO_DATA_3	I/O	SDIO 4-bit mode: Data line Bit[3] SDIO 1-bit mode: Not used
SDIO_DATA_2	I/O	SDIO 4-bit mode: Data line Bit[2] or Read Wait (optional) SDIO 1-bit mode: Read Wait (optional)
SDIO_DATA_1	I/O	SDIO 4-bit mode: Data line Bit[1] SDIO 1-bit mode: Interrupt
SDIO_DATA_0	I/O	SDIO 4-bit mode: Data line Bit[0] SDIO 1-bit mode: Data line

## Default Speed, High-Speed Modes

### SDIO Protocol Timing Diagram – Default Speed Mode

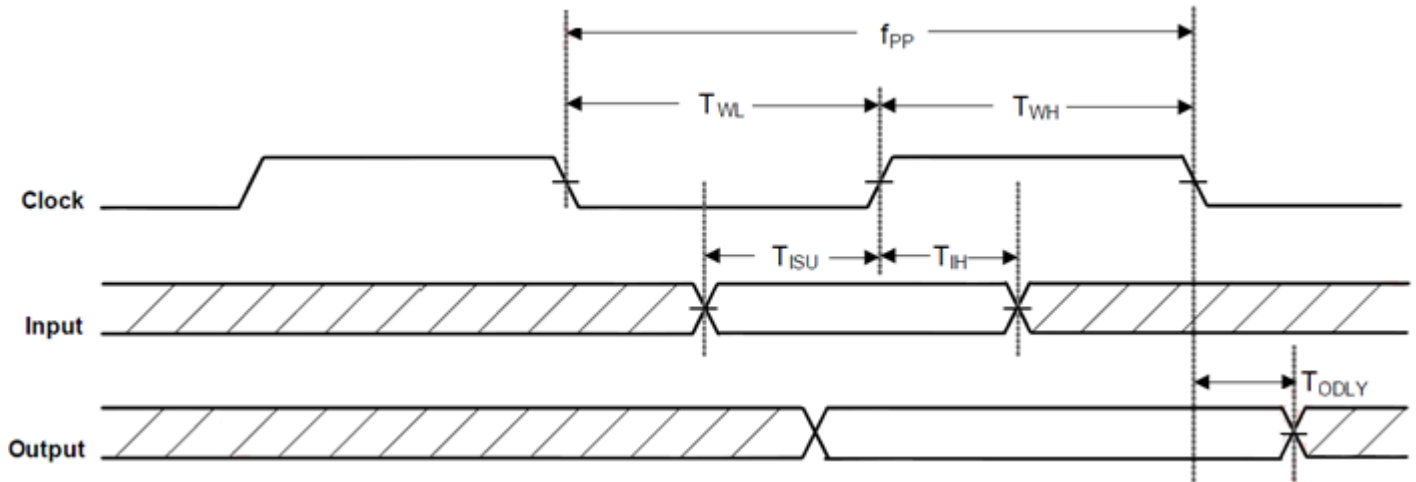

### SDIO Protocol Timing Diagram – High Speed Mode

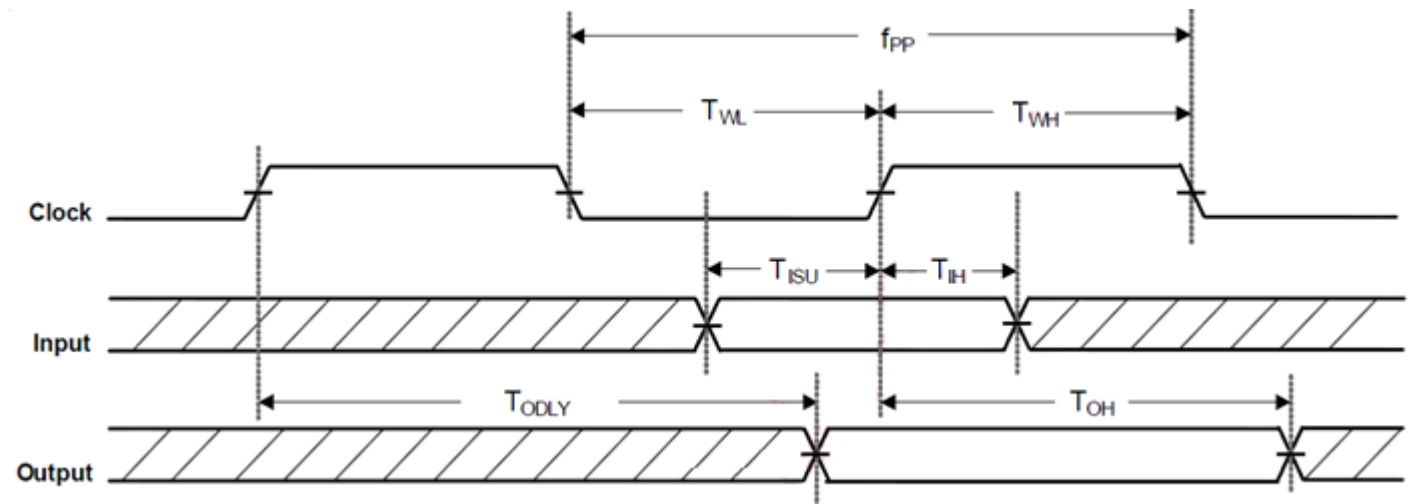

### SDIO Timing Data- Default Speed, High-Speed Modes

Symbol	Parameter	Condition	Min	Max	Units
$f_{pp}$	CLK Frequency	Normal	0	25	MHz
		High Speed	0	50	
$t_{WL}$	CLK low Time	Normal	10	-	ns
		High Speed	7	-	
$t_{WH}$	CLK High Time	Normal	10	-	
		High Speed	7	-	

<b>t<sub>ISU</sub></b>	Input Setup Time	Normal	5	-	
		High Speed	6	-	
<b>t<sub>IH</sub></b>	Input Hold Time	Normal	5	-	
		High Speed	2	-	
<b>t<sub>ODLY</sub></b>	Output Delay Time	Normal	-	14	
		High Speed	-	14	
<b>T<sub>OH</sub></b>	Output hold time	High Speed	2.5		

1. For SDIO 2.0 running at 50MHz clock frequency, only 1.8V is supported.
2. For SDIO 2.0 running at 25MHz clock frequency, 1.8V is supported.

### SDIO Protocol Timing Diagram – SDR12, SDR25, SDR50 Modes (up to 100MHz) (1.8V)

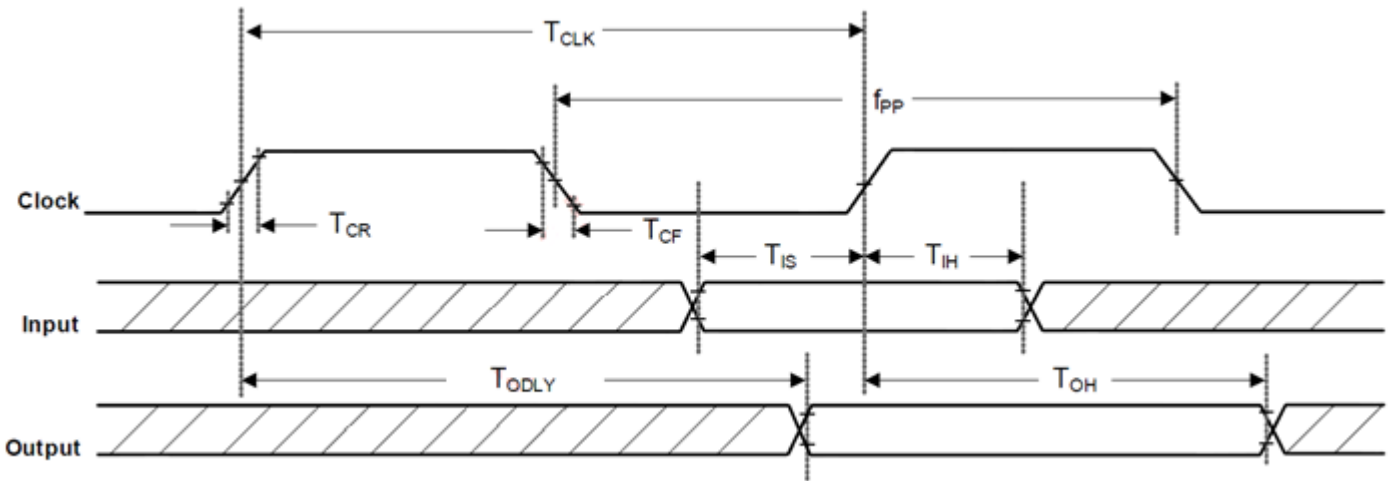

### SDIO Timing Data- SDR12, SDR25, SDR50 Modes (up to 100MHz) (1.8V)

Symbol	Parameter	Condition	Min	Typ	Max	Units
<b>f<sub>pp</sub></b>	CLK Frequency	SDR12/25/50	25	-	100	MHz
<b>T<sub>IS</sub></b>	Input setup time	SDR12/25/50	3	-	-	ns
<b>T<sub>IH</sub></b>	Input hold time	SDR12/25/50	0.8	-	-	ns
<b>T<sub>CLK</sub></b>	Clock time	SDR12/25/50	10	-	40	ns
<b>T<sub>CR</sub>, T<sub>CF</sub></b>	Rise time, fall time	SDR12/25/50	-	-	0.2*T <sub>CLK</sub>	ns
<b>T<sub>ODLY</sub></b>	Output delay time	SDR12/25/50	-	-	7.5	ns
<b>T<sub>OH</sub></b>	Output hold time	SDR12/25/50	1.5	-	-	ns

## SDIO Protocol Timing Diagram – SDR104 Mode (208MHz)

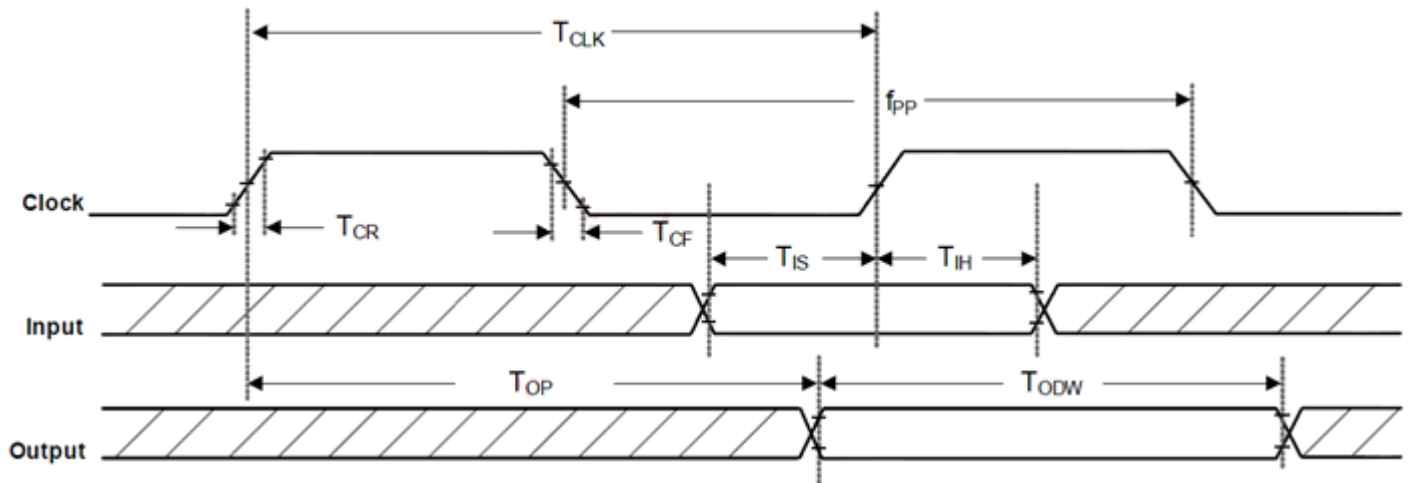

## SDIO Timing Data- SDR104 Mode (208MHz)

Symbol	Parameter	Condition	Min	Typ	Max	Units
$f_{pp}$	CLK Frequency	SDR104	0	-	208	MHz
$T_{IS}$	Input setup time	SDR104	1.4	-	-	ns
$T_{IH}$	Input hold time	SDR104	0.8	-	-	ns
$T_{CLK}$	Clock time	SDR104	4.8	-	-	ns
$T_{CR},$ $T_{CF}$	Rise time, fall time	SDR104	-	-	$0.2 \cdot T_{CLK}$	ns
$T_{ODLY}$	Output delay time	SDR104	0	-	10	ns
$T_{OH}$	Output hold time	SDR104	2.88	-	-	ns

### SDIO CMD Timing Diagram – DDR50 Mode (50MHz)

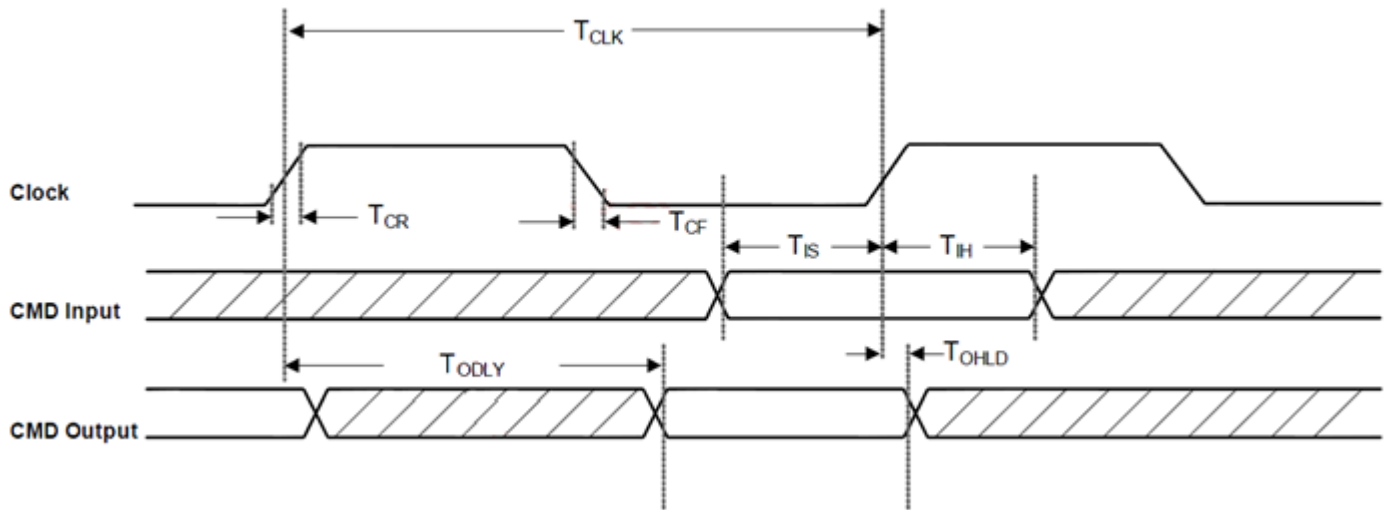

### SDIO SAT [3:0] Timing Diagram – SDR50 Mode (50MHz)

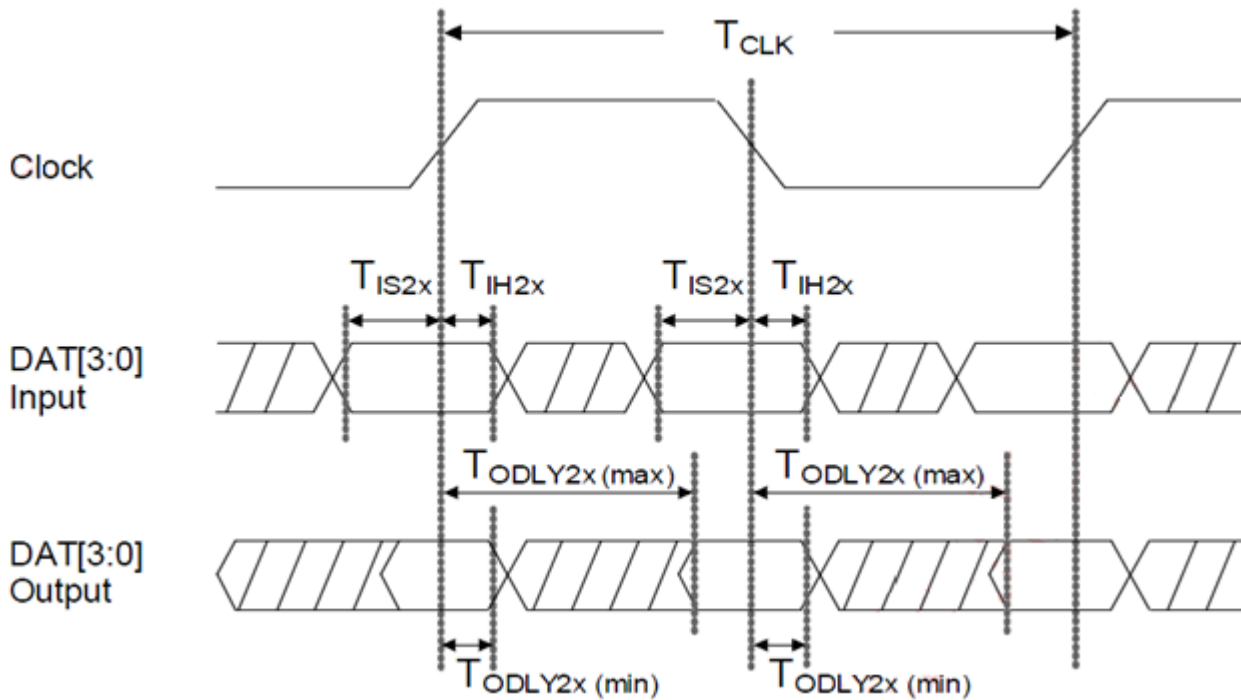

### SDIO Timing Data- DDR50 Mode (50MHz)

Symbol	Parameter	Condition	Min	Typ	Max	Units
<b>Clock</b>						
$T_{CLK}$	Clock time	DDR50	20	-	-	ns
$T_{CR}, T_{CF}$	Rise time, fall time	DDR50	-	-	$0.2 \cdot T_{CLK}$	Ns

<b>Clock Duty</b>		DDR50	45	-	55	%
<b>CMD Input</b>						
<b>T<sub>IS</sub></b>	Input setup time	DDR50	6	-	-	ns
<b>T<sub>IH</sub></b>	Input hold time	DDR50	0.8	-	-	ns
<b>CMD Output</b>						
<b>T<sub>ODLY</sub></b>	Output delay time during data transfer mode	DDR50	-	-	13.7	ns
<b>T<sub>OHL D</sub></b>	Output hold time	DDR50	1.5	-	-	ns
<b>DAT [3:0] Input</b>						
<b>T<sub>IS2X</sub></b>	Input hold time	DDR50	3	-	-	ns
<b>T<sub>IH2X</sub></b>	Input hold time	DDR50	0.8	-	-	ns
<b>DAT [3:0] Output</b>						
<b>T<sub>ODLY2X(max)</sub></b>	Output delay time during data transfer mode	DDR50	-	-	7	ns
<b>T<sub>ODLY2X(min)</sub></b>	Output hold time	DDR50	1.5	-	-	ns

### 3.4.2 UART Interface

#### High-Speed UART interface

The AW-CM358 supports a high-speed Universal Asynchronous Receiver/ Transmitter (UART) interface, compliant to the industry standard 16550 specification.

- ◆ FIFO mode permanently selected for transmit and receive operations.
- ◆ 2 pins for transmit and receive operations.
- ◆ 2 flow control pins.
- ◆ Interrupt triggers for low-power, internal CPU (for debug purposes).
- ◆ Support diagnostic tests.
- ◆ Support data input/ output operations for peripheral devices connected through a standard UART interface.

#### UART Interface Signals

Pin Number	Signal Name	16550 Standard Name	Type	Description
42	UART_SOUT	SOUT	O	Serial data
43	UART_SIN	SIN	I	Serial data
44	UART_CTSn	CTS <sub>n</sub>	I	Clear To Send
41	UART_RTSn	RTS <sub>n</sub>	O	Request To Send

#### UART Baud Rates Supported

Baud Rate				
1200	38400	460800	1500000	3000000
2400	57600	500000	1843200	3250000
4800	76800	921600	2000000	3692300
9600	115200	1000000	2100000	4000000
19200	230400	1382400	2764800	-

The UART Tx and Rx pins are powered from the VDDIO voltage supply.

### UART Timing Diagram

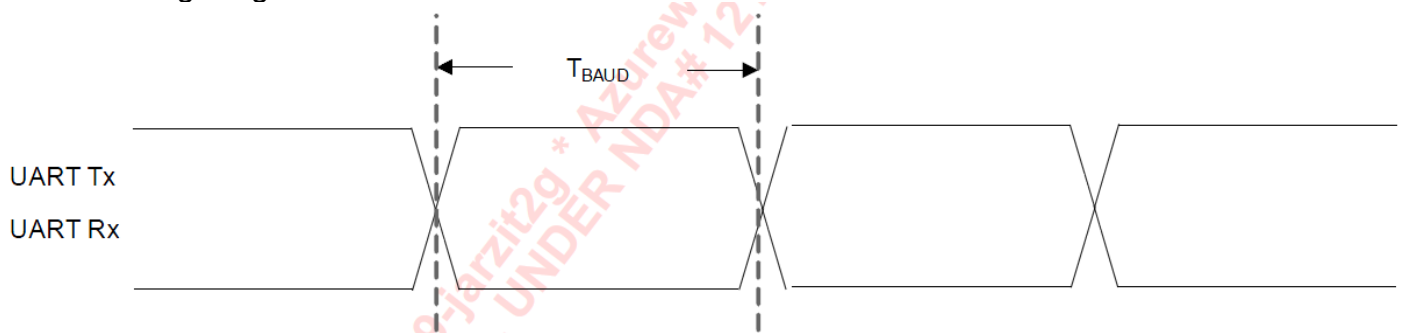

### UART Timing Data

Symbol	Parameter	Condition	Min	Typ	Max	Units
<b>TBAUD</b>	Baud rate	26MHz input clock	250	-	-	ns
<b>TBAUD</b>	Baud rate	38.4MHz input clock	250	-	-	ns



### 3.4.3 Frequency Reference

An external crystal is used for generating all radio frequencies and normal operation clocking. As an alternative, an external frequency reference driven by a temperature-compensated crystal oscillator (TCXO) signal may be used. No software settings are required to differentiate between the two. In addition, a low-power oscillator (LPO) is provided for lower power mode timing.

#### External 32.768KHz Low-Power Oscillator

Symbol	Parameter	Min	Typ	Max	Units
<b>CLK</b>	Clock frequency range/ accuracy CMOS input clock signal type $\pm 250$ ppm (initial, aging, temperature)	-	32.768	-	kHz
<b>V<sub>IH</sub></b>	Input levels, where VDDIO=1.8, 3.3V for V <sub>IH</sub> , V <sub>IL</sub>	0.7*VDDIO	-	VDDIO_0.4	V
<b>V<sub>IL</sub></b>		-0.4	-	0.3*VDDIO	V
<b>PN</b>	Phase noise requirement (@ 100KHz)	-	-125	-	dBc/Hz
<b>J<sub>c</sub></b>	Cycle jitter	-	1.5	-	ns (RMS)
<b>SR</b>	Slew rate limit (10-90%)	-	-	100	ns
<b>DC</b>	Duty cycle tolerance	20	-	80	%

The AW-CM358 module crystal specifications

## 3.5 Power Consumption\*

### 3.5.1 WLAN

No.	Item			VBAT_IN=3.3 V		
				Max.	Avg.	
1	Power Down <sup>*(1)(2)</sup>			1.0mA	0.92mA	
2	Sleep <sup>*(2)(4)</sup> (Not associated with AP)			1.3mA	1.2mA	
3	Power Save (2.4GHz) <sup>*(2)(3)(4)</sup>			49.5mA	2.4mA	
4	Power Save (5GHz) <sup>*(2)(3)(4)</sup>			80.4mA	2.1mA	
Band (GHz)	Mode	BW (MHz)	RF Power (dBm)	Transmit		
				Max.	Avg.	Duty(%) (Mean)
2.4	11b@1Mbps	20	16	287	161	67
	11b@11Mbps	20	16	277	163	65
	11g@54Mbps	20	14	191	120	52
	11n@MCS7	40	12	98	57	36
5	11a@6Mbps	20	13	247	143	64
	11a@54Mbps	20	13	198	130	53
	11n@MCS7	40	10	112	74	16
	11ac@MCS0	20	10	217	129	48
	11ac@MCS9	40	9	103	74	42
	11ac@MCS0 NSS1	80	8	212	88	55
	11ac@MCS9 NSS1	80	8	93	76	27
Band (GHz)	Mode	BW(MHz)		Receive		
				Max.	Avg.	
2.4	11b@1Mbps	20		57	55	
	11n@MCS7	40		64	63	
5	11a@6Mbps	20		71	69	
	11ac@MCS8 NSS1	20		73	72	
	11ac@MCS9 NSS1	40		85	84	
	11ac@MCS9 NSS1	80		98	95	

#### \*Current Unit: mA

\* The power consumption is based on Azurewave test environment, these data for reference only.

- (1) WLAN and Bluetooth off (WL\_REG\_ON=LOW, #hconfig hciX down)
- (2) Using normal firmware.
- (3) Link AP use ASUS RT-AC66U, DTIM = 1, Beacon Interval = 100 ms
- (4) WLAN Initial value is too high, in SD-UART mode, BT power save mode is Active, About this issue, Please refer below bring up comment:  
modprobe cfg80211



```
insmod mlan.ko
insmod sd8987.ko cal_data_cfg=none fw_name=mrvl/sdio8xxx_uart_combo_pxx.bin
insmod hci_uart.ko ps_mode=1
hciattach /dev/ttyUSB0 any 115200 flow
```

### 3.5.2 Bluetooth

No.	Mode	Packet Type	RF Power (dBm)	VBAT_IN=3.3 V	
				Max.	Avg.
1	Play Music <sup>*(1)</sup>	A2DP	n/a	21.6	12
2	Transmit <sup>*(2)</sup>	DH5	4	68.9	62.8
3	Receive <sup>*(2)</sup>	3-DH5	n/a	61.4	57.3

**\*Current Unit: mA**

\* The power consumption is based on Azurewave test environment, these data for reference only.

1. Using Normal Firmware
2. Using MFG Firmware



## 5. Packaging Information

1. One reel can pack 1,500pcs 12x12 LGA modules

(整軸產品數量為 1500pcs)

2. One production label is pasted on the reel, one desiccant and one humidity indicator card are put on the reel

(卷軸貼上一張生產標籤，並放上一包防潮包及濕度指示卡)

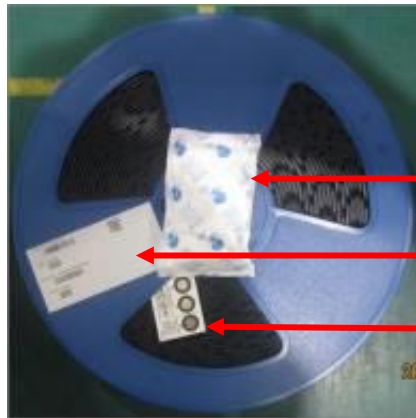

One desiccant

One production label

One humidity indicator card

3. One reel is put into the anti-static moisture barrier bag, and then one label is pasted on the bag

(卷軸放進防靜電鋁箔袋，再貼上一張生產標籤)



One production label

4. A bag is put into the anti-static pink bubble wrap  
(防靜電鋁箔袋放進氣泡袋內)

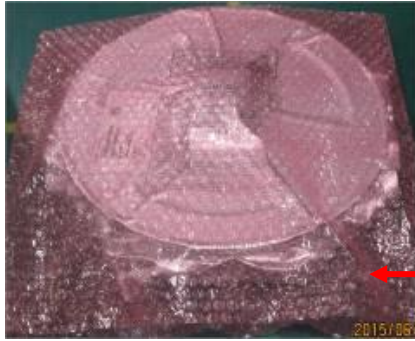

← One anti-static pink bubble wrap

5. A bubble wrap is put into the inner box and then one label is pasted on the inner box  
(氣泡袋放進內箱中，再貼上一張生產標籤)



生產標籤  
Production label

← One production label

6. **5 inner boxes** could be put into one carton  
(五個內箱可以放進一個外箱)



Production

7. Sealing the carton by AzureWave tape

(使用海華 Logo 膠帶將外箱進行工字型封箱)



8. One carton label and one box label are pasted on the carton. If one carton is not full, one balance label pasted on the carton

(外箱上貼附出貨標籤和箱號標籤；如不滿箱，需貼附尾數標籤)





### **Federal Communication Commission Interference Statement**

This device complies with Part 15 of the FCC Rules. Operation is subject to the following two conditions: (1) This device may not cause harmful interference, and (2) this device must accept any interference received, including interference that may cause undesired operation.

This equipment has been tested and found to comply with the limits for a Class B digital device, pursuant to Part 15 of the FCC Rules. These limits are designed to provide reasonable protection against harmful interference in a residential installation. This equipment generates, uses and can radiate radio frequency energy and, if not installed and used in accordance with the instructions, may cause harmful interference to radio communications. However, there is no guarantee that interference will not occur in a particular installation. If this equipment does cause harmful interference to radio or television reception, which can be determined by turning the equipment off and on, the user is encouraged to try to correct the interference by one of the following measures:

- Reorient or relocate the receiving antenna.
- Increase the separation between the equipment and receiver.
- Connect the equipment into an outlet on a circuit different from that to which the receiver is connected.
- Consult the dealer or an experienced radio/TV technician for help.

FCC Caution: Any changes or modifications not expressly approved by the party responsible for compliance could void the user's authority to operate this equipment.

This transmitter must not be co-located or operating in conjunction with any other antenna or transmitter.



Radiation Exposure Statement:

This equipment complies with FCC radiation exposure limits set forth for an uncontrolled environment. This equipment should be installed and operated with minimum distance 20 cm between the radiator & your body.

**This module is intended for OEM integrators only. Per FCC KDB 996369 D03 OEM Manual v01 guidance, the following conditions must be strictly followed when using this certified module:**

**KDB 996369 D03 OEM Manual v01 rule sections:**

**2.2 List of applicable FCC rules**

This module has been tested for compliance to **FCC Part 15.247, 15.407**

**2.3 Summarize the specific operational use conditions**

The module is tested for standalone mobile RF exposure use condition. Any other usage conditions such as co-location with other transmitter(s) or being used in a portable condition will need a separate reassessment through a class II permissive change application or new certification.

**2.4 Limited module procedures**

Not applicable.

**2.5 Trace antenna designs**

Not applicable.

**2.6 RF exposure considerations**

This equipment complies with FCC mobile radiation exposure limits set forth for an uncontrolled environment. This equipment should be installed and operated with a minimum distance of 20cm between the radiator & your body. If the module is installed in a portable host, a separate SAR evaluation is required to confirm compliance with relevant FCC portable RF exposure rules.

**2.7 Antennas**

The following antennas have been certified for use with this module; antennas of the same type with equal or lower gain may also be used with this module. The antenna must be installed such that 20 cm can be maintained between the antenna and users.

Antenna No.	Brand	Model	Antenna Net Gain(dBi)	Frequency range	Antenna Type	Connector Type	Cable length
1	MAG.LAYERS	MSA-4008-25GC1-A2	2.98	2.4~2.4835GHz	PIFA	i-pex(MHF)	155mm
			5.16	5.15~5.85GHz			
2	AzureWave	AW-CM358AN	3.4	2.4~2.4835GHz	PCB	none	NA
			3.4	5.15~5.85GHz			
3	FOXCONN	EA-2INP501-0010	1.17	2.4~2.4835GHz	PIFA	ipex(MHF)	90mm
			5.09	5.15~5.35GHz			
			6.38	5.475~5.725GHz			
			4.81	5.725~5.85GHz			
4	FOXCONN	EA-2RUNMAP-0010	3.08	2.4~2.4835GHz	PIFA	w/ RP-SMA	1935mm

			2.07	5.15~5.35GHz		to ipex(MHF) cable	
			2.86	5.475~5.725GHz			
			3.45	5.725~5.85GHz			

NOTE: Antenna 4 is sold with RP-SMA to ipex(MHF) adapter cable and is included in cable length calculation. RP-SMA connector is for BT/WLAN TX w/ this module. SMA connectors on Antenna 4 are for WWAN/GPS only

**2.8 Label and compliance information**

The final end product must be labeled in a visible area with the following: “Contains FCC ID: TLZ-CM358SM”. The grantee's FCC ID can be used only when all FCC compliance requirements are met.

**2.9 Information on test modes and additional testing requirements**

This transmitter is tested in a standalone mobile RF exposure condition and any co-located or simultaneous transmission with other transmitter(s) or portable use will require a separate class II permissive change re-evaluation or new certification.

**2.10 Additional testing, Part 15 Subpart B disclaimer**

This transmitter module is tested as a subsystem and its certification does not cover the FCC Part 15 Subpart B (unintentional radiator) rule requirement applicable to the final host. The final host will still need to be reassessed for compliance to this portion of rule requirements if applicable.

As long as all conditions above are met, further transmitter test will not be required. However, the OEM integrator is still responsible for testing their end-product for any additional compliance requirements required with this module installed.

**IMPORTANT NOTE:** In the event that these conditions can not be met (for example certain laptop configurations or co-location with another transmitter), then the FCC authorization is no longer considered valid and the FCC ID can not be used on the final product. In these circumstances, the OEM integrator will be responsible for re-evaluating the end product (including the transmitter) and obtaining a separate FCC authorization.

**Manual Information To the End User**

The OEM integrator has to be aware not to provide information to the end user regarding how to install or remove this RF module in the user’s manual of the end product which integrates this module.

The end user manual shall include all required regulatory information/warning as show in this manual.

**OEM/Host manufacturer responsibilities**

OEM/Host manufacturers are ultimately responsible for the compliance of the Host and Module. The final product must be reassessed against all the essential requirements of the FCC rule such as FCC Part 15 Subpart B before it can be placed on the US market. This includes reassessing the transmitter

module for compliance with the Radio and EMF essential requirements of the FCC rules. This module must not be incorporated into any other device or system without retesting for compliance as multi-radio and combined equipment.

**Industry Canada statement:**

This device complies with ISED's licence-exempt RSSs. Operation is subject to the following two conditions: (1) This device may not cause harmful interference, and (2) this device must accept any interference received, including interference that may cause undesired operation.

Le présent appareil est conforme aux CNR d'ISED applicables aux appareils radio exempts de licence. L'exploitation est autorisée aux deux conditions suivantes : (1) le dispositif ne doit pas produire de brouillage préjudiciable, et (2) ce dispositif doit accepter tout brouillage reçu, y compris un brouillage susceptible de provoquer un fonctionnement indésirable.

**Radiation Exposure Statement:**

This equipment complies with ISED radiation exposure limits set forth for an uncontrolled environment. This equipment should be installed and operated with greater than 20 cm between the radiator & your body.

**Déclaration d'exposition aux radiations:**

Cet équipement est conforme aux limites d'exposition aux rayonnements ISED établies pour un environnement non contrôlé. Cet équipement doit être installé et utilisé à plus de 20 cm entre le radiateur et votre corps.

**This device is intended only for OEM integrators under the following conditions: (For module device use)**

- 1) The antenna must be installed and operated with greater than 20cm between the antenna and users, and
- 2) The transmitter module may not be co-located with any other transmitter or antenna.

As long as **2** conditions above are met, further transmitter test will not be required. However, the OEM integrator is still responsible for testing their end-product for any additional compliance requirements required with this module installed.

**Cet appareil est conçu uniquement pour les intégrateurs OEM dans les conditions suivantes: (Pour utilisation de dispositif module)**

- 1) L'antenne doit être installé et exploité avec plus de 20 cm entre l'antenne et les utilisateurs, et

2) Le module émetteur peut ne pas être coïmplanté avec un autre émetteur ou antenne.

Tant que les **2** conditions ci-dessus sont remplies, des essais supplémentaires sur l'émetteur ne seront pas nécessaires. Toutefois, l'intégrateur OEM est toujours responsable des essais sur son produit final pour toutes exigences de conformité supplémentaires requis pour ce module installé.

**IMPORTANT NOTE:**

In the event that these conditions can not be met (for example certain laptop configurations or co-location with another transmitter), then the Canada authorization is no longer considered valid and the IC ID can not be used on the final product. In these circumstances, the OEM integrator will be responsible for re-evaluating the end product (including the transmitter) and obtaining a separate Canada authorization.

**NOTE IMPORTANTE:**

Dans le cas où ces conditions ne peuvent être satisfaites (par exemple pour certaines configurations d'ordinateur portable ou de certaines co-localisation avec un autre émetteur), l'autorisation du Canada n'est plus considéré comme valide et l'ID IC ne peut pas être utilisé sur le produit final. Dans ces circonstances, l'intégrateur OEM sera chargé de réévaluer le produit final (y compris l'émetteur) et l'obtention d'une autorisation distincte au Canada.

**End Product Labeling**

This transmitter module is authorized only for use in device where the antenna may be installed and operated with greater than 20 cm between the antenna and users. The final end product must be labeled in a visible area with the following: "Contains IC: **6100A-CM358SM**".

**Plaque signalétique du produit final**

Ce module émetteur est autorisé uniquement pour une utilisation dans un appareil où l'antenne peut être installée et utilisée à plus de 20 cm entre l'antenne et les utilisateurs. Le produit final doit être étiqueté dans un endroit visible avec l'inscription suivante: "Contient des IC: **6100A-CM358SM**".

**Manual Information To the End User**

The OEM integrator has to be aware not to provide information to the end user regarding how to install or remove this RF module in the user's manual of the end product which integrates this module. The end user manual shall include all required regulatory information/warning as show in this manual.

**Manuel d'information à l'utilisateur final**

L'intégrateur OEM doit être conscient de ne pas fournir des informations à l'utilisateur final quant à la façon d'installer ou de supprimer ce module RF dans le manuel de l'utilisateur du produit final qui intègre ce module. Le manuel de l'utilisateur final doit inclure toutes les informations réglementaires requises et avertissements comme indiqué dans ce manuel.

**Caution :**

- (i) the device for operation in the band 5150-5250 MHz is only for indoor use to reduce the potential for harmful interference to co-channel mobile satellite systems;

- (ii) for devices with detachable antenna(s), the maximum antenna gain permitted for devices in the bands 5250-5350 MHz and 5470-5725 MHz shall be such that the equipment still complies with the e.i.r.p. limit;
- (iii) for devices with detachable antenna(s), the maximum antenna gain permitted for devices in the band 5725-5850 MHz shall be such that the equipment still complies with the e.i.r.p. limits as appropriate;
- (iv) where applicable, antenna type(s), antenna model(s), and worst-case tilt angle(s) necessary to remain compliant with the e.i.r.p. elevation mask requirement set forth in section 6.2.2.3 shall be clearly indicated.

**Avertissement:**

Le guide d'utilisation des dispositifs pour réseaux locaux doit inclure des instructions précises sur les restrictions susmentionnées, notamment :

- (i) les dispositifs fonctionnant dans la bande 5150-5250 MHz sont réservés uniquement pour une utilisation à l'intérieur afin de réduire les risques de brouillage préjudiciable aux systèmes de satellites mobiles utilisant les mêmes canaux;
- (ii) pour les dispositifs munis d'antennes amovibles, le gain maximal d'antenne permis pour les dispositifs utilisant les bandes de 5 250 à 5 350 MHz et de 5 470 à 5 725 MHz doit être conforme à la limite de la p.i.r.e.;
- (iii) pour les dispositifs munis d'antennes amovibles, le gain maximal d'antenne permis (pour les dispositifs utilisant la bande de 5 725 à 5 850 MHz) doit être conforme à la limite de la p.i.r.e. spécifiée, selon le cas;
- (iv) lorsqu'il y a lieu, les types d'antennes (s'il y en a plusieurs), les numéros de modèle de l'antenne et les pires angles d'inclinaison nécessaires pour rester conforme à l'exigence de la p.i.r.e. applicable au masque d'élévation, énoncée à la section 6.2.2.3, doivent être clairement indiqués

**DETACHABLE ANTENNA USAGE**

This radio transmitter [IC: 6100A-CM358SM] has been approved by Innovation, Science and Economic Development Canada to operate with the antenna types listed below, with the maximum permissible gain indicated. Antenna types not included in this list that have a gain greater than the maximum gain indicated for any type listed are strictly prohibited for use with this device.

Le présent émetteur radio [IC: 6100A-CM358SM] a été approuvé par Innovation, Sciences et Développement économique Canada pour fonctionner avec les types d'antenne énumérés ci-dessous et ayant un gain admissible maximal. Les types d'antenne non inclus dans cette liste, et dont le gain est supérieur au gain maximal indiqué pour tout type figurant sur la liste, sont strictement interdits pour l'exploitation de l'émetteur.



Required Impedance / L'impédance Requisite: 50 Ω

Antenna No.	Brand	Model	Antenna Net Gain(dBi)	Frequency range	Antenna Type	Connector Type	Cable length
1	MAG.LAYERS	MSA-4008-25GC1-A2	2.98	2.4~2.4835GHz	PIFA	i-plex(MHF)	155mm
			5.16	5.15~5.85GHz			
2	AzureWave	AW-CM358AN	3.4	2.4~2.4835GHz	PCB	none	NA
			3.4	5.15~5.85GHz			
3	FOXCONN	EA-2INP501-0010	1.17	2.4~2.4835GHz	PIFA	ipex(MHF)	90mm
			5.09	5.15~5.35GHz			
			6.38	5.475~5.725GHz			
			4.81	5.725~5.85GHz			
4	FOXCONN	EA-2RUNMAP-0010	3.08	2.4~2.4835GHz	PIFA	w/ RP-SMA to ipex(MHF) cable	1935mm
			2.07	5.15~5.35GHz			
			2.86	5.475~5.725GHz			
			3.45	5.725~5.85GHz			

NOTE: Antenna 4 is sold with RP-SMA to ipex(MHF) adapter cable and is included in cable length calculation. RP-SMA connector is for BT/WLAN TX w/ this module. SMA connectors on Antenna 4 are for WWAN/GPS only

取得審驗證明之低功率射頻器材，非經核准，公司、商號或使用者均不得擅自變更頻率、加大功率或變更原設計之特性及功能。

低功率射頻器材之使用不得影響飛航安全及干擾合法通信；經發現有干擾現象時，應立即停用，並改善至無干擾時方得繼續使用。前述合法通信，指依電信管理法規定作業之無線電通信。低功率射頻器材須忍受合法通信或工業、科學及醫療用電波輻射性電機設備之干擾。

1. 應避免影響附近雷達系統之操作。
2. 高增益指向性天線只得應用於固定式點對點系統。
3. 系統廠商應於平台上標示「本產品內含射頻模組：XXXyyyLPDzzzz-x」字樣。

本模組取得認證後將依規定於模組本體標示審驗合格標籤