

APPROVAL SHEET

(RoHS)

CUSTOMER : 海華科技股份有限公司
CUSTOMER'S PART NO. :
DESCRIPTION : METAL STAMPING ANTENNA ASSEMBLY
PART NO. : MSA-4008-25GC1-A2
DATE :
AUTHORIZED BY : *Jason Chang*

	FULLY APPROVED	PARTIALLY APPROVED	REJECTED
SIGN			
SUGGESTION			

美磊科技股份有限公司

MAG. LAYERS SCIENTIFIC-TECHNICS CO., LTD

No.270, Nanfeng Rd., Pingzhen Dist., Taoyuan City 324, Taiwan (R.O.C.)

TEL: +886-3-4159111 FAX: +886-3-4192255

<http://www.maglayers.com.tw>

E-mail : info@maglayers.com.tw



MAG.LAYERS

Contents

Item	Description	Page
1.	Mechanical Specification	4
2.	Antenna Specification	5
3.	Test Report	6~13

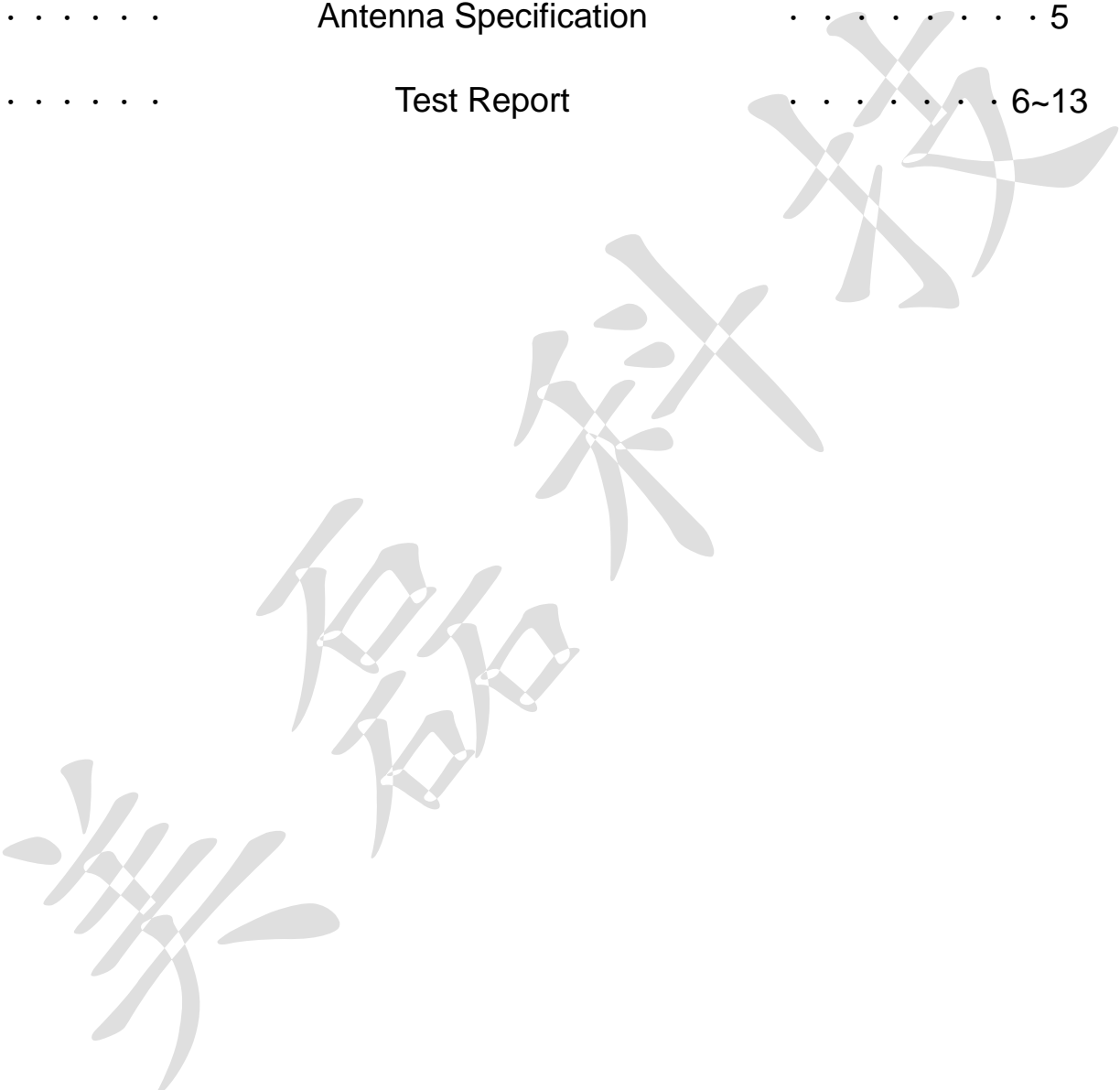

Mechanical Specification

RoHS COMPLIANT

MECHANICAL

Body : SUS 430(鍍鎳) T=0.3mm
 Cable : Coaxial Cable ϕ 1.13(Black)
 Connector : IPEX-4 Compatible

ELECTRICAL

Frequency : 2.4/5GHz

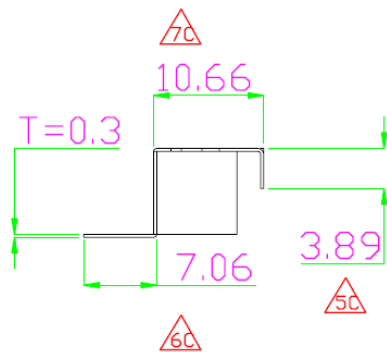
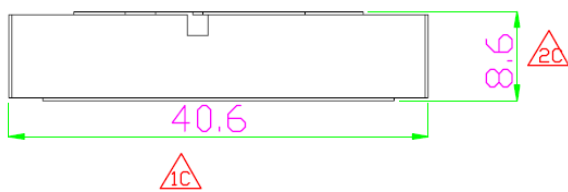
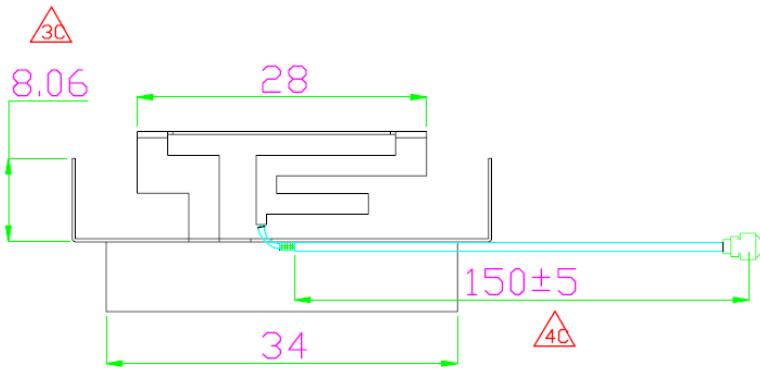
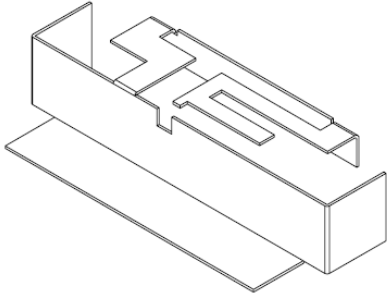

※凡標記△C記號者, 為品管檢驗之尺寸

設計 DR. Seric 2018/08/16	核准 APPD. Frank 2018/08/16	容許公差 TOLERANCE .XXX ±0.1 .XX ±0.5 .X ±1.0 X ±3.0 ANG ±5	品名 ARTICLE MSA-4008-25GC1-A2
版本說明 REVISION NOTE			
MAGLAYERS			單位 UNIT mm
			比例 SCALE ****
			張數 SHEET 1
			版本 REV. A

Antenna Specification

ELECTRICAL PROPERTIES

- 1.1 Frequency Range..... 2.4~2.5GHz /4.9~5.9GHz
- 1.2 Antenna Type..... PIFA
- 1.3 Impedance..... 50 Ohm Nominal
- 1.4 Return Loss..... -10dB (Max)
- 1.5 Radiation..... Directional
- 1.6 3D Peak Gain..... 2.98dBi(2.4~2.5GHz)
5.16dBi(4.9~5.9GHz)
- 1.7 Polarization..... Linear Vertical
- 1.8 Admitted Power..... 1W

PHYSICAL PROPERTIES

- 2.1 Antenna Material..... SUS430 (鍍鎳)
- 2.2 Cable..... Coaxial Cable ϕ 1.13(Black)
- 2.3 Connector..... IPEX-4 Compatible
- 2.4 Operating Temp..... -20°C ~ +65°C
- 2.5 Storage Temp..... -30°C ~ +75°C



Test Report

ELECTRICAL CHARACTERISTICS

P/NO: MSA-4008-25GC1-A2

Spec: 2.4~2.5GHz / 4.9~5.9GHz

S11

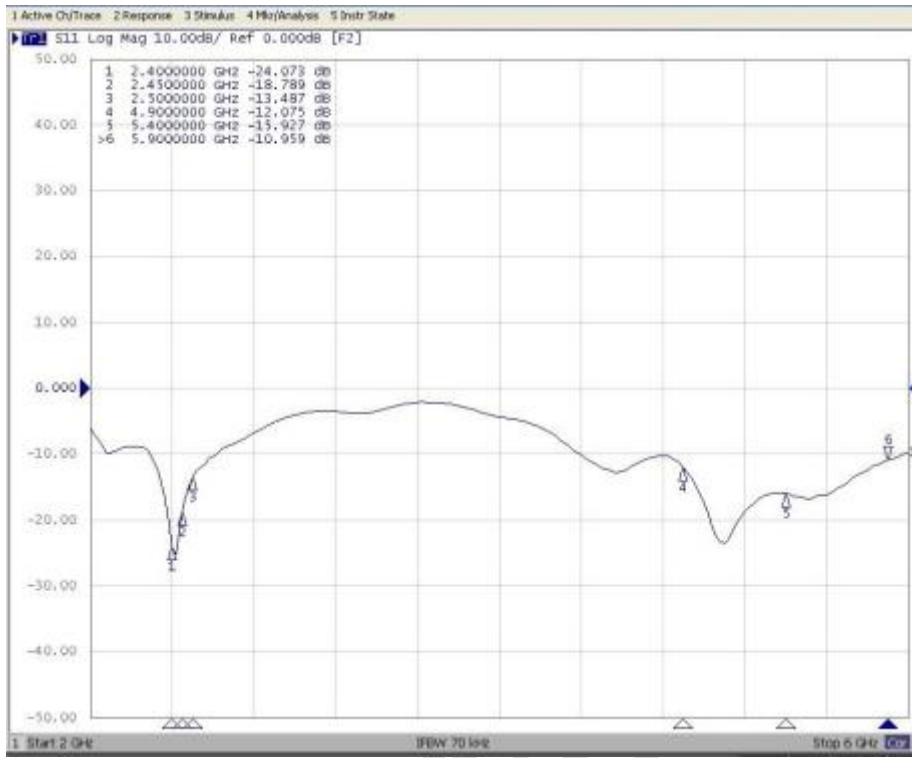

Peak Gain & Efficiency List Table

Frequency (MHz)	Efficiency (%)	Peak Gain (dBi)
2400	60%	2.98
2450	61%	2.87
2500	66%	2.88
5150	66%	4.61
5250	61%	4.56
5350	57%	4.32
5470	65%	4.30
5500	66%	4.29
5600	73%	5.16
5725	79%	4.99
5750	77%	4.89
5785	73%	4.63
5850	67%	4.11
5925	57%	3.05

2D Gain Pattern_Antenna_@2G_ZX Cut(Phi=0)

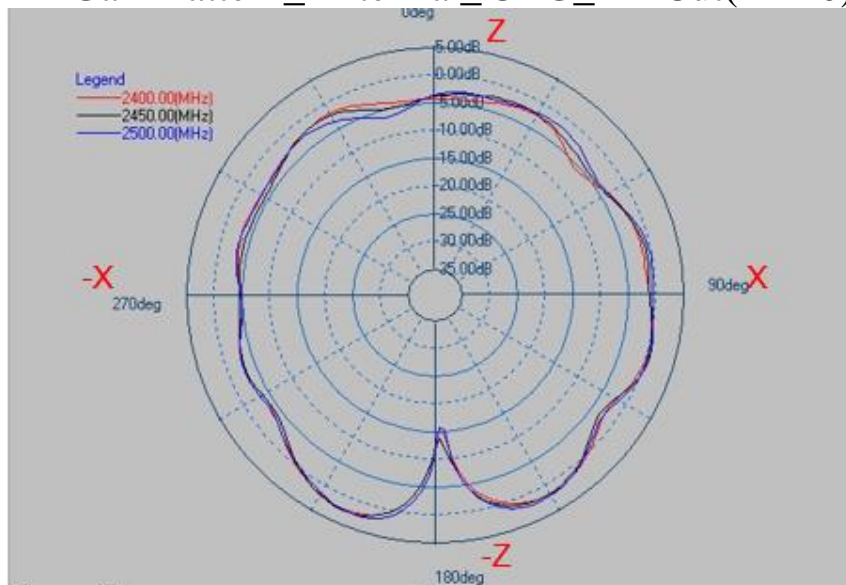

Layer	Max value	Min value	Average
2400(MHz)	2.15 dB	-15.23 dB	-1.99 dB
2450(MHz)	2.37 dB	-13.80 dB	-1.95 dB
2500(MHz)	2.42 dB	-15.95 dB	-1.74 dB

2D Gain Pattern_Antenna_@2G_ZY Cut(Phi=90)

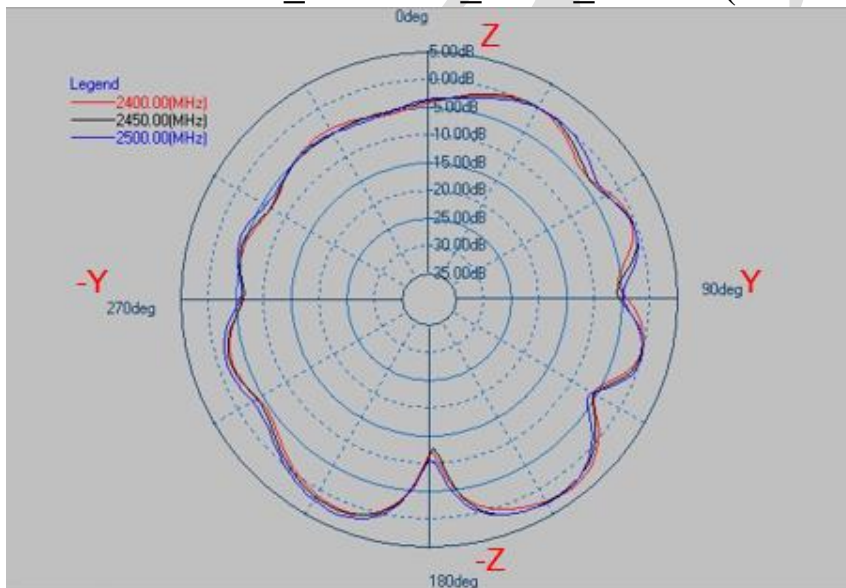

Layer	Max value	Min value	Average
2400(MHz)	2.97 dB	-12.03 dB	-2.03 dB
2450(MHz)	2.65 dB	-12.88 dB	-1.93 dB
2500(MHz)	2.82 dB	-10.67 dB	-1.64 dB



2D Gain Pattern_Antenna_@2G_XY Cut(Theta=90)

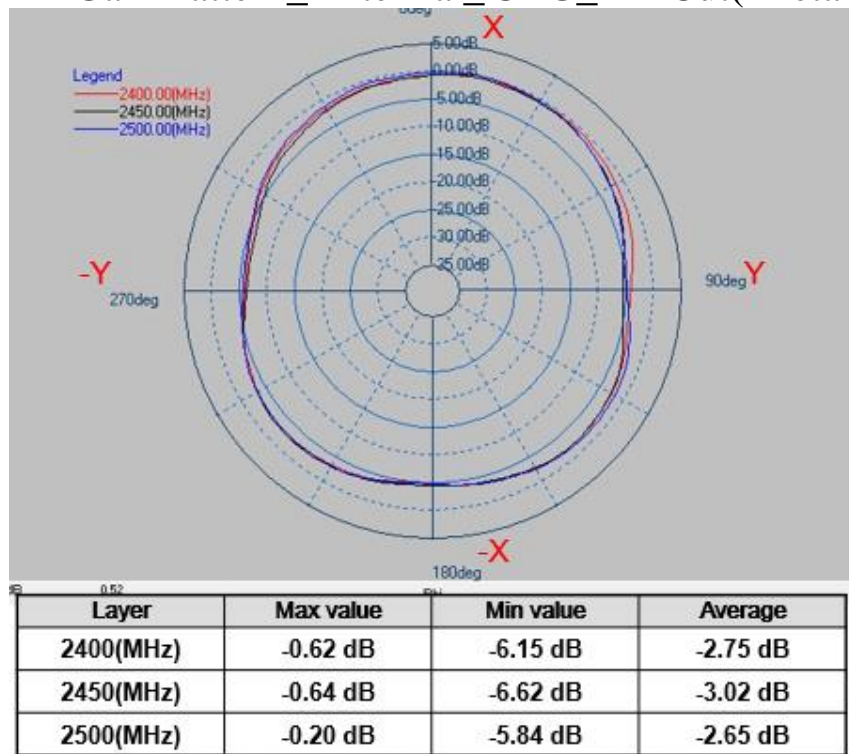

2D Gain Pattern_Antenna_@5G_ZX Cut(Phi=0)

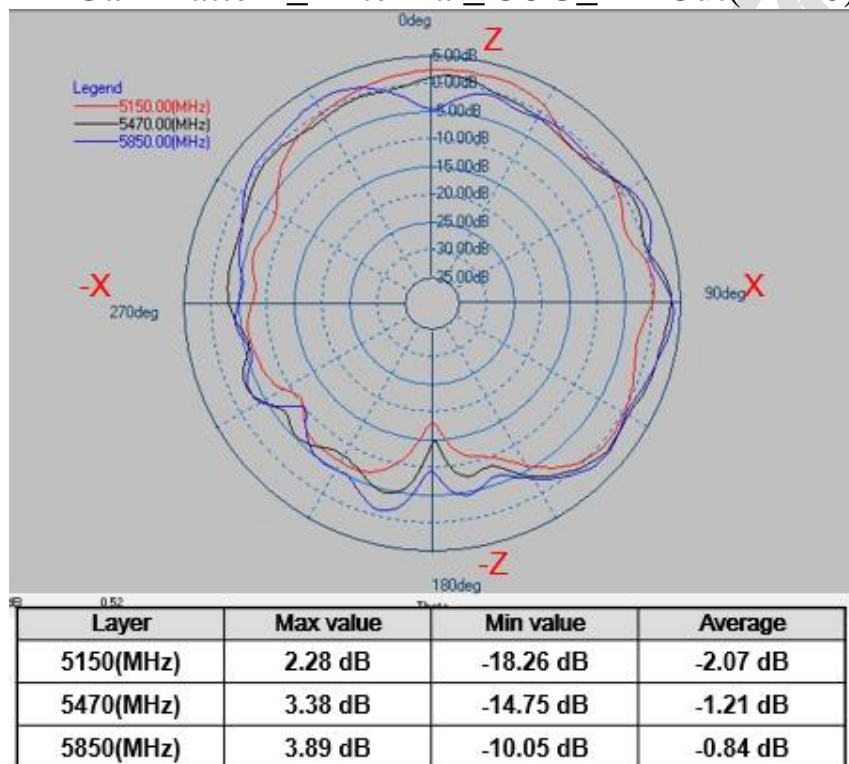

2D Gain Pattern_Antenna _@5G_ZY Cut(Phi=90)

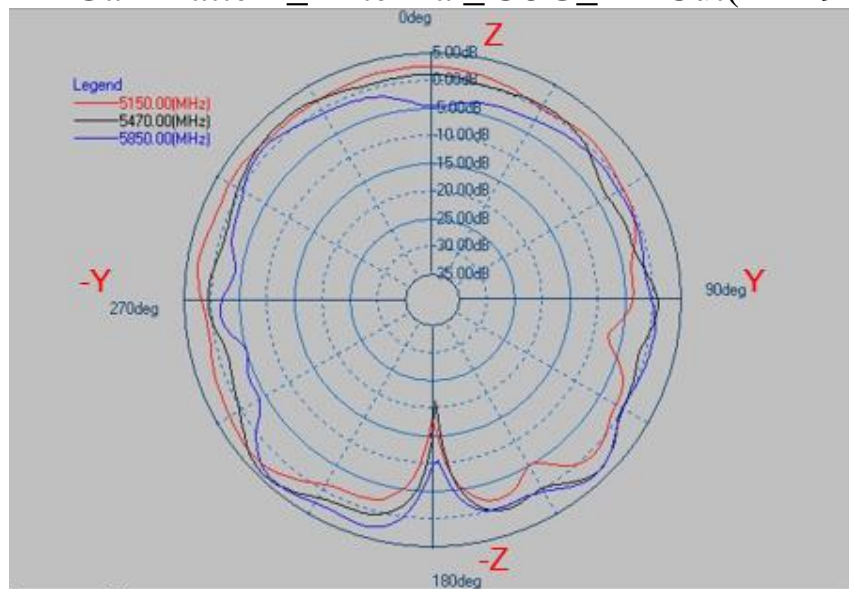

Layer	Max value	Min value	Average
5150(MHz)	3.03 dB	-18.26 dB	0.32 dB
5470(MHz)	4.04 dB	-21.57 dB	0.36 dB
5850(MHz)	3.65 dB	-10.63 dB	-0.32 dB

2D Gain Pattern_Antenna _@5G_XY Cut(Theta=90)

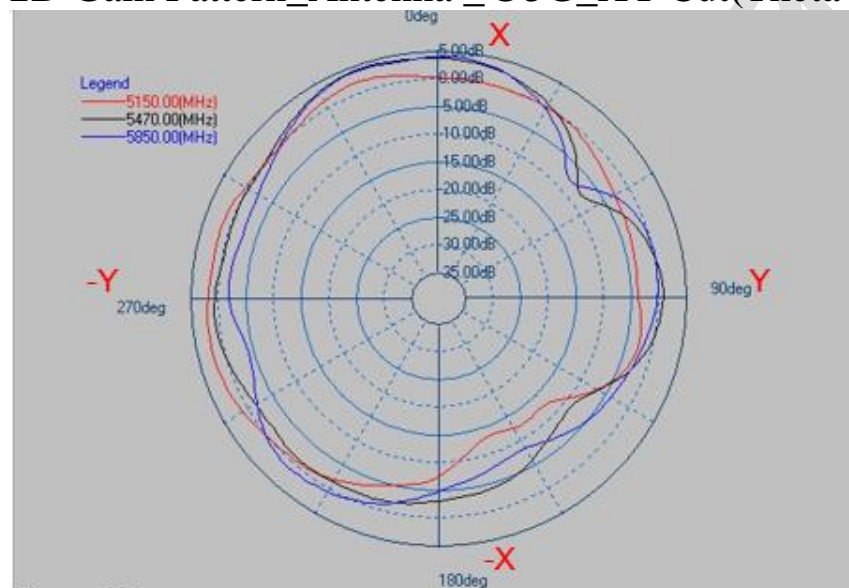

Layer	Max value	Min value	Average
5150(MHz)	2.20 dB	-13.33 dB	-1.13 dB
5470(MHz)	3.83 dB	-8.81 dB	-0.31 dB
5850(MHz)	3.76 dB	-8.52 dB	-0.64 dB



3D Gain Pattern_Antenna

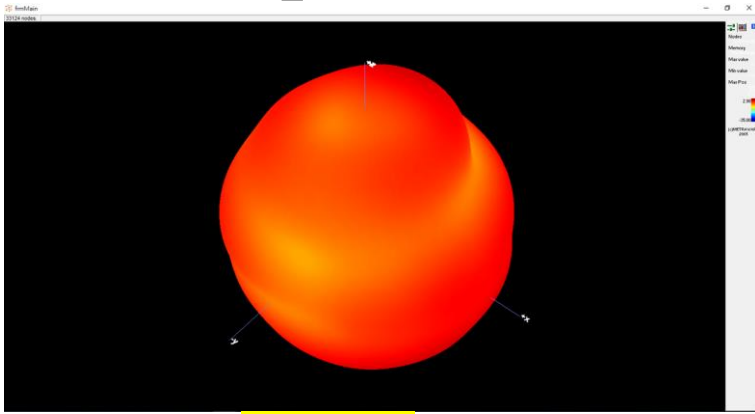

Peak Gain @ 2400MHz : 2.98dBi

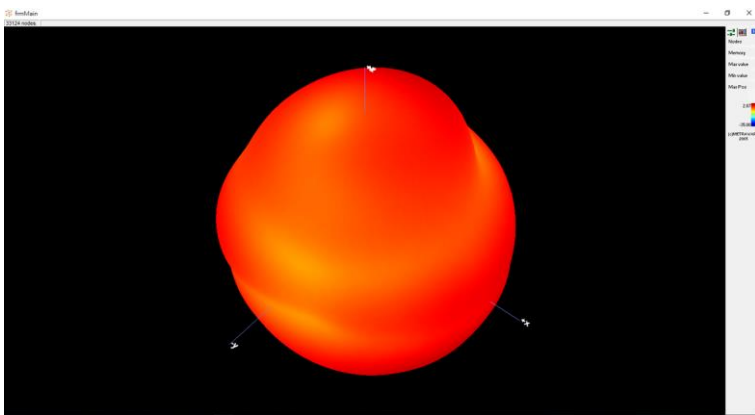

Peak Gain @ 2450MHz : 2.87dBi

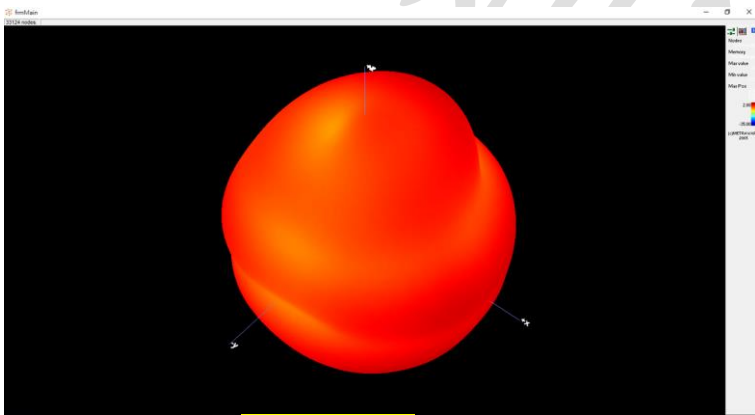

Peak Gain @ 2500MHz : 2.88dBi

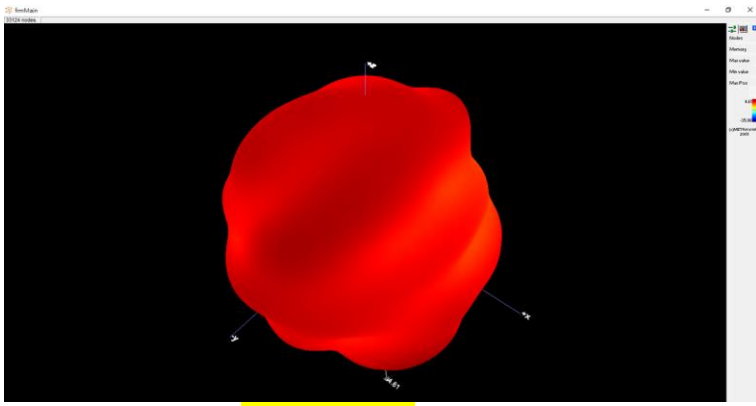

Peak Gain @ 5150MHz : 4.61dBi

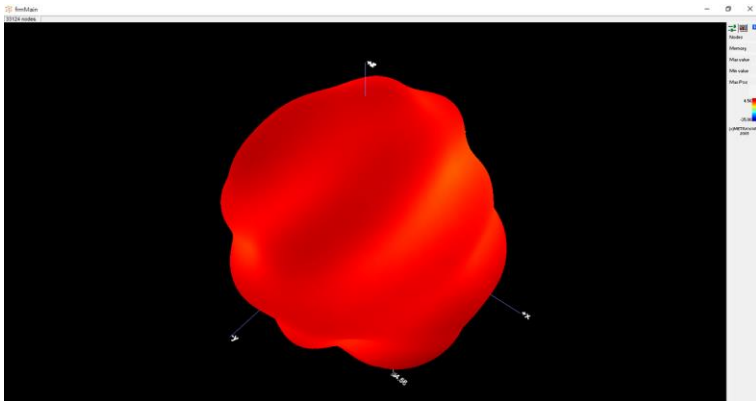

Peak Gain @ 5250MHz : 4.56dBi

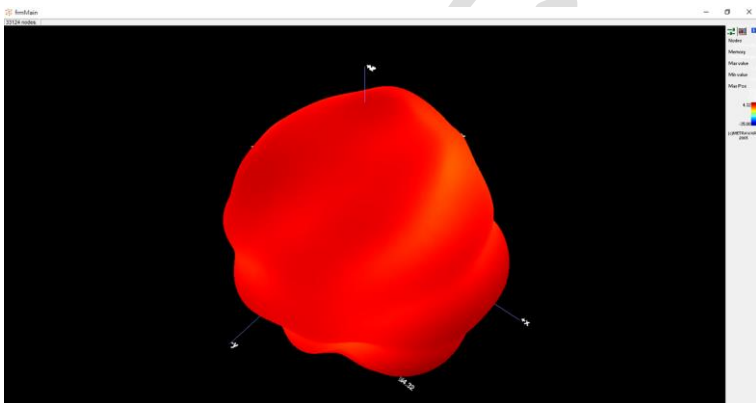

Peak Gain @ 5350MHz : 4.32dBi

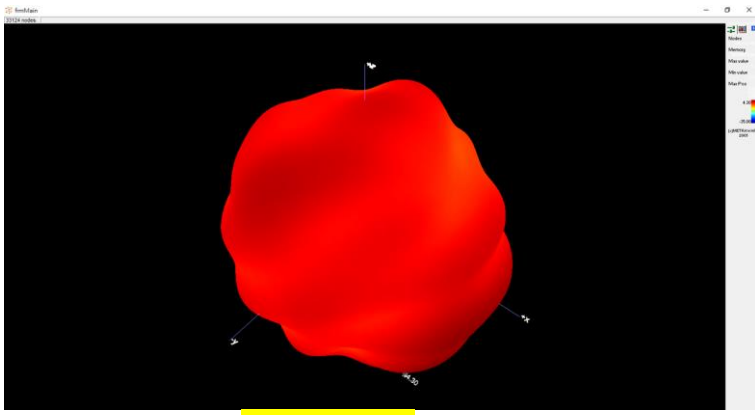

Peak Gain @ 5470MHz : 4.30dBi

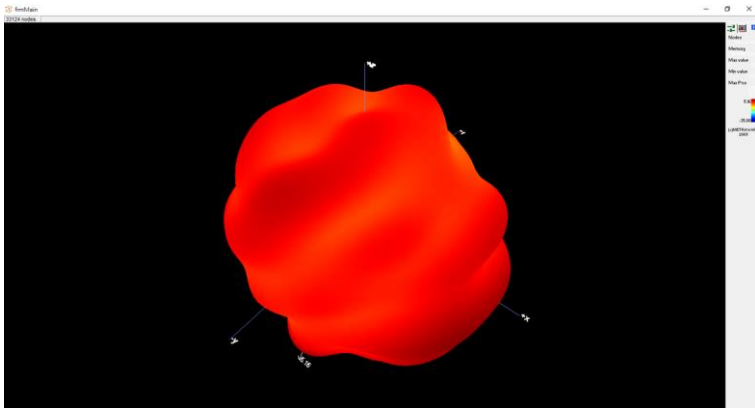

Peak Gain @ 5600MHz : 5.16dBi

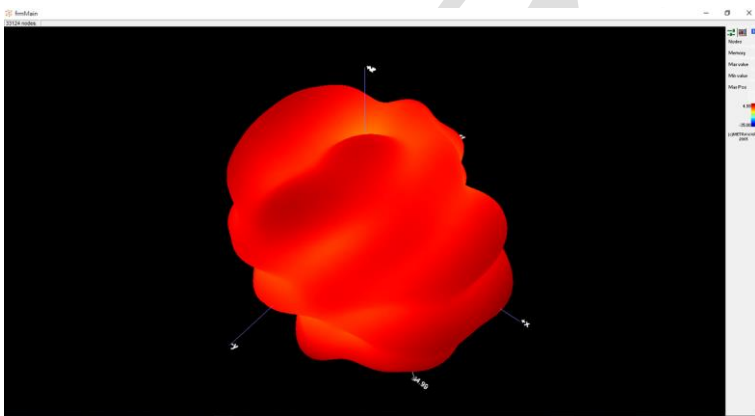

Peak Gain @ 5725MHz : 4.99dBi

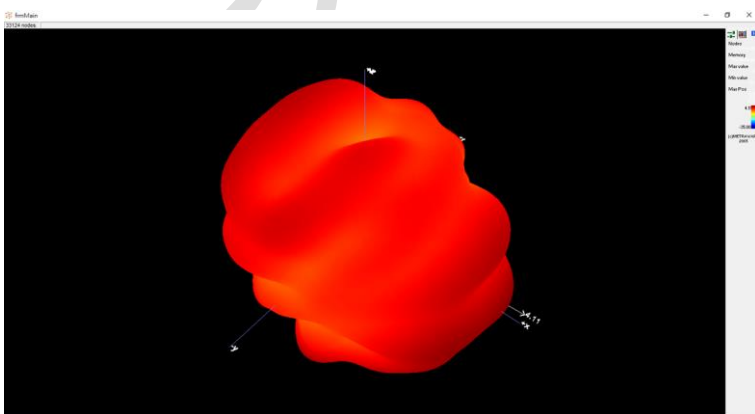

Peak Gain @ 5850MHz : 4.11dBi