

TEST REPORT

CERTIFICATE OF CONFORMITY

Standard: 47 CFR FCC Part 15, Subpart C (Section 15.247)
Report No.: RFBECO-WTW-P21060006A-2
FCC ID: TLZ-CM358SM
Test Model: AW-CM358AN
Series Model: AW-CM358SM, AW-CM358
Received Date: 2022/3/10
Test Date: 2022/9/1 ~ 2022/9/7
Issued Date: 2022/9/29

Applicant: AzureWave Technologies, Inc.

Address: 8F., No.94, Baozhong Rd., Xindian Dist., New Taipei City 23144, Taiwan

Issued By: Bureau Veritas Consumer Products Services (H.K.) Ltd., Taoyuan Branch
Hsin Chu Laboratory

Lab Address: E-2, No.1, Li Hsin 1st Road, Hsinchu Science Park, Hsinchu City 300, Taiwan

Test Location: E-2, No.1, Li Hsin 1st Road, Hsinchu Science Park, Hsinchu City 300, Taiwan

FCC Registration / 723255 / TW2022

Designation Number:

Approved by: _____

May Chen / Manager

Date: _____

2022/9/29

This test report consists of 41 pages in total. It may be duplicated completely for legal use with the approval of the applicant. It should not be reproduced except in full, without the written approval of our laboratory. The test results in the report only apply to the tested sample. The test results in this report are traceable to the national or international standards.



Prepared by : Cherry Chuo / Specialist

This report is governed by, and incorporates by reference, the Conditions of Testing as posted at the date of issuance of this report at <http://www.bureauveritas.com/home/about-us/our-business/cps/about-us/terms-conditions/> and is intended for your exclusive use. Any copying or replication of this report to or for any other person or entity, or use of our name or trademark, is permitted only with our prior written permission. This report sets forth our findings solely with respect to the test samples identified herein. The results set forth in this report are not indicative or representative of the quality or characteristics of the lot from which a test sample was taken or any similar or identical product unless specifically and expressly noted. Our report includes all of the tests requested by you and the results thereof based upon the information that you provided to us. Measurement uncertainty is only provided upon request for accredited tests. Statements of conformity are based on simple acceptance criteria without taking measurement uncertainty into account, unless otherwise requested in writing. You have 60 days from date of issuance of this report to notify us of any material error or omission caused by our negligence or if you require measurement uncertainty; provided, however, that such notice shall be in writing and shall specifically address the issue you wish to raise. A failure to raise such issue within the prescribed time shall constitute your unqualified acceptance of the completeness of this report, the tests conducted and the correctness of the report contents.

Table of Contents

Release Control Record	3
1 Certificate.....	4
2 Summary of Test Results	5
2.1 Measurement Uncertainty	5
2.2 Supplementary Information	5
3 General Information	6
3.1 General Description.....	6
3.2 Antenna Description of EUT	7
3.3 Channel List.....	8
3.4 Test Mode Applicability and Tested Channel Detail.....	9
3.5 Duty Cycle of Test Signal.....	10
3.6 Test Program Used and Operation Descriptions	11
3.7 Connection Diagram of EUT and Peripheral Devices	11
3.8 Configuration of Peripheral Devices and Cable Connections	12
4 Test Instruments	13
4.1 RF Output Power.....	13
4.2 AC Power Conducted Emissions	13
4.3 Unwanted Emissions below 1 GHz	14
4.4 Unwanted Emissions above 1 GHz.....	15
5 Limits of Test Items.....	16
5.1 RF Output Power.....	16
5.2 AC Power Conducted Emissions	16
5.3 Unwanted Emissions below 1 GHz	16
5.4 Unwanted Emissions above 1 GHz.....	16
6 Test Arrangements.....	17
6.1 RF Output Power.....	17
6.1.1 Test Setup	17
6.1.2 Test Procedure.....	17
6.2 AC Power Conducted Emissions	17
6.2.1 Test Setup	17
6.2.2 Test Procedure.....	17
6.3 Unwanted Emissions below 1 GHz	18
6.3.1 Test Setup	18
6.3.2 Test Procedure.....	19
6.4 Unwanted Emissions above 1 GHz.....	20
6.4.1 Test Setup	20
6.4.2 Test Procedure.....	20
7 Test Results of Test Item	21
7.1 RF Output Power.....	21
7.2 AC Power Conducted Emissions	22
7.3 Unwanted Emissions below 1 GHz	24
7.4 Unwanted Emissions above 1 GHz.....	26
8 Pictures of Test Arrangements	40
9 Information of the Testing Laboratories	41



Release Control Record

Issue No.	Description	Date Issued
RFBECO-WTW-P21060006A-2	Original release.	2022/9/29

1 Certificate

Product: IEEE 802.11a/b/g/n/ac WLAN with Bluetooth 5 Combo Stamp Module

Brand: AzureWave

Test Model: AW-CM358AN

Series Model: AW-CM358SM, AW-CM358

Sample Status: Engineering sample

Applicant: AzureWave Technologies, Inc.

Test Date: 2022/9/1 ~ 2022/9/7

Standard: 47 CFR FCC Part 15, Subpart C (Section 15.247)

Measurement ANSI C63.10-2013

procedure: KDB 558074 D01 15.247 Meas Guidance v05r02

The above equipment has been tested by **Bureau Veritas Consumer Products Services (H.K.) Ltd., Taoyuan Branch**, and found compliance with the requirement of the above standards. The test record, data evaluation & Equipment Under Test (EUT) configurations represented herein are true and accurate accounts of the measurements of the sample's RF characteristics under the conditions specified in this report.

2 Summary of Test Results

47 CFR FCC Part 15, Subpart C (Section 15.247)			
Standard / Clause	Test Item	Result	Remark
15.247 (a)(1)	RF Output Power	Pass	Meet the requirement of limit.
15.247(a)(1) (iii)	Number of Hopping Frequency Used	NA	Refer to Note 1 below
15.247(a)(1) (iii)	Dwell Time on Each Channel	NA	Refer to Note 1 below
15.247(a)(1)	Hopping Channel Separation	NA	Refer to Note 1 below
15.247(a)(1)	20 dB Bandwidth	NA	Refer to Note 1 below
15.247(d)	Conducted Out of Band Emissions	NA	Refer to Note 1 below
15.207	AC Power Conducted Emissions	Pass	Minimum passing margin is -18.64 dB at 0.41947 MHz
15.205 / 15.209 / 15.247(d)	Unwanted Emissions below 1 GHz	Pass	Minimum passing margin is -3.3 dB at 359.94, 575.95 MHz
15.205 / 15.209 / 15.247(d)	Unwanted Emissions above 1 GHz	Pass	Minimum passing margin is -4.8 dB at 4804.00 MHz
15.203	Antenna Requirement	Pass	No antenna connector is used.

Notes:

1. RF Output Power, AC Power Conducted Emissions and Unwanted Emissions were performed for this addendum. The others testing data refer to original test report.
2. Determining compliance based on the results of the compliance measurement, not taking into account measurement instrumentation uncertainty.

2.1 Measurement Uncertainty

Where relevant, the following measurement uncertainty levels have been estimated for tests performed on the EUT as specified in CISPR 16-4-2:

Measurement	Specification	Expanded Uncertainty (k=2) (±)
AC Power Conducted Emissions	150 kHz ~ 30 MHz	1.9 dB
Unwanted Emissions below 1 GHz	9 kHz ~ 30 MHz	3.1 dB
	30 MHz ~ 1 GHz	5.5 dB
Unwanted Emissions above 1 GHz	1 GHz ~ 18 GHz	5.1 dB
	18 GHz ~ 40 GHz	5.3 dB

The other instruments specified are routine verified to remain within the calibrated levels, no measurement uncertainty is required to be calculated.

2.2 Supplementary Information

There is not any deviation from the test standards for the test method, and no modifications required for compliance.

3 General Information

3.1 General Description

Product	IEEE 802.11a/b/g/n/ac WLAN with Bluetooth 5 Combo Stamp Module
Brand	AzureWave
Test Model	AW-CM358SM, AW-CM358, AW-CM358AN
Status of EUT	Engineering sample
Power Supply Rating	3.3 Vdc from host equipment
Modulation Type	GFSK, $\pi/4$ -DQPSK, 8DPSK
Modulation Technology	FHSS
Transfer Rate	Up to 3 Mbps
Operating Frequency	2.402 GHz ~ 2.48 GHz
Number of Channel	79
Output Power	22.909 mW (13.6 dBm)

Note:

- This report is prepared for FCC Class II permissive change. The difference compared with the Report No.: RFBECO-WTW-P21060006-2 design is as the following information:
 - ◆ Add model name. (Refer to Note 4)
 - ◆ Add PCB antenna. Digital element with antenna related item. Does not affect RF (Refer to Section 3.2)
- According to above conditions and the applicant's requirements, only RF Output Power, AC Power Conducted Emissions and Unwanted Emissions test items need to be performed. All data for meeting the requirement is verified.
- WLAN (2.4GHz), WLAN (5GHz) and Bluetooth technology can't transmit at same time.
- All models are listed as below.

Original		
Brand	Model	Difference
AzureWave	AW-CM358SM	All models are electrically identical, different model names are for marketing purpose.
	AW-CM358	
Newly		
Brand	Model	Difference
AzureWave	AW-CM358AN	Extend PCBA (Digital element with antenna related item) and add antenna on board.

Note: All models share the same internal PCB layout and are electrically identical. The only difference is in antenna as noted above.

From the above models, model: AW-CM358AN was selected as representative model for the test and its data was recorded in this report.

- The above EUT information is declared by manufacturer and for more detailed features description, please refer to the manufacturer's specifications or user's manual.

3.2 Antenna Description of EUT

1. The antenna information is listed as below.

Original					
Brand	Model	Ant. Net Gain (dBi)	Frequency range (GHz)	Antenna Type	Connector Type
MAG.LAYERS	MSA-4008-25GC1-A2	2.98	2.4~2.4835	PIFA	i-pex(MHF)
		5.16	5.15~5.85		
Newly					
Brand	Model	Ant. Net Gain (dBi)	Frequency range (GHz)	Antenna Type	Connector Type
AzureWave	AW-CM358AN	3.4	2.4~2.4835	PCB	None
		3.4	5.15~5.85		

* Detail antenna specification please refer to antenna datasheet and/or antenna measurement report.

3.3 Channel List

79 channels are provided for BT-EDR:

Channel	Frequency (MHz)	Channel	Frequency (MHz)	Channel	Frequency (MHz)	Channel	Frequency (MHz)
0	2402	20	2422	40	2442	60	2462
1	2403	21	2423	41	2443	61	2463
2	2404	22	2424	42	2444	62	2464
3	2405	23	2425	43	2445	63	2465
4	2406	24	2426	44	2446	64	2466
5	2407	25	2427	45	2447	65	2467
6	2408	26	2428	46	2448	66	2468
7	2409	27	2429	47	2449	67	2469
8	2410	28	2430	48	2450	68	2470
9	2411	29	2431	49	2451	69	2471
10	2412	30	2432	50	2452	70	2472
11	2413	31	2433	51	2453	71	2473
12	2414	32	2434	52	2454	72	2474
13	2415	33	2435	53	2455	73	2475
14	2416	34	2436	54	2456	74	2476
15	2417	35	2437	55	2457	75	2477
16	2418	36	2438	56	2458	76	2478
17	2419	37	2439	57	2459	77	2479
18	2420	38	2440	58	2460	78	2480
19	2421	39	2441	59	2461		

3.4 Test Mode Applicability and Tested Channel Detail

Pre-Scan:	1. Add PCB Ant. EUT can be used in the following ways: X-axis/ Y-axis/ Z-axis/. Pre-scan these ways and find the worst case as a representative test condition.
Worst Case:	1. PCB Ant. Worst Condition: For Unwanted Emission below 1 GHz: X-axis, For Unwanted Emission above 1 GHz: Y-axis 2. Pre-Scan has been conducted to determine the worst-case mode from all possible combinations between available modulations, data rates and antenna ports (if EUT with antenna diversity architecture).

Following channel(s) was (were) selected for the final test as listed below:

Test Item	Tested Channel	Modulation	Data Rate Parameter
RF Output Power	0, 39, 78	GFSK	DH5
		8DPSK	3DH5
AC Power Conducted Emissions	0	GFSK	DH5
Unwanted Emissions below 1 GHz	0	GFSK	DH5
Unwanted Emissions above 1 GHz	0, 39, 78	GFSK	DH5
	0, 39, 78	8DPSK	3DH5

3.5 Duty Cycle of Test Signal

Duty cycle of test signal is $\geq 98\%$, duty factor is not required.

Duty cycle of test signal is $< 98\%$, duty factor shall be considered.

GFSK: Duty cycle = $2.88 \text{ ms} / 3.76 \text{ ms} \times 100\% = 76.6\%$, duty factor = $10 \cdot \log(1/\text{Duty cycle}) = 1.16 \text{ dB}$

8DPSK: Duty cycle = $2.872 \text{ ms} / 3.752 \text{ ms} \times 100\% = 76.5\%$, duty factor = $10 \cdot \log(1/\text{Duty cycle}) = 1.16 \text{ dB}$

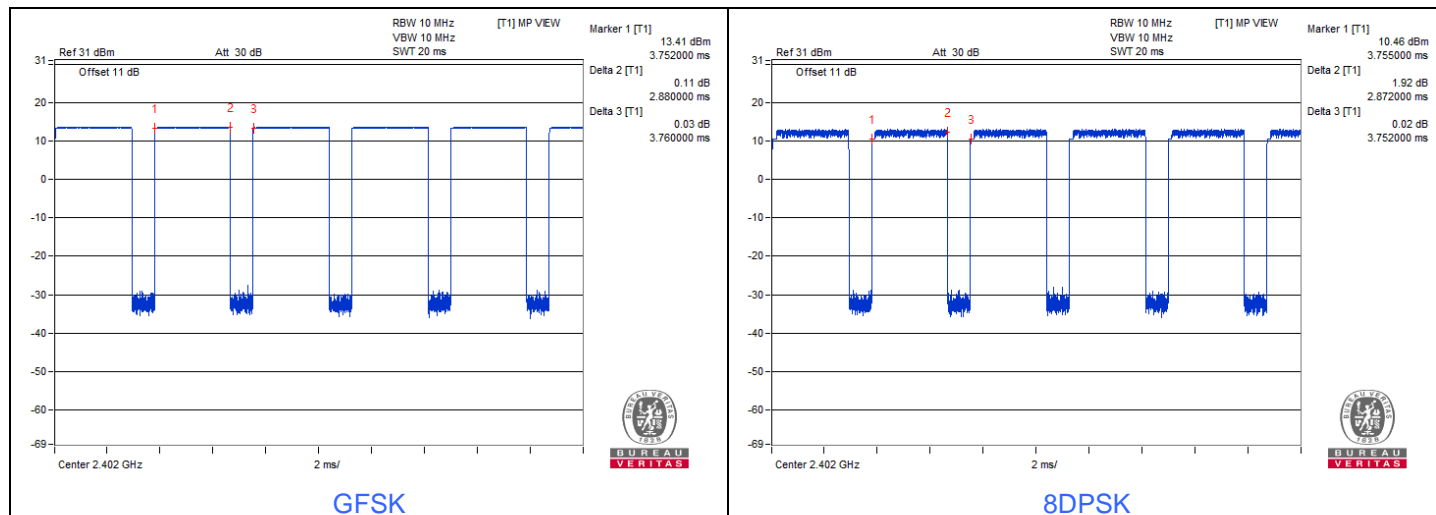

3.6 Test Program Used and Operation Descriptions

Controlling software (DutApiSisoACDuallf.exe 1.0.0.164) has been activated to set the EUT under transmission condition continuously at specific channel frequency.

3.7 Connection Diagram of EUT and Peripheral Devices

For AC Power Conducted Emission test

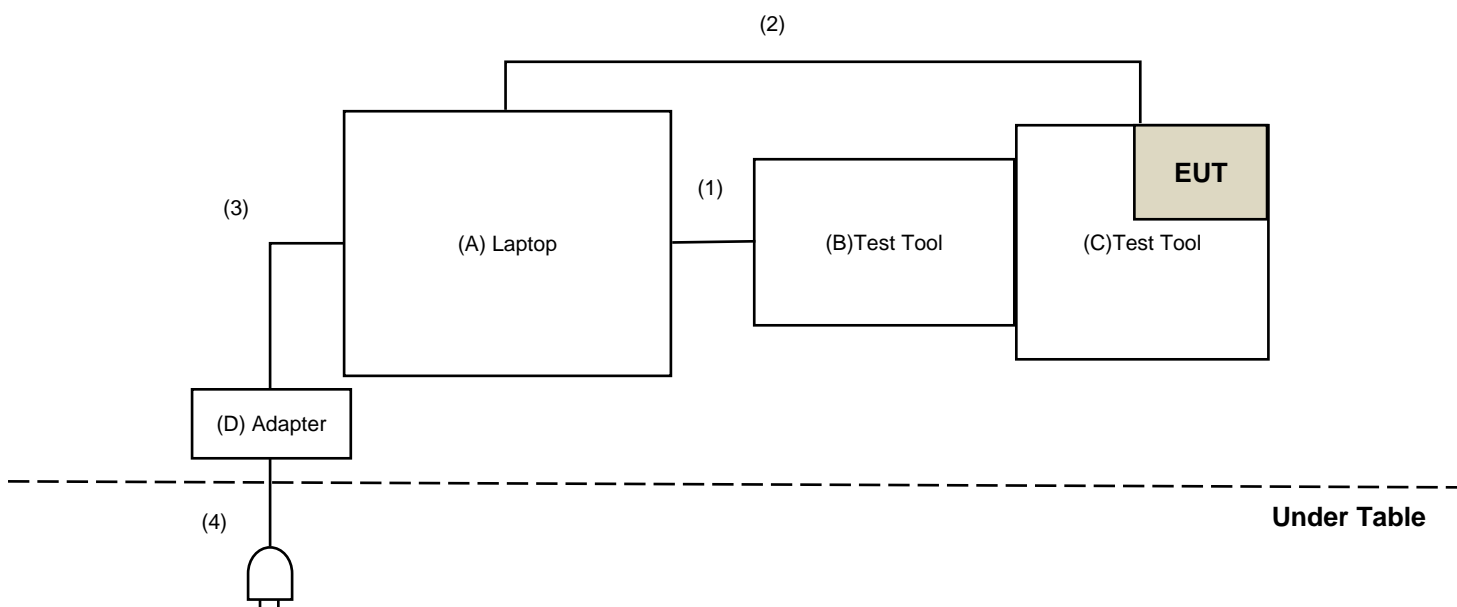

For Unwanted Emission test

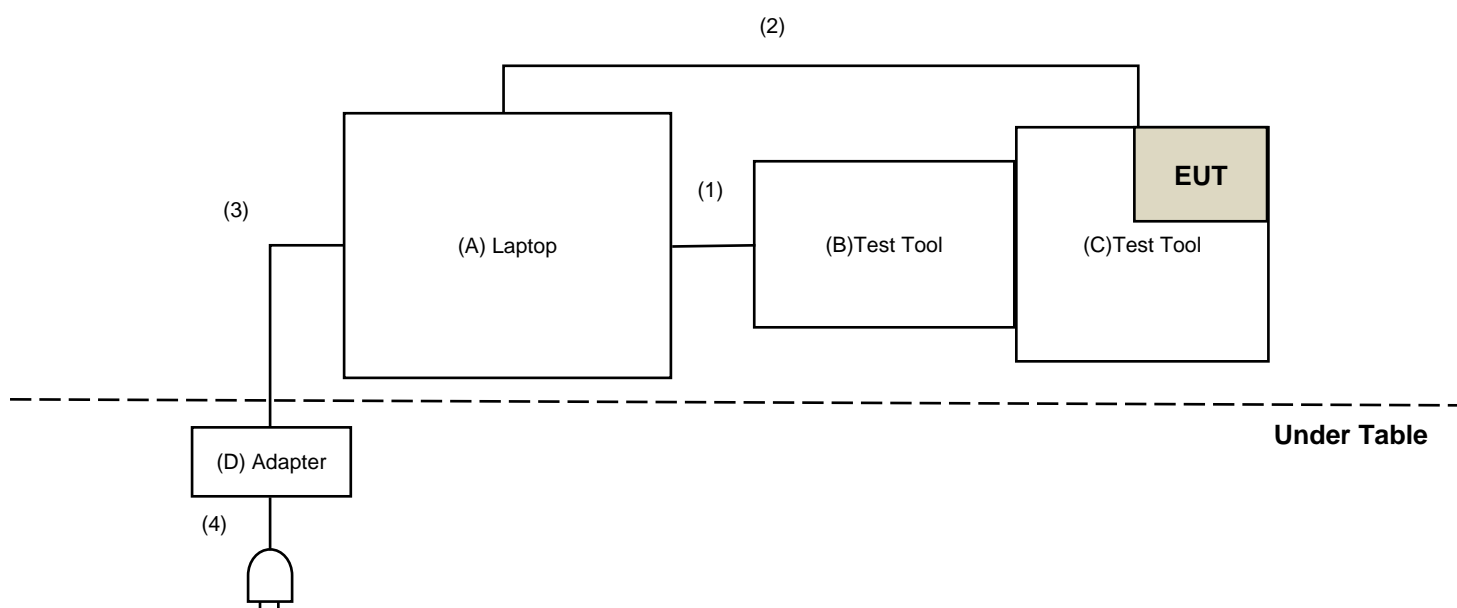

3.8 Configuration of Peripheral Devices and Cable Connections

ID	Product	Brand	Model No.	Serial No.	FCC ID	Remarks
A	Laptop	Sony	PCG-61711P	N/A	N/A	Supplied by applicant
B	Test Tool	Azure Wave	N/A	N/A	N/A	Supplied by applicant
C	Test Tool	Azure Wave	N/A	N/A	N/A	Supplied by applicant
D	Adapter	Sony	VGP-AC19V41	N/A	N/A	Supplied by applicant

ID	Cable Descriptions	Qty.	Length (m)	Shielding (Yes/No)	Cores (Qty.)	Remarks
1	USB Type B Cable	1	1.8	Yes	0	Provided by Lab
2	USB Type B Cable	1	1.8	Yes	0	Provided by Lab
3	DC Cable	1	0.8	No	0	Supplied by applicant
4	AC Cable	1	1.8	No	0	Supplied by applicant

4 Test Instruments

The calibration interval of the all test instruments are 12 months and the calibrations are traceable to NML/ROC and NIST/USA.

4.1 RF Output Power

Description Manufacturer	Model No.	Serial No.	Calibrated Date	Calibrated Until
Power Meter Anritsu	ML2495A	1529002	2022/6/22	2023/6/21
Pulse Power Sensor Anritsu	MA2411B	1726434	2022/6/22	2023/6/21

Notes:

1. The test was performed in Oven room 2.
2. Tested Date: 2022/9/7

4.2 AC Power Conducted Emissions

Description Manufacturer	Model No.	Serial No.	Calibrated Date	Calibrated Until
50 ohms Terminator	50	3	2021/10/27	2022/10/26
Fixed attenuator STI	STI02-2200-10	005	2022/8/24	2023/8/23
LISN R&S	ESH3-Z5	848773/004	2021/10/29	2022/10/28
RF Coaxial Cable JYEBO	5D-FB	COCCAB-001	2022/8/24	2023/8/23
Software BVADT	BVADT_Cond_V7.3.7.4	N/A	N/A	N/A
TEST RECEIVER R&S	ESCS 30	847124/029	2021/10/13	2022/10/12

Notes:

1. The test was performed in Conduction 1
2. Tested Date: 2022/9/5

4.3 Unwanted Emissions below 1 GHz

Description Manufacturer	Model No.	Serial No.	Calibrated Date	Calibrated Until
Boresight Antenna Tower & Turn Table Max-Full	MF-7802BS	MF780208530	N/A	N/A
Fixed attenuator Mini-Circuits	UNAT-5+	PAD-ATT5-03	2022/1/10	2023/1/9
LOOP ANTENNA Electro-Metrics	EM-6879	264	2022/3/18	2023/3/17
Pre_Amplifier Agilent	8447D	2944A10636	2022/3/19	2023/3/18
Pre_Amplifier EMCI	EMC330N	980701	2022/3/8	2023/3/7
RF Coaxial Cable COMMATE/PEWC	8D	966-4-1	2022/3/8	2023/3/7
		966-4-2	2022/3/8	2023/3/7
		966-4-3	2022/3/8	2023/3/7
RF Coaxial Cable JYEBO	5D-FB	LOOPCAB-001	2022/1/6	2023/1/5
		LOOPCAB-002	2022/1/6	2023/1/5
Software	ADT_Radiated_V8.7.08	N/A	N/A	N/A
Test Receiver Agilent	N9038A	MY51210202	2021/11/19	2022/11/18
Trilog Broadband Antenna Schwarzbeck	VULB 9168	9168-406	2021/10/27	2022/10/26

Notes:

1. The test was performed in 966 Chamber No. 4.
2. Tested Date: 2022/9/5

4.4 Unwanted Emissions above 1 GHz

Description Manufacturer	Model No.	Serial No.	Calibrated Date	Calibrated Until
Boresight Antenna Tower & Turn Table Max-Full	MF-7802BS	MF780208530	N/A	N/A
Horn Antenna Schwarzbeck	BBHA 9120D	9120D-783	2021/11/14	2022/11/13
	BBHA 9170	9170-739	2021/11/14	2022/11/13
Pre_Amplifier EMCI	EMC 12630 SE	980638	2022/4/5	2023/4/4
	EMC184045SE	980387	2022/1/10	2023/1/9
RF Cable-Frequency Range : 1- 26.5GHz EMCI	EMC104-SM-SM-1200	160922	2021/12/24	2022/12/23
RF Cable-Frequency range: 1- 40GHz EMCI	EMC102-KM-KM-1200	160924	2022/1/10	2023/1/9
RF Coaxial Cable EMCI	EMC-KM-KM-4000	200214	2022/3/8	2023/3/7
	EMC104-SM-SM-2000	180502	2022/4/25	2023/4/24
	EMC104-SM-SM-6000	210704	2021/11/9	2022/11/8
Software	ADT_Radiated_V8.7.08	N/A	N/A	N/A
Test Receiver Agilent	N9038A	MY51210202	2021/11/19	2022/11/18

Notes:

1. The test was performed in 966 Chamber No. 4.
2. Tested Date: 2022/9/1 ~ 2022/9/5

5 Limits of Test Items

5.1 RF Output Power

The Maximum Output Power Measurement is 125 mW (21 dBm).

5.2 AC Power Conducted Emissions

Frequency (MHz)	Conducted Limit (dBuV)	
	Quasi-peak	Average
0.15 - 0.5	66 - 56	56 - 46
0.50 - 5.0	56	46
5.0 - 30.0	60	50

Notes:

1. The lower limit shall apply at the transition frequencies.
2. The limit decreases in line with the logarithm of the frequency in the range of 0.15 to 0.50 MHz.

5.3 Unwanted Emissions below 1 GHz

Radiated emissions up to 1 GHz which fall in the restricted bands must comply with the radiated emission limits specified as below table. Other emissions shall be at least 20 dB below the highest level of the desired power:

Frequencies (MHz)	Field Strength (microvolts/meter)	Measurement Distance (meters)
0.009 ~ 0.490	2400/F(kHz)	300
0.490 ~ 1.705	24000/F(kHz)	30
1.705 ~ 30.0	30	30
30 ~ 88	100	3
88 ~ 216	150	3
216 ~ 960	200	3
Above 960	500	3

Notes:

1. The lower limit shall apply at the transition frequencies.
2. Emission level (dBuV/m) = 20 log Emission level (uV/m).

5.4 Unwanted Emissions above 1 GHz

Radiated emissions above 1 GHz which fall in the restricted bands must comply with the radiated emission limits specified as below table. Other emissions shall be at least 20 dB below the highest level of the desired power:

Frequencies (MHz)	Field Strength (microvolts/meter)	Measurement Distance (meters)
Above 960	500	3

Notes:

1. The lower limit shall apply at the transition frequencies.
2. Emission level (dBuV/m) = 20 log Emission level (uV/m).
3. For frequencies above 1000 MHz, the field strength limits are based on average detector, however, the peak field strength of any emission shall not exceed the maximum permitted average limits, specified above by more than 20 dB under any condition of modulation.

6 Test Arrangements

6.1 RF Output Power

6.1.1 Test Setup

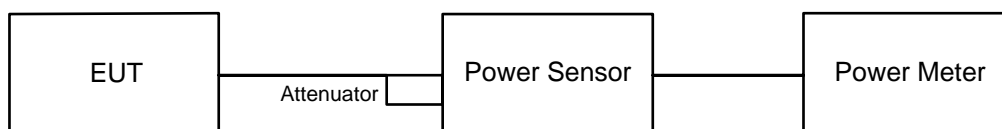

6.1.2 Test Procedure

Peak Power:

A peak power sensor was used on the output port of the EUT. A power meter was used to read the response of the peak power sensor. Record the power level.

Average Power:

Average power sensor was used to perform output power measurement, trigger and gating function of wide band power meter is enabled to measure max output power of TX on burst. Duty factor is not added to measured value.

6.2 AC Power Conducted Emissions

6.2.1 Test Setup

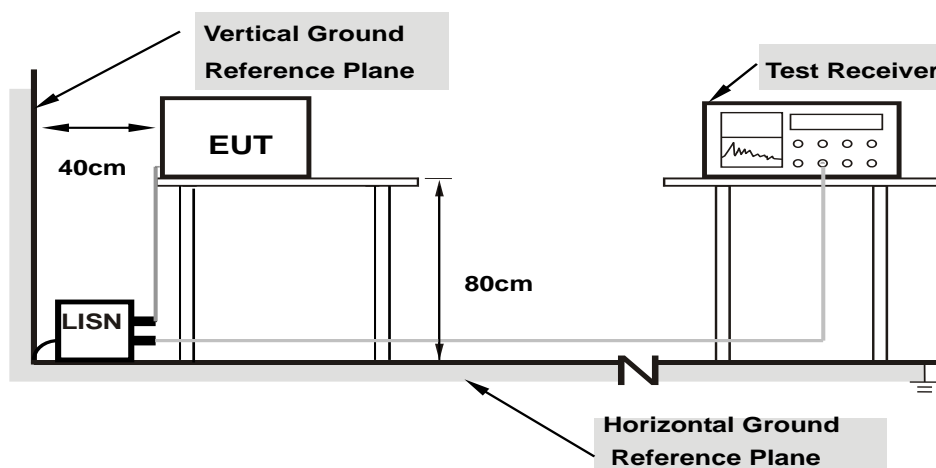

For the actual test configuration, please refer to the attached file (Test Setup Photo).

6.2.2 Test Procedure

- The EUT was placed on a 0.8 meter to the top of table and placed 0.4 meters from the conducting wall of the shielded room with EUT being connected to the power mains through a line impedance stabilization network (LISN). Other support units were connected to the power mains through another LISN. The two LISNs provide 50 ohm/ 50 uH of coupling impedance for the measuring instrument.
- Both lines of the power mains connected to the EUT were checked for maximum conducted interference.
- The frequency range from 150 kHz to 30 MHz was searched. Emission levels under (Limit – 20 dB) was not recorded.

Note: The resolution bandwidth and video bandwidth of test receiver is 9 kHz for quasi-peak detection (QP) and average detection (AV) at frequency 0.15 MHz-30 MHz.

6.3 Unwanted Emissions below 1 GHz

6.3.1 Test Setup

For Radiated emission below 30 MHz

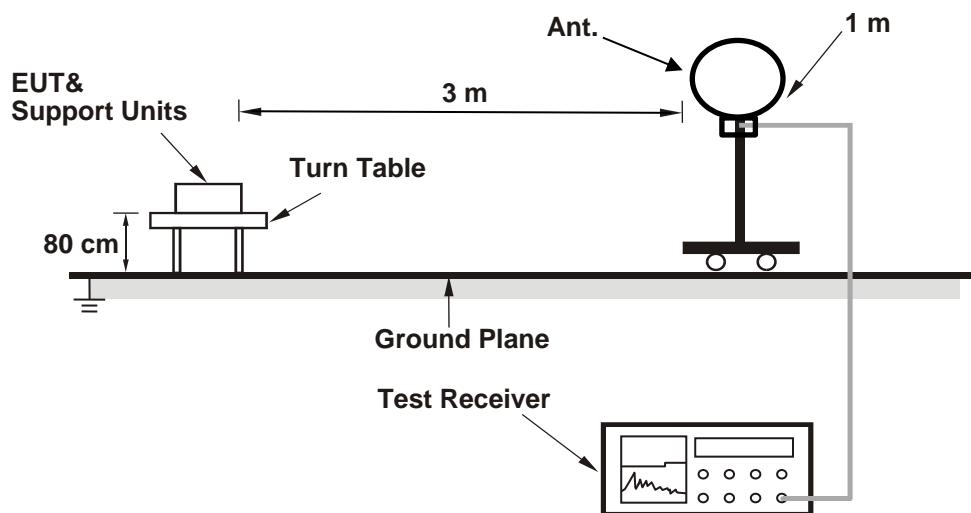

For Radiated emission above 30 MHz

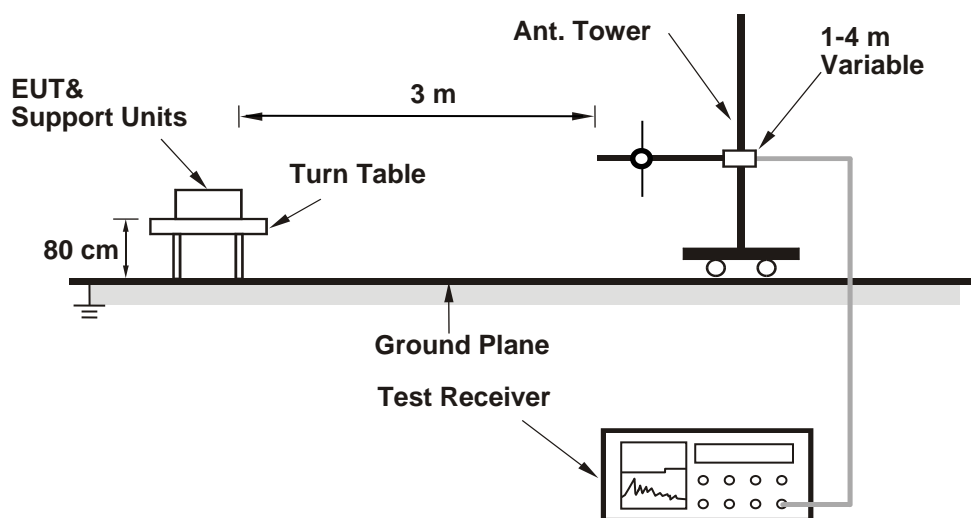

For the actual test configuration, please refer to the attached file (Test Setup Photo).

6.3.2 Test Procedure

For Radiated emission below 30 MHz

- a. The EUT was placed on the top of a rotating table 0.8 meters above the ground at 3 meter chamber room for test. The table was rotated 360 degrees to determine the position of the highest radiation.
- b. The EUT was set 3 meters away from the interference-receiving antenna, which was mounted on the top of a variable-height antenna tower.
- c. Parallel, perpendicular, and ground-parallel orientations of the antenna are set to make the measurement.
- d. For each suspected emission, the EUT was arranged to its worst case and the rotatable table was turned from 0 degrees to 360 degrees to find the maximum reading.
- e. The test-receiver system was set to Quasi-Peak Detect Function and Specified Bandwidth with Maximum Hold Mode, except for the frequency band (9 kHz to 90 kHz and 110 kHz to 490 kHz) set to average detect function and peak detect function.

Notes:

1. The resolution bandwidth and video bandwidth of test receiver/spectrum analyzer is 200 Hz at frequency below 150 kHz.
2. The resolution bandwidth and video bandwidth of test receiver/spectrum analyzer is 9 kHz or 10 kHz at frequency (150 kHz to 30 MHz).
3. All modes of operation were investigated and the worst-case emissions are reported.

For Radiated emission above 30 MHz

- a. The EUT was placed on the top of a rotating table 0.8 meters above the ground at 3 meter chamber room for test. The table was rotated 360 degrees to determine the position of the highest radiation.
- b. The EUT was set 3 meters away from the interference-receiving antenna, which was mounted on the top of a variable-height antenna tower.
- c. The height of antenna is varied from one meter to four meters above the ground to determine the maximum value of the field strength. Both horizontal and vertical polarizations of the antenna are set to make the measurement.
- d. For each suspected emission, the EUT was arranged to its worst case and then the antenna was tuned to heights from 1 meter to 4 meters and the rotatable table was turned from 0 degrees to 360 degrees to find the maximum reading.
- e. The test-receiver system was set to quasi-peak detect function and specified bandwidth with maximum hold mode when the test frequency is below 1 GHz.

Notes:

1. The resolution bandwidth and video bandwidth of test receiver/spectrum analyzer is 120 kHz for Quasi-peak detection (QP) at frequency below 1 GHz.
2. All modes of operation were investigated and the worst-case emissions are reported.

6.4 Unwanted Emissions above 1 GHz

6.4.1 Test Setup

For Radiated emission above 1 GHz

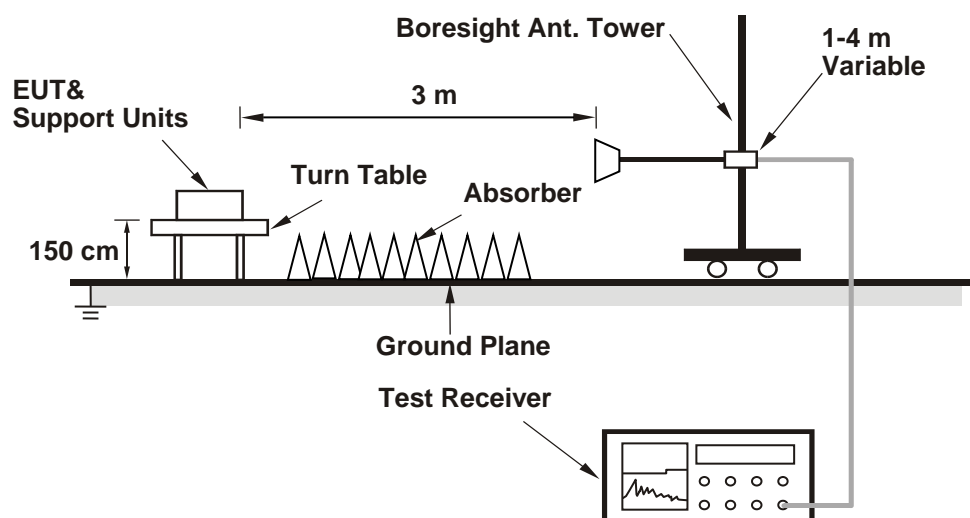

For the actual test configuration, please refer to the attached file (Test Setup Photo).

6.4.2 Test Procedure

- The EUT was placed on the top of a rotating table 1.5 meters above the ground at 3 meter chamber room for test. The table was rotated 360 degrees to determine the position of the highest radiation.
- The EUT was set 3 meters away from the interference-receiving antenna, which was mounted on the top of a variable-height antenna tower.
- The height of antenna is varied from one meter to four meters above the ground to determine the maximum value of the field strength. Both horizontal and vertical polarizations of the antenna are set to make the measurement.
- For each suspected emission, the EUT was arranged to its worst case and then the antenna was tuned to heights from 1 meter to 4 meters and the rotatable table was turned from 0 degrees to 360 degrees to find the maximum reading.
- The test-receiver system was set to peak and average detects function and specified bandwidth with maximum hold mode when the test frequency is above 1 GHz. If the peak reading value also meets average limit, measurement with the average detector is unnecessary.

Notes:

- The resolution bandwidth of test receiver/spectrum analyzer is 1 MHz and the video bandwidth is 3 MHz for Peak detection (PK) and Average detection (AV) at frequency above 1 GHz.
- For fundamental and harmonic signal measurement, the resolution bandwidth of test receiver/spectrum analyzer is 1 MHz and the video bandwidth is $\geq 1/T$ (Duty cycle < 98%) or 10 Hz (Duty cycle $\geq 98\%$) for Average detection (AV) at frequency above 1 GHz.
- All modes of operation were investigated and the worst-case emissions are reported.

7 Test Results of Test Item

7.1 RF Output Power

Input Power:	3.3 Vdc	Environmental Conditions:	25°C, 63% RH	Tested By:	Eric Peng
--------------	---------	---------------------------	--------------	------------	-----------

For Peak Power

GFSK

Chan.	Chan. Freq. (MHz)	Peak Power (mW)	Peak Power (dBm)	Power Limit (dBm)	Test Result
0	2402	22.909	13.60	21	Pass
39	2441	22.491	13.52	21	Pass
78	2480	21.777	13.38	21	Pass

Note: The antenna gain is 3.4 dBi < 6 dBi, so the output power limit shall not be reduced.

8DPSK

Chan.	Chan. Freq. (MHz)	Peak Power (mW)	Peak Power (dBm)	Power Limit (dBm)	Test Result
0	2402	19.099	12.81	21	Pass
39	2441	18.75	12.73	21	Pass
78	2480	18.664	12.71	21	Pass

Note: The antenna gain is 3.4 dBi < 6 dBi, so the output power limit shall not be reduced.

For Average Power

GFSK

Chan.	Chan. Freq. (MHz)	Average Power (mW)	Average Power (dBm)
0	2402	22.387	13.50
39	2441	22.08	13.44
78	2480	21.33	13.29

8DPSK

Chan.	Chan. Freq. (MHz)	Average Power (mW)	Average Power (dBm)
0	2402	11.117	10.46
39	2441	10.691	10.29
78	2480	10.423	10.18

7.2 AC Power Conducted Emissions

RF Mode	TX BT GFSK	Channel	CH 0 : 2402 MHz
Frequency Range	150 kHz ~ 30 MHz	Detector Function & Resolution Bandwidth	Quasi-Peak (QP) / Average (AV), 9 kHz
Input Power (System)	120 Vac, 60 Hz	Environmental Conditions	25°C, 65% RH
Tested By	Tom Yang		

Phase Of Power : Line (L)

No	Frequency (MHz)	Correction Factor (dB)	Reading Value (dBuV)		Emission Level (dBuV)		Limit (dBuV)		Margin (dB)	
			Q.P.	AV.	Q.P.	AV.	Q.P.	AV.	Q.P.	AV.
1	0.15117	9.94	35.73	17.25	45.67	27.19	65.94	55.94	-20.27	-28.75
2	0.18752	9.95	33.80	16.93	43.75	26.88	64.15	54.15	-20.40	-27.27
3	0.23251	9.95	22.76	6.35	32.71	16.30	62.36	52.36	-29.65	-36.06
4	0.41958	9.95	23.76	16.64	33.71	26.59	57.46	47.46	-23.75	-20.87
5	1.84152	10.02	19.13	13.46	29.15	23.48	56.00	46.00	-26.85	-22.52
6	8.07962	10.40	18.64	11.63	29.04	22.03	60.00	50.00	-30.96	-27.97

Remarks:

1. Q.P. and AV. are abbreviations of quasi-peak and average individually.
2. The emission levels of other frequencies were very low against the limit.
3. Margin value = Emission level – Limit value
4. Correction factor = Insertion loss + Cable loss
5. Emission Level = Correction Factor + Reading Value

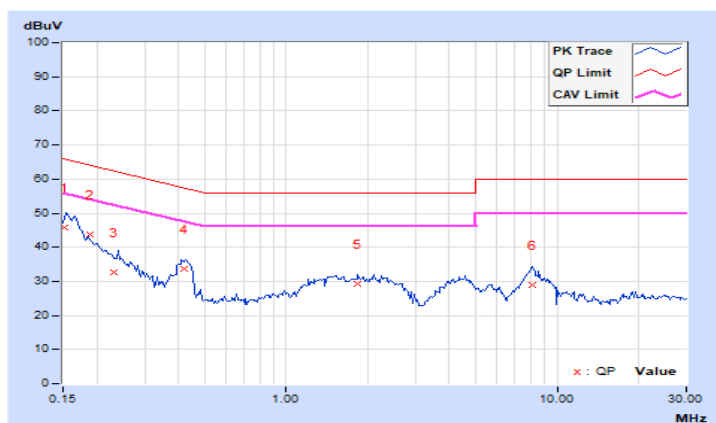

RF Mode	TX BT GFSK	Channel	CH 0 : 2402 MHz
Frequency Range	150 kHz ~ 30 MHz	Detector Function & Resolution Bandwidth	Quasi-Peak (QP) / Average (AV), 9 kHz
Input Power (System)	120 Vac, 60 Hz	Environmental Conditions	25°C, 65% RH
Tested By	Tom Yang		

Phase Of Power : Neutral (N)										
No	Frequency (MHz)	Correction Factor (dB)	Reading Value (dBuV)		Emission Level (dBuV)		Limit (dBuV)		Margin (dB)	
			Q.P.	AV.	Q.P.	AV.	Q.P.	AV.	Q.P.	AV.
1	0.15157	9.95	36.26	18.53	46.21	28.48	65.91	55.91	-19.70	-27.43
2	0.19437	9.95	30.08	12.71	40.03	22.66	63.85	53.85	-23.82	-31.19
3	0.41947	9.96	26.41	18.86	36.37	28.82	57.46	47.46	-21.09	-18.64
4	1.68473	10.02	18.67	12.06	28.69	22.08	56.00	46.00	-27.31	-23.92
5	4.57651	10.16	18.43	10.44	28.59	20.60	56.00	46.00	-27.41	-25.40
6	20.04615	10.92	19.94	15.23	30.86	26.15	60.00	50.00	-29.14	-23.85

Remarks:

1. Q.P. and AV. are abbreviations of quasi-peak and average individually.
2. The emission levels of other frequencies were very low against the limit.
3. Margin value = Emission level – Limit value
4. Correction factor = Insertion loss + Cable loss
5. Emission Level = Correction Factor + Reading Value

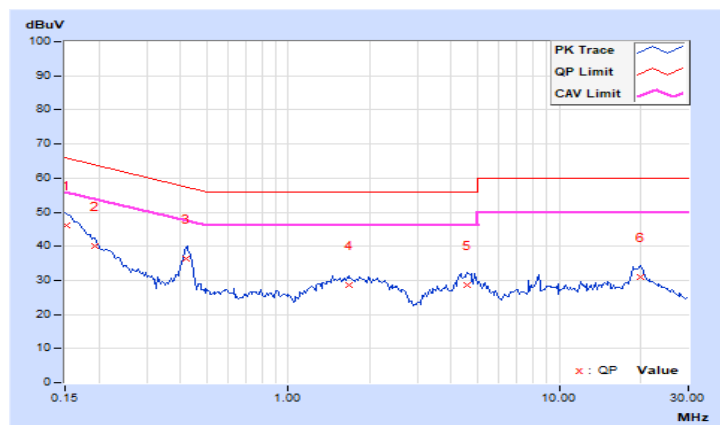

7.3 Unwanted Emissions below 1 GHz

RF Mode	TX BT GFSK	Channel	CH 0 : 2402 MHz
Frequency Range	9 kHz ~ 1 GHz	Detector Function & Bandwidth	(QP) RB = 120kHz
Input Power (System)	120 Vac, 60 Hz	Environmental Conditions	25°C, 65% RH
Tested By	Tom Yang		

Antenna Polarity & Test Distance : Horizontal at 3 m

No	Frequency (MHz)	Emission Level (dBuV/m)	Limit (dBuV/m)	Margin (dB)	Antenna Height (m)	Table Angle (Degree)	Raw Value (dBuV)	Correction Factor (dB/m)
1	60.01	35.5 QP	40.0	-4.5	2.00 H	327	48.5	-13.0
2	107.94	36.8 QP	43.5	-6.7	1.50 H	167	51.7	-14.9
3	249.99	42.3 QP	46.0	-3.7	1.00 H	103	54.8	-12.5
4	359.94	42.7 QP	46.0	-3.3	1.00 H	167	51.5	-8.8
5	432.00	42.5 QP	46.0	-3.5	2.00 H	153	48.7	-6.2
6	575.98	42.2 QP	46.0	-3.8	3.00 H	356	45.0	-2.8

Remarks:

1. Emission Level(dBuV/m) = Raw Value(dBuV) + Correction Factor(dB/m)
2. Correction Factor(dB/m) = Antenna Factor(dB/m) + Cable Factor(dB) – Pre-Amplifier Factor(dB)
3. Margin value = Emission Level – Limit value
4. The other emission levels were very low against the limit of frequency range 30 MHz ~ 1 GHz.
5. The emission levels were very low against the limit of frequency range 9 kHz ~ 30 MHz: the amplitude of spurious emissions attenuated more than 20 dB below the permissible value to be report.

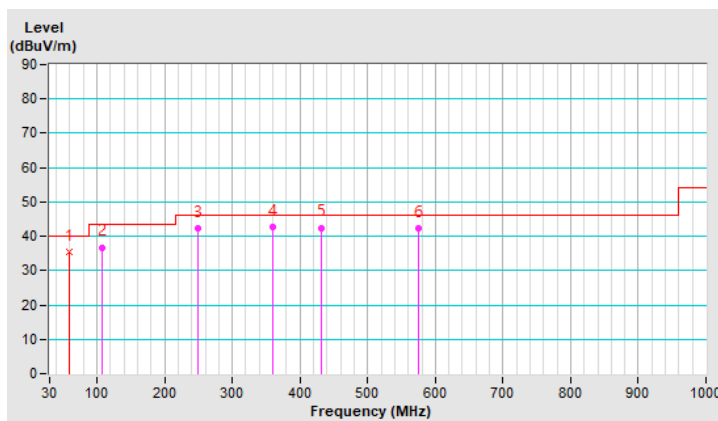

RF Mode	TX BT GFSK	Channel	CH 0 : 2402 MHz
Frequency Range	9 kHz ~ 1 GHz	Detector Function & Bandwidth	(QP) RB = 120kHz
Input Power (System)	120 Vac, 60 Hz	Environmental Conditions	25°C, 65% RH
Tested By	Tom Yang		

Antenna Polarity & Test Distance : Vertical at 3 m								
No	Frequency (MHz)	Emission Level (dBuV/m)	Limit (dBuV/m)	Margin (dB)	Antenna Height (m)	Table Angle (Degree)	Raw Value (dBuV)	Correction Factor (dB/m)
1	107.96	38.2 QP	43.5	-5.3	1.50 V	86	53.1	-14.9
2	155.95	36.8 QP	43.5	-6.7	2.00 V	357	48.4	-11.6
3	249.98	37.2 QP	46.0	-8.8	1.00 V	58	49.7	-12.5
4	312.03	41.3 QP	46.0	-4.7	1.50 V	9	51.3	-10.0
5	431.92	41.9 QP	46.0	-4.1	1.00 V	166	48.2	-6.3
6	575.95	42.7 QP	46.0	-3.3	1.50 V	66	45.5	-2.8

Remarks:

1. Emission Level(dBuV/m) = Raw Value(dBuV) + Correction Factor(dB/m)
2. Correction Factor(dB/m) = Antenna Factor(dB/m) + Cable Factor(dB) – Pre-Amplifier Factor(dB)
3. Margin value = Emission Level – Limit value
4. The other emission levels were very low against the limit of frequency range 30 MHz ~ 1 GHz.
5. The emission levels were very low against the limit of frequency range 9 kHz ~ 30 MHz: the amplitude of spurious emissions attenuated more than 20 dB below the permissible value to be report.

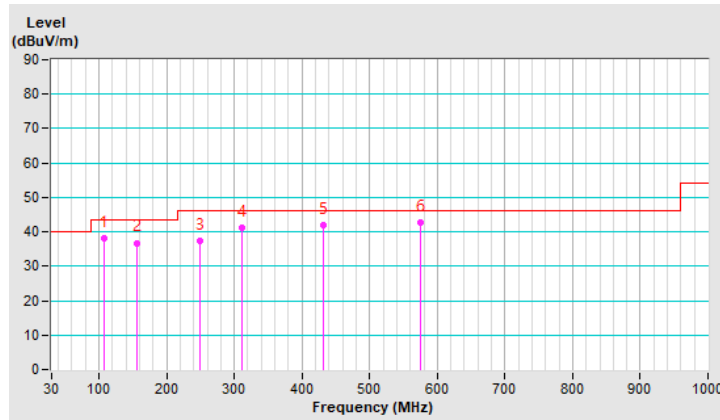

7.4 Unwanted Emissions above 1 GHz

RF Mode	TX BT GFSK	Channel	CH 0 : 2402 MHz
Frequency Range	1 GHz ~ 25 GHz	Detector Function & Bandwidth	(PK) RB = 1 MHz, VB = 3 MHz (AV) RB = 1 MHz, VB = 510 Hz
Input Power (System)	120 Vac, 60 Hz	Environmental Conditions	25°C, 66% RH
Tested By	Tom Yang		

Antenna Polarity & Test Distance : Horizontal at 3 m								
No	Frequency (MHz)	Emission Level (dBuV/m)	Limit (dBuV/m)	Margin (dB)	Antenna Height (m)	Table Angle (Degree)	Raw Value (dBuV)	Correction Factor (dB/m)
1	2390.00	55.4 PK	74.0	-18.6	1.44 H	166	59.9	-4.5
2	2390.00	44.2 AV	54.0	-9.8	1.44 H	166	48.7	-4.5
3	*2402.00	111.5 PK			1.44 H	166	116.0	-4.5
4	*2402.00	111.1 AV			1.44 H	166	115.6	-4.5
5	4804.00	52.1 PK	74.0	-21.9	1.91 H	24	52.3	-0.2
6	4804.00	49.2 AV	54.0	-4.8	1.91 H	24	49.4	-0.2

Remarks:

1. Emission Level(dBuV/m) = Raw Value(dBuV) + Correction Factor(dB/m)
2. Correction Factor(dB/m) = Antenna Factor(dB/m) + Cable Factor(dB) – Pre-Amplifier Factor(dB)
3. Margin value = Emission Level – Limit value
4. The other emission levels were very low against the limit.
5. " * " : Fundamental frequency, the limit was restricted at the RF Output Power.

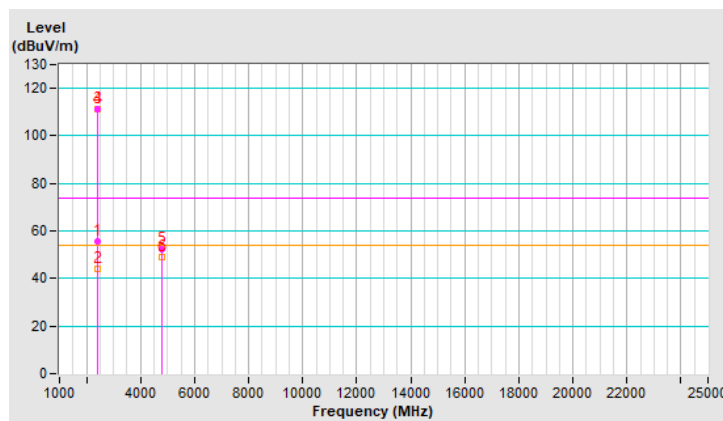

RF Mode	TX BT GFSK	Channel	CH 0 : 2402 MHz
Frequency Range	1 GHz ~ 25 GHz	Detector Function & Bandwidth	(PK) RB = 1 MHz, VB = 3 MHz (AV) RB = 1 MHz, VB = 510 Hz
Input Power (System)	120 Vac, 60 Hz	Environmental Conditions	25°C, 66% RH
Tested By	Tom Yang		

Antenna Polarity & Test Distance : Vertical at 3 m								
No	Frequency (MHz)	Emission Level (dBuV/m)	Limit (dBuV/m)	Margin (dB)	Antenna Height (m)	Table Angle (Degree)	Raw Value (dBuV)	Correction Factor (dB/m)
1	2390.00	52.9 PK	74.0	-21.1	1.48 V	304	57.4	-4.5
2	2390.00	42.4 AV	54.0	-11.6	1.48 V	304	46.9	-4.5
3	*2402.00	104.4 PK			1.48 V	304	108.9	-4.5
4	*2402.00	103.8 AV			1.48 V	304	108.3	-4.5
5	4804.00	49.9 PK	74.0	-24.1	3.11 V	303	50.1	-0.2
6	4804.00	40.3 AV	54.0	-13.7	3.11 V	303	40.5	-0.2

Remarks:

1. Emission Level(dBuV/m) = Raw Value(dBuV) + Correction Factor(dB/m)
2. Correction Factor(dB/m) = Antenna Factor(dB/m) + Cable Factor(dB) – Pre-Amplifier Factor(dB)
3. Margin value = Emission Level – Limit value
4. The other emission levels were very low against the limit.
5. " * " : Fundamental frequency, the limit was restricted at the RF Output Power.

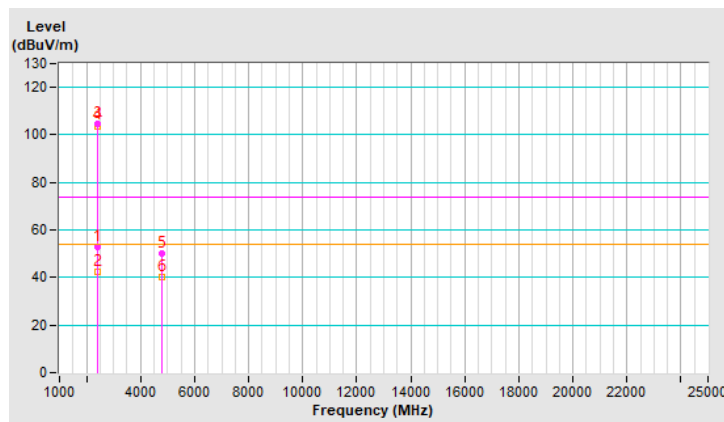

RF Mode	TX BT GFSK	Channel	CH 39 : 2441 MHz
Frequency Range	1 GHz ~ 25 GHz	Detector Function & Bandwidth	(PK) RB = 1 MHz, VB = 3 MHz (AV) RB = 1 MHz, VB = 510 Hz
Input Power (System)	120 Vac, 60 Hz	Environmental Conditions	25°C, 66% RH
Tested By	Tom Yang		

Antenna Polarity & Test Distance : Horizontal at 3 m								
No	Frequency (MHz)	Emission Level (dBuV/m)	Limit (dBuV/m)	Margin (dB)	Antenna Height (m)	Table Angle (Degree)	Raw Value (dBuV)	Correction Factor (dB/m)
1	*2441.00	112.5 PK			1.77 H	30	117.0	-4.5
2	*2441.00	112.0 AV			1.77 H	30	116.5	-4.5
3	4882.00	51.7 PK	74.0	-22.3	1.85 H	30	51.9	-0.2
4	4882.00	48.9 AV	54.0	-5.1	1.85 H	30	49.1	-0.2
5	7323.00	45.8 PK	74.0	-28.2	1.95 H	314	39.6	6.2
6	7323.00	35.0 AV	54.0	-19.0	1.95 H	314	28.8	6.2

Remarks:

1. Emission Level(dBuV/m) = Raw Value(dBuV) + Correction Factor(dB/m)
2. Correction Factor(dB/m) = Antenna Factor(dB/m) + Cable Factor(dB) – Pre-Amplifier Factor(dB)
3. Margin value = Emission Level – Limit value
4. The other emission levels were very low against the limit.
5. " * " : Fundamental frequency, the limit was restricted at the RF Output Power.

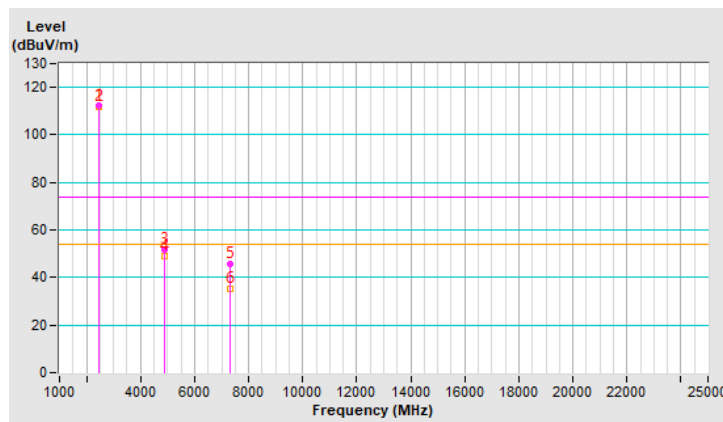

RF Mode	TX BT GFSK	Channel	CH 39 : 2441 MHz
Frequency Range	1 GHz ~ 25 GHz	Detector Function & Bandwidth	(PK) RB = 1 MHz, VB = 3 MHz (AV) RB = 1 MHz, VB = 510 Hz
Input Power (System)	120 Vac, 60 Hz	Environmental Conditions	25°C, 66% RH
Tested By	Tom Yang		

Antenna Polarity & Test Distance : Vertical at 3 m								
No	Frequency (MHz)	Emission Level (dBuV/m)	Limit (dBuV/m)	Margin (dB)	Antenna Height (m)	Table Angle (Degree)	Raw Value (dBuV)	Correction Factor (dB/m)
1	*2441.00	107.6 PK			1.02 V	59	112.1	-4.5
2	*2441.00	107.0 AV			1.02 V	59	111.5	-4.5
3	4882.00	50.4 PK	74.0	-23.6	3.02 V	308	50.6	-0.2
4	4882.00	40.7 AV	54.0	-13.3	3.02 V	308	40.9	-0.2
5	7323.00	45.4 PK	74.0	-28.6	2.32 V	42	39.2	6.2
6	7323.00	33.5 AV	54.0	-20.5	2.32 V	42	27.3	6.2

Remarks:

1. Emission Level(dBuV/m) = Raw Value(dBuV) + Correction Factor(dB/m)
2. Correction Factor(dB/m) = Antenna Factor(dB/m) + Cable Factor(dB) – Pre-Amplifier Factor(dB)
3. Margin value = Emission Level – Limit value
4. The other emission levels were very low against the limit.
5. " * " : Fundamental frequency, the limit was restricted at the RF Output Power.

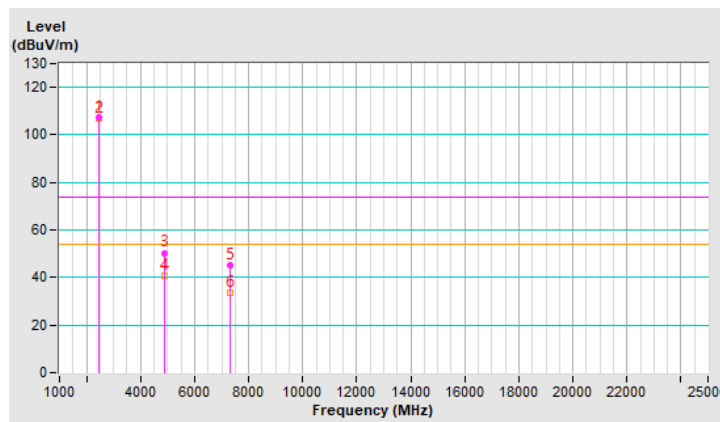

RF Mode	TX BT GFSK	Channel	CH 78 : 2480 MHz
Frequency Range	1 GHz ~ 25 GHz	Detector Function & Bandwidth	(PK) RB = 1 MHz, VB = 3 MHz (AV) RB = 1 MHz, VB = 510 Hz
Input Power (System)	120 Vac, 60 Hz	Environmental Conditions	25°C, 66% RH
Tested By	Tom Yang		

Antenna Polarity & Test Distance : Horizontal at 3 m								
No	Frequency (MHz)	Emission Level (dBuV/m)	Limit (dBuV/m)	Margin (dB)	Antenna Height (m)	Table Angle (Degree)	Raw Value (dBuV)	Correction Factor (dB/m)
1	*2480.00	110.5 PK			1.14 H	151	115.0	-4.5
2	*2480.00	110.0 AV			1.14 H	151	114.5	-4.5
3	2483.50	55.6 PK	74.0	-18.4	1.14 H	151	60.1	-4.5
4	2483.50	44.7 AV	54.0	-9.3	1.14 H	151	49.2	-4.5
5	4960.00	51.6 PK	74.0	-22.4	1.86 H	20	51.4	0.2
6	4960.00	48.9 AV	54.0	-5.1	1.86 H	20	48.7	0.2
7	7440.00	46.0 PK	74.0	-28.0	1.91 H	328	39.3	6.7
8	7440.00	35.2 AV	54.0	-18.8	1.91 H	328	28.5	6.7

Remarks:

1. Emission Level(dBuV/m) = Raw Value(dBuV) + Correction Factor(dB/m)
2. Correction Factor(dB/m) = Antenna Factor(dB/m) + Cable Factor(dB) – Pre-Amplifier Factor(dB)
3. Margin value = Emission Level – Limit value
4. The other emission levels were very low against the limit.
5. " * " : Fundamental frequency, the limit was restricted at the RF Output Power.

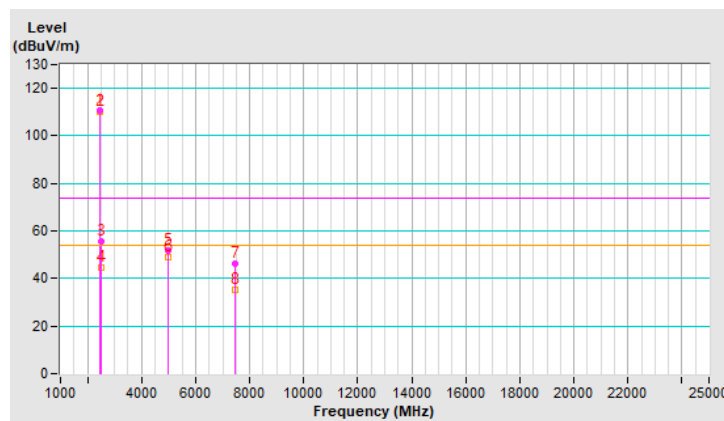

RF Mode	TX BT GFSK	Channel	CH 78 : 2480 MHz
Frequency Range	1 GHz ~ 25 GHz	Detector Function & Bandwidth	(PK) RB = 1 MHz, VB = 3 MHz (AV) RB = 1 MHz, VB = 510 Hz
Input Power (System)	120 Vac, 60 Hz	Environmental Conditions	25°C, 66% RH
Tested By	Tom Yang		

Antenna Polarity & Test Distance : Vertical at 3 m								
No	Frequency (MHz)	Emission Level (dBuV/m)	Limit (dBuV/m)	Margin (dB)	Antenna Height (m)	Table Angle (Degree)	Raw Value (dBuV)	Correction Factor (dB/m)
1	*2480.00	105.8 PK			1.17 V	84	110.3	-4.5
2	*2480.00	105.0 AV			1.17 V	84	109.5	-4.5
3	2483.50	54.4 PK	74.0	-19.6	1.17 V	84	58.9	-4.5
4	2483.50	43.2 AV	54.0	-10.8	1.17 V	84	47.7	-4.5
5	4960.00	50.1 PK	74.0	-23.9	3.06 V	310	49.9	0.2
6	4960.00	40.3 AV	54.0	-13.7	3.06 V	310	40.1	0.2
7	7440.00	45.2 PK	74.0	-28.8	2.36 V	55	38.5	6.7
8	7440.00	33.6 AV	54.0	-20.4	2.36 V	55	26.9	6.7

Remarks:

1. Emission Level(dBuV/m) = Raw Value(dBuV) + Correction Factor(dB/m)
2. Correction Factor(dB/m) = Antenna Factor(dB/m) + Cable Factor(dB) – Pre-Amplifier Factor(dB)
3. Margin value = Emission Level – Limit value
4. The other emission levels were very low against the limit.
5. " * ": Fundamental frequency, the limit was restricted at the RF Output Power.

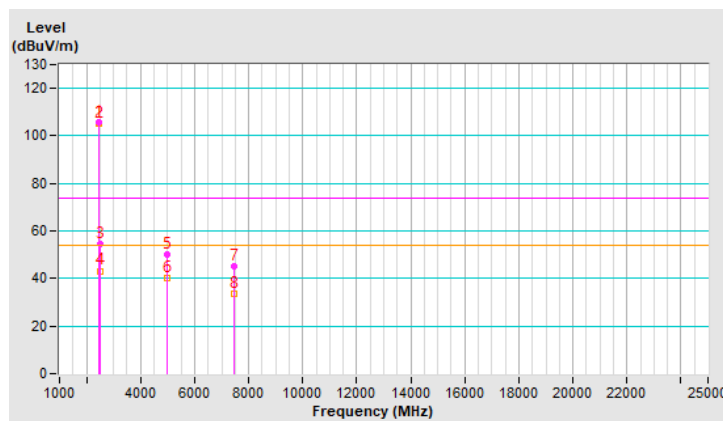

RF Mode	TX BT 8DPSK	Channel	CH 0 : 2402 MHz
Frequency Range	1 GHz ~ 25 GHz	Detector Function & Bandwidth	(PK) RB = 1 MHz, VB = 3 MHz (AV) RB = 1 MHz, VB = 510 Hz
Input Power (System)	120 Vac, 60 Hz	Environmental Conditions	25°C, 66% RH
Tested By	Tom Yang		

Antenna Polarity & Test Distance : Horizontal at 3 m								
No	Frequency (MHz)	Emission Level (dBuV/m)	Limit (dBuV/m)	Margin (dB)	Antenna Height (m)	Table Angle (Degree)	Raw Value (dBuV)	Correction Factor (dB/m)
1	2390.00	55.5 PK	74.0	-18.5	1.80 H	158	60.0	-4.5
2	2390.00	42.6 AV	54.0	-11.4	1.80 H	158	47.1	-4.5
3	*2402.00	109.5 PK			1.80 H	158	114.0	-4.5
4	*2402.00	105.8 AV			1.80 H	158	110.3	-4.5
5	4804.00	48.8 PK	74.0	-25.2	2.09 H	24	49.0	-0.2
6	4804.00	41.9 AV	54.0	-12.1	2.09 H	24	42.1	-0.2

Remarks:

1. Emission Level(dBuV/m) = Raw Value(dBuV) + Correction Factor(dB/m)
2. Correction Factor(dB/m) = Antenna Factor(dB/m) + Cable Factor(dB) – Pre-Amplifier Factor(dB)
3. Margin value = Emission Level – Limit value
4. The other emission levels were very low against the limit.
5. " * " : Fundamental frequency, the limit was restricted at the RF Output Power.

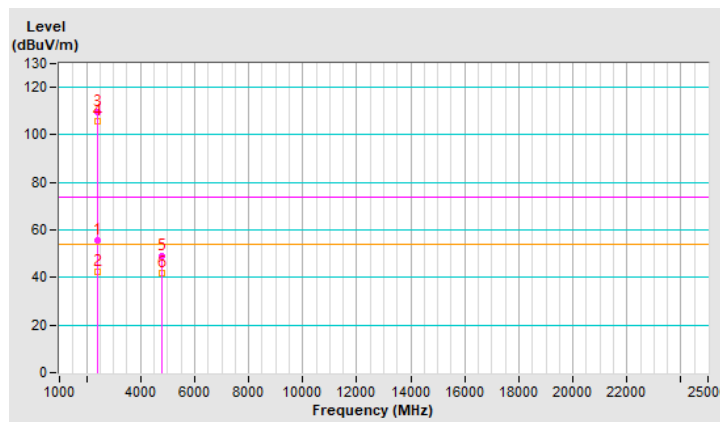

RF Mode	TX BT 8DPSK	Channel	CH 0 : 2402 MHz
Frequency Range	1 GHz ~ 25 GHz	Detector Function & Bandwidth	(PK) RB = 1 MHz, VB = 3 MHz (AV) RB = 1 MHz, VB = 510 Hz
Input Power (System)	120 Vac, 60 Hz	Environmental Conditions	25°C, 66% RH
Tested By	Tom Yang		

Antenna Polarity & Test Distance : Vertical at 3 m								
No	Frequency (MHz)	Emission Level (dBuV/m)	Limit (dBuV/m)	Margin (dB)	Antenna Height (m)	Table Angle (Degree)	Raw Value (dBuV)	Correction Factor (dB/m)
1	2390.00	53.7 PK	74.0	-20.3	1.54 V	303	58.2	-4.5
2	2390.00	42.4 AV	54.0	-11.6	1.54 V	303	46.9	-4.5
3	*2402.00	102.1 PK			1.54 V	303	106.6	-4.5
4	*2402.00	98.4 AV			1.54 V	303	102.9	-4.5
5	4804.00	48.5 PK	74.0	-25.5	3.35 V	304	48.7	-0.2
6	4804.00	42.5 AV	54.0	-11.5	3.35 V	304	42.7	-0.2

Remarks:

1. Emission Level(dBuV/m) = Raw Value(dBuV) + Correction Factor(dB/m)
2. Correction Factor(dB/m) = Antenna Factor(dB/m) + Cable Factor(dB) – Pre-Amplifier Factor(dB)
3. Margin value = Emission Level – Limit value
4. The other emission levels were very low against the limit.
5. " * " : Fundamental frequency, the limit was restricted at the RF Output Power.

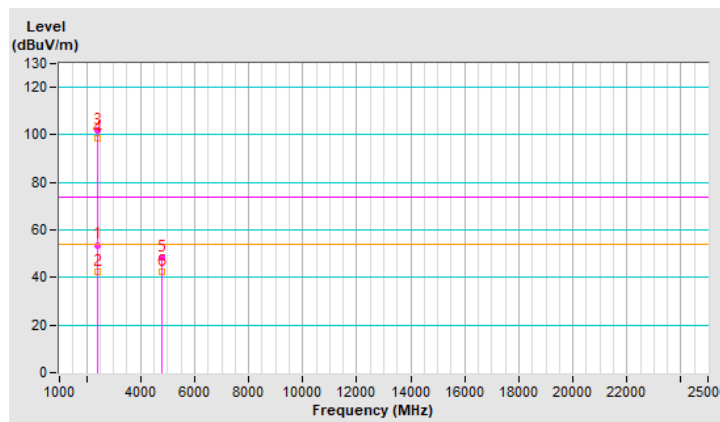

RF Mode	TX BT 8DPSK	Channel	CH 39 : 2441 MHz
Frequency Range	1 GHz ~ 25 GHz	Detector Function & Bandwidth	(PK) RB = 1 MHz, VB = 3 MHz (AV) RB = 1 MHz, VB = 510 Hz
Input Power (System)	120 Vac, 60 Hz	Environmental Conditions	25°C, 66% RH
Tested By	Tom Yang		

Antenna Polarity & Test Distance : Horizontal at 3 m								
No	Frequency (MHz)	Emission Level (dBuV/m)	Limit (dBuV/m)	Margin (dB)	Antenna Height (m)	Table Angle (Degree)	Raw Value (dBuV)	Correction Factor (dB/m)
1	*2441.00	110.9 PK			1.79 H	30	115.4	-4.5
2	*2441.00	106.9 AV			1.79 H	30	111.4	-4.5
3	4882.00	48.4 PK	74.0	-25.6	2.10 H	10	48.6	-0.2
4	4882.00	41.7 AV	54.0	-12.3	2.10 H	10	41.9	-0.2
5	7323.00	45.1 PK	74.0	-28.9	2.10 H	322	38.9	6.2
6	7323.00	33.0 AV	54.0	-21.0	2.10 H	322	26.8	6.2

Remarks:

1. Emission Level(dBuV/m) = Raw Value(dBuV) + Correction Factor(dB/m)
2. Correction Factor(dB/m) = Antenna Factor(dB/m) + Cable Factor(dB) – Pre-Amplifier Factor(dB)
3. Margin value = Emission Level – Limit value
4. The other emission levels were very low against the limit.
5. " * " : Fundamental frequency, the limit was restricted at the RF Output Power.

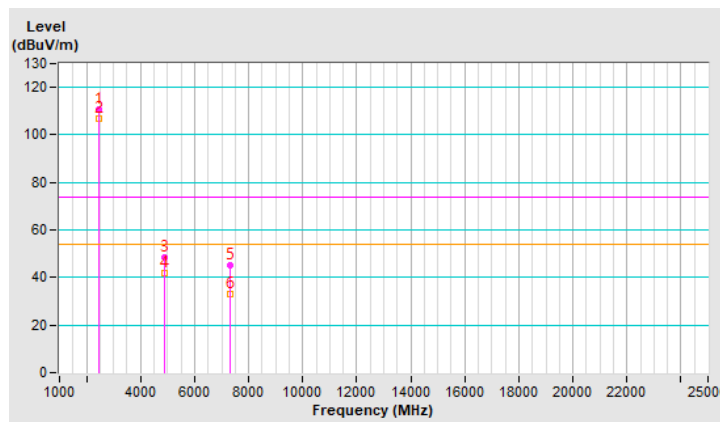

RF Mode	TX BT 8DPSK	Channel	CH 39 : 2441 MHz
Frequency Range	1 GHz ~ 25 GHz	Detector Function & Bandwidth	(PK) RB = 1 MHz, VB = 3 MHz (AV) RB = 1 MHz, VB = 510 Hz
Input Power (System)	120 Vac, 60 Hz	Environmental Conditions	25°C, 66% RH
Tested By	Tom Yang		

Antenna Polarity & Test Distance : Vertical at 3 m								
No	Frequency (MHz)	Emission Level (dBuV/m)	Limit (dBuV/m)	Margin (dB)	Antenna Height (m)	Table Angle (Degree)	Raw Value (dBuV)	Correction Factor (dB/m)
1	*2441.00	104.1 PK			1.15 V	78	108.6	-4.5
2	*2441.00	99.9 AV			1.15 V	78	104.4	-4.5
3	4882.00	48.7 PK	74.0	-25.3	3.23 V	310	48.9	-0.2
4	4882.00	42.6 AV	54.0	-11.4	3.23 V	310	42.8	-0.2
5	7323.00	45.3 PK	74.0	-28.7	2.11 V	42	39.1	6.2
6	7323.00	32.7 AV	54.0	-21.3	2.11 V	42	26.5	6.2

Remarks:

1. Emission Level(dBuV/m) = Raw Value(dBuV) + Correction Factor(dB/m)
2. Correction Factor(dB/m) = Antenna Factor(dB/m) + Cable Factor(dB) – Pre-Amplifier Factor(dB)
3. Margin value = Emission Level – Limit value
4. The other emission levels were very low against the limit.
5. " * " : Fundamental frequency, the limit was restricted at the RF Output Power.

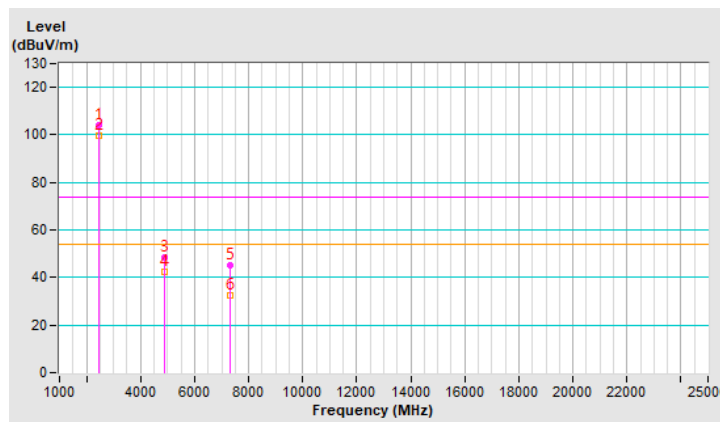

RF Mode	TX BT 8DPSK	Channel	CH 78 : 2480 MHz
Frequency Range	1 GHz ~ 25 GHz	Detector Function & Bandwidth	(PK) RB = 1 MHz, VB = 3 MHz (AV) RB = 1 MHz, VB = 510 Hz
Input Power (System)	120 Vac, 60 Hz	Environmental Conditions	25°C, 66% RH
Tested By	Tom Yang		

Antenna Polarity & Test Distance : Horizontal at 3 m								
No	Frequency (MHz)	Emission Level (dBuV/m)	Limit (dBuV/m)	Margin (dB)	Antenna Height (m)	Table Angle (Degree)	Raw Value (dBuV)	Correction Factor (dB/m)
1	*2480.00	109.5 PK			1.09 H	161	114.0	-4.5
2	*2480.00	105.7 AV			1.09 H	161	110.2	-4.5
3	2483.50	55.2 PK	74.0	-18.8	1.09 H	161	59.7	-4.5
4	2483.50	44.3 AV	54.0	-9.7	1.09 H	161	48.8	-4.5
5	4960.00	48.2 PK	74.0	-25.8	2.05 H	11	48.0	0.2
6	4960.00	41.6 AV	54.0	-12.4	2.05 H	11	41.4	0.2
7	7440.00	44.8 PK	74.0	-29.2	2.07 H	306	38.1	6.7
8	7440.00	32.7 AV	54.0	-21.3	2.07 H	306	26.0	6.7

Remarks:

1. Emission Level(dBuV/m) = Raw Value(dBuV) + Correction Factor(dB/m)
2. Correction Factor(dB/m) = Antenna Factor(dB/m) + Cable Factor(dB) – Pre-Amplifier Factor(dB)
3. Margin value = Emission Level – Limit value
4. The other emission levels were very low against the limit.
5. " * " : Fundamental frequency, the limit was restricted at the RF Output Power.

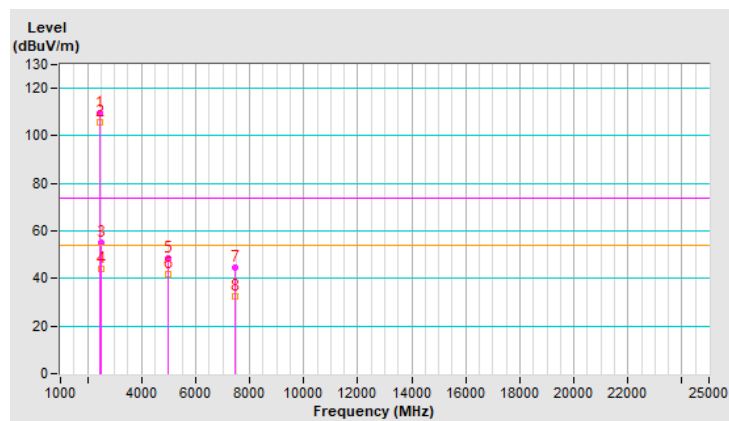

RF Mode	TX BT 8DPSK	Channel	CH 78 : 2480 MHz
Frequency Range	1 GHz ~ 25 GHz	Detector Function & Bandwidth	(PK) RB = 1 MHz, VB = 3 MHz (AV) RB = 1 MHz, VB = 510 Hz
Input Power (System)	120 Vac, 60 Hz	Environmental Conditions	25°C, 66% RH
Tested By	Tom Yang		

Antenna Polarity & Test Distance : Vertical at 3 m								
No	Frequency (MHz)	Emission Level (dBuV/m)	Limit (dBuV/m)	Margin (dB)	Antenna Height (m)	Table Angle (Degree)	Raw Value (dBuV)	Correction Factor (dB/m)
1	*2480.00	103.8 PK			1.20 V	83	108.3	-4.5
2	*2480.00	99.8 AV			1.20 V	83	104.3	-4.5
3	2483.50	54.1 PK	74.0	-19.9	1.20 V	83	58.6	-4.5
4	2483.50	42.6 AV	54.0	-11.4	1.20 V	83	47.1	-4.5
5	4960.00	48.4 PK	74.0	-25.6	3.12 V	316	48.2	0.2
6	4960.00	42.5 AV	54.0	-11.5	3.12 V	316	42.3	0.2
7	7440.00	45.6 PK	74.0	-28.4	2.06 V	46	38.9	6.7
8	7440.00	33.1 AV	54.0	-20.9	2.06 V	46	26.4	6.7

Remarks:

1. Emission Level(dBuV/m) = Raw Value(dBuV) + Correction Factor(dB/m)
2. Correction Factor(dB/m) = Antenna Factor(dB/m) + Cable Factor(dB) – Pre-Amplifier Factor(dB)
3. Margin value = Emission Level – Limit value
4. The other emission levels were very low against the limit.
5. " * ": Fundamental frequency, the limit was restricted at the RF Output Power.

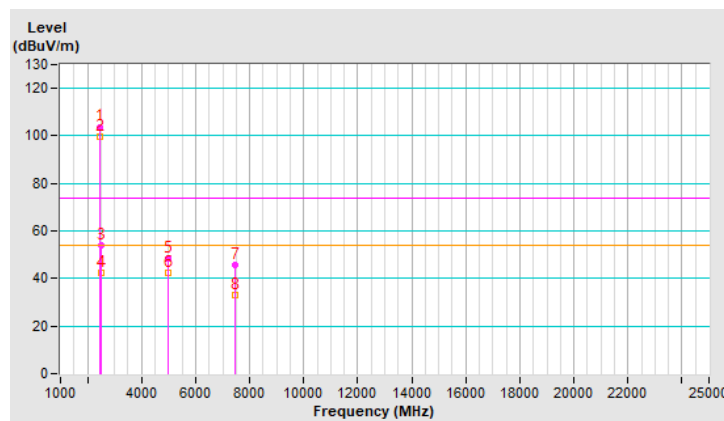

BT 8DPSK Channel 0

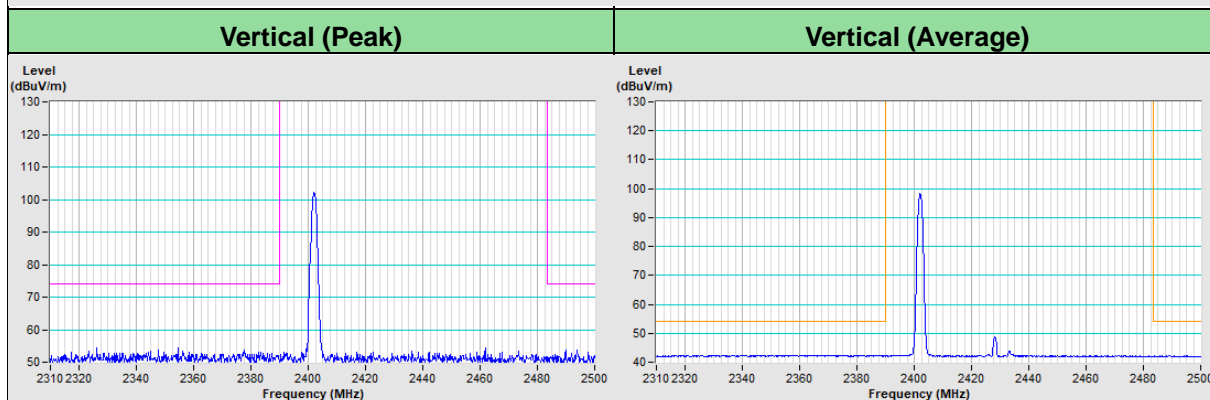
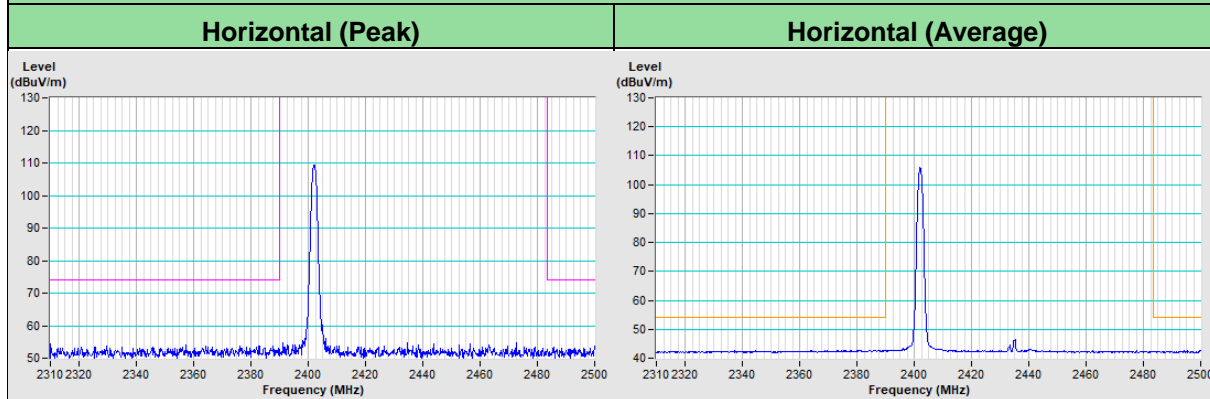

BT 8DPSK Channel 78

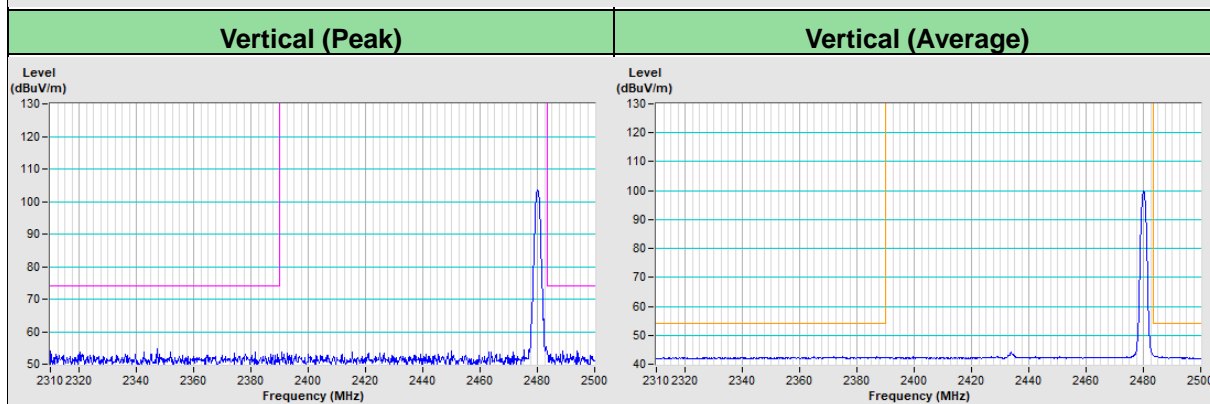
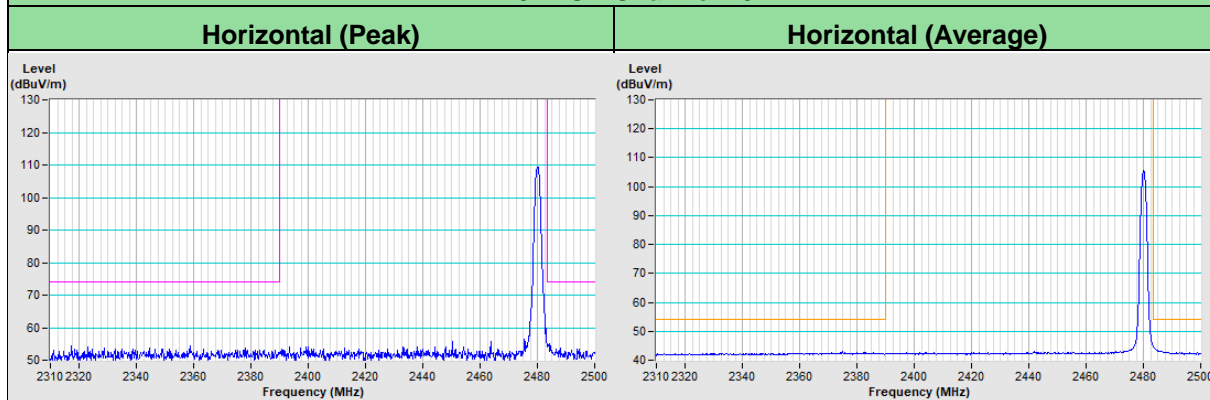

8 Pictures of Test Arrangements

Please refer to the attached file (Test Setup Photo)

9 Information of the Testing Laboratories

We, Bureau Veritas Consumer Products Services (H.K.) Ltd., Taoyuan Branch, were founded in 1988 to provide our best service in EMC, Radio, Telecom and Safety consultation. Our laboratories are FCC recognized accredited test firms and accredited according to ISO/IEC 17025.

If you have any comments, please feel free to contact us at the following:

Lin Kou EMC/RF Lab

Tel: 886-2-26052180

Fax: 886-2-26051924

Hsin Chu EMC/RF/Telecom Lab

Tel: 886-3-6668565

Fax: 886-3-6668323

Hwa Ya EMC/RF/Safety Lab

Tel: 886-3-3183232

Fax: 886-3-3270892

Email: service.adt@bureauveritas.com

Web Site: <http://ee.bureauveritas.com.tw>

The address and road map of all our labs can be found in our web site also.

--- END ---