



# RADIO TEST REPORT

**FCC ID** : TLZ-CB511  
**Equipment** : IEEE 802.11 a/b/g/n/ac WLAN 2T2R with Bluetooth 5.0 Combo Module  
**Brand Name** : AzureWave  
**Model Name** : AW-CB511NF-BPF  
**Applicant** : AzureWave Technologies, Inc.  
8F., No.94, Baozhong Rd. , Xindian Dist., New Taipei City , Taiwan 231  
**Manufacturer** : AzureWave Technologies, Inc.  
8F., No.94, Baozhong Rd. , Xindian Dist., New Taipei City , Taiwan 231  
**Standard** : 47 CFR FCC Part 15.247

The product was received on Sep. 03, 2021, and testing was started from Sep. 04, 2021 and completed on Dec. 06, 2021. We, Sporton International Inc. Hsinchu Laboratory, would like to declare that the tested sample has been evaluated in accordance with the procedures given in ANSI C63.10-2013 and shown compliance with the applicable technical standards.

The test results in this report apply exclusively to the tested model / sample. Without written approval of Sporton International Inc. Hsinchu Laboratory, the test report shall not be reproduced except in full.

Approved by: Sam Chen

**Sporton International Inc. Hsinchu Laboratory**

No.8, Ln. 724, Bo'ai St., Zhubei City, Hsinchu County 302010, Taiwan (R.O.C.)



## Table of Contents

**History of this test report.....3**

**Summary of Test Result.....4**

**1 General Description .....5**

1.1 Information.....5

1.2 Applicable Standards .....9

1.3 Testing Location Information .....9

1.4 Measurement Uncertainty .....10

**2 Test Configuration of EUT .....11**

2.1 Test Channel Mode .....11

2.2 The Worst Case Measurement Configuration .....12

2.3 EUT Operation during Test .....14

2.4 Accessories .....14

2.5 Support Equipment.....14

2.6 Test Setup Diagram .....15

**3 Transmitter Test Result .....18**

3.1 AC Power-line Conducted Emissions .....18

3.2 DTS Bandwidth .....20

3.3 Maximum Conducted Output Power .....21

3.4 Power Spectral Density .....24

3.5 Emissions in Non-restricted Frequency Bands .....26

3.6 Emissions in Restricted Frequency Bands.....27

**4 Test Equipment and Calibration Data .....31**

**Appendix A. Test Results of AC Power-line Conducted Emissions**

**Appendix B. Test Results of DTS Bandwidth**

**Appendix C. Test Results of Maximum Conducted Output Power**

**Appendix D. Test Results of Power Spectral Density**

**Appendix E. Test Results of Emissions in Non-restricted Frequency Bands**

**Appendix F. Test Results of Emissions in Restricted Frequency Bands**

**Appendix G. Test Results of Radiated Emission Co-location**

**Appendix H. Test Photos**

**Photographs of EUT v02**



### History of this test report

<b>Report No.</b>	<b>Version</b>	<b>Description</b>	<b>Issued Date</b>
FR170220AD	01	Initial issue of report	Mar. 28, 2022
FR170220AD	02	Changing the model name to "AW-CB511NF-BPF" from "AW-CB511NF-BPF, AW-CB511NF, AW-CB511MA".	Apr. 12, 2022



### Summary of Test Result

Report Clause	Ref Std. Clause	Test Items	Result (PASS/FAIL)	Remark
1.1.2	15.203	Antenna Requirement	PASS	-
3.1	15.207	AC Power-line Conducted Emissions	PASS	-
3.2	15.247(a)	DTS Bandwidth	PASS	-
3.3	15.247(b)	Maximum Conducted Output Power	PASS	-
3.4	15.247(e)	Power Spectral Density	PASS	-
3.5	15.247(d)	Emissions in Non-restricted Frequency Bands	PASS	-
3.6	15.247(d)	Emissions in Restricted Frequency Bands	PASS	-

**Declaration of Conformity:**

1. The test results with all measurement uncertainty excluded are presented in accordance with the regulation limits or requirements declared by manufacturers. It's means measurement values may risk exceeding the limit of regulation standards, if measurement uncertainty is include in test results.
2. The measurement uncertainty please refer to report "Measurement Uncertainty".

**Comments and Explanations:**

The declared of product specification for EUT presented in the report are provided by the manufacturer, and the manufacturer takes all the responsibilities for the accuracy of product specification.

**Reviewed by: Sam Chen**

**Report Producer: Sandy Chuang**



# 1 General Description

## 1.1 Information

### 1.1.1 RF General Information

Frequency Range (MHz)	Bluetooth Mode	Ch. Frequency (MHz)	Channel Number
2400-2483.5	LE	2402-2480	0-39 [40]

Band	Mode	BWch (MHz)	Nant
2.4-2.4835GHz	BT-LE(1Mbps)	1.0	1TX
2.4-2.4835GHz	BT-LE(500Kb/s)	1.0	1TX
2.4-2.4835GHz	BT-LE(125Kb/s)	1.0	1TX
2.4-2.4835GHz	BT-LE(2Mbps)	2.0	1TX

**Note:**

- ♦ Bluetooth LE uses a GFSK modulation.
- ♦ BWch is the nominal channel bandwidth.



**1.1.2 Antenna Information**

Ant.	Port	Brand	Model Name	Antenna Type	Connector	Antenna Gain(dBi)		
						WLAN 2.4GHz	WLAN 5GHz	Bluetooth
1	1	NVIDIA	320-1929-000	PIFA	I-PEX MHF4-L	4.3	5.4	4.3
2	2	NVIDIA	320-1929-000	PIFA	I-PEX MHF4-L	4.3	5.4	-

Note 1: The above information was declared by manufacturer.

**<WLAN 2.4GHz Function>**

For IEEE 802.11b/g/n/VHT mode (1TX/2RX):

The EUT supports 1TX/2RX function, and it supports TX diversity function.

Both Port 1 and Port 2 could be used as transmitting antenna, but only one of them will be used at one time. Port 1 and Port 2 could receive simultaneously.

Both Port 1 and Port 2 are selected to test.

For IEEE 802.11b/g/n/VHT mode (2TX/2RX):

Port 1 and Port 2 can be used as transmitting/receiving antenna.

Port 1 and Port 2 could transmit/receive simultaneously.

**<WLAN 5GHz Function>**

For IEEE 802.11a/n/ac mode (1TX/2RX):

The EUT supports 1TX/2RX function, and it supports TX diversity function.

Both Port 1 and Port 2 could be used as transmitting antenna, but only one of them will be used at one time. Port 1 and Port 2 could receive simultaneously.

Both Port 1 and Port 2 are selected to test.

For IEEE 802.11a/n/ac mode (2TX/2RX):

Port 1 and Port 2 can be used as transmitting/receiving antenna.

Port 1 and Port 2 could transmit/receive simultaneously.

**<Bluetooth Function> (1TX/1RX)**

Only Port 1 can be used as transmitting/receiving.



Note 2: Directional gain information

Type	Maximum Output Power	Power Spectral Density
Non-BF	Directional gain = Max. gain + array gain. For power measurements on IEEE 802.11 devices Array Gain = 0 dB (i.e., no array gain) for N ANT ≤ 4	$DirectionalGain = 10 \cdot \log \left[ \frac{\sum_{j=1}^{N_{ANT}} \left( \sum_{k=1}^{N_{ANT}} \xi_{j,k} \right)^2}{N_{ANT}} \right]$
BF	$DirectionalGain = 10 \cdot \log \left[ \frac{\sum_{j=1}^{N_{ANT}} \left( \sum_{k=1}^{N_{ANT}} \xi_{j,k} \right)^2}{N_{ANT}} \right]$	$DirectionalGain = 10 \cdot \log \left[ \frac{\sum_{j=1}^{N_{ANT}} \left( \sum_{k=1}^{N_{ANT}} \xi_{j,k} \right)^2}{N_{ANT}} \right]$

Ex.

Directional Gain (NSS1) formula :

$$DirectionalGain = 10 \cdot \log \left[ \frac{\sum_{j=1}^{N_{ANT}} \left( \sum_{k=1}^{N_{ANT}} \xi_{j,k} \right)^2}{N_{ANT}} \right]$$

$$NSS1(g1,1) = 10^{G1/20} ; NSS1(g1,2) = 10^{G2/20}$$

$$g_{j,k} = (NSS1(g1,1) + NSS1(g1,2))^2$$

$$DG = 10 \log \left[ \frac{(NSS1(g1,1) + NSS1(g1,2))^2}{N_{ANT}} \right] \Rightarrow 10 \log \left[ \frac{(10^{G1/20} + 10^{G2/20})^2}{N_{ANT}} \right]$$

Where ;

G1 = Ant 1 Gain ; G2 = Ant 2 Gain

2.4GHz DG = 7.31 dBi

5 GHz U-NII-1 DG = 8.41 dBi

5 GHz U-NII-2A DG = 8.41 dBi

5 GHz U-NII-2C DG = 8.41 dBi

5 GHz U-NII-3 DG = 8.41 dBi



**1.1.3 Mode Test Duty Cycle**

Mode	DC	DCF(dB)	T(s)	VBW(Hz) ≥ 1/T
BT-LE(1Mbps)	0.628	2.02	392.5u	3k
BT-LE(2Mbps)	0.316	5	197.5u	10k

Note:

- ◆ DC is Duty Cycle.
- ◆ DCF is Duty Cycle Factor.

**1.1.4 EUT Operational Condition**

<b>EUT Power Type</b>	From host system			
<b>EUT Power</b>	3.3V			
<b>Function</b>	<input checked="" type="checkbox"/> Point-to-multipoint	<input type="checkbox"/> Point-to-point		
<b>Test Software Version</b>	Putty 0.62.0.0			
<b>Support Mode</b>	<input checked="" type="checkbox"/> LE 1M PHY: 1 Mb/s			
	<input checked="" type="checkbox"/> LE Coded PHY (S=2): 500 Kb/s			
	<input checked="" type="checkbox"/> LE Coded PHY (S=8): 125 Kb/s			
	<input checked="" type="checkbox"/> LE 2M PHY: 2 Mb/s			

Note: The above information was declared by manufacturer.

**1.1.5 Table for EUT Type**

EUT	Power IC Source	Brand Name	Model Name	Part No.	Location
1	Main	uPI	RE0108ADD6-18	XC6223H1819R-G	U11
2	Second	MicrOne	ME6211C18U4AG-N	RE0108ADD6-18WDFN-6L	

Note 1: EUT 1 has been evaluated as the worst EUT, so it was selected to test.

Note 2: The above information was declared by manufacturer.





### 1.2 Applicable Standards

According to the specifications of the manufacturer, the EUT must comply with the requirements of the following standards:

- ◆ 47 CFR FCC Part 15
- ◆ ANSI C63.10-2013

The following reference test guidance is not within the scope of accreditation of TAF.

- ◆ FCC KDB 558074 D01 v05r02
- ◆ FCC KDB 414788 D01 v01r01

### 1.3 Testing Location Information

Testing Location Information	
Test Lab. : Sporton International Inc. Hsinchu Laboratory	
Hsinchu	ADD: No.8, Ln. 724, Bo'ai St., Zhubei City, Hsinchu County 302010, Taiwan (R.O.C.)
(TAF: 3787)	TEL: 886-3-656-9065 FAX: 886-3-656-9085
	Test site Designation No. TW3787 with FCC.
	Conformity Assessment Body Identifier (CABID) TW3787 with ISED.

Test Condition	Test Site No.	Test Engineer	Test Environment (°C / %)	Test Date
RF Conducted	TH02-CB	Lucas Haung	24~25.3 / 54~55	Sep. 07, 2021~ Dec. 06, 2021
Radiated <Below 1GHz>	10CH01-CB	Peter Wu	23~24 / 56~57	Sep. 07, 2021
Radiated <Above 1GHz>	03CH01-CB	Ken Yeh	24.2-26.1 / 55-58	Sep. 04, 2021~ Dec. 03, 2021
Radiated <Co-location>	03CH04-CB	Ken Yeh	23.9-26.1 / 55-58	Sep. 04, 2021~ Dec. 03, 2021
AC Conduction	CO01-CB	Ryo Fan	23~24 / 56~57	Sep. 07, 2021



## 1.4 Measurement Uncertainty

ISO/IEC 17025 requires that an estimate of the measurement uncertainties associated with the emissions test results be included in the report. The measurement uncertainties given below are based on a 95% confidence level (based on a coverage factor (k=2))

Test Items	Uncertainty	Remark
Conducted Emission (150kHz ~ 30MHz)	2.0 dB	Confidence levels of 95%
Radiated Emission (9kHz ~ 30MHz)	1.6 dB	Confidence levels of 95%
Radiated Emission (30MHz ~ 1,000MHz)	4.2 dB	Confidence levels of 95%
Radiated Emission (1GHz ~ 18GHz)	4.7 dB	Confidence levels of 95%
Radiated Emission (18GHz ~ 40GHz)	4.2 dB	Confidence levels of 95%
Conducted Emission	2.5 dB	Confidence levels of 95%
Output Power Measurement	1.3 dB	Confidence levels of 95%
Power Density Measurement	2.5 dB	Confidence levels of 95%
Bandwidth Measurement	0.9%	Confidence levels of 95%



## **2 Test Configuration of EUT**

### **2.1 Test Channel Mode**

<b>Mode</b>
BT-LE(1Mbps)
2402MHz
2440MHz
2480MHz
BT-LE(2Mbps)
2402MHz
2440MHz
2480MHz



## 2.2 The Worst Case Measurement Configuration

The Worst Case Mode for Following Conformance Tests	
<b>Tests Item</b>	AC power-line conducted emissions
<b>Condition</b>	AC power-line conducted measurement for line and neutral Test Voltage: 120Vac / 60Hz
<b>Operating Mode</b>	Normal Link
1	EUT 1 in Z axis + WLAN 2.4GHz + Bluetooth
2	EUT 1 in Z axis + WLAN 5GHz + Bluetooth
For operating mode 2 is the worst case and it was record in this test report.	

The Worst Case Mode for Following Conformance Tests	
<b>Tests Item</b>	DTS Bandwidth Maximum Conducted Output Power Power Spectral Density Emissions in Non-restricted Frequency Bands
<b>Test Condition</b>	Conducted measurement at transmit chains
1	EUT 1



<b>The Worst Case Mode for Following Conformance Tests</b>	
<b>Tests Item</b>	Emissions in Restricted Frequency Bands
<b>Test Condition</b>	Radiated measurement If EUT consist of multiple antenna assembly (multiple antenna are used in EUT regardless of spatial multiplexing MIMO configuration), the radiated test should be performed with highest antenna gain of each antenna type.
<b>Operating Mode &lt; 1GHz</b>	Normal Link
1	EUT 1 in Z axis + WLAN 2.4GHz + Bluetooth
2	EUT 1 in Z axis + WLAN 5GHz + Bluetooth
Mode 2 has been evaluated to be the worst case among Mode 1~2, thus measurement for Mode 3 ~ 4 will follow this same test mode.	
3	EUT 1 in Y axis + WLAN 5GHz + Bluetooth
4	EUT 1 in X axis + WLAN 5GHz + Bluetooth
For operating mode 2 is the worst case and it was record in this test report.	
<b>Operating Mode &gt; 1GHz</b>	CTX
The EUT was performed at X axis, Y axis and Z axis position, and the worst case as below:	
1	EUT 1 in Y axis

<b>The Worst Case Mode for Following Conformance Tests</b>	
<b>Tests Item</b>	Simultaneous Transmission Analysis - Radiated Emission Co-location
<b>Test Condition</b>	Radiated measurement
<b>Operating Mode</b>	Normal Link
The EUT was performed at X axis, Y axis and Z axis position. EUT Z axis has been evaluated to be the worst case at Emissions in Restricted Frequency Bands <Above 1GHz>; thus, the measurement will follow this same test configuration.	
1	EUT 1 in Z axis + WLAN 2.4GHz + Bluetooth
2	EUT 1 in Z axis + WLAN 5GHz + Bluetooth
For operating mode 1 is the worst case and it was record in this test report.	
Refer to Appendix G for Radiated Emission Co-location.	

<b>The Worst Case Mode for Following Conformance Tests</b>	
<b>Tests Item</b>	Simultaneous Transmission Analysis - Co-location RF Exposure Evaluation
<b>Operating Mode</b>	
1	EUT 1 <2.4GHz + Bluetooth>
2	EUT 1 <5GHz + Bluetooth>
Refer to Sporton Test Report No.: FA170220 for Co-location RF Exposure Evaluation.	



### 2.3 EUT Operation during Test

For CTX Mode:

The EUT was programmed to be in continuously transmitting mode.

For Normal Link Mode:

During the test, the EUT operation to normal function.

### 2.4 Accessories

N/A

### 2.5 Support Equipment

**For AC Conduction and Radiated <below 1GHz>**

Support Equipment				
No.	Equipment	Brand Name	Model Name	FCC ID
A	NB	DELL	E6430	N/A
B	Earphone	SHYARO CHI	MIC-04	N/A
C	Mouse	HP	FM100	N/A
D	Fixture	AzureWare	2460 I2	N/A
E	2.4G / 5G AP	ASUS	RP-N53	MSQ-RPN53

**For Radiated <Above 1GHz> and RF Conducted**

Support Equipment				
No.	Equipment	Brand Name	Model Name	FCC ID
A	NB	DELL	E4300	N/A
B	Fixture	AzureWare	2460 I2	N/A

## 2.6 Test Setup Diagram

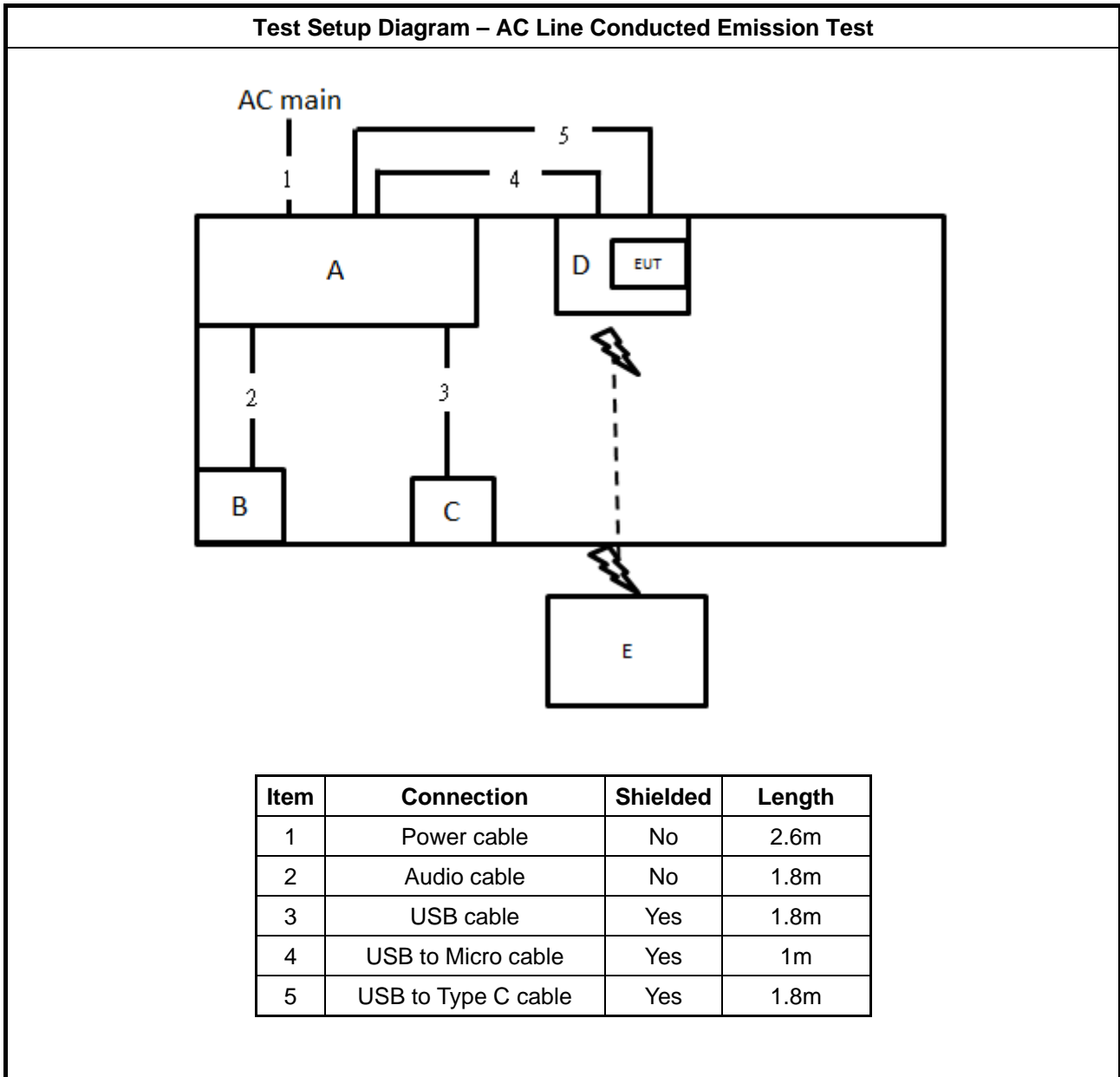

**Test Setup Diagram - Radiated Test < 1GHz**

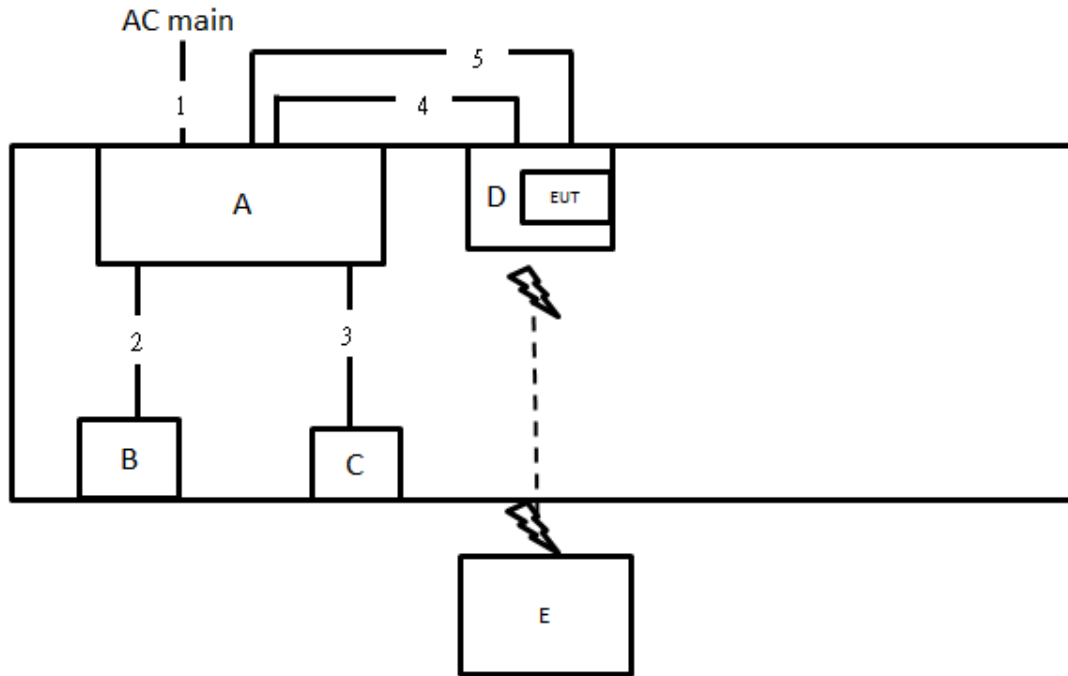

Item	Connection	Shielded	Length
1	Power cable	No	2.6m
2	Audio cable	No	1.8m
3	USB cable	Yes	1.8m
4	USB to Micro cable	Yes	1m
5	USB to Type C cable	Yes	1.8m



**Test Setup Diagram - Radiated Test > 1GHz**

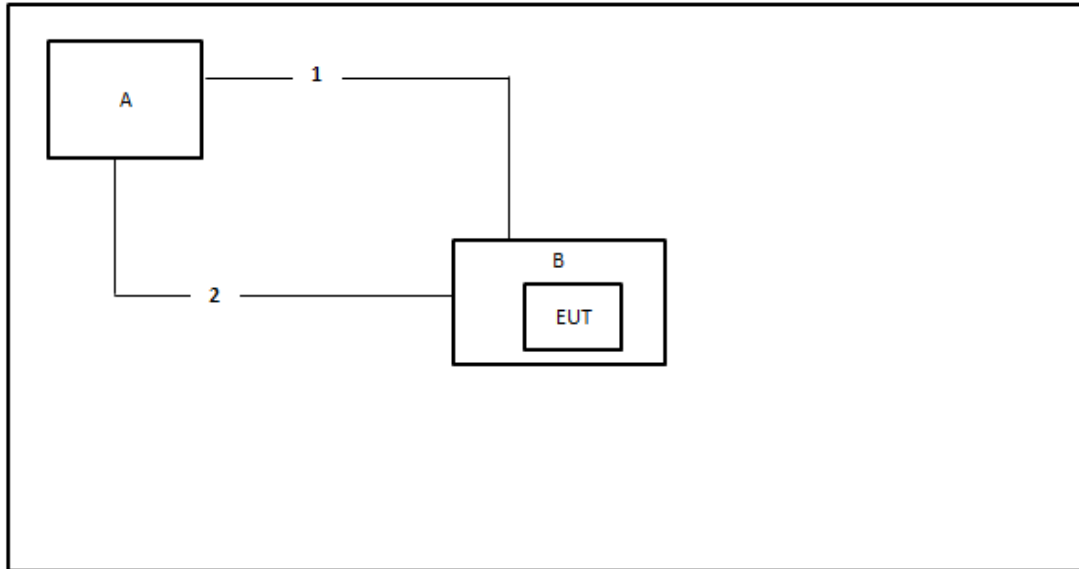

Item	Connection	Shielded	Length
1	USB to Type C cable	Yes	1m
2	USB to Micro cable	Yes	0.5m



### 3 Transmitter Test Result

#### 3.1 AC Power-line Conducted Emissions

##### 3.1.1 AC Power-line Conducted Emissions Limit

AC Power-line Conducted Emissions Limit		
Frequency Emission (MHz)	Quasi-Peak	Average
0.15-0.5	66 - 56 *	56 - 46 *
0.5-5	56	46
5-30	60	50

Note 1: \* Decreases with the logarithm of the frequency.

##### 3.1.2 Measuring Instruments

Refer a test equipment and calibration data table in this test report.

##### 3.1.3 Test Procedures

Test Method
▪ Refer as ANSI C63.10-2013, clause 6.2 for AC power-line conducted emissions.

### 3.1.4 Test Setup

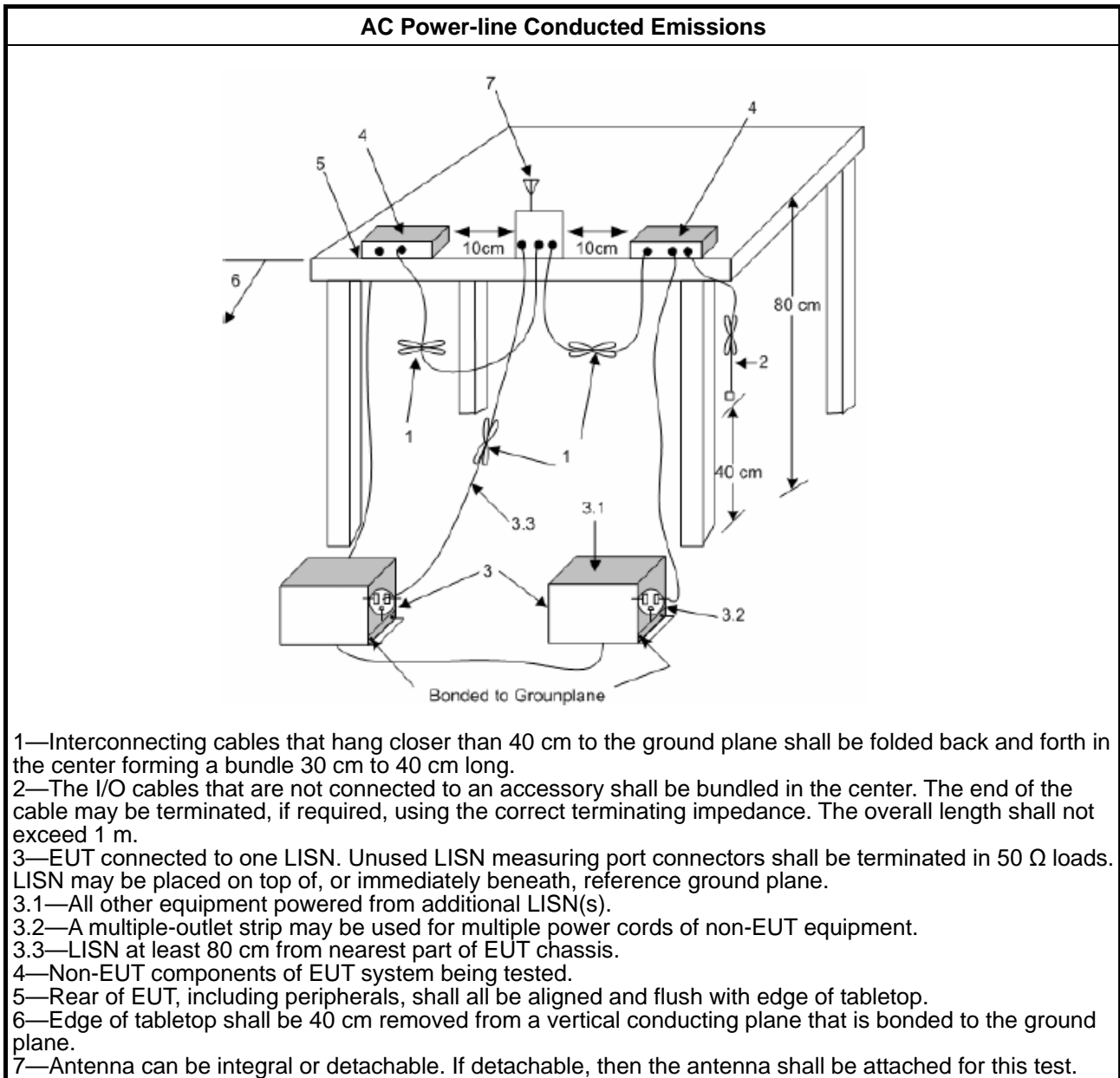

#### 1.1.1. Measurement Results Calculation

The measured Level is calculated using:

- a. Corrected Reading: LISN Factor (LISN) + Attenuator (AT/AUX) + Cable Loss (CL) + Read Level (Raw) = Level
- b. Margin = -Limit + Level

### 3.1.5 Test Result of AC Power-line Conducted Emissions

Refer as Appendix A

### 3.2 DTS Bandwidth

#### 3.2.1 6dB Bandwidth Limit

6dB Bandwidth Limit
<b>Systems using digital modulation techniques:</b>
<ul style="list-style-type: none"> <li>▪ 6 dB bandwidth <math>\geq</math> 500 kHz.</li> </ul>

#### 3.2.2 Measuring Instruments

Refer a test equipment and calibration data table in this test report.

#### 3.2.3 Test Procedures

Test Method
<ul style="list-style-type: none"> <li>▪ For the emission bandwidth shall be measured using one of the options below:</li> </ul>
<input checked="" type="checkbox"/> Refer as FCC KDB 558074, clause 8.2 & C63.10 clause 11.8.1 Option 1 for 6 dB bandwidth measurement.
<input type="checkbox"/> Refer as FCC KDB 558074, clause 8.2 & C63.10 clause 11.8.2 Option 2 for 6 dB bandwidth measurement.
<input type="checkbox"/> Refer as ANSI C63.10, clause 6.9.1 for occupied bandwidth testing.

#### 3.2.4 Test Setup

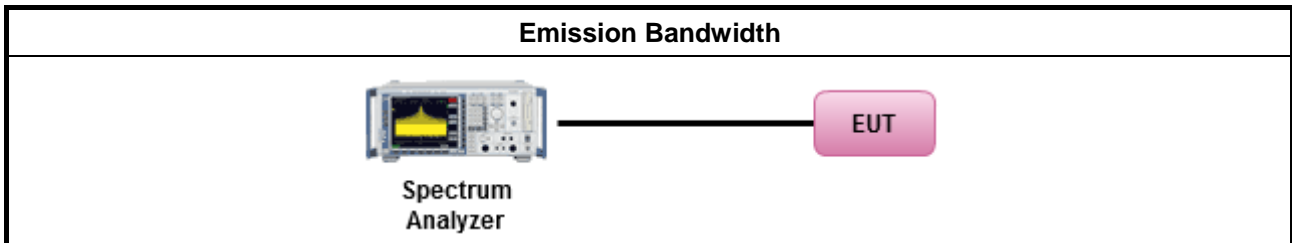

#### 3.2.5 Test Result of Emission Bandwidth

Refer as Appendix B



### 3.3 Maximum Conducted Output Power

#### 3.3.1 Maximum Conducted Output Power Limit

Maximum Conducted Output Power Limit	
	<ul style="list-style-type: none"><li>▪ If <math>G_{TX} \leq 6</math> dBi, then <math>P_{Out} \leq 30</math> dBm (1 W)</li></ul>
	<ul style="list-style-type: none"><li>▪ Point-to-multipoint systems (P2M): If <math>G_{TX} &gt; 6</math> dBi, then <math>P_{Out} = 30 - (G_{TX} - 6)</math> dBm</li></ul>
	<ul style="list-style-type: none"><li>▪ Point-to-point systems (P2P): If <math>G_{TX} &gt; 6</math> dBi, then <math>P_{Out} = 30 - (G_{TX} - 6)/3</math> dBm</li></ul>
	<ul style="list-style-type: none"><li>▪ Smart antenna system (SAS):</li></ul>
	<ul style="list-style-type: none"><li>- Single beam: If <math>G_{TX} &gt; 6</math> dBi, then <math>P_{Out} = 30 - (G_{TX} - 6)/3</math> dBm</li></ul>
	<ul style="list-style-type: none"><li>- Overlap beam: If <math>G_{TX} &gt; 6</math> dBi, then <math>P_{Out} = 30 - (G_{TX} - 6)/3</math> dBm</li></ul>
	<ul style="list-style-type: none"><li>- Aggregate power on all beams: If <math>G_{TX} &gt; 6</math> dBi, then <math>P_{Out} = 30 - (G_{TX} - 6)/3 + 8</math> dB dBm</li></ul>
$P_{Out}$ = maximum peak conducted output power or maximum conducted output power in dBm, $G_{TX}$ = the maximum transmitting antenna directional gain in dBi.	

#### 3.3.2 Measuring Instruments

Refer a test equipment and calibration data table in this test report.

**3.3.3 Test Procedures**

<b>Test Method</b>	
<ul style="list-style-type: none"> <li>▪ Maximum Peak Conducted Output Power</li> </ul>	
	<input type="checkbox"/> Refer as FCC KDB 558074, clause 8.3.1.1 & C63.10 clause 11.9.1.1 (RBW ≥ EBW method).
	<input type="checkbox"/> Refer as FCC KDB 558074, clause 8.3.1.3 & C63.10 clause 11.9.1.3 (peak power meter).
<ul style="list-style-type: none"> <li>▪ Maximum Conducted Output Power</li> </ul>	
[duty cycle ≥ 98% or external video / power trigger]	
	<input type="checkbox"/> Refer as FCC KDB 558074, clause 8.3.2.2 & C63.10 clause 11.9.2.2.2 Method AVGSA-1.
	<input type="checkbox"/> Refer as FCC KDB 558074, clause 8.3.2.2 & C63.10 clause 11.9.2.2.3 Method AVGSA-1A. (alternative)
duty cycle < 98% and average over on/off periods with duty factor	
	<input type="checkbox"/> Refer as FCC KDB 558074, clause 8.3.2.2 & C63.10 clause 11.9.2.2.4 Method AVGSA-2.
	<input type="checkbox"/> Refer as FCC KDB 558074, clause 8.3.2.2 & C63.10 clause 11.9.2.2.5 Method AVGSA-2A (alternative)
	<input type="checkbox"/> Refer as FCC KDB 558074, clause 8.3.2.2 & C63.10 clause 11.9.2.2.6 Method AVGSA-3
	<input type="checkbox"/> Refer as FCC KDB 558074, clause 8.3.2.2 & C63.10 clause 11.9.2.2.7 Method AVGSA-3A (alternative)
Measurement using a power meter (PM)	
	<input type="checkbox"/> Refer as FCC KDB 558074, clause 8.3.2.3 & C63.10 clause 11.9.2.3.1 Method AVGPM (using an RF average power meter).
	<input checked="" type="checkbox"/> Refer as FCC KDB 558074, clause 8.3.2.3 & C63.10 clause 11.9.2.3.2 Method AVGPM-G (using an gate RF average power meter).
<ul style="list-style-type: none"> <li>▪ For conducted measurement.</li> </ul>	
	<ul style="list-style-type: none"> <li>▪ If the EUT supports multiple transmit chains using options given below: Refer as FCC KDB 662911, In-band power measurements. Using the measure-and-sum approach, measured all transmit ports individually. Sum the power (in linear power units e.g., mW) of all ports for each individual sample and save them.</li> </ul>
	<ul style="list-style-type: none"> <li>▪ If multiple transmit chains, EIRP calculation could be following as methods:  <math display="block">P_{total} = P_1 + P_2 + \dots + P_n</math>                     (calculated in linear unit [mW] and transfer to log unit [dBm])  <math display="block">EIRP_{total} = P_{total} + DG</math> </li> </ul>

**3.3.4 Test Setup**

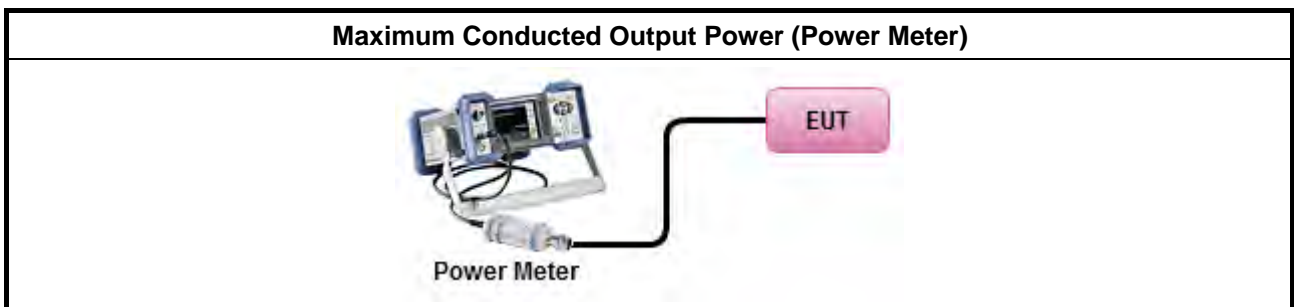



### **3.3.5 Test Result of Maximum Conducted Output Power**

Refer as Appendix C



### 3.4 Power Spectral Density

#### 3.4.1 Power Spectral Density Limit

Power Spectral Density Limit
<ul style="list-style-type: none"> <li>Power Spectral Density (PSD) ≤ 8 dBm/3kHz</li> </ul>

#### 3.4.2 Measuring Instruments

Refer a test equipment and calibration data table in this test report.

#### 3.4.3 Test Procedures

Test Method
<ul style="list-style-type: none"> <li>Peak power spectral density procedures that the same method as used to determine the conducted output power. If maximum peak conducted output power was measured to demonstrate compliance to the output power limit, then the peak PSD procedure below (Method PKPSD) shall be used. If maximum conducted output power was measured to demonstrate compliance to the output power limit, then one of the average PSD procedures shall be used, as applicable based on the following criteria (the peak PSD procedure is also an acceptable option).</li> </ul>
<input checked="" type="checkbox"/> Refer as FCC KDB 558074, clause 8.4 & C63.10 clause 11.10 Method Max. PSD. [duty cycle ≥ 98% or external video / power trigger]
<ul style="list-style-type: none"> <li>For conducted measurement.</li> </ul>
<ul style="list-style-type: none"> <li>If The EUT supports multiple transmit chains using options given below: <ul style="list-style-type: none"> <li><input type="checkbox"/> Option 1: Measure and sum the spectra across the outputs. Refer as FCC KDB 662911, In-band power spectral density (PSD). Sample all transmit ports simultaneously using a spectrum analyzer for each transmit port. Where the trace bin-by-bin of each transmit port summing can be performed. (i.e., in the first spectral bin of output 1 is summed with that in the first spectral bin of output 2 and that from the first spectral bin of output 3, and so on up to the NTX output to obtain the value for the first frequency bin of the summed spectrum.). Add up the amplitude (power) values for the different transmit chains and use this as the new data trace.</li> <li><input type="checkbox"/> Option 2: Measure and sum spectral maxima across the outputs. With this technique, spectra are measured at each output of the device at the required resolution bandwidth. The maximum value (peak) of each spectrum is determined. These maximum values are then summed mathematically in linear power units across the outputs. These operations shall be performed separately over frequency spans that have different out-of-band or spurious emission limits,</li> <li><input type="checkbox"/> Option 3: Measure and add 10 log(N) dB, where N is the number of transmit chains. Refer as FCC KDB 662911, In-band power spectral density (PSD). Performed at each transmit chains and each transmit chains shall be compared with the limit have been reduced with 10 log(N). Or each transmit chains shall be add 10 log(N) to compared with the limit.</li> </ul> </li> </ul>



### 3.4.4 Test Setup

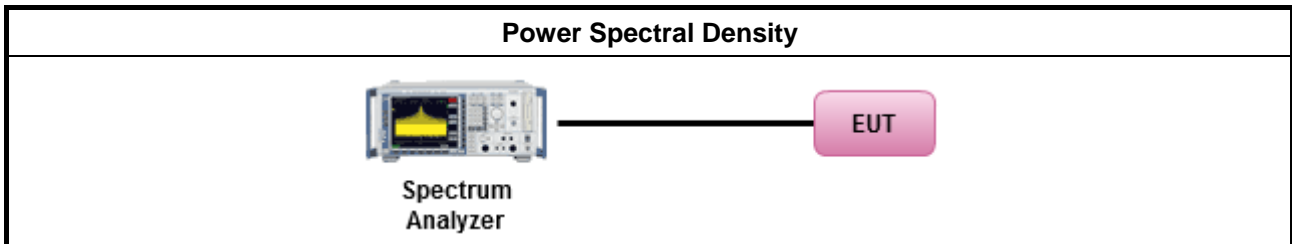

### 3.4.5 Test Result of Power Spectral Density

Refer as Appendix D

### 3.5 Emissions in Non-restricted Frequency Bands

#### 3.5.1 Emissions in Non-restricted Frequency Bands Limit

Un-restricted Band Emissions Limit	
RF output power procedure	Limit (dBc)
Peak output power procedure	20
Average output power procedure	30

Note 1: If the peak output power procedure is used to measure the fundamental emission power to demonstrate compliance to requirements, then the peak conducted output power measured within any 100 kHz outside the authorized frequency band shall be attenuated by at least 20 dB relative to the maximum measured in-band peak PSD level.

Note 2: If the average output power procedure is used to measure the fundamental emission power to demonstrate compliance to requirements, then the power in any 100 kHz outside of the authorized frequency band shall be attenuated by at least 30 dB relative to the maximum measured in-band average PSD level.

#### 3.5.2 Measuring Instruments

Refer a test equipment and calibration data table in this test report.

#### 3.5.3 Test Procedures

Test Method
<ul style="list-style-type: none"> <li>Refer as FCC KDB 558074, clause 8.5 for unwanted emissions into non-restricted bands.</li> </ul>

#### 3.5.4 Test Setup

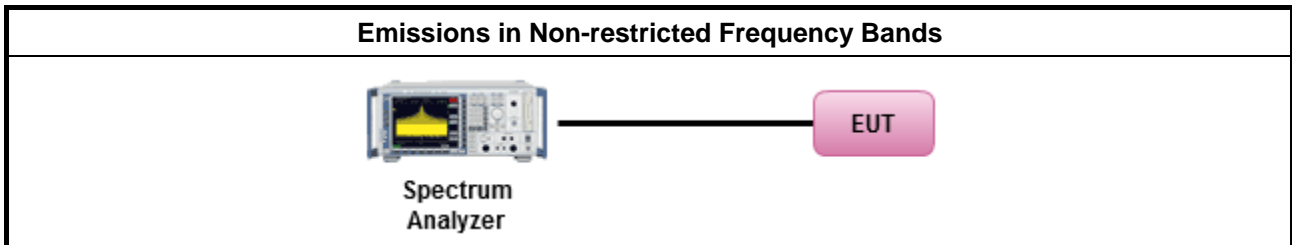

#### 3.5.5 Test Result of Emissions in Non-restricted Frequency Bands

Refer as Appendix E



### 3.6 Emissions in Restricted Frequency Bands

#### 3.6.1 Emissions in Restricted Frequency Bands Limit

Restricted Band Emissions Limit			
Frequency Range (MHz)	Field Strength (uV/m)	Field Strength (dBuV/m)	Measure Distance (m)
0.009~0.490	2400/F(kHz)	48.5 - 13.8	300
0.490~1.705	24000/F(kHz)	33.8 - 23	30
1.705~30.0	30	29	30
30~88	100	40	3
88~216	150	43.5	3
216~960	200	46	3
Above 960	500	54	3

Note 1: Test distance for frequencies at or above 30 MHz, measurements may be performed at a distance other than the limit distance provided they are not performed in the near field and the emissions to be measured can be detected by the measurement equipment. When performing measurements at a distance other than that specified, the results shall be extrapolated to the specified distance using an extrapolation factor of 20 dB/decade (inverse of linear distance for field-strength measurements, inverse of linear distance-squared for power-density measurements).

Note 2: Test distance for frequencies at below 30 MHz, measurements may be performed at a distance closer than the EUT limit distance; however, an attempt should be made to avoid making measurements in the near field. When performing measurements below 30 MHz at a closer distance than the limit distance, the results shall be extrapolated to the specified distance by either making measurements at a minimum of two or more distances on at least one radial to determine the proper extrapolation factor or by using the square of an inverse linear distance extrapolation factor (40 dB / decade). The test report shall specify the extrapolation method used to determine compliance of the EUT.

Note 3: Using the distance of 1m during the test for above 18 GHz, and the test value to correct for the distance factor at 3m.

#### 3.6.2 Measuring Instruments

Refer a test equipment and calibration data table in this test report.



**3.6.3 Test Procedures**

<b>Test Method</b>	
<ul style="list-style-type: none"> <li>▪ The average emission levels shall be measured in [duty cycle <math>\geq</math> 98 or duty factor].</li> </ul>	
<ul style="list-style-type: none"> <li>▪ Refer as ANSI C63.10, clause 6.10.3 band-edge testing shall be performed at the lowest frequency channel and highest frequency channel within the allowed operating band.</li> </ul>	
<ul style="list-style-type: none"> <li>▪ For the transmitter unwanted emissions shall be measured using following options below:</li> </ul>	
	<ul style="list-style-type: none"> <li>▪ Refer as FCC KDB 558074, clause 8.6 for unwanted emissions into restricted bands.</li> </ul>
	<input type="checkbox"/> Refer as FCC KDB 558074, clause 8.6 & C63.10 clause 11.12.2.5.1(trace averaging for duty cycle $\geq$ 98%).
	<input type="checkbox"/> Refer as FCC KDB 558074, clause 8.6 & C63.10 clause 11.12.2.5.2(trace averaging + duty factor).
	<input checked="" type="checkbox"/> Refer as FCC KDB 558074, clause 8.6 & C63.10 clause 11.12.2.5.3(Reduced VBW $\geq$ 1/T).
	<input type="checkbox"/> Refer as ANSI C63.10, clause 11.12.2.5.3 (Reduced VBW). VBW $\geq$ 1/T, where T is pulse time.
	<input type="checkbox"/> Refer as ANSI C63.10, clause 7.5 average value of pulsed emissions.
	<input checked="" type="checkbox"/> Refer as FCC KDB 558074, clause 8.6 & C63.10 clause 11.12.2.4 measurement procedure peak limit.
<ul style="list-style-type: none"> <li>▪ For the transmitter band-edge emissions shall be measured using following options below:</li> </ul>	
	<ul style="list-style-type: none"> <li>▪ Refer as FCC KDB 558074 clause 8.7 &amp; c63.10 clause 11.13.1, When the performing peak or average radiated measurements, emissions within 2 MHz of the authorized band edge may be measured using the marker-delta method described below.</li> </ul>
	<ul style="list-style-type: none"> <li>▪ Refer as FCC KDB 558074, clause 8.7 (ANSI C63.10, clause 6.10.6) for marker-delta method for band-edge measurements.</li> </ul>
	<ul style="list-style-type: none"> <li>▪ Refer as FCC KDB 558074, clause 8.7 for narrower resolution bandwidth (100kHz) using the band power and summing the spectral levels (i.e., 1 MHz).</li> </ul>
	<ul style="list-style-type: none"> <li>▪ For conducted unwanted emissions into restricted bands (absolute emission limits). Devices with multiple transmit chains using options given below:                (1) Measure and sum the spectra across the outputs or                (2) Measure and add 10 log(N) dB             </li> </ul>
	<ul style="list-style-type: none"> <li>▪ For FCC KDB 662911 The methodology described here may overestimate array gain, thereby resulting in apparent failures to satisfy the out-of-band limits even if the device is actually compliant. In such cases, compliance may be demonstrated by performing radiated tests around the frequencies at which the apparent failures occurred.</li> </ul>

**3.6.4 Test Setup**

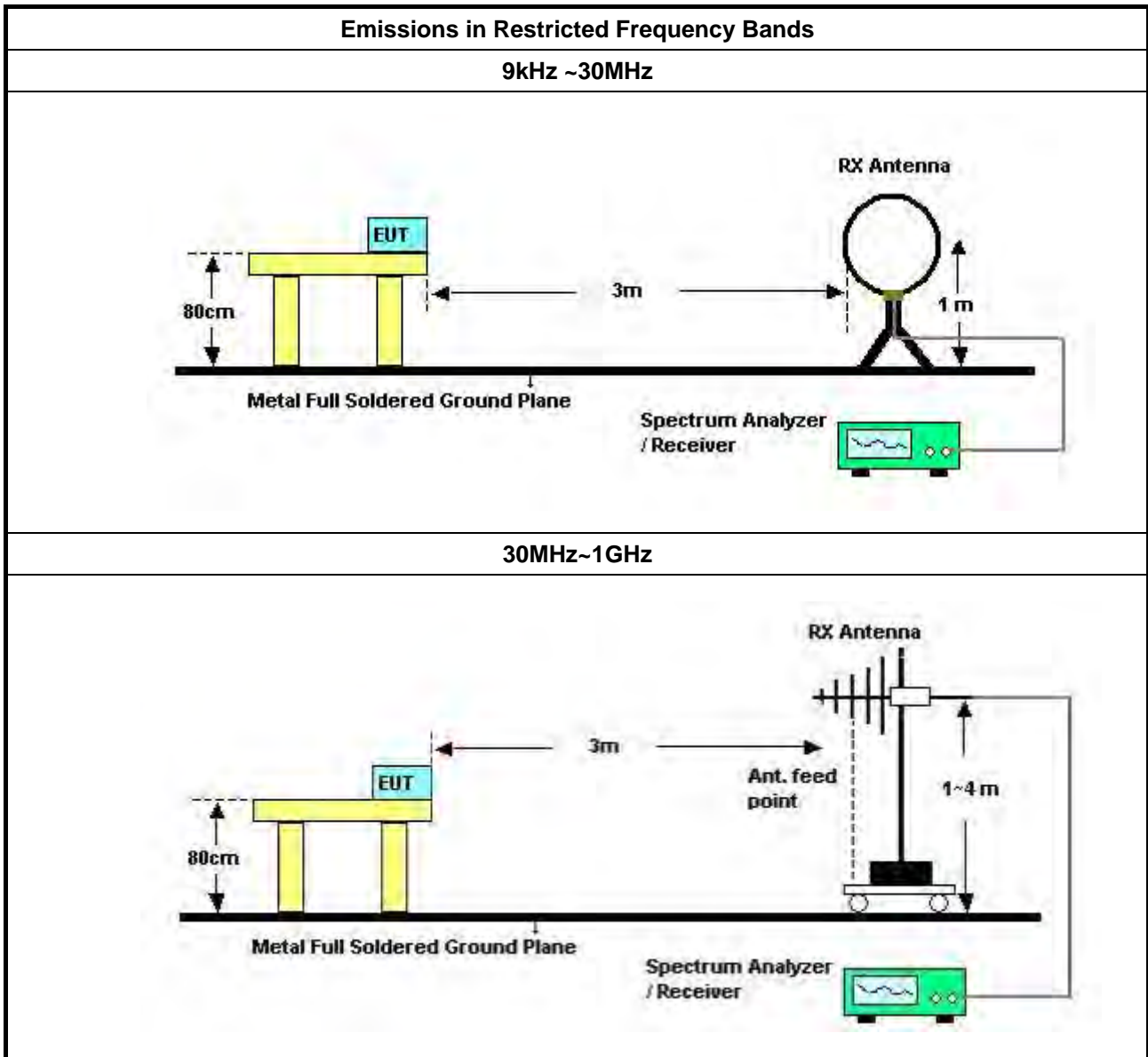

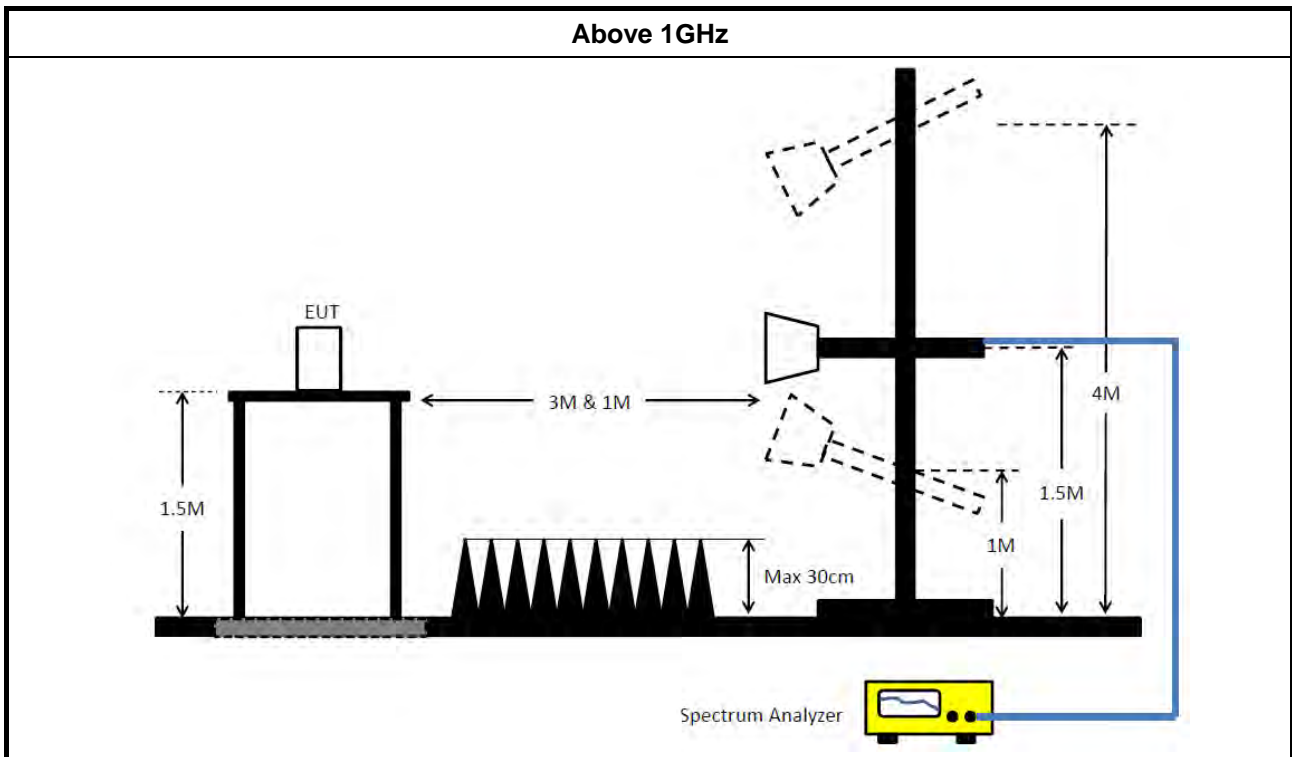

### 3.6.5 Measurement Results Calculation

The measured Level is calculated using:

Corrected Reading: Antenna factor (AF) + Cable loss (CL) + Read level (Raw) - Preamp factor (PA)(if applicable) = Level.

### 3.6.6 Emissions in Restricted Frequency Bands (Below 30MHz)

There is a comparison data of both open-field test site and alternative test site - semi-Anechoic chamber according to KDB414788 Radiated Test Site, and the result came out very similar.

All amplitude of spurious emissions that are attenuated by more than 20 dB below the permissible value has no need to be reported.

The radiated emissions were investigated from 9 kHz or the lowest frequency generated within the device, up to the 10th harmonic or 40 GHz, whichever is appropriate.

### 3.6.7 Test Result of Emissions in Restricted Frequency Bands

Refer as Appendix F



## 4 Test Equipment and Calibration Data

Instrument	Brand	Model No.	Serial No.	Characteristics	Calibration Date	Calibration Due Date	Remark
EMI Receiver	Agilent	N9038A	My52260123	9kHz ~ 8.4GHz	Mar. 03, 2021	Mar. 02, 2022	Conduction (CO01-CB)
LISN	F.C.C.	FCC-LISN-50-16-2	04083	150kHz ~ 100MHz	Jan. 06, 2021	Jan. 05, 2022	Conduction (CO01-CB)
LISN	Schwarzbeck	NSLK 8127	8127647	9kHz ~ 30MHz	Mar. 07, 2021	Mar. 06, 2022	Conduction (CO01-CB)
Pulse Limiter	Rohde&Schwarz	ESH3-Z2	100430	9kHz ~ 30MHz	Jan. 30, 2021	Jan. 29, 2022	Conduction (CO01-CB)
COND Cable	Woken	Cable	Low cable-CO01	9kHz ~ 30MHz	May 19, 2021	May 18, 2022	Conduction (CO01-CB)
Software	SPORTON	SENSE	V5.10	-	N.C.R.	N.C.R.	Conduction (CO01-CB)
Loop Antenna	Teseq	HLA 6120	24155	9kHz - 30 MHz	Apr. 14, 2021	Apr. 13, 2022	Radiation (10CH01-CB)
10m Semi Anechoic Chamber NSA	TDK	SAC-10M	10CH01-CB	30MHz~1GHz 10m,3m	Jan. 28, 2021	Jan. 27, 2022	Radiation (10CH01-CB)
10m Semi Anechoic Chamber NSA	TDK	SAC-10M	10CH01-CB	30MHz~1GHz 10m,3m	Jan. 28, 2021	Jan. 27, 2022	Radiation (10CH01-CB)
Pre-Amplifier	Agilent	8447D	2944A10783	9kHz ~ 1.3GHz	Mar. 11, 2021	Mar. 10, 2022	Radiation (10CH01-CB)
Pre-Amplifier	Agilent	8447D	2944A10784	9kHz ~ 1.3GHz	Mar. 11, 2021	Mar. 10, 2022	Radiation (10CH01-CB)
Low Cable	Woken	SUCOFLEX 104	low cable-01	25MHz ~ 1GHz	Oct. 20, 2020	Oct. 19, 2021	Radiation (10CH01-CB)
High Cable	Woken	SUCOFLEX 104	low cable-02	25MHz ~ 1GHz	Oct. 20, 2020	Oct. 19, 2021	Radiation (10CH01-CB)
Bilog Antenna with 6dB Attenuator	Chase & EMCI	CBL6111A &N-6-06	1543 &AT-N0609	30MHz ~ 1GHz	Jul. 01, 2021	Jun. 30, 2022	Radiation (10CH01-CB)
EMI Test Receiver	Rohde&Schwarz	ESCI	100186	9kHz ~ 3GHz	Jul. 12, 2021	Jul. 11, 2022	Radiation (10CH01-CB)
Spectrum Analyzer	Rohde&Schwarz	FSV30	101026	9kHz ~ 30GHz	Mar. 08, 2021	Mar. 07, 2022	Radiation (10CH01-CB)
Software	SPORTON	SENSE	V5.10	-	N.C.R.	N.C.R.	Radiation (10CH01-CB)
3m Semi Anechoic Chamber VSWR	TDK	SAC-3M	03CH01-CB	1GHz ~18GHz 3m	May 07, 2021	May 06, 2022	Radiation (03CH01-CB)
Horn Antenna	ETS-LINDGREN	3115	00075790	750MHz ~ 18GHz	Nov. 06, 2020	Nov. 05, 2021	Radiation (03CH01-CB)
Horn Antenna	Schwarzbeck	BBHA 9170	BBHA9170252	15GHz ~ 40GHz	Aug. 05, 2021	Aug. 04, 2022	Radiation (03CH01-CB)
Pre-Amplifier	Agilent	8449B	3008A02121	1GHz ~ 26.5GHz	May 20, 2021	May 19, 2022	Radiation (03CH01-CB)



Instrument	Brand	Model No.	Serial No.	Characteristics	Calibration Date	Calibration Due Date	Remark
Pre-Amplifier	MITEQ	TTA1840-35-HG	1864479	18GHz ~ 40GHz	Jul. 13, 2021	Jul. 12, 2022	Radiation (03CH01-CB)
Spectrum Analyzer	R&S	FSP40	100056	9kHz ~ 40GHz	May 03, 2021	May 02, 2022	Radiation (03CH01-CB)
RF Cable-high	Woken	RG402	High Cable-18	1GHz ~ 18GHz	Oct. 05, 2020	Oct. 04, 2021	Radiation (03CH01-CB)
RF Cable-high	Woken	RG402	High Cable-18	1GHz ~ 18GHz	Oct. 04, 2021	Oct. 03, 2022	Radiation (03CH01-CB)
RF Cable-high	Woken	RG402	High Cable-18+19	1GHz ~ 18GHz	Oct. 05, 2020	Oct. 04, 2021	Radiation (03CH01-CB)
RF Cable-high	Woken	RG402	High Cable-18+19	1GHz ~ 18GHz	Oct. 04, 2021	Oct. 03, 2022	Radiation (03CH01-CB)
RF Cable-high	Woken	RG402	High Cable-40G#1	18GHz ~ 40 GHz	Jul. 15, 2021	Jul. 14, 2022	Radiation (03CH01-CB)
RF Cable-high	Woken	RG402	High Cable-40G#2	18GHz ~ 40 GHz	Jul. 15, 2021	Jul. 14, 2022	Radiation (03CH01-CB)
Test Software	SPORTON	SENSE	V5.10	-	N.C.R.	N.C.R.	Radiation (03CH01-CB)
3m Semi Anechoic Chamber VSWR	TDK	SAC-3M	03CH04-CB	1GHz ~18GHz 3m	Feb. 25, 2021	Feb. 24, 2022	Radiation (03CH04-CB)
Horn Antenna	COM-POWER	AH-118	071028	1GHz ~ 18GHz	Jun. 23, 2021	Jun. 22, 2022	Radiation (03CH04-CB)
Horn Antenna	Schwarzbeck	BBHA 9170	BBHA9170252	15GHz ~ 40GHz	Aug. 05, 2021	Aug. 04, 2022	Radiation (03CH04-CB)
Pre-Amplifier	Agilent	83017A	MY53270063	0.5GHz ~ 26.5GHz	Jul. 12, 2021	Jul. 11, 2022	Radiation (03CH04-CB)
Pre-Amplifier	MITEQ	TTA1840-35-HG	1864479	18GHz ~ 40GHz	Jul. 13, 2021	Jul. 12, 2022	Radiation (03CH04-CB)
Spectrum Analyzer	R&S	FSP40	100142	9kHz~40GHz	Feb. 19, 2021	Feb. 18, 2022	Radiation (03CH04-CB)
RF Cable-high	Woken	RG402	High Cable-18	1GHz ~ 18GHz	Oct. 05, 2020	Oct. 04, 2021	Radiation (03CH04-CB)
RF Cable-high	Woken	RG402	High Cable-18	1GHz ~ 18GHz	Oct. 04, 2021	Oct. 03, 2022	Radiation (03CH04-CB)
RF Cable-high	Woken	RG402	High Cable-18+19	1GHz ~ 18GHz	Oct. 05, 2020	Oct. 04, 2021	Radiation (03CH04-CB)
RF Cable-high	Woken	RG402	High Cable-18+19	1GHz ~ 18GHz	Oct. 04, 2021	Oct. 03, 2022	Radiation (03CH04-CB)
RF Cable-high	Woken	RG402	High Cable-40G#1	18GHz ~ 40 GHz	Jul. 15, 2021	Jul. 14, 2022	Radiation (03CH04-CB)
RF Cable-high	Woken	RG402	High Cable-40G#2	18GHz ~ 40 GHz	Jul. 15, 2021	Jul. 14, 2022	Radiation (03CH04-CB)
Test Software	SPORTON	SENSE	V5.10	-	N.C.R.	N.C.R.	Radiation (03CH04-CB)
Spectrum analyzer	R&S	FSV40	101027	9kHz~40GHz	Aug. 02, 2021	Aug. 01, 2022	Conducted (TH02-CB)
Power Sensor	Anritsu	MA2411B	1531343	300MHz~40GHz	Aug. 15, 2021	Aug. 14, 2022	Conducted (TH02-CB)





Instrument	Brand	Model No.	Serial No.	Characteristics	Calibration Date	Calibration Due Date	Remark
Power Meter	Anritsu	ML2495A	1728001	300MHz~40GHz	Aug. 15, 2021	Aug. 14, 2022	Conducted (TH02-CB)
RF Cable-high	Woken	RG402	High Cable-01	1 GHz – 18 GHz	Oct. 05, 2020	Oct. 04, 2021	Conducted (TH02-CB)
RF Cable-high	Woken	RG402	High Cable-01	1 GHz – 18 GHz	Oct. 04, 2021	Oct. 03, 2022	Conducted (TH02-CB)
RF Cable-high	Woken	RG402	High Cable-02	1 GHz – 18 GHz	Oct. 05, 2020	Oct. 04, 2021	Conducted (TH02-CB)
RF Cable-high	Woken	RG402	High Cable-02	1 GHz – 18 GHz	Oct. 04, 2021	Oct. 03, 2022	Conducted (TH02-CB)
RF Cable-high	Woken	RG402	High Cable-03	1 GHz – 18 GHz	Oct. 05, 2020	Oct. 04, 2021	Conducted (TH02-CB)
RF Cable-high	Woken	RG402	High Cable-03	1 GHz – 18 GHz	Oct. 04, 2021	Oct. 03, 2022	Conducted (TH02-CB)
RF Cable-high	Woken	RG402	High Cable-04	1 GHz – 18 GHz	Oct. 05, 2020	Oct. 04, 2021	Conducted (TH02-CB)
RF Cable-high	Woken	RG402	High Cable-04	1 GHz – 18 GHz	Oct. 04, 2021	Oct. 03, 2022	Conducted (TH02-CB)
RF Cable-high	Woken	RG402	High Cable-05	1 GHz – 18 GHz	Oct. 05, 2020	Oct. 04, 2021	Conducted (TH02-CB)
RF Cable-high	Woken	RG402	High Cable-05	1 GHz – 18 GHz	Oct. 04, 2021	Oct. 03, 2022	Conducted (TH02-CB)
Test Software	SPORTON	SENSE	V5.10	-	N.C.R.	N.C.R.	Conducted (TH02-CB)

Note: Calibration Interval of instruments listed above is one year.

NCR means Non-Calibration required.



**Summary**

Mode	Result	Type	Freq (Hz)	Level (dBuV)	Limit (dBuV)	Margin (dB)	Condition
Mode 2	Pass	QP	177k	56.80	64.62	-7.82	Line

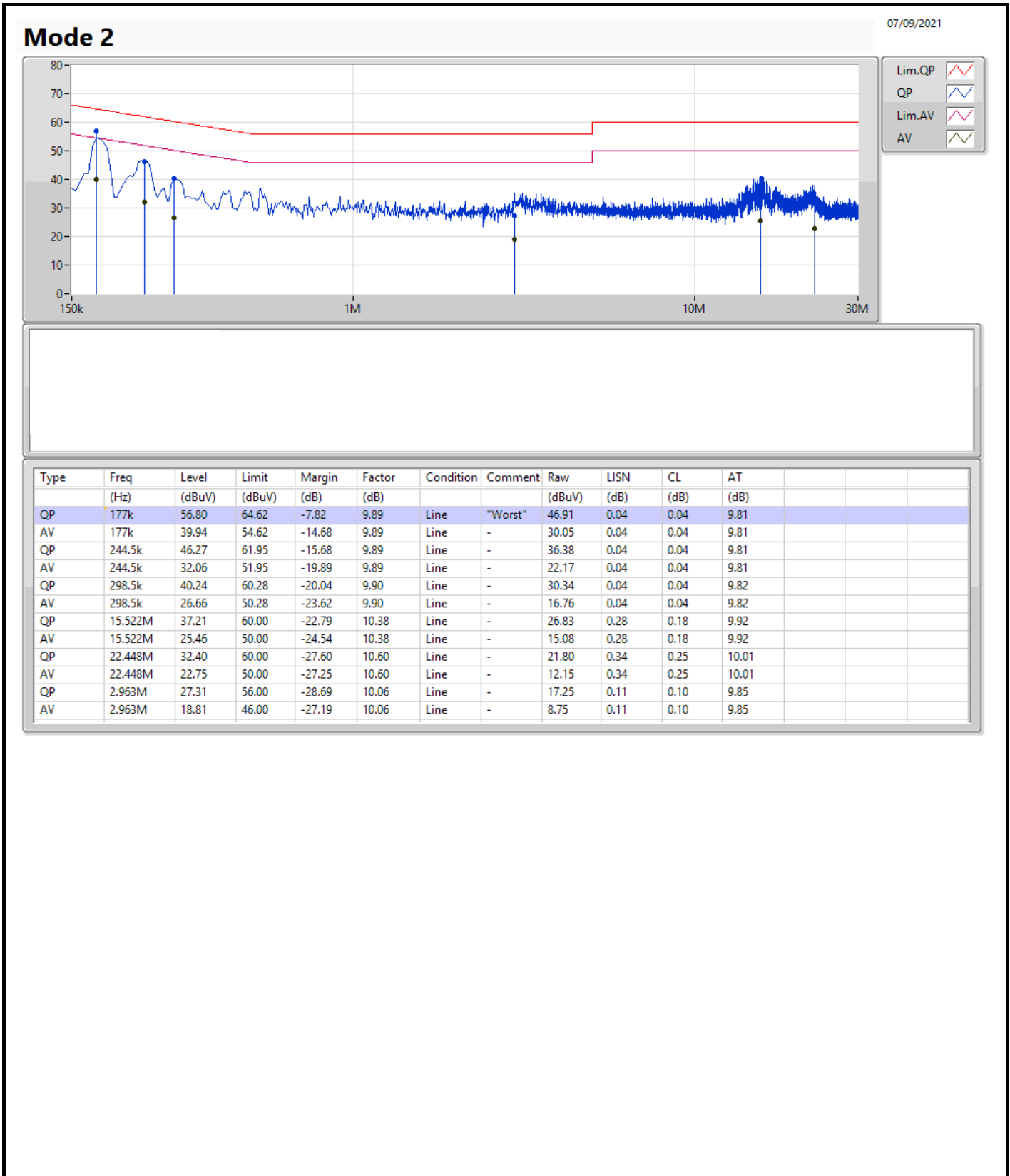

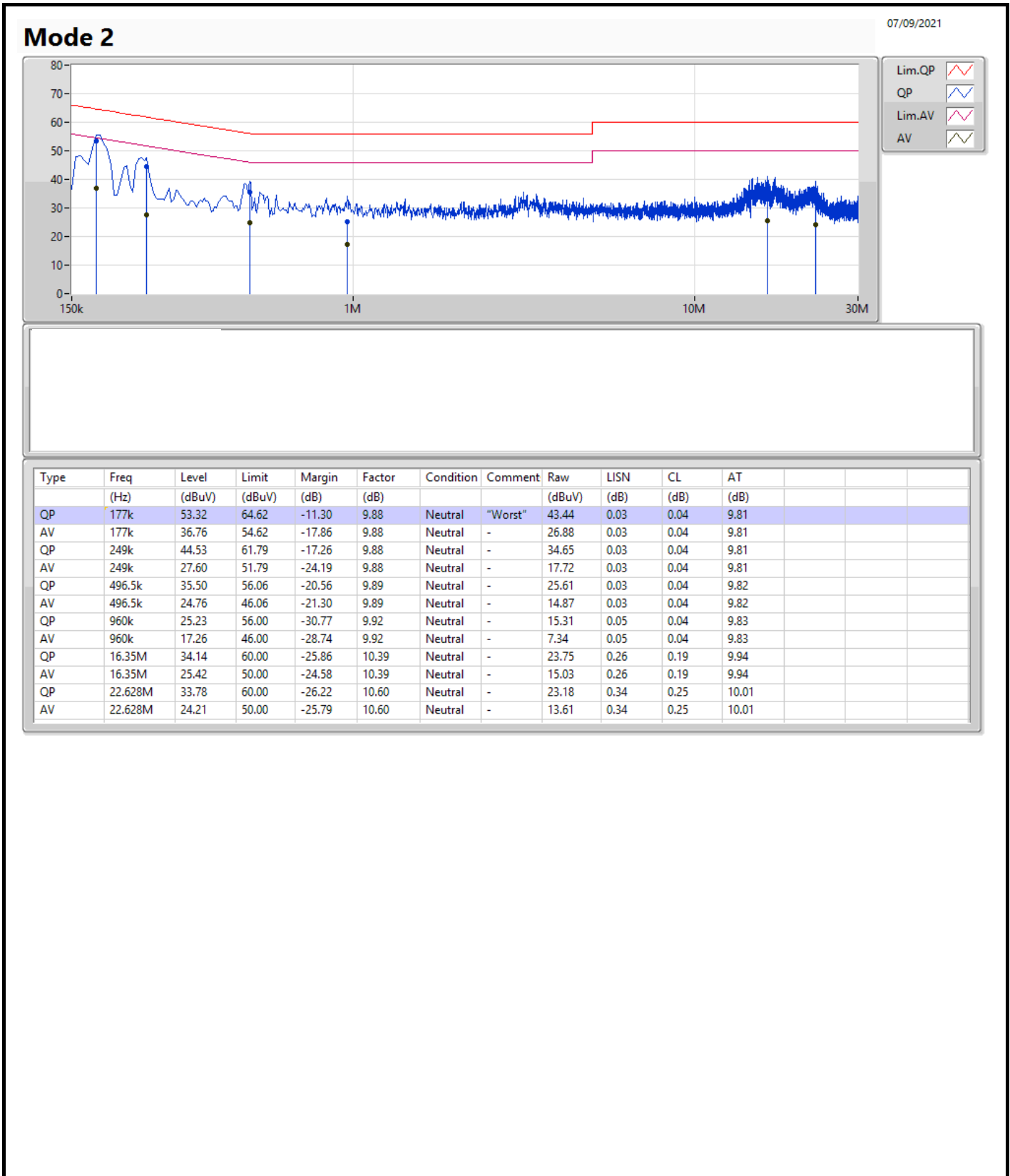



Summary

Mode	Max-N dB (Hz)	Max-OBW (Hz)	ITU-Code	Min-N dB (Hz)	Min-OBW (Hz)
2.4-2.4835GHz	-	-	-	-	-
BT-LE(1Mbps)	721.25k	1.057M	1M06F1D	711.25k	1.056M
BT-LE(2Mbps)	1.275M	2.109M	2M11F1D	1.268M	2.094M

Max-N dB = Maximum 6dB down bandwidth; Max-OBW = Maximum 99% occupied bandwidth;  
Min-N dB = Minimum 6dB down bandwidth; Min-OBW = Minimum 99% occupied bandwidth



Result

Mode	Result	Limit (Hz)	Port 1-N dB (Hz)	Port 1-OBW (Hz)
BT-LE(1Mbps)	-	-	-	-
2402MHz	Pass	500k	711.25k	1.056M
2440MHz	Pass	500k	718.75k	1.057M
2480MHz	Pass	500k	721.25k	1.057M
BT-LE(2Mbps)	-	-	-	-
2402MHz	Pass	500k	1.268M	2.094M
2440MHz	Pass	500k	1.275M	2.101M
2480MHz	Pass	500k	1.27M	2.109M

Port X-N dB = Port X 6dB down bandwidth;  
Port X-OBW = Port X 99% occupied bandwidth

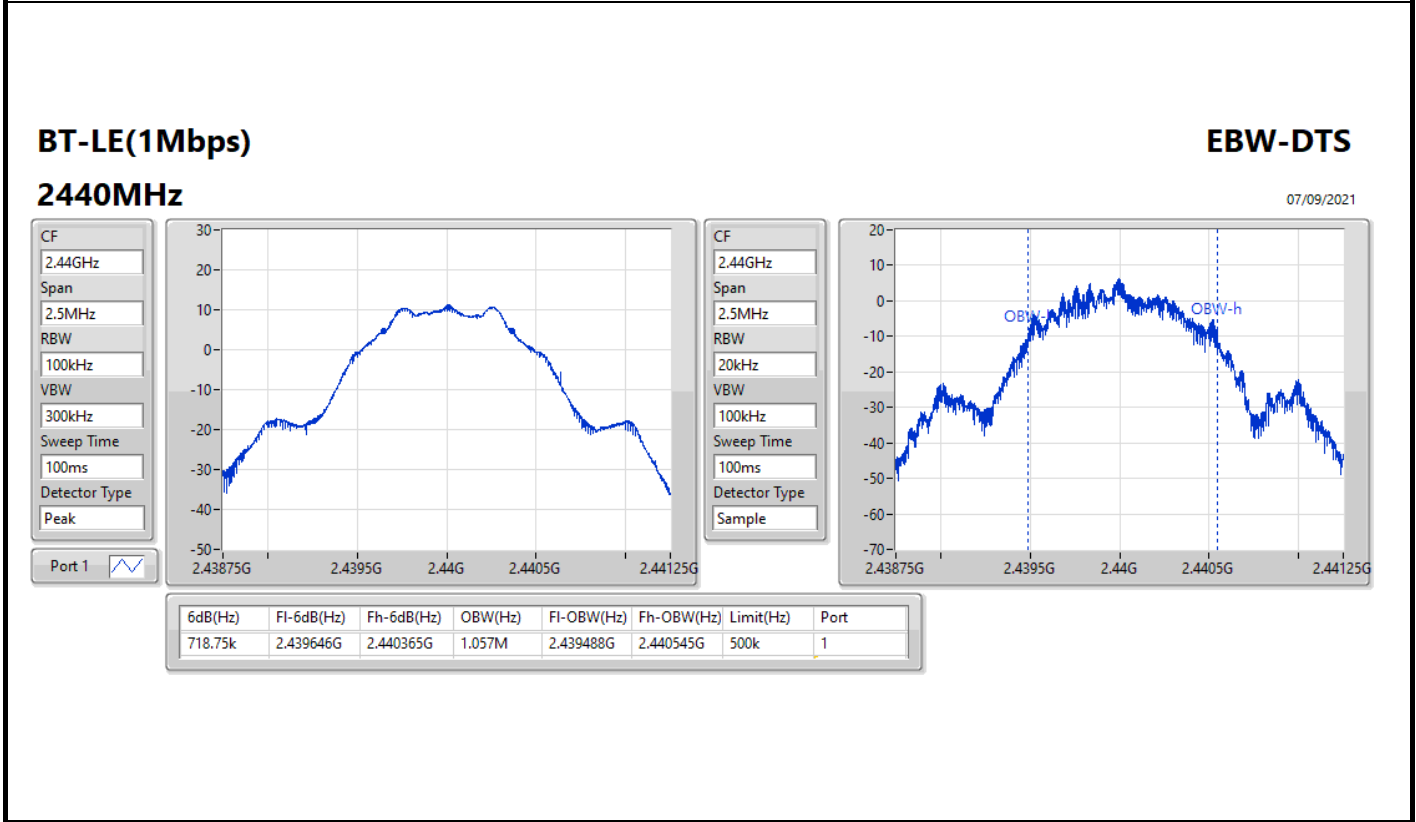
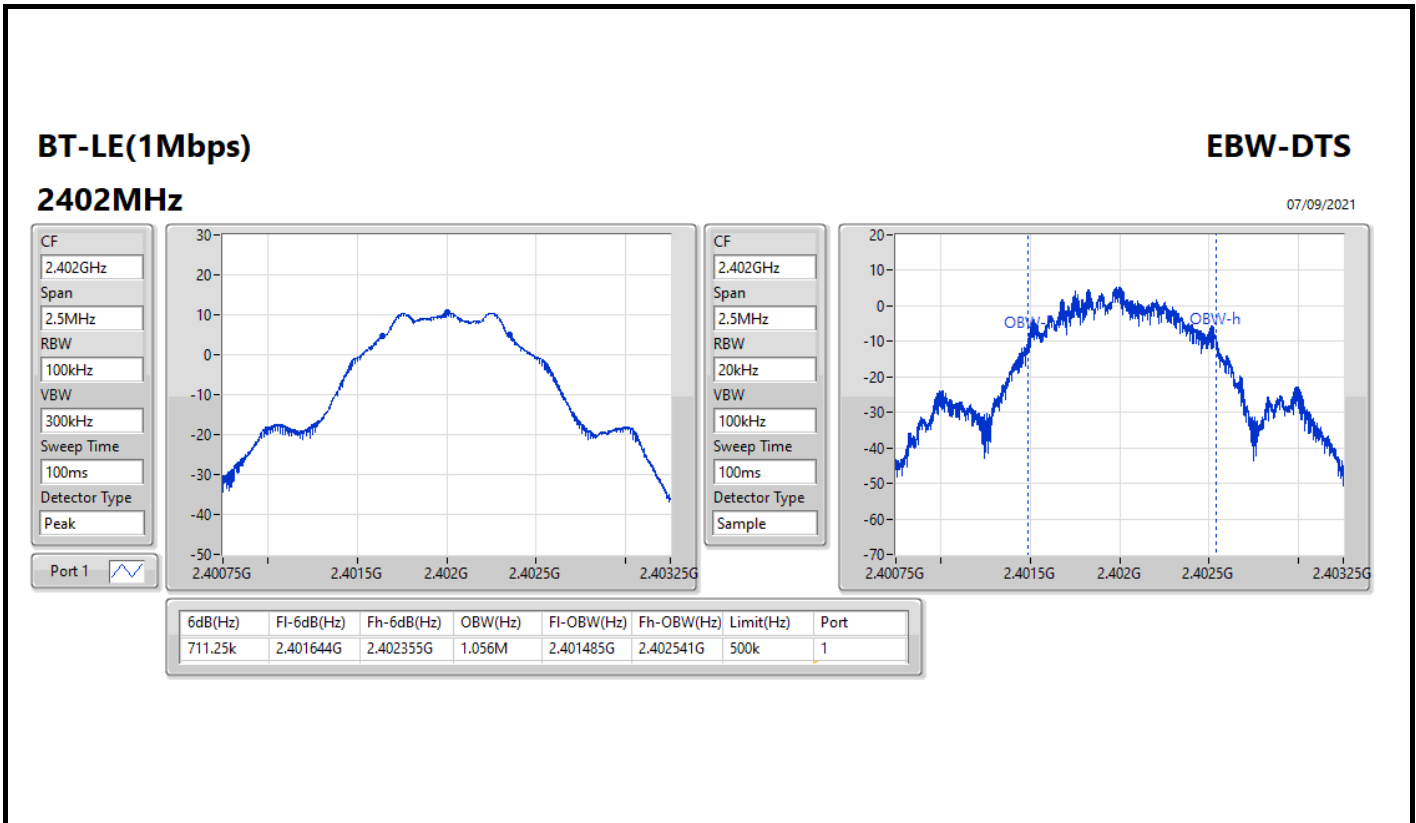

**BT-LE(1Mbps)**

**EBW-DTS**

2480MHz

07/09/2021

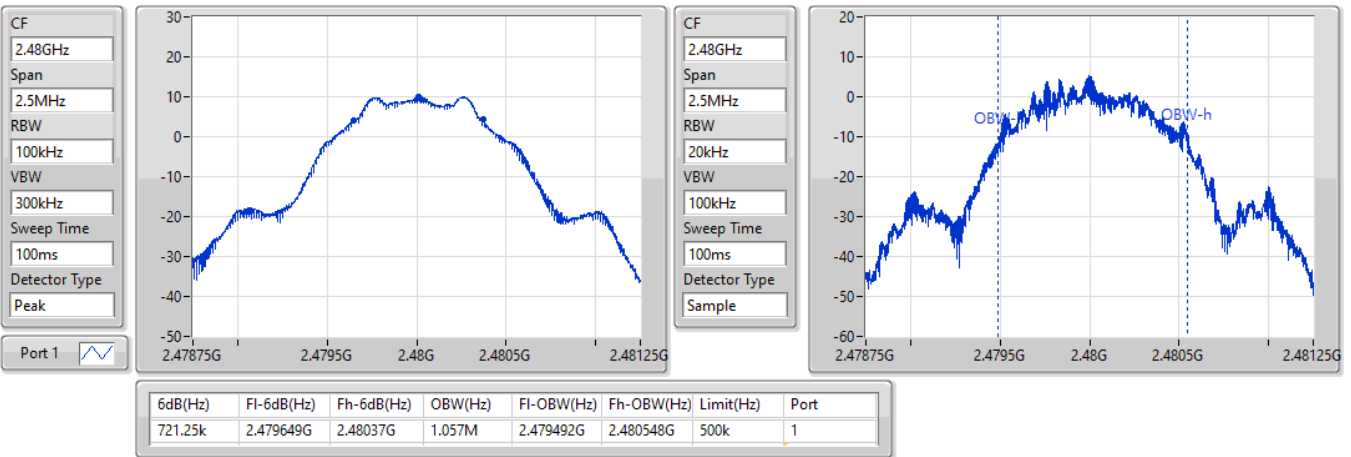

**BT-LE(2Mbps)**

**EBW-DTS**

2402MHz

07/09/2021

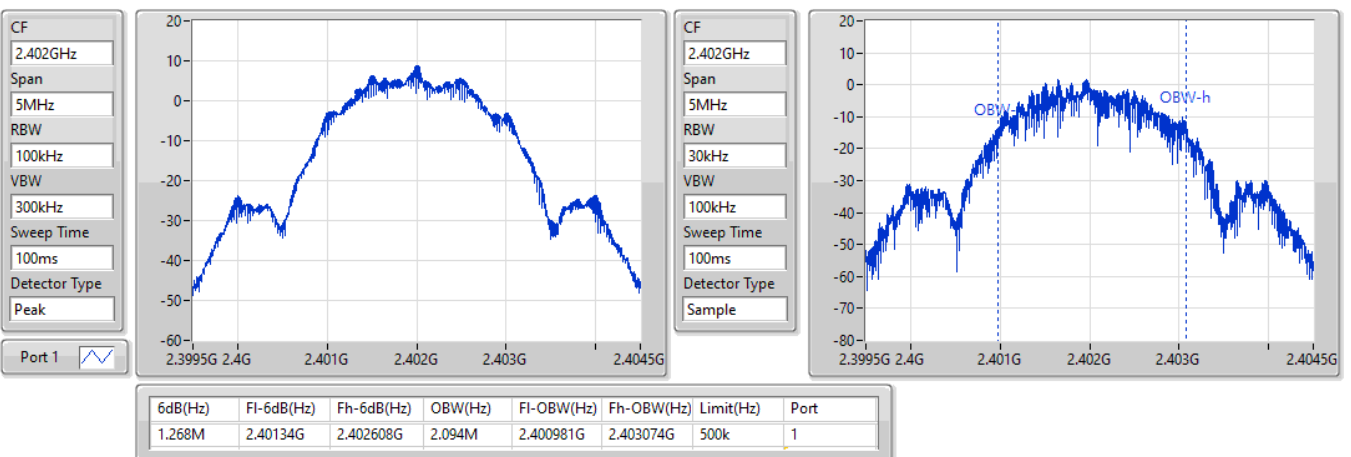



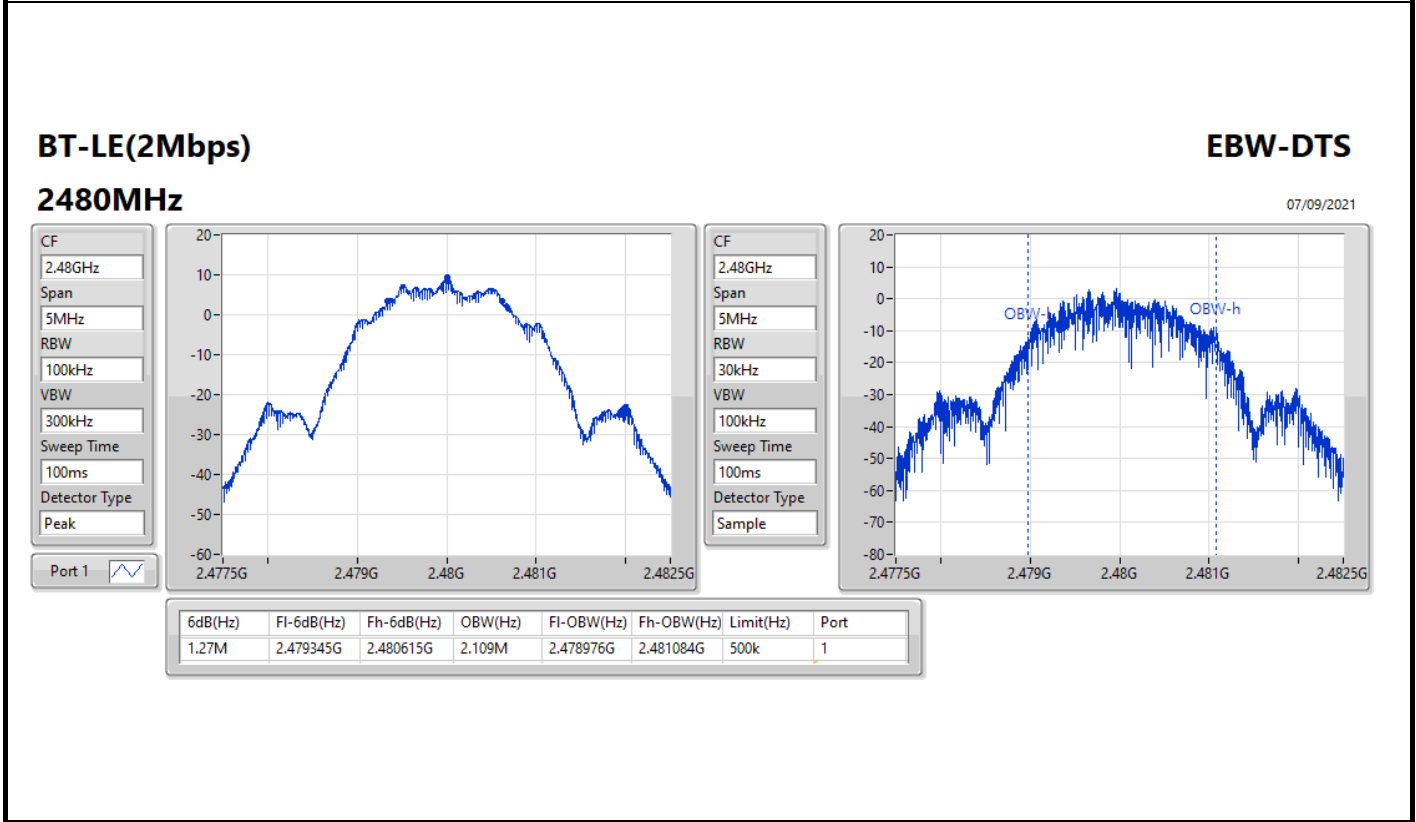
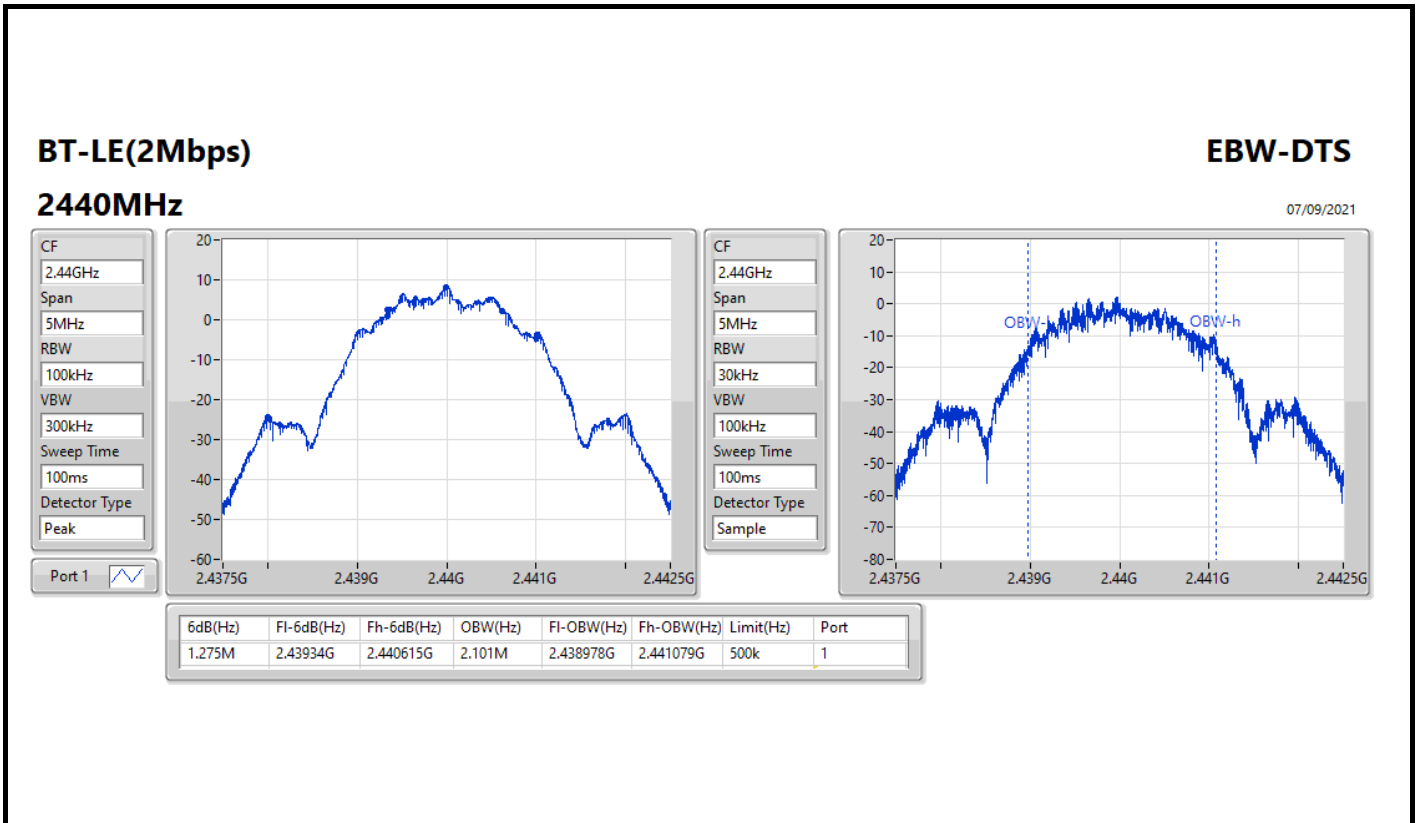



**Summary**

Mode	Power (dBm)	Power (W)
2.4-2.4835GHz	-	-
BT-LE(1Mbps)	10.95	0.01245
BT-LE(2Mbps)	10.22	0.01052



Result

Mode	Result	Gain (dBi)	Power (dBm)	Power Limit (dBm)
BT-LE(1Mbps)	-	-	-	-
2402MHz	Pass	4.30	10.78	30.00
2440MHz	Pass	4.30	10.95	30.00
2480MHz	Pass	4.30	10.30	30.00
BT-LE(2Mbps)	-	-	-	-
2402MHz	Pass	4.30	8.93	30.00
2440MHz	Pass	4.30	8.92	30.00
2480MHz	Pass	4.30	10.22	30.00

DG = Directional Gain; Port X = Port X output power



Summary

Mode	PD (dBm/RBW)
2.4-2.4835GHz	-
BT-LE(1Mbps)	-3.60
BT-LE(2Mbps)	-7.45

RBW = 3kHz:



Result

Mode	Result	Gain (dBi)	PD (dBm/RBW)	PD Limit (dBm/RBW)
BT-LE(1Mbps)	-	-	-	-
2402MHz	Pass	4.30	-3.72	8.00
2440MHz	Pass	4.30	-3.60	8.00
2480MHz	Pass	4.30	-4.57	8.00
BT-LE(2Mbps)	-	-	-	-
2402MHz	Pass	4.30	-8.65	8.00
2440MHz	Pass	4.30	-8.90	8.00
2480MHz	Pass	4.30	-7.45	8.00

DG = Directional Gain; RBW = 3kHz;  
PD = trace bin-by-bin of each transmits port summing can be performed maximum power density; Port X = Port X Power Density;

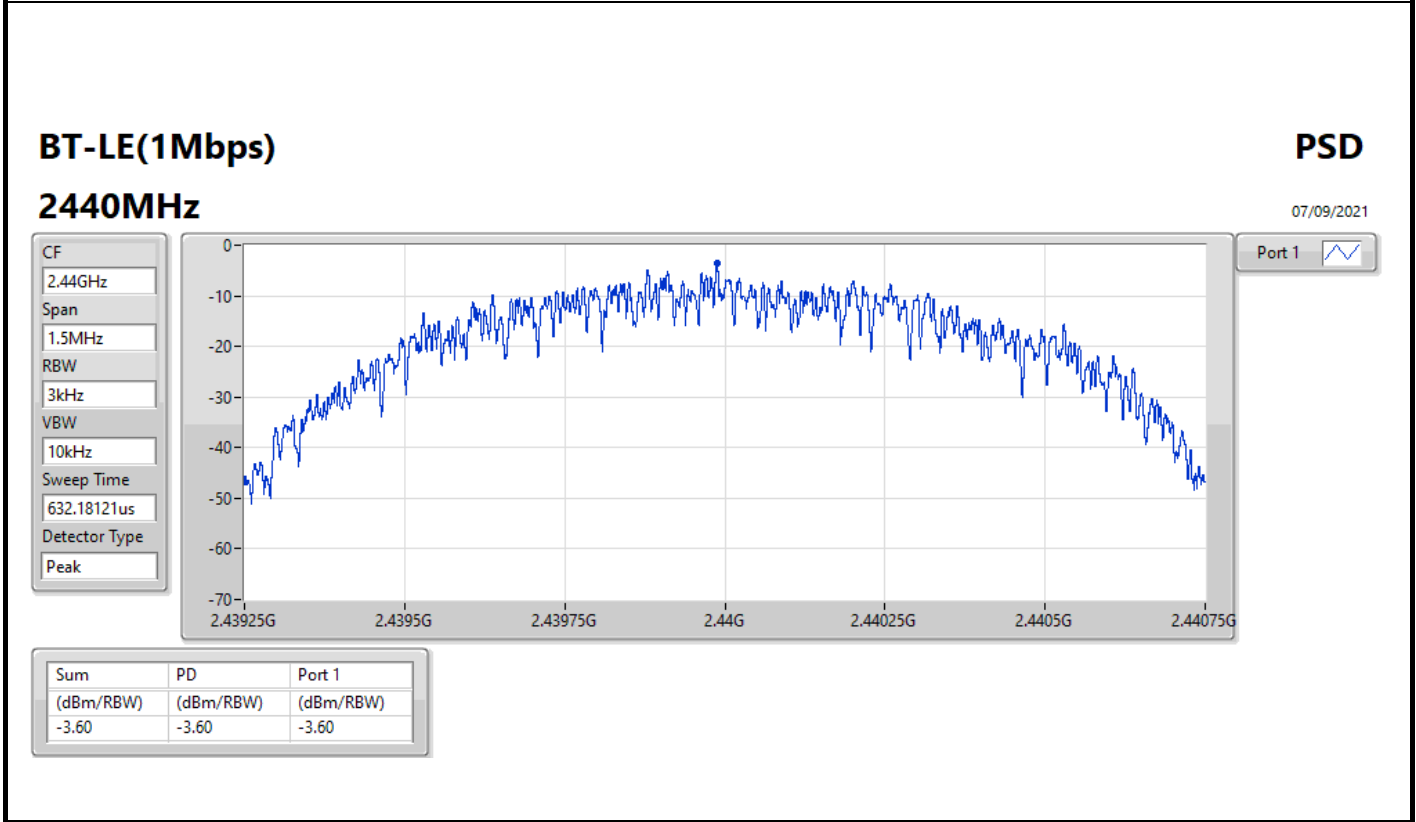
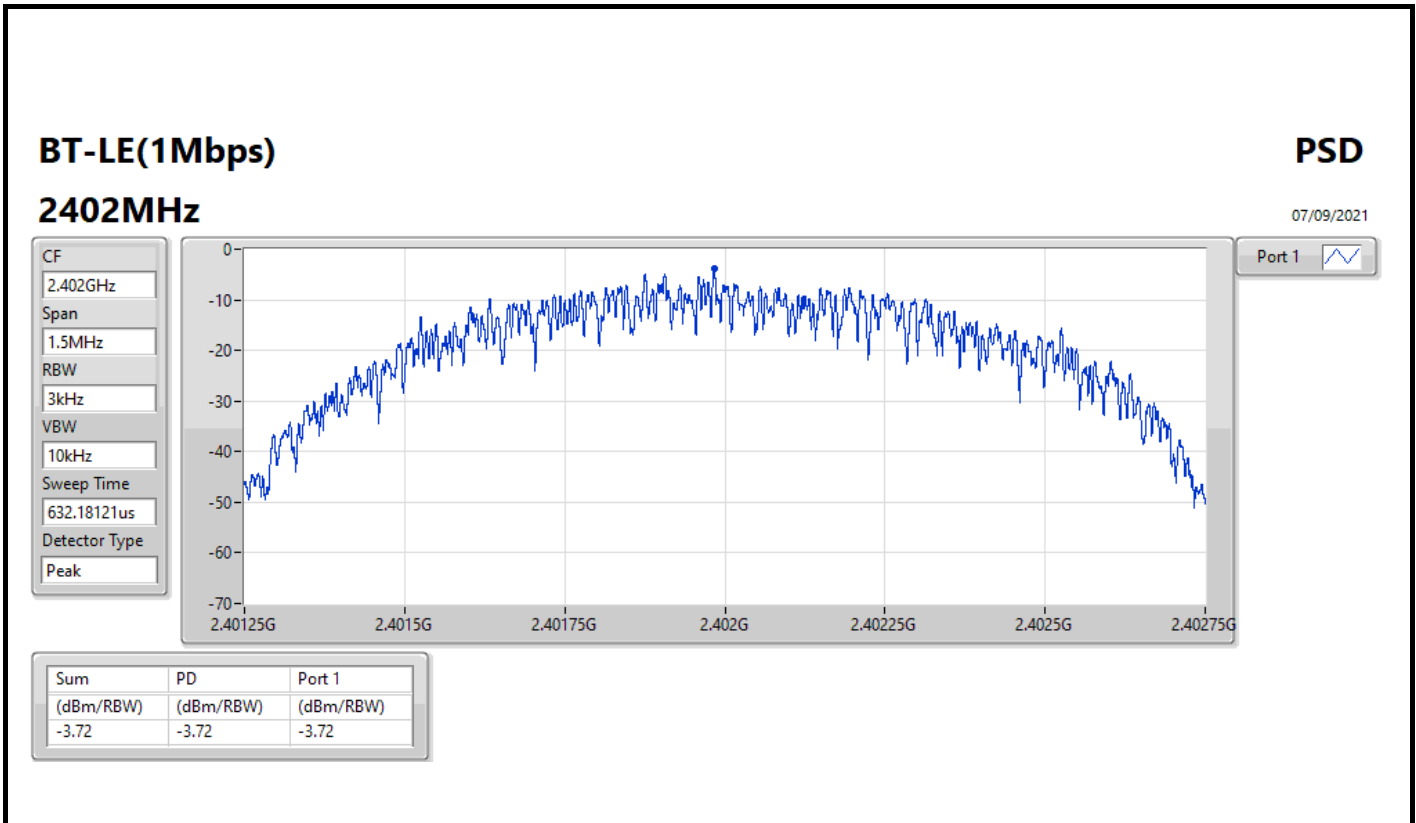

### BT-LE(1Mbps)

### PSD

2480MHz

07/09/2021

CF  
2.48GHz

Span  
1.5MHz

RBW  
3kHz

VBW  
10kHz

Sweep Time  
632.18121us

Detector Type  
Peak

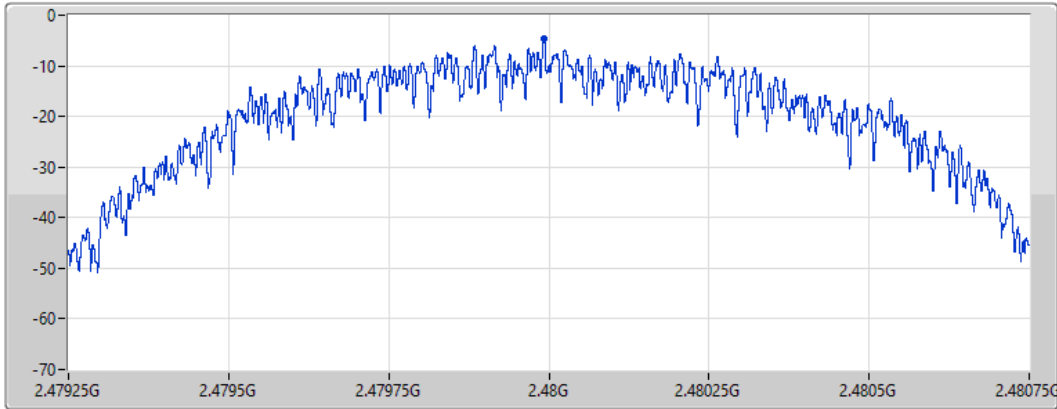

Port 1 

Sum	PD	Port 1
(dBm/RBW)	(dBm/RBW)	(dBm/RBW)
-4.57	-4.57	-4.57

### BT-LE(2Mbps)

### PSD

2402MHz

07/09/2021

CF  
2.402GHz

Span  
3MHz

RBW  
3kHz

VBW  
10kHz

Sweep Time  
632.01845us

Detector Type  
Peak

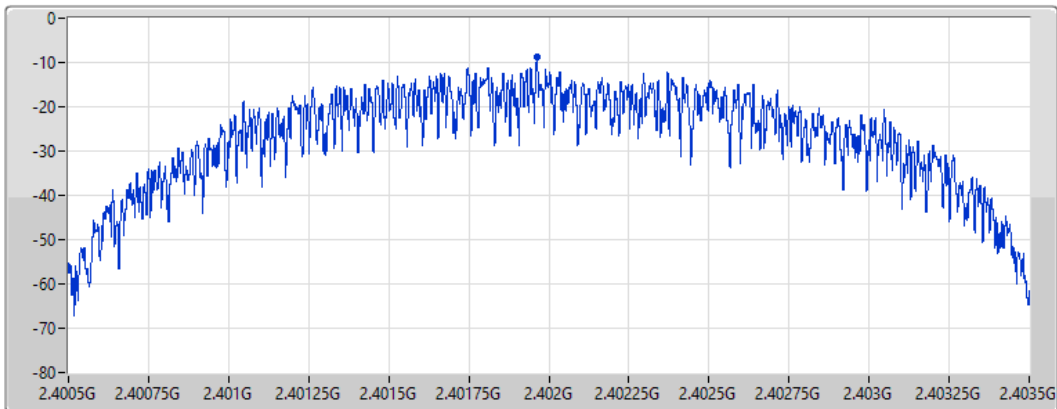

Port 1 

Sum	PD	Port 1
(dBm/RBW)	(dBm/RBW)	(dBm/RBW)
-8.65	-8.65	-8.65

**BT-LE(2Mbps)**

**PSD**

**2440MHz**

07/09/2021

CF  
2.44GHz

Span  
3MHz

RBW  
3kHz

VBW  
10kHz

Sweep Time  
632.01845us

Detector Type  
Peak

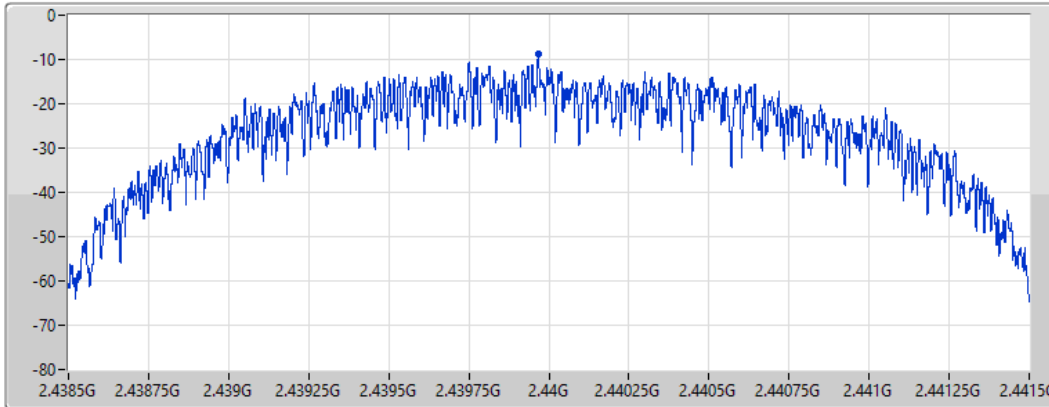

Port 1 

Sum	PD	Port 1
(dBm/RBW)	(dBm/RBW)	(dBm/RBW)
-8.90	-8.90	-8.90

**BT-LE(2Mbps)**

**PSD**

**2480MHz**

07/09/2021

CF  
2.48GHz

Span  
3MHz

RBW  
3kHz

VBW  
10kHz

Sweep Time  
632.01845us

Detector Type  
Peak

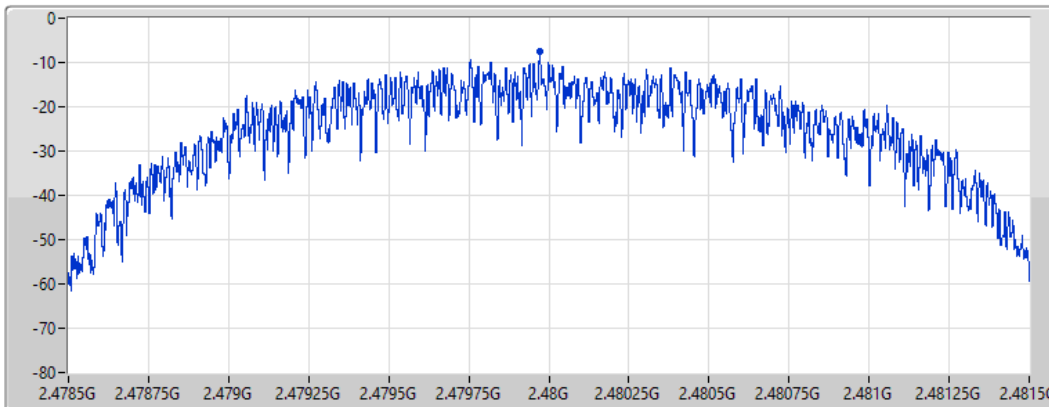

Port 1 

Sum	PD	Port 1
(dBm/RBW)	(dBm/RBW)	(dBm/RBW)
-7.45	-7.45	-7.45





Summary

Mode	Result	Ref (Hz)	Ref (dBm)	Limit (dBm)	Freq (Hz)	Level (dBm)	Freq (Hz)	Level (dBm)	Freq (Hz)	Level (dBm)	Freq (Hz)	Level (dBm)	Freq (Hz)	Level (dBm)	Port
2.4-2.4835GHz	-	-	-	-	-	-	-	-	-	-	-	-	-	-	-
BT-LE(1Mbps)	Pass	2.44G	10.60	-19.40	912.13M	-52.47	2.39982G	-49.20	2.4G	-48.62	2.50312G	-51.30	6.66816G	-45.71	1
BT-LE(2Mbps)	Pass	2.47999G	9.03	-20.97	2.14471G	-51.62	2.39999G	-24.20	2.4G	-25.22	2.49295G	-51.04	6.78346G	-46.22	1



Result

Mode	Result	Ref (Hz)	Ref (dBm)	Limit (dBm)	Freq (Hz)	Level (dBm)	Freq (Hz)	Level (dBm)	Freq (Hz)	Level (dBm)	Freq (Hz)	Level (dBm)	Freq (Hz)	Level (dBm)	Port
BT-LE(1Mbps)	-	-	-	-	-	-	-	-	-	-	-	-	-	-	-
2402MHz	Pass	2.44G	10.60	-19.40	912.13M	-52.47	2.39982G	-49.20	2.4G	-48.62	2.50312G	-51.30	6.66816G	-45.71	1
2440MHz	Pass	2.44G	10.60	-19.40	939.45M	-51.69	2.39558G	-51.97	2.4835G	-52.03	2.48445G	-51.17	24.47133G	-45.94	1
2480MHz	Pass	2.44G	10.60	-19.40	2.16028G	-51.86	2.39617G	-50.74	2.4835G	-53.51	2.49866G	-49.91	16.75503G	-45.73	1
BT-LE(2Mbps)	-	-	-	-	-	-	-	-	-	-	-	-	-	-	-
2402MHz	Pass	2.47999G	9.03	-20.97	2.14471G	-51.62	2.39999G	-24.20	2.4G	-25.22	2.49295G	-51.04	6.78346G	-46.22	1
2440MHz	Pass	2.47999G	9.03	-20.97	948.85M	-51.37	2.39833G	-51.29	2.4835G	-54.18	2.49426G	-51.48	6.99436G	-45.20	1
2480MHz	Pass	2.47999G	9.03	-20.97	890.69M	-52.44	2.39361G	-51.61	2.4835G	-53.09	2.48381G	-51.32	24.46008G	-45.66	1

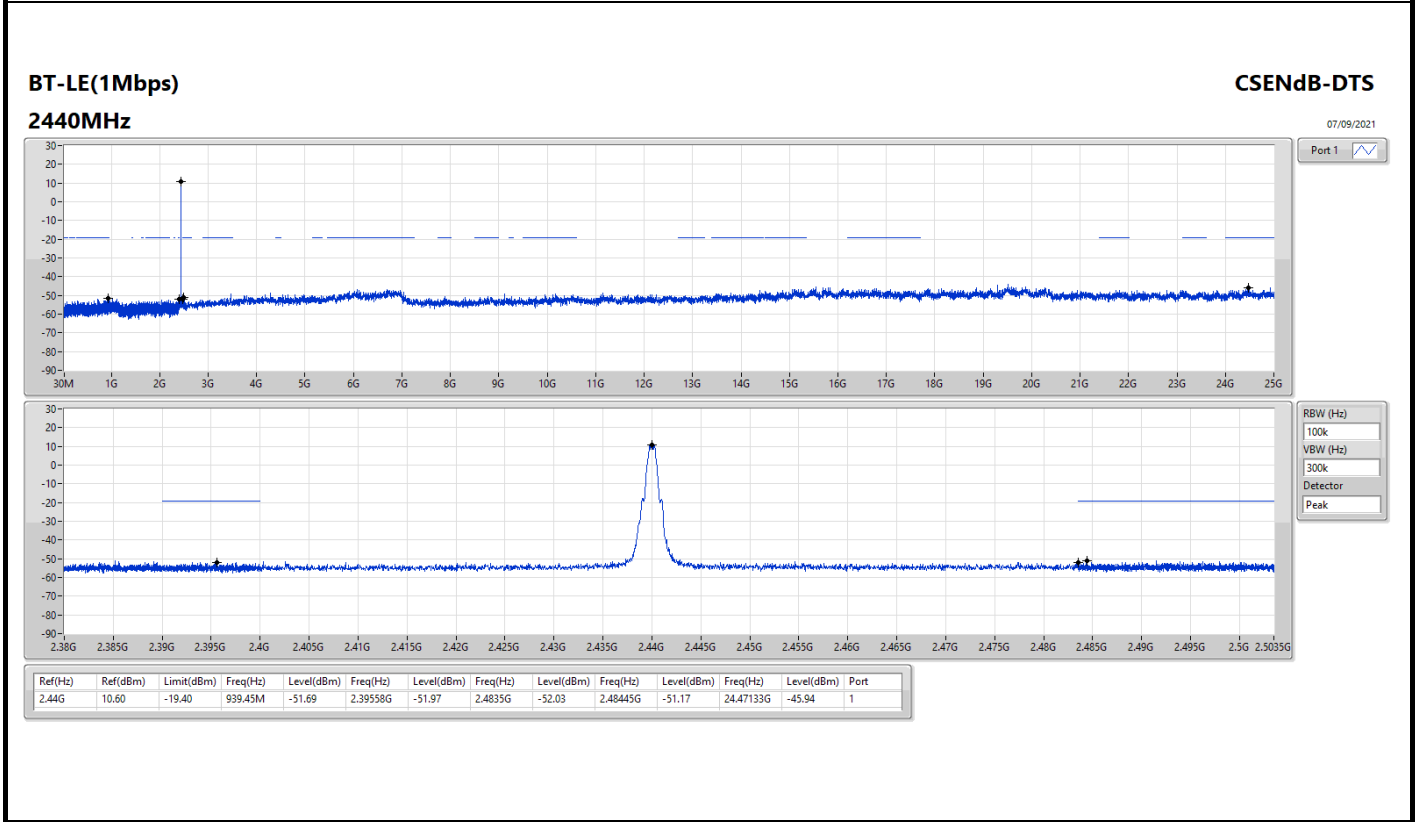
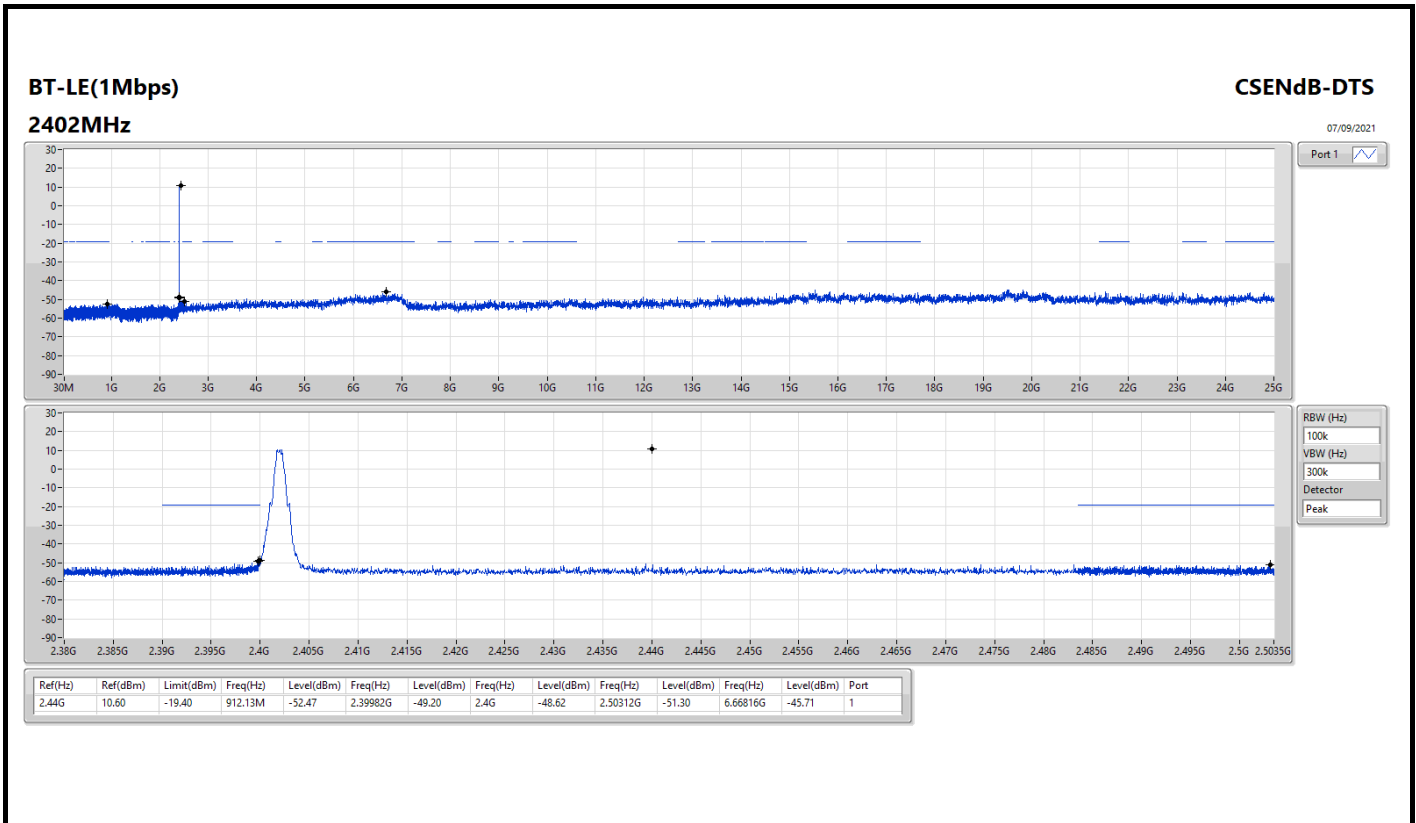

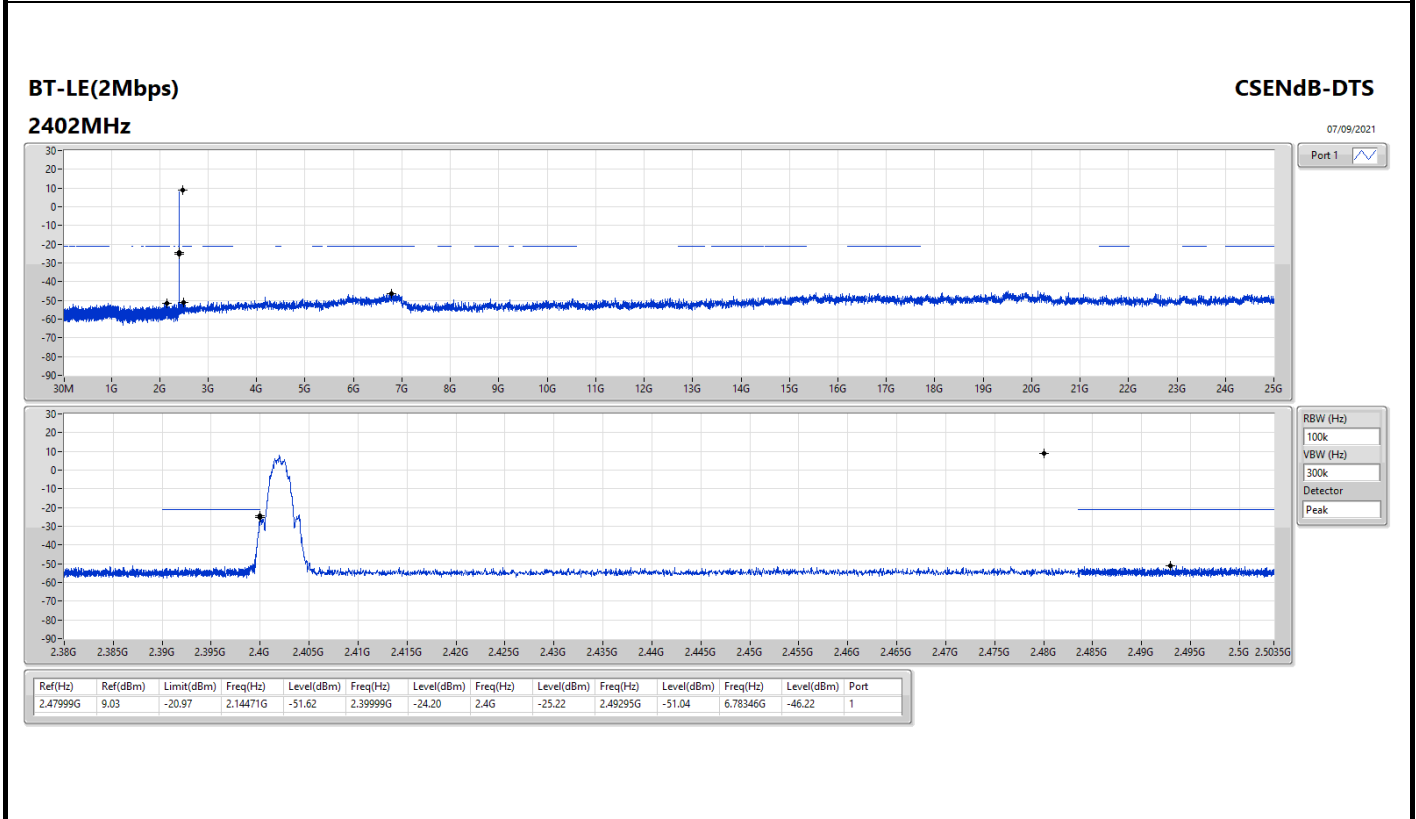
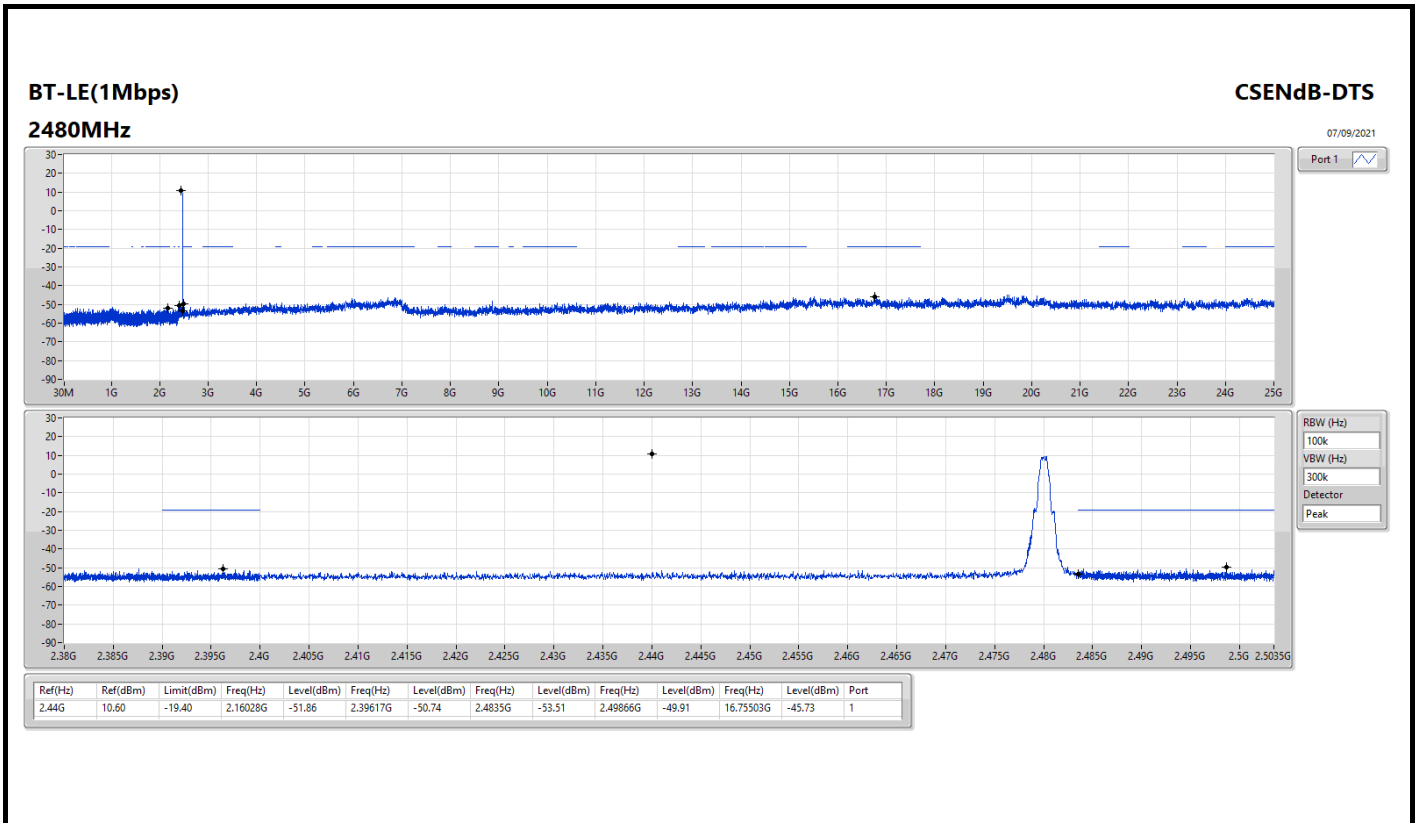

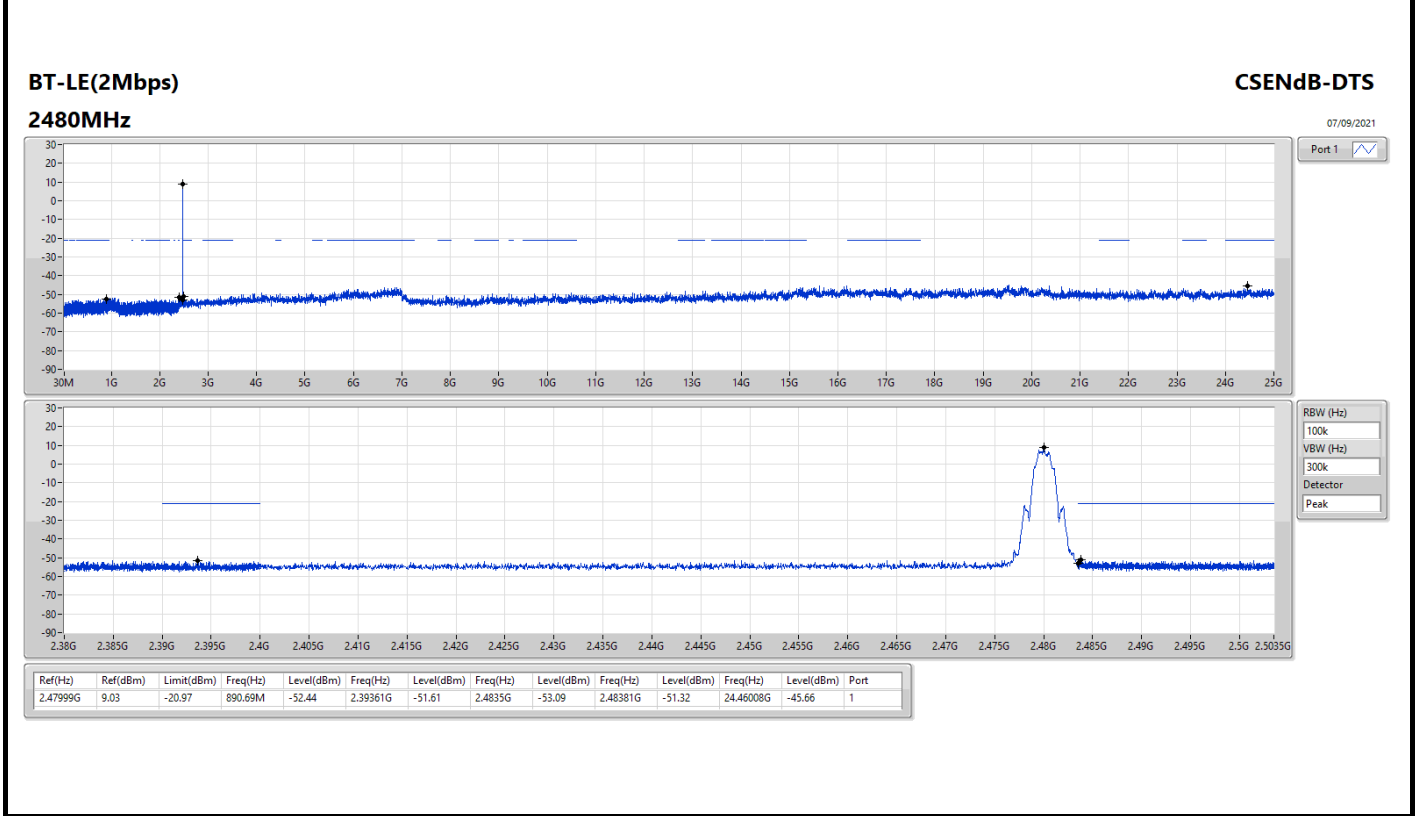
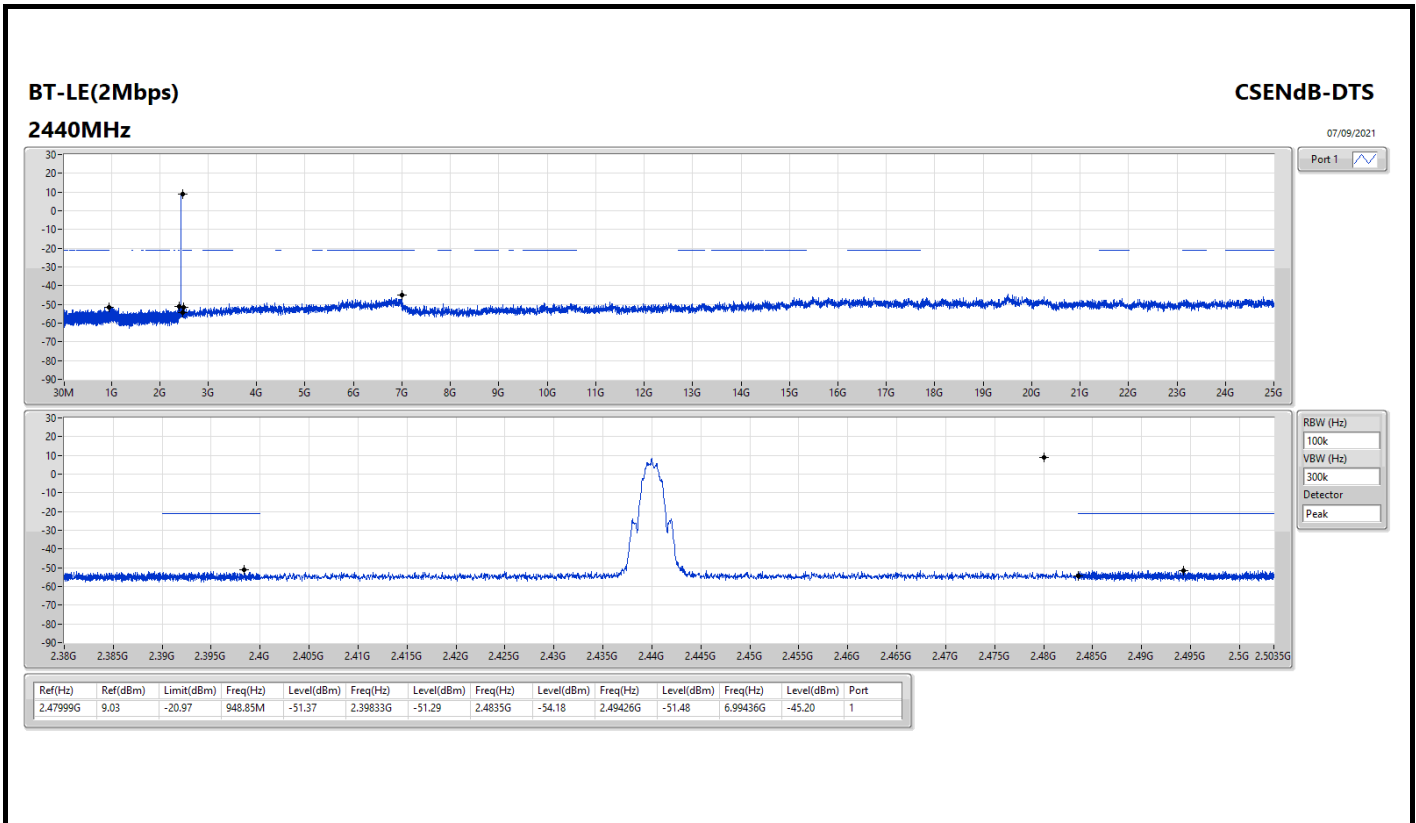



**Summary**

Mode	Result	Type	Freq (Hz)	Level (dBuV/m)	Limit (dBuV/m)	Margin (dB)	Condition
Mode 2	Pass	PK	730M	42.85	46.00	-3.15	Vertical

07/09/2021

Mode 2

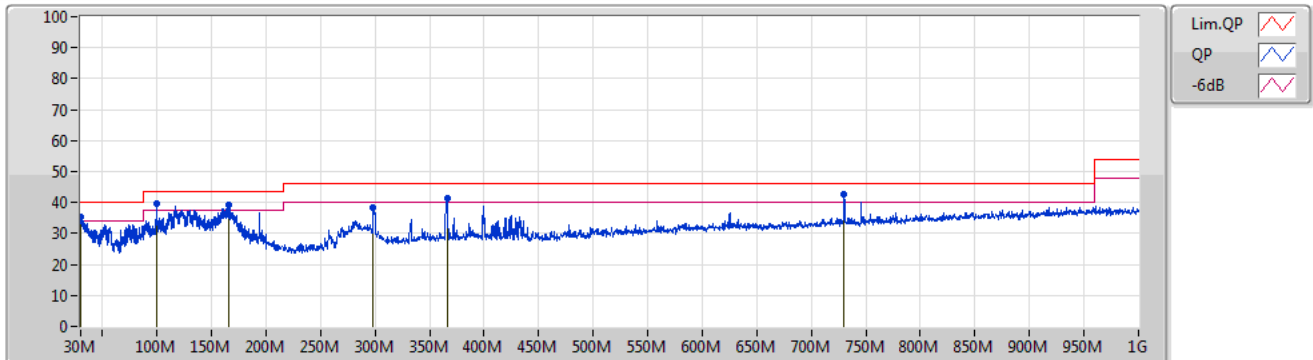

Type	Freq (Hz)	Level (dBuV/m)	Limit (dBuV/m)	Margin (dB)	Factor (dB)	Dist (m)	Condition	Azimuth (°)	Height (m)	Comment	Raw (dBuV)	AF (dB)	CL (dB)	PA (dB)
PK	30.51M	35.21	40.00	-4.79	-3.21	3	Vertical	318	2.00	-	38.42	23.65	1.02	27.88
PK	99.53M	39.77	43.50	-3.73	-8.53	3	Vertical	346	1.00	-	48.30	16.89	2.39	27.81
PK	166M	39.18	43.50	-4.32	-8.41	3	Vertical	178	1.00	-	47.59	15.78	3.29	27.48
PK	298.4M	38.56	46.00	-7.44	-9.38	3	Vertical	0	2.00	-	47.94	13.20	3.79	26.37
PK	366.4M	41.47	46.00	-4.53	-7.49	3	Vertical	337	3.00	-	48.96	15.38	4.17	27.04
PK	730M	42.85	46.00	-3.15	-1.00	3	Vertical	270	1.00	"Worst"	43.85	20.70	5.92	27.62

07/09/2021

Mode 2

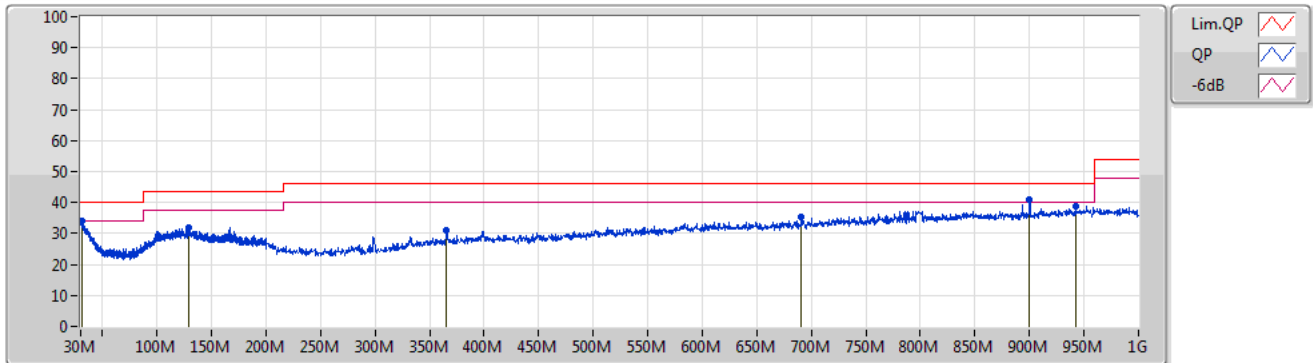

Type	Freq (Hz)	Level (dBuV/m)	Limit (dBuV/m)	Margin (dB)	Factor (dB)	Dist (m)	Condition	Azimuth (°)	Height (m)	Comment	Raw (dBuV)	AF (dB)	CL (dB)	PA (dB)
PK	31.02M	34.07	40.00	-5.93	-3.35	3	Horizontal	236	4.00	-	37.42	23.50	1.04	27.89
PK	129.45M	31.96	43.50	-11.54	-6.83	3	Horizontal	160	1.00	-	38.79	17.92	2.84	27.59
PK	365.2M	30.92	46.00	-15.08	-7.51	3	Horizontal	125	4.00	-	38.43	15.36	4.16	27.03
PK	690.8M	35.25	46.00	-10.75	-2.05	3	Horizontal	14	1.00	-	37.30	19.86	5.76	27.67
PK	900M	40.77	46.00	-5.23	1.60	3	Horizontal	241	1.00	"Worst"	39.17	21.64	6.60	26.64
PK	942.4M	38.80	46.00	-7.20	2.74	3	Horizontal	19	3.00	-	36.06	22.19	6.94	26.39





Summary

Mode	Result	Type	Freq (Hz)	Level (dBuV/m)	Limit (dBuV/m)	Margin (dB)	Dist (m)	Condition	Azimuth (°)	Height (m)	Comments
2.4-2.4835GHz	-	-	-	-	-	-	-	-	-	-	-
BT-LE(2Mbps)	Pass	AV	2.4835G	51.37	54.00	-2.63	3	Vertical	344	1.06	-

### BT-LE(1Mbps)

### 2402MHz\_TX

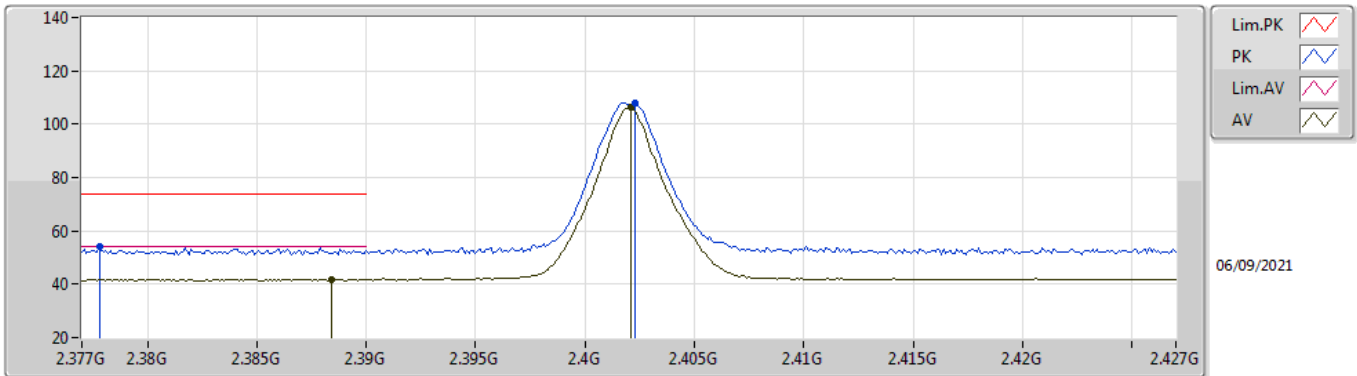

EUT Y\_1TX  
Setting Default  
01-A-B-2

Type	Freq (Hz)	Level (dBuV/m)	Limit (dBuV/m)	Margin (dB)	Raw (dBuV)	Dist (m)	Condition	Azimuth (°)	Height (m)	Comment	AF (dB)	CL (dB)	PA (dB)
PK	2.3778G	53.90	74.00	-20.10	24.36	3	Vertical	356	1.13	-	27.36	2.18	-
AV	2.3884G	41.96	54.00	-12.04	12.39	3	Vertical	356	1.13	-	27.38	2.19	-
PK	2.4023G	107.86	Inf	-Inf	78.26	3	Vertical	356	1.13	-	27.40	2.20	-
AV	2.4021G	106.38	Inf	-Inf	76.78	3	Vertical	356	1.13	-	27.40	2.20	-

### BT-LE(1Mbps)

### 2402MHz\_TX

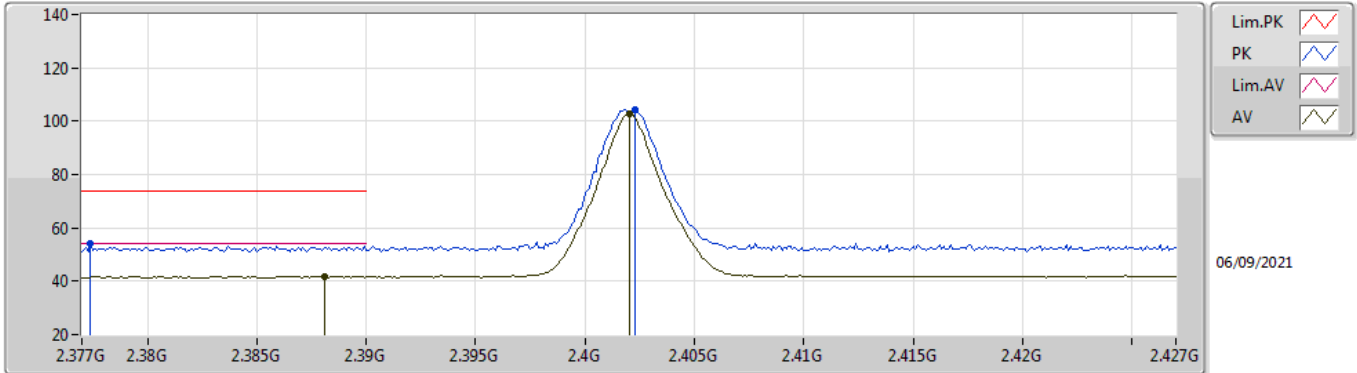

EUT Y\_1TX  
Setting Default  
01-A-B-2

Type	Freq (Hz)	Level (dBuV/m)	Limit (dBuV/m)	Margin (dB)	Raw (dBuV)	Dist (m)	Condition	Azimuth (°)	Height (m)	Comment	AF (dB)	CL (dB)	PA (dB)
PK	2.3774G	53.93	74.00	-20.07	24.40	3	Horizontal	305	1.57	-	27.35	2.18	-
AV	2.3881G	41.93	54.00	-12.07	12.36	3	Horizontal	305	1.57	-	27.38	2.19	-
PK	2.4023G	104.13	Inf	-Inf	74.53	3	Horizontal	305	1.57	-	27.40	2.20	-
AV	2.402G	102.64	Inf	-Inf	73.04	3	Horizontal	305	1.57	-	27.40	2.20	-

### BT-LE(1Mbps)

### 2402MHz\_TX

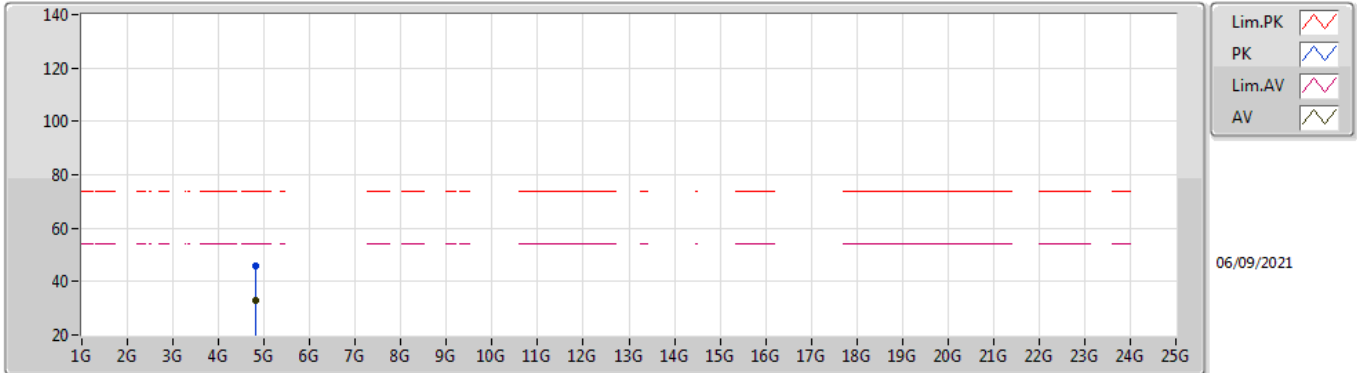

EUT Y\_1TX  
Setting Default  
01-A-B-2

Type	Freq (Hz)	Level (dBuV/m)	Limit (dBuV/m)	Margin (dB)	Raw (dBuV)	Dist (m)	Condition	Azimuth (°)	Height (m)	Comment	AF (dB)	CL (dB)	PA (dB)
PK	4.80496G	45.65	74.00	-28.35	41.51	3	Vertical	206	2.28	-	32.13	5.00	32.99
AV	4.80056G	33.11	54.00	-20.89	29.00	3	Vertical	206	2.28	-	32.10	5.00	32.99

### BT-LE(1Mbps)

### 2402MHz\_TX

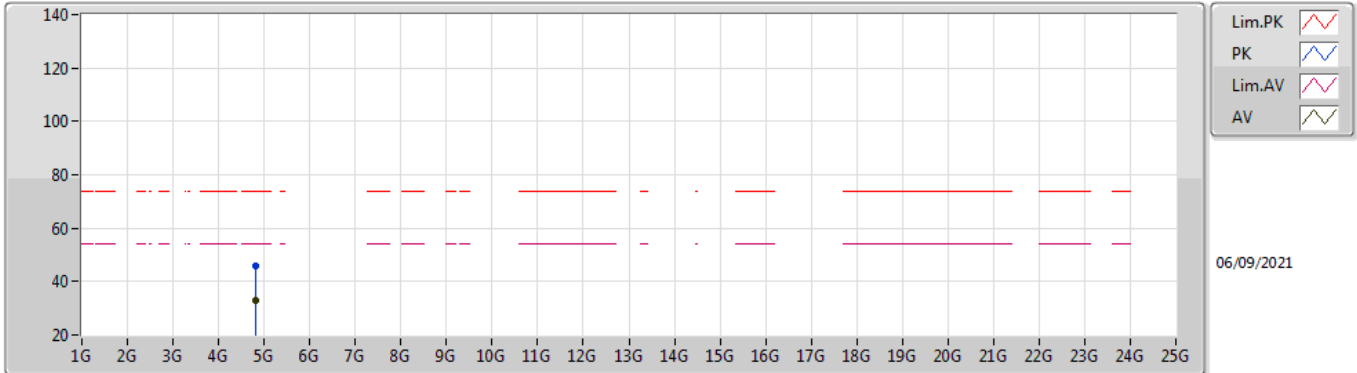

EUT Y\_1TX  
Setting Default  
01-A-B-2

Type	Freq (Hz)	Level (dBuV/m)	Limit (dBuV/m)	Margin (dB)	Raw (dBuV)	Dist (m)	Condition	Azimuth (°)	Height (m)	Comment	AF (dB)	CL (dB)	PA (dB)
PK	4.80886G	45.85	74.00	-28.15	41.69	3	Horizontal	358	1.79	-	32.15	5.00	32.99
AV	4.80438G	33.12	54.00	-20.88	28.98	3	Horizontal	358	1.79	-	32.13	5.00	32.99

**BT-LE(1Mbps)**

**2440MHz\_TX**

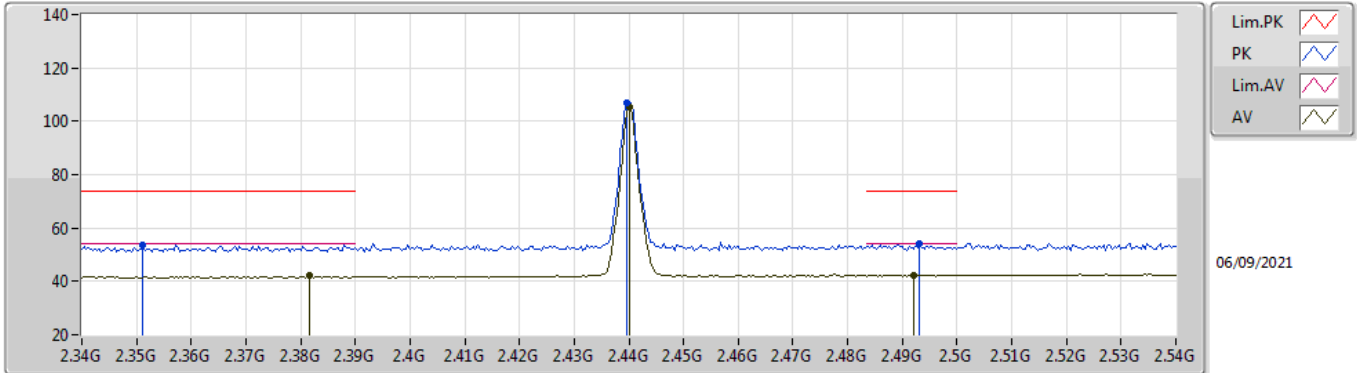

EUT\_V\_1TX  
Setting Default  
01-A-B-2

Type	Freq (Hz)	Level (dBuV/m)	Limit (dBuV/m)	Margin (dB)	Raw (dBuV)	Dist (m)	Condition	Azimuth (°)	Height (m)	Comment	AF (dB)	CL (dB)	PA (dB)
PK	2.3512G	53.51	74.00	-20.49	24.06	3	Vertical	343	2.51	-	27.30	2.15	-
AV	2.3816G	42.05	54.00	-11.95	12.51	3	Vertical	343	2.51	-	27.36	2.18	-
PK	2.4396G	107.03	Inf	-Inf	77.31	3	Vertical	343	2.51	-	27.48	2.24	-
AV	2.44G	105.56	Inf	-Inf	75.84	3	Vertical	343	2.51	-	27.48	2.24	-
PK	2.4932G	54.11	74.00	-19.89	24.06	3	Vertical	343	2.51	-	27.76	2.29	-
AV	2.492G	42.40	54.00	-11.60	12.36	3	Vertical	343	2.51	-	27.75	2.29	-

**BT-LE(1Mbps)**

**2440MHz\_TX**

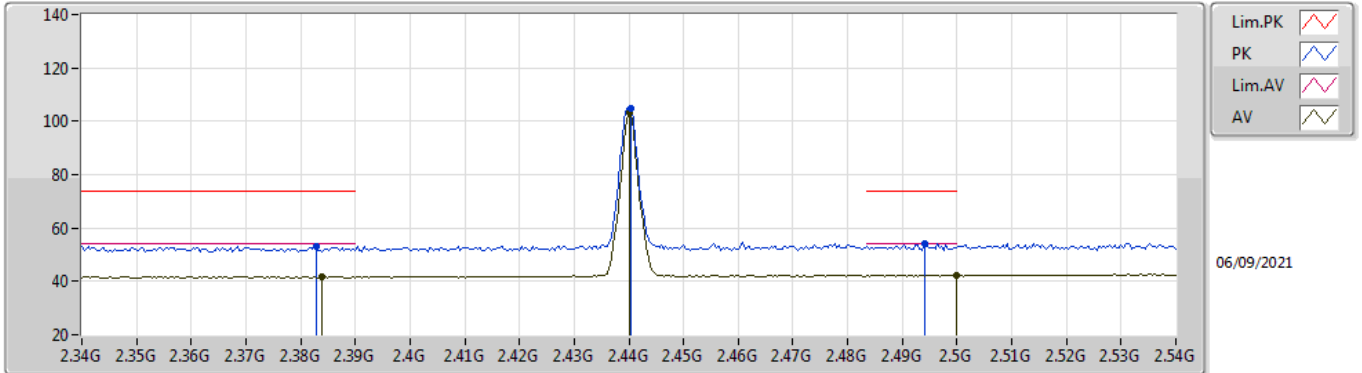

EUT\_V\_1TX  
Setting Default  
01-A-B-2

Type	Freq (Hz)	Level (dBuV/m)	Limit (dBuV/m)	Margin (dB)	Raw (dBuV)	Dist (m)	Condition	Azimuth (°)	Height (m)	Comment	AF (dB)	CL (dB)	PA (dB)
PK	2.3828G	53.33	74.00	-20.67	23.78	3	Horizontal	306	1.71	-	27.37	2.18	-
AV	2.384G	41.82	54.00	-12.18	12.27	3	Horizontal	306	1.71	-	27.37	2.18	-
PK	2.4404G	104.60	Inf	-Inf	74.88	3	Horizontal	306	1.71	-	27.48	2.24	-
AV	2.44G	103.09	Inf	-Inf	73.37	3	Horizontal	306	1.71	-	27.48	2.24	-
PK	2.494G	54.18	74.00	-19.82	24.13	3	Horizontal	306	1.71	-	27.76	2.29	-
AV	2.5G	42.35	54.00	-11.65	12.25	3	Horizontal	306	1.71	-	27.80	2.30	-

### BT-LE(1Mbps)

### 2440MHz\_TX

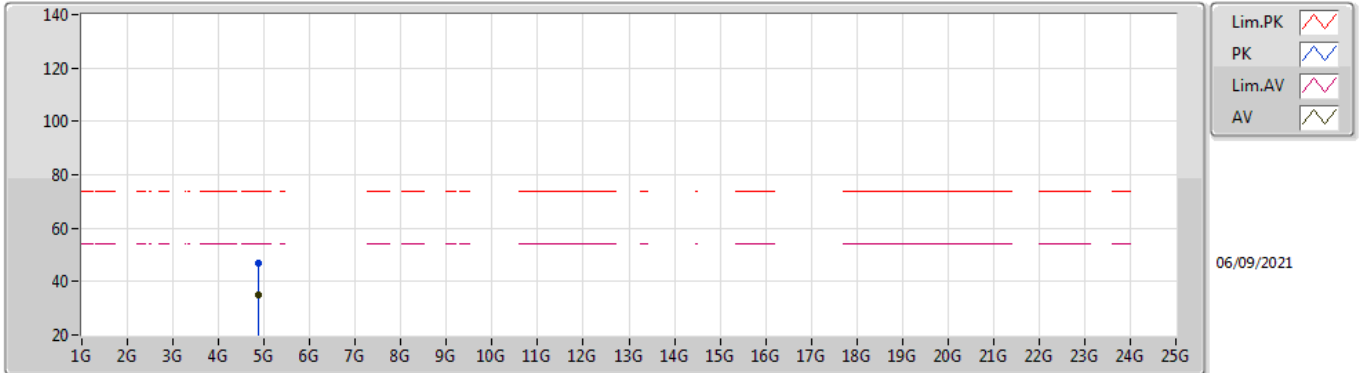

EUT Y\_1TX  
Setting Default  
01-A-B-2

Type	Freq (Hz)	Level (dBuV/m)	Limit (dBuV/m)	Margin (dB)	Raw (dBuV)	Dist (m)	Condition	Azimuth (°)	Height (m)	Comment	AF (dB)	CL (dB)	PA (dB)
PK	4.87966G	46.68	74.00	-27.32	42.16	3	Vertical	342	1.00	-	32.46	5.04	32.98
AV	4.88024G	34.79	54.00	-19.21	30.27	3	Vertical	342	1.00	-	32.46	5.04	32.98



### BT-LE(1Mbps)

### 2440MHz\_TX

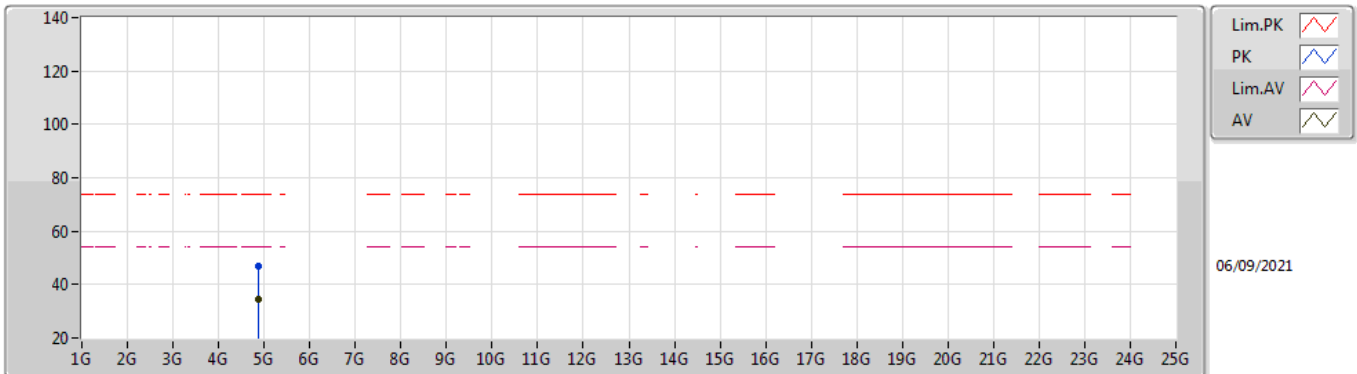

EUT Y\_1TX  
Setting Default  
01-A-B-2

Type	Freq (Hz)	Level (dBuV/m)	Limit (dBuV/m)	Margin (dB)	Raw (dBuV)	Dist (m)	Condition	Azimuth (°)	Height (m)	Comment	AF (dB)	CL (dB)	PA (dB)
PK	4.88252G	46.77	74.00	-27.23	42.24	3	Horizontal	182	1.81	-	32.47	5.04	32.98
AV	4.8796G	34.55	54.00	-19.45	30.03	3	Horizontal	182	1.81	-	32.46	5.04	32.98

### BT-LE(1Mbps)

### 2480MHz\_TX

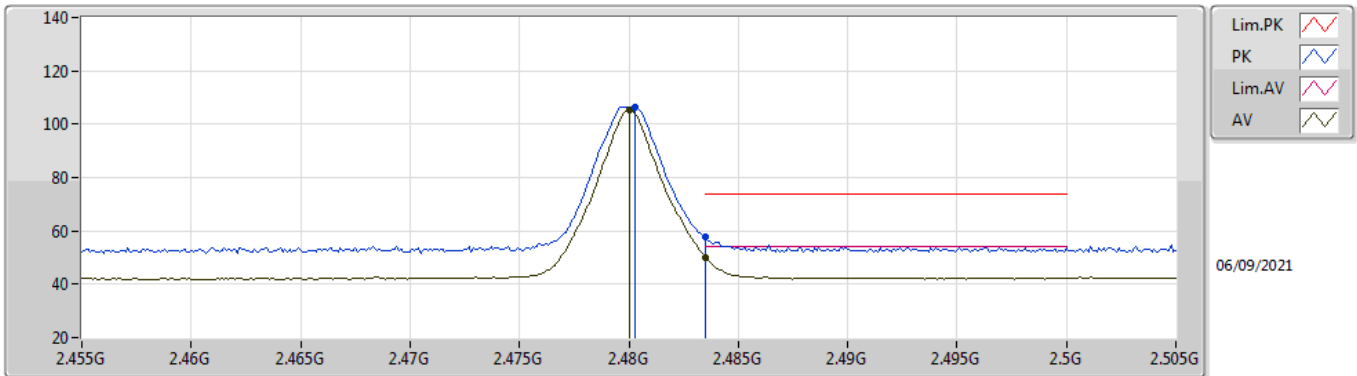

EUT Y\_1TX  
Setting Default  
01-A-B-2

Type	Freq (Hz)	Level (dBuV/m)	Limit (dBuV/m)	Margin (dB)	Raw (dBuV)	Dist (m)	Condition	Azimuth (°)	Height (m)	Comment	AF (dB)	CL (dB)	PA (dB)
PK	2.4803G	106.63	Inf	-Inf	76.67	3	Vertical	336	2.75	-	27.68	2.28	-
AV	2.48G	105.19	Inf	-Inf	75.23	3	Vertical	336	2.75	-	27.68	2.28	-
PK	2.4835G	57.58	74.00	-16.42	27.60	3	Vertical	336	2.75	-	27.70	2.28	-
AV	2.4835G	50.15	54.00	-3.85	20.17	3	Vertical	336	2.75	-	27.70	2.28	-

### BT-LE(1Mbps)

### 2480MHz\_TX

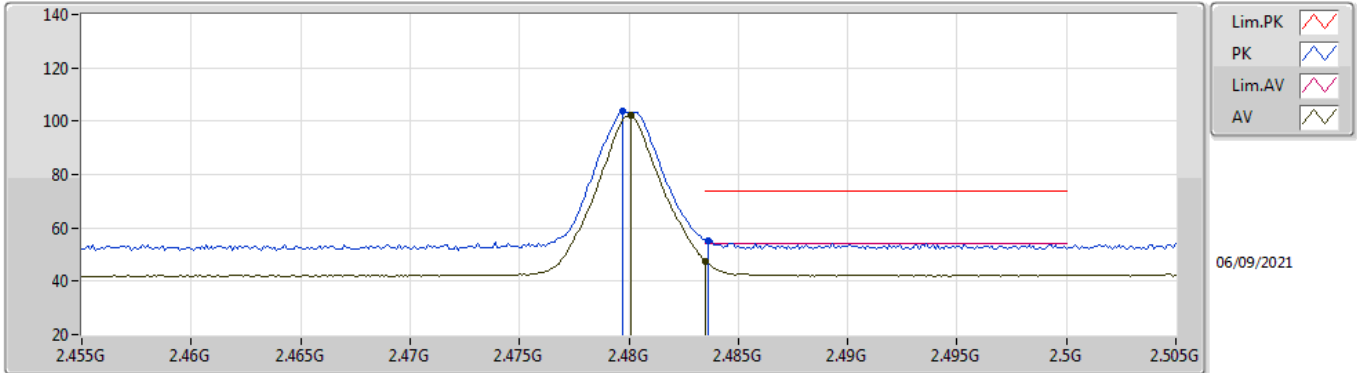

EUT V\_1TX  
Setting Default  
01-A-B-2

Type	Freq (Hz)	Level (dBuV/m)	Limit (dBuV/m)	Margin (dB)	Raw (dBuV)	Dist (m)	Condition	Azimuth (°)	Height (m)	Comment	AF (dB)	CL (dB)	PA (dB)
PK	2.4797G	103.61	Inf	-Inf	73.65	3	Horizontal	308	1.53	-	27.68	2.28	-
AV	2.4801G	102.09	Inf	-Inf	72.13	3	Horizontal	308	1.53	-	27.68	2.28	-
PK	2.4836G	55.22	74.00	-18.78	25.24	3	Horizontal	308	1.53	-	27.70	2.28	-
AV	2.4835G	47.43	54.00	-6.57	17.45	3	Horizontal	308	1.53	-	27.70	2.28	-

### BT-LE(1Mbps)

### 2480MHz\_TX

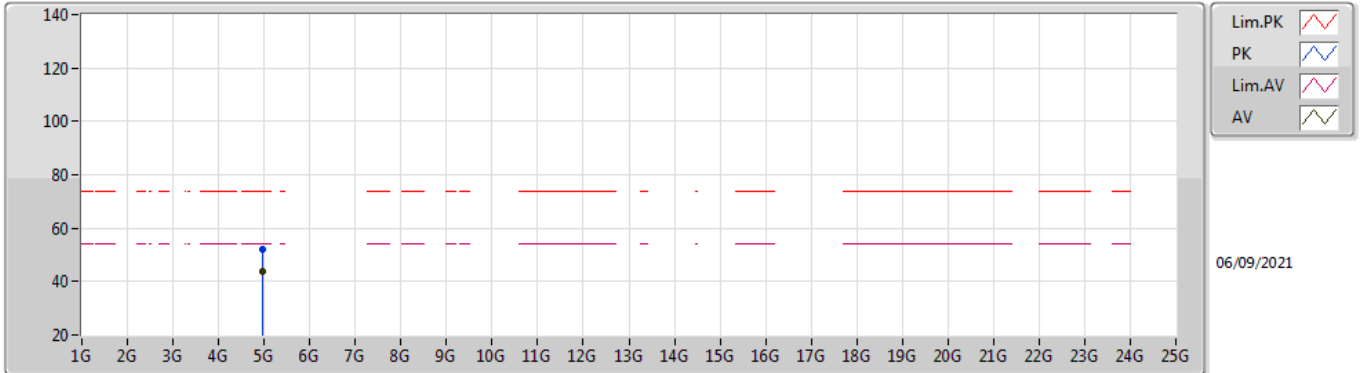

EUT Y\_1TX  
Setting Default  
01-A-B-2

Type	Freq (Hz)	Level (dBuV/m)	Limit (dBuV/m)	Margin (dB)	Raw (dBuV)	Dist (m)	Condition	Azimuth (°)	Height (m)	Comment	AF (dB)	CL (dB)	PA (dB)
PK	4.96036G	52.27	74.00	-21.73	47.38	3	Vertical	23	1.13	-	32.78	5.08	32.97
AV	4.96012G	44.02	54.00	-9.98	39.13	3	Vertical	23	1.13	-	32.78	5.08	32.97

### BT-LE(1Mbps)

### 2480MHz\_TX

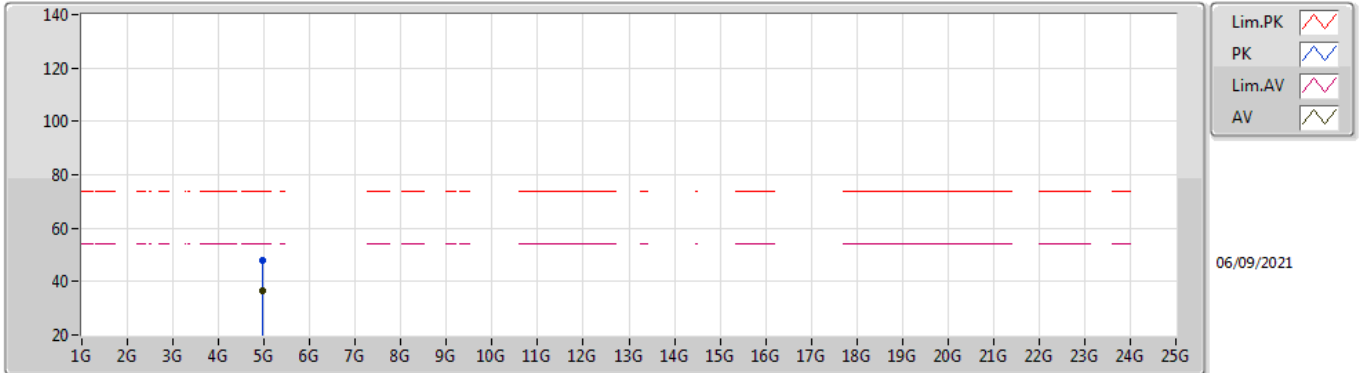

EUT Y\_1TX  
Setting Default  
01-A-B-2

Type	Freq (Hz)	Level (dBuV/m)	Limit (dBuV/m)	Margin (dB)	Raw (dBuV)	Dist (m)	Condition	Azimuth (°)	Height (m)	Comment	AF (dB)	CL (dB)	PA (dB)
PK	4.96042G	48.04	74.00	-25.96	43.15	3	Horizontal	19	2.45	-	32.78	5.08	32.97
AV	4.95956G	36.48	54.00	-17.52	31.59	3	Horizontal	19	2.45	-	32.78	5.08	32.97

### BT-LE(2Mbps)

### 2402MHz\_TX

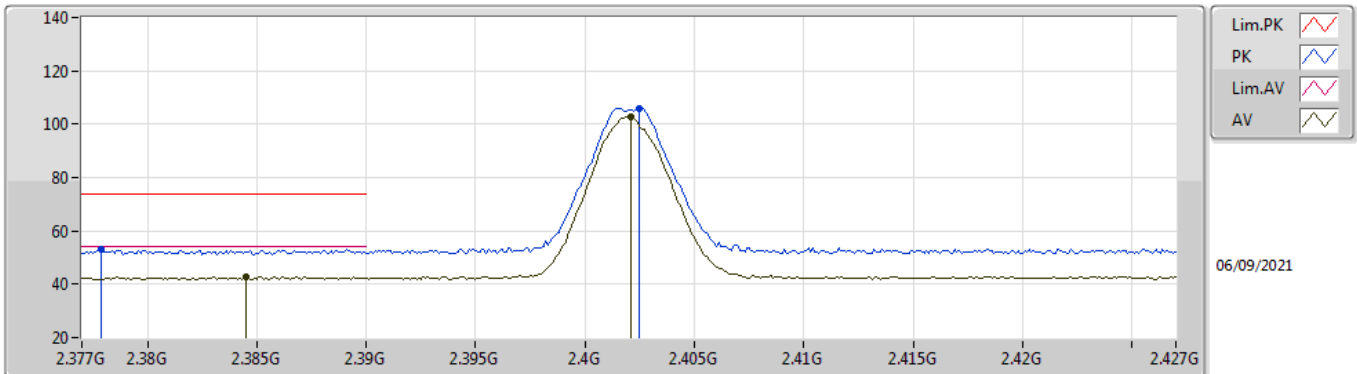

EUT Y\_1TX  
Setting Default  
01-A-B-2

Type	Freq (Hz)	Level (dBuV/m)	Limit (dBuV/m)	Margin (dB)	Raw (dBuV)	Dist (m)	Condition	Azimuth (°)	Height (m)	Comment	AF (dB)	CL (dB)	PA (dB)
PK	2.3779G	53.02	74.00	-20.98	23.48	3	Vertical	358	1.15	-	27.36	2.18	-
AV	2.3845G	42.75	54.00	-11.25	13.20	3	Vertical	358	1.15	-	27.37	2.18	-
PK	2.4025G	105.94	Inf	-Inf	76.34	3	Vertical	358	1.15	-	27.40	2.20	-
AV	2.4021G	102.90	Inf	-Inf	73.30	3	Vertical	358	1.15	-	27.40	2.20	-

### BT-LE(2Mbps)

### 2402MHz\_TX

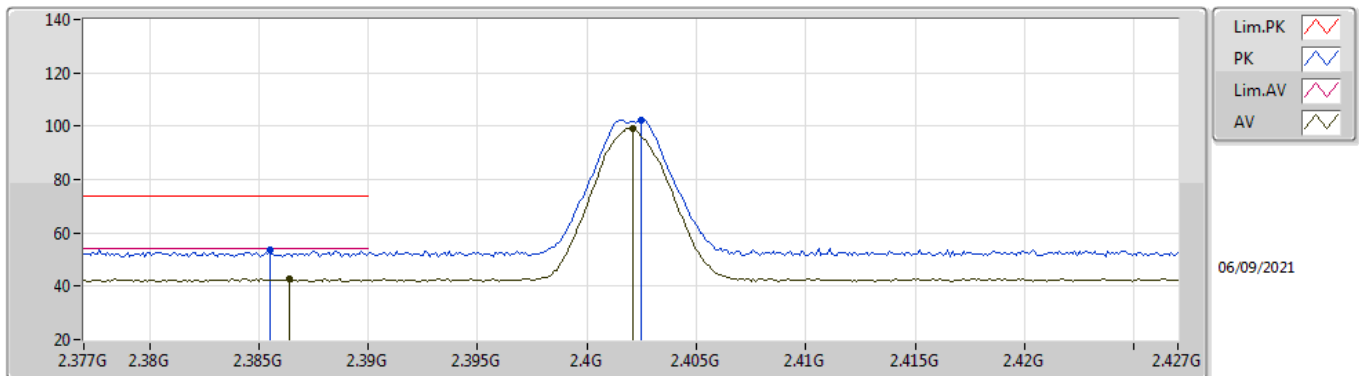

EUT Y\_1TX  
Setting Default  
01-A-B-2

Type	Freq (Hz)	Level (dBuV/m)	Limit (dBuV/m)	Margin (dB)	Raw (dBuV)	Dist (m)	Condition	Azimuth (°)	Height (m)	Comment	AF (dB)	CL (dB)	PA (dB)
PK	2.3855G	53.53	74.00	-20.47	23.97	3	Horizontal	306	1.41	-	27.37	2.19	-
AV	2.3864G	42.71	54.00	-11.29	13.15	3	Horizontal	306	1.41	-	27.37	2.19	-
PK	2.4025G	102.39	Inf	-Inf	72.79	3	Horizontal	306	1.41	-	27.40	2.20	-
AV	2.4021G	99.26	Inf	-Inf	69.66	3	Horizontal	306	1.41	-	27.40	2.20	-

**BT-LE(2Mbps)**

**2402MHz\_TX**

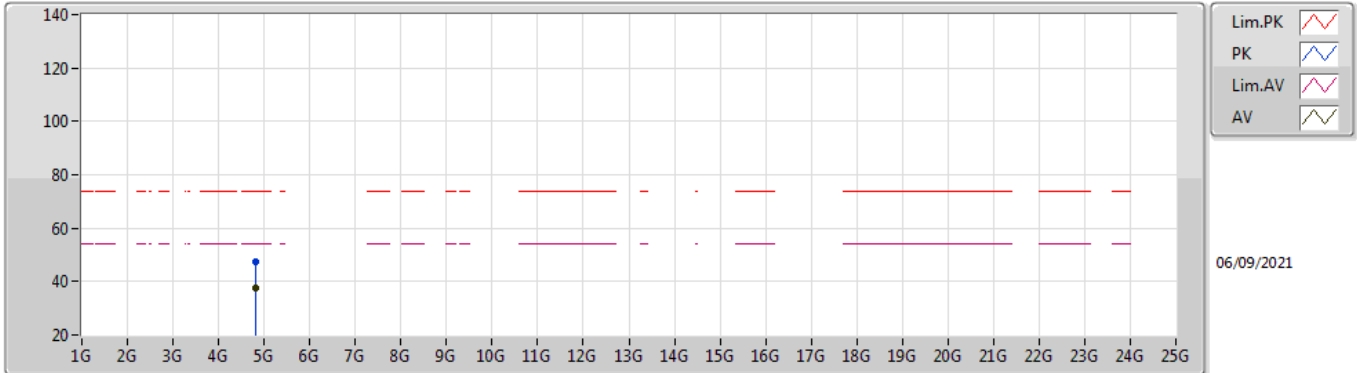

EUT Y\_1TX  
Setting Default  
01-A-B-2

Type	Freq (Hz)	Level (dBuV/m)	Limit (dBuV/m)	Margin (dB)	Raw (dBuV)	Dist (m)	Condition	Azimuth (°)	Height (m)	Comment	AF (dB)	CL (dB)	PA (dB)
PK	4.80482G	47.36	74.00	-26.64	43.22	3	Vertical	22	1.00	-	32.13	5.00	32.99
AV	4.803G	37.69	54.00	-16.31	33.56	3	Vertical	22	1.00	-	32.12	5.00	32.99



**BT-LE(2Mbps)**

**2402MHz\_TX**

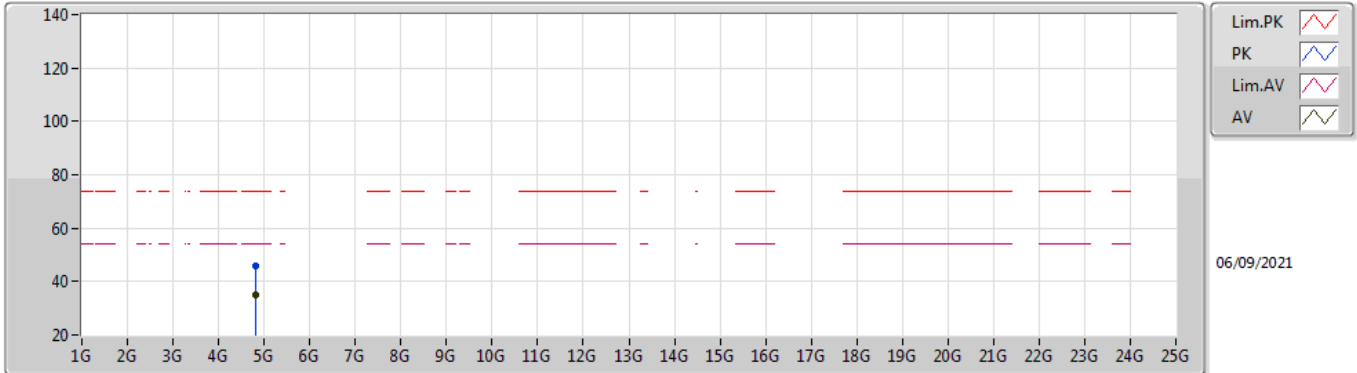

EUT Y\_1TX  
Setting Default  
01-A-B-2

Type	Freq (Hz)	Level (dBuV/m)	Limit (dBuV/m)	Margin (dB)	Raw (dBuV)	Dist (m)	Condition	Azimuth (°)	Height (m)	Comment	AF (dB)	CL (dB)	PA (dB)
PK	4.80292G	45.94	74.00	-28.06	41.81	3	Horizontal	307	1.94	-	32.12	5.00	32.99
AV	4.8004G	35.05	54.00	-18.95	30.94	3	Horizontal	307	1.94	-	32.10	5.00	32.99

**BT-LE(2Mbps)**

**2440MHz\_TX**

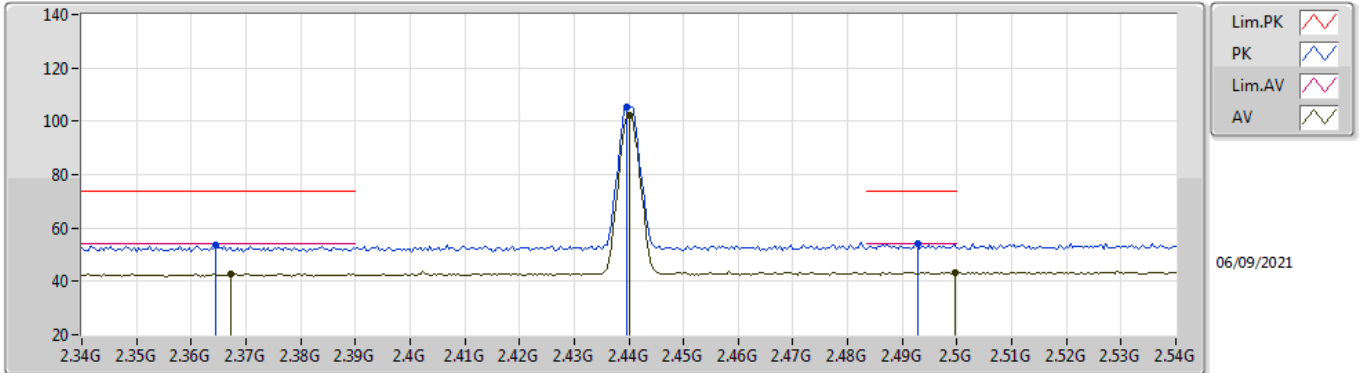

EUT\_V\_1TX  
Setting Default  
01-A-B-2

Type	Freq (Hz)	Level (dBuV/m)	Limit (dBuV/m)	Margin (dB)	Raw (dBuV)	Dist (m)	Condition	Azimuth (°)	Height (m)	Comment	AF (dB)	CL (dB)	PA (dB)
PK	2.3644G	53.48	74.00	-20.52	23.99	3	Vertical	344	1.00	-	27.33	2.16	-
AV	2.3672G	42.87	54.00	-11.13	13.37	3	Vertical	344	1.00	-	27.33	2.17	-
PK	2.4396G	105.52	Inf	-Inf	75.80	3	Vertical	344	1.00	-	27.48	2.24	-
AV	2.44G	102.44	Inf	-Inf	72.72	3	Vertical	344	1.00	-	27.48	2.24	-
PK	2.4928G	54.29	74.00	-19.71	24.24	3	Vertical	344	1.00	-	27.76	2.29	-
AV	2.4996G	43.29	54.00	-10.71	13.19	3	Vertical	344	1.00	-	27.80	2.30	-

**BT-LE(2Mbps)**

**2440MHz\_TX**

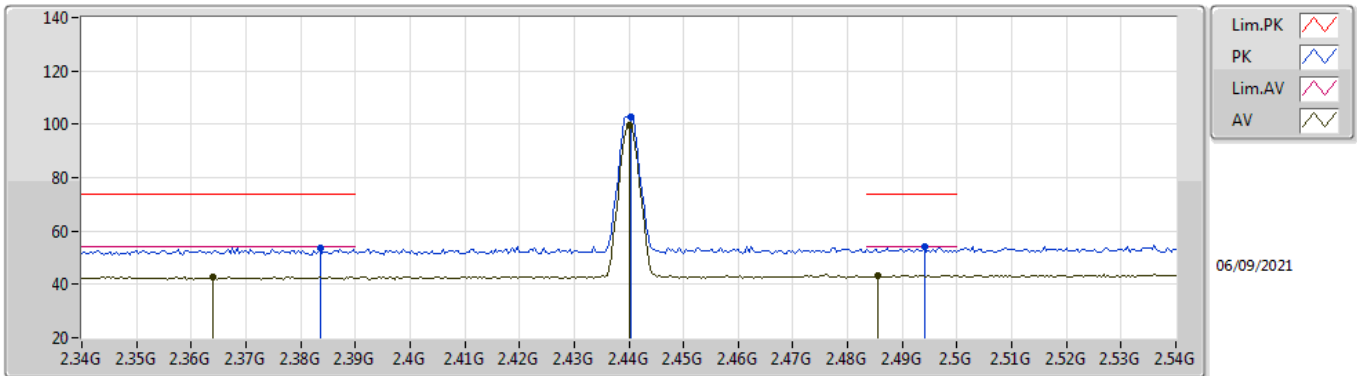

EUT\_V\_1TX  
Setting Default  
01-A-B-2

Type	Freq (Hz)	Level (dBuV/m)	Limit (dBuV/m)	Margin (dB)	Raw (dBuV)	Dist (m)	Condition	Azimuth (°)	Height (m)	Comment	AF (dB)	CL (dB)	PA (dB)
PK	2.3836G	53.74	74.00	-20.26	24.19	3	Horizontal	308	1.72	-	27.37	2.18	-
AV	2.364G	42.81	54.00	-11.19	13.32	3	Horizontal	308	1.72	-	27.33	2.16	-
PK	2.4404G	102.87	Inf	-Inf	73.15	3	Horizontal	308	1.72	-	27.48	2.24	-
AV	2.44G	99.76	Inf	-Inf	70.04	3	Horizontal	308	1.72	-	27.48	2.24	-
PK	2.494G	54.27	74.00	-19.73	24.22	3	Horizontal	308	1.72	-	27.76	2.29	-
AV	2.4856G	43.37	54.00	-10.63	13.37	3	Horizontal	308	1.72	-	27.71	2.29	-

### BT-LE(2Mbps)

### 2440MHz\_TX

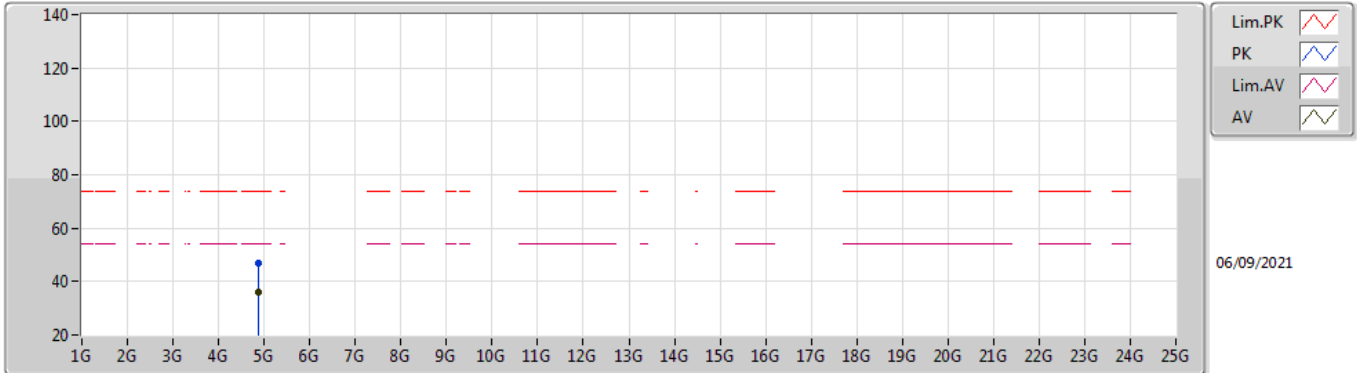

EUT Y\_1TX  
Setting Default  
01-A-B-2

Type	Freq (Hz)	Level (dBuV/m)	Limit (dBuV/m)	Margin (dB)	Raw (dBuV)	Dist (m)	Condition	Azimuth (°)	Height (m)	Comment	AF (dB)	CL (dB)	PA (dB)
PK	4.8832G	47.14	74.00	-26.86	42.61	3	Vertical	0	1.76	-	32.47	5.04	32.98
AV	4.8785G	35.84	54.00	-18.16	31.32	3	Vertical	0	1.76	-	32.46	5.04	32.98

**BT-LE(2Mbps)**

**2440MHz\_TX**

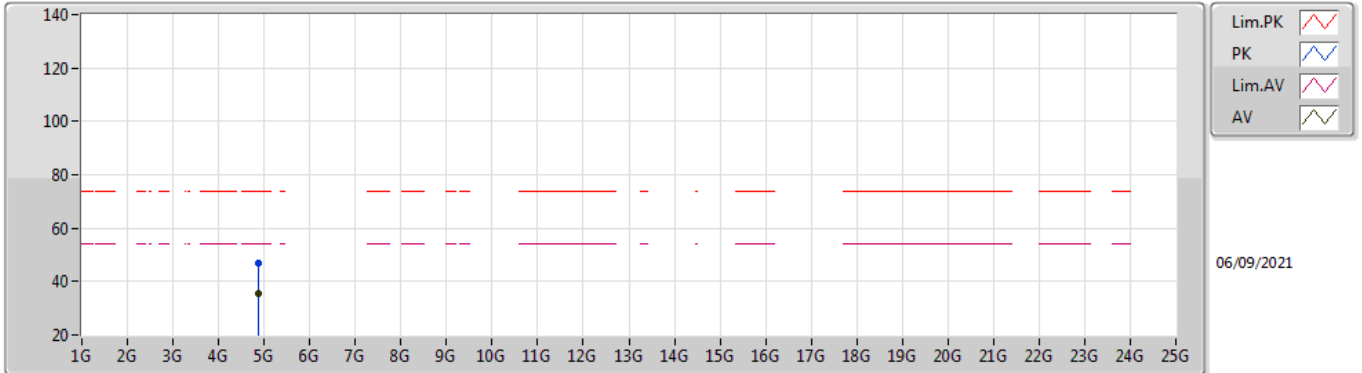

EUT Y\_1TX  
Setting Default  
01-A-B-2

Type	Freq (Hz)	Level (dBuV/m)	Limit (dBuV/m)	Margin (dB)	Raw (dBuV)	Dist (m)	Condition	Azimuth (°)	Height (m)	Comment	AF (dB)	CL (dB)	PA (dB)
PK	4.87536G	46.87	74.00	-27.13	42.36	3	Horizontal	94	1.80	-	32.45	5.04	32.98
AV	4.8843G	35.47	54.00	-18.53	30.94	3	Horizontal	94	1.80	-	32.47	5.04	32.98

### BT-LE(2Mbps)

### 2480MHz\_TX

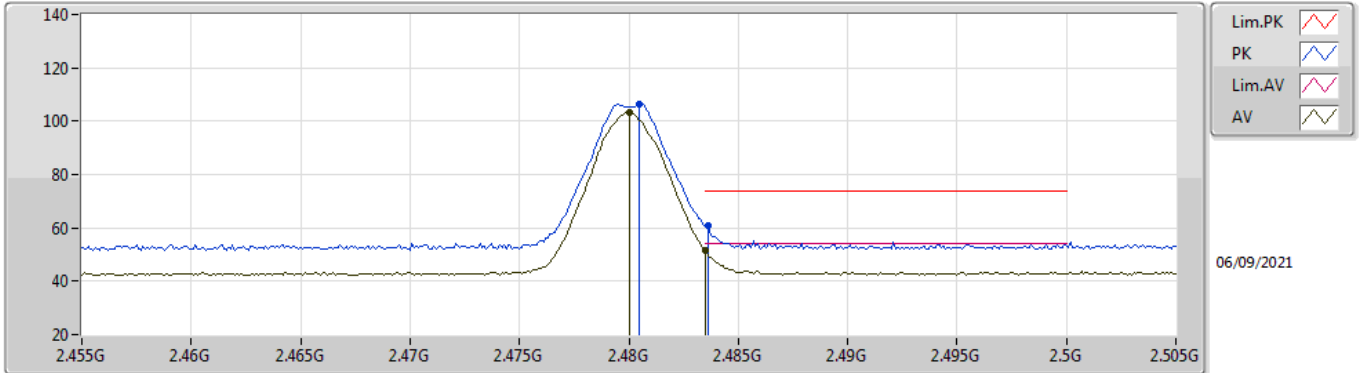

EUT\_V\_1TX  
Setting Default  
01-A-B-2

Type	Freq (Hz)	Level (dBuV/m)	Limit (dBuV/m)	Margin (dB)	Raw (dBuV)	Dist (m)	Condition	Azimuth (°)	Height (m)	Comment	AF (dB)	CL (dB)	PA (dB)
PK	2.4805G	106.22	Inf	-Inf	76.26	3	Vertical	344	1.06	-	27.68	2.28	-
AV	2.48G	103.20	Inf	-Inf	73.24	3	Vertical	344	1.06	-	27.68	2.28	-
PK	2.4836G	60.78	74.00	-13.22	30.80	3	Vertical	344	1.06	-	27.70	2.28	-
AV	2.4835G	51.37	54.00	-2.63	21.39	3	Vertical	344	1.06	-	27.70	2.28	-

**BT-LE(2Mbps)**

**2480MHz\_TX**

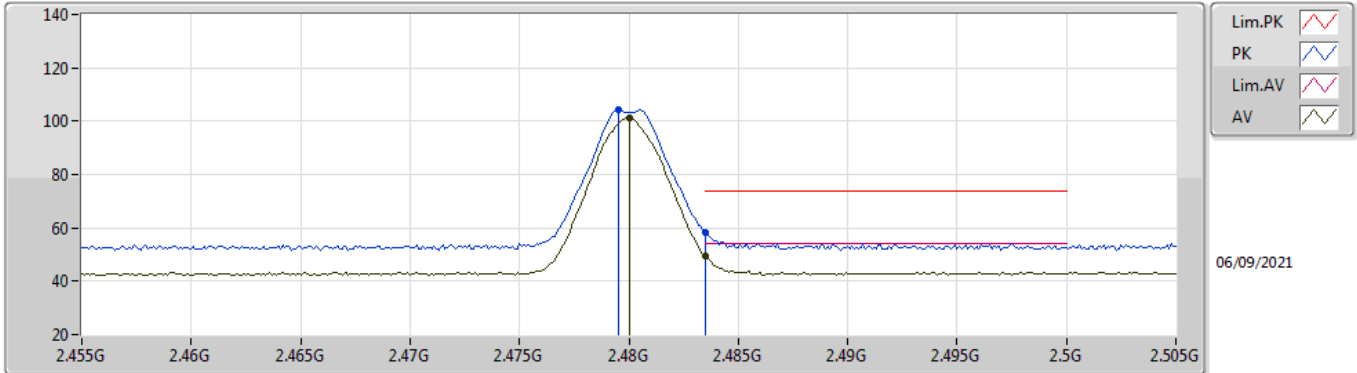

EUT\_V\_1TX  
Setting Default  
01-A-B-2

Type	Freq (Hz)	Level (dBuV/m)	Limit (dBuV/m)	Margin (dB)	Raw (dBuV)	Dist (m)	Condition	Azimuth (°)	Height (m)	Comment	AF (dB)	CL (dB)	PA (dB)
PK	2.4795G	104.22	Inf	-Inf	74.26	3	Horizontal	305	1.52	-	27.68	2.28	-
AV	2.48G	101.14	Inf	-Inf	71.18	3	Horizontal	305	1.52	-	27.68	2.28	-
PK	2.4835G	58.40	74.00	-15.60	28.42	3	Horizontal	305	1.52	-	27.70	2.28	-
AV	2.4835G	49.51	54.00	-4.49	19.53	3	Horizontal	305	1.52	-	27.70	2.28	-

### BT-LE(2Mbps)

### 2480MHz\_TX

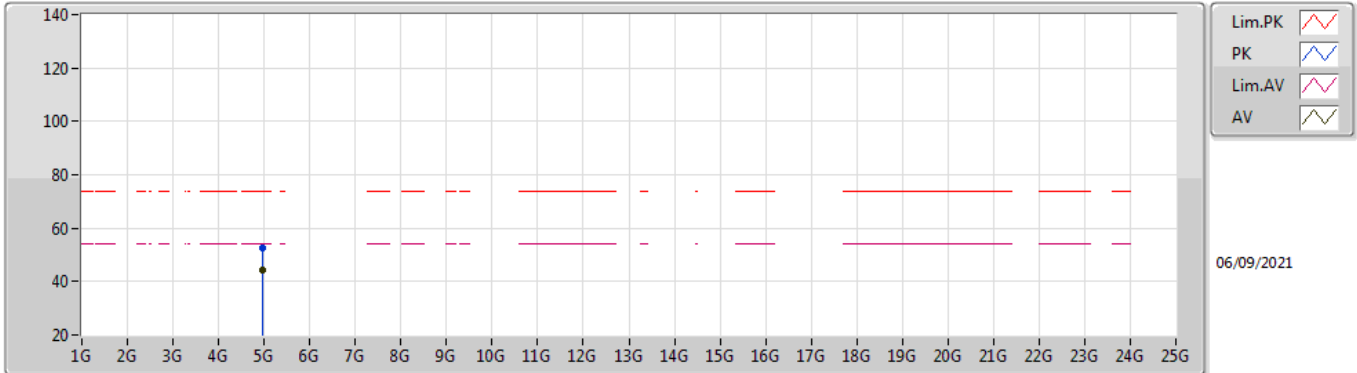

EUT Y\_1TX  
Setting Default  
01-A-B-2

Type	Freq (Hz)	Level (dBuV/m)	Limit (dBuV/m)	Margin (dB)	Raw (dBuV)	Dist (m)	Condition	Azimuth (°)	Height (m)	Comment	AF (dB)	CL (dB)	PA (dB)
PK	4.96093G	52.38	74.00	-21.62	47.49	3	Vertical	22	1.13	-	32.78	5.08	32.97
AV	4.95904G	44.38	54.00	-9.62	39.49	3	Vertical	22	1.13	-	32.78	5.08	32.97



### BT-LE(2Mbps)

### 2480MHz\_TX

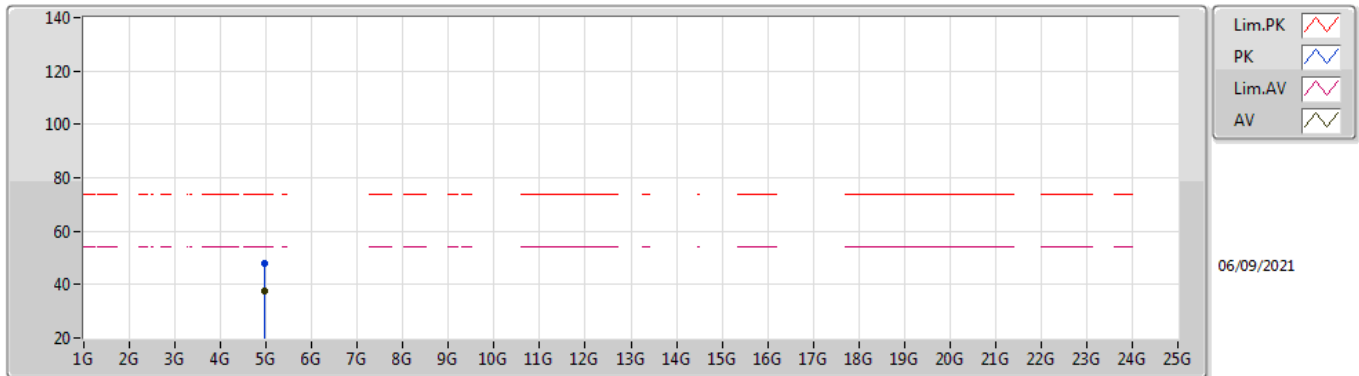

EUT Y\_1TX  
Setting Default  
01-A-B-2

Type	Freq (Hz)	Level (dBuV/m)	Limit (dBuV/m)	Margin (dB)	Raw (dBuV)	Dist (m)	Condition	Azimuth (°)	Height (m)	Comment	AF (dB)	CL (dB)	PA (dB)
PK	4.9589G	47.74	74.00	-26.26	42.85	3	Horizontal	23	2.83	-	32.78	5.08	32.97
AV	4.961G	37.43	54.00	-16.57	32.54	3	Horizontal	23	2.83	-	32.78	5.08	32.97



**Summary**

Mode	Result	Type	Freq (Hz)	Level (dBuV/m)	Limit (dBuV/m)	Margin (dB)	Condition
Mode 1	Pass	AV	1.31242G	41.88	54.00	-12.12	Horizontal

Mode 1

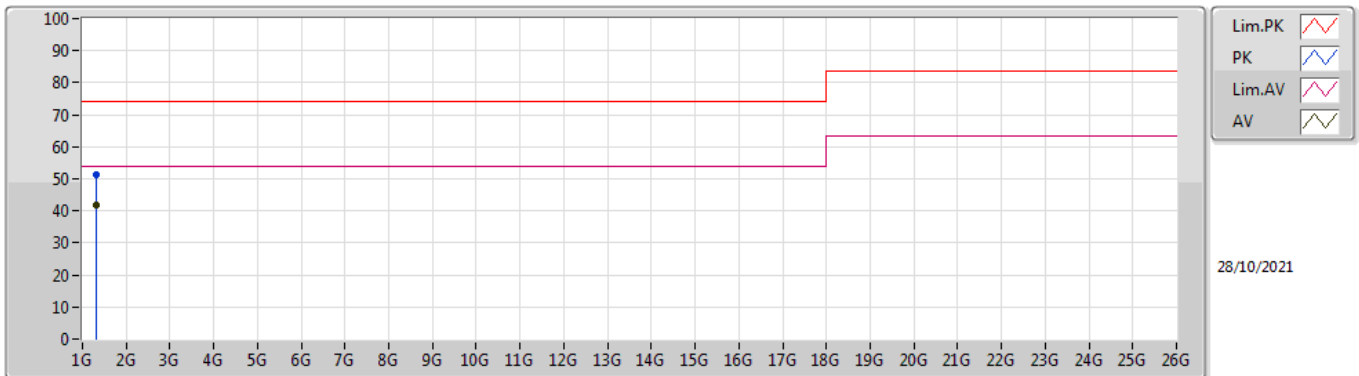

Type	Freq (Hz)	Level (dBuV/m)	Limit (dBuV/m)	Margin (dB)	Factor (dB/m)	Dist (m)	Condition	Azimuth (°)	Height (m)	Comment	Raw (dBuV/m)	AF (dB/m)	CL (dB)	PA (dB)
PK	1.30518G	51.45	74.00	-22.55	-7.68	3	Vertical	136	1.08	-	59.13	25.95	2.51	36.14
AV	1.30977G	41.69	54.00	-12.31	-7.61	3	Vertical	136	1.08	"Worst"	49.30	26.00	2.51	36.12

Mode 1

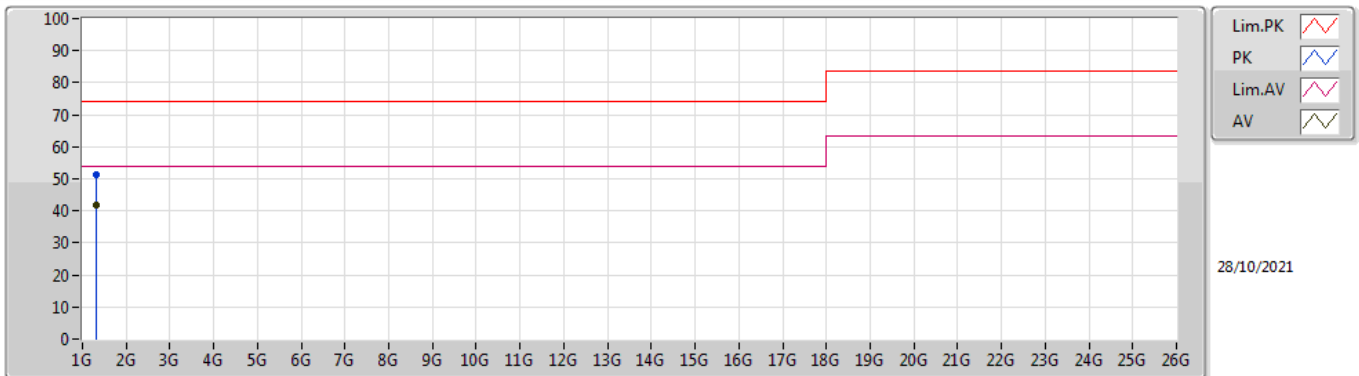

Type	Freq (Hz)	Level (dBuV/m)	Limit (dBuV/m)	Margin (dB)	Factor (dB/m)	Dist (m)	Condition	Azimuth (°)	Height (m)	Comment	Raw (dBuV/m)	AF (dB/m)	CL (dB)	PA (dB)
PK	1.31581G	51.30	74.00	-22.70	-7.51	3	Horizontal	208	1.22	-	58.81	26.06	2.52	36.09
AV	1.31242G	41.88	54.00	-12.12	-7.58	3	Horizontal	208	1.22	"Worst"	49.46	26.02	2.51	36.11