



RADIO TEST REPORT

FCC ID : TLZ-CB511
Equipment : IEEE 802.11 a/b/g/n/ac WLAN 2T2R with Bluetooth 5.0 Combo Module
Brand Name : AzureWave
Model Name : AW-CB511NF-BPF, AW-CB511NF, AW-CB511MA
Applicant : AzureWave Technologies, Inc.
8F., No.94, Baozhong Rd. , Xindian Dist., New Taipei City , Taiwan 231
Manufacturer : AzureWave Technologies, Inc.
8F., No.94, Baozhong Rd. , Xindian Dist., New Taipei City , Taiwan 231
Standard : 47 CFR FCC Part 15.247

The product was received on Sep. 03, 2021, and testing was started from Sep. 04, 2021 and completed on Dec. 06, 2021. We, Sporton International Inc. Hsinchu Laboratory, would like to declare that the tested sample has been evaluated in accordance with the procedures given in ANSI C63.10-2013 and shown compliance with the applicable technical standards.

The test results in this report apply exclusively to the tested model / sample. Without written approval of Sporton International Inc. Hsinchu Laboratory, the test report shall not be reproduced except in full.

Approved by: Sam Chen

Sporton International Inc. Hsinchu Laboratory
No.8, Ln. 724, Bo'ai St., Zhubei City, Hsinchu County 302010, Taiwan (R.O.C.)



Table of Contents

History of this test report.....3

Summary of Test Result.....4

1 General Description5

1.1 Information.....5

1.2 Applicable Standards9

1.3 Testing Location Information9

1.4 Measurement Uncertainty10

2 Test Configuration of EUT11

2.1 Test Channel Mode11

2.2 The Worst Case Measurement Configuration12

2.3 EUT Operation during Test14

2.4 Accessories14

2.5 Support Equipment.....14

2.6 Test Setup Diagram15

2.7 Transmitter Test Result18

2.8 AC Power-line Conducted Emissions18

2.9 20dB Bandwidth and Carrier Frequency Separation.....20

2.10 Maximum Conducted Output Power21

2.11 Number of Hopping Frequencies and Hopping Bandedge22

2.12 Time of Occupancy (Dwell Time)23

2.13 Emissions in Non-restricted Frequency Bands24

2.14 Emissions in Restricted Frequency Bands.....25

3 Test Equipment and Calibration Data28

Appendix A. Test Results of AC Power-line Conducted Emissions

Appendix B. Test Results of 20dB Bandwidth and Carrier Frequency Separation

Appendix C. Test Results of Maximum Conducted Output Power

Appendix D. Test Results of Number of Hopping Frequencies and Hopping Bandedge

Appendix E. Test Results of Time of Occupancy (Dwell Time)

Appendix F. Test Results of Emissions in Non-restricted Frequency Bands

Appendix G. Test Results of Emissions in Restricted Frequency Bands

Appendix H. Test Results of Radiated Emission Co-location

Appendix I. Test Photos

Photographs of EUT v01



History of this test report

Report No.	Version	Description	Issued Date
FR170220AC	01	Initial issue of report	Mar. 28, 2022



Summary of Test Result

Report Clause	Ref Std. Clause	Test Items	Result (PASS/FAIL)	Remark
1.1.2	15.203	Antenna Requirement	PASS	-
2.8	15.207	AC Power-line Conducted Emissions	PASS	-
2.9	15.247(a)	20dB Bandwidth	PASS	-
2.9	15.247(a)	Carrier Frequency Separation	PASS	-
2.10	15.247(b)	Maximum Conducted Output Power	PASS	-
2.11	15.247(a)	Number of Hopping Frequencies and Hopping Band edge	PASS	-
2.12	15.247(a)	Time of Occupancy (Dwell Time)	PASS	-
2.13	15.247(d)	Emissions in Non-restricted Frequency Bands	PASS	-
2.14	15.247(d)	Emissions in Restricted Frequency Bands	PASS	-

Declaration of Conformity:

1. The test results with all measurement uncertainty excluded are presented in accordance with the regulation limits or requirements declared by manufacturers. It's means measurement values may risk exceeding the limit of regulation standards, if measurement uncertainty is include in test results.
2. The measurement uncertainty please refer to report "Measurement Uncertainty".

Comments and Explanations:

The declared of product specification for EUT presented in the report are provided by the manufacturer, and the manufacturer takes all the responsibilities for the accuracy of product specification.

Reviewed by: Sam Chen

Report Producer: Sandy Chuang



1 General Description

1.1 Information

1.1.1 RF General Information

Frequency Range (MHz)	Bluetooth Version	Ch. Frequency (MHz)	Channel Number
2400-2483.5	BR / EDR	2402-2480	0-78 [79]

Band	Mode	BWch (MHz)	Nant
2400-2483.5	BT-BR	1	1
2400-2483.5	BT-EDR	1	1

Note:

- ♦ Bluetooth BR uses a GFSK (1Mbps).
- ♦ Bluetooth EDR uses a combination of $\pi/4$ -DQPSK (2Mbps) and 8DPSK (3Mbps).
- ♦ Bluetooth BR/EDR uses as a system using FHSS modulation.
- ♦ BWch is the nominal channel bandwidth.



1.1.2 Antenna Information

Ant.	Port	Brand	Model Name	Antenna Type	Connector	Antenna Gain(dBi)		
						WLAN 2.4GHz	WLAN 5GHz	Bluetooth
1	1	NVIDIA	320-1929-000	PIFA	I-PEX MHF4-L	4.3	5.4	4.3
2	2	NVIDIA	320-1929-000	PIFA	I-PEX MHF4-L	4.3	5.4	-

Note 1: The above information was declared by manufacturer.

<WLAN 2.4GHz Function>

For IEEE 802.11b/g/n/VHT mode (1TX/2RX):

The EUT supports 1TX/2RX function, and it supports TX diversity function.

Both Port 1 and Port 2 could be used as transmitting antenna, but only one of them will be used at one time. Port 1 and Port 2 could receive simultaneously.

Both Port 1 and Port 2 are selected to test.

For IEEE 802.11b/g/n/VHT mode (2TX/2RX):

Port 1 and Port 2 can be used as transmitting/receiving antenna.

Port 1 and Port 2 could transmit/receive simultaneously.

<WLAN 5GHz Function>

For IEEE 802.11a/n/ac mode (1TX/2RX):

The EUT supports 1TX/2RX function, and it supports TX diversity function.

Both Port 1 and Port 2 could be used as transmitting antenna, but only one of them will be used at one time. Port 1 and Port 2 could receive simultaneously.

Both Port 1 and Port 2 are selected to test.

For IEEE 802.11a/n/ac mode (2TX/2RX):

Port 1 and Port 2 can be used as transmitting/receiving antenna.

Port 1 and Port 2 could transmit/receive simultaneously.

<Bluetooth Function> (1TX/1RX)

Only Port 1 can be used as transmitting/receiving.



Note 2: Directional gain information

Type	Maximum Output Power	Power Spectral Density
Non-BF	Directional gain = Max. gain + array gain. For power measurements on IEEE 802.11 devices Array Gain = 0 dB (i.e., no array gain) for N ANT ≤ 4	$DirectionalGain = 10 \cdot \log \left[\frac{\sum_{j=1}^{N_{ANT}} \left(\sum_{k=1}^{N_{ANT}} \xi_{j,k} \right)^2}{N_{ANT}} \right]$
BF	$DirectionalGain = 10 \cdot \log \left[\frac{\sum_{j=1}^{N_{ANT}} \left(\sum_{k=1}^{N_{ANT}} \xi_{j,k} \right)^2}{N_{ANT}} \right]$	$DirectionalGain = 10 \cdot \log \left[\frac{\sum_{j=1}^{N_{ANT}} \left(\sum_{k=1}^{N_{ANT}} \xi_{j,k} \right)^2}{N_{ANT}} \right]$

Ex.

Directional Gain (NSS1) formula :

$$DirectionalGain = 10 \cdot \log \left[\frac{\sum_{j=1}^{N_{ANT}} \left(\sum_{k=1}^{N_{ANT}} \xi_{j,k} \right)^2}{N_{ANT}} \right]$$

$$NSS1(g1,1) = 10^{G1/20} ; NSS1(g1,2) = 10^{G2/20}$$

$$g_{j,k} = (NSS1(g1,1) + NSS1(g1,2))^2$$

$$DG = 10 \log \left[\frac{(NSS1(g1,1) + NSS1(g1,2))^2}{N_{ANT}} \right] \Rightarrow 10 \log \left[\frac{(10^{G1/20} + 10^{G2/20})^2}{N_{ANT}} \right]$$

Where ;

G1 = Ant 1 Gain ; G2 = Ant 2 Gain

2.4GHz DG = 7.31 dBi

5 GHz U-NII-1 DG = 8.41 dBi

5 GHz U-NII-2A DG = 8.41 dBi

5 GHz U-NII-2C DG = 8.41 dBi

5 GHz U-NII-3 DG = 8.41 dBi



1.1.3 Mode Test Duty Cycle

Mode	DC	DCF(dB)	T(s)	VBW(Hz) ≥ 1/T
BT-BR(1Mbps)	0.756	1.21	2.89m	1k
BT-EDR(2Mbps)	0.835	0.78	2.924m	1k
BT-EDR(3Mbps)	0.787	1.04	2.899m	1k

Note:

- ◆ DC is Duty Cycle.
- ◆ DCF is Duty Cycle Factor.

1.1.4 EUT Operational Condition

EUT Power Type	From host system
EUT Power	3.3V
Test Software Version	Putty 0.62.0.0

1.1.5 Table for EUT Type

EUT	Power IC Source	Brand Name	Model Name	Part No.	Location
1	Main	uPI	RE0108ADD6-18	XC6223H1819R-G	U11
2	Second	MicrOne	ME6211C18U4AG-N	RE0108ADD6-18WDFN-6L	

Note 1: EUT 1 has been evaluated as the worst EUT, so it was selected to test.

Note 2: The above information was declared by manufacturer.

1.1.6 Table for Multiple Listing

Model Name	Description
AW-CB511NF-BPF	All the models are identical; different models serve as marketing strategy.
AW-CB511NF	
AW-CB511MA	

Note: From the above models, model: AW-CB511NF-BPF (EUT 1) was selected as representative model for the test and its data was recorded in this report.



1.2 Applicable Standards

According to the specifications of the manufacturer, the EUT must comply with the requirements of the following standards:

- ♦ 47 CFR FCC Part 15

The following reference test guidance is not within the scope of accreditation of TAF.

- ♦ FCC KDB 558074 D01 v05r02
- ♦ FCC KDB 414788 D01 v01r01

1.3 Testing Location Information

Testing Location Information	
Test Lab. : Sporton International Inc. Hsinchu Laboratory	
Hsinchu (TAF: 3787)	ADD: No.8, Ln. 724, Bo'ai St., Zhubei City, Hsinchu County 302010, Taiwan (R.O.C.) TEL: 886-3-656-9065 FAX: 886-3-656-9085 Test site Designation No. TW3787 with FCC. Conformity Assessment Body Identifier (CABID) TW3787 with ISED.

Test Condition	Test Site No.	Test Engineer	Test Environment (°C / %)	Test Date
RF Conducted	TH02-CB	Lucas Haung	24~25.3 / 54~55	Sep. 07, 2021~ Dec. 06, 2021
Radiated <Below 1GHz>	10CH01-CB	Peter Wu	23~24 / 56~57	Sep. 07, 2021
Radiated <Above 1GHz>	03CH01-CB	Ken Yeh	24.2-26.1 / 55-58	Sep. 04, 2021~ Dec. 03, 2021
Radiated <Co-location>	03CH04-CB	Ken Yeh	23.9-26.1 / 55-58	Sep. 04, 2021~ Dec. 03, 2021
AC Conduction	CO01-CB	Ryo Fan	23~24 / 56~57	Sep. 07, 2021



1.4 Measurement Uncertainty

ISO/IEC 17025 requires that an estimate of the measurement uncertainties associated with the emissions test results be included in the report. The measurement uncertainties given below are based on a 95% confidence level (based on a coverage factor (k=2))

Test Items	Uncertainty	Remark
Conducted Emission (150kHz ~ 30MHz)	2.0 dB	Confidence levels of 95%
Radiated Emission (9kHz ~ 30MHz)	1.6 dB	Confidence levels of 95%
Radiated Emission (30MHz ~ 1,000MHz)	4.2 dB	Confidence levels of 95%
Radiated Emission (1GHz ~ 18GHz)	4.7 dB	Confidence levels of 95%
Radiated Emission (18GHz ~ 40GHz)	4.2 dB	Confidence levels of 95%
Conducted Emission	2.5 dB	Confidence levels of 95%
Output Power Measurement	1.3 dB	Confidence levels of 95%
Power Density Measurement	2.5 dB	Confidence levels of 95%
Bandwidth Measurement	0.9%	Confidence levels of 95%



2 Test Configuration of EUT

2.1 Test Channel Mode

Mode
BT-BR(1Mbps)
2402MHz
2440MHz
2480MHz
BT-EDR(2Mbps)
2402MHz
2440MHz
2480MHz
BT-EDR(3Mbps)
2402MHz
2440MHz
2480MHz



2.2 The Worst Case Measurement Configuration

The Worst Case Mode for Following Conformance Tests	
Tests Item	AC power-line conducted emissions
Condition	AC power-line conducted measurement for line and neutral Test Voltage: 120Vac / 60Hz
Operating Mode	Normal Link
1	EUT 1 in Z axis + WLAN 2.4GHz + Bluetooth
2	EUT 1 in Z axis + WLAN 5GHz + Bluetooth

For operating mode 2 is the worst case and it was record in this test report.

The Worst Case Mode for Following Conformance Tests	
Tests Item	20dB Bandwidth Carrier Frequency Separation Maximum Conducted Output Power Number of Hopping Frequencies Hopping Bandedge Time of Occupancy (Dwell Time) Emissions in Non-restricted Frequency Bands
Test Condition	Conducted measurement at transmit chains
1	EUT 1



The Worst Case Mode for Following Conformance Tests	
Tests Item	Emissions in Restricted Frequency Bands
Test Condition	Radiated measurement If EUT consist of multiple antenna assembly (multiple antenna are used in EUT regardless of spatial multiplexing MIMO configuration), the radiated test should be performed with highest antenna gain of each antenna type.
Operating Mode < 1GHz	Normal Link
1	EUT 1 in Z axis + WLAN 2.4GHz + Bluetooth
2	EUT 1 in Z axis + WLAN 5GHz + Bluetooth
Mode 2 has been evaluated to be the worst case among Mode 1~2, thus measurement for Mode 3 ~ 4 will follow this same test mode.	
3	EUT 1 in Y axis + WLAN 5GHz + Bluetooth
4	EUT 1 in X axis + WLAN 5GHz + Bluetooth
For operating mode 2 is the worst case and it was record in this test report.	
Operating Mode > 1GHz	CTX
The EUT was performed at X axis, Y axis and Z axis position, and the worst case as below:	
1	EUT 1 in Y axis

The Worst Case Mode for Following Conformance Tests	
Tests Item	Simultaneous Transmission Analysis - Radiated Emission Co-location
Test Condition	Radiated measurement
Operating Mode	Normal Link
The EUT was performed at X axis, Y axis and Z axis position. EUT Z axis has been evaluated to be the worst case at Emissions in Restricted Frequency Bands <Above 1GHz>; thus, the measurement will follow this same test configuration.	
1	EUT 1 in Z axis + WLAN 2.4GHz + Bluetooth
2	EUT 1 in Z axis + WLAN 5GHz + Bluetooth
For operating mode 1 is the worst case and it was record in this test report.	
Refer to Appendix H for Radiated Emission Co-location.	

The Worst Case Mode for Following Conformance Tests	
Tests Item	Simultaneous Transmission Analysis - Co-location RF Exposure Evaluation
Operating Mode	
1	EUT 1 <2.4GHz + Bluetooth>
2	EUT 1 <5GHz + Bluetooth>
Refer to Sporton Test Report No.: FA170220 for Co-location RF Exposure Evaluation.	



2.3 EUT Operation during Test

For CTX Mode:

The EUT was programmed to be in continuously transmitting mode.

For Normal Link Mode:

During the test, the EUT operation to normal function.

2.4 Accessories

N/A

2.5 Support Equipment

For AC Conduction and Radiated <below 1GHz>

Support Equipment				
No.	Equipment	Brand Name	Model Name	FCC ID
A	NB	DELL	E6430	N/A
B	Earphone	SHYARO CHI	MIC-04	N/A
C	Mouse	HP	FM100	N/A
D	Fixture	AzureWare	2460 I2	N/A
E	2.4G / 5G AP	ASUS	RP-N53	MSQ-RPN53

For Radiated <Above 1GHz> and RF Conducted

Support Equipment				
No.	Equipment	Brand Name	Model Name	FCC ID
A	NB	DELL	E4300	N/A
B	Fixture	AzureWare	2460 I2	N/A

2.6 Test Setup Diagram

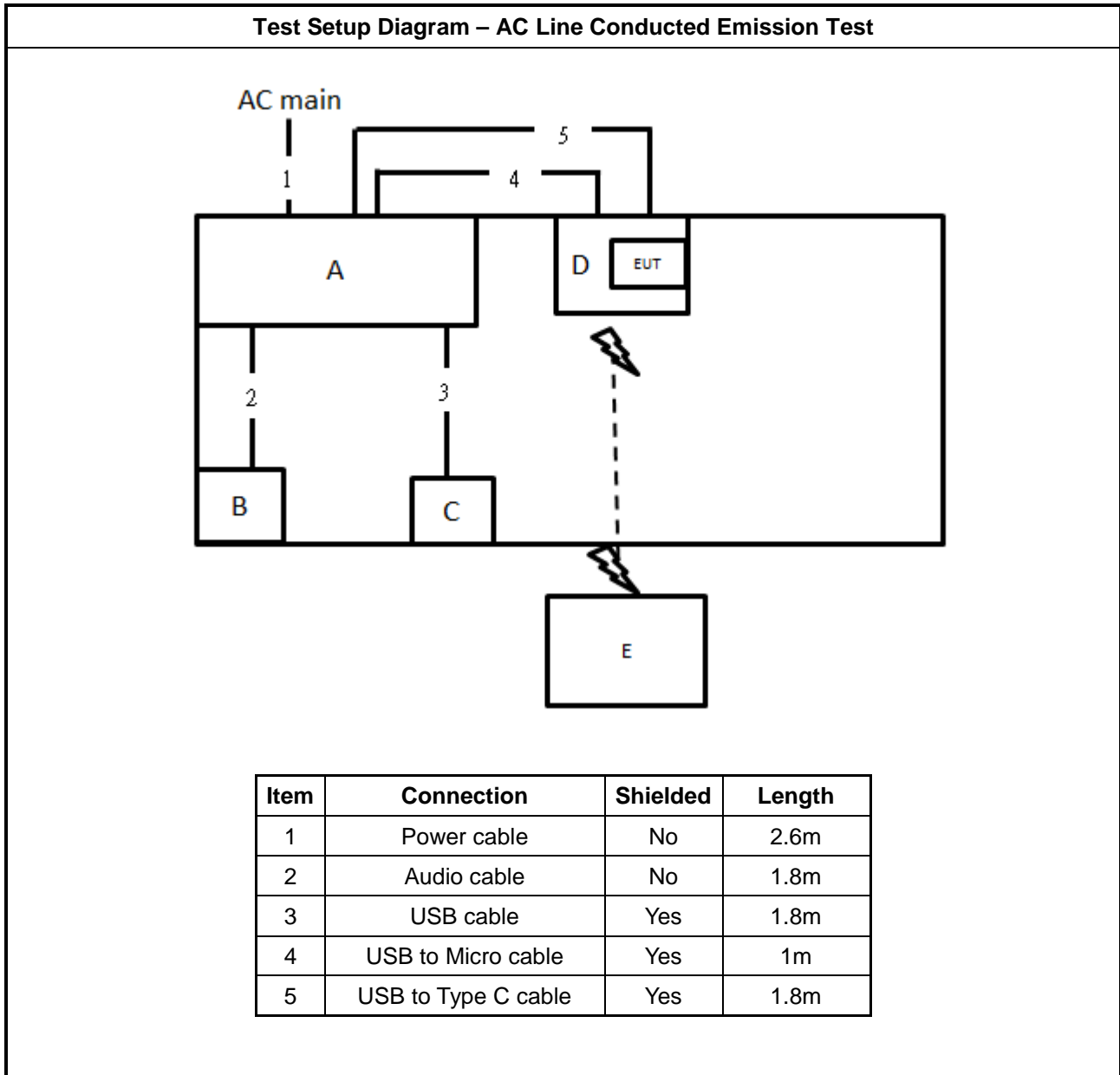

Test Setup Diagram - Radiated Test < 1GHz

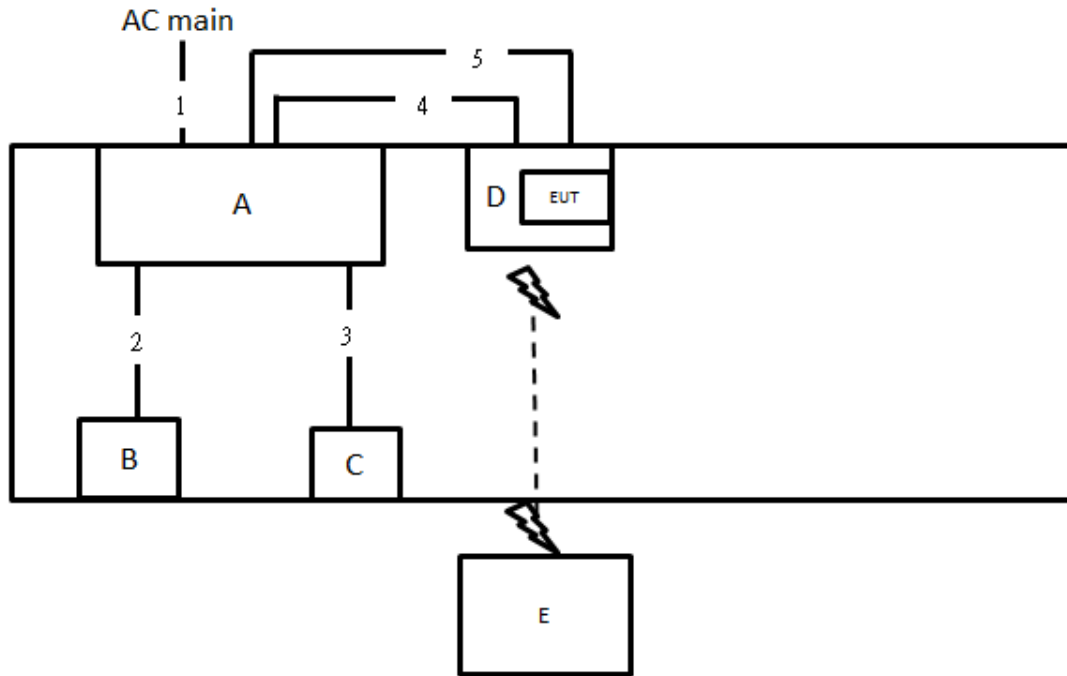

Item	Connection	Shielded	Length
1	Power cable	No	2.6m
2	Audio cable	No	1.8m
3	USB cable	Yes	1.8m
4	USB to Micro cable	Yes	1m
5	USB to Type C cable	Yes	1.8m

Test Setup Diagram - Radiated Test > 1GHz

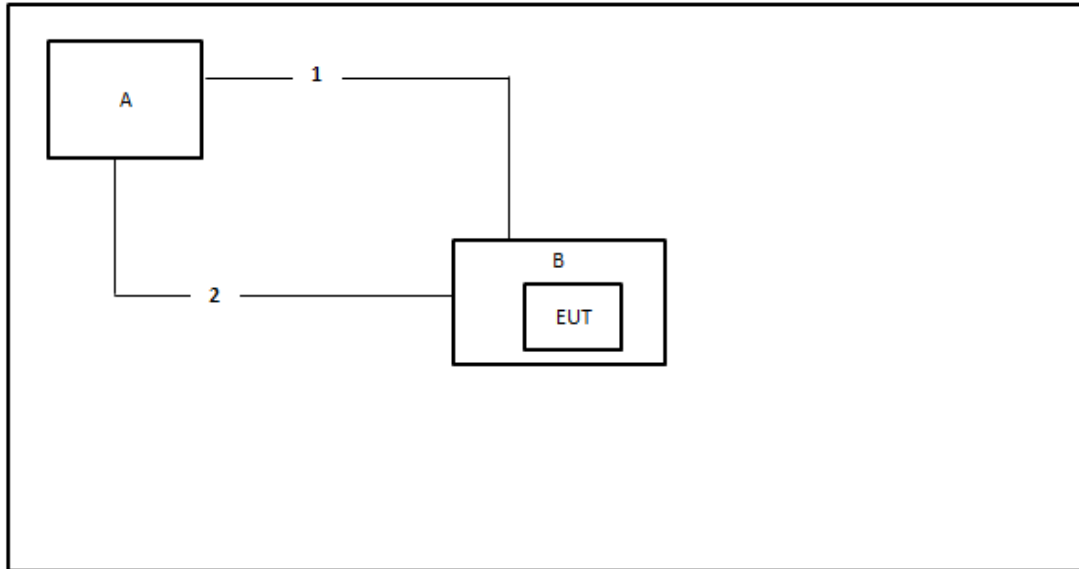

Item	Connection	Shielded	Length
1	USB to Type C cable	Yes	1m
2	USB to Micro cable	Yes	0.5m



2.7 Transmitter Test Result

2.8 AC Power-line Conducted Emissions

2.8.1 AC Power-line Conducted Emissions Limit

AC Power-line Conducted Emissions Limit		
Frequency Emission (MHz)	Quasi-Peak	Average
0.15-0.5	66 - 56 *	56 - 46 *
0.5-5	56	46
5-30	60	50

Note 1: * Decreases with the logarithm of the frequency.

2.8.2 Measuring Instruments

Refer a test equipment and calibration data table in this test report.

2.8.3 Test Procedures

Test Method
▪ Refer as ANSI C63.10-2013, clause 6.2 for AC power-line conducted emissions.

2.8.4 Test Setup

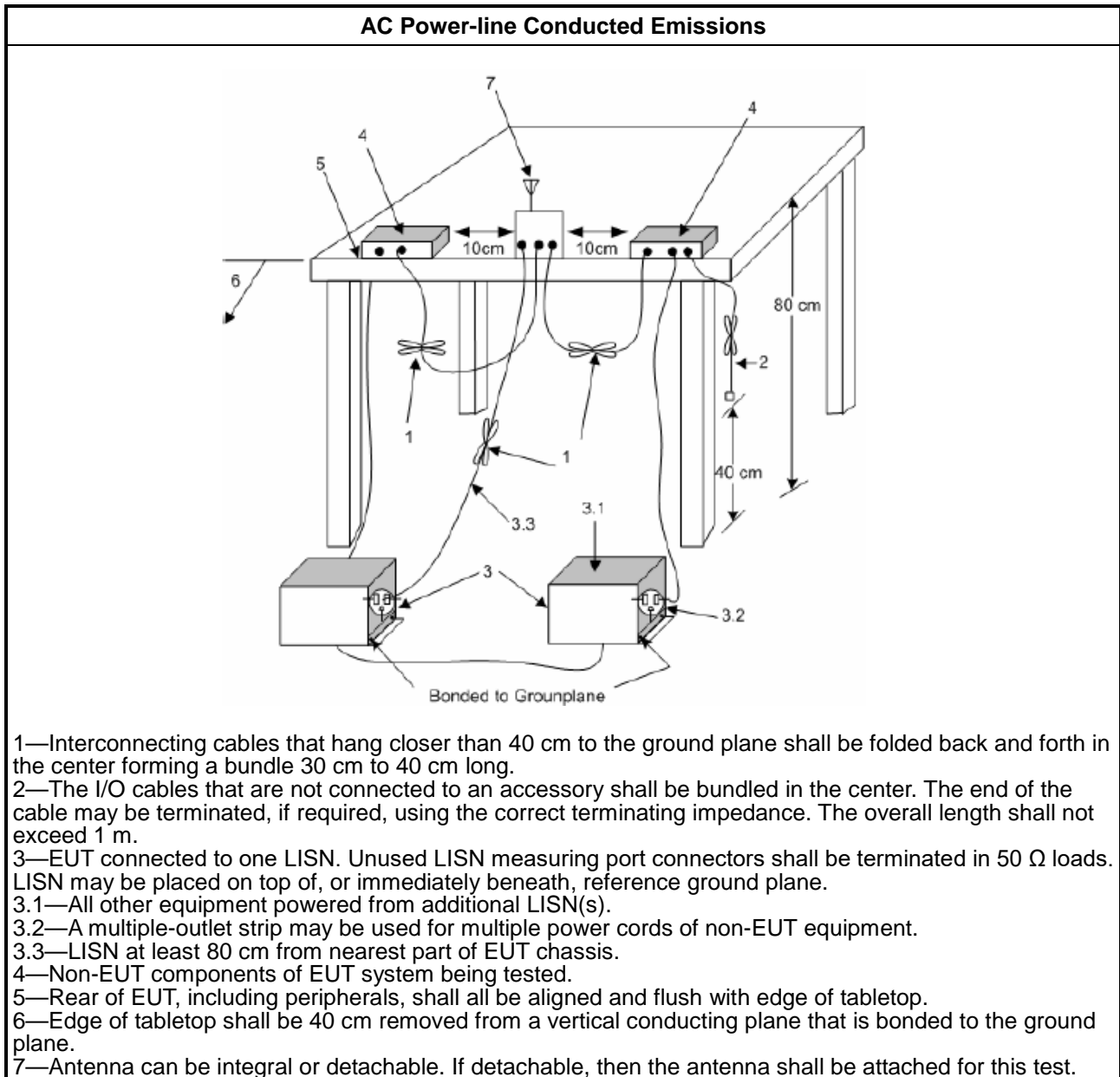

1.1.1. Measurement Results Calculation

The measured Level is calculated using:

- a. Corrected Reading: LISN Factor (LISN) + Attenuator (AT/AUX) + Cable Loss (CL) + Read Level (Raw) = Level
- b. Margin = -Limit + Level

2.8.5 Test Result of AC Power-line Conducted Emissions

Refer as Appendix A

2.9 20dB Bandwidth and Carrier Frequency Separation

2.9.1 20dB Bandwidth and Carrier Frequency Separation Limit

20dB Bandwidth and Carrier Frequency Separation Limit for Frequency Hopping Systems	
▪ 902-928 MHz Band:	
	▪ $N \geq 50$ and $ChS \geq \text{MAX}$ (20 dB bandwidth, 25 kHz); 20 dB bandwidth \leq 250 kHz.
	▪ $50 > N \geq 25$ and $ChS \geq \text{MAX}$ (20 dB bandwidth, 25 kHz); 20 dB bandwidth $>$ 250 kHz.
▪ 2400-2483.5 MHz Band:	
	▪ $N \geq 75$ and $ChS \geq \text{MAX}$ (20 dB bandwidth, 25 kHz).
	▪ $75 > N \geq 15$ and $ChS \geq \text{MAX}$ (20 dB bandwidth 2/3, 25 kHz).
▪ 5725-5850 MHz Band:	
	▪ $N \geq 75$ and $ChS \geq \text{MAX}$ (20 dB bandwidth, 25 kHz); 20 dB bandwidth \leq 1 MHz.
N: Number of Hopping Frequencies; ChS: Hopping Channel Separation	

2.9.2 Measuring Instruments

Refer a test equipment and calibration data table in this test report.

2.9.3 Test Procedures

Test Method
▪ Refer as ANSI C63.10-2013, clause 6.9.1 for 20 dB bandwidth measurement.
▪ Refer as ANSI C63.10-2013, clause 7.8.2 for carrier frequency separation measurement.

2.9.4 Test Setup

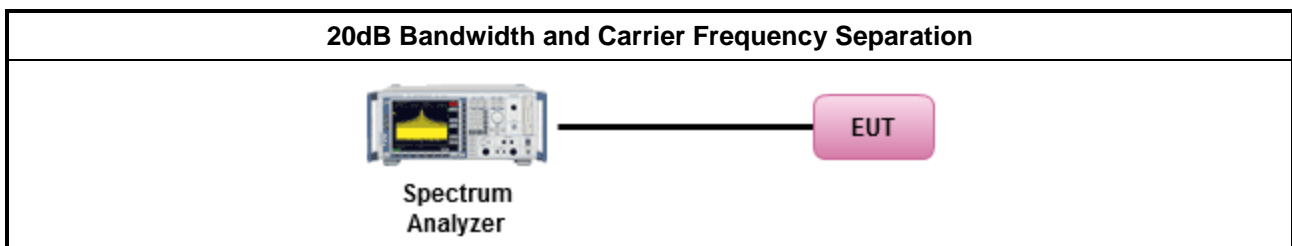

2.9.5 Test Result of 20dB Bandwidth

Refer as Appendix B

2.9.6 Test Result of Carrier Frequency Separation

Refer as Appendix B

2.10 Maximum Conducted Output Power

2.10.1 Maximum Conducted Output Power Limit

Maximum Conducted Output Power Limit	
<ul style="list-style-type: none"> ▪ 902-928 MHz Band: 	
	<ul style="list-style-type: none"> ▪ $N \geq 50$; Power 30dBm; EIRP 36dBm
	<ul style="list-style-type: none"> ▪ $50 > N \geq 25$; Power 23.98dBm; EIRP 29.98dBm
<ul style="list-style-type: none"> ▪ 2400-2483.5 MHz Band: 	
	<ul style="list-style-type: none"> ▪ $N \geq 75$; Power 30dBm; EIRP 36dBm
	<ul style="list-style-type: none"> ▪ $75 > N \geq 15$; Power 21dBm; EIRP 27dBm
<ul style="list-style-type: none"> ▪ 5725-5850 MHz Band: 	
	<ul style="list-style-type: none"> ▪ $N \geq 75$; Power 30dBm; EIRP 36dBm
N: Number of Hopping Frequencies	

2.10.2 Measuring Instruments

Refer a test equipment and calibration data table in this test report.

2.10.3 Test Procedures

Test Method
<ul style="list-style-type: none"> ▪ Refer as ANSI C63.10-2013, clause 7.8.5 for output power measurement.

2.10.4 Test Setup

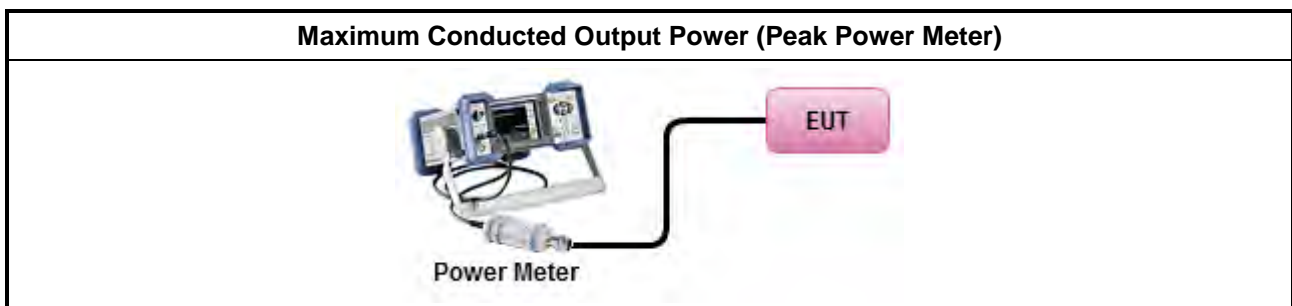

2.10.5 Test Result of Maximum Conducted Output Power

Refer as Appendix C

2.11 Number of Hopping Frequencies and Hopping Bandedge

2.11.1 Number of Hopping Frequencies Limit

Number of Hopping Frequencies Limit	
▪	902-928 MHz Band:
	▪ $N \geq 50$ and $ChS \geq MAX$ (20 dB bandwidth, 25 kHz); 20 dB bandwidth \leq 250 kHz.
	▪ $50 > N \geq 25$ and $ChS \geq MAX$ (20 dB bandwidth, 25 kHz); 20 dB bandwidth $>$ 250 kHz.
▪	2400-2483.5 MHz Band:
	▪ $N \geq 75$ and $ChS \geq MAX$ (20 dB bandwidth, 25 kHz).
	▪ $75 > N \geq 15$ and $ChS \geq MAX$ (20 dB bandwidth 2/3, 25 kHz).
▪	5725-5850 MHz Band:
	▪ $N \geq 75$ and $ChS \geq MAX$ (20 dB bandwidth, 25 kHz); 20 dB bandwidth \leq 1 MHz.
N: Number of Hopping Frequencies; ChS : Hopping Channel Separation	

2.11.2 Hopping Bandedge Limit

Refer clause 2.13.1 and clause 2.14.1

2.11.3 Measuring Instruments

Refer a test equipment and calibration data table in this test report.

2.11.4 Test Procedures

Test Method
▪ Refer as ANSI C63.10-2013, clause 7.8.3 for number of hopping frequencies measurement.
▪ Refer as ANSI C63.10-2013, clause 7.8.6 for hopping frequencies Bandedge measurement.

2.11.5 Test Setup

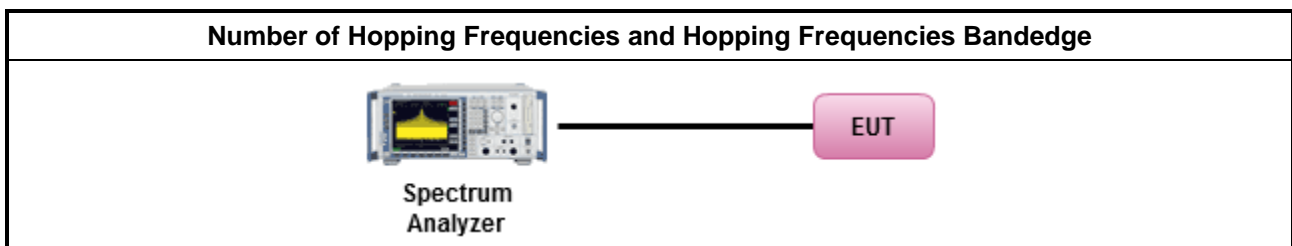

2.11.6 Test Result of Number of Hopping Frequencies

Refer as Appendix D

2.11.7 Test Result of Number of Hopping Frequencies Bandedge

Refer as Appendix D

2.12 Time of Occupancy (Dwell Time)

2.12.1 Time of Occupancy (Dwell Time) Limit

20dB Bandwidth and Carrier Frequency Separation Limit for Frequency Hopping Systems	
<ul style="list-style-type: none"> 902-928 MHz Band: 	
	<ul style="list-style-type: none"> N ≥ 50; 0.4s in 20s period
	<ul style="list-style-type: none"> 50 > N ≥ 25; 0.4s in 10s period
<ul style="list-style-type: none"> 2400-2483.5 MHz Band: 	
	<ul style="list-style-type: none"> N ≥ 75; 0.4s in N x 0.4 period
	<ul style="list-style-type: none"> 75 > N ≥ 15; 0.4s in N x 0.4 period
<ul style="list-style-type: none"> 5725-5850 MHz Band: 	
	<ul style="list-style-type: none"> N ≥ 75; 0.4s in 30s period
N: Number of Hopping Frequencies	

2.12.2 Measuring Instruments

Refer a test equipment and calibration data table in this test report.

2.12.3 Test Procedures

Test Method	
<ul style="list-style-type: none"> Refer as ANSI C63.10-2013, clause 7.8.4 for dwell time measurement. 	
<ul style="list-style-type: none"> Bluetooth ACL packets can be 1, 3, or 5 time slots. Following as dwell time. Operate DH5 at maximum dwell time and maximum duty cycle. 	
	<ul style="list-style-type: none"> The DH5 packet can cover up to 5 time slots. Operate DH5 at maximum dwell time and maximum duty cycle. A maximum length packet has duration of 5 time slots. The hopping rate is 1600 hops/second so the maximum dwell time is 5/1600 seconds, or 3.125ms. DH5 Packet permit maximum $1600 / 79 / 6 = 3.37$ hops per second in each channel.

2.12.4 Test Setup

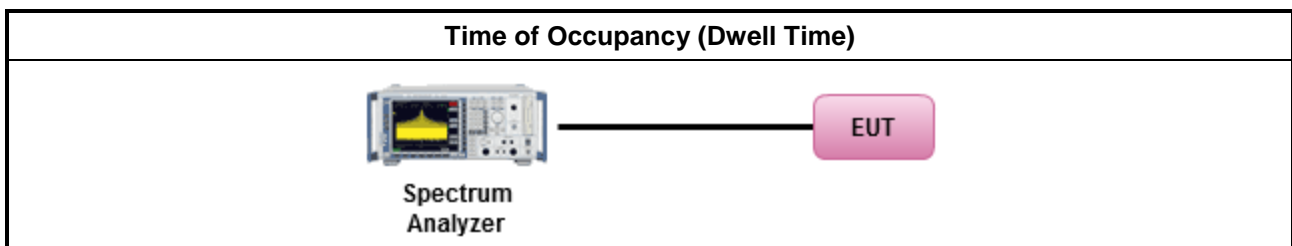

2.12.5 Test Result of Time of Occupancy (Dwell Time)

Refer as Appendix E

2.13 Emissions in Non-restricted Frequency Bands

2.13.1 Emissions in Non-restricted Frequency Bands Limit

Un-restricted Band Emissions Limit	
RF output power procedure	Limit (dBc)
Peak output power procedure	20
Note 1: If the peak output power procedure is used to measure the fundamental emission power to demonstrate compliance to requirements, then the peak conducted output power measured within any 100 kHz outside the authorized frequency band shall be attenuated by at least 20 dB relative to the maximum measured in-band peak PSD level.	

2.13.2 Measuring Instruments

Refer a test equipment and calibration data table in this test report.

2.13.3 Test Procedures

Test Method
<ul style="list-style-type: none"> Refer as ANSI C63.10-2013, clause 7.8.8 for unwanted emissions into non-restricted bands.

2.13.4 Test Setup

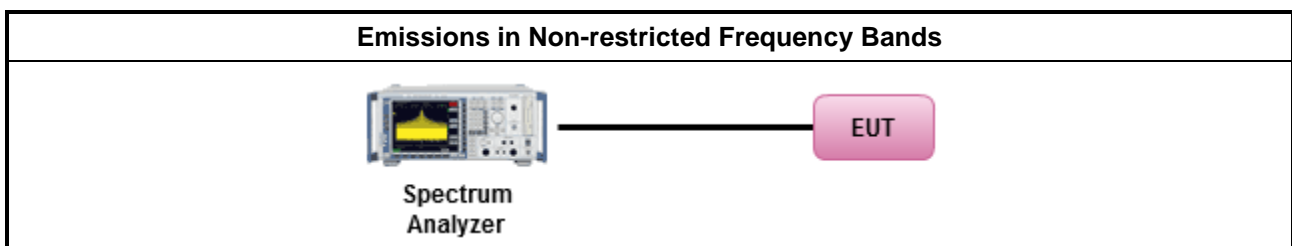

2.13.5 Test Result of Emissions in Non-restricted Frequency Bands

Refer as Appendix F



2.14 Emissions in Restricted Frequency Bands

2.14.1 Emissions in Restricted Frequency Bands Limit

Restricted Band Emissions Limit			
Frequency Range (MHz)	Field Strength (uV/m)	Field Strength (dBuV/m)	Measure Distance (m)
0.009~0.490	2400/F(kHz)	48.5 - 13.8	300
0.490~1.705	24000/F(kHz)	33.8 - 23	30
1.705~30.0	30	29	30
30~88	100	40	3
88~216	150	43.5	3
216~960	200	46	3
Above 960	500	54	3

Note 1: Test distance for frequencies at or above 30 MHz, measurements may be performed at a distance other than the limit distance provided they are not performed in the near field and the emissions to be measured can be detected by the measurement equipment. When performing measurements at a distance other than that specified, the results shall be extrapolated to the specified distance using an extrapolation factor of 20 dB/decade (inverse of linear distance for field-strength measurements, inverse of linear distance-squared for power-density measurements).

Note 2: Test distance for frequencies at below 30 MHz, measurements may be performed at a distance closer than the EUT limit distance; however, an attempt should be made to avoid making measurements in the near field. When performing measurements below 30 MHz at a closer distance than the limit distance, the results shall be extrapolated to the specified distance by either making measurements at a minimum of two or more distances on at least one radial to determine the proper extrapolation factor or by using the square of an inverse linear distance extrapolation factor (40 dB / decade). The test report shall specify the extrapolation method used to determine compliance of the EUT.

Note 3: Using the distance of 1m during the test for above 18 GHz, and the test value to correct for the distance factor at 3m.

2.14.2 Measuring Instruments

Refer a test equipment and calibration data table in this test report.

2.14.3 Test Procedures

Test Method				
<ul style="list-style-type: none"> The average emission levels shall be measured in [hopping duty factor]. 				
<ul style="list-style-type: none"> Refer as ANSI C63.10; clause 6.10.3 band-edge testing shall be performed at the lowest frequency channel and highest frequency channel within the allowed operating band. 				
<ul style="list-style-type: none"> For the transmitter unwanted emissions shall be measured using following options below: <table border="1" data-bbox="188 1776 1428 1912"> <tbody> <tr> <td> <ul style="list-style-type: none"> Refer as ANSI C63.10, clause 4.1.4.2.1 QP value. </td> </tr> <tr> <td> <ul style="list-style-type: none"> Refer as ANSI C63.10, clause 4.1.4.2.2 measurement procedure peak. </td> </tr> <tr> <td> <ul style="list-style-type: none"> Refer as ANSI C63.10, clause 4.1.4.2.4 average value of hopping pulsed emissions. </td> </tr> </tbody> </table> 		<ul style="list-style-type: none"> Refer as ANSI C63.10, clause 4.1.4.2.1 QP value. 	<ul style="list-style-type: none"> Refer as ANSI C63.10, clause 4.1.4.2.2 measurement procedure peak. 	<ul style="list-style-type: none"> Refer as ANSI C63.10, clause 4.1.4.2.4 average value of hopping pulsed emissions.
<ul style="list-style-type: none"> Refer as ANSI C63.10, clause 4.1.4.2.1 QP value. 				
<ul style="list-style-type: none"> Refer as ANSI C63.10, clause 4.1.4.2.2 measurement procedure peak. 				
<ul style="list-style-type: none"> Refer as ANSI C63.10, clause 4.1.4.2.4 average value of hopping pulsed emissions. 				

2.14.4 Test Setup

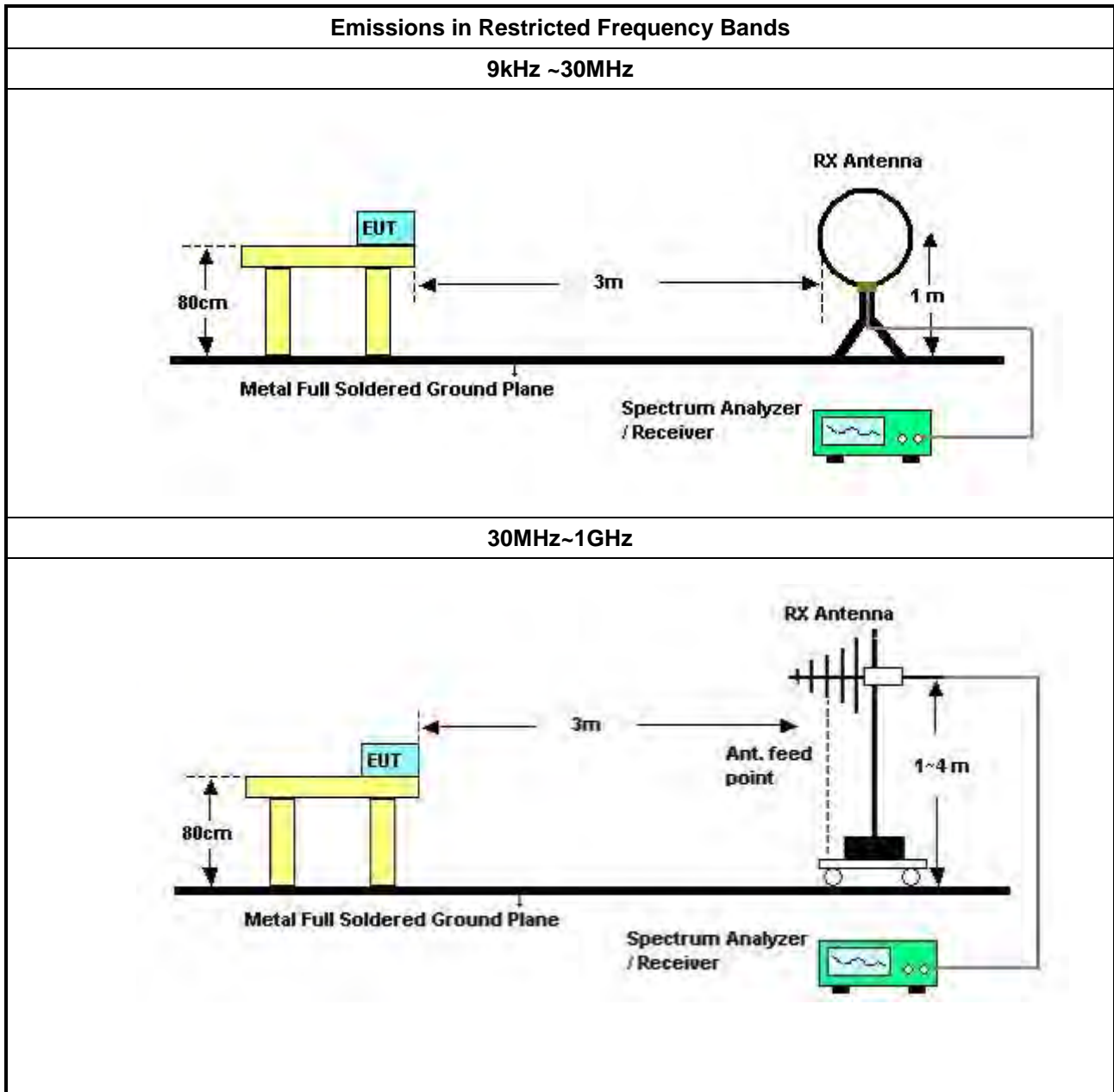

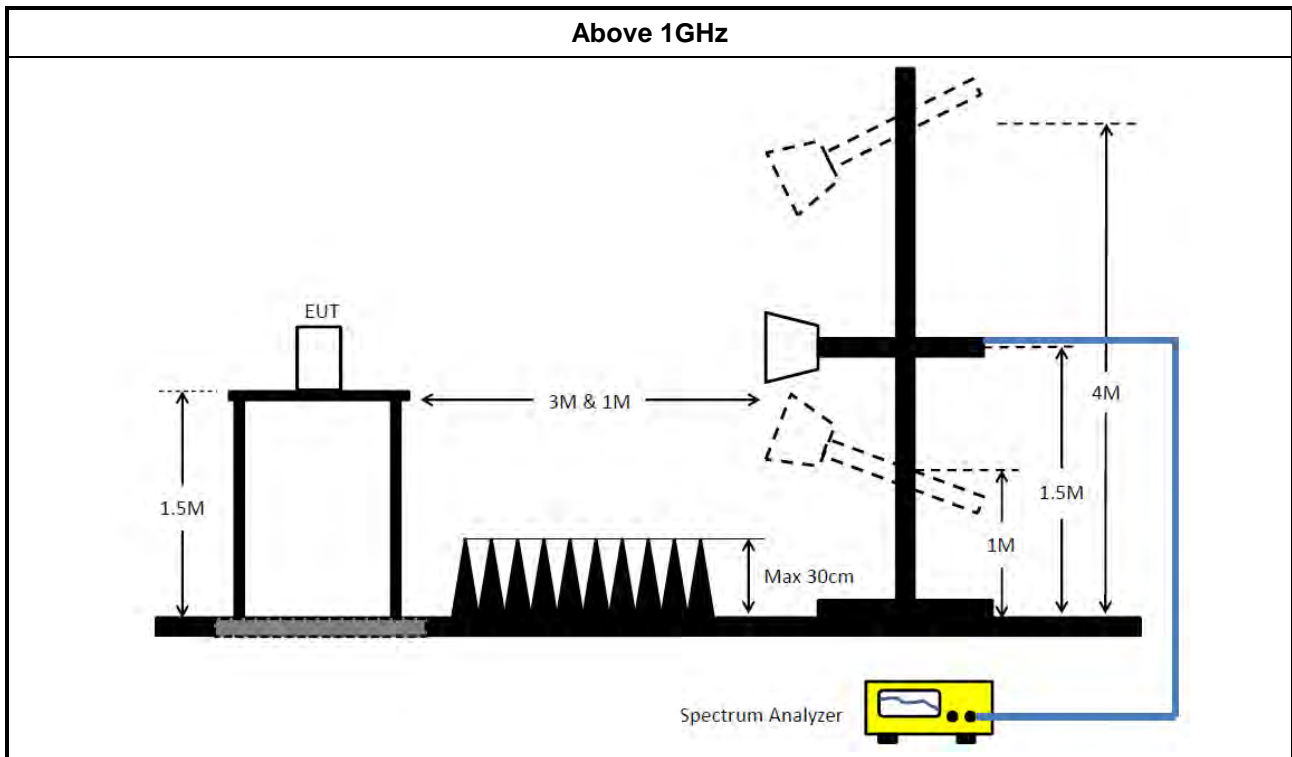

2.14.5 Measurement Results Calculation

The measured Level is calculated using:

Corrected Reading: Antenna factor (AF) + Cable loss (CL) + Read level (Raw) - Preamp factor (PA)(if applicable) = Level.

2.14.6 Emissions in Restricted Frequency Bands (Below 30MHz)

There is a comparison data of both open-field test site and alternative test site - semi-Anechoic chamber according to KDB414788 Radiated Test Site, and the result came out very similar.

All amplitude of spurious emissions that are attenuated by more than 20 dB below the permissible value has no need to be reported.

The radiated emissions were investigated from 9 kHz or the lowest frequency generated within the device, up to the 10th harmonic or 40 GHz, whichever is appropriate.

2.14.7 Test Result of Emissions in Restricted Frequency Bands

Refer as Appendix G



3 Test Equipment and Calibration Data

Instrument	Brand	Model No.	Serial No.	Characteristics	Calibration Date	Calibration Due Date	Remark
EMI Receiver	Agilent	N9038A	My52260123	9kHz ~ 8.4GHz	Mar. 03, 2021	Mar. 02, 2022	Conduction (CO01-CB)
LISN	F.C.C.	FCC-LISN-50-16-2	04083	150kHz ~ 100MHz	Jan. 06, 2021	Jan. 05, 2022	Conduction (CO01-CB)
LISN	Schwarzbeck	NSLK 8127	8127647	9kHz ~ 30MHz	Mar. 07, 2021	Mar. 06, 2022	Conduction (CO01-CB)
Pulse Limiter	Rohde&Schwarz	ESH3-Z2	100430	9kHz ~ 30MHz	Jan. 30, 2021	Jan. 29, 2022	Conduction (CO01-CB)
COND Cable	Woken	Cable	Low cable-CO01	9kHz ~ 30MHz	May 19, 2021	May 18, 2022	Conduction (CO01-CB)
Software	SPORTON	SENSE	V5.10	-	N.C.R.	N.C.R.	Conduction (CO01-CB)
Loop Antenna	Teseq	HLA 6120	24155	9kHz - 30 MHz	Apr. 14, 2021	Apr. 13, 2022	Radiation (10CH01-CB)
10m Semi Anechoic Chamber NSA	TDK	SAC-10M	10CH01-CB	30MHz~1GHz 10m,3m	Jan. 28, 2021	Jan. 27, 2022	Radiation (10CH01-CB)
10m Semi Anechoic Chamber NSA	TDK	SAC-10M	10CH01-CB	30MHz~1GHz 10m,3m	Jan. 28, 2021	Jan. 27, 2022	Radiation (10CH01-CB)
Pre-Amplifier	Agilent	8447D	2944A10783	9kHz ~ 1.3GHz	Mar. 11, 2021	Mar. 10, 2022	Radiation (10CH01-CB)
Pre-Amplifier	Agilent	8447D	2944A10784	9kHz ~ 1.3GHz	Mar. 11, 2021	Mar. 10, 2022	Radiation (10CH01-CB)
Low Cable	Woken	SUCOFLEX 104	low cable-01	25MHz ~ 1GHz	Oct. 20, 2020	Oct. 19, 2021	Radiation (10CH01-CB)
High Cable	Woken	SUCOFLEX 104	low cable-02	25MHz ~ 1GHz	Oct. 20, 2020	Oct. 19, 2021	Radiation (10CH01-CB)
Bilog Antenna with 6dB Attenuator	Chase & EMCI	CBL6111A &N-6-06	1543 &AT-N0609	30MHz ~ 1GHz	Jul. 01, 2021	Jun. 30, 2022	Radiation (10CH01-CB)
EMI Test Receiver	Rohde&Schwarz	ESCI	100186	9kHz ~ 3GHz	Jul. 12, 2021	Jul. 11, 2022	Radiation (10CH01-CB)
Spectrum Analyzer	Rohde&Schwarz	FSV30	101026	9kHz ~ 30GHz	Mar. 08, 2021	Mar. 07, 2022	Radiation (10CH01-CB)
Software	SPORTON	SENSE	V5.10	-	N.C.R.	N.C.R.	Radiation (10CH01-CB)
3m Semi Anechoic Chamber VSWR	TDK	SAC-3M	03CH01-CB	1GHz ~18GHz 3m	May 07, 2021	May 06, 2022	Radiation (03CH01-CB)
Horn Antenna	ETS-LINDGREN	3115	00075790	750MHz ~ 18GHz	Nov. 06, 2020	Nov. 05, 2021	Radiation (03CH01-CB)
Horn Antenna	Schwarzbeck	BBHA 9170	BBHA9170252	15GHz ~ 40GHz	Aug. 05, 2021	Aug. 04, 2022	Radiation (03CH01-CB)
Pre-Amplifier	Agilent	8449B	3008A02121	1GHz ~ 26.5GHz	May 20, 2021	May 19, 2022	Radiation (03CH01-CB)



Instrument	Brand	Model No.	Serial No.	Characteristics	Calibration Date	Calibration Due Date	Remark
Pre-Amplifier	MITEQ	TTA1840-35-HG	1864479	18GHz ~ 40GHz	Jul. 13, 2021	Jul. 12, 2022	Radiation (03CH01-CB)
Spectrum Analyzer	R&S	FSP40	100056	9kHz ~ 40GHz	May 03, 2021	May 02, 2022	Radiation (03CH01-CB)
RF Cable-high	Woken	RG402	High Cable-18	1GHz ~ 18GHz	Oct. 05, 2020	Oct. 04, 2021	Radiation (03CH01-CB)
RF Cable-high	Woken	RG402	High Cable-18	1GHz ~ 18GHz	Oct. 04, 2021	Oct. 03, 2022	Radiation (03CH01-CB)
RF Cable-high	Woken	RG402	High Cable-18+19	1GHz ~ 18GHz	Oct. 05, 2020	Oct. 04, 2021	Radiation (03CH01-CB)
RF Cable-high	Woken	RG402	High Cable-18+19	1GHz ~ 18GHz	Oct. 04, 2021	Oct. 03, 2022	Radiation (03CH01-CB)
RF Cable-high	Woken	RG402	High Cable-40G#1	18GHz ~ 40 GHz	Jul. 15, 2021	Jul. 14, 2022	Radiation (03CH01-CB)
RF Cable-high	Woken	RG402	High Cable-40G#2	18GHz ~ 40 GHz	Jul. 15, 2021	Jul. 14, 2022	Radiation (03CH01-CB)
Test Software	SPORTON	SENSE	V5.10	-	N.C.R.	N.C.R.	Radiation (03CH01-CB)
3m Semi Anechoic Chamber VSWR	TDK	SAC-3M	03CH04-CB	1GHz ~18GHz 3m	Feb. 25, 2021	Feb. 24, 2022	Radiation (03CH04-CB)
Horn Antenna	COM-POWER	AH-118	071028	1GHz ~ 18GHz	Jun. 23, 2021	Jun. 22, 2022	Radiation (03CH04-CB)
Horn Antenna	Schwarzbeck	BBHA 9170	BBHA9170252	15GHz ~ 40GHz	Aug. 05, 2021	Aug. 04, 2022	Radiation (03CH04-CB)
Pre-Amplifier	Agilent	83017A	MY53270063	0.5GHz ~ 26.5GHz	Jul. 12, 2021	Jul. 11, 2022	Radiation (03CH04-CB)
Pre-Amplifier	MITEQ	TTA1840-35-HG	1864479	18GHz ~ 40GHz	Jul. 13, 2021	Jul. 12, 2022	Radiation (03CH04-CB)
Spectrum Analyzer	R&S	FSP40	100142	9kHz~40GHz	Feb. 19, 2021	Feb. 18, 2022	Radiation (03CH04-CB)
RF Cable-high	Woken	RG402	High Cable-18	1GHz ~ 18GHz	Oct. 05, 2020	Oct. 04, 2021	Radiation (03CH04-CB)
RF Cable-high	Woken	RG402	High Cable-18	1GHz ~ 18GHz	Oct. 04, 2021	Oct. 03, 2022	Radiation (03CH04-CB)
RF Cable-high	Woken	RG402	High Cable-18+19	1GHz ~ 18GHz	Oct. 05, 2020	Oct. 04, 2021	Radiation (03CH04-CB)
RF Cable-high	Woken	RG402	High Cable-18+19	1GHz ~ 18GHz	Oct. 04, 2021	Oct. 03, 2022	Radiation (03CH04-CB)
RF Cable-high	Woken	RG402	High Cable-40G#1	18GHz ~ 40 GHz	Jul. 15, 2021	Jul. 14, 2022	Radiation (03CH04-CB)
RF Cable-high	Woken	RG402	High Cable-40G#2	18GHz ~ 40 GHz	Jul. 15, 2021	Jul. 14, 2022	Radiation (03CH04-CB)
Test Software	SPORTON	SENSE	V5.10	-	N.C.R.	N.C.R.	Radiation (03CH04-CB)
Spectrum analyzer	R&S	FSV40	101027	9kHz~40GHz	Aug. 02, 2021	Aug. 01, 2022	Conducted (TH02-CB)
Power Sensor	Anritsu	MA2411B	1531343	300MHz~40GHz	Aug. 15, 2021	Aug. 14, 2022	Conducted (TH02-CB)



Instrument	Brand	Model No.	Serial No.	Characteristics	Calibration Date	Calibration Due Date	Remark
Power Meter	Anritsu	ML2495A	1728001	300MHz~40GHz	Aug. 15, 2021	Aug. 14, 2022	Conducted (TH02-CB)
RF Cable-high	Woken	RG402	High Cable-01	1 GHz – 18 GHz	Oct. 05, 2020	Oct. 04, 2021	Conducted (TH02-CB)
RF Cable-high	Woken	RG402	High Cable-01	1 GHz – 18 GHz	Oct. 04, 2021	Oct. 03, 2022	Conducted (TH02-CB)
RF Cable-high	Woken	RG402	High Cable-02	1 GHz – 18 GHz	Oct. 05, 2020	Oct. 04, 2021	Conducted (TH02-CB)
RF Cable-high	Woken	RG402	High Cable-02	1 GHz – 18 GHz	Oct. 04, 2021	Oct. 03, 2022	Conducted (TH02-CB)
RF Cable-high	Woken	RG402	High Cable-03	1 GHz – 18 GHz	Oct. 05, 2020	Oct. 04, 2021	Conducted (TH02-CB)
RF Cable-high	Woken	RG402	High Cable-03	1 GHz – 18 GHz	Oct. 04, 2021	Oct. 03, 2022	Conducted (TH02-CB)
RF Cable-high	Woken	RG402	High Cable-04	1 GHz – 18 GHz	Oct. 05, 2020	Oct. 04, 2021	Conducted (TH02-CB)
RF Cable-high	Woken	RG402	High Cable-04	1 GHz – 18 GHz	Oct. 04, 2021	Oct. 03, 2022	Conducted (TH02-CB)
RF Cable-high	Woken	RG402	High Cable-05	1 GHz – 18 GHz	Oct. 05, 2020	Oct. 04, 2021	Conducted (TH02-CB)
RF Cable-high	Woken	RG402	High Cable-05	1 GHz – 18 GHz	Oct. 04, 2021	Oct. 03, 2022	Conducted (TH02-CB)
Test Software	SPORTON	SENSE	V5.10	-	N.C.R.	N.C.R.	Conducted (TH02-CB)

Note: Calibration Interval of instruments listed above is one year.

NCR means Non-Calibration required.



Summary

Mode	Result	Type	Freq (Hz)	Level (dBuV)	Limit (dBuV)	Margin (dB)	Condition
Mode 2	Pass	QP	177k	56.80	64.62	-7.82	Line

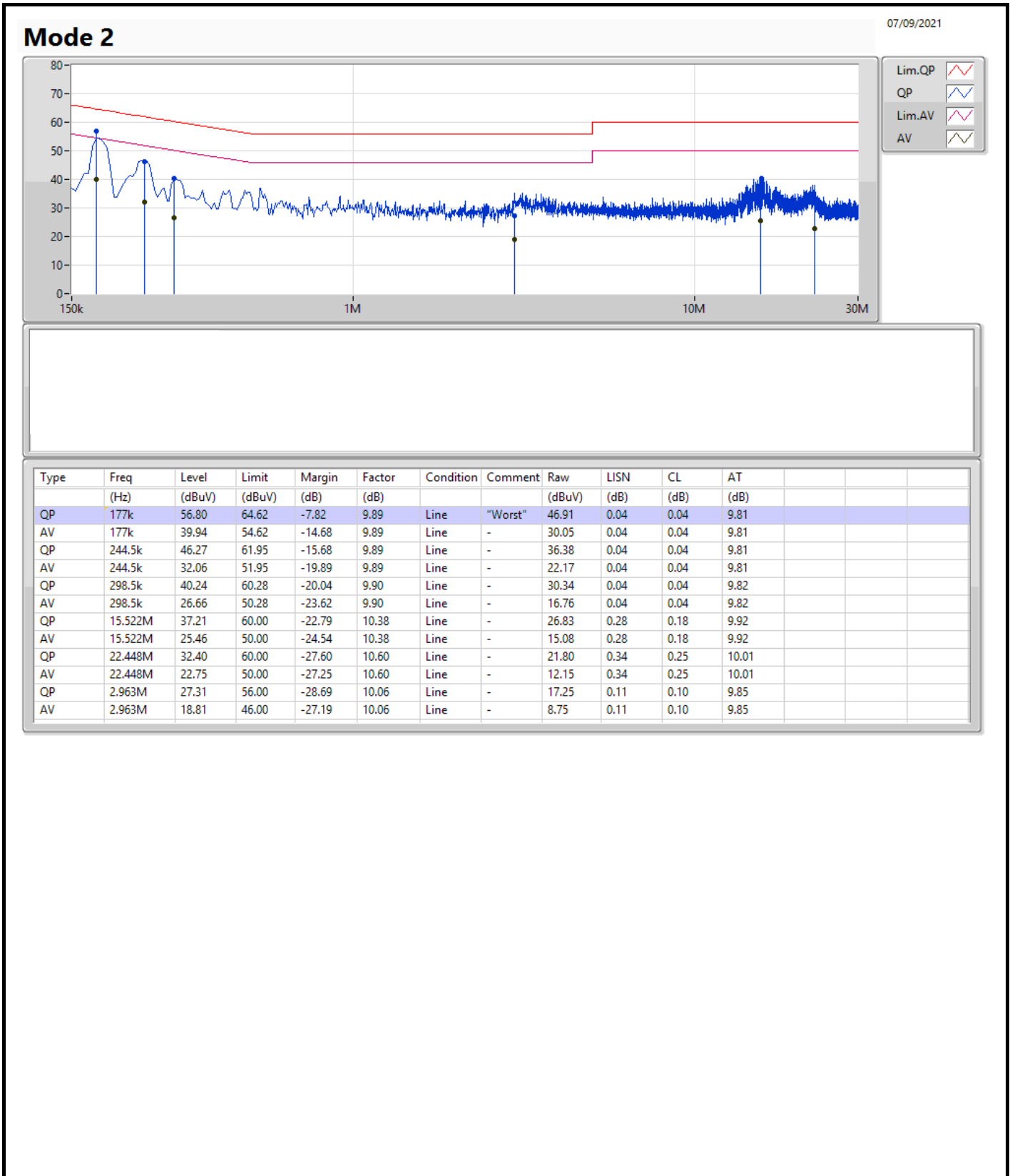

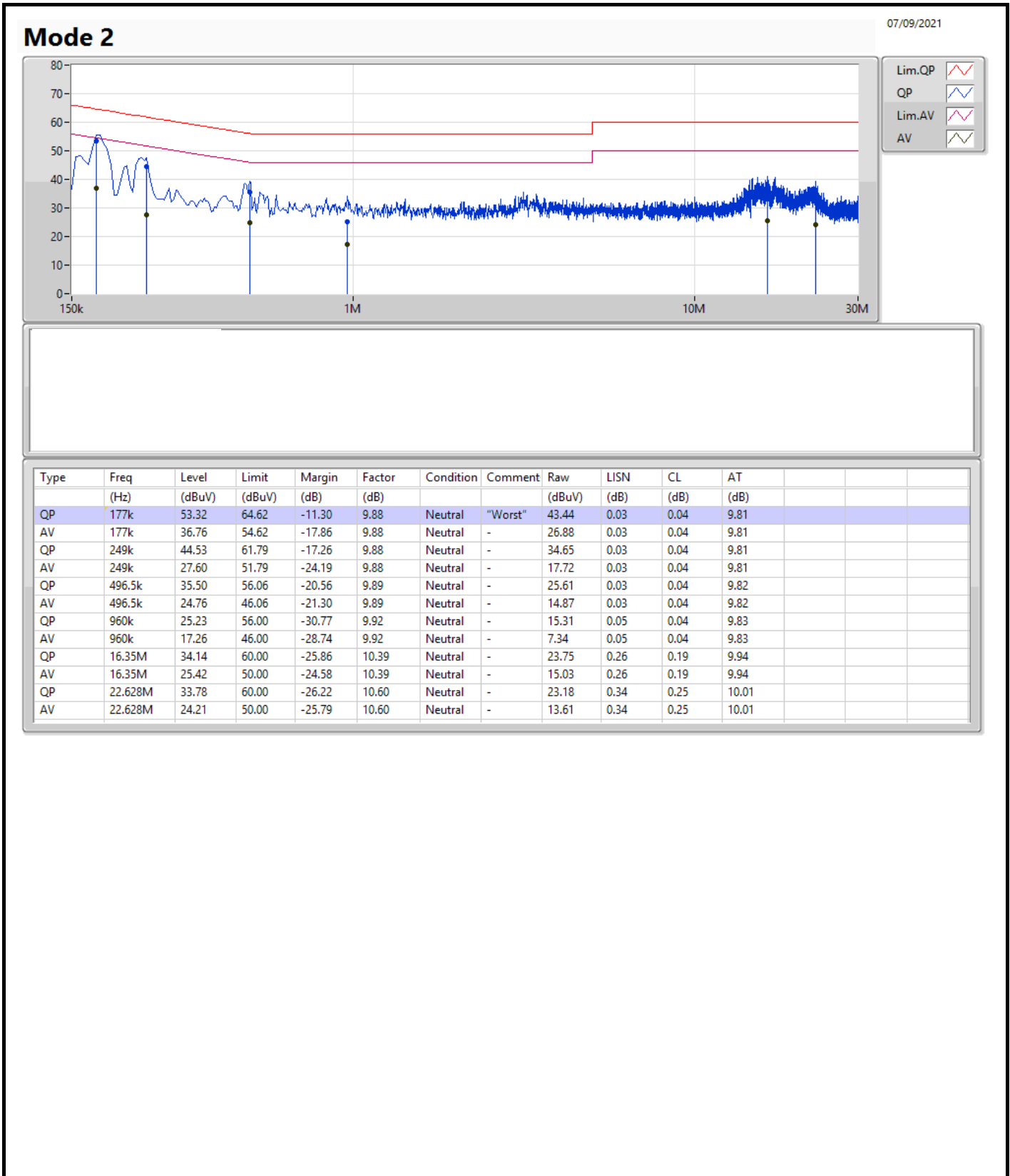



Summary

Mode	Max-N dB (Hz)	Max-OBW (Hz)	ITU-Code	Min-N dB (Hz)	Min-OBW (Hz)
2.4-2.4835GHz	-	-	-	-	-
BT-BR(1Mbps)	1.018M	900.8k	901KF1D	983.75k	890.805k
BT-EDR(2Mbps)	1.338M	1.228M	1M23G1D	1.336M	1.222M
BT-EDR(3Mbps)	1.31M	1.223M	1M22G1D	1.308M	1.218M

Max-N dB = Maximum 20dB down bandwidth; Max-OBW = Maximum 99% occupied bandwidth;
Min-N dB = Minimum 20dB down bandwidth; Min-OBW = Minimum 99% occupied bandwidth

Result

Mode	Result	Limit (Hz)	Port 1-N dB (Hz)	Port 1-OBW (Hz)
BT-BR(1Mbps)	-	-	-	-
2402MHz	Pass	Inf	1.013M	898.301k
2440MHz	Pass	Inf	1.018M	890.805k
2480MHz	Pass	Inf	983.75k	900.8k
BT-EDR(2Mbps)	-	-	-	-
2402MHz	Pass	Inf	1.336M	1.228M
2440MHz	Pass	Inf	1.336M	1.226M
2480MHz	Pass	Inf	1.338M	1.222M
BT-EDR(3Mbps)	-	-	-	-
2402MHz	Pass	Inf	1.309M	1.218M
2440MHz	Pass	Inf	1.31M	1.219M
2480MHz	Pass	Inf	1.308M	1.223M

Port X-N dB = Port X 20dB down bandwidth;
 Port X-OBW = Port X 99% occupied bandwidth

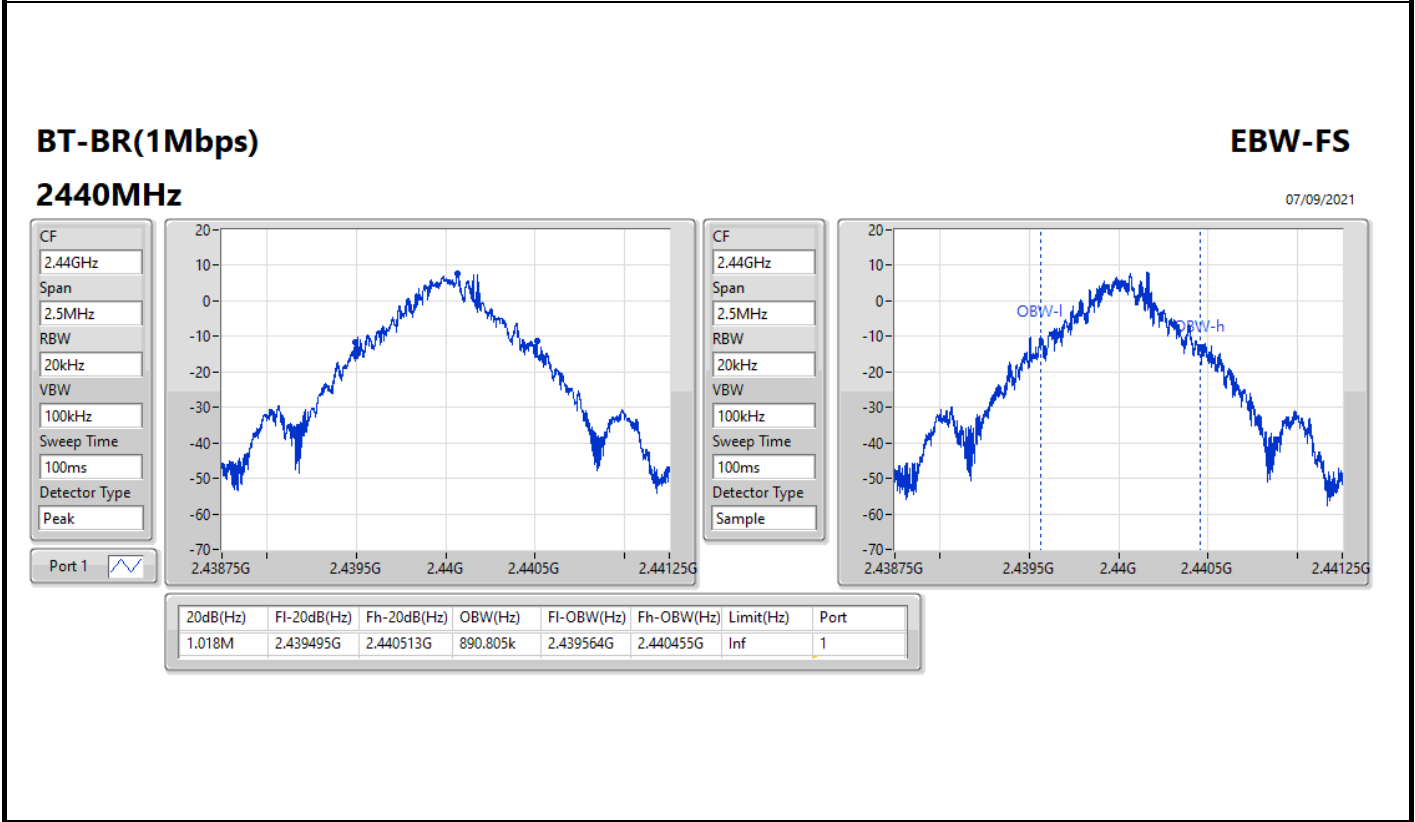
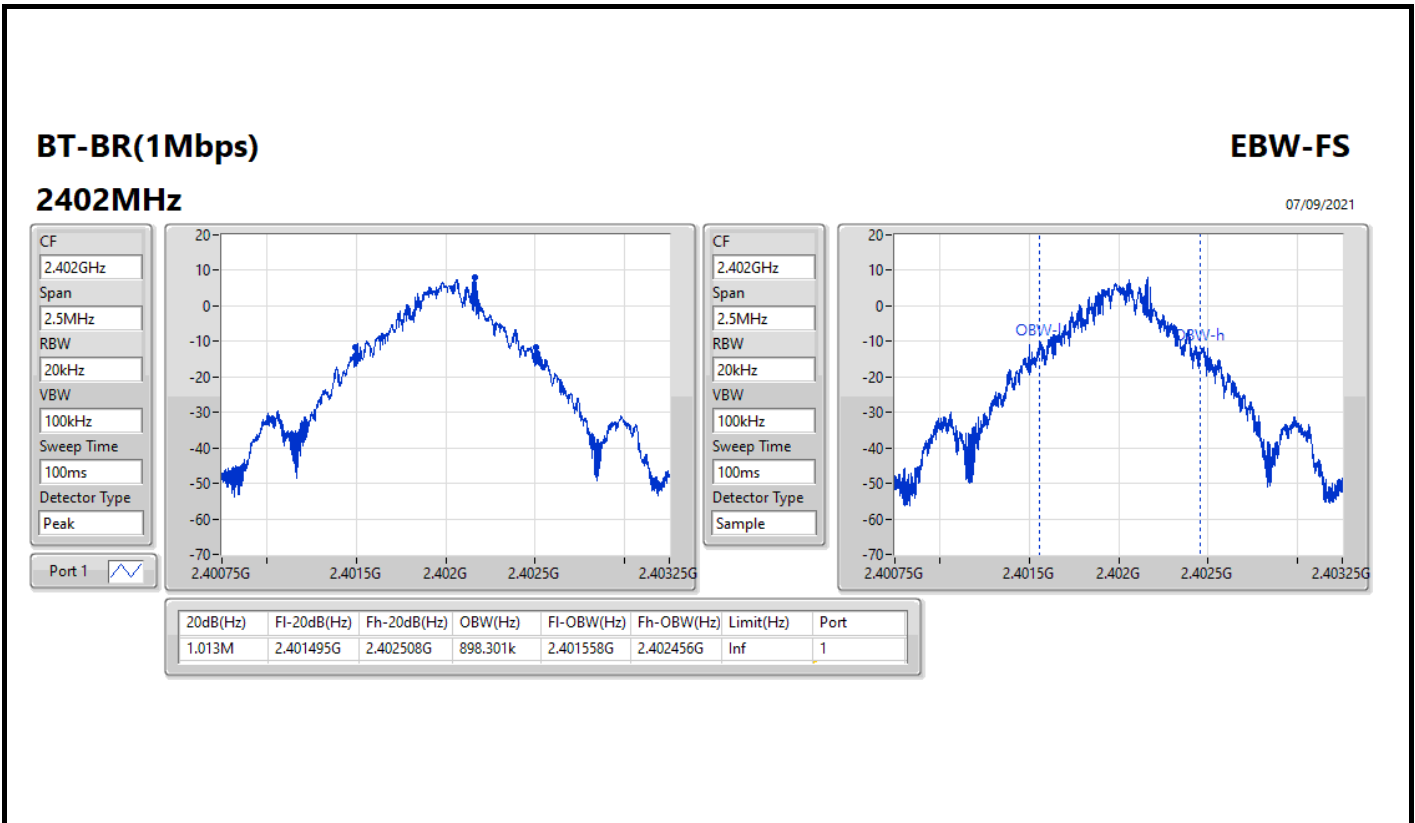

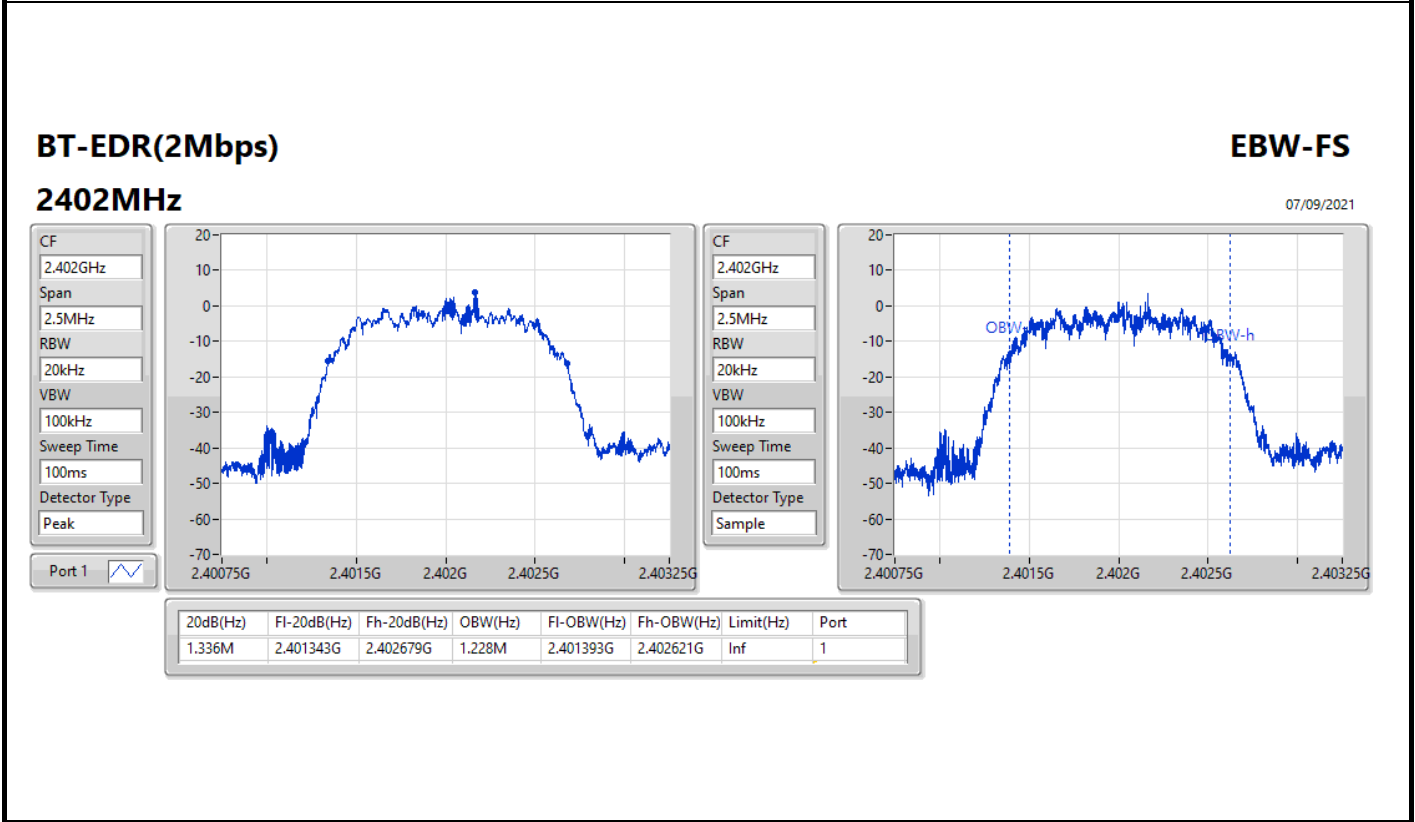
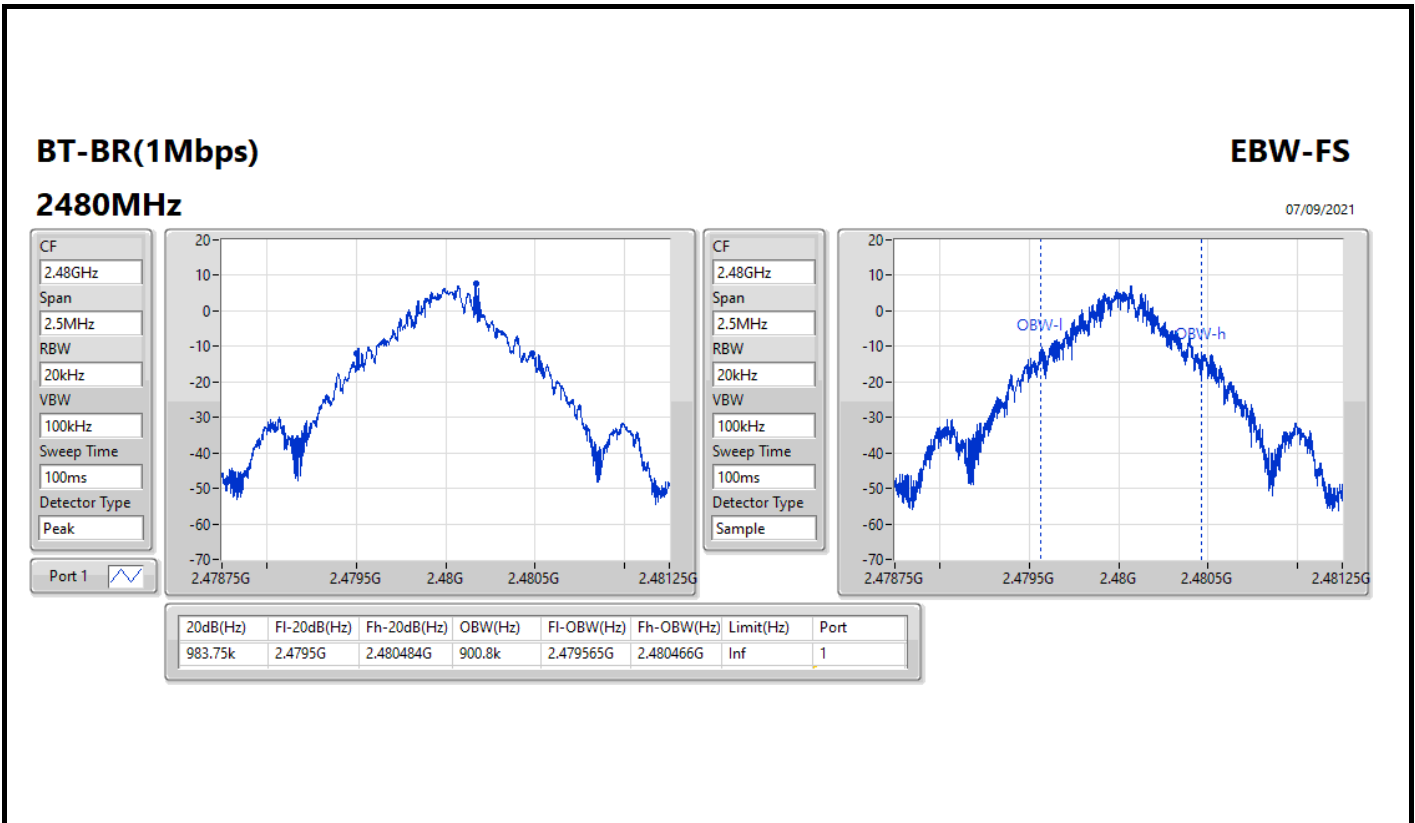

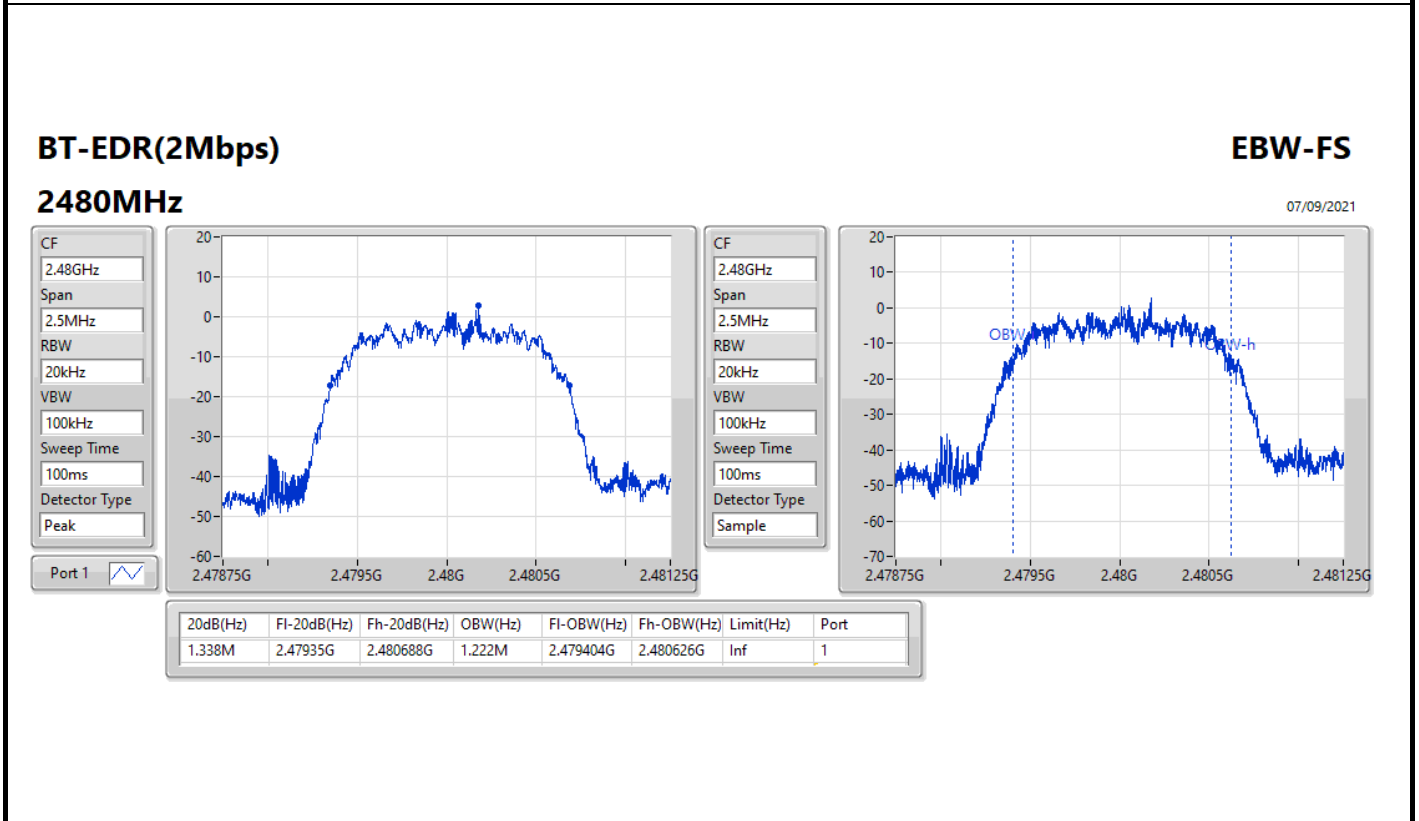
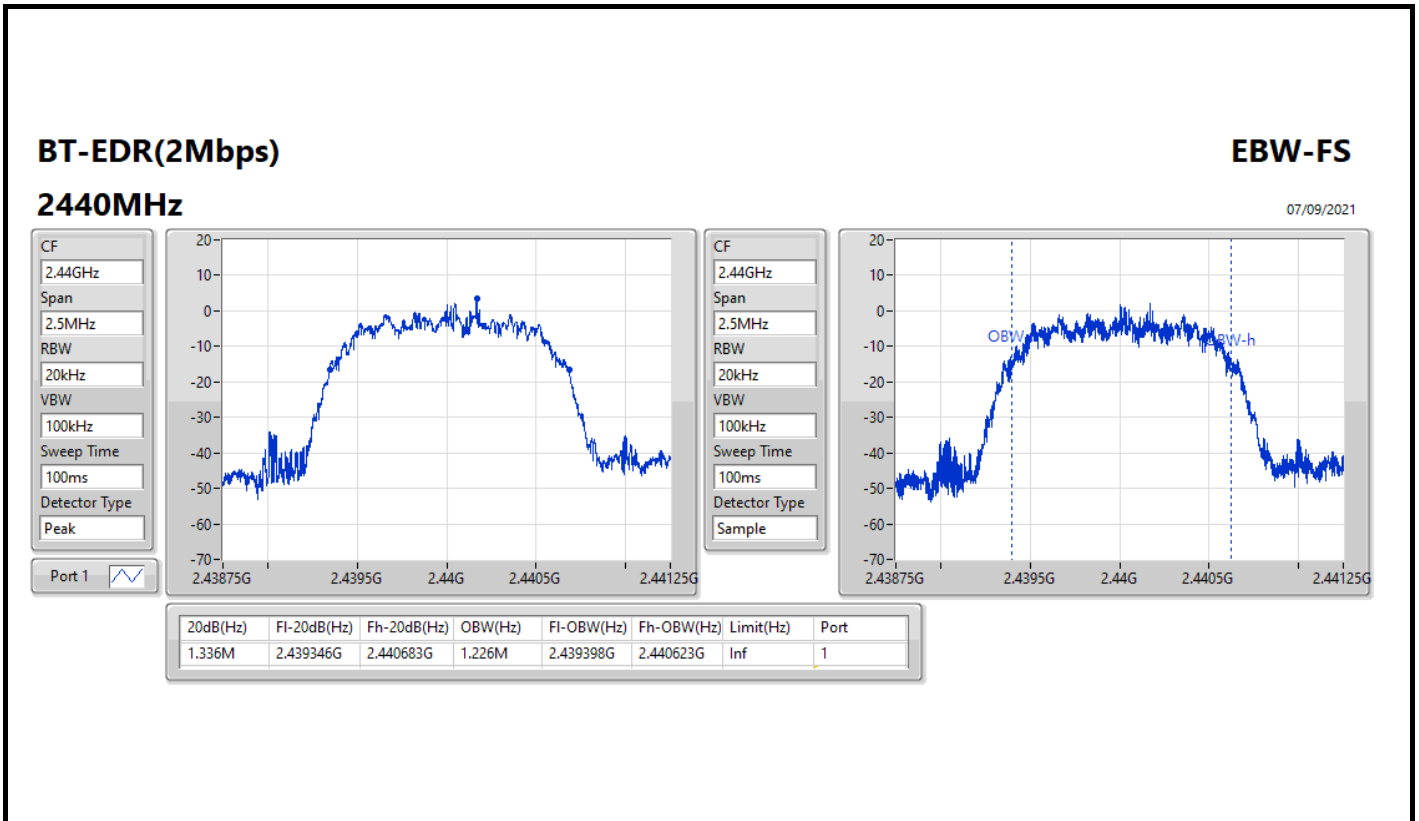

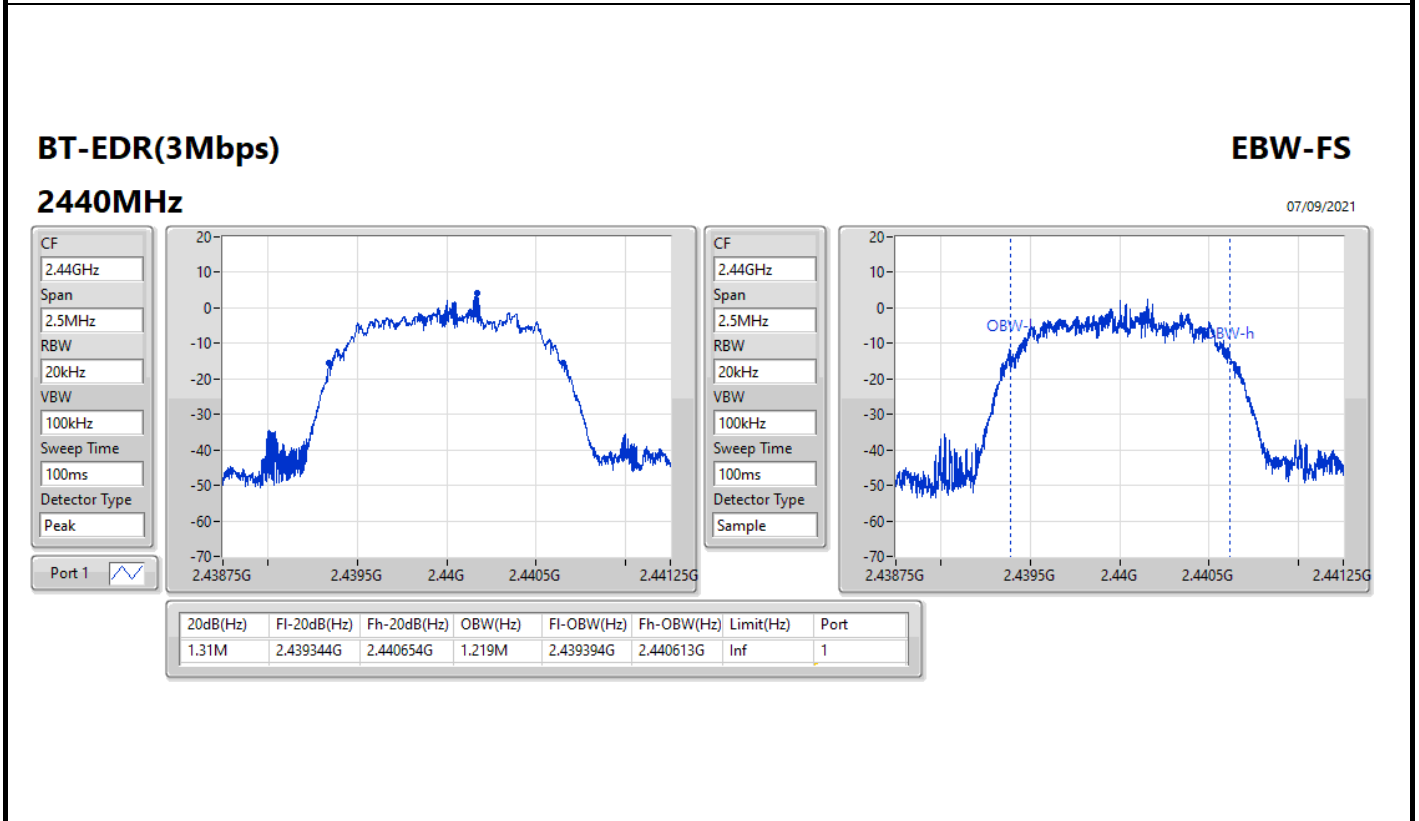
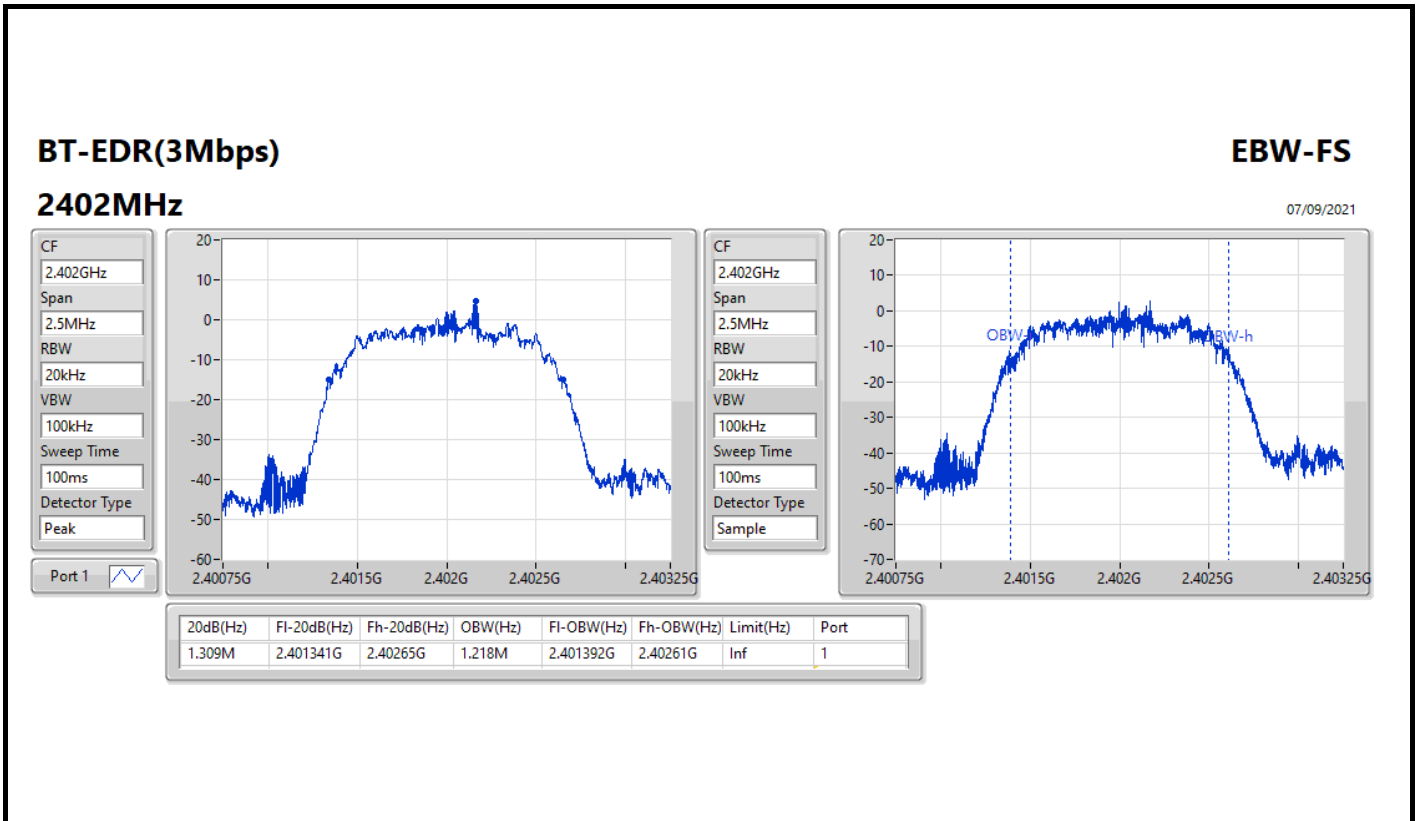

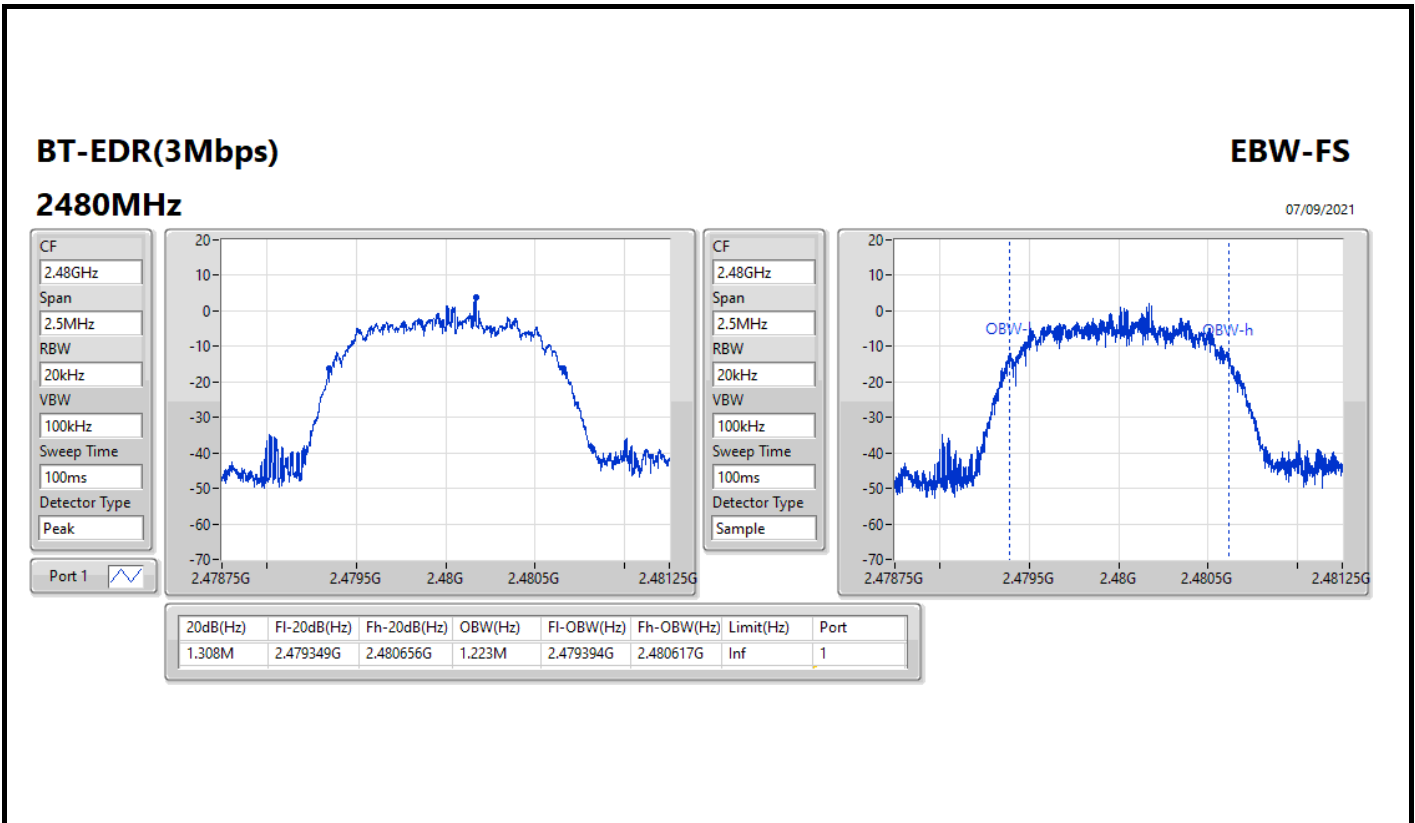



Summary

Mode	Max-Space (Hz)	Min-Space (Hz)
2.4-2.4835GHz	-	-
BT-BR(1Mbps)	1.002M	999k
BT-EDR(2Mbps)	1.002M	1.0005M
BT-EDR(3Mbps)	1.002M	999k

Result

Mode	Result	Fl (Hz)	Fh (Hz)	Ch.Space (Hz)	Limit (Hz)
BT-BR(1Mbps)	-	-	-	-	-
2402MHz	Pass	2.402161G	2.403163G	1.002M	674.658k
2440MHz	Pass	2.440167G	2.441166G	999k	677.988k
2480MHz	Pass	2.479169G	2.480169G	1.0005M	655.1775k
BT-EDR(2Mbps)	-	-	-	-	-
2402MHz	Pass	2.402164G	2.403166G	1.002M	889.776k
2440MHz	Pass	2.440169G	2.441169G	1.0005M	889.776k
2480MHz	Pass	2.479175G	2.480175G	1.0005M	891.108k
BT-EDR(3Mbps)	-	-	-	-	-
2402MHz	Pass	2.40216G	2.403162G	1.002M	871.794k
2440MHz	Pass	2.440166G	2.441165G	999k	872.46k
2480MHz	Pass	2.47917G	2.480171G	1.0005M	871.128k

BT-BR(1Mbps)

Channel Separation-FS

2.402G/2.403GHz



BT-BR(1Mbps)

Channel Separation-FS

2.44G/2.441GHz

07/09/2021

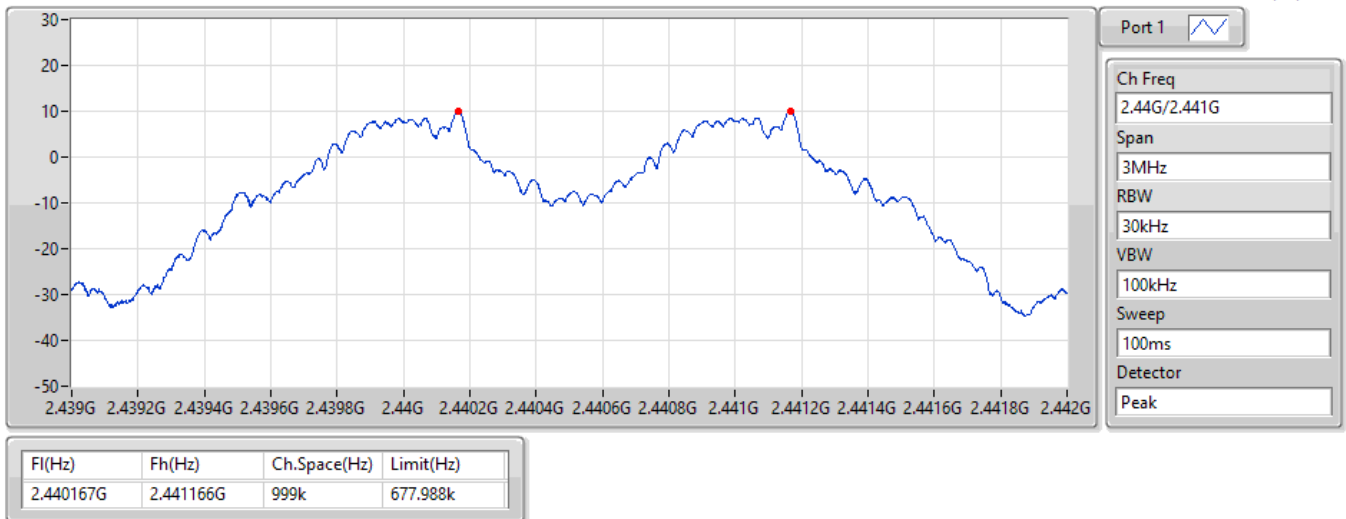

BT-BR(1Mbps)

2.48G/2.479GHz

Channel Separation-FS

07/09/2021



Port 1 

Ch Freq
2.48G/2.479G

Span
3MHz

RBW
30kHz

VBW
100kHz

Sweep
100ms

Detector
Peak

F1(Hz)	Fh(Hz)	Ch.Space(Hz)	Limit(Hz)
2.479169G	2.480169G	1.0005M	655.1775k

BT-EDR(2Mbps)

2.402G/2.403GHz

Channel Separation-FS

07/09/2021

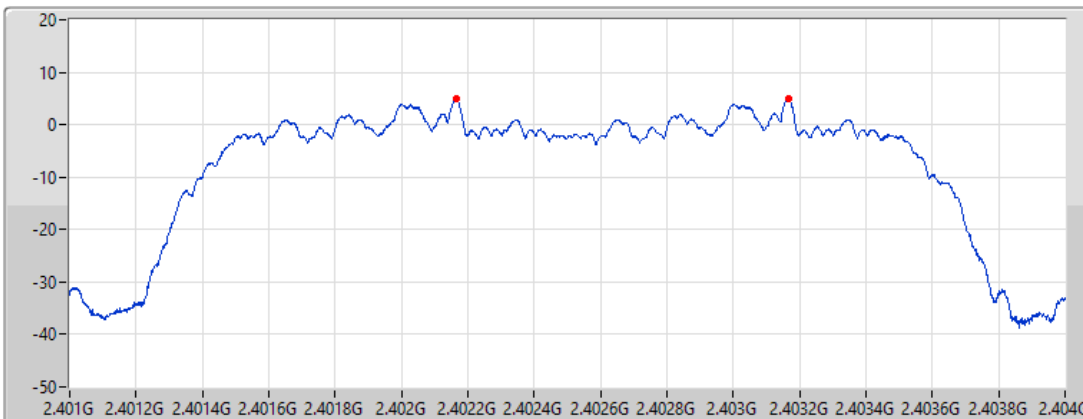

Port 1 

Ch Freq
2.402G/2.403G

Span
3MHz

RBW
30kHz

VBW
100kHz

Sweep
100ms

Detector
Peak

F1(Hz)	Fh(Hz)	Ch.Space(Hz)	Limit(Hz)
2.402164G	2.403166G	1.002M	889.776k

BT-EDR(2Mbps)

Channel Separation-FS

2.44G/2.441GHz

07/09/2021

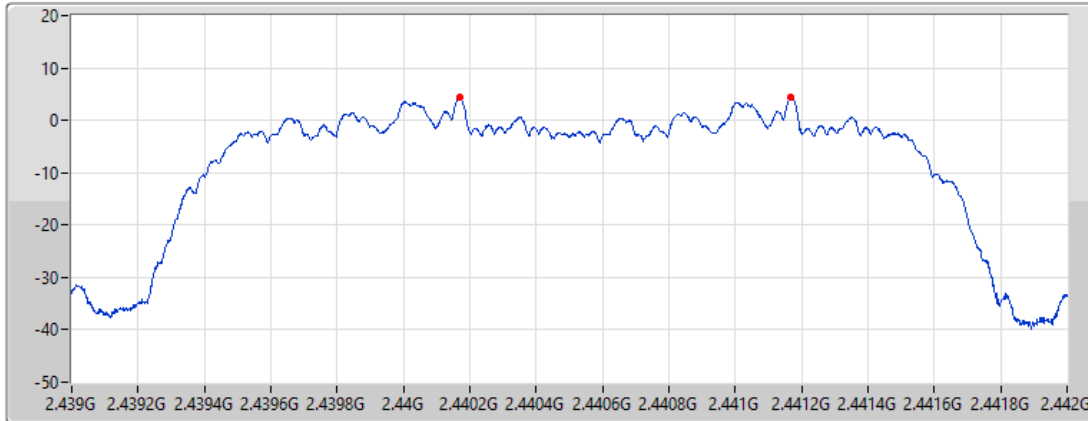

Port 1 

Ch Freq
2.44G/2.441G

Span
3MHz

RBW
30kHz

VBW
100kHz

Sweep
100ms

Detector
Peak

Fl(Hz)	Fh(Hz)	Ch.Space(Hz)	Limit(Hz)
2.440169G	2.441169G	1.0005M	889.776k

BT-EDR(2Mbps)

Channel Separation-FS

2.48G/2.479GHz

07/09/2021

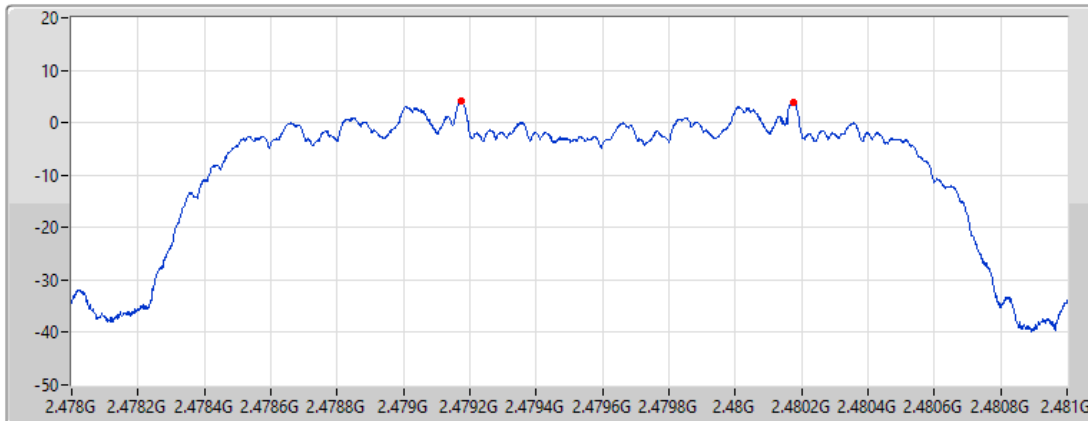

Port 1 

Ch Freq
2.48G/2.479G

Span
3MHz

RBW
30kHz

VBW
100kHz

Sweep
100ms

Detector
Peak

Fl(Hz)	Fh(Hz)	Ch.Space(Hz)	Limit(Hz)
2.479175G	2.480175G	1.0005M	891.108k

BT-EDR(3Mbps)

Channel Separation-FS

2.402G/2.403GHz

07/09/2021



Port 1 

Ch Freq
2.402G/2.403G

Span
3MHz

RBW
30kHz

VBW
100kHz

Sweep
100ms

Detector
Peak

F1(Hz)	Fh(Hz)	Ch.Space(Hz)	Limit(Hz)
2.40216G	2.403162G	1.002M	871.794k

BT-EDR(3Mbps)

Channel Separation-FS

2.44G/2.441GHz

07/09/2021

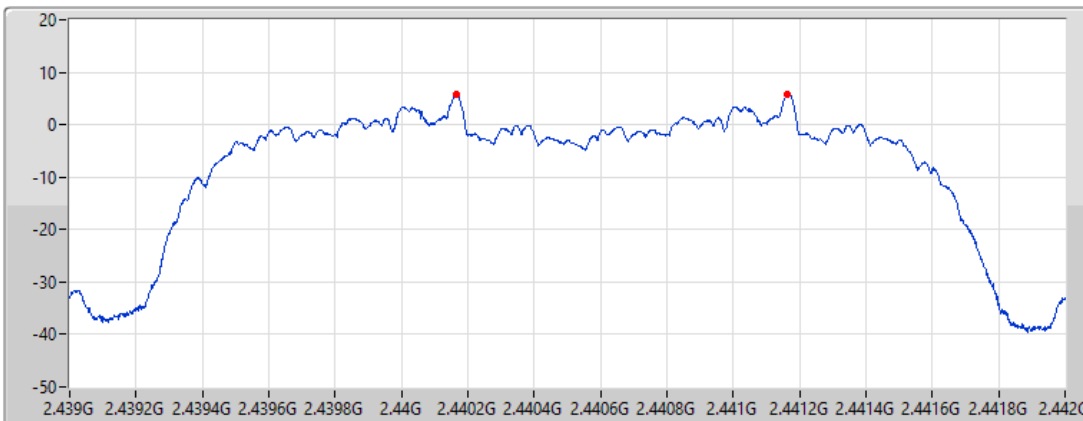

Port 1 

Ch Freq
2.44G/2.441G

Span
3MHz

RBW
30kHz

VBW
100kHz

Sweep
100ms

Detector
Peak

F1(Hz)	Fh(Hz)	Ch.Space(Hz)	Limit(Hz)
2.440166G	2.441165G	999k	872.46k

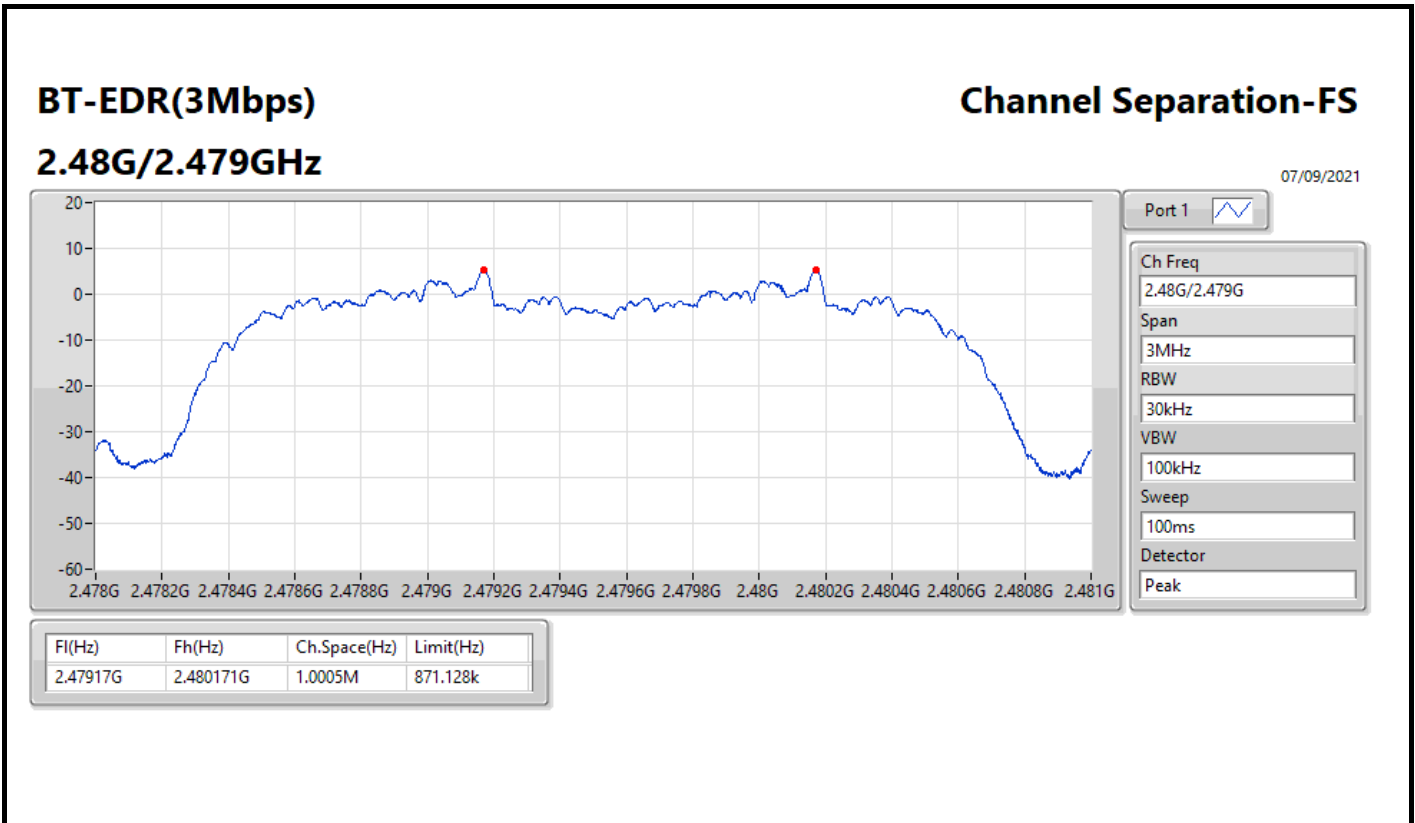



Summary

Mode	Power (dBm)	Power (W)
2.4-2.4835GHz	-	-
BT-BR(1Mbps)	11.10	0.01288
BT-EDR(2Mbps)	7.49	0.00561
BT-EDR(3Mbps)	7.55	0.00569



Result

Mode	Result	Gain (dBi)	Power (dBm)	Power Limit (dBm)
BT-BR(1Mbps)	-	-	-	-
2402MHz	Pass	4.30	10.78	21.00
2440MHz	Pass	4.30	11.10	21.00
2480MHz	Pass	4.30	10.44	21.00
BT-EDR(2Mbps)	-	-	-	-
2402MHz	Pass	4.30	7.49	21.00
2440MHz	Pass	4.30	7.12	21.00
2480MHz	Pass	4.30	6.66	21.00
BT-EDR(3Mbps)	-	-	-	-
2402MHz	Pass	4.30	7.55	21.00
2440MHz	Pass	4.30	7.12	21.00
2480MHz	Pass	4.30	6.64	21.00

DG = Directional Gain; Port X = Port X output power



Summary

Mode	Power (dBm)	Power (W)
2.4-2.4835GHz	-	-
BT-BR(1Mbps)	11.39	0.01377
BT-EDR(2Mbps)	10.01	0.01002
BT-EDR(3Mbps)	10.48	0.01117



Result

Mode	Result	Gain (dBi)	Power (dBm)	Power Limit (dBm)
BT-BR(1Mbps)	-	-	-	-
2402MHz	Pass	4.30	11.06	21.00
2440MHz	Pass	4.30	11.39	21.00
2480MHz	Pass	4.30	10.69	21.00
BT-EDR(2Mbps)	-	-	-	-
2402MHz	Pass	4.30	10.01	21.00
2440MHz	Pass	4.30	9.66	21.00
2480MHz	Pass	4.30	9.07	21.00
BT-EDR(3Mbps)	-	-	-	-
2402MHz	Pass	4.30	10.48	21.00
2440MHz	Pass	4.30	10.10	21.00
2480MHz	Pass	4.30	9.52	21.00

DG = Directional Gain; Port X = Port X output power

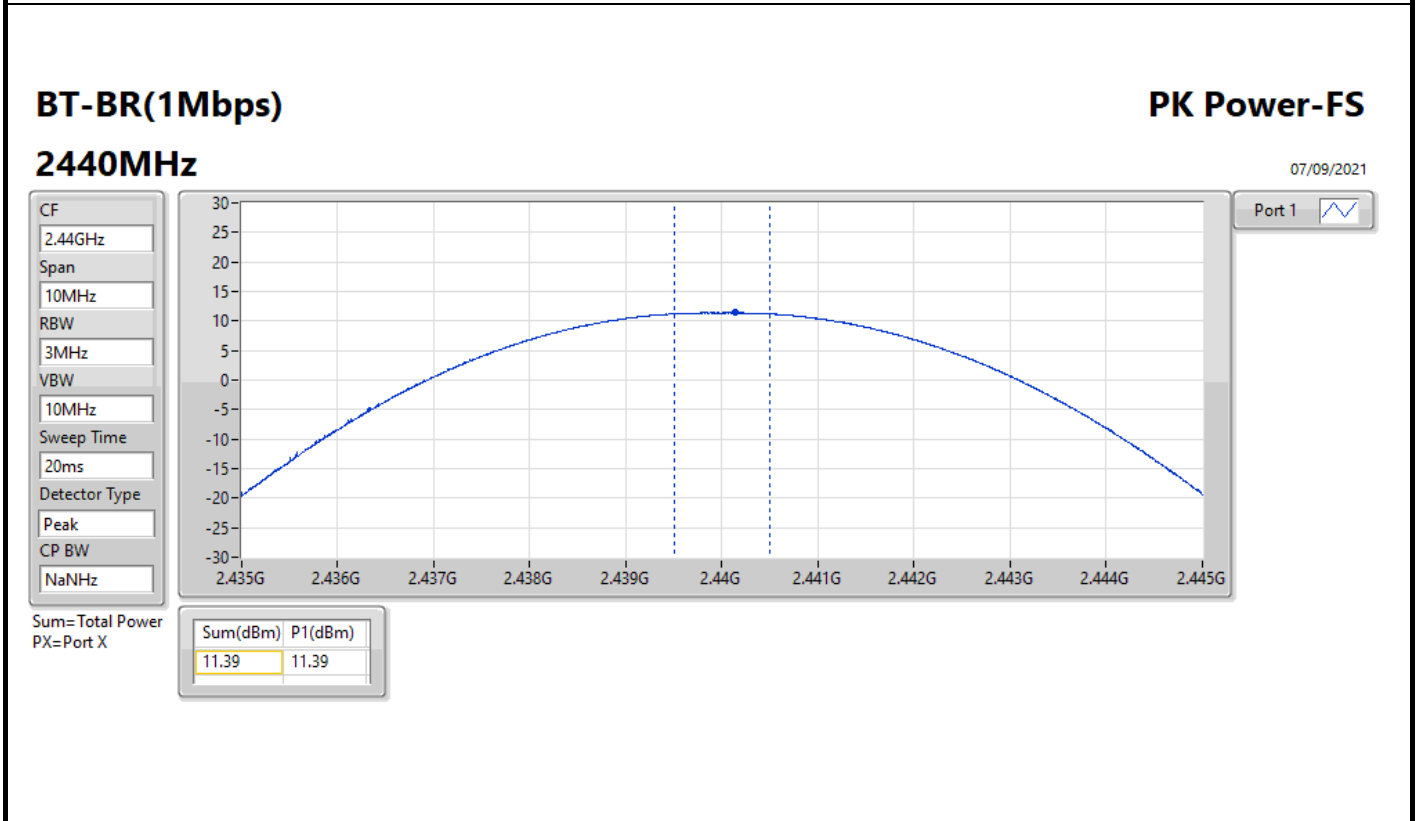
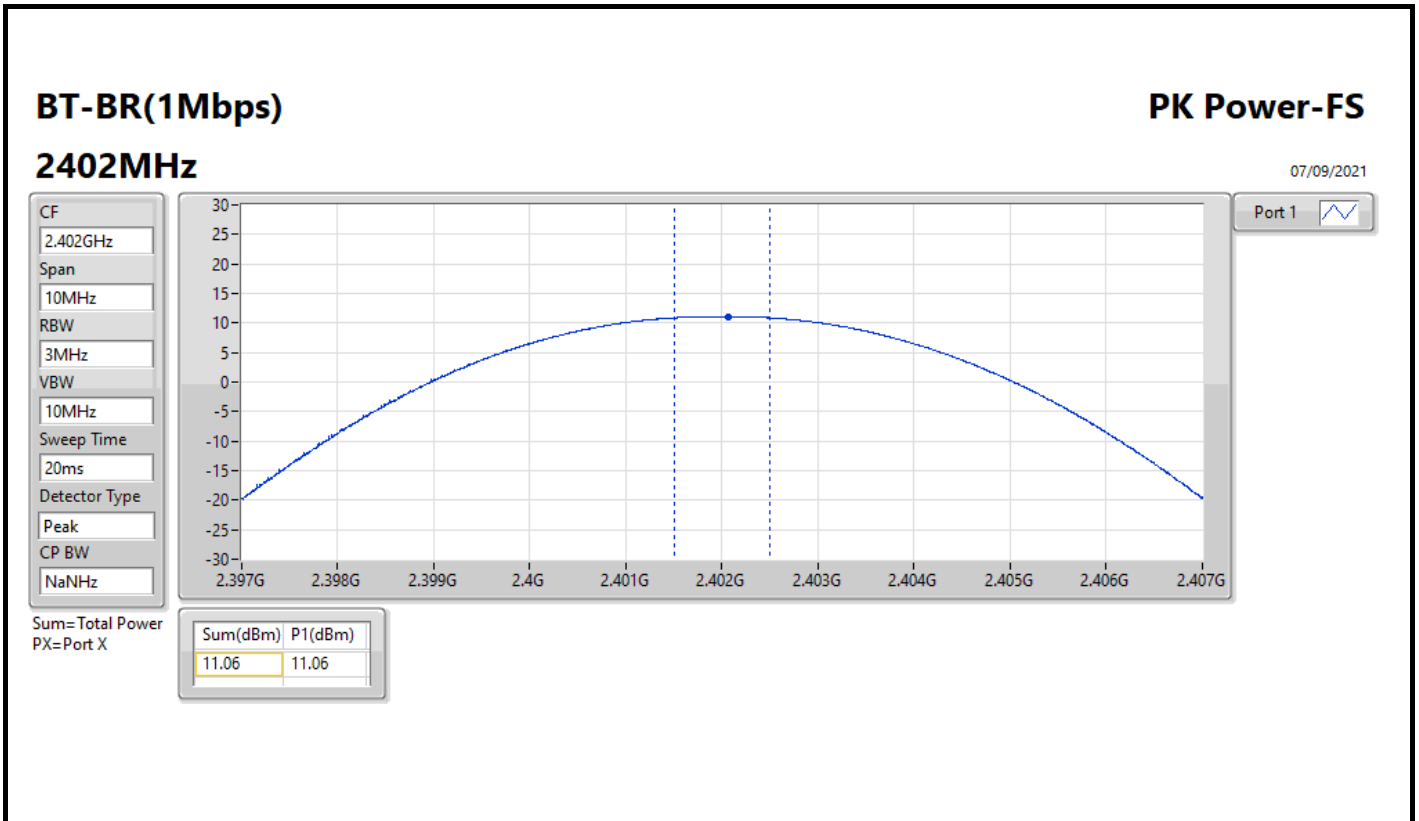

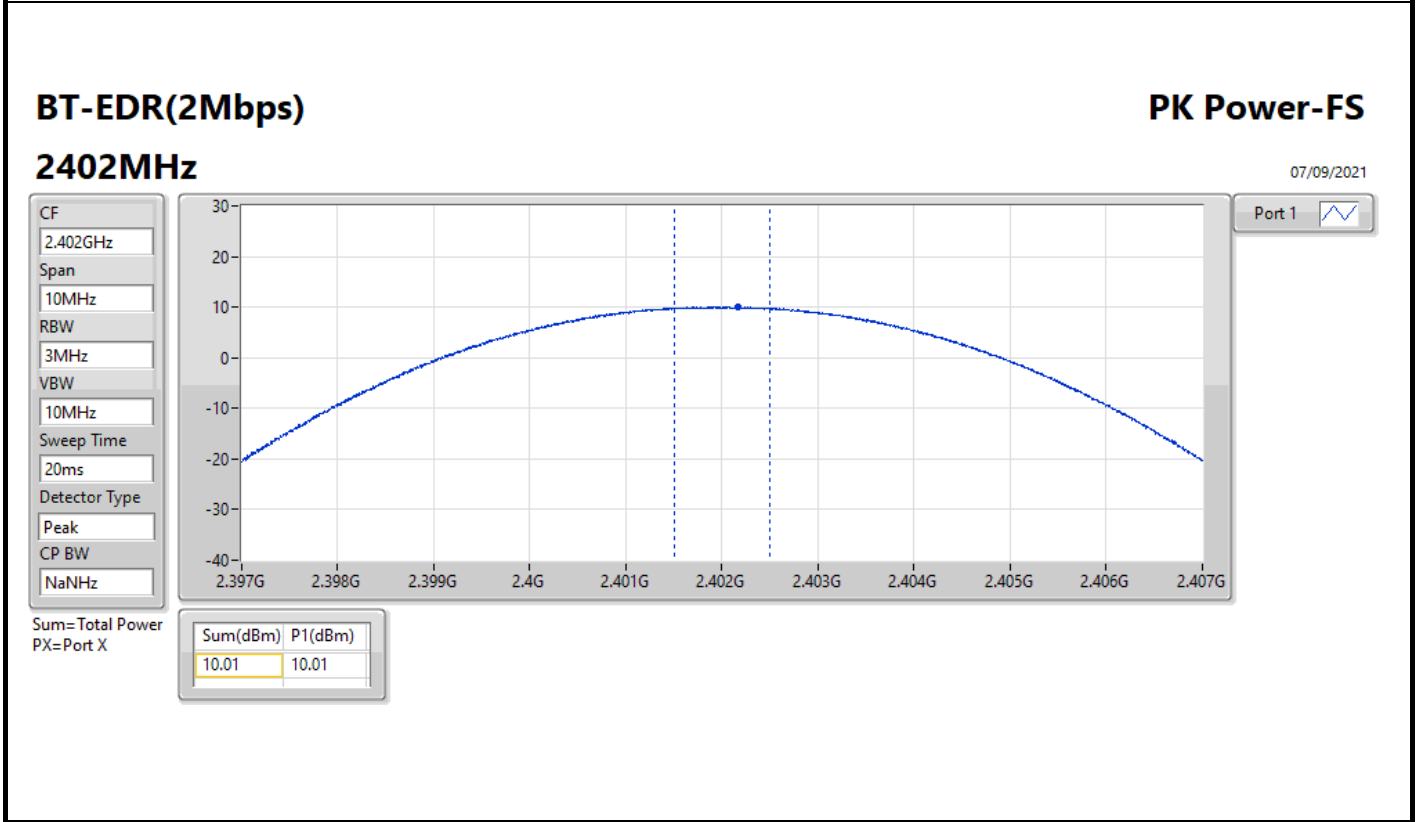
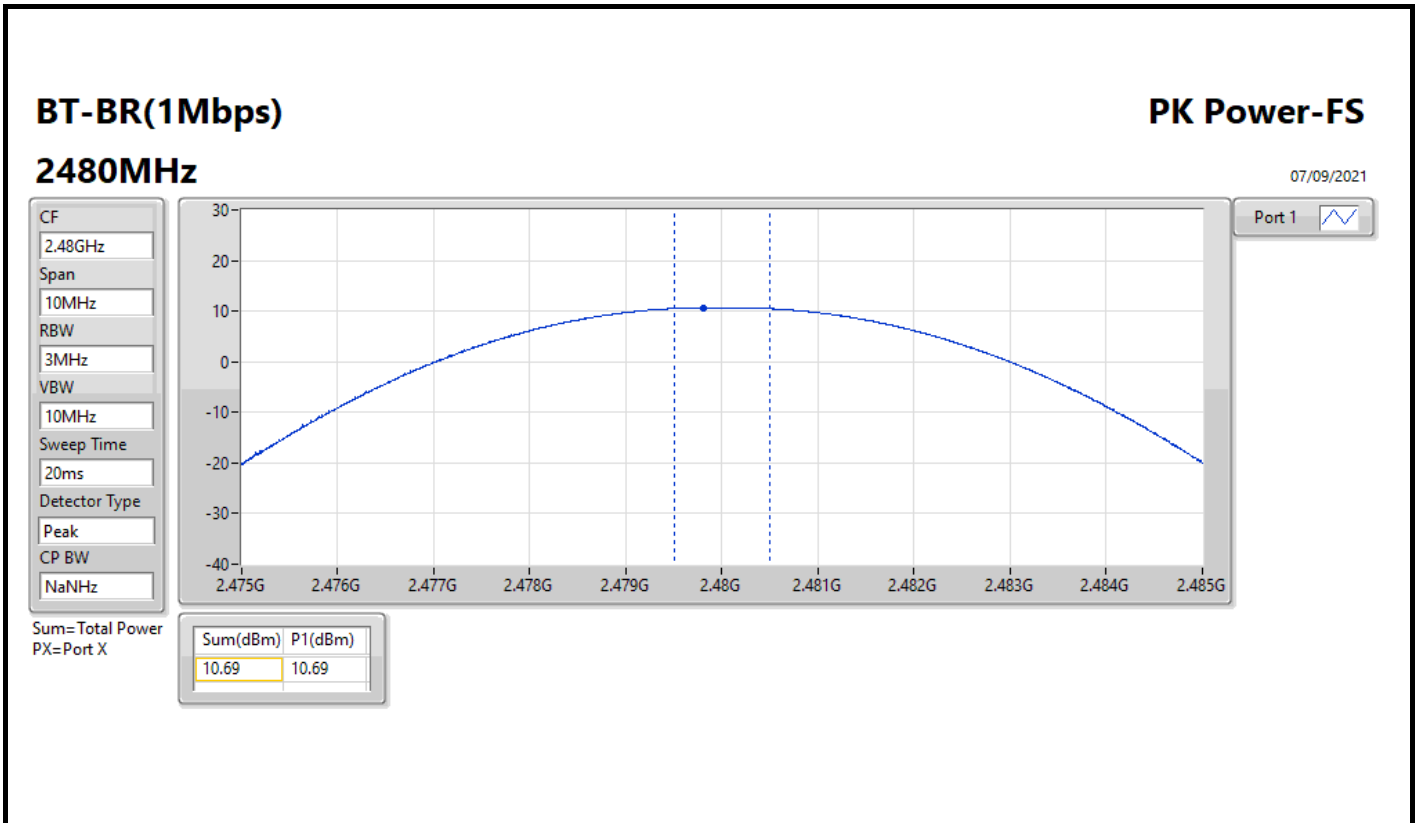

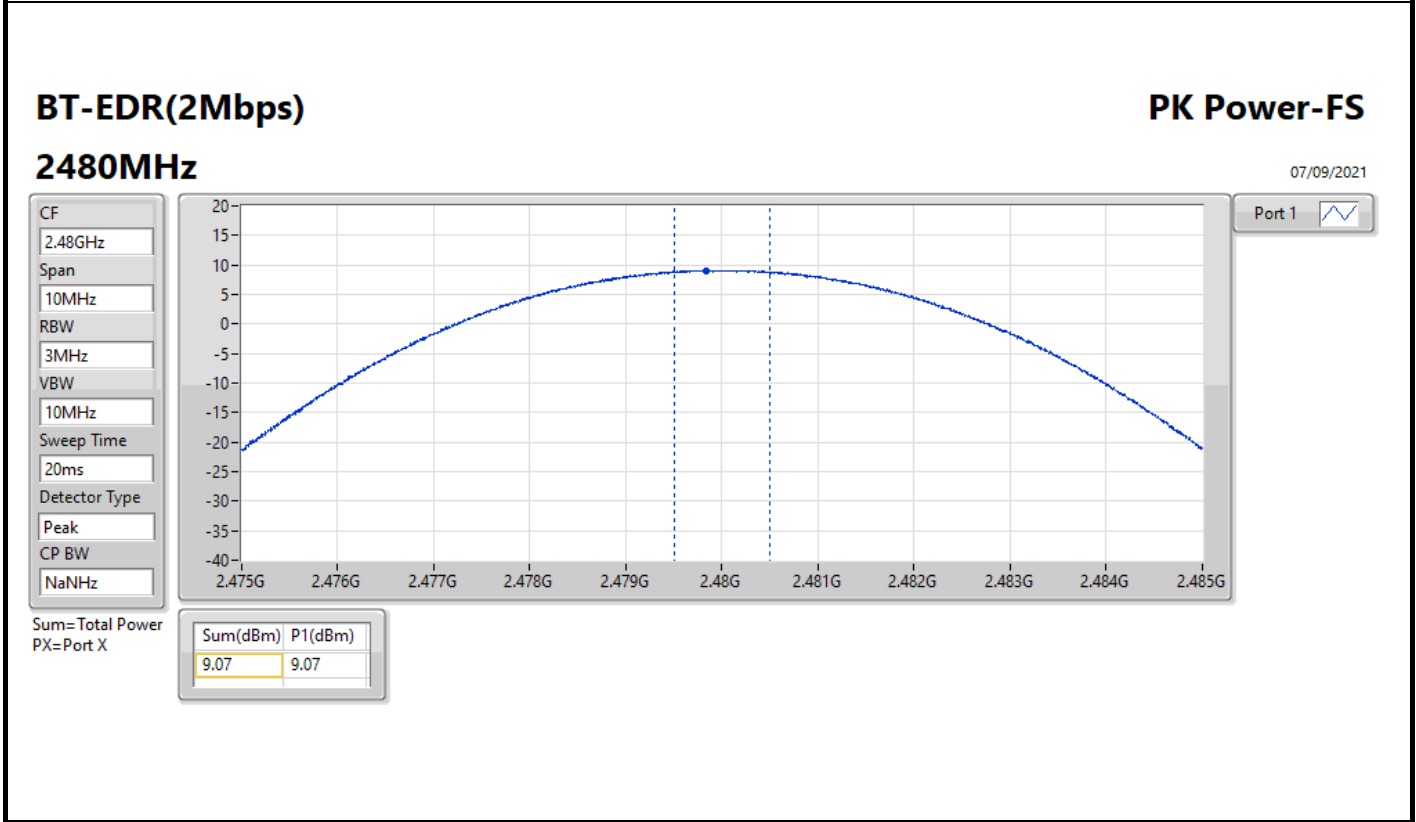
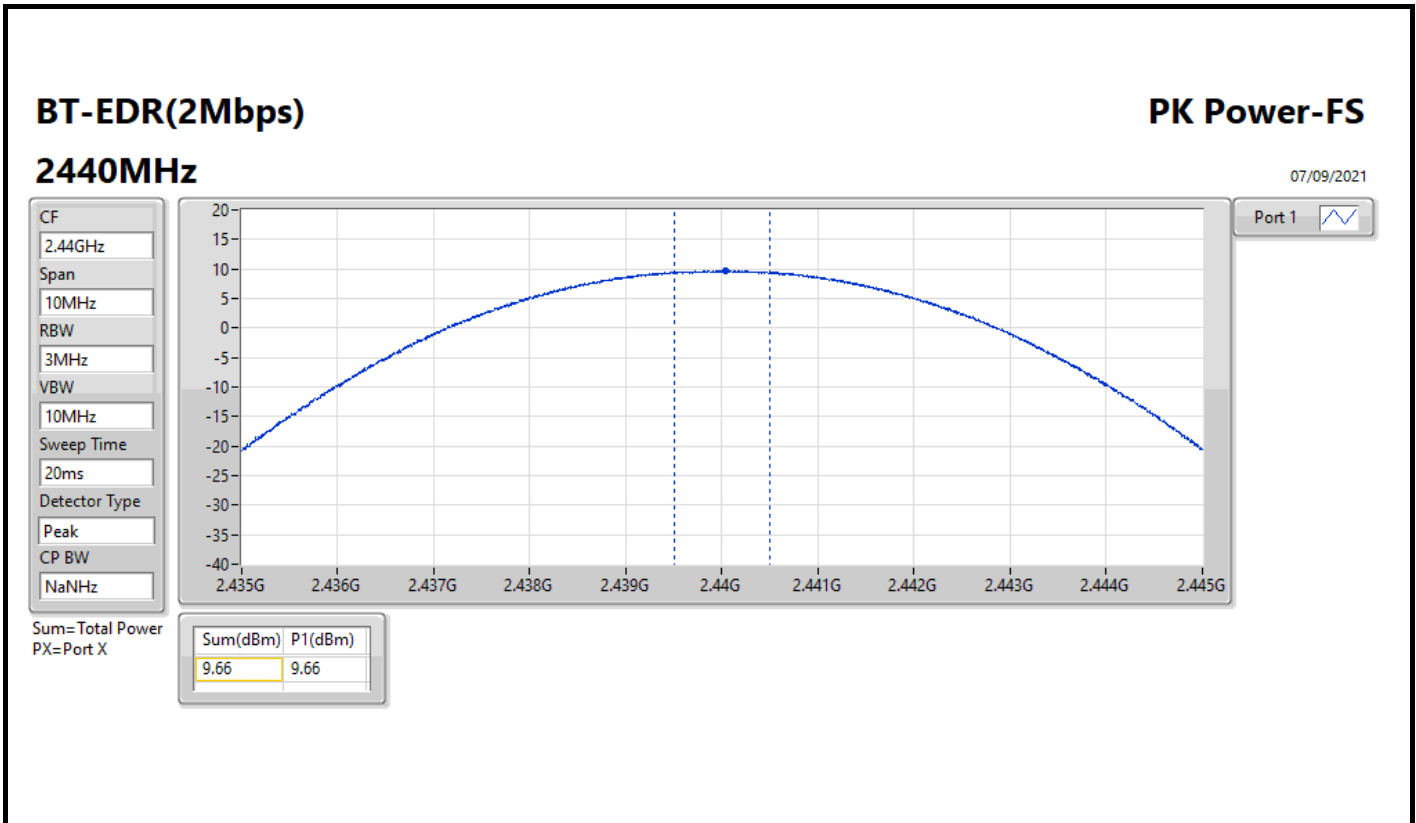

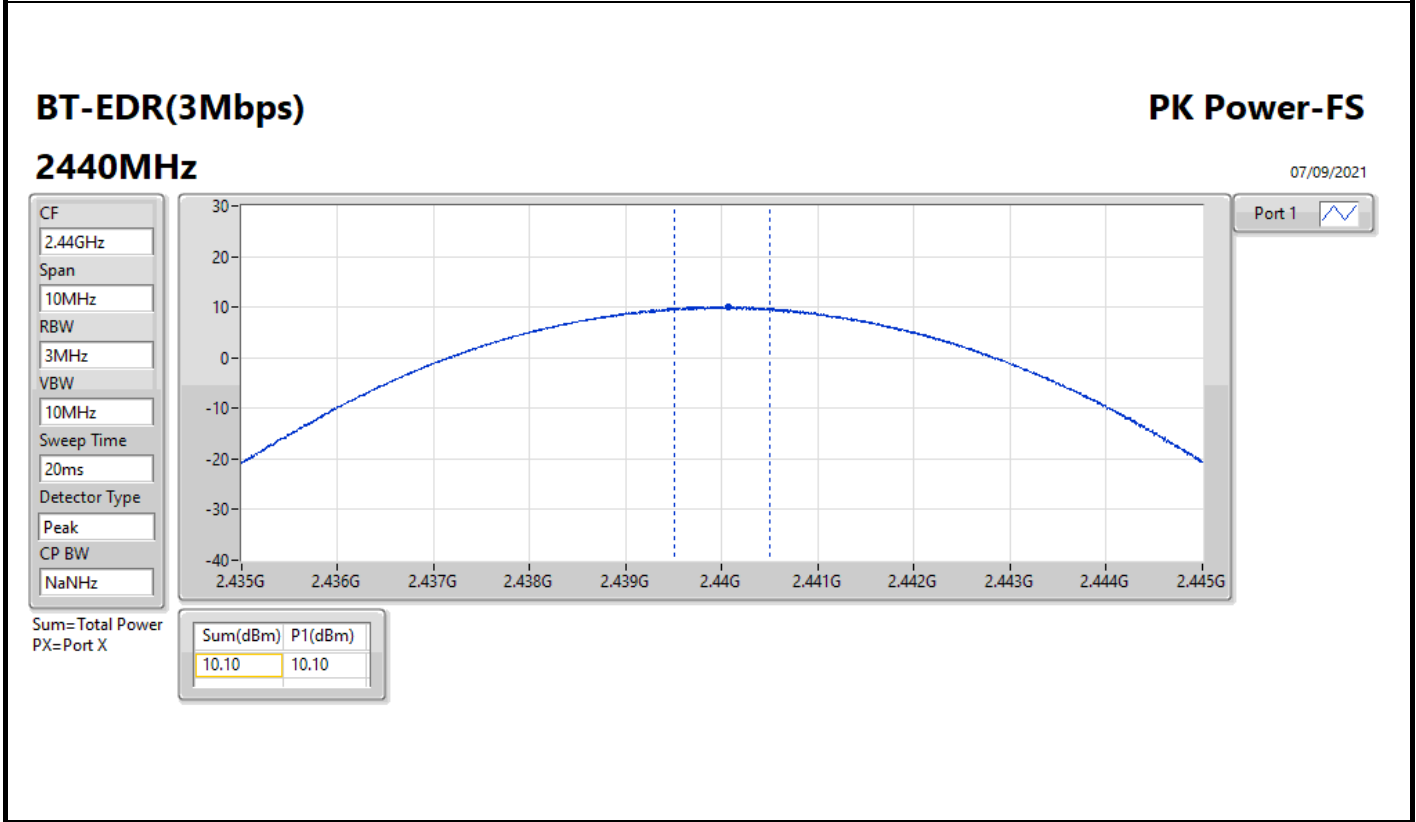
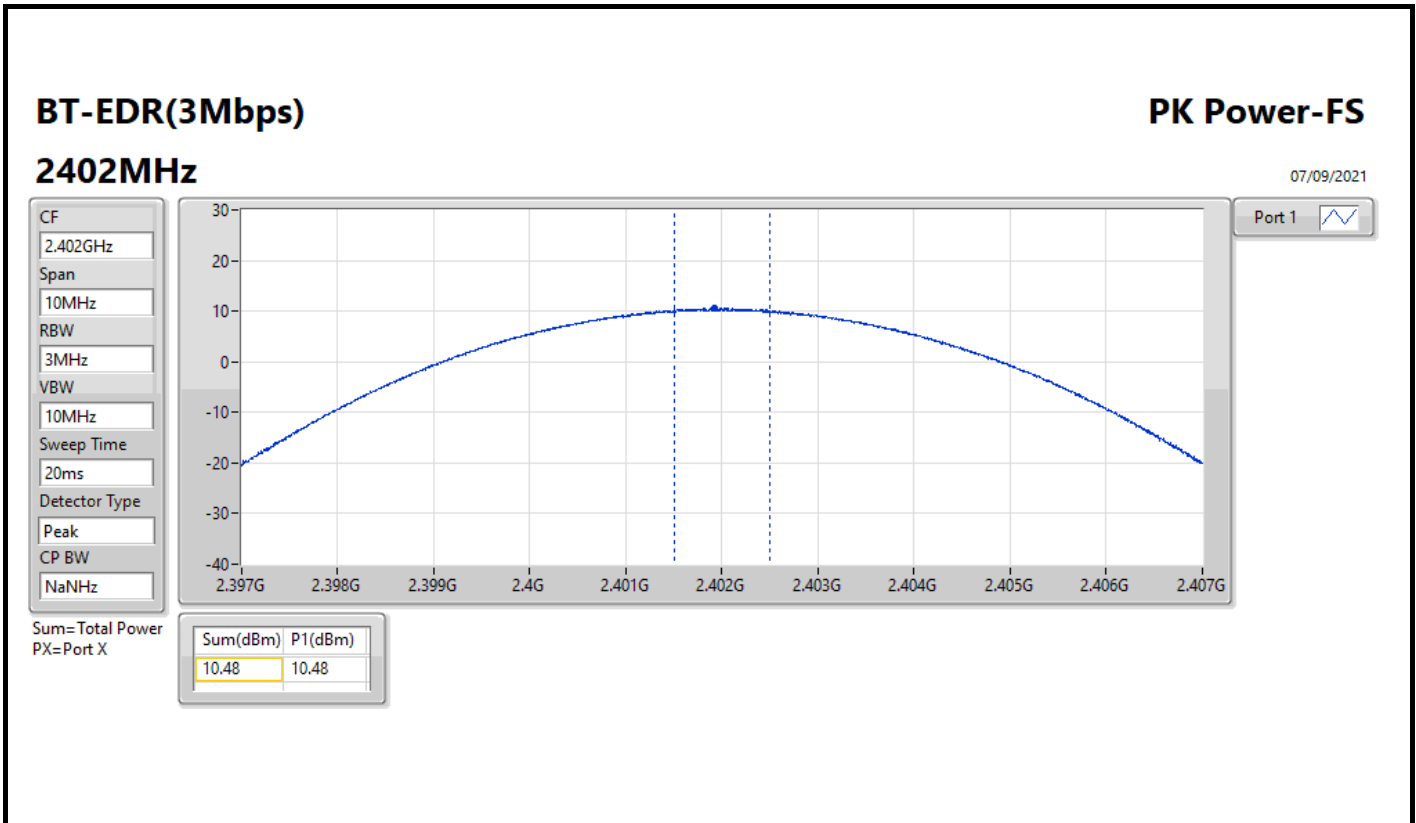

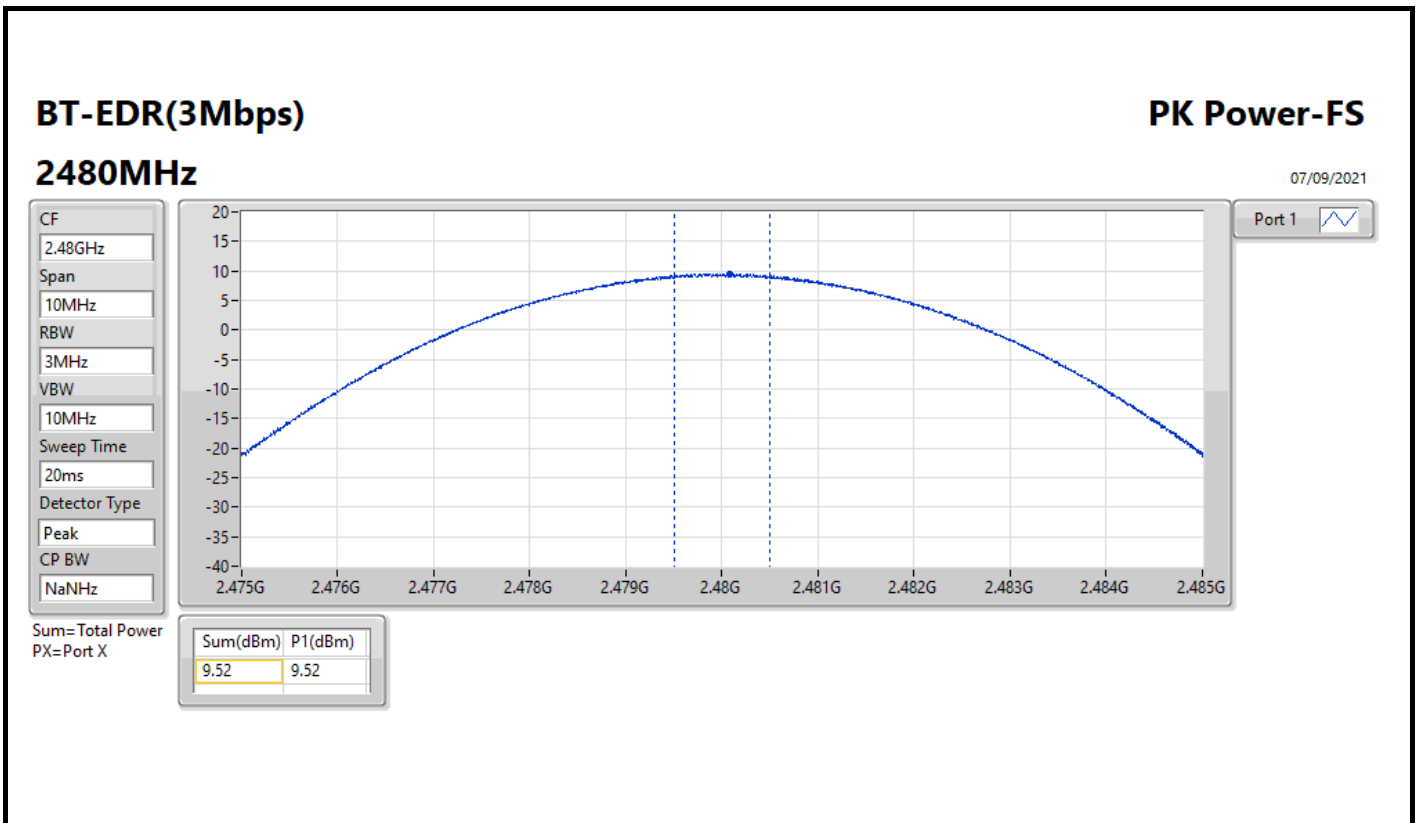



Summary

Mode	Max-Hop No
2.4-2.4835GHz	-
BT-BR(1Mbps)	79
BT-EDR(2Mbps)	79
BT-EDR(3Mbps)	79



Result

Mode	Result	Hopping No	Limit
BT-BR(1Mbps)	-	-	-
2440MHz	Pass	79	15
BT-EDR(2Mbps)	-	-	-
2440MHz	Pass	79	15
BT-EDR(3Mbps)	-	-	-
2440MHz	Pass	79	15

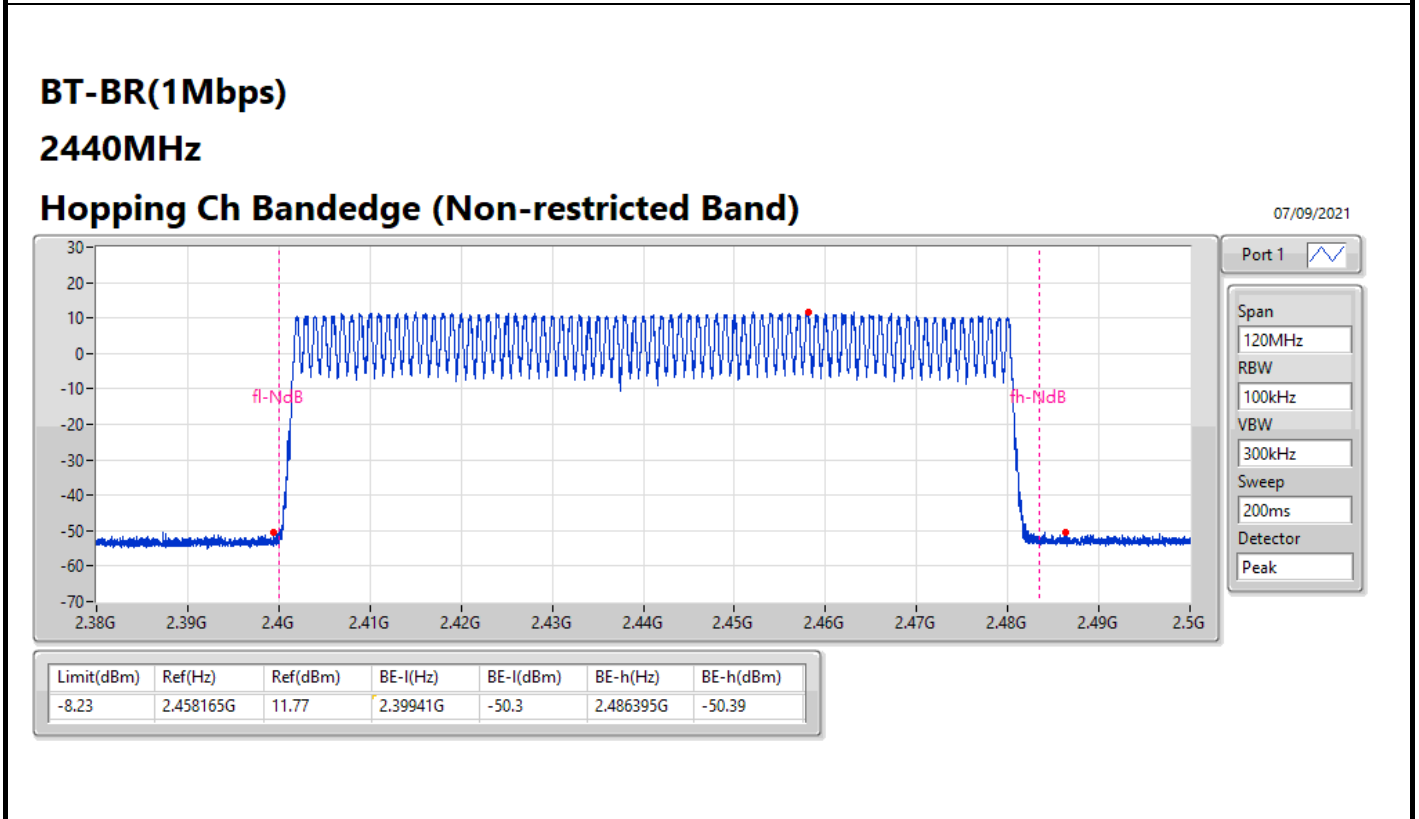
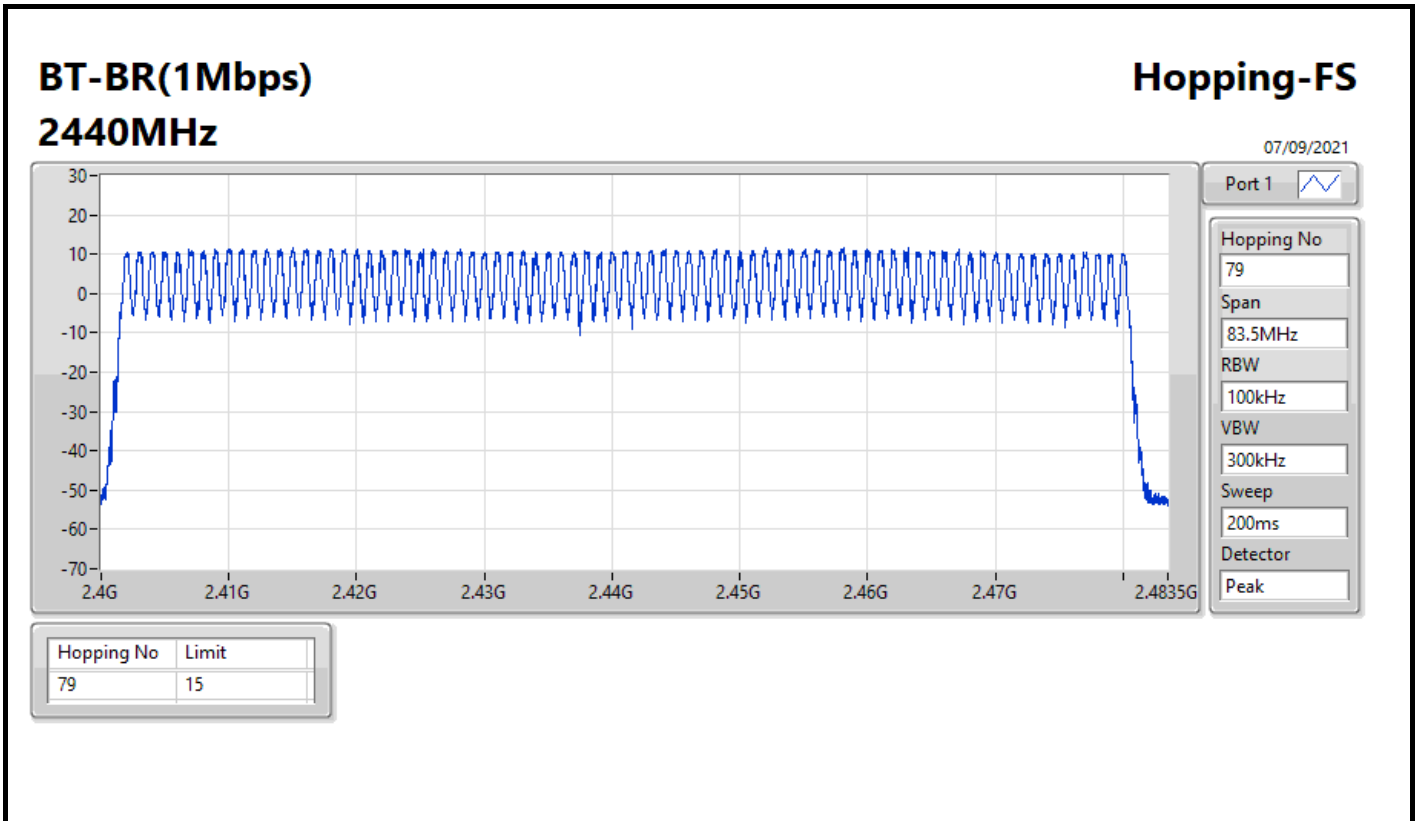

BT-BR(1Mbps)
2440MHz
Hopping Ch Bandedge (Restricted Band)

07/09/2021

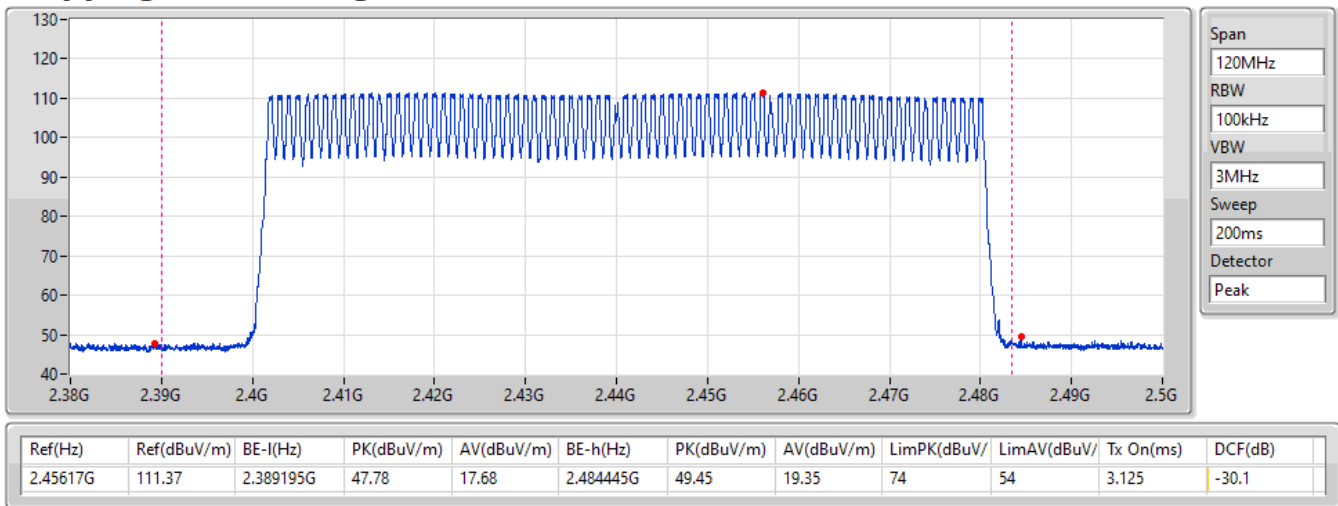

BT-EDR(2Mbps) **Hopping-FS**
2440MHz

07/09/2021

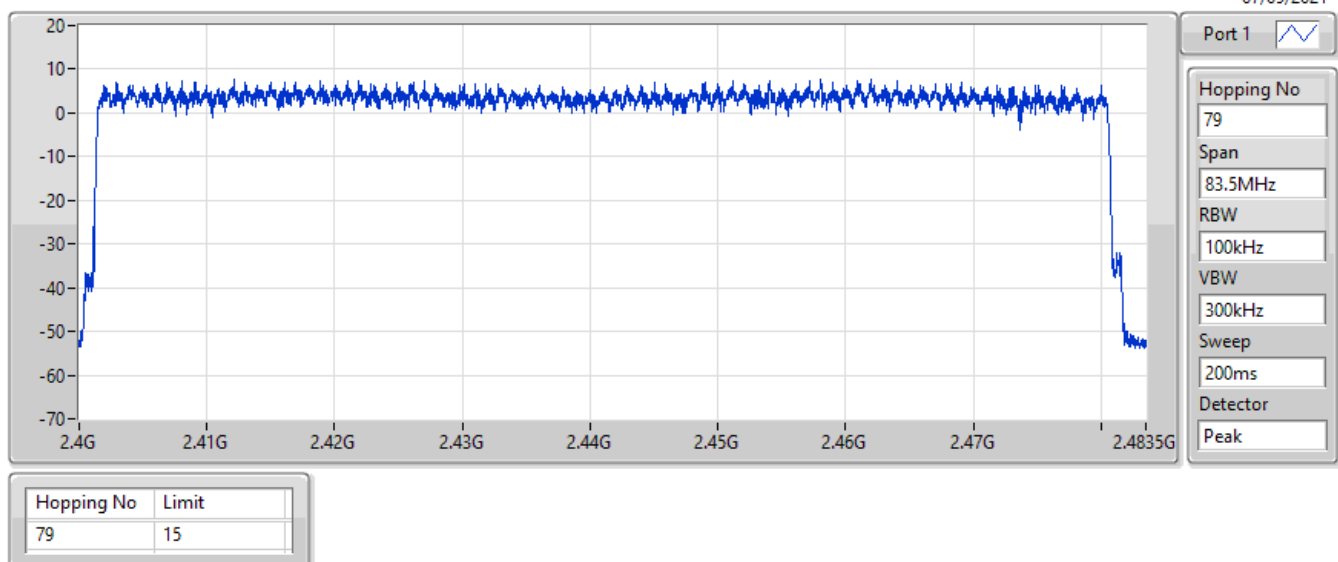

BT-EDR(2Mbps)
2440MHz
Hopping Ch Bandedge (Non-restricted Band)

07/09/2021

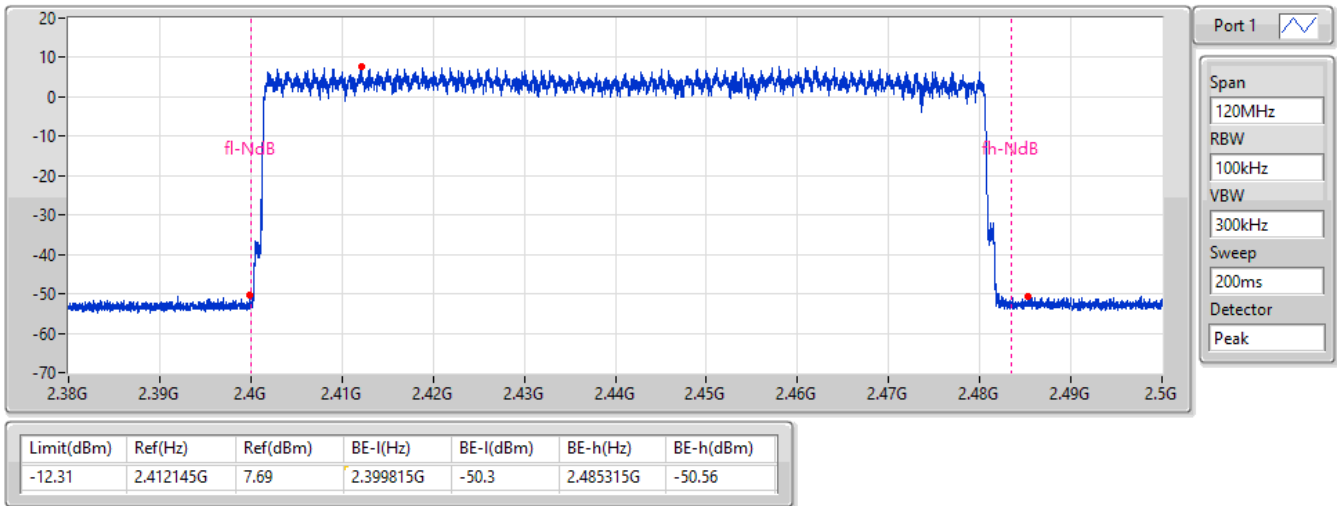

BT-EDR(2Mbps)
2440MHz
Hopping Ch Bandedge (Restricted Band)

07/09/2021

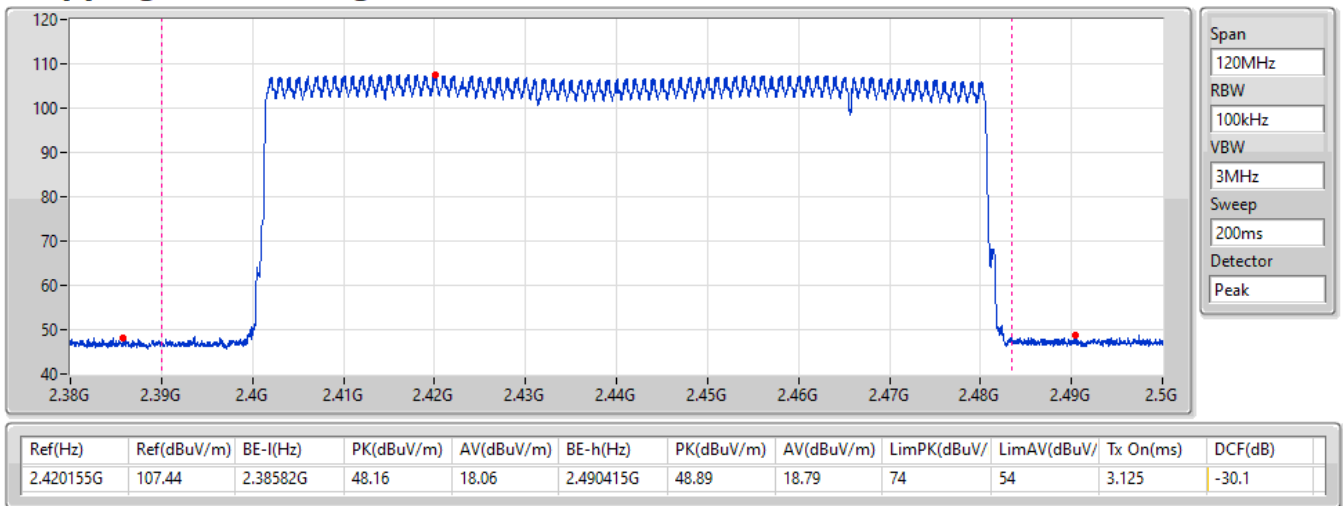

**BT-EDR(3Mbps)
2440MHz**

Hopping-FS

07/09/2021

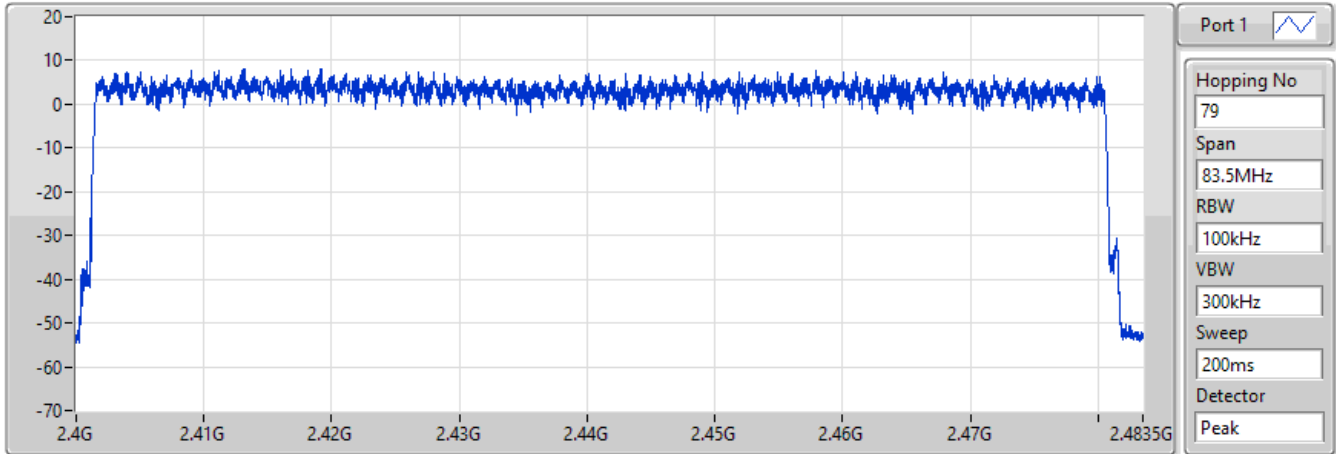

Hopping No	Limit
79	15

**BT-EDR(3Mbps)
2440MHz**

Hopping Ch Bandedge (Non-restricted Band)

07/09/2021

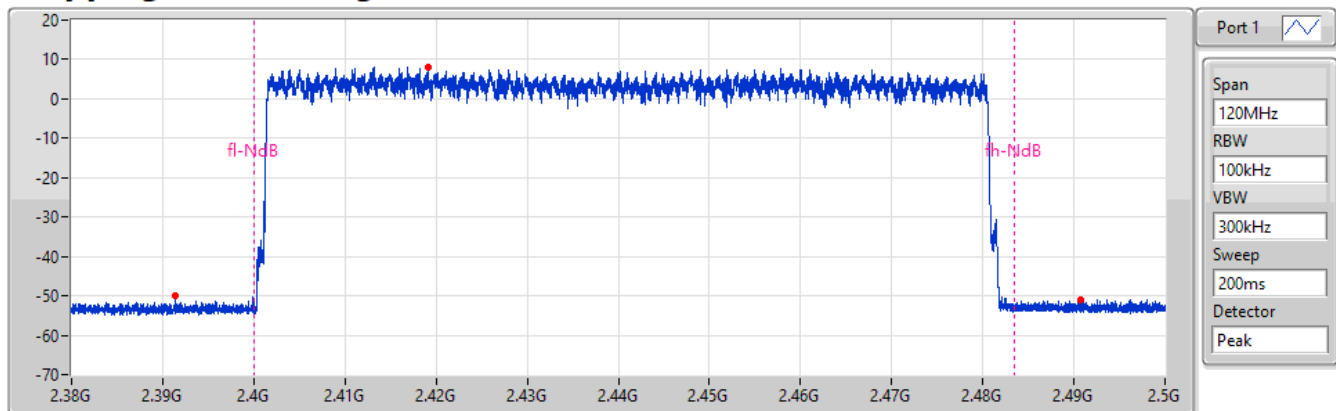

Limit(dBm)	Ref(Hz)	Ref(dBm)	BE-l(Hz)	BE-l(dBm)	BE-h(Hz)	BE-h(dBm)
-11.96	2.41915G	8.04	2.3914G	-50	2.4907G	-51.12

BT-EDR(3Mbps)
2440MHz
Hopping Ch Bandedge (Restricted Band)

07/09/2021

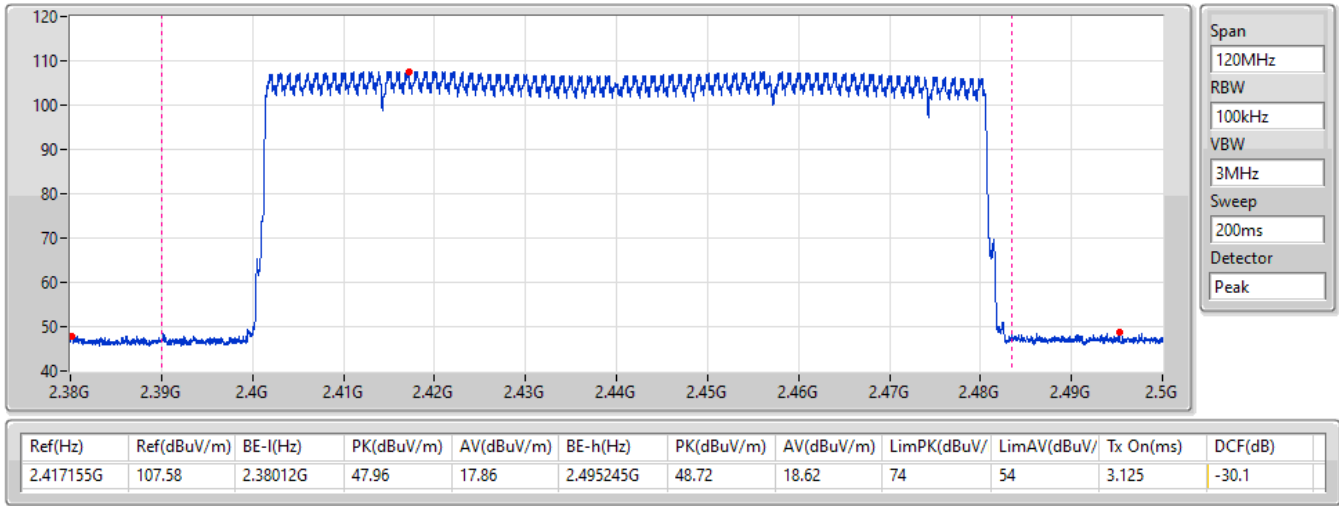



Summary

Mode	Max-Dwell (s)
2.4-2.4835GHz	-
BT-BR(1Mbps)	308.2872m_DH5
BT-EDR(2Mbps)	311.67175m_DH5
BT-EDR(3Mbps)	308.7136m_DH5

Result

Mode	Result	Period (s)	Dwell (s)	Limit (s)	Tx On (s)
BT-BR(1Mbps)	-	-	-	-	-
2440MHz	Pass	31.6	308.2872m_DH5	400m	2.892m
2440MHz	Pass	8	154.17025m_DH5-AFH	400m	2.8925m
BT-EDR(2Mbps)	-	-	-	-	-
2440MHz	Pass	31.6	311.67175m_DH5	400m	2.92375m
2440MHz	Pass	8	155.8492m_DH5-AFH	400m	2.924m
BT-EDR(3Mbps)	-	-	-	-	-
2440MHz	Pass	31.6	308.7136m_DH5	400m	2.896m
2440MHz	Pass	8	154.3568m_DH5-AFH	400m	2.896m

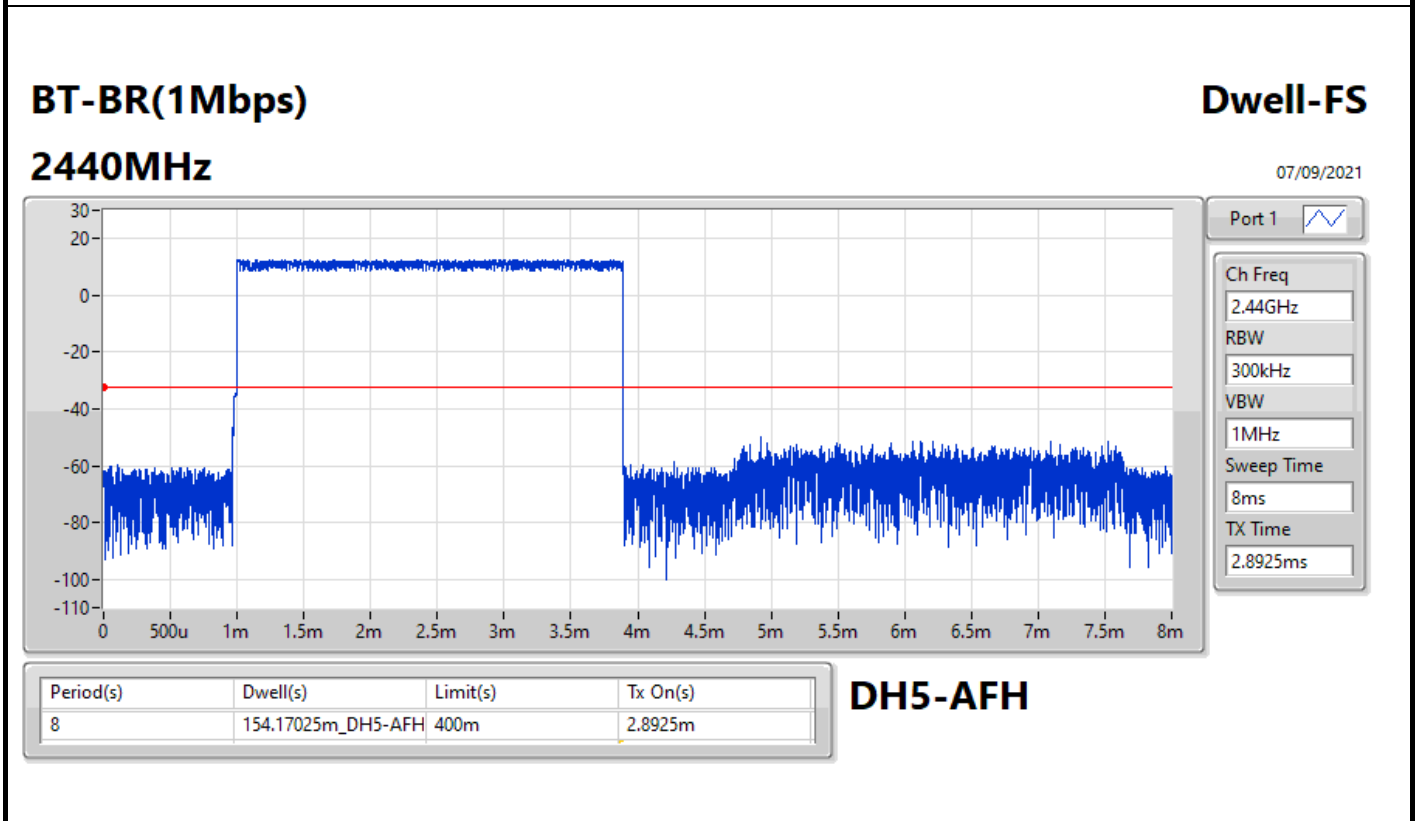
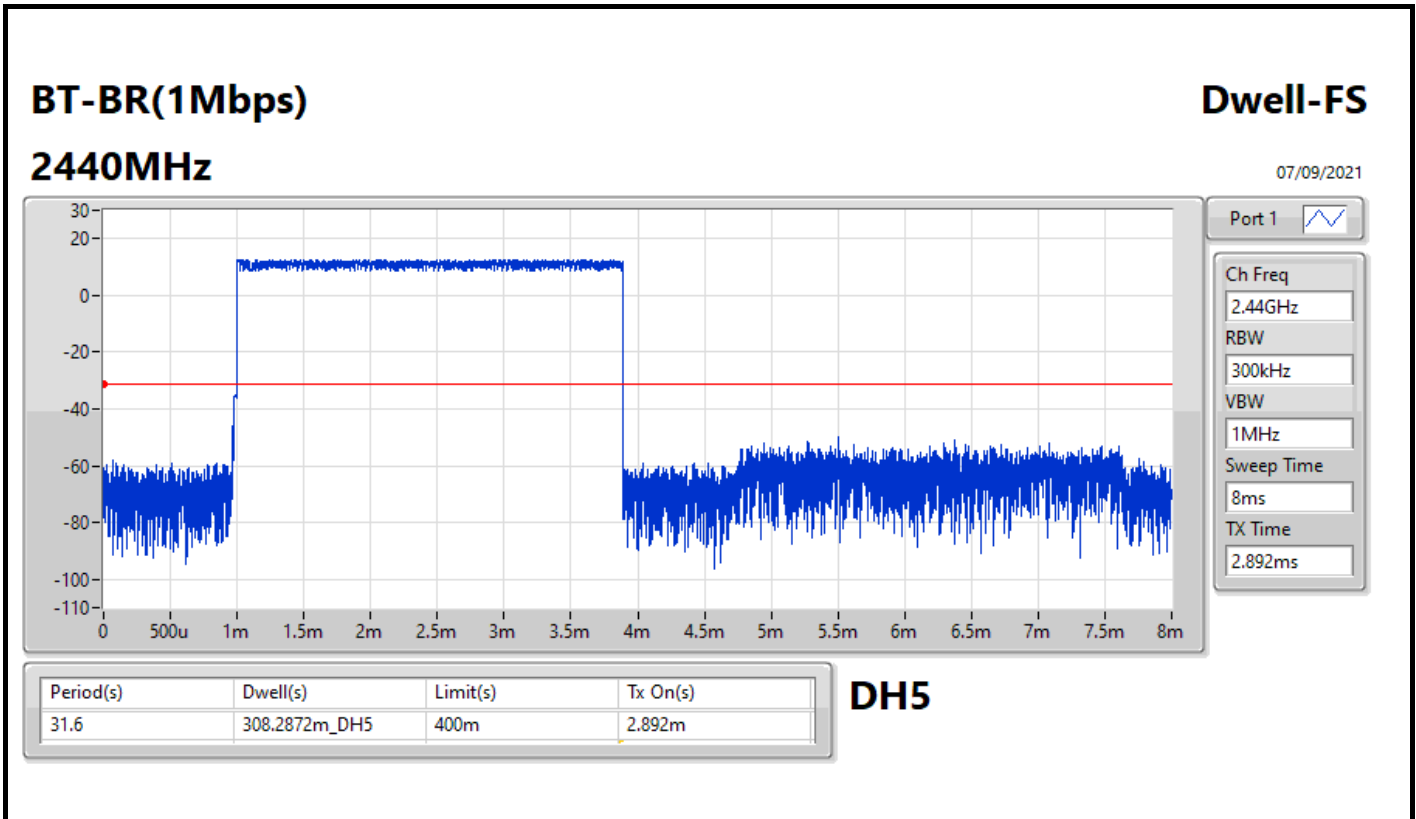

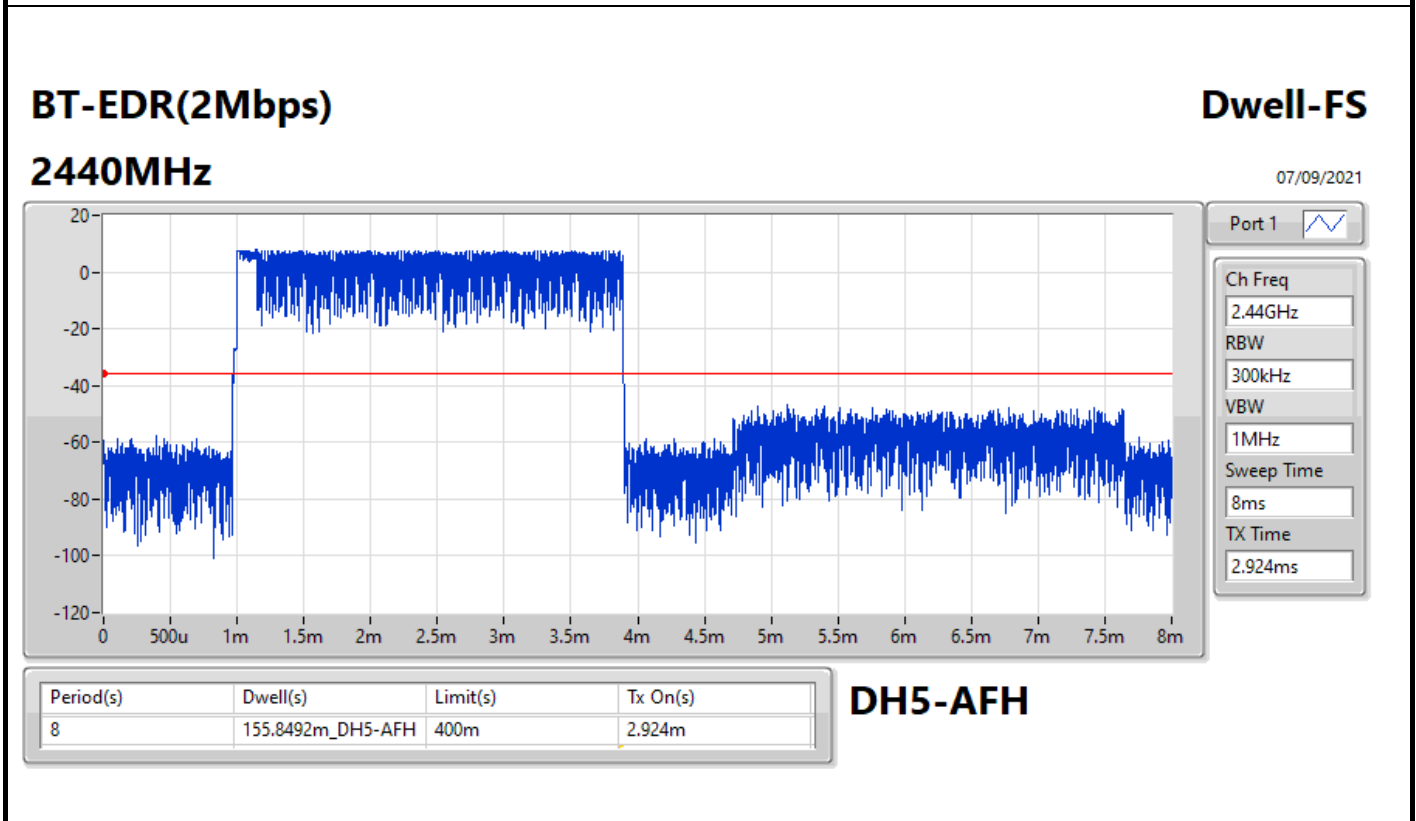
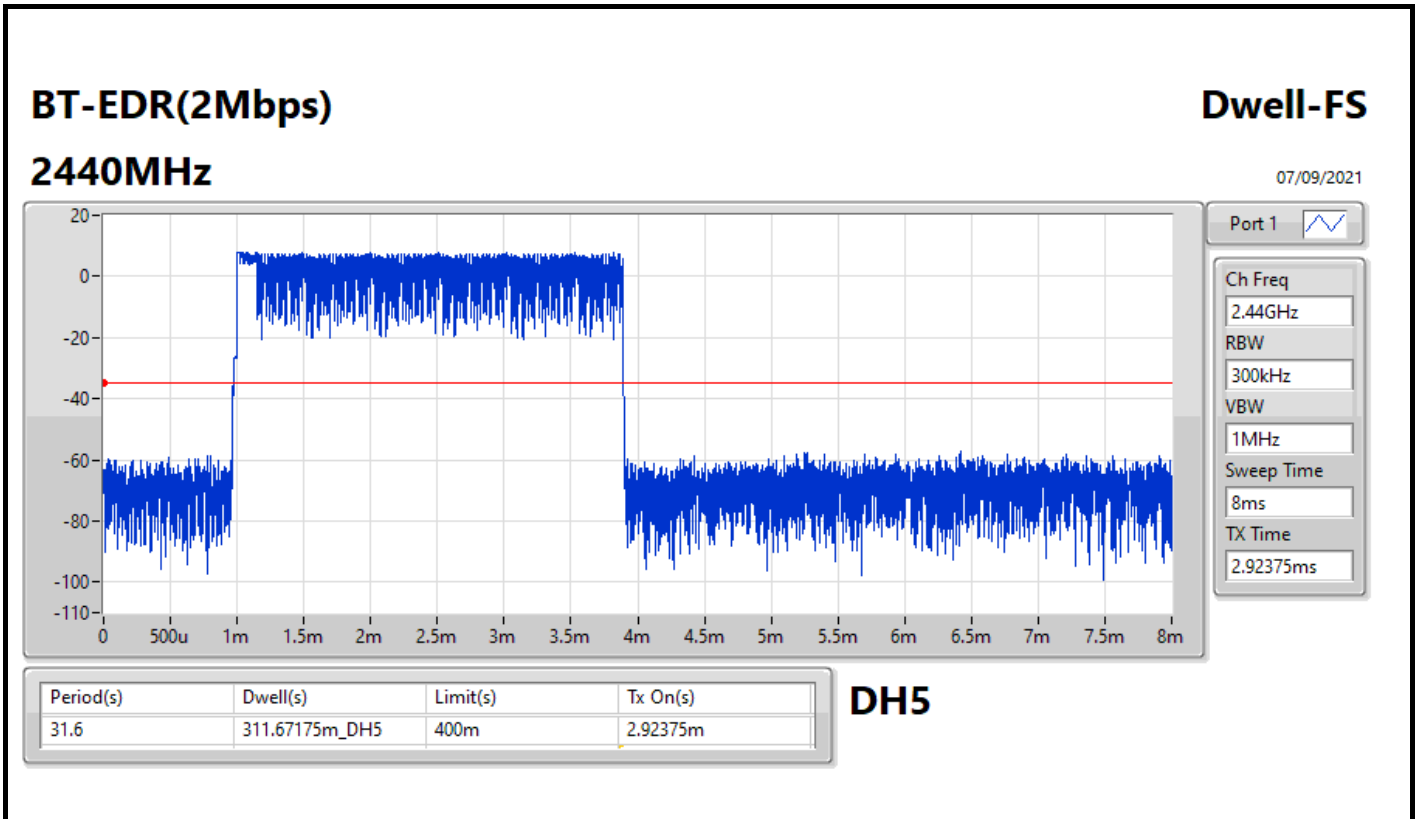

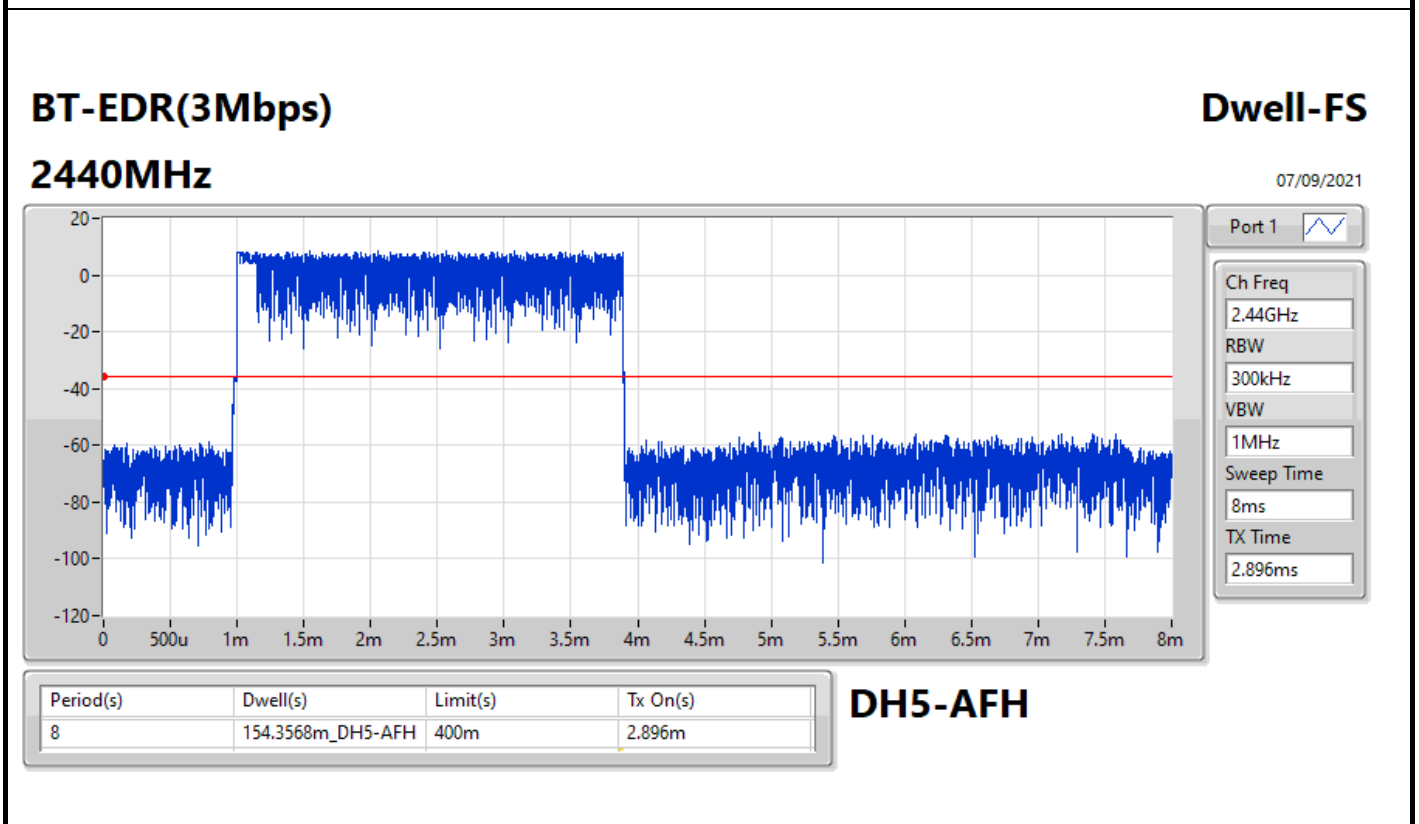
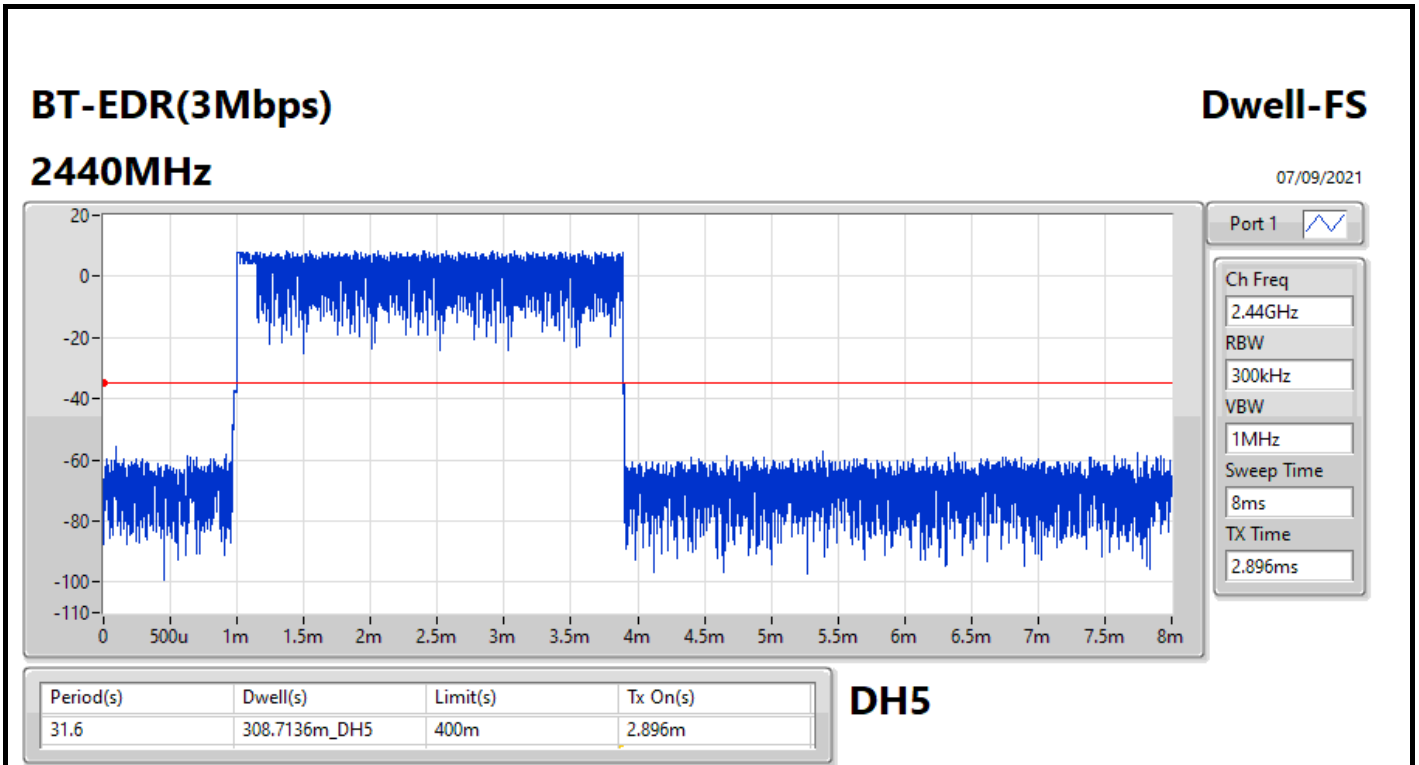



Summary

Mode	Result	Ref (Hz)	Ref (dBm)	Limit (dBm)	Freq (Hz)	Level (dBm)	Freq (Hz)	Level (dBm)	Freq (Hz)	Level (dBm)	Freq (Hz)	Level (dBm)	Freq (Hz)	Level (dBm)	Port
2.4-2.4835GHz	-	-	-	-	-	-	-	-	-	-	-	-	-	-	-
BT-BR(1Mbps)	Pass	2.40184G	10.26	-9.74	1.96288G	-51.34	2.39995G	-48.85	2.4G	-50.72	2.49231G	-50.57	16.4204G	-44.67	1
BT-EDR(2Mbps)	Pass	2.4802G	6.41	-13.59	849.27M	-51.66	2.3998G	-51.66	2.4835G	-53.11	2.48658G	-48.84	24.27168G	-45.81	1
BT-EDR(3Mbps)	Pass	2.48012G	5.35	-14.65	2.16498G	-51.50	2.39373G	-50.82	2.4835G	-54.00	2.48402G	-50.84	24.56413G	-45.33	1

Result

Mode	Result	Ref (Hz)	Ref (dBm)	Limit (dBm)	Freq (Hz)	Level (dBm)	Freq (Hz)	Level (dBm)	Freq (Hz)	Level (dBm)	Freq (Hz)	Level (dBm)	Freq (Hz)	Level (dBm)	Port
BT-BR(1Mbps)	-	-	-	-	-	-	-	-	-	-	-	-	-	-	-
2402MHz	Pass	2.40184G	10.26	-9.74	1.96288G	-51.34	2.39995G	-48.85	2.4G	-50.72	2.49231G	-50.57	16.4204G	-44.67	1
2440MHz	Pass	2.44012G	10.80	-9.20	814.31M	-51.93	2.39652G	-51.41	2.4G	-54.04	2.4946G	-50.51	6.88469G	-45.81	1
2480MHz	Pass	2.48003G	9.89	-10.11	955.31M	-50.45	2.39472G	-52.07	2.4835G	-53.03	2.48393G	-49.29	16.77753G	-44.70	1
BT-EDR(2Mbps)	-	-	-	-	-	-	-	-	-	-	-	-	-	-	-
2402MHz	Pass	2.40196G	6.54	-13.46	1.98285G	-51.18	2.39962G	-49.91	2.4G	-49.90	2.50019G	-51.15	16.71285G	-45.16	1
2440MHz	Pass	2.43983G	6.53	-13.47	1.78663G	-52.04	2.3926G	-51.81	2.4G	-53.65	2.49344G	-50.08	16.86189G	-45.56	1
2480MHz	Pass	2.4802G	6.41	-13.59	849.27M	-51.66	2.3998G	-51.66	2.4835G	-53.11	2.48658G	-48.84	24.27168G	-45.81	1
BT-EDR(3Mbps)	-	-	-	-	-	-	-	-	-	-	-	-	-	-	-
2402MHz	Pass	2.40184G	6.92	-13.08	1.82481G	-51.96	2.39981G	-50.08	2.4G	-52.31	2.50051G	-51.40	6.89875G	-46.30	1
2440MHz	Pass	2.44G	6.89	-13.11	918.89M	-52.40	2.39477G	-51.57	2.4835G	-54.29	2.49634G	-51.03	17.44118G	-45.27	1
2480MHz	Pass	2.48012G	5.35	-14.65	2.16498G	-51.50	2.39373G	-50.82	2.4835G	-54.00	2.48402G	-50.84	24.56413G	-45.33	1

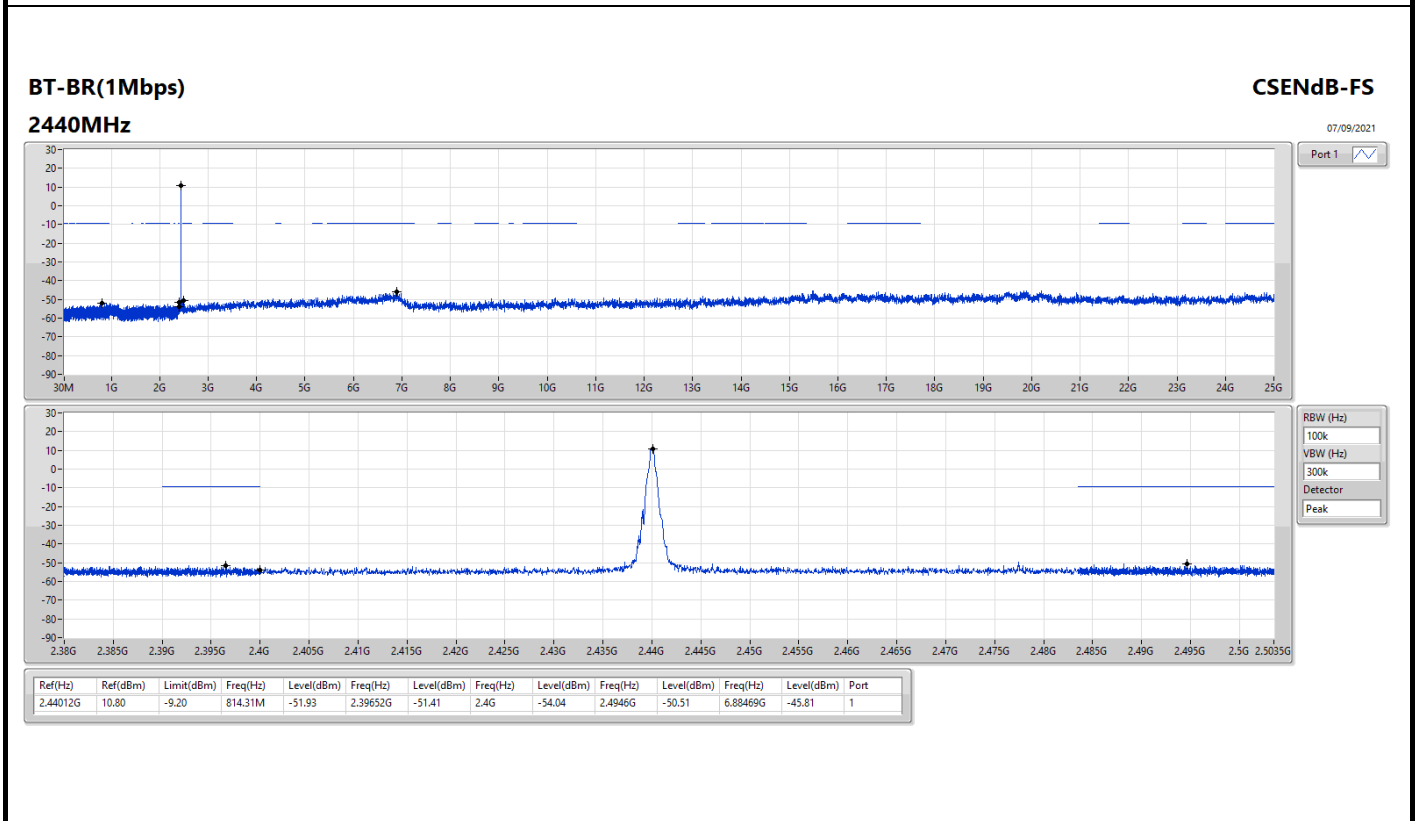
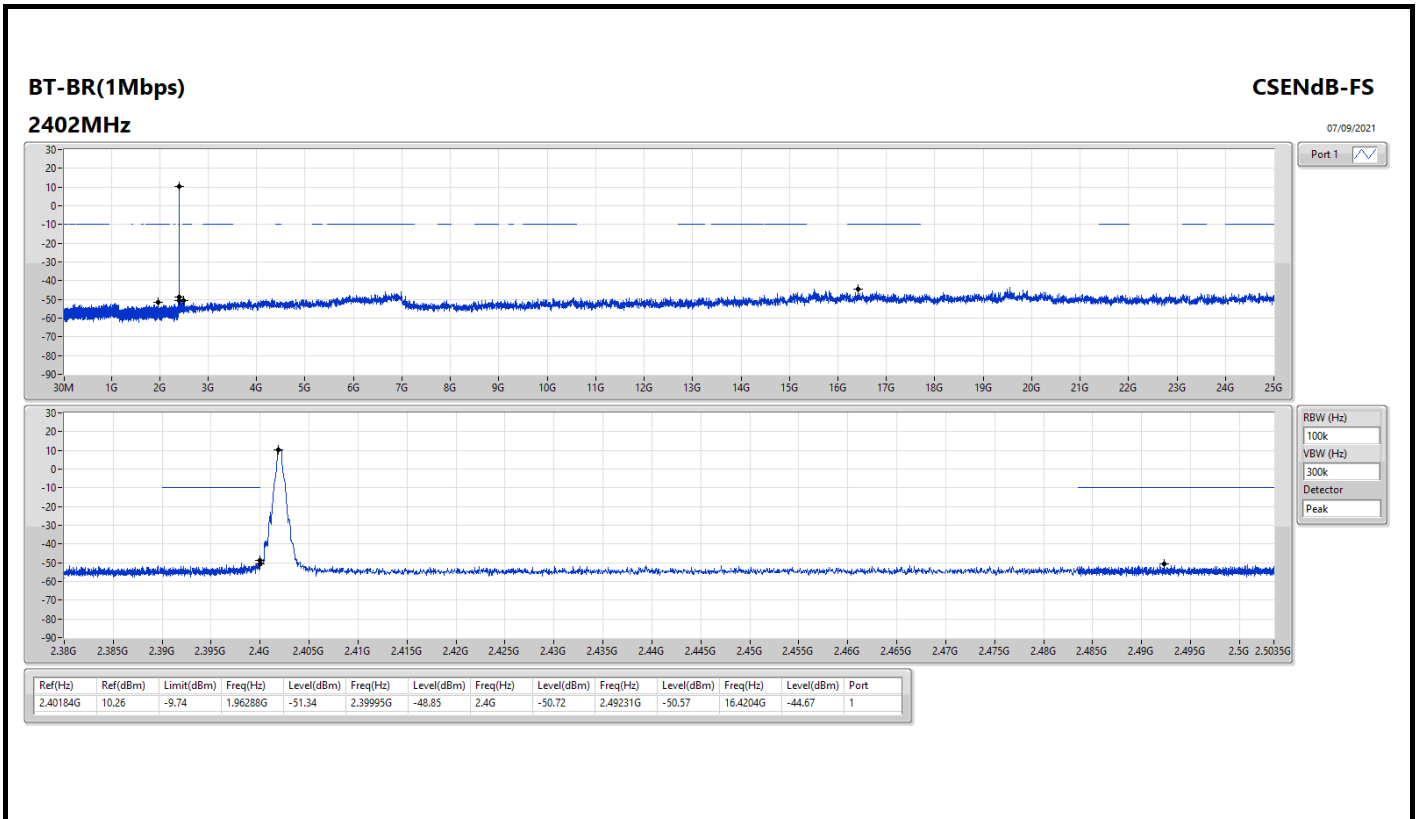

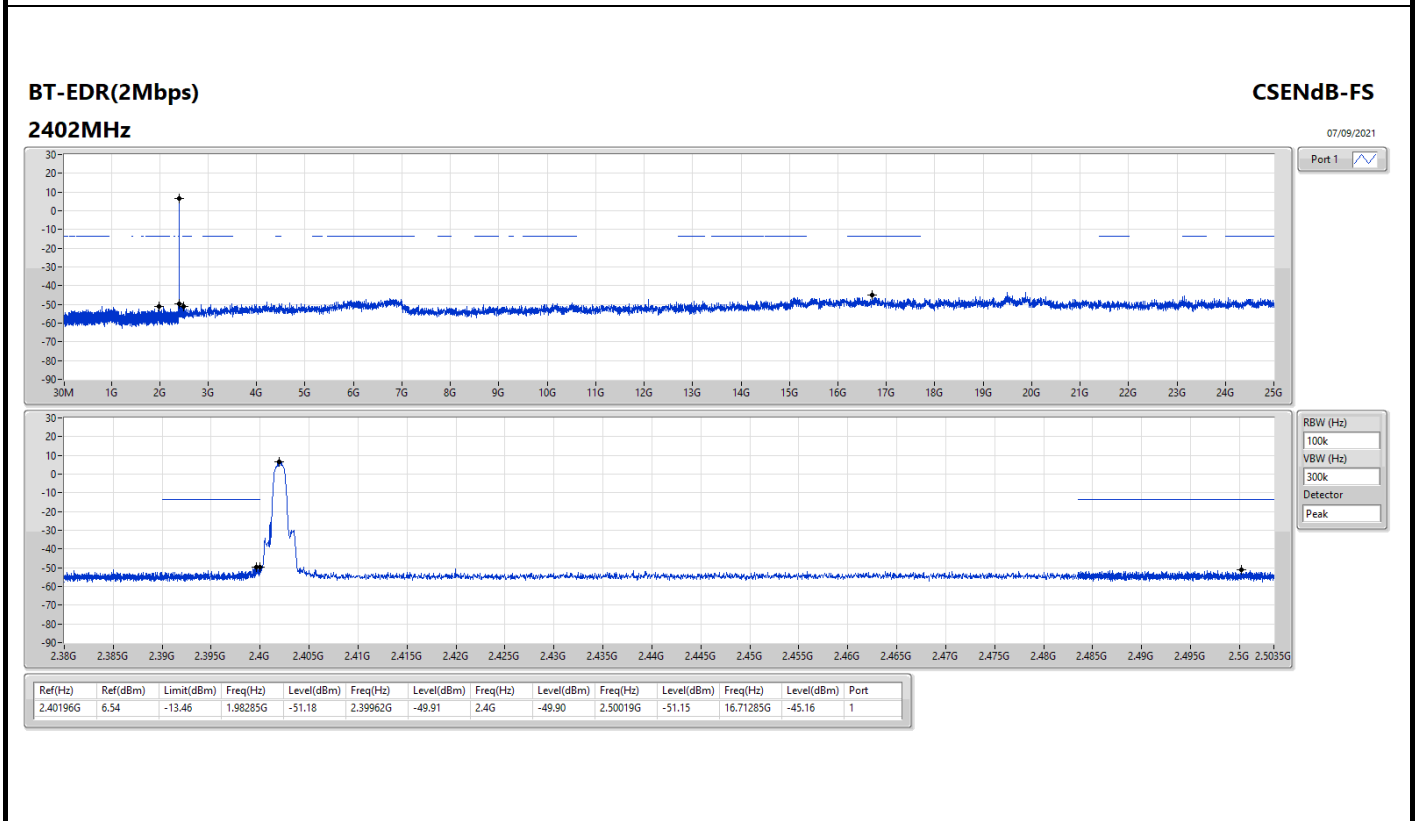
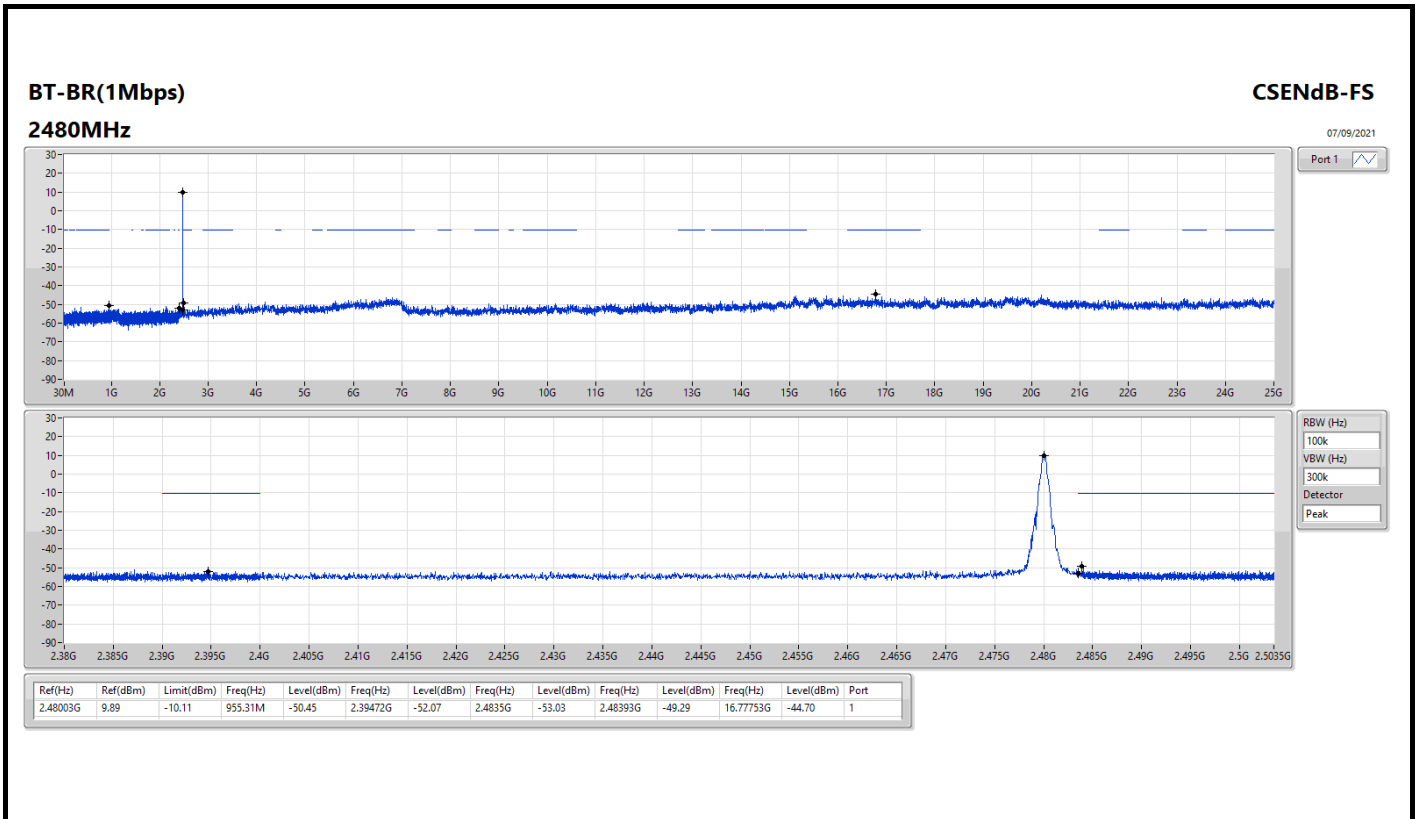

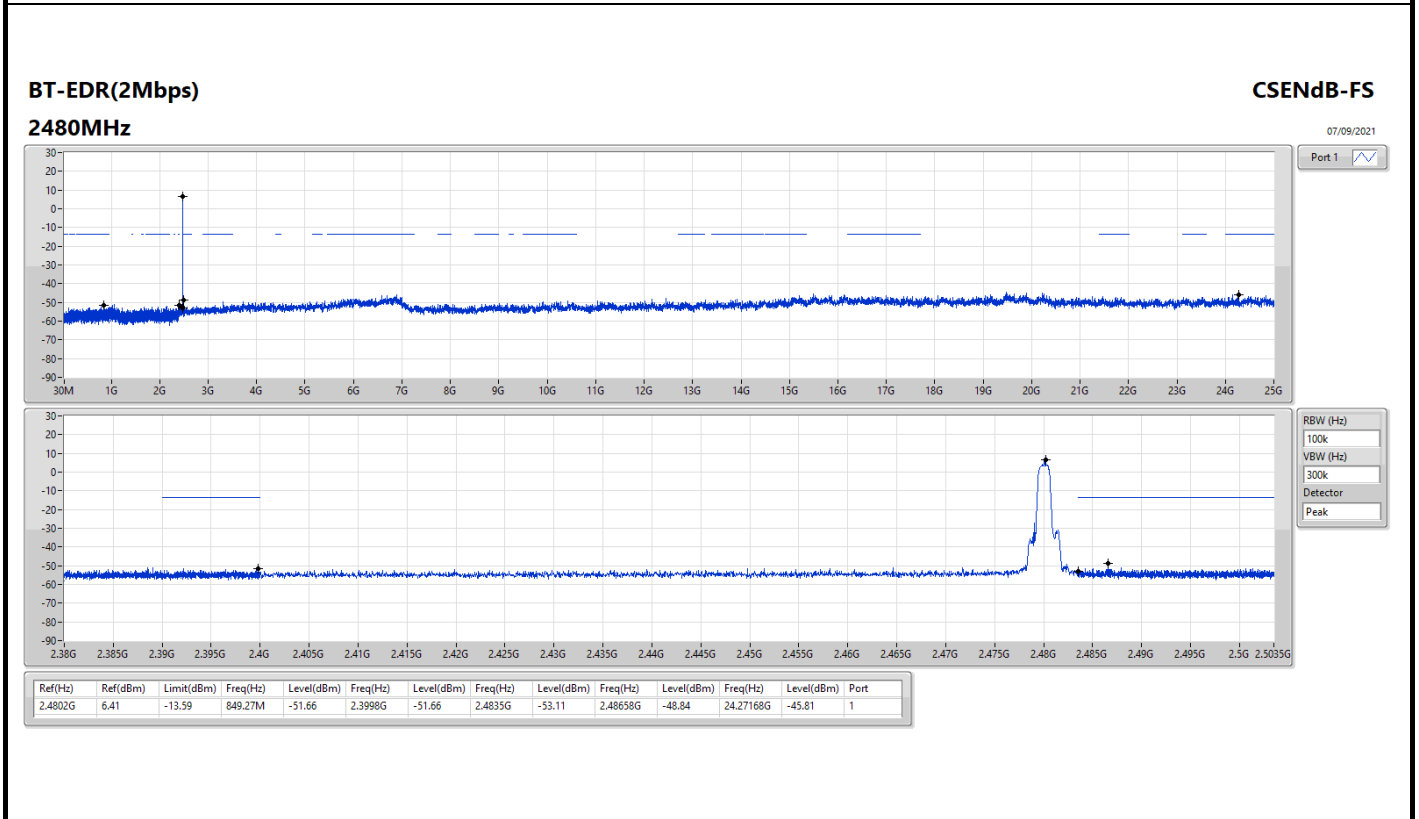
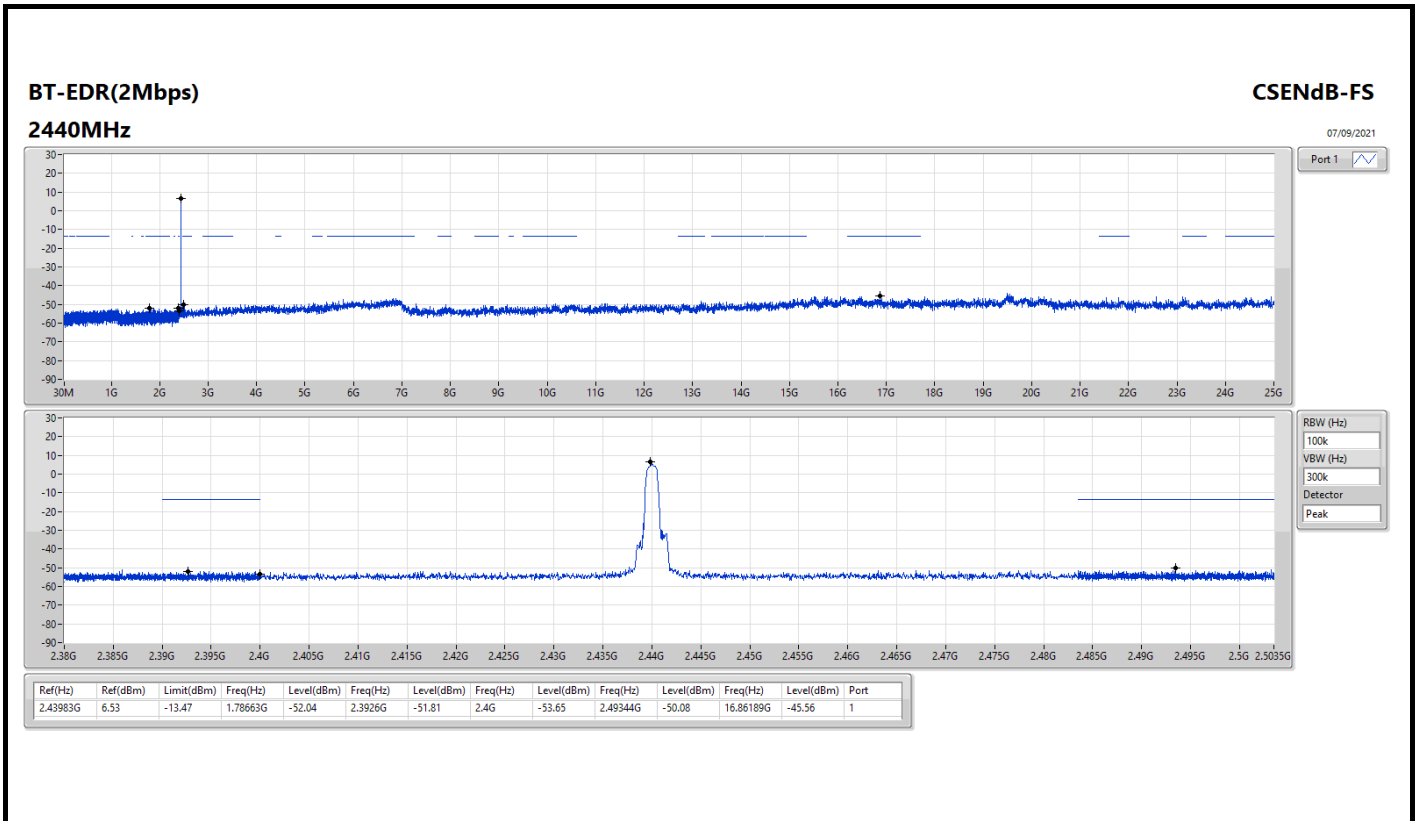

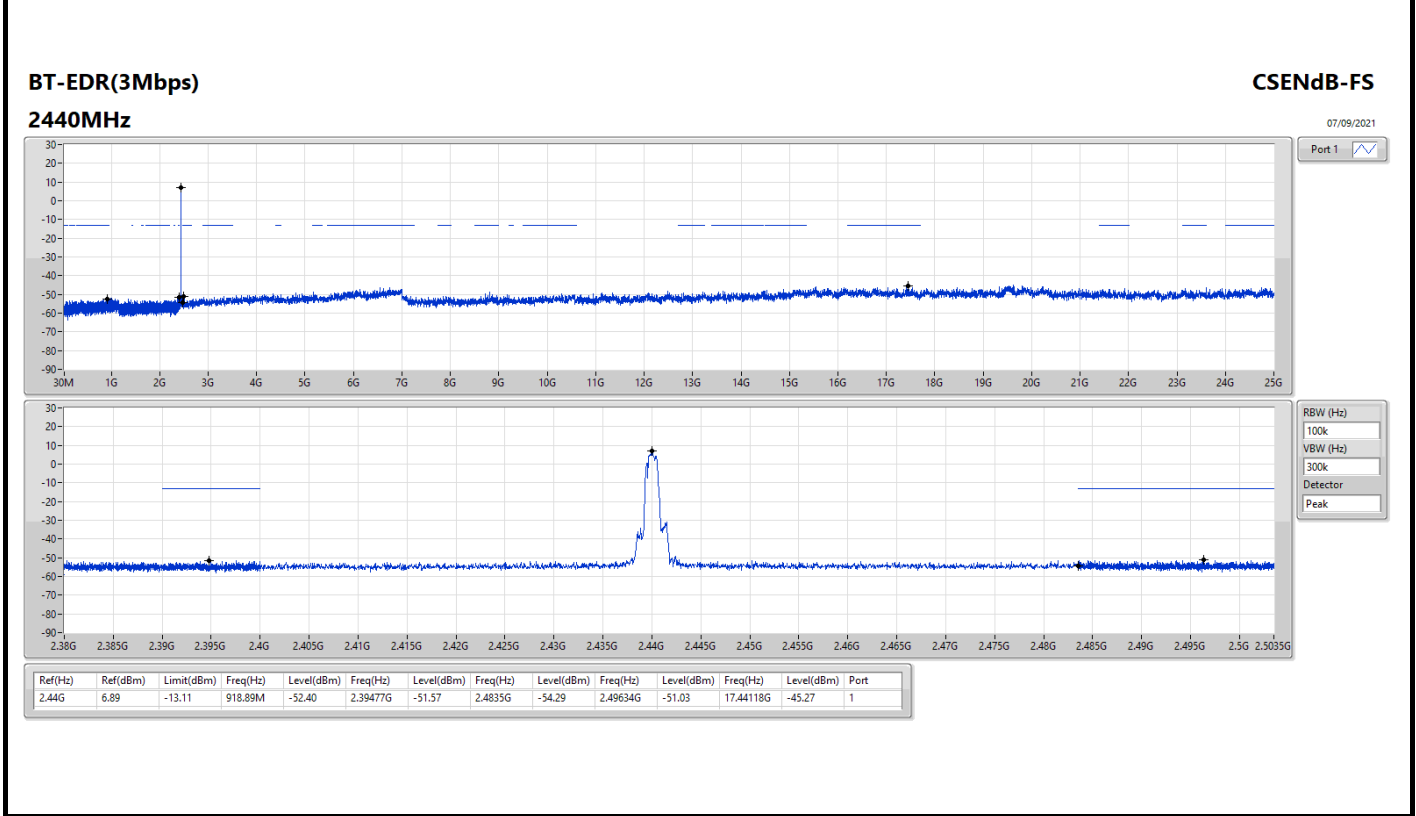
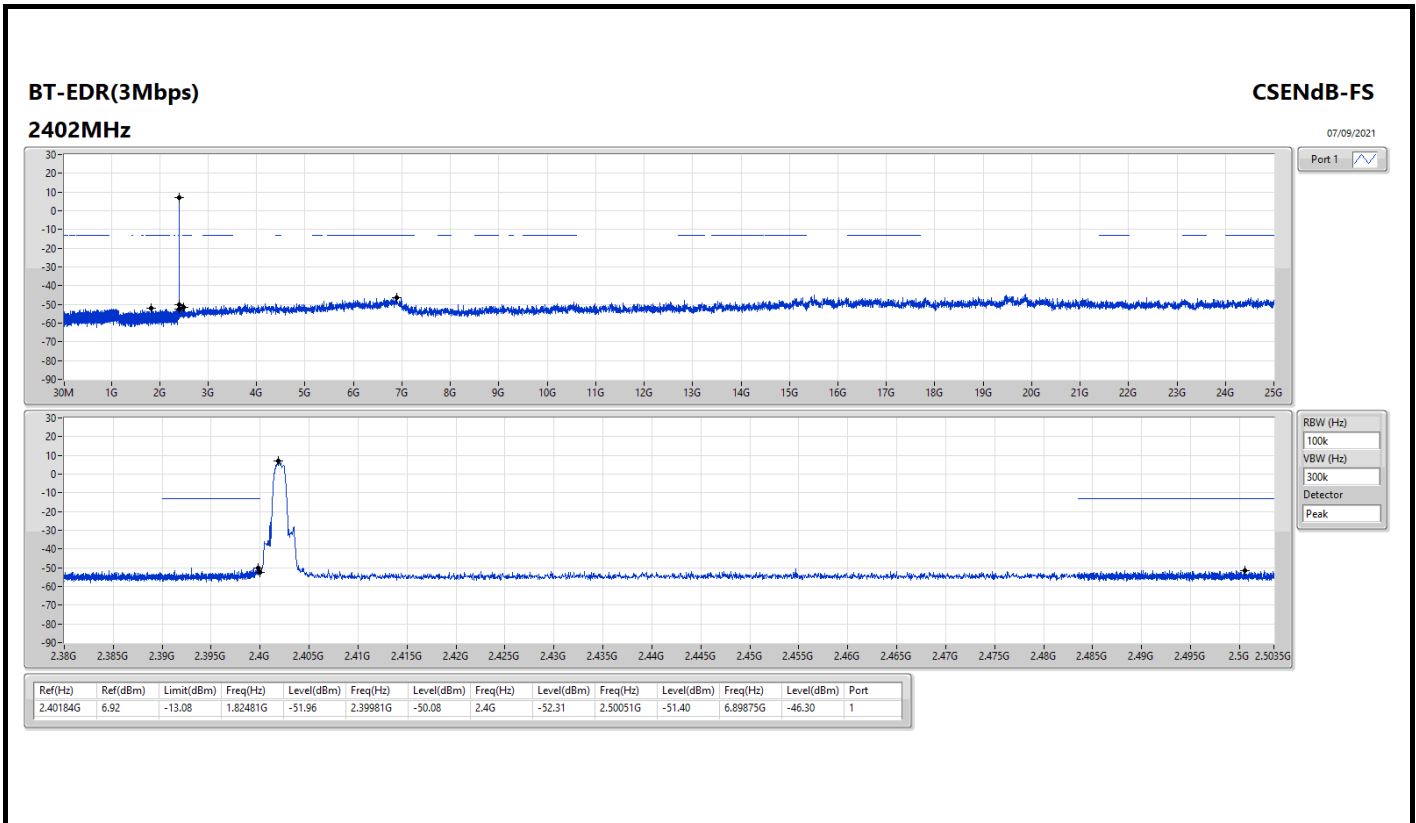

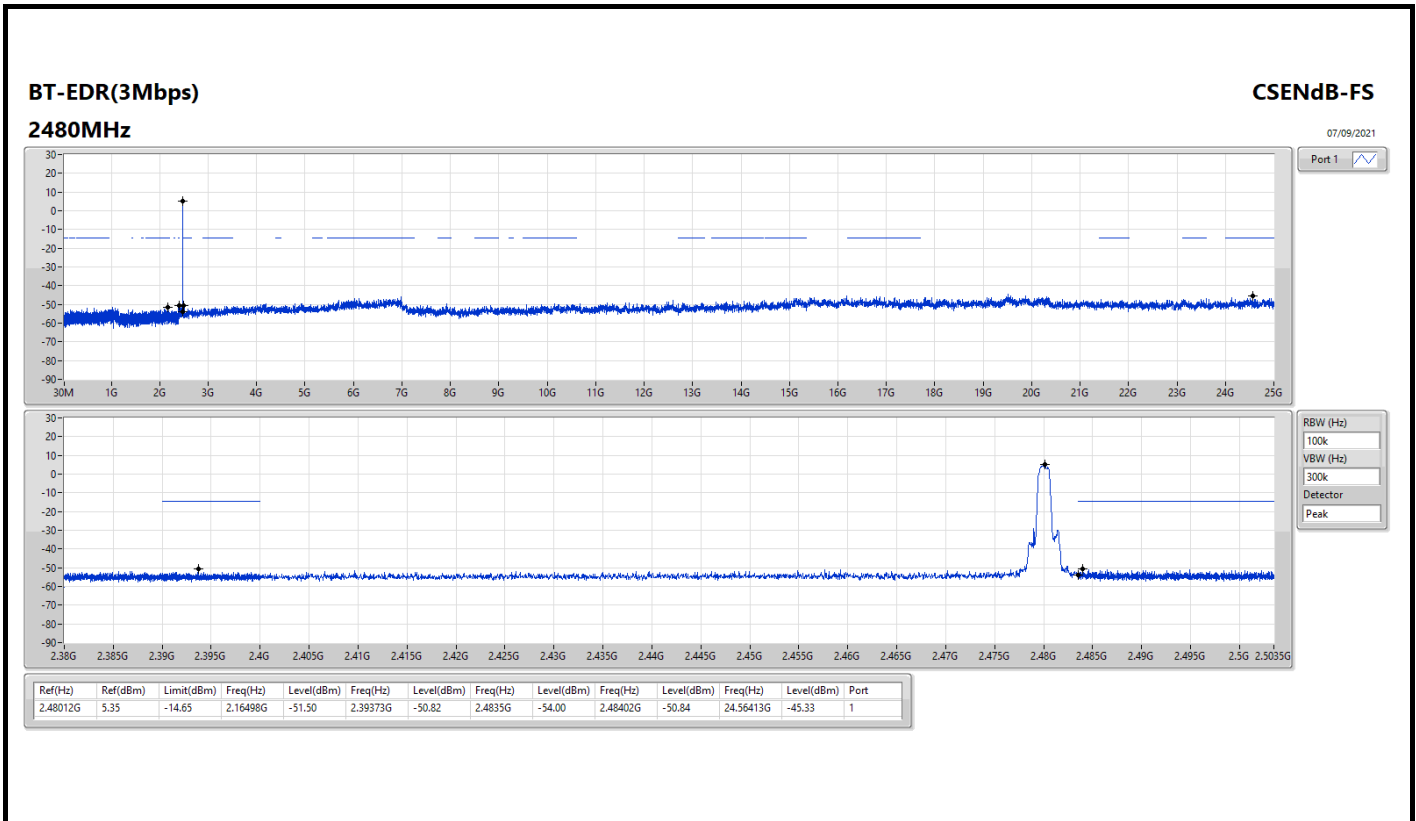



Summary

Mode	Result	Type	Freq (Hz)	Level (dBuV/m)	Limit (dBuV/m)	Margin (dB)	Condition
Mode 2	Pass	PK	730M	42.85	46.00	-3.15	Vertical

07/09/2021

Mode 2

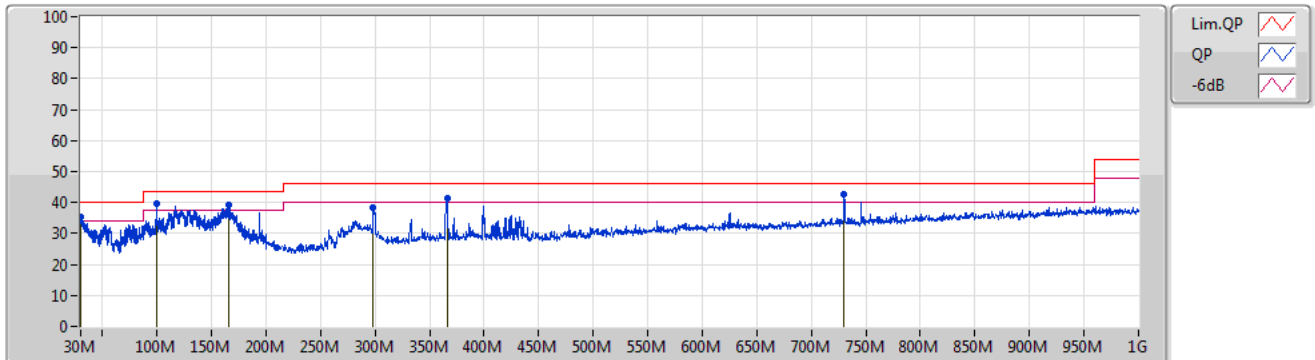

Type	Freq (Hz)	Level (dBuV/m)	Limit (dBuV/m)	Margin (dB)	Factor (dB)	Dist (m)	Condition	Azimuth (°)	Height (m)	Comment	Raw (dBuV)	AF (dB)	CL (dB)	PA (dB)
PK	30.51M	35.21	40.00	-4.79	-3.21	3	Vertical	318	2.00	-	38.42	23.65	1.02	27.88
PK	99.53M	39.77	43.50	-3.73	-8.53	3	Vertical	346	1.00	-	48.30	16.89	2.39	27.81
PK	166M	39.18	43.50	-4.32	-8.41	3	Vertical	178	1.00	-	47.59	15.78	3.29	27.48
PK	298.4M	38.56	46.00	-7.44	-9.38	3	Vertical	0	2.00	-	47.94	13.20	3.79	26.37
PK	366.4M	41.47	46.00	-4.53	-7.49	3	Vertical	337	3.00	-	48.96	15.38	4.17	27.04
PK	730M	42.85	46.00	-3.15	-1.00	3	Vertical	270	1.00	"Worst"	43.85	20.70	5.92	27.62

07/09/2021

Mode 2

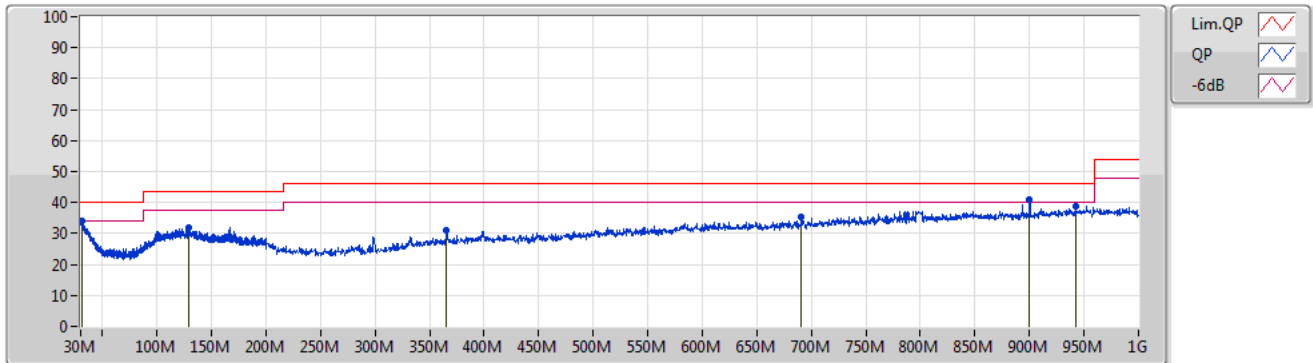

Type	Freq (Hz)	Level (dBuV/m)	Limit (dBuV/m)	Margin (dB)	Factor (dB)	Dist (m)	Condition	Azimuth (°)	Height (m)	Comment	Raw (dBuV)	AF (dB)	CL (dB)	PA (dB)
PK	31.02M	34.07	40.00	-5.93	-3.35	3	Horizontal	236	4.00	-	37.42	23.50	1.04	27.89
PK	129.45M	31.96	43.50	-11.54	-6.83	3	Horizontal	160	1.00	-	38.79	17.92	2.84	27.59
PK	365.2M	30.92	46.00	-15.08	-7.51	3	Horizontal	125	4.00	-	38.43	15.36	4.16	27.03
PK	690.8M	35.25	46.00	-10.75	-2.05	3	Horizontal	14	1.00	-	37.30	19.86	5.76	27.67
PK	900M	40.77	46.00	-5.23	1.60	3	Horizontal	241	1.00	"Worst"	39.17	21.64	6.60	26.64
PK	942.4M	38.80	46.00	-7.20	2.74	3	Horizontal	19	3.00	-	36.06	22.19	6.94	26.39



Summary

Mode	Result	Type	Freq (Hz)	Level (dBuV/m)	Limit (dBuV/m)	Margin (dB)	Dist (m)	Condition	Azimuth (°)	Height (m)	Comments
2.4-2.4835GHz	-	-	-	-	-	-	-	-	-	-	-
BT-BR(1Mbps)	Pass	AV	2.4835G	50.43	54.00	-3.57	3	Vertical	344.4	1.07	-

BT-BR(1Mbps)

2402MHz_TX

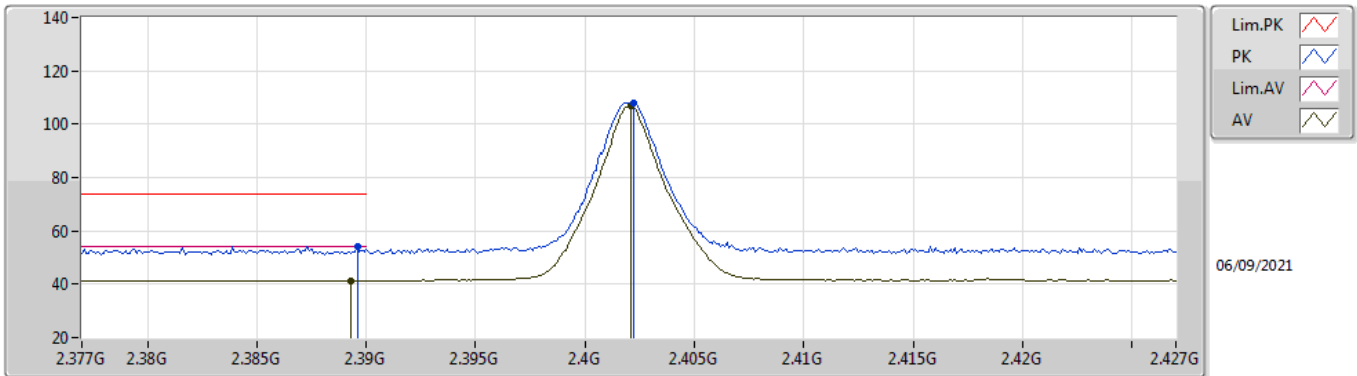

EUT Y_1TX
Setting Default
01-A-B-2

Type	Freq (Hz)	Level (dBuV/m)	Limit (dBuV/m)	Margin (dB)	Raw (dBuV)	Dist (m)	Condition	Azimuth (°)	Height (m)	Comment	AF (dB)	CL (dB)	PA (dB)
PK	2.3896G	54.07	74.00	-19.93	24.50	3	Vertical	343	1.14	-	27.38	2.19	-
AV	2.3893G	41.38	54.00	-12.62	11.81	3	Vertical	343	1.14	-	27.38	2.19	-
PK	2.4022G	107.84	Inf	-Inf	78.24	3	Vertical	343	1.14	-	27.40	2.20	-
AV	2.4021G	106.93	Inf	-Inf	77.33	3	Vertical	343	1.14	-	27.40	2.20	-

BT-BR(1Mbps)

2402MHz_TX

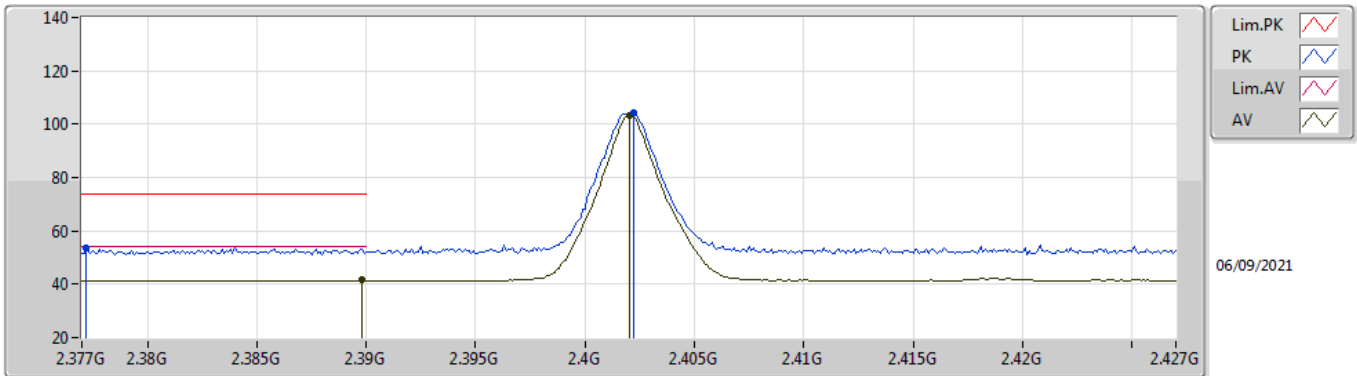

EUT Y_1TX
Setting Default
01-A-B-2

Type	Freq (Hz)	Level (dBuV/m)	Limit (dBuV/m)	Margin (dB)	Raw (dBuV)	Dist (m)	Condition	Azimuth (°)	Height (m)	Comment	AF (dB)	CL (dB)	PA (dB)
PK	2.3772G	53.86	74.00	-20.14	24.33	3	Horizontal	307	1.56	-	27.35	2.18	-
AV	2.3898G	41.49	54.00	-12.51	11.92	3	Horizontal	307	1.56	-	27.38	2.19	-
PK	2.4022G	104.06	Inf	-Inf	74.46	3	Horizontal	307	1.56	-	27.40	2.20	-
AV	2.402G	103.15	Inf	-Inf	73.55	3	Horizontal	307	1.56	-	27.40	2.20	-

BT-BR(1Mbps)

2402MHz_TX

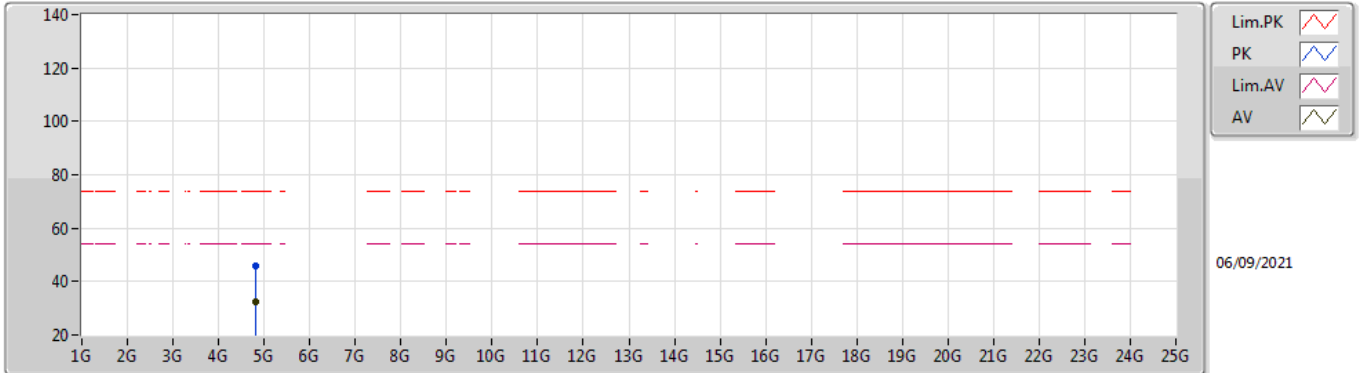

EUT Y_1TX
Setting Default
01-A-B-2

Type	Freq (Hz)	Level (dBuV/m)	Limit (dBuV/m)	Margin (dB)	Raw (dBuV)	Dist (m)	Condition	Azimuth (°)	Height (m)	Comment	AF (dB)	CL (dB)	PA (dB)
PK	4.80388G	45.70	74.00	-28.30	41.57	3	Vertical	354	1.27	-	32.12	5.00	32.99
AV	4.80096G	32.44	54.00	-21.56	28.32	3	Vertical	354	1.27	-	32.11	5.00	32.99

BT-BR(1Mbps)

2402MHz_TX

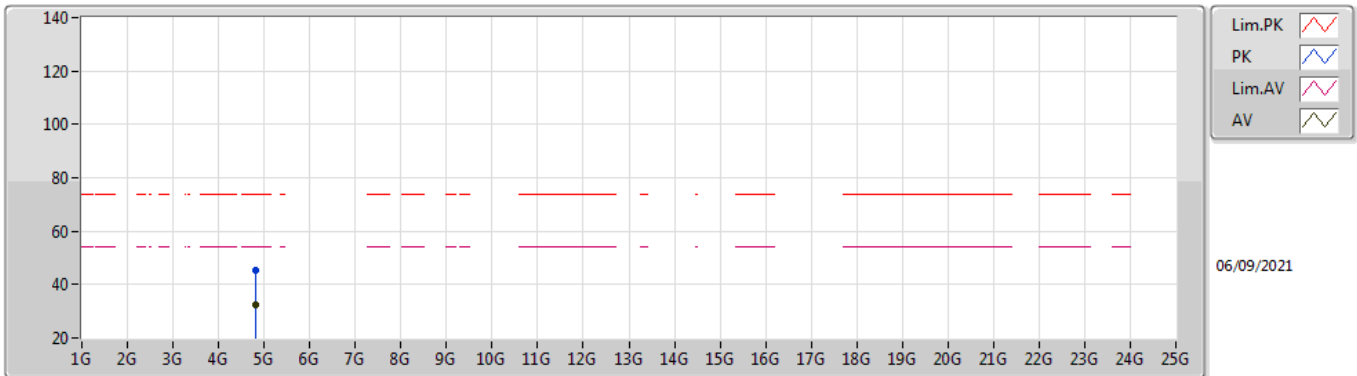

EUT Y_1TX
Setting Default
01-A-B-2

Type	Freq (Hz)	Level (dBuV/m)	Limit (dBuV/m)	Margin (dB)	Raw (dBuV)	Dist (m)	Condition	Azimuth (°)	Height (m)	Comment	AF (dB)	CL (dB)	PA (dB)
PK	4.80604G	45.47	74.00	-28.53	41.32	3	Horizontal	152	1.47	-	32.14	5.00	32.99
AV	4.79944G	32.48	54.00	-21.52	28.37	3	Horizontal	152	1.47	-	32.10	5.00	32.99

BT-BR(1Mbps)

2440MHz_TX

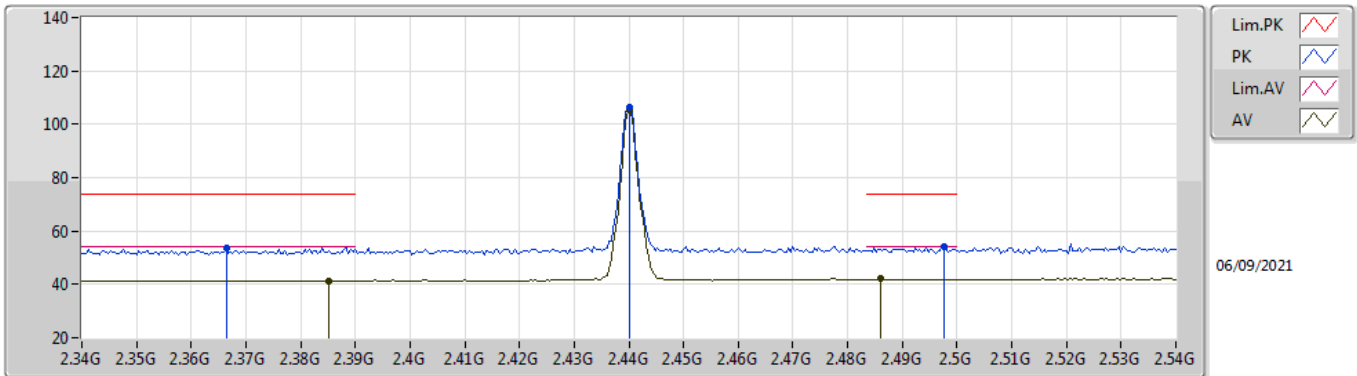

EUT_V_1TX
Setting Default
01-A-B-2

Type	Freq (Hz)	Level (dBuV/m)	Limit (dBuV/m)	Margin (dB)	Raw (dBuV)	Dist (m)	Condition	Azimuth (°)	Height (m)	Comment	AF (dB)	CL (dB)	PA (dB)
PK	2.3664G	53.77	74.00	-20.23	24.27	3	Vertical	349.8	1.14	-	27.33	2.17	-
AV	2.3852G	41.39	54.00	-12.61	11.83	3	Vertical	349.8	1.14	-	27.37	2.19	-
PK	2.44G	106.40	Inf	-Inf	76.68	3	Vertical	349.8	1.14	-	27.48	2.24	-
AV	2.44G	105.50	Inf	-Inf	75.78	3	Vertical	349.8	1.14	-	27.48	2.24	-
PK	2.4976G	54.33	74.00	-19.67	24.24	3	Vertical	349.8	1.14	-	27.79	2.30	-
AV	2.486G	42.05	54.00	-11.95	12.04	3	Vertical	349.8	1.14	-	27.72	2.29	-

BT-BR(1Mbps)

2440MHz_TX

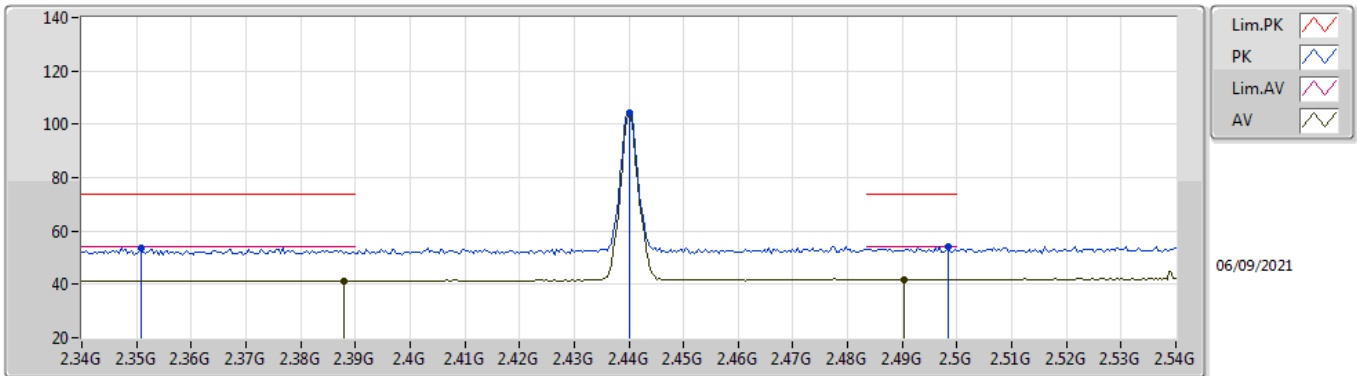

EUT_V_1TX
Setting Default
01-A-B-2

Type	Freq (Hz)	Level (dBuV/m)	Limit (dBuV/m)	Margin (dB)	Raw (dBuV)	Dist (m)	Condition	Azimuth (°)	Height (m)	Comment	AF (dB)	CL (dB)	PA (dB)
PK	2.3508G	53.57	74.00	-20.43	24.12	3	Horizontal	309.2	1.55	-	27.30	2.15	-
AV	2.388G	41.37	54.00	-12.63	11.80	3	Horizontal	309.2	1.55	-	27.38	2.19	-
PK	2.44G	104.46	Inf	-Inf	74.74	3	Horizontal	309.2	1.55	-	27.48	2.24	-
AV	2.44G	103.58	Inf	-Inf	73.86	3	Horizontal	309.2	1.55	-	27.48	2.24	-
PK	2.4984G	53.94	74.00	-20.06	23.85	3	Horizontal	309.2	1.55	-	27.79	2.30	-
AV	2.4904G	41.96	54.00	-12.04	11.93	3	Horizontal	309.2	1.55	-	27.74	2.29	-

BT-BR(1Mbps)

2440MHz_TX

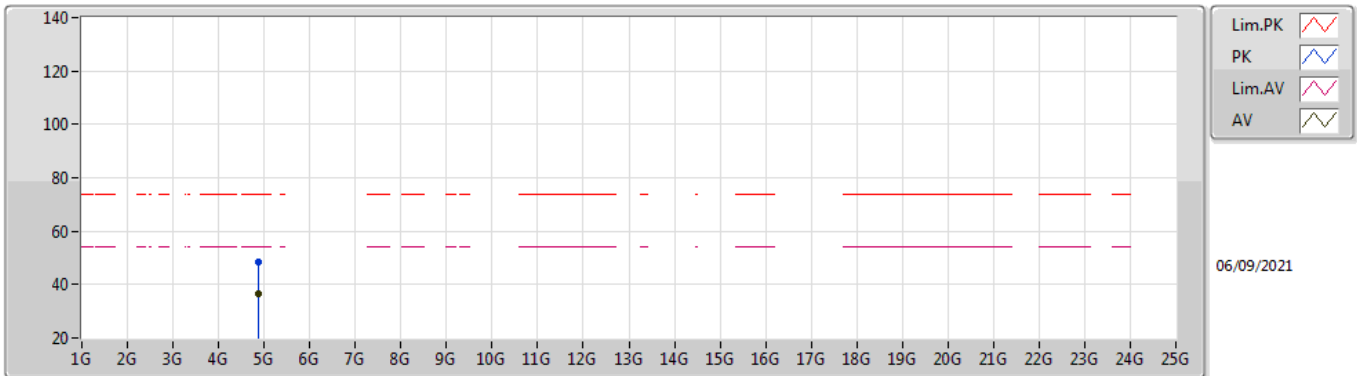

EUT Y_1TX
Setting Default
01-A-B-2

Type	Freq (Hz)	Level (dBuV/m)	Limit (dBuV/m)	Margin (dB)	Raw (dBuV)	Dist (m)	Condition	Azimuth (°)	Height (m)	Comment	AF (dB)	CL (dB)	PA (dB)
PK	4.87962G	48.20	74.00	-25.80	43.68	3	Vertical	21	1.15	-	32.46	5.04	32.98
AV	4.88012G	36.40	54.00	-17.60	31.88	3	Vertical	21	1.15	-	32.46	5.04	32.98

BT-BR(1Mbps)

2440MHz_TX

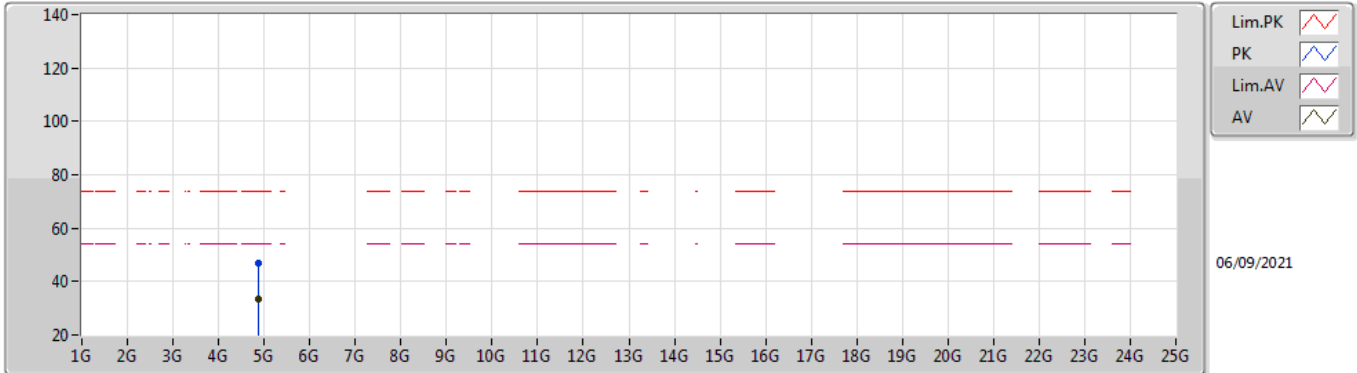

EUT Y_1TX
Setting Default
01-A-B-2

Type	Freq (Hz)	Level (dBuV/m)	Limit (dBuV/m)	Margin (dB)	Raw (dBuV)	Dist (m)	Condition	Azimuth (°)	Height (m)	Comment	AF (dB)	CL (dB)	PA (dB)
PK	4.87826G	46.65	74.00	-27.35	42.13	3	Horizontal	143	1.00	-	32.46	5.04	32.98
AV	4.8809G	33.27	54.00	-20.73	28.75	3	Horizontal	143	1.00	-	32.46	5.04	32.98

BT-BR(1Mbps)

2480MHz_TX

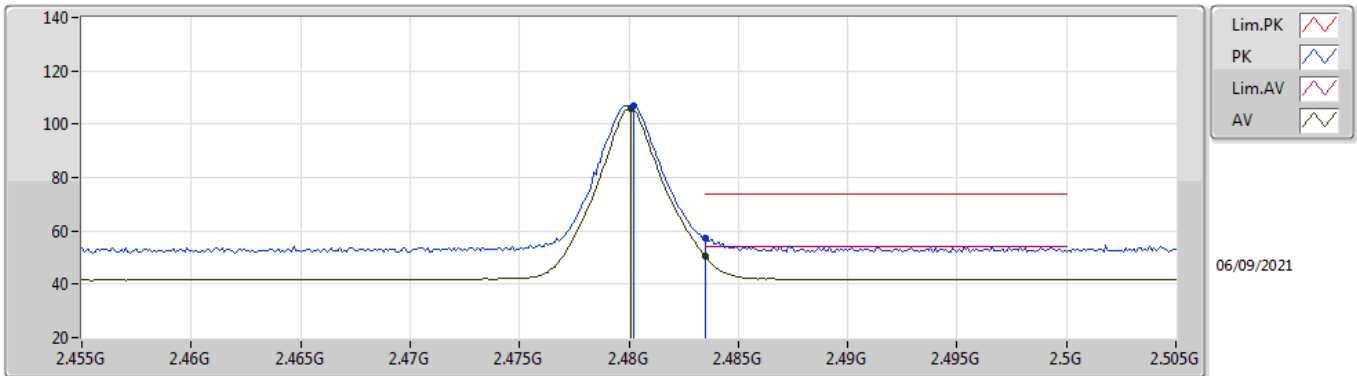

EUT Y_1TX
Setting Default
01-A-B-2

Type	Freq (Hz)	Level (dBuV/m)	Limit (dBuV/m)	Margin (dB)	Raw (dBuV)	Dist (m)	Condition	Azimuth (°)	Height (m)	Comment	AF (dB)	CL (dB)	PA (dB)
PK	2.4802G	106.80	Inf	-Inf	76.84	3	Vertical	344.4	1.07	-	27.68	2.28	-
AV	2.4801G	105.89	Inf	-Inf	75.93	3	Vertical	344.4	1.07	-	27.68	2.28	-
PK	2.4835G	57.05	74.00	-16.95	27.07	3	Vertical	344.4	1.07	-	27.70	2.28	-
AV	2.4835G	50.43	54.00	-3.57	20.45	3	Vertical	344.4	1.07	-	27.70	2.28	-

BT-BR(1Mbps)

2480MHz_TX

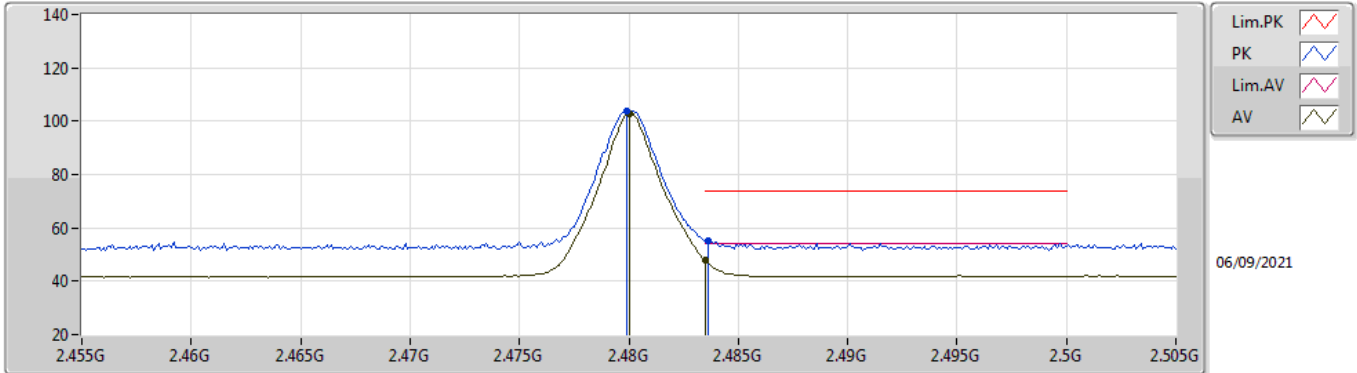

EUT Y_1TX
Setting Default
01-A-B-2

Type	Freq (Hz)	Level (dBuV/m)	Limit (dBuV/m)	Margin (dB)	Raw (dBuV)	Dist (m)	Condition	Azimuth (°)	Height (m)	Comment	AF (dB)	CL (dB)	PA (dB)
PK	2.4799G	103.80	Inf	-Inf	73.84	3	Horizontal	301.3	1.52	-	27.68	2.28	-
AV	2.48G	102.88	Inf	-Inf	72.92	3	Horizontal	301.3	1.52	-	27.68	2.28	-
PK	2.4836G	54.92	74.00	-19.08	24.94	3	Horizontal	301.3	1.52	-	27.70	2.28	-
AV	2.4835G	47.71	54.00	-6.29	17.73	3	Horizontal	301.3	1.52	-	27.70	2.28	-

BT-BR(1Mbps)

2480MHz_TX

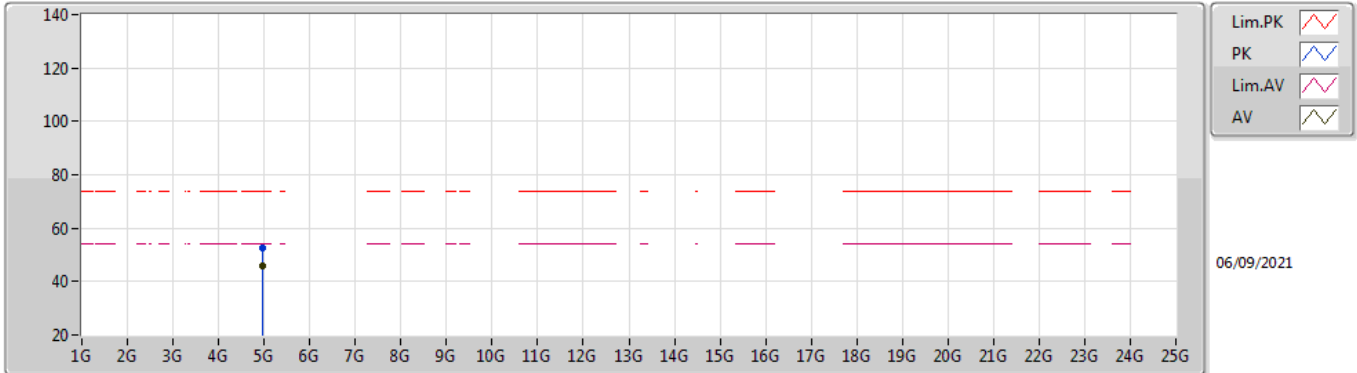

EUT Y_1TX
Setting Default
01-A-B-2

Type	Freq (Hz)	Level (dBuV/m)	Limit (dBuV/m)	Margin (dB)	Raw (dBuV)	Dist (m)	Condition	Azimuth (°)	Height (m)	Comment	AF (dB)	CL (dB)	PA (dB)
PK	4.95973G	52.37	74.00	-21.63	47.48	3	Vertical	20.8	1.13	-	32.78	5.08	32.97
AV	4.96003G	45.74	54.00	-8.26	40.85	3	Vertical	20.8	1.13	-	32.78	5.08	32.97

BT-BR(1Mbps)

2480MHz_TX

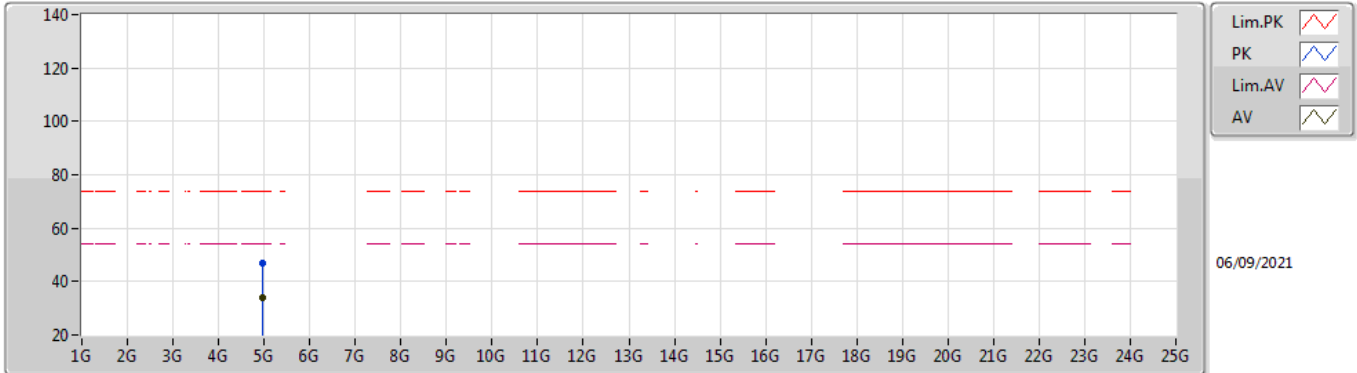

EUT Y_1TX
Setting Default
01-A-B-2

Type	Freq (Hz)	Level (dBuV/m)	Limit (dBuV/m)	Margin (dB)	Raw (dBuV)	Dist (m)	Condition	Azimuth (°)	Height (m)	Comment	AF (dB)	CL (dB)	PA (dB)
PK	4.9597G	46.67	74.00	-27.33	41.78	3	Horizontal	33	1.69	-	32.78	5.08	32.97
AV	4.96G	33.97	54.00	-20.03	29.08	3	Horizontal	33	1.69	-	32.78	5.08	32.97

BT-EDR(3Mbps)

2402MHz_TX

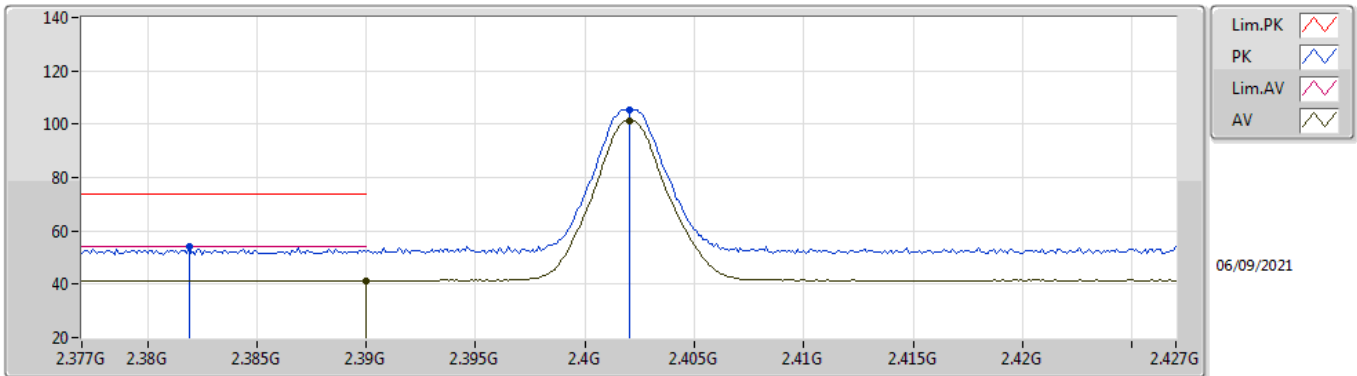

EUT Y_1TX
Setting Default
01-A-B-2

Type	Freq (Hz)	Level (dBuV/m)	Limit (dBuV/m)	Margin (dB)	Raw (dBuV)	Dist (m)	Condition	Azimuth (°)	Height (m)	Comment	AF (dB)	CL (dB)	PA (dB)
PK	2.3819G	53.90	74.00	-20.10	24.36	3	Vertical	344	1.14	-	27.36	2.18	-
AV	2.39G	41.39	54.00	-12.61	11.82	3	Vertical	344	1.14	-	27.38	2.19	-
PK	2.402G	105.56	Inf	-Inf	75.96	3	Vertical	344	1.14	-	27.40	2.20	-
AV	2.402G	101.44	Inf	-Inf	71.84	3	Vertical	344	1.14	-	27.40	2.20	-

BT-EDR(3Mbps)

2402MHz_TX

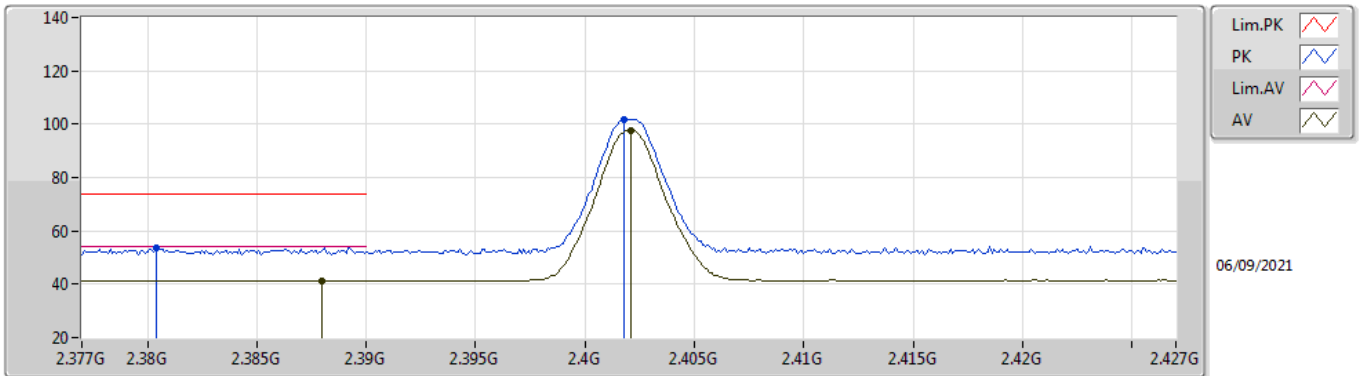

EUT_V_1TX
Setting Default
01-A-B-2

Type	Freq (Hz)	Level (dBuV/m)	Limit (dBuV/m)	Margin (dB)	Raw (dBuV)	Dist (m)	Condition	Azimuth (°)	Height (m)	Comment	AF (dB)	CL (dB)	PA (dB)
PK	2.3804G	53.58	74.00	-20.42	24.04	3	Horizontal	305	1.56	-	27.36	2.18	-
AV	2.388G	41.43	54.00	-12.57	11.86	3	Horizontal	305	1.56	-	27.38	2.19	-
PK	2.4018G	101.89	Inf	-Inf	72.29	3	Horizontal	305	1.56	-	27.40	2.20	-
AV	2.4021G	97.67	Inf	-Inf	68.07	3	Horizontal	305	1.56	-	27.40	2.20	-

BT-EDR(3Mbps)

2402MHz_TX

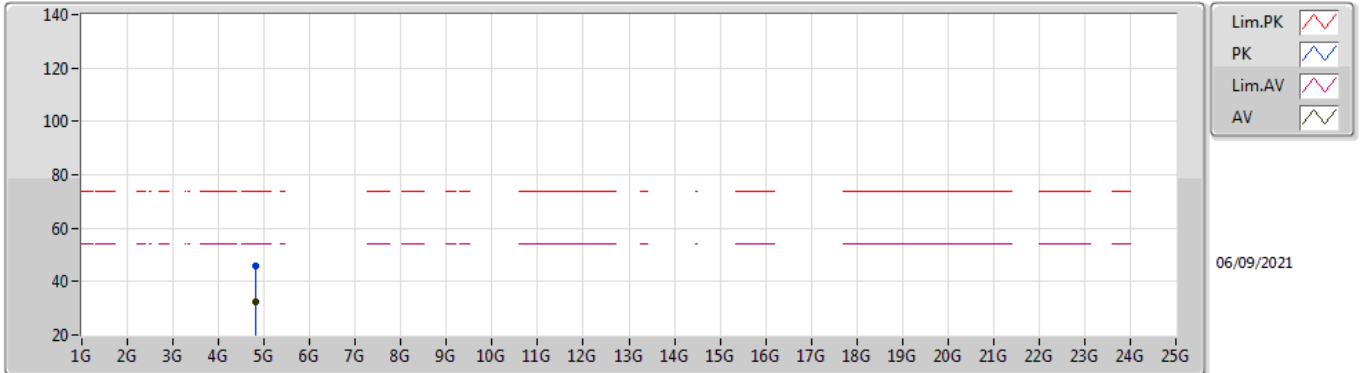

EUT Y_1TX
Setting Default
01-A-B-2

Type	Freq (Hz)	Level (dBuV/m)	Limit (dBuV/m)	Margin (dB)	Raw (dBuV)	Dist (m)	Condition	Azimuth (°)	Height (m)	Comment	AF (dB)	CL (dB)	PA (dB)
PK	4.80492G	45.92	74.00	-28.08	41.78	3	Vertical	116	1.31	-	32.13	5.00	32.99
AV	4.80806G	32.62	54.00	-21.38	28.46	3	Vertical	116	1.31	-	32.15	5.00	32.99

BT-EDR(3Mbps)

2402MHz_TX

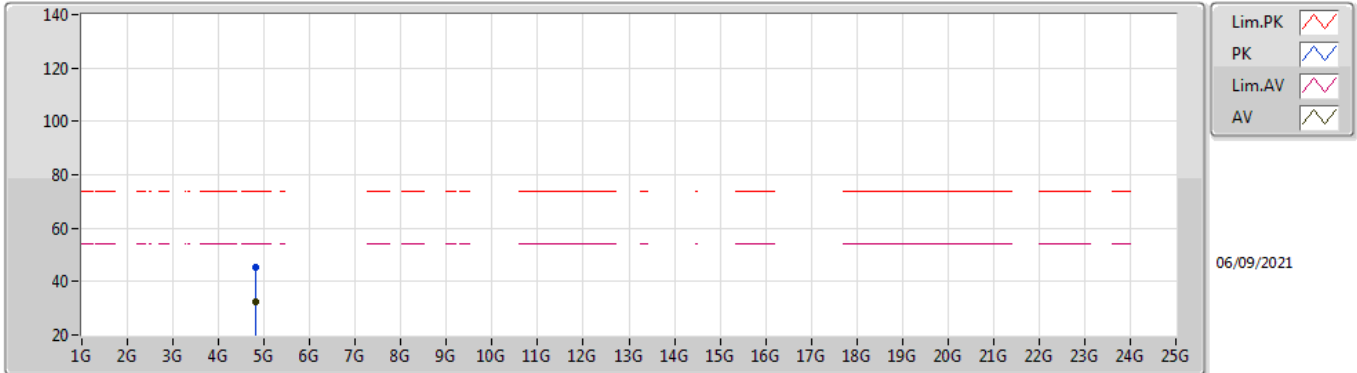

EUT Y_1TX
Setting Default
01-A-B-2

Type	Freq (Hz)	Level (dBuV/m)	Limit (dBuV/m)	Margin (dB)	Raw (dBuV)	Dist (m)	Condition	Azimuth (°)	Height (m)	Comment	AF (dB)	CL (dB)	PA (dB)
PK	4.80056G	45.53	74.00	-28.47	41.42	3	Horizontal	35	2.82	-	32.10	5.00	32.99
AV	4.8084G	32.46	54.00	-21.54	28.30	3	Horizontal	35	2.82	-	32.15	5.00	32.99

BT-EDR(3Mbps)

2440MHz_TX

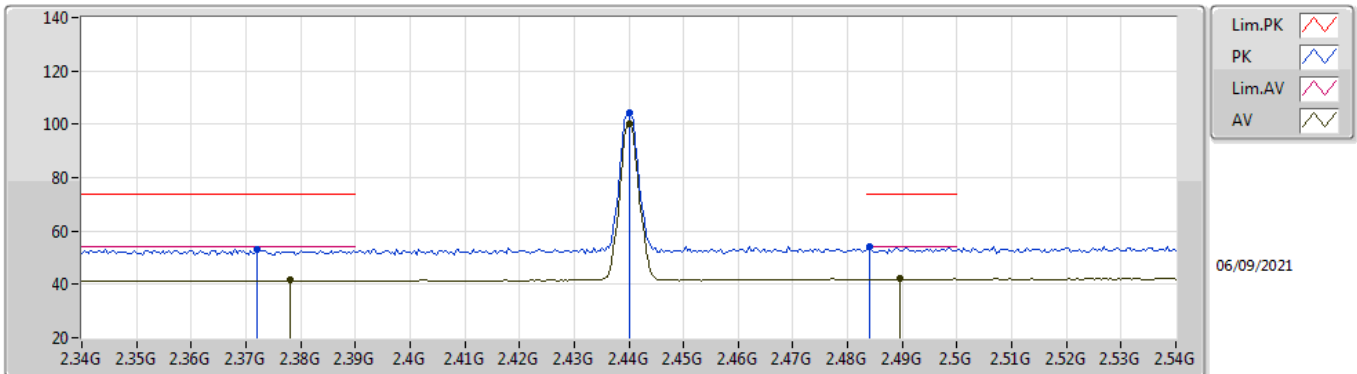

EUT_V_1TX
Setting Default
01-A-B-2

Type	Freq (Hz)	Level (dBuV/m)	Limit (dBuV/m)	Margin (dB)	Raw (dBuV)	Dist (m)	Condition	Azimuth (°)	Height (m)	Comment	AF (dB)	CL (dB)	PA (dB)
PK	2.372G	53.06	74.00	-20.94	23.55	3	Vertical	341.2	1.00	-	27.34	2.17	-
AV	2.378G	41.52	54.00	-12.48	11.98	3	Vertical	341.2	1.00	-	27.36	2.18	-
PK	2.44G	104.22	Inf	-Inf	74.50	3	Vertical	341.2	1.00	-	27.48	2.24	-
AV	2.44G	99.98	Inf	-Inf	70.26	3	Vertical	341.2	1.00	-	27.48	2.24	-
PK	2.484G	54.15	74.00	-19.85	24.17	3	Vertical	341.2	1.00	-	27.70	2.28	-
AV	2.4896G	42.00	54.00	-12.00	11.97	3	Vertical	341.2	1.00	-	27.74	2.29	-

BT-EDR(3Mbps)

2440MHz_TX

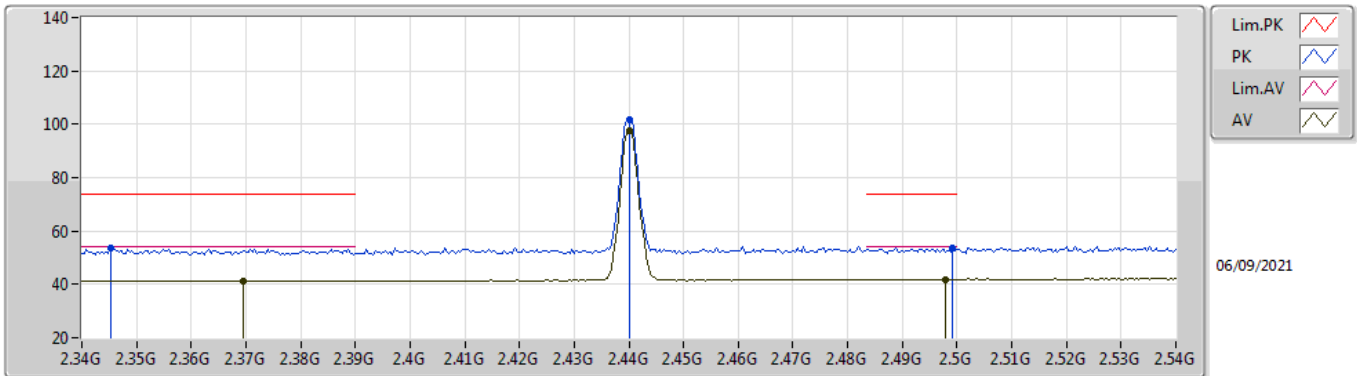

EUT_V_1TX
Setting Default
01-A-B-2

Type	Freq (Hz)	Level (dBuV/m)	Limit (dBuV/m)	Margin (dB)	Raw (dBuV)	Dist (m)	Condition	Azimuth (°)	Height (m)	Comment	AF (dB)	CL (dB)	PA (dB)
PK	2.3452G	53.39	74.00	-20.61	23.94	3	Horizontal	304	1.56	-	27.30	2.15	-
AV	2.3696G	41.37	54.00	-12.63	11.86	3	Horizontal	304	1.56	-	27.34	2.17	-
PK	2.44G	101.77	Inf	-Inf	72.05	3	Horizontal	304	1.56	-	27.48	2.24	-
AV	2.44G	97.64	Inf	-Inf	67.92	3	Horizontal	304	1.56	-	27.48	2.24	-
PK	2.4992G	53.50	74.00	-20.50	23.40	3	Horizontal	304	1.56	-	27.80	2.30	-
AV	2.498G	41.93	54.00	-12.07	11.84	3	Horizontal	304	1.56	-	27.79	2.30	-

BT-EDR(3Mbps)

2440MHz_TX

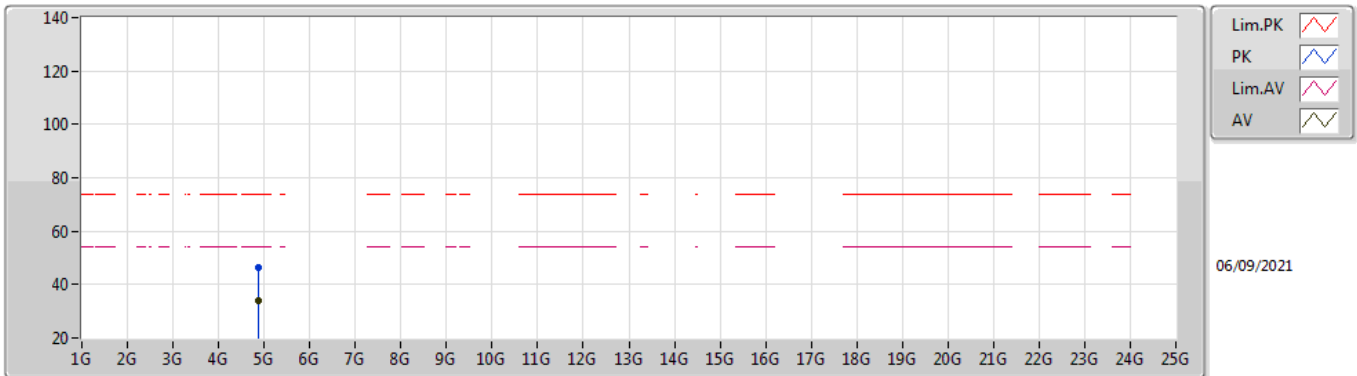

EUT Y_1TX
Setting Default
01-A-B-2

Type	Freq (Hz)	Level (dBuV/m)	Limit (dBuV/m)	Margin (dB)	Raw (dBuV)	Dist (m)	Condition	Azimuth (°)	Height (m)	Comment	AF (dB)	CL (dB)	PA (dB)
PK	4.87538G	46.35	74.00	-27.65	41.84	3	Vertical	55	2.50	-	32.45	5.04	32.98
AV	4.87978G	33.87	54.00	-20.13	29.35	3	Vertical	55	2.50	-	32.46	5.04	32.98

BT-EDR(3Mbps)

2440MHz_TX

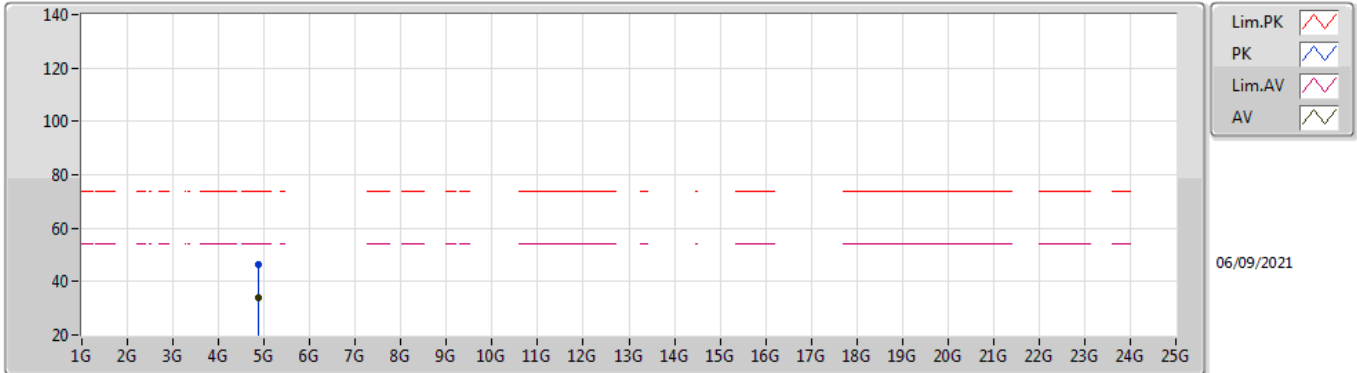

EUT Y_1TX
Setting Default
01-A-B-2

Type	Freq (Hz)	Level (dBuV/m)	Limit (dBuV/m)	Margin (dB)	Raw (dBuV)	Dist (m)	Condition	Azimuth (°)	Height (m)	Comment	AF (dB)	CL (dB)	PA (dB)
PK	4.88042G	46.37	74.00	-27.63	41.85	3	Horizontal	318	1.00	-	32.46	5.04	32.98
AV	4.88028G	33.97	54.00	-20.03	29.45	3	Horizontal	318	1.00	-	32.46	5.04	32.98

BT-EDR(3Mbps)

2480MHz_TX

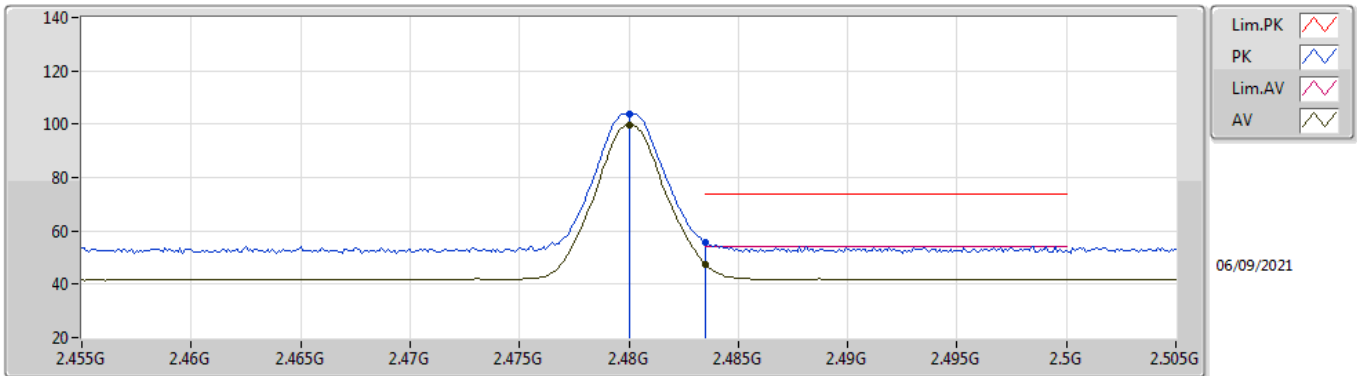

EUT_V_1TX
Setting Default
01-A-B-2

Type	Freq (Hz)	Level (dBuV/m)	Limit (dBuV/m)	Margin (dB)	Raw (dBuV)	Dist (m)	Condition	Azimuth (°)	Height (m)	Comment	AF (dB)	CL (dB)	PA (dB)
PK	2.48G	103.82	Inf	-Inf	73.86	3	Vertical	346.5	1.06	-	27.68	2.28	-
AV	2.48G	99.65	Inf	-Inf	69.69	3	Vertical	346.5	1.06	-	27.68	2.28	-
PK	2.4835G	55.77	74.00	-18.23	25.79	3	Vertical	346.5	1.06	-	27.70	2.28	-
AV	2.4835G	47.55	54.00	-6.45	17.57	3	Vertical	346.5	1.06	-	27.70	2.28	-

BT-EDR(3Mbps)

2480MHz_TX

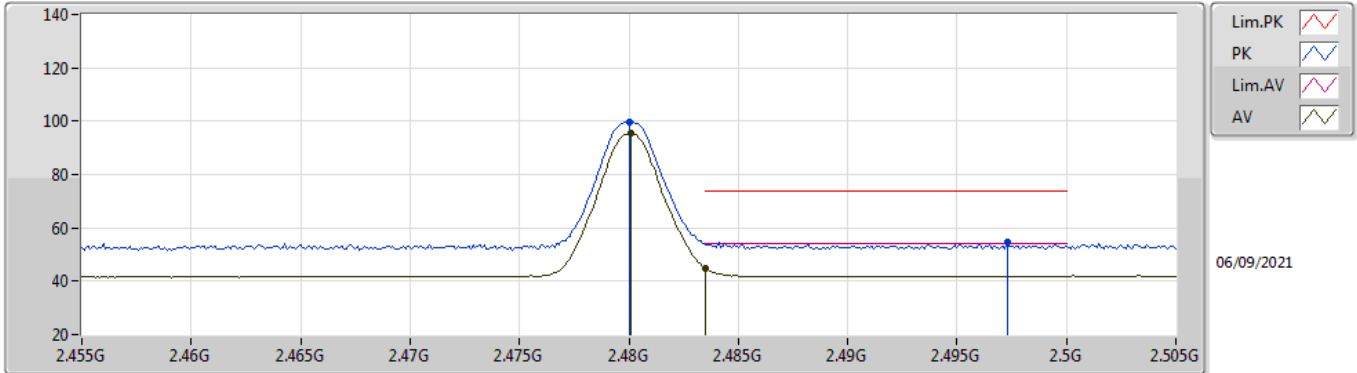

EUT V_1TX
Setting Default
01-A-B-2

Type	Freq (Hz)	Level (dBuV/m)	Limit (dBuV/m)	Margin (dB)	Raw (dBuV)	Dist (m)	Condition	Azimuth (°)	Height (m)	Comment	AF (dB)	CL (dB)	PA (dB)
PK	2.48G	99.60	Inf	-Inf	69.64	3	Horizontal	306	1.59	-	27.68	2.28	-
AV	2.4801G	95.42	Inf	-Inf	65.46	3	Horizontal	306	1.59	-	27.68	2.28	-
PK	2.4973G	54.72	74.00	-19.28	24.64	3	Horizontal	306	1.59	-	27.78	2.30	-
AV	2.4835G	44.68	54.00	-9.32	14.70	3	Horizontal	306	1.59	-	27.70	2.28	-

BT-EDR(3Mbps)

2480MHz_TX

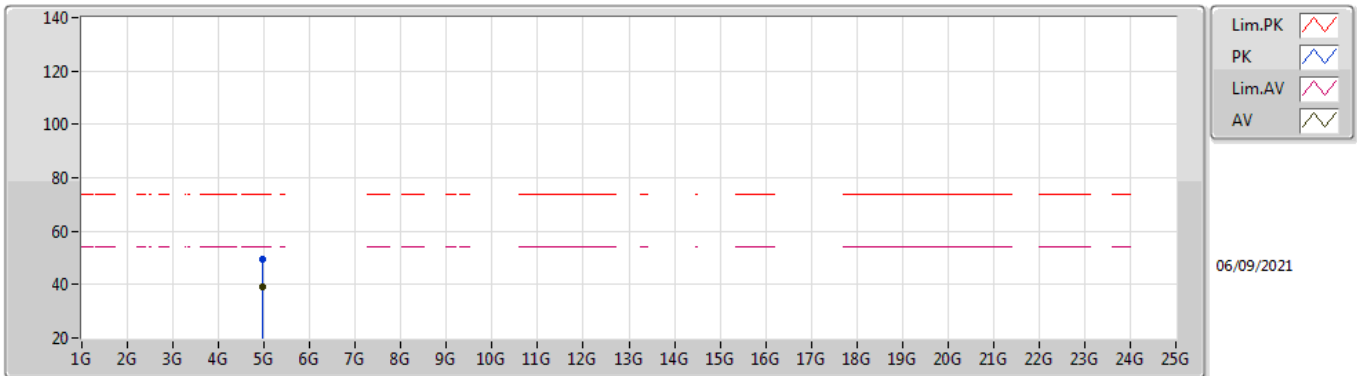

EUT Y_1TX
Setting Default
01-A-B-2

Type	Freq (Hz)	Level (dBuV/m)	Limit (dBuV/m)	Margin (dB)	Raw (dBuV)	Dist (m)	Condition	Azimuth (°)	Height (m)	Comment	AF (dB)	CL (dB)	PA (dB)
PK	4.9599G	49.54	74.00	-24.46	44.65	3	Vertical	24	1.14	-	32.78	5.08	32.97
AV	4.96008G	39.00	54.00	-15.00	34.11	3	Vertical	24	1.14	-	32.78	5.08	32.97

BT-EDR(3Mbps)

2480MHz_TX

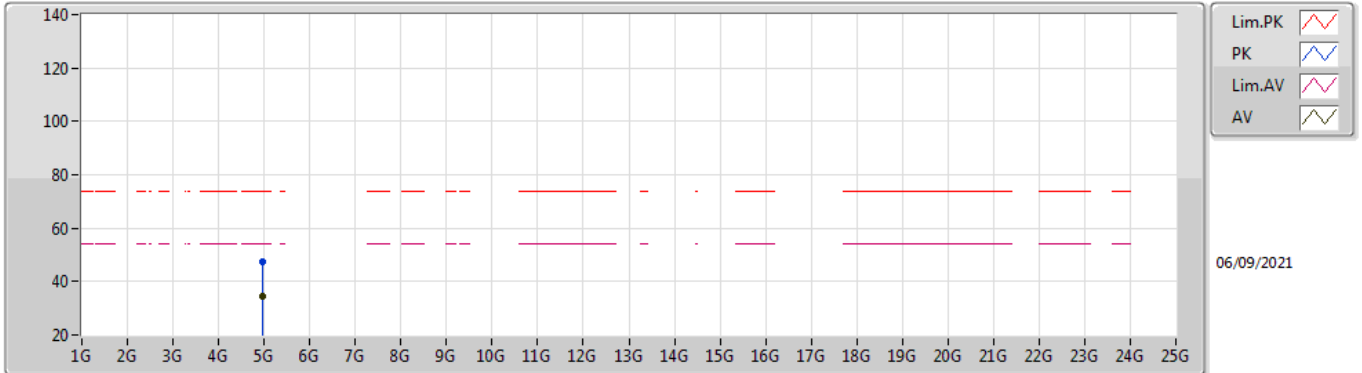

EUT Y_1TX
Setting Default
01-A-B-2

Type	Freq (Hz)	Level (dBuV/m)	Limit (dBuV/m)	Margin (dB)	Raw (dBuV)	Dist (m)	Condition	Azimuth (°)	Height (m)	Comment	AF (dB)	CL (dB)	PA (dB)
PK	4.95982G	47.30	74.00	-26.70	42.41	3	Horizontal	336	3.00	-	32.78	5.08	32.97
AV	4.9602G	34.29	54.00	-19.71	29.40	3	Horizontal	336	3.00	-	32.78	5.08	32.97



Summary

Mode	Result	Type	Freq (Hz)	Level (dBuV/m)	Limit (dBuV/m)	Margin (dB)	Condition
Mode 1	Pass	AV	1.31242G	41.88	54.00	-12.12	Horizontal

Mode 1

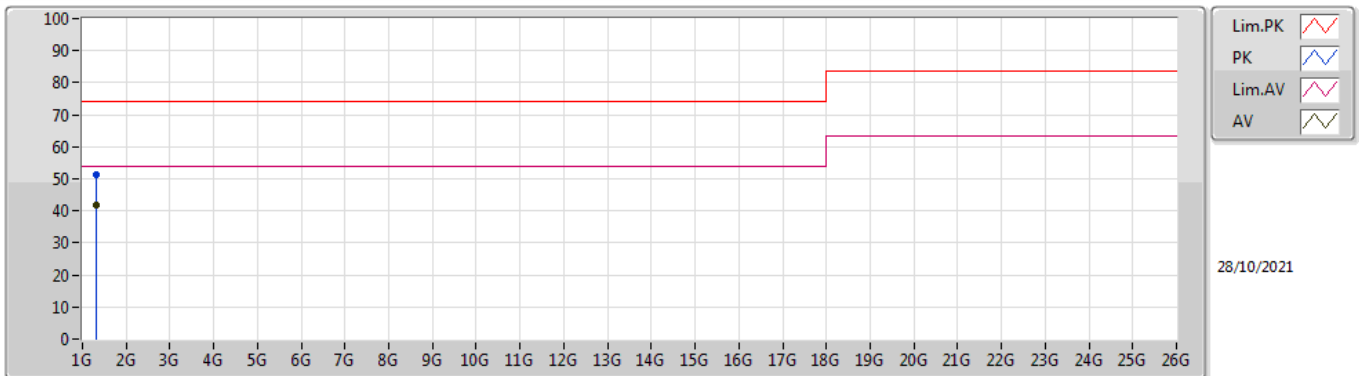

Type	Freq (Hz)	Level (dBuV/m)	Limit (dBuV/m)	Margin (dB)	Factor (dB/m)	Dist (m)	Condition	Azimuth (°)	Height (m)	Comment	Raw (dBuV/m)	AF (dB/m)	CL (dB)	PA (dB)
PK	1.30518G	51.45	74.00	-22.55	-7.68	3	Vertical	136	1.08	-	59.13	25.95	2.51	36.14
AV	1.30977G	41.69	54.00	-12.31	-7.61	3	Vertical	136	1.08	"Worst"	49.30	26.00	2.51	36.12

Mode 1

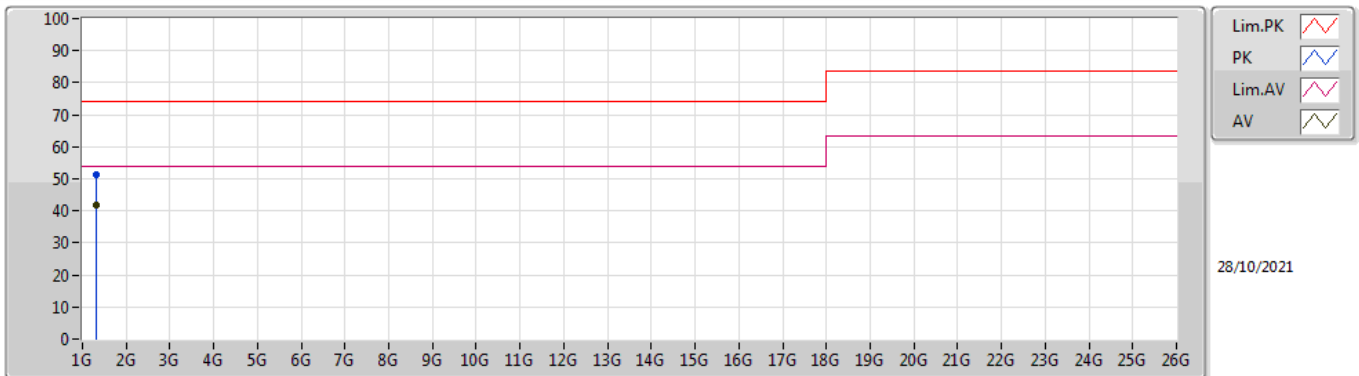

Type	Freq (Hz)	Level (dBuV/m)	Limit (dBuV/m)	Margin (dB)	Factor (dB/m)	Dist (m)	Condition	Azimuth (°)	Height (m)	Comment	Raw (dBuV/m)	AF (dB/m)	CL (dB)	PA (dB)
PK	1.31581G	51.30	74.00	-22.70	-7.51	3	Horizontal	208	1.22	-	58.81	26.06	2.52	36.09
AV	1.31242G	41.88	54.00	-12.12	-7.58	3	Horizontal	208	1.22	"Worst"	49.46	26.02	2.51	36.11