



# FCC TEST REPORT

**REPORT NO.:** RF970417L07  
**MODEL NO.:** AW-BT252  
**RECEIVED:** Mar. 21, 2008  
**TESTED:** Mar. 22 ~ May 08, 2008  
**ISSUED:** May 28, 2008

**APPLICANT:** AzureWave Technologies, Inc.

**ADDRESS:** 8F, No.94, Baozhong Rd., Xindian, Taipei ,  
Taiwan 231.

**ISSUED BY:** Advance Data Technology Corporation

**LAB ADDRESS:** No. 47, 14<sup>th</sup> Ling, Chia Pau Tsuen, Lin Kou  
Hsiang 244, Taipei Hsien, Taiwan, R.O.C.

**TEST LOCATION:** No. 19, Hwa Ya 2<sup>nd</sup> Rd., Wen Hwa Tsuen, Kwei  
Shan Hsiang, Taoyuan Hsien 333, Taiwan,  
R.O.C.

This test report consists of 85 pages in total. It may be duplicated completely for legal use with the approval of the applicant. It should not be reproduced except in full, without the written approval of our laboratory. The client should not use it to claim product endorsement by TAF, A2LA or any government agencies. The test results in the report only apply to the tested sample.



## Table of Contents

1.	CERTIFICATION.....	4
2.	SUMMARY OF TEST RESULTS .....	5
2.1	MEASUREMENT UNCERTAINTY.....	5
3.	GENERAL INFORMATION.....	6
3.1	GENERAL DESCRIPTION OF EUT .....	6
3.2	DESCRIPTION OF TEST MODES .....	7
3.2.1	CONFIGURATION OF SYSTEM UNDER TEST .....	7
3.2.2	TEST MODE APPLICABILITY AND TESTED CHANNEL DETAIL .....	8
3.3	GENERAL DESCRIPTION OF APPLIED STANDARDS .....	10
3.4	DESCRIPTION OF SUPPORT UNITS .....	10
4.	TEST TYPES AND RESULTS .....	11
4.1	RADIATED EMISSION MEASUREMENT .....	11
4.1.1	LIMITS OF RADIATED EMISSION MEASUREMENT.....	11
4.1.2	TEST INSTRUMENTS.....	12
4.1.3	TEST PROCEDURES .....	13
4.1.4	DEVIATION FROM TEST STANDARD.....	13
4.1.5	TEST SETUP.....	14
4.1.6	EUT OPERATING CONDITIONS .....	14
4.1.7	TEST RESULTS .....	15
4.2	CONDUCTED EMISSION MEASUREMENT .....	36
4.2.1	LIMITS OF CONDUCTED EMISSION MEASUREMENT .....	36
4.2.2	TEST INSTRUMENTS.....	36
4.2.3	TEST PROCEDURES .....	37
4.2.4	DEVIATION FROM TEST STANDARD.....	37
4.2.5	TEST SETUP.....	38
4.2.6	EUT OPERATING CONDITIONS .....	38
4.2.7	TEST RESULTS .....	39
4.3	NUMBER OF HOPPING FREQUENCY USED .....	41
4.3.1	LIMIT OF HOPPING FREQUENCY USED.....	41
4.3.2	TEST INSTRUMENTS.....	41
4.3.3	TEST PROCEDURES .....	41
4.3.4	DEVIATION FROM TEST STANDARD.....	42
4.3.5	TEST SETUP.....	42
4.3.6	TEST RESULTS .....	42
4.4	DWELL TIME ON EACH CHANNEL .....	45
4.4.1	LIMIT OF DWELL TIME USED.....	45
4.4.2	TEST INSTRUMENTS.....	45
4.4.3	TEST PROCEDURES .....	45



4.4.4	DEVIATION FROM TEST STANDARD.....	45
4.4.5	TEST SETUP .....	46
4.4.6	TEST RESULTS .....	46
4.5	CHANNEL BANDWIDTH .....	54
4.5.1	LIMITS OF CHANNEL BANDWIDTH .....	54
4.5.2	TEST INSTRUMENTS.....	54
4.5.3	TEST PROCEDURE.....	54
4.5.4	DEVIATION FROM TEST STANDARD.....	54
4.5.5	TEST SETUP .....	55
4.5.6	EUT OPERATING CONDITION.....	55
4.5.7	TEST RESULTS .....	55
4.6	HOPPING CHANNEL SEPARATION.....	60
4.6.1	LIMIT OF HOPPING CHANNEL SEPARATION .....	60
4.6.2	TEST INSTRUMENTS.....	60
4.6.3	TEST PROCEDURES .....	60
4.6.4	DEVIATION FROM TEST STANDARD.....	60
4.6.5	TEST SETUP .....	60
4.6.6	TEST RESULTS .....	61
4.7	MAXIMUM PEAK OUTPUT POWER.....	65
4.7.1	LIMITS OF MAXIMUM PEAK OUTPUT POWER MEASUREMENT .....	65
4.7.2	TEST INSTRUMENTS.....	65
4.7.3	TEST PROCEDURES .....	65
4.7.4	DEVIATION FROM TEST STANDARD.....	65
4.7.5	TEST SETUP .....	66
4.7.6	EUT OPERATING CONDITION.....	66
4.7.7	TEST RESULTS .....	66
4.8	BAND EDGES MEASUREMENT .....	71
4.8.1	LIMITS OF BAND EDGES MEASUREMENT .....	71
4.8.2	TEST INSTRUMENTS.....	71
4.8.3	TEST PROCEDURE.....	71
4.8.4	DEVIATION FROM TEST STANDARD.....	71
4.8.5	EUT OPERATING CONDITION.....	71
4.8.6	TEST RESULTS .....	72
4.9	ANTENNA REQUIREMENT .....	82
4.9.1	STANDARD APPLICABLE .....	82
4.9.2	ANTENNA CONNECTED CONSTRUCTION .....	82
5.	PHOTOGRAPHS OF THE TEST CONFIGURATION.....	83
6.	INFORMATION ON THE TESTING LABORATORIES .....	84
7.	APPENDIX A - MODIFICATIONS RECORDERS FOR ENGINEERING CHANGES TO THE EUT BY THE LAB .....	85



# 1. CERTIFICATION

**PRODUCT:** Bluetooth Module

**MODEL:** AW-BT252

**BRAND:** Azurewave

**APPLICANT:** AzureWave Technologies, Inc.

**TESTED:** Mar. 22 ~ May 08, 2008

**TEST SAMPLE:** ENGINEERING SAMPLE

**STANDARDS:** **FCC Part 15, Subpart C (Section 15.247),**  
ANSI C63.4-2003

The above equipment (Model: AW-BT252) has been tested by **Advance Data Technology Corporation**, and found compliance with the requirement of the above standards. The test record, data evaluation & Equipment Under Test (EUT) configurations represented herein are true and accurate accounts of the measurements of the sample's EMC characteristics under the conditions specified in this report.

**PREPARED BY** : Ivy Lin , **DATE:** May 28, 2008  
Ivy Lin / Specialist

**TECHNICAL ACCEPTANCE** : Long Chen , **DATE:** May 28, 2008  
Responsible for RF Long Chen / Senior Engineer

**APPROVED BY** : Gary Chang , **DATE:** May 28, 2008  
Gary Chang / Assistant Manager

## 2. SUMMARY OF TEST RESULTS

The EUT has been tested according to the following specifications:

APPLIED STANDARD: FCC Part 15, Subpart C			
STANDARD SECTION	TEST TYPE AND LIMIT	RESULT	REMARK
15.207	AC Power Conducted Emission	PASS	Meet the requirement of limit. Minimum passing margin is -17.54dB at 0.177MHz
15.247(a)(1)(iii)	Number of Hopping Frequency Used Spec.: At least 15 channels	PASS	Meet the requirement of limit.
15.247(a)(1)(iii)	Dwell Time on Each Channel Spec.: Max. 0.4 second within 31.6 second	PASS	Meet the requirement of limit.
15.247(a)(1)	1. Hopping Channel Separation Spec.: Min. 25 kHz or 20 dB bandwidth, whichever is greater 2. Spectrum Bandwidth of a Frequency Hopping Sequence Spread Spectrum System	PASS	Meet the requirement of limit.
15.247(b)	Maximum Peak Output Power Spec.: max. 21dBm	PASS	Meet the requirement of limit.
15.247(d)	Transmitter Radiated Emissions Spec.: Table 15.209	PASS	Meet the requirement of limit. Minimum passing margin is -1.11dB at 131.98MHz
15.247(d)	Band Edge Measurement	PASS	Meet the requirement of limit.

**NOTE:** If The Frequency Hopping System operating in 2400-2483.5MHz band and the output power less than 125mW. The hopping channel carrier frequencies separated by a minimum of 25kHz or two-thirds of the 20dB bandwidth of hopping channel whichever is greater.

### 2.1 MEASUREMENT UNCERTAINTY

Where relevant, the following measurement uncertainty levels have been estimated for tests performed on the EUT as specified in CISPR 16-4-2:

MEASUREMENT	FREQUENCY	UNCERTAINTY
Conducted emissions	9kHz~30MHz	2.44 dB
Radiated emissions	30MHz ~ 200MHz	2.93 dB
	200MHz ~1000MHz	2.95 dB
	1GHz ~ 18GHz	2.26 dB
	18GHz ~ 40GHz	1.94 dB

This uncertainty represents an expanded uncertainty expressed at approximately the 95% confidence level using a coverage factor of k=2.

### 3. GENERAL INFORMATION

#### 3.1 GENERAL DESCRIPTION OF EUT

<b>EUT</b>	Bluetooth Module
<b>MODEL NO.</b>	AW-BT252
<b>FCC ID</b>	TLZ-BT252
<b>POWER SUPPLY</b>	5.0Vdc from host equipment
<b>MODULATION TYPE</b>	GFSK, $\pi/4$ -DQPSK, 8DPSK
<b>MODULATION TECHNOLOGY</b>	FHSS
<b>TRANSFER RATE</b>	1/2/3Mbps
<b>FREQUENCY RANGE</b>	2400 ~ 2483.5MHz
<b>NUMBER OF CHANNEL</b>	79
<b>CHANNEL SPACING</b>	1MHz
<b>OUTPUT POWER</b>	1.845mW
<b>ANTENNA TYPE</b>	Refer to note 1 as below
<b>DATA CABLE</b>	NA
<b>I/O PORTS</b>	USB
<b>ACCESSORY DEVICES</b>	NA

**NOTE:**

1. The following antennas were provided to this EUT.

NO.	BRAND	MODEL	ANTENNA TYPE	ANTENNA CONNECTOR	ANTENNA GAIN (dBi)
1	MAG.LAYERS	LTA-5320-2G4S3-A1	Chip Ant.	NA	-2.13
2	WNC	81.EEU15.001	PIFA Ant.	U.FL	-3.03
3	INC	21-92607-01	Printed Ant.	U.FL	1.89

2. Bluetooth technology is used in this EUT.
3. The above EUT information was declared by the manufacturer and for more detailed features description, please refer to the manufacturer's specifications or User's Manual.

### 3.2 DESCRIPTION OF TEST MODES

79 channels are provided to this EUT:

CHANNEL	FREQ. (MHz)	CHANNEL	FREQ. (MHz)	CHANNEL	FREQ. (MHz)	CHANNEL	FREQ. (MHz)
0	2402	20	2422	40	2442	60	2462
1	2403	21	2423	41	2443	61	2463
2	2404	22	2424	42	2444	62	2464
3	2405	23	2425	43	2445	63	2465
4	2406	24	2426	44	2446	64	2466
5	2407	25	2427	45	2447	65	2467
6	2408	26	2428	46	2448	66	2468
7	2409	27	2429	47	2449	67	2469
8	2410	28	2430	48	2450	68	2470
9	2411	29	2431	49	2451	69	2471
10	2412	30	2432	50	2452	70	2472
11	2413	31	2433	51	2453	71	2473
12	2414	32	2434	52	2454	72	2474
13	2415	33	2435	53	2455	73	2475
14	2416	34	2436	54	2456	74	2476
15	2417	35	2437	55	2457	75	2477
16	2418	36	2438	56	2458	76	2478
17	2419	37	2439	57	2459	77	2479
18	2420	38	2440	58	2460	78	2480
19	2421	39	2441	59	2461		

#### 3.2.1 CONFIGURATION OF SYSTEM UNDER TEST

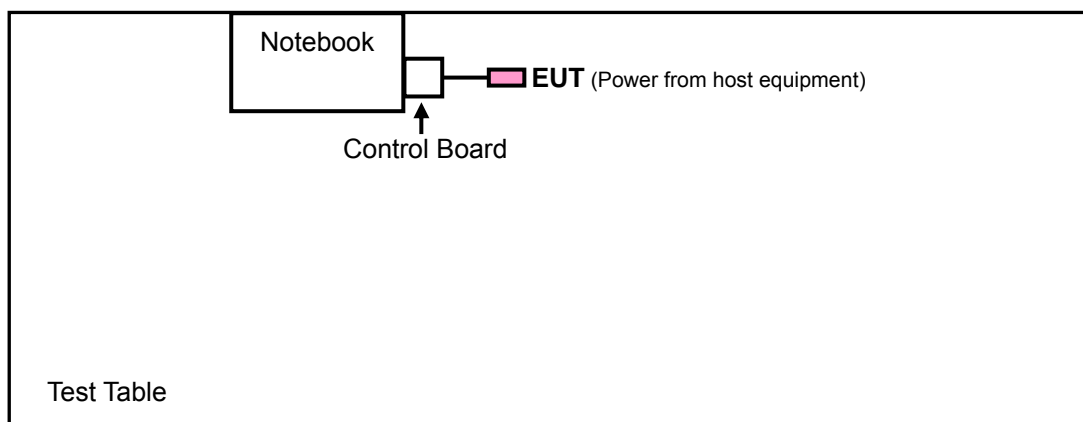

### 3.2.2 TEST MODE APPLICABILITY AND TESTED CHANNEL DETAIL

EUT CONFIGURE MODE	APPLICABLE TO				DESCRIPTION
	RE $\geq$ 1G	RE<1G	PLC	APCM	
A	√	√	-	-	Antenna No.: 1
B	√	√	-	-	Antenna No.: 2
C	√	√	√	√	Antenna No.: 3

Where **RE $\geq$ 1G**: Radiated Emission above 1GHz

**RE<1G**: Radiated Emission below 1GHz

**PLC**: Power Line Conducted Emission

**APCM**: Antenna Port Conducted Measurement

“-“: Mean no effect

#### **RADIATED EMISSION TEST (ABOVE 1 GHz):**

- Pre-Scan has been conducted to determine the worst-case mode from all possible combinations between available modulations, data rates, XYZ axis, antenna ports (if EUT with antenna diversity architecture) and packet type.
- Following channel(s) was (were) selected for the final test as listed below.

EUT CONFIGURE MODE	AVAILABLE CHANNEL	TESTED CHANNEL	MODULATION TECHNOLOGY	MODULATION TYPE	PACKET TYPE	AXIS
A, B, C	0 to 78	0, 39, 78	FHSS	GFSK	DH5	X
A, B, C	0 to 78	0, 39, 78	FHSS	8DPSK	DH5	X

#### **RADIATED EMISSION TEST (BELOW 1 GHz):**

- Pre-Scan has been conducted to determine the worst-case mode from all possible combinations between available modulations, data rates, XYZ axis, antenna ports (if EUT with antenna diversity architecture) and packet type.
- Following channel(s) was (were) selected for the final test as listed below.

EUT CONFIGURE MODE	AVAILABLE CHANNEL	TESTED CHANNEL	MODULATION TECHNOLOGY	MODULATION TYPE	PACKET TYPE	AXIS
A, B, C	0 to 78	0	FHSS	8DPSK	DH5	X

#### **POWER LINE CONDUCTED EMISSION TEST:**

- Pre-Scan has been conducted to determine the worst-case mode from all possible combinations between available modulations, antenna ports (if EUT with antenna diversity architecture), and packet types.
- Following channel(s) was (were) selected for the final test as listed below.

EUT CONFIGURE MODE	AVAILABLE CHANNEL	TESTED CHANNEL	MODULATION TECHNOLOGY	MODULATION TYPE	PACKET TYPE
C	0 to 78	0	FHSS	8DPSK	DH5





**BANDEDGE MEASUREMENT:**

- Pre-Scan has been conducted to determine the worst-case mode from all possible combinations between available modulations, antenna ports (if EUT with antenna diversity architecture), and packet types.
- Following channel(s) was (were) selected for the final test as listed below.

EUT CONFIGURE MODE	AVAILABLE CHANNEL	TESTED CHANNEL	MODULATION TECHNOLOGY	MODULATION TYPE	PACKET TYPE
A, B, C	0 to 78	0, 78	FHSS	GFSK	DH5
A, B, C	0 to 78	0, 78	FHSS	8DPSK	DH5

**ANTENNA PORT CONDUCTED MEASUREMENT:**

- Pre-Scan has been conducted to determine the worst-case mode from all possible combinations between available modulations, antenna ports (if EUT with antenna diversity architecture), and packet types.
- Following channel(s) was (were) selected for the final test as listed below.

EUT CONFIGURE MODE	AVAILABLE CHANNEL	TESTED CHANNEL	MODULATION TECHNOLOGY	MODULATION TYPE	PACKET TYPE
C	0 to 78	0, 39, 78	FHSS	GFSK	DH5
C	0 to 78	0, 39, 78	FHSS	8DPSK	DH5



### 3.3 GENERAL DESCRIPTION OF APPLIED STANDARDS

The EUT is a RF Product. According to the specifications of the manufacturer, it must comply with the requirements of the following standards:

#### FCC Part 15, Subpart C. (15.247)

#### ANSI C63.4-2003

All test items have been performed and recorded as per the above standards.

**NOTE:** The EUT is also considered as a kind of computer peripheral, because the connection to computer is necessary for typical use. It has been verified to comply with the requirements of FCC Part 15, Subpart B, Class B (DoC). The test report has been issued separately.

### 3.4 DESCRIPTION OF SUPPORT UNITS

The EUT has been tested as an independent unit together with other necessary accessories or support units. The following support units or accessories were used to form a representative test configuration during the tests.

NO.	PRODUCT	BRAND	MODEL NO.	SERIAL NO.	FCC ID
1	NOTEBOOK COMPUTER	DELL	PP05L	16484462992	E2K24CLNS
2	CONTROL BOARD	NA	NA	NA	NA

NO.	SIGNAL CABLE DESCRIPTION OF THE ABOVE SUPPORT UNITS
1	NA
2	0.5m shielded USB cable

**NOTE:** All power cords of the above support units are non shielded (1.8m).

## 4. TEST TYPES AND RESULTS

### 4.1 RADIATED EMISSION MEASUREMENT

#### 4.1.1 LIMITS OF RADIATED EMISSION MEASUREMENT

Emissions radiated outside of the specified bands, shall be according to the general radiated limits in 15.209 as following:

FREQUENCIES (MHz)	FIELD STRENGTH (microvolts/meter)	MEASUREMENT DISTANCE (meters)
0.009 ~ 0.490	2400/F(kHz)	300
0.490 ~ 1.705	24000/F(kHz)	30
1.705 ~ 30.0	30	30
30 ~ 88	100	3
88 ~ 216	150	3
216 ~ 960	200	3
Above 960	500	3

**NOTE:**

1. The lower limit shall apply at the transition frequencies.
2. Emission level (dBuV/m) = 20 log Emission level (uV/m).
3. As shown in 15.35(b), for frequencies above 1000MHz, the field strength limits are based on average detector, however, the peak field strength of any emission shall not exceed the maximum permitted average limits, specified above by more than 20dB under any condition of modulation.



#### 4.1.2 TEST INSTRUMENTS

DESCRIPTION & MANUFACTURER	MODEL NO.	SERIAL NO.	CALIBRATED UNTIL
Test Receiver ROHDE & SCHWARZ	ESCI	100424	Jul. 27, 2008
Spectrum Analyzer ROHDE & SCHWARZ	FSP40	100269	Aug. 05, 2008
BILOG Antenna SCHWARZBECK	VULB9168	9168-153	Jan. 03, 2009
HORN Antenna SCHWARZBECK	BBHA 9120 D	9120D-563	Jul. 30, 2008
HORN Antenna SCHWARZBECK	BBHA 9170	BBHA9170242	Jan. 06, 2009
Preamplifier Agilent	8449B	3008A01910	Sep. 19, 2008
Preamplifier Agilent	8447D	2944A10638	Dec. 19, 2008
RF signal cable HUBER+SUHNNER	SUCOFLEX 104	274039/223650	Nov. 07, 2008
RF signal cable Worken	8D-FB	Cable-HYCH9-01	Aug. 09, 2008
Software	ADT_Radiated_V7.6	NA	NA
Antenna Tower EMCO	2070/2080	512.835.4684	NA
Turn Table EMCO	2087-2.03	NA	NA
Antenna Tower & Turn Table Controller EMCO	2090	NA	NA

- NOTE:**
1. The calibration interval of the above test instruments is 12 months and the calibrations are traceable to NML/ROC and NIST/USA.
  2. The test was performed in HwaYa Chamber 9.
  3. The horn antenna and HP preamplifier (model: 8449B) are used only for the measurement of emission frequency above 1GHz if tested.
  4. The FCC Site Registration No. is 215374.
  5. The IC Site Registration No. is IC3789B-9.

#### 4.1.3 TEST PROCEDURES

- a. The EUT was placed on the top of a rotating table 0.8 meters above the ground at a 3 meter semi-anechoic chamber. The table was rotated 360 degrees to determine the position of the highest radiation.
- b. The EUT was set 3 meters away from the interference-receiving antenna, which was mounted on the top of a variable-height antenna tower.
- c. The antenna is a broadband antenna, and its height is varied from one meter to four meters above the ground to determine the maximum value of the field strength. Both horizontal and vertical polarizations of the antenna are set to make the measurement.
- d. For each suspected emission, the EUT was arranged to its worst case and then the antenna was tuned to heights from 1 meter to 4 meters and the rotatable table was turned from 0 degrees to 360 degrees to find the maximum reading.
- e. The test-receiver system was set to Peak Detect Function and Specified Bandwidth with Maximum Hold Mode.
- f. If the emission level of the EUT in peak mode was lower than the limit specified, then testing could be stopped and the peak values of the EUT would be reported. Otherwise the emissions would be re-tested one by one using peak, quasi-peak or average method as specified and then reported in a data sheet.

**NOTE:**

1. The resolution bandwidth and video bandwidth of test receiver/spectrum analyzer is 120kHz for Quasi-peak detection at frequency below 1GHz.
2. The resolution bandwidth of test receiver/spectrum analyzer is 1 MHz and video bandwidth is 3MHz for Peak detection at frequency above 1GHz.
3. All modes of operation were investigated and the worst-case emissions are reported.

#### 4.1.4 DEVIATION FROM TEST STANDARD

No deviation

#### 4.1.5 TEST SETUP

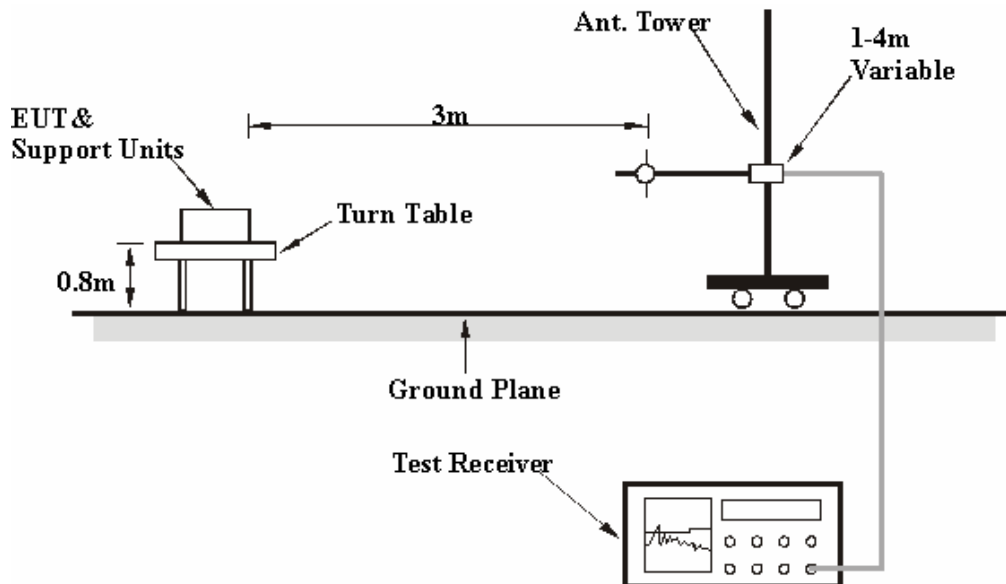

For the actual test configuration, please refer to the attached file (Test Setup Photo).

#### 4.1.6 EUT OPERATING CONDITIONS

- Connected EUT with notebook system via control board and placed on a testing table.
- The notebook system ran a test program (provided by manufacturer) to enable EUT under transmitting condition continuously at specific channel frequency.
- The necessary accessories enable the system in full functions.

#### 4.1.7 TEST RESULTS

##### Radiated Above 1GHz DATA: GFSK MODULATION

EUT TEST CONDITION		MEASUREMENT DETAIL	
CHANNEL	Channel 0	FREQUENCY RANGE	1 ~ 25GHz
MODULATION TYPE	GFSK	DETECTOR FUNCTION	Peak (PK) Average (AV)
INPUT POWER (SYSTEM)	120Vac, 60 Hz	ENVIRONMENTAL CONDITIONS	24deg. C, 70%RH, 1017hPa
TESTED BY	Lori Chiu	TEST MODE	A

ANTENNA POLARITY & TEST DISTANCE: HORIZONTAL AT 3 M								
NO.	FREQ. (MHz)	EMISSION LEVEL (dBuV/m)	LIMIT (dBuV/m)	MARGIN (dB)	ANTENNA HEIGHT (m)	TABLE ANGLE (Degree)	RAW VALUE (dBuV)	CORRECTION FACTOR (dB/m)
1	2390.00	36.85 PK	74.00	-37.15	1.04 H	39	4.53	32.32
2	2390.00	27.35 AV	54.00	-26.65	1.04 H	39	-4.97	32.32
3	*2402.00	95.78 PK			1.04 H	39	63.47	32.31
4	*2402.00	65.68 AV			1.04 H	39	33.37	32.31
5	4804.00	50.29 PK	74.00	-23.71	1.28 H	118	12.34	37.95
6	4804.00	20.19 AV	54.00	-33.81	1.28 H	118	-17.76	37.95
7	7206.00	57.74 PK	74.00	-16.26	1.18 H	100	12.90	44.85
8	7206.00	27.64 AV	54.00	-26.36	1.18 H	100	-17.20	44.85

ANTENNA POLARITY & TEST DISTANCE: VERTICAL AT 3 M								
NO.	FREQ. (MHz)	EMISSION LEVEL (dBuV/m)	LIMIT (dBuV/m)	MARGIN (dB)	ANTENNA HEIGHT (m)	TABLE ANGLE (Degree)	RAW VALUE (dBuV)	CORRECTION FACTOR (dB/m)
1	2390.00	33.81 PK	74.00	-40.19	1.70 V	30	1.49	32.32
2	2390.00	24.31 AV	54.00	-29.69	1.70 V	30	-8.01	32.32
3	*2402.00	92.74 PK			1.70 V	30	60.43	32.31
4	*2402.00	62.64 AV			1.70 V	30	30.33	32.31
5	4804.00	48.79 PK	74.00	-25.21	1.05 V	251	10.84	37.95
6	4804.00	18.69 AV	54.00	-35.31	1.05 V	251	-19.26	37.95
7	7206.00	54.86 PK	74.00	-19.14	1.39 V	13	10.02	44.85
8	7206.00	24.76 AV	54.00	-29.24	1.39 V	13	-20.08	44.85

- REMARKS:**
1. Emission level (dBuV/m) = Raw Value (dBuV) + Correction Factor (dB/m).
  2. Correction Factor (dB/m) = Antenna Factor (dB/m) + Cable Factor (dB).
  3. The other emission levels were very low against the limit.
  4. Margin value = Emission level – Limit value.
  5. “ \* “: Fundamental frequency.
  6. The DH5 packet was the worse case duty cycle for a transmit dwell time on a channel, based upon bluetooth theory the transmitter is on 0.625 \* 5 per 296.25 ms per channel. Therefore, the duty cycle correlation factor be equal to:  $20\log(3.125 / 100) = -30.1$  dB.
  7. Average value = peak reading +  $20\log(\text{duty cycle})$ .

EUT TEST CONDITION		MEASUREMENT DETAIL	
CHANNEL	Channel 39	FREQUENCY RANGE	1 ~ 25GHz
MODULATION TYPE	GFSK	DETECTOR FUNCTION	Peak (PK) Average (AV)
INPUT POWER (SYSTEM)	120Vac, 60 Hz	ENVIRONMENTAL CONDITIONS	24deg. C, 70%RH, 1017hPa
TESTED BY	Lori Chiu	TEST MODE	A

ANTENNA POLARITY & TEST DISTANCE: HORIZONTAL AT 3 M								
NO.	FREQ. (MHz)	EMISSION LEVEL (dBuV/m)	LIMIT (dBuV/m)	MARGIN (dB)	ANTENNA HEIGHT (m)	TABLE ANGLE (Degree)	RAW VALUE (dBuV)	CORRECTION FACTOR (dB/m)
1	*2441.00	95.33 PK			1.01 H	20	62.98	32.35
2	*2441.00	65.23 AV			1.01 H	20	32.88	32.35
3	4882.00	50.61 PK	74.00	-23.39	1.14 H	51	12.47	38.14
4	4882.00	20.51 AV	54.00	-33.49	1.14 H	51	-17.63	38.14
5	7323.00	58.08 PK	74.00	-15.92	1.05 H	211	13.10	44.98
6	7323.00	27.98 AV	54.00	-26.02	1.05 H	211	-17.00	44.98
ANTENNA POLARITY & TEST DISTANCE: VERTICAL AT 3 M								
NO.	FREQ. (MHz)	EMISSION LEVEL (dBuV/m)	LIMIT (dBuV/m)	MARGIN (dB)	ANTENNA HEIGHT (m)	TABLE ANGLE (Degree)	RAW VALUE (dBuV)	CORRECTION FACTOR (dB/m)
1	*2441.00	92.36 PK			1.62 V	40	60.01	32.35
2	*2441.00	62.26 AV			1.62 V	40	29.91	32.35
3	4882.00	48.80 PK	74.00	-25.20	1.01 V	5	10.66	38.14
4	4882.00	18.70 AV	54.00	-35.30	1.01 V	5	-19.44	38.14
5	7323.00	55.11 PK	74.00	-18.89	1.23 V	352	10.13	44.98
6	7323.00	25.01 AV	54.00	-28.99	1.23 V	352	-19.97	44.98

- REMARKS:**
- Emission level (dBuV/m) = Raw Value (dBuV) + Correction Factor (dB/m).
  - Correction Factor (dB/m) = Antenna Factor (dB/m) + Cable Factor (dB).
  - The other emission levels were very low against the limit.
  - Margin value = Emission level – Limit value.
  - “ \* “: Fundamental frequency.
  - The DH5 packet was the worse case duty cycle for a transmit dwell time on a channel, based upon bluetooth theory the transmitter is on 0.625 \* 5 per 296.25 ms per channel. Therefore, the duty cycle correlation factor be equal to:  $20\log(3.125 / 100) = -30.1$  dB.
  - Average value = peak reading +  $20\log(\text{duty cycle})$ .





EUT TEST CONDITION		MEASUREMENT DETAIL	
CHANNEL	Channel 78	FREQUENCY RANGE	1 ~ 25GHz
MODULATION TYPE	GFSK	DETECTOR FUNCTION	Peak (PK) Average (AV)
INPUT POWER (SYSTEM)	120Vac, 60 Hz	ENVIRONMENTAL CONDITIONS	24deg. C, 70%RH, 1017hPa
TESTED BY	Lori Chiu	TEST MODE	A

ANTENNA POLARITY & TEST DISTANCE: HORIZONTAL AT 3 M								
NO.	FREQ. (MHz)	EMISSION LEVEL (dBuV/m)	LIMIT (dBuV/m)	MARGIN (dB)	ANTENNA HEIGHT (m)	TABLE ANGLE (Degree)	RAW VALUE (dBuV)	CORRECTION FACTOR (dB/m)
1	*2480.00	94.96 PK			1.00 H	19	62.58	32.38
2	*2480.00	64.86 AV			1.00 H	19	32.48	32.38
3	2483.50	35.59 PK	74.00	-38.41	1.00 H	19	3.20	32.39
4	2483.50	26.09 AV	54.00	-27.91	1.00 H	19	-6.30	32.39
5	4960.00	50.90 PK	74.00	-23.10	1.00 H	89	12.60	38.30
6	4960.00	20.80 AV	54.00	-33.20	1.00 H	89	-17.50	38.30
7	7440.00	58.36 PK	74.00	-15.64	1.39 H	69	13.34	45.02
8	7440.00	28.26 AV	54.00	-25.74	1.39 H	69	-16.76	45.02
ANTENNA POLARITY & TEST DISTANCE: VERTICAL AT 3 M								
NO.	FREQ. (MHz)	EMISSION LEVEL (dBuV/m)	LIMIT (dBuV/m)	MARGIN (dB)	ANTENNA HEIGHT (m)	TABLE ANGLE (Degree)	RAW VALUE (dBuV)	CORRECTION FACTOR (dB/m)
1	*2480.00	91.82 PK			1.53 V	36	59.44	32.38
2	*2480.00	61.72 AV			1.53 V	36	29.34	32.38
3	2483.50	32.45 PK	74.00	-41.55	1.53 V	36	0.06	32.39
4	2483.50	22.95 AV	54.00	-31.05	1.53 V	36	-9.44	32.39
5	4960.00	48.94 PK	74.00	-25.06	1.10 V	301	10.64	38.30
6	4960.00	18.84 AV	54.00	-35.16	1.10 V	301	-19.46	38.30
7	7440.00	55.46 PK	74.00	-18.54	1.25 V	342	10.44	45.02
8	7440.00	25.36 AV	54.00	-28.64	1.25 V	342	-19.66	45.02

- REMARKS:**
1. Emission level (dBuV/m) = Raw Value (dBuV) + Correction Factor (dB/m).
  2. Correction Factor (dB/m) = Antenna Factor (dB/m) + Cable Factor (dB).
  3. The other emission levels were very low against the limit.
  4. Margin value = Emission level – Limit value.
  5. “ \* “: Fundamental frequency.
  6. The DH5 packet was the worse case duty cycle for a transmit dwell time on a channel, based upon bluetooth theory the transmitter is on 0.625 \* 5 per 296.25 ms per channel. Therefore, the duty cycle correlation factor be equal to:  $20\log(3.125 / 100) = -30.1$  dB.
  7. Average value = peak reading +  $20\log(\text{duty cycle})$ .



EUT TEST CONDITION		MEASUREMENT DETAIL	
CHANNEL	Channel 0	FREQUENCY RANGE	1 ~ 25GHz
MODULATION TYPE	GFSK	DETECTOR FUNCTION	Peak (PK) Average (AV)
INPUT POWER (SYSTEM)	120Vac, 60 Hz	ENVIRONMENTAL CONDITIONS	24deg. C, 70%RH, 1016hPa
TESTED BY	Lori Chiu	TEST MODE	B

**ANTENNA POLARITY & TEST DISTANCE: HORIZONTAL AT 3 M**

NO.	FREQ. (MHz)	EMISSION LEVEL (dBuV/m)	LIMIT (dBuV/m)	MARGIN (dB)	ANTENNA HEIGHT (m)	TABLE ANGLE (Degree)	RAW VALUE (dBuV)	CORRECTION FACTOR (dB/m)
1	2390.00	36.12 PK	74.00	-37.88	1.05 H	19	3.80	32.32
2	2390.00	26.62 AV	54.00	-27.38	1.05 H	19	-5.70	32.32
3	*2402.00	91.21 PK			1.36 H	225	58.90	32.31
4	*2402.00	61.11 AV			1.36 H	225	28.80	32.31
5	4804.00	57.84 PK	74.00	-16.16	1.04 H	174	19.89	37.95
6	4804.00	27.74 AV	54.00	-26.26	1.04 H	174	-10.21	37.95
7	7206.00	56.87 PK	74.00	-17.13	1.03 H	202	12.03	44.85
8	7206.00	26.77 AV	54.00	-27.23	1.03 H	202	-18.07	44.85

**ANTENNA POLARITY & TEST DISTANCE: VERTICAL AT 3 M**

NO.	FREQ. (MHz)	EMISSION LEVEL (dBuV/m)	LIMIT (dBuV/m)	MARGIN (dB)	ANTENNA HEIGHT (m)	TABLE ANGLE (Degree)	RAW VALUE (dBuV)	CORRECTION FACTOR (dB/m)
1	2390.00	33.68 PK	74.00	-40.32	1.56 V	89	1.36	32.32
2	2390.00	24.18 AV	54.00	-29.82	1.56 V	89	-8.14	32.32
3	*2402.00	88.57 PK			1.00 V	261	56.26	32.31
4	*2402.00	58.47 AV			1.00 V	261	26.16	32.31
5	4804.00	52.07 PK	74.00	-21.93	1.00 V	89	14.12	37.95
6	4804.00	21.97 AV	54.00	-32.03	1.00 V	89	-15.98	37.95
7	7206.00	54.49 PK	74.00	-19.51	1.56 V	89	9.65	44.85
8	7206.00	24.39 AV	54.00	-29.61	1.56 V	89	-20.45	44.85

- REMARKS:**
- Emission level (dBuV/m) = Raw Value (dBuV) + Correction Factor (dB/m).
  - Correction Factor (dB/m) = Antenna Factor (dB/m) + Cable Factor (dB).
  - The other emission levels were very low against the limit.
  - Margin value = Emission level – Limit value.
  - \* \*: Fundamental frequency.
  - The DH5 packet was the worse case duty cycle for a transmit dwell time on a channel, based upon bluetooth theory the transmitter is on 0.625 \* 5 per 296.25 ms per channel. Therefore, the duty cycle correlation factor be equal to:  $20\log(3.125 / 100) = -30.1$  dB.
  - Average value = peak reading +  $20\log(\text{duty cycle})$ .



EUT TEST CONDITION		MEASUREMENT DETAIL	
CHANNEL	Channel 39	FREQUENCY RANGE	1 ~ 25GHz
MODULATION TYPE	GFSK	DETECTOR FUNCTION	Peak (PK) Average (AV)
INPUT POWER (SYSTEM)	120Vac, 60 Hz	ENVIRONMENTAL CONDITIONS	24deg. C, 70%RH, 1016hPa
TESTED BY	Lori Chiu	TEST MODE	B

ANTENNA POLARITY & TEST DISTANCE: HORIZONTAL AT 3 M								
NO.	FREQ. (MHz)	EMISSION LEVEL (dBuV/m)	LIMIT (dBuV/m)	MARGIN (dB)	ANTENNA HEIGHT (m)	TABLE ANGLE (Degree)	RAW VALUE (dBuV)	CORRECTION FACTOR (dB/m)
1	*2441.00	92.45 PK			1.24 H	247	60.10	32.35
2	*2441.00	62.35 AV			1.24 H	247	30.00	32.35
3	4882.00	55.64 PK	74.00	-18.36	1.32 H	246	17.50	38.14
4	4882.00	25.54 AV	54.00	-28.46	1.32 H	246	-12.60	38.14
5	7323.00	57.82 PK	74.00	-16.18	1.03 H	61	12.84	44.98
6	7323.00	27.72 AV	54.00	-26.28	1.03 H	61	-17.26	44.98
ANTENNA POLARITY & TEST DISTANCE: VERTICAL AT 3 M								
NO.	FREQ. (MHz)	EMISSION LEVEL (dBuV/m)	LIMIT (dBuV/m)	MARGIN (dB)	ANTENNA HEIGHT (m)	TABLE ANGLE (Degree)	RAW VALUE (dBuV)	CORRECTION FACTOR (dB/m)
1	*2441.00	88.79 PK			1.46 V	280	56.44	32.35
2	*2441.00	58.69 AV			1.46 V	280	26.34	32.35
3	4882.00	50.61 PK	74.00	-23.39	1.32 V	311	12.47	38.14
4	4882.00	20.51 AV	54.00	-33.49	1.32 V	311	-17.63	38.14
5	7323.00	55.84 PK	74.00	-18.16	1.22 V	198	10.86	44.98
6	7323.00	25.74 AV	54.00	-28.26	1.22 V	198	-19.24	44.98

- REMARKS:**
- Emission level (dBuV/m) = Raw Value (dBuV) + Correction Factor (dB/m).
  - Correction Factor (dB/m) = Antenna Factor (dB/m) + Cable Factor (dB).
  - The other emission levels were very low against the limit.
  - Margin value = Emission level – Limit value.
  - “ \* “: Fundamental frequency.
  - The DH5 packet was the worse case duty cycle for a transmit dwell time on a channel, based upon bluetooth theory the transmitter is on 0.625 \* 5 per 296.25 ms per channel. Therefore, the duty cycle correlation factor be equal to:  $20\log(3.125 / 100) = -30.1$  dB.
  - Average value = peak reading +  $20\log(\text{duty cycle})$ .

EUT TEST CONDITION		MEASUREMENT DETAIL	
CHANNEL	Channel 78	FREQUENCY RANGE	1 ~ 25GHz
MODULATION TYPE	GFSK	DETECTOR FUNCTION	Peak (PK) Average (AV)
INPUT POWER (SYSTEM)	120Vac, 60 Hz	ENVIRONMENTAL CONDITIONS	24deg. C, 70%RH, 1016hPa
TESTED BY	Lori Chiu	TEST MODE	B

ANTENNA POLARITY & TEST DISTANCE: HORIZONTAL AT 3 M								
NO.	FREQ. (MHz)	EMISSION LEVEL (dBuV/m)	LIMIT (dBuV/m)	MARGIN (dB)	ANTENNA HEIGHT (m)	TABLE ANGLE (Degree)	RAW VALUE (dBuV)	CORRECTION FACTOR (dB/m)
1	*2480.00	93.63 PK			1.32 H	59	61.25	32.38
2	*2480.00	63.53 AV			1.32 H	59	31.15	32.38
3	2483.50	35.56 PK	74.00	-38.44	1.32 H	59	3.17	32.39
4	2483.50	26.06 AV	54.00	-27.94	1.32 H	59	-6.33	32.39
5	4960.00	51.13 PK	74.00	-22.87	1.00 H	210	12.83	38.30
6	4960.00	21.03 AV	54.00	-32.97	1.00 H	210	-17.27	38.30
7	7440.00	58.60 PK	74.00	-15.40	1.00 H	211	13.58	45.02
8	7440.00	28.50 AV	54.00	-25.50	1.00 H	211	-16.52	45.02
ANTENNA POLARITY & TEST DISTANCE: VERTICAL AT 3 M								
NO.	FREQ. (MHz)	EMISSION LEVEL (dBuV/m)	LIMIT (dBuV/m)	MARGIN (dB)	ANTENNA HEIGHT (m)	TABLE ANGLE (Degree)	RAW VALUE (dBuV)	CORRECTION FACTOR (dB/m)
1	*2480.00	90.69 PK			1.50 V	279	58.31	32.38
2	*2480.00	60.59 AV			1.50 V	279	28.21	32.38
3	2483.50	32.62 PK	74.00	-41.38	1.50 V	279	0.23	32.39
4	2483.50	23.12 AV	54.00	-30.88	1.50 V	279	-9.27	32.39
5	4960.00	46.99 PK	74.00	-27.01	1.05 V	100	8.69	38.30
6	4960.00	16.89 AV	54.00	-37.11	1.05 V	100	-21.41	38.30
7	7440.00	56.74 PK	74.00	-17.26	1.37 V	258	11.72	45.02
8	7440.00	26.64 AV	54.00	-27.36	1.37 V	258	-18.38	45.02

- REMARKS:**
1. Emission level (dBuV/m) = Raw Value (dBuV) + Correction Factor (dB/m).
  2. Correction Factor (dB/m) = Antenna Factor (dB/m) + Cable Factor (dB).
  3. The other emission levels were very low against the limit.
  4. Margin value = Emission level – Limit value.
  5. “ \* “: Fundamental frequency.
  6. The DH5 packet was the worse case duty cycle for a transmit dwell time on a channel, based upon bluetooth theory the transmitter is on 0.625 \* 5 per 296.25 ms per channel. Therefore, the duty cycle correlation factor be equal to:  $20\log(3.125 / 100) = -30.1$  dB.
  7. Average value = peak reading +  $20\log(\text{duty cycle})$ .

EUT TEST CONDITION		MEASUREMENT DETAIL	
CHANNEL	Channel 0	FREQUENCY RANGE	1 ~ 25GHz
MODULATION TYPE	GFSK	DETECTOR FUNCTION	Peak (PK) Average (AV)
INPUT POWER (SYSTEM)	120Vac, 60 Hz	ENVIRONMENTAL CONDITIONS	24deg. C, 70%RH, 1011hPa
TESTED BY	Lori Chiu	TEST MODE	C

**ANTENNA POLARITY & TEST DISTANCE: HORIZONTAL AT 3 M**

NO.	FREQ. (MHz)	EMISSION LEVEL (dBuV/m)	LIMIT (dBuV/m)	MARGIN (dB)	ANTENNA HEIGHT (m)	TABLE ANGLE (Degree)	RAW VALUE (dBuV)	CORRECTION FACTOR (dB/m)
1	2390.00	38.28 PK	74.00	-35.72	1.31 H	279	5.96	32.32
2	2390.00	28.78 AV	54.00	-25.22	1.31 H	279	-3.54	32.32
3	*2402.00	98.66 PK			1.31 H	279	66.35	32.31
4	*2402.00	68.56 AV			1.31 H	279	36.25	32.31
5	4804.00	57.94 PK	74.00	-16.06	1.25 H	266	19.99	37.95
6	4804.00	27.84 AV	54.00	-26.16	1.25 H	266	-10.11	37.95
7	7206.00	58.71 PK	74.00	-15.29	1.21 H	82	13.87	44.85
8	7206.00	28.61 AV	54.00	-25.39	1.21 H	82	-16.23	44.85

**ANTENNA POLARITY & TEST DISTANCE: VERTICAL AT 3 M**

NO.	FREQ. (MHz)	EMISSION LEVEL (dBuV/m)	LIMIT (dBuV/m)	MARGIN (dB)	ANTENNA HEIGHT (m)	TABLE ANGLE (Degree)	RAW VALUE (dBuV)	CORRECTION FACTOR (dB/m)
1	2390.00	31.79 PK	74.00	-42.21	1.00 V	246	-0.53	32.32
2	2390.00	22.29 AV	54.00	-31.71	1.00 V	246	-10.03	32.32
3	*2402.00	92.17 PK			1.00 V	246	59.86	32.31
4	*2402.00	62.07 AV			1.00 V	246	29.76	32.31
5	4804.00	52.47 PK	74.00	-21.53	1.10 V	343	14.52	37.95
6	4804.00	22.37 AV	54.00	-31.63	1.10 V	343	-15.58	37.95
7	7206.00	56.10 PK	74.00	-17.90	1.00 V	346	11.26	44.85
8	7206.00	26.00 AV	54.00	-28.00	1.00 V	346	-18.84	44.85

- REMARKS:**
- Emission level (dBuV/m) = Raw Value (dBuV) + Correction Factor (dB/m).
  - Correction Factor (dB/m) = Antenna Factor (dB/m) + Cable Factor (dB).
  - The other emission levels were very low against the limit.
  - Margin value = Emission level – Limit value.
  - \* \*: Fundamental frequency.
  - The DH5 packet was the worse case duty cycle for a transmit dwell time on a channel, based upon bluetooth theory the transmitter is on 0.625 \* 5 per 296.25 ms per channel. Therefore, the duty cycle correlation factor be equal to:  $20\log(3.125 / 100) = -30.1$  dB.
  - Average value = peak reading +  $20\log(\text{duty cycle})$ .



EUT TEST CONDITION		MEASUREMENT DETAIL	
CHANNEL	Channel 39	FREQUENCY RANGE	1 ~ 25GHz
MODULATION TYPE	GFSK	DETECTOR FUNCTION	Peak (PK) Average (AV)
INPUT POWER (SYSTEM)	120Vac, 60 Hz	ENVIRONMENTAL CONDITIONS	24deg. C, 70%RH, 1011hPa
TESTED BY	Lori Chiu	TEST MODE	C

ANTENNA POLARITY & TEST DISTANCE: HORIZONTAL AT 3 M								
NO.	FREQ. (MHz)	EMISSION LEVEL (dBuV/m)	LIMIT (dBuV/m)	MARGIN (dB)	ANTENNA HEIGHT (m)	TABLE ANGLE (Degree)	RAW VALUE (dBuV)	CORRECTION FACTOR (dB/m)
1	*2441.00	97.12 PK			1.02 H	288	64.77	32.35
2	*2441.00	67.02 AV			1.02 H	288	34.67	32.35
3	4882.00	56.64 PK	74.00	-17.36	1.09 H	241	18.50	38.14
4	4882.00	26.54 AV	54.00	-27.46	1.09 H	241	-11.60	38.14
5	7323.00	57.88 PK	74.00	-16.12	1.00 H	271	12.90	44.98
6	7323.00	27.78 AV	54.00	-26.22	1.00 H	271	-17.20	44.98
ANTENNA POLARITY & TEST DISTANCE: VERTICAL AT 3 M								
NO.	FREQ. (MHz)	EMISSION LEVEL (dBuV/m)	LIMIT (dBuV/m)	MARGIN (dB)	ANTENNA HEIGHT (m)	TABLE ANGLE (Degree)	RAW VALUE (dBuV)	CORRECTION FACTOR (dB/m)
1	*2441.00	91.08 PK			1.52 V	355	58.73	32.35
2	*2441.00	60.98 AV			1.52 V	355	28.63	32.35
3	4882.00	52.89 PK	74.00	-21.11	1.07 V	302	14.75	38.14
4	4882.00	22.79 AV	54.00	-31.21	1.07 V	302	-15.35	38.14
5	7323.00	55.46 PK	74.00	-18.54	1.02 V	216	10.48	44.98
6	7323.00	25.36 AV	54.00	-28.64	1.02 V	216	-19.62	44.98

- REMARKS:**
- Emission level (dBuV/m) = Raw Value (dBuV) + Correction Factor (dB/m).
  - Correction Factor (dB/m) = Antenna Factor (dB/m) + Cable Factor (dB).
  - The other emission levels were very low against the limit.
  - Margin value = Emission level – Limit value.
  - “ \* “: Fundamental frequency.
  - The DH5 packet was the worse case duty cycle for a transmit dwell time on a channel, based upon bluetooth theory the transmitter is on 0.625 \* 5 per 296.25 ms per channel. Therefore, the duty cycle correlation factor be equal to:  $20\log(3.125 / 100) = -30.1$  dB.
  - Average value = peak reading +  $20\log(\text{duty cycle})$ .

EUT TEST CONDITION		MEASUREMENT DETAIL	
CHANNEL	Channel 78	FREQUENCY RANGE	1 ~ 25GHz
MODULATION TYPE	GFSK	DETECTOR FUNCTION	Peak (PK) Average (AV)
INPUT POWER (SYSTEM)	120Vac, 60 Hz	ENVIRONMENTAL CONDITIONS	24deg. C, 70%RH, 1011hPa
TESTED BY	Lori Chiu	TEST MODE	C

ANTENNA POLARITY & TEST DISTANCE: HORIZONTAL AT 3 M								
NO.	FREQ. (MHz)	EMISSION LEVEL (dBuV/m)	LIMIT (dBuV/m)	MARGIN (dB)	ANTENNA HEIGHT (m)	TABLE ANGLE (Degree)	RAW VALUE (dBuV)	CORRECTION FACTOR (dB/m)
1	*2480.00	95.47 PK			1.01 H	216	63.09	32.38
2	*2480.00	65.37 AV			1.01 H	216	32.99	32.38
3	2483.50	35.35 PK	74.00	-38.65	1.01 H	216	2.96	32.39
4	2483.50	25.85 AV	54.00	-28.15	1.01 H	216	-6.54	32.39
5	4960.00	54.62 PK	74.00	-19.38	1.00 H	216	16.32	38.30
6	4960.00	24.52 AV	54.00	-29.48	1.00 H	216	-13.78	38.30
7	7440.00	56.46 PK	74.00	-17.54	1.00 H	46	11.44	45.02
8	7440.00	26.36 AV	54.00	-27.64	1.00 H	46	-18.66	45.02
ANTENNA POLARITY & TEST DISTANCE: VERTICAL AT 3 M								
NO.	FREQ. (MHz)	EMISSION LEVEL (dBuV/m)	LIMIT (dBuV/m)	MARGIN (dB)	ANTENNA HEIGHT (m)	TABLE ANGLE (Degree)	RAW VALUE (dBuV)	CORRECTION FACTOR (dB/m)
1	*2480.00	89.25 PK			1.61 V	194	56.87	32.38
2	*2480.00	59.15 AV			1.61 V	194	26.77	32.38
3	2483.50	29.13 PK	74.00	-44.87	1.61 V	194	-3.26	32.39
4	2483.50	19.63 AV	54.00	-34.37	1.61 V	194	-12.76	32.39
5	4960.00	53.36 PK	74.00	-20.64	1.09 V	10	15.06	38.30
6	4960.00	23.26 AV	54.00	-30.74	1.09 V	10	-15.04	38.30
7	7440.00	54.97 PK	74.00	-19.03	1.01 V	314	9.95	45.02
8	7440.00	24.87 AV	54.00	-29.13	1.01 V	314	-20.15	45.02

- REMARKS:**
1. Emission level (dBuV/m) = Raw Value (dBuV) + Correction Factor (dB/m).
  2. Correction Factor (dB/m) = Antenna Factor (dB/m) + Cable Factor (dB).
  3. The other emission levels were very low against the limit.
  4. Margin value = Emission level – Limit value.
  5. “ \* “: Fundamental frequency.
  6. The DH5 packet was the worse case duty cycle for a transmit dwell time on a channel, based upon bluetooth theory the transmitter is on 0.625 \* 5 per 296.25 ms per channel. Therefore, the duty cycle correlation factor be equal to:  $20\log(3.125 / 100) = -30.1$  dB.
  7. Average value = peak reading +  $20\log(\text{duty cycle})$ .

### 8DPSK MODULATION

EUT TEST CONDITION		MEASUREMENT DETAIL	
CHANNEL	Channel 0	FREQUENCY RANGE	1 ~ 25GHz
MODULATION TYPE	8DPSK	DETECTOR FUNCTION	Peak (PK) Average (AV)
INPUT POWER (SYSTEM)	120Vac, 60 Hz	ENVIRONMENTAL CONDITIONS	24deg. C, 70%RH, 1017hPa
TESTED BY	Lori Chiu	TEST MODE	A

ANTENNA POLARITY & TEST DISTANCE: HORIZONTAL AT 3 M								
NO.	FREQ. (MHz)	EMISSION LEVEL (dBuV/m)	LIMIT (dBuV/m)	MARGIN (dB)	ANTENNA HEIGHT (m)	TABLE ANGLE (Degree)	RAW VALUE (dBuV)	CORRECTION FACTOR (dB/m)
1	2390.00	38.67 PK	74.00	-35.33	1.08 H	162	6.35	32.32
2	2390.00	29.17 AV	54.00	-24.83	1.08 H	162	-3.15	32.32
3	*2402.00	95.44 PK			1.08 H	162	63.13	32.31
4	*2402.00	65.34 AV			1.08 H	162	33.03	32.31
5	4804.00	49.14 PK	74.00	-24.86	1.28 H	87	11.19	37.95
6	4804.00	19.04 AV	54.00	-34.96	1.28 H	87	-18.91	37.95
7	7206.00	61.58 PK	74.00	-12.42	1.40 H	71	16.74	44.85
8	7206.00	31.48 AV	54.00	-22.52	1.40 H	71	-13.36	44.85
ANTENNA POLARITY & TEST DISTANCE: VERTICAL AT 3 M								
NO.	FREQ. (MHz)	EMISSION LEVEL (dBuV/m)	LIMIT (dBuV/m)	MARGIN (dB)	ANTENNA HEIGHT (m)	TABLE ANGLE (Degree)	RAW VALUE (dBuV)	CORRECTION FACTOR (dB/m)
1	2390.00	35.80 PK	74.00	-38.20	1.72 V	27	3.48	32.32
2	2390.00	26.30 AV	54.00	-27.70	1.72 V	27	-6.02	32.32
3	*2402.00	92.57 PK			1.72 V	27	60.26	32.31
4	*2402.00	62.47 AV			1.72 V	27	30.16	32.31
5	4804.00	47.84 PK	74.00	-26.16	1.52 V	18	9.89	37.95
6	4804.00	17.74 AV	54.00	-36.26	1.52 V	18	-20.21	37.95
7	7206.00	59.25 PK	74.00	-14.75	1.40 V	13	14.41	44.85
8	7206.00	29.15 AV	54.00	-24.85	1.40 V	13	-15.69	44.85

- REMARKS:**
1. Emission level (dBuV/m) = Raw Value (dBuV) + Correction Factor (dB/m).
  2. Correction Factor (dB/m) = Antenna Factor (dB/m) + Cable Factor (dB).
  3. The other emission levels were very low against the limit.
  4. Margin value = Emission level – Limit value.
  5. “ \* “: Fundamental frequency.
  6. The DH5 packet was the worse case duty cycle for a transmit dwell time on a channel, based upon bluetooth theory the transmitter is on 0.625 \* 5 per 296.25 ms per channel. Therefore, the duty cycle correlation factor be equal to:  $20\log(3.125 / 100) = -30.1$  dB.
  7. Average value = peak reading +  $20\log(\text{duty cycle})$ .



EUT TEST CONDITION		MEASUREMENT DETAIL	
CHANNEL	Channel 39	FREQUENCY RANGE	1 ~ 25GHz
MODULATION TYPE	8DPSK	DETECTOR FUNCTION	Peak (PK) Average (AV)
INPUT POWER (SYSTEM)	120Vac, 60 Hz	ENVIRONMENTAL CONDITIONS	24deg. C, 70%RH, 1017hPa
TESTED BY	Lori Chiu	TEST MODE	A

ANTENNA POLARITY & TEST DISTANCE: HORIZONTAL AT 3 M								
NO.	FREQ. (MHz)	EMISSION LEVEL (dBuV/m)	LIMIT (dBuV/m)	MARGIN (dB)	ANTENNA HEIGHT (m)	TABLE ANGLE (Degree)	RAW VALUE (dBuV)	CORRECTION FACTOR (dB/m)
1	*2441.00	95.16 PK			1.03 H	19	62.81	32.35
2	*2441.00	65.06 AV			1.03 H	19	32.71	32.35
3	4882.00	49.32 PK	74.00	-24.68	1.03 H	100	11.18	38.14
4	4882.00	19.22 AV	54.00	-34.78	1.03 H	100	-18.92	38.14
5	7323.00	62.36 PK	74.00	-11.64	1.35 H	67	17.38	44.98
6	7323.00	32.26 AV	54.00	-21.74	1.35 H	67	-12.72	44.98
ANTENNA POLARITY & TEST DISTANCE: VERTICAL AT 3 M								
NO.	FREQ. (MHz)	EMISSION LEVEL (dBuV/m)	LIMIT (dBuV/m)	MARGIN (dB)	ANTENNA HEIGHT (m)	TABLE ANGLE (Degree)	RAW VALUE (dBuV)	CORRECTION FACTOR (dB/m)
1	*2441.00	92.19 PK			1.21 V	61	59.84	32.35
2	*2441.00	62.09 AV			1.21 V	61	29.74	32.35
3	4882.00	47.92 PK	74.00	-26.08	1.42 V	136	9.78	38.14
4	4882.00	17.82 AV	54.00	-36.18	1.42 V	136	-20.32	38.14
5	7323.00	60.42 PK	74.00	-13.58	1.00 V	147	15.44	44.98
6	7323.00	30.32 AV	54.00	-23.68	1.00 V	147	-14.66	44.98

- REMARKS:**
1. Emission level (dBuV/m) = Raw Value (dBuV) + Correction Factor (dB/m).
  2. Correction Factor (dB/m) = Antenna Factor (dB/m) + Cable Factor (dB).
  3. The other emission levels were very low against the limit.
  4. Margin value = Emission level – Limit value.
  5. “ \* “: Fundamental frequency.
  6. The DH5 packet was the worse case duty cycle for a transmit dwell time on a channel, based upon bluetooth theory the transmitter is on 0.625 \* 5 per 296.25 ms per channel. Therefore, the duty cycle correlation factor be equal to:  $20\log(3.125 / 100) = -30.1$  dB.
  7. Average value = peak reading +  $20\log(\text{duty cycle})$ .

EUT TEST CONDITION		MEASUREMENT DETAIL	
CHANNEL	Channel 78	FREQUENCY RANGE	1 ~ 25GHz
MODULATION TYPE	8DPSK	DETECTOR FUNCTION	Peak (PK) Average (AV)
INPUT POWER (SYSTEM)	120Vac, 60 Hz	ENVIRONMENTAL CONDITIONS	24deg. C, 70%RH, 1017hPa
TESTED BY	Lori Chiu	TEST MODE	A

ANTENNA POLARITY & TEST DISTANCE: HORIZONTAL AT 3 M								
NO.	FREQ. (MHz)	EMISSION LEVEL (dBuV/m)	LIMIT (dBuV/m)	MARGIN (dB)	ANTENNA HEIGHT (m)	TABLE ANGLE (Degree)	RAW VALUE (dBuV)	CORRECTION FACTOR (dB/m)
1	*2480.00	94.87 PK			1.01 H	21	62.49	32.38
2	*2480.00	64.77 AV			1.01 H	21	32.39	32.38
3	2483.50	37.84 PK	74.00	-36.16	1.01 H	21	5.45	32.39
4	2483.50	28.34 AV	54.00	-25.66	1.01 H	21	-4.05	32.39
5	4960.00	50.14 PK	74.00	-23.86	1.10 H	208	11.84	38.30
6	4960.00	20.04 AV	54.00	-33.96	1.10 H	208	-18.26	38.30
7	7440.00	62.81 PK	74.00	-11.19	1.58 H	99	17.79	45.02
8	7440.00	32.71 AV	54.00	-21.29	1.58 H	99	-12.31	45.02
ANTENNA POLARITY & TEST DISTANCE: VERTICAL AT 3 M								
NO.	FREQ. (MHz)	EMISSION LEVEL (dBuV/m)	LIMIT (dBuV/m)	MARGIN (dB)	ANTENNA HEIGHT (m)	TABLE ANGLE (Degree)	RAW VALUE (dBuV)	CORRECTION FACTOR (dB/m)
1	*2480.00	91.79 PK			1.60 V	41	59.41	32.38
2	*2480.00	61.69 AV			1.60 V	41	29.31	32.38
3	2483.50	34.76 PK	74.00	-39.24	1.60 V	41	2.37	32.39
4	2483.50	25.26 AV	54.00	-28.74	1.60 V	41	-7.13	32.39
5	4960.00	48.20 PK	74.00	-25.80	1.11 V	13	9.90	38.30
6	4960.00	18.10 AV	54.00	-35.90	1.11 V	13	-20.20	38.30
7	7440.00	60.58 PK	74.00	-13.42	1.36 V	307	15.56	45.02
8	7440.00	30.48 AV	54.00	-23.52	1.36 V	307	-14.54	45.02

- REMARKS:**
1. Emission level (dBuV/m) = Raw Value (dBuV) + Correction Factor (dB/m).
  2. Correction Factor (dB/m) = Antenna Factor (dB/m) + Cable Factor (dB).
  3. The other emission levels were very low against the limit.
  4. Margin value = Emission level – Limit value.
  5. “ \* “: Fundamental frequency.
  6. The DH5 packet was the worse case duty cycle for a transmit dwell time on a channel, based upon bluetooth theory the transmitter is on 0.625 \* 5 per 296.25 ms per channel. Therefore, the duty cycle correlation factor be equal to:  $20\log(3.125 / 100) = -30.1$  dB.
  7. Average value = peak reading +  $20\log(\text{duty cycle})$ .

EUT TEST CONDITION		MEASUREMENT DETAIL	
CHANNEL	Channel 0	FREQUENCY RANGE	1 ~ 25GHz
MODULATION TYPE	8DPSK	DETECTOR FUNCTION	Peak (PK) Average (AV)
INPUT POWER (SYSTEM)	120Vac, 60 Hz	ENVIRONMENTAL CONDITIONS	24deg. C, 70%RH, 1011hPa
TESTED BY	Lori Chiu	TEST MODE	B

ANTENNA POLARITY & TEST DISTANCE: HORIZONTAL AT 3 M								
NO.	FREQ. (MHz)	EMISSION LEVEL (dBuV/m)	LIMIT (dBuV/m)	MARGIN (dB)	ANTENNA HEIGHT (m)	TABLE ANGLE (Degree)	RAW VALUE (dBuV)	CORRECTION FACTOR (dB/m)
1	2390.00	36.31 PK	74.00	-37.69	1.28 H	246	3.99	32.32
2	2390.00	26.81 AV	54.00	-27.19	1.28 H	246	-5.51	32.32
3	*2402.00	91.07 PK			1.28 H	246	58.76	32.31
4	*2402.00	60.97 AV			1.28 H	246	28.66	32.31
5	4804.00	58.77 PK	74.00	-15.23	1.04 H	176	20.82	37.95
6	4804.00	28.67 AV	54.00	-25.33	1.04 H	176	-9.28	37.95
7	7206.00	58.51 PK	74.00	-15.49	1.04 H	178	13.67	44.85
8	7206.00	28.41 AV	54.00	-25.59	1.04 H	178	-16.43	44.85
ANTENNA POLARITY & TEST DISTANCE: VERTICAL AT 3 M								
NO.	FREQ. (MHz)	EMISSION LEVEL (dBuV/m)	LIMIT (dBuV/m)	MARGIN (dB)	ANTENNA HEIGHT (m)	TABLE ANGLE (Degree)	RAW VALUE (dBuV)	CORRECTION FACTOR (dB/m)
1	2390.00	32.87 PK	74.00	-41.13	1.04 V	155	0.55	32.32
2	2390.00	23.37 AV	54.00	-30.63	1.04 V	155	-8.95	32.32
3	*2402.00	87.63 PK			1.04 V	155	55.32	32.31
4	*2402.00	57.53 AV			1.04 V	155	25.22	32.31
5	4804.00	53.46 PK	74.00	-20.54	1.06 V	24	15.51	37.95
6	4804.00	23.36 AV	54.00	-30.64	1.06 V	24	-14.59	37.95
7	7206.00	56.28 PK	74.00	-17.72	1.00 V	97	11.43	44.85
8	7206.00	26.18 AV	54.00	-27.82	1.00 V	97	-18.67	44.85

- REMARKS:**
1. Emission level (dBuV/m) = Raw Value (dBuV) + Correction Factor (dB/m).
  2. Correction Factor (dB/m) = Antenna Factor (dB/m) + Cable Factor (dB).
  3. The other emission levels were very low against the limit.
  4. Margin value = Emission level – Limit value.
  5. “ \* “: Fundamental frequency.
  6. The DH5 packet was the worse case duty cycle for a transmit dwell time on a channel, based upon bluetooth theory the transmitter is on 0.625 \* 5 per 296.25 ms per channel. Therefore, the duty cycle correlation factor be equal to:  $20\log(3.125 / 100) = -30.1$  dB.
  7. Average value = peak reading +  $20\log(\text{duty cycle})$ .

EUT TEST CONDITION		MEASUREMENT DETAIL	
CHANNEL	Channel 39	FREQUENCY RANGE	1 ~ 25GHz
MODULATION TYPE	8DPSK	DETECTOR FUNCTION	Peak (PK) Average (AV)
INPUT POWER (SYSTEM)	120Vac, 60 Hz	ENVIRONMENTAL CONDITIONS	24deg. C, 70%RH, 1011hPa
TESTED BY	Lori Chiu	TEST MODE	B

ANTENNA POLARITY & TEST DISTANCE: HORIZONTAL AT 3 M								
NO.	FREQ. (MHz)	EMISSION LEVEL (dBuV/m)	LIMIT (dBuV/m)	MARGIN (dB)	ANTENNA HEIGHT (m)	TABLE ANGLE (Degree)	RAW VALUE (dBuV)	CORRECTION FACTOR (dB/m)
1	*2441.00	91.39 PK			1.22 H	341	59.04	32.35
2	*2441.00	61.29 AV			1.22 H	341	28.94	32.35
3	4882.00	56.67 PK	74.00	-17.33	1.00 H	123	18.53	38.14
4	4882.00	26.57 AV	54.00	-27.43	1.00 H	123	-11.57	38.14
5	7323.00	58.79 PK	74.00	-15.21	1.32 H	5	13.81	44.98
6	7323.00	28.69 AV	54.00	-25.31	1.32 H	5	-16.29	44.98
ANTENNA POLARITY & TEST DISTANCE: VERTICAL AT 3 M								
NO.	FREQ. (MHz)	EMISSION LEVEL (dBuV/m)	LIMIT (dBuV/m)	MARGIN (dB)	ANTENNA HEIGHT (m)	TABLE ANGLE (Degree)	RAW VALUE (dBuV)	CORRECTION FACTOR (dB/m)
1	*2441.00	87.90 PK			1.00 V	213	55.55	32.35
2	*2441.00	57.80 AV			1.00 V	213	25.45	32.35
3	4882.00	51.32 PK	74.00	-22.68	1.00 V	358	13.18	38.14
4	4882.00	21.22 AV	54.00	-32.78	1.00 V	358	-16.92	38.14
5	7323.00	56.30 PK	74.00	-17.70	1.01 V	130	11.32	44.98
6	7323.00	26.20 AV	54.00	-27.80	1.01 V	130	-18.78	44.98

- REMARKS:**
1. Emission level (dBuV/m) = Raw Value (dBuV) + Correction Factor (dB/m).
  2. Correction Factor (dB/m) = Antenna Factor (dB/m) + Cable Factor (dB).
  3. The other emission levels were very low against the limit.
  4. Margin value = Emission level – Limit value.
  5. “ \* “: Fundamental frequency.
  6. The DH5 packet was the worse case duty cycle for a transmit dwell time on a channel, based upon bluetooth theory the transmitter is on 0.625 \* 5 per 296.25 ms per channel. Therefore, the duty cycle correlation factor be equal to:  $20\log(3.125 / 100) = -30.1$  dB.
  7. Average value = peak reading +  $20\log(\text{duty cycle})$ .

EUT TEST CONDITION		MEASUREMENT DETAIL	
CHANNEL	Channel 78	FREQUENCY RANGE	1 ~ 25GHz
MODULATION TYPE	8DPSK	DETECTOR FUNCTION	Peak (PK) Average (AV)
INPUT POWER (SYSTEM)	120Vac, 60 Hz	ENVIRONMENTAL CONDITIONS	24deg. C, 70%RH, 1011hPa
TESTED BY	Lori Chiu	TEST MODE	B

ANTENNA POLARITY & TEST DISTANCE: HORIZONTAL AT 3 M								
NO.	FREQ. (MHz)	EMISSION LEVEL (dBuV/m)	LIMIT (dBuV/m)	MARGIN (dB)	ANTENNA HEIGHT (m)	TABLE ANGLE (Degree)	RAW VALUE (dBuV)	CORRECTION FACTOR (dB/m)
1	*2480.00	92.58 PK			1.29 H	245	60.20	32.38
2	*2480.00	62.48 AV			1.29 H	245	30.10	32.38
3	2483.50	35.50 PK	74.00	-38.50	1.29 H	245	3.11	32.39
4	2483.50	26.00 AV	54.00	-28.00	1.29 H	245	-6.39	32.39
5	4960.00	52.32 PK	74.00	-21.68	1.20 H	59	14.02	38.30
6	4960.00	22.22 AV	54.00	-31.78	1.20 H	59	-16.08	38.30
7	7440.00	59.97 PK	74.00	-14.03	1.10 H	154	14.95	45.02
8	7440.00	29.87 AV	54.00	-24.13	1.10 H	154	-15.15	45.02
ANTENNA POLARITY & TEST DISTANCE: VERTICAL AT 3 M								
NO.	FREQ. (MHz)	EMISSION LEVEL (dBuV/m)	LIMIT (dBuV/m)	MARGIN (dB)	ANTENNA HEIGHT (m)	TABLE ANGLE (Degree)	RAW VALUE (dBuV)	CORRECTION FACTOR (dB/m)
1	*2480.00	89.88 PK			1.43 V	261	57.50	32.38
2	*2480.00	59.78 AV			1.43 V	261	27.40	32.38
3	2483.50	32.80 PK	74.00	-41.20	1.43 V	261	0.41	32.39
4	2483.50	23.30 AV	54.00	-30.70	1.43 V	261	-9.09	32.39
5	4960.00	47.53 PK	74.00	-26.47	1.01 V	102	9.23	38.30
6	4960.00	17.43 AV	54.00	-36.57	1.01 V	102	-20.87	38.30
7	7440.00	57.13 PK	74.00	-16.87	1.30 V	147	12.11	45.02
8	7440.00	27.03 AV	54.00	-26.97	1.30 V	147	-17.99	45.02

- REMARKS:**
1. Emission level (dBuV/m) = Raw Value (dBuV) + Correction Factor (dB/m).
  2. Correction Factor (dB/m) = Antenna Factor (dB/m) + Cable Factor (dB).
  3. The other emission levels were very low against the limit.
  4. Margin value = Emission level – Limit value.
  5. “ \* “: Fundamental frequency.
  6. The DH5 packet was the worse case duty cycle for a transmit dwell time on a channel, based upon bluetooth theory the transmitter is on 0.625 \* 5 per 296.25 ms per channel. Therefore, the duty cycle correlation factor be equal to:  $20\log(3.125 / 100) = -30.1$  dB.
  7. Average value = peak reading +  $20\log(\text{duty cycle})$ .

EUT TEST CONDITION		MEASUREMENT DETAIL	
CHANNEL	Channel 0	FREQUENCY RANGE	1 ~ 25GHz
MODULATION TYPE	8DPSK	DETECTOR FUNCTION	Peak (PK) Average (AV)
INPUT POWER (SYSTEM)	120Vac, 60 Hz	ENVIRONMENTAL CONDITIONS	24deg. C, 70%RH, 1011hPa
TESTED BY	Lori Chiu	TEST MODE	C

ANTENNA POLARITY & TEST DISTANCE: HORIZONTAL AT 3 M								
NO.	FREQ. (MHz)	EMISSION LEVEL (dBuV/m)	LIMIT (dBuV/m)	MARGIN (dB)	ANTENNA HEIGHT (m)	TABLE ANGLE (Degree)	RAW VALUE (dBuV)	CORRECTION FACTOR (dB/m)
1	2390.00	37.65 PK	74.00	-36.35	1.34 H	213	5.33	32.32
2	2390.00	28.15 AV	54.00	-25.85	1.34 H	213	-4.17	32.32
3	*2402.00	97.92 PK			1.34 H	213	65.61	32.31
4	*2402.00	67.82 AV			1.34 H	213	35.51	32.31
5	4804.00	56.34 PK	74.00	-17.66	1.05 H	212	18.39	37.95
6	4804.00	26.24 AV	54.00	-27.76	1.05 H	212	-11.71	37.95
7	7206.00	61.44 PK	74.00	-12.56	1.02 H	20	16.60	44.85
8	7206.00	31.34 AV	54.00	-22.66	1.02 H	20	-13.50	44.85
ANTENNA POLARITY & TEST DISTANCE: VERTICAL AT 3 M								
NO.	FREQ. (MHz)	EMISSION LEVEL (dBuV/m)	LIMIT (dBuV/m)	MARGIN (dB)	ANTENNA HEIGHT (m)	TABLE ANGLE (Degree)	RAW VALUE (dBuV)	CORRECTION FACTOR (dB/m)
1	2390.00	31.10 PK	74.00	-42.90	1.01 V	250	-1.22	32.32
2	2390.00	21.60 AV	54.00	-32.40	1.01 V	250	-10.72	32.32
3	*2402.00	91.37 PK			1.01 V	250	59.06	32.31
4	*2402.00	61.27 AV			1.01 V	250	28.96	32.31
5	4804.00	51.66 PK	74.00	-22.34	1.09 V	25	13.71	37.95
6	4804.00	21.56 AV	54.00	-32.44	1.09 V	25	-16.39	37.95
7	7206.00	58.69 PK	74.00	-15.31	1.22 V	150	13.84	44.85
8	7206.00	28.59 AV	54.00	-25.41	1.22 V	150	-16.26	44.85

- REMARKS:**
1. Emission level (dBuV/m) = Raw Value (dBuV) + Correction Factor (dB/m).
  2. Correction Factor (dB/m) = Antenna Factor (dB/m) + Cable Factor (dB).
  3. The other emission levels were very low against the limit.
  4. Margin value = Emission level – Limit value.
  5. “ \* “: Fundamental frequency.
  6. The DH5 packet was the worse case duty cycle for a transmit dwell time on a channel, based upon bluetooth theory the transmitter is on 0.625 \* 5 per 296.25 ms per channel. Therefore, the duty cycle correlation factor be equal to:  $20\log(3.125 / 100) = -30.1$  dB.
  7. Average value = peak reading +  $20\log(\text{duty cycle})$ .

EUT TEST CONDITION		MEASUREMENT DETAIL	
CHANNEL	Channel 39	FREQUENCY RANGE	1 ~ 25GHz
MODULATION TYPE	8DPSK	DETECTOR FUNCTION	Peak (PK) Average (AV)
INPUT POWER (SYSTEM)	120Vac, 60 Hz	ENVIRONMENTAL CONDITIONS	24deg. C, 70%RH, 1011hPa
TESTED BY	Lori Chiu	TEST MODE	C

ANTENNA POLARITY & TEST DISTANCE: HORIZONTAL AT 3 M								
NO.	FREQ. (MHz)	EMISSION LEVEL (dBuV/m)	LIMIT (dBuV/m)	MARGIN (dB)	ANTENNA HEIGHT (m)	TABLE ANGLE (Degree)	RAW VALUE (dBuV)	CORRECTION FACTOR (dB/m)
1	*2441.00	96.52 PK			1.22 H	263	64.17	32.35
2	*2441.00	66.42 AV			1.22 H	263	34.07	32.35
3	4882.00	55.71 PK	74.00	-18.29	1.32 H	147	17.57	38.14
4	4882.00	25.61 AV	54.00	-28.39	1.32 H	147	-12.53	38.14
5	7323.00	60.39 PK	74.00	-13.61	1.07 H	218	15.41	44.98
6	7323.00	30.29 AV	54.00	-23.71	1.07 H	218	-14.69	44.98
ANTENNA POLARITY & TEST DISTANCE: VERTICAL AT 3 M								
NO.	FREQ. (MHz)	EMISSION LEVEL (dBuV/m)	LIMIT (dBuV/m)	MARGIN (dB)	ANTENNA HEIGHT (m)	TABLE ANGLE (Degree)	RAW VALUE (dBuV)	CORRECTION FACTOR (dB/m)
1	*2441.00	90.55 PK			1.44 V	16	58.20	32.35
2	*2441.00	60.45 AV			1.44 V	16	28.10	32.35
3	4882.00	51.07 PK	74.00	-22.93	1.05 V	167	12.93	38.14
4	4882.00	20.97 AV	54.00	-33.03	1.05 V	167	-17.17	38.14
5	7323.00	58.60 PK	74.00	-15.40	1.00 V	101	13.62	44.98
6	7323.00	28.50 AV	54.00	-25.50	1.00 V	101	-16.48	44.98

- REMARKS:**
1. Emission level (dBuV/m) = Raw Value (dBuV) + Correction Factor (dB/m).
  2. Correction Factor (dB/m) = Antenna Factor (dB/m) + Cable Factor (dB).
  3. The other emission levels were very low against the limit.
  4. Margin value = Emission level – Limit value.
  5. “ \* “: Fundamental frequency.
  6. The DH5 packet was the worse case duty cycle for a transmit dwell time on a channel, based upon bluetooth theory the transmitter is on 0.625 \* 5 per 296.25 ms per channel. Therefore, the duty cycle correlation factor be equal to:  $20\log(3.125 / 100) = -30.1$  dB.
  7. Average value = peak reading +  $20\log(\text{duty cycle})$ .



EUT TEST CONDITION		MEASUREMENT DETAIL	
CHANNEL	Channel 78	FREQUENCY RANGE	1 ~ 25GHz
MODULATION TYPE	8DPSK	DETECTOR FUNCTION	Peak (PK) Average (AV)
INPUT POWER (SYSTEM)	120Vac, 60 Hz	ENVIRONMENTAL CONDITIONS	24deg. C, 70%RH, 1017hPa
TESTED BY	Lori Chiu	TEST MODE	C

ANTENNA POLARITY & TEST DISTANCE: HORIZONTAL AT 3 M								
NO.	FREQ. (MHz)	EMISSION LEVEL (dBuV/m)	LIMIT (dBuV/m)	MARGIN (dB)	ANTENNA HEIGHT (m)	TABLE ANGLE (Degree)	RAW VALUE (dBuV)	CORRECTION FACTOR (dB/m)
1	*2480.00	94.66 PK			1.11 H	278	62.28	32.38
2	*2480.00	64.56 AV			1.11 H	278	32.18	32.38
3	2483.50	34.57 PK	74.00	-39.43	1.11 H	278	2.18	32.39
4	2483.50	25.07 AV	54.00	-28.93	1.11 H	278	-7.32	32.39
5	4960.00	53.69 PK	74.00	-20.31	1.25 H	58	15.39	38.30
6	4960.00	23.59 AV	54.00	-30.41	1.25 H	58	-14.71	38.30
7	7440.00	58.92 PK	74.00	-15.08	1.07 H	136	13.90	45.02
8	7440.00	28.82 AV	54.00	-25.18	1.07 H	136	-16.20	45.02
ANTENNA POLARITY & TEST DISTANCE: VERTICAL AT 3 M								
NO.	FREQ. (MHz)	EMISSION LEVEL (dBuV/m)	LIMIT (dBuV/m)	MARGIN (dB)	ANTENNA HEIGHT (m)	TABLE ANGLE (Degree)	RAW VALUE (dBuV)	CORRECTION FACTOR (dB/m)
1	*2480.00	88.73 PK			1.34 V	5	56.35	32.38
2	*2480.00	58.63 AV			1.34 V	5	26.25	32.38
3	2483.50	28.64 PK	74.00	-45.36	1.34 V	5	-3.75	32.39
4	2483.50	19.14 AV	54.00	-34.86	1.34 V	5	-13.25	32.39
5	4960.00	49.67 PK	74.00	-24.33	1.00 V	219	11.37	38.30
6	4960.00	19.57 AV	54.00	-34.43	1.00 V	219	-18.73	38.30
7	7440.00	56.92 PK	74.00	-17.08	1.41 V	352	11.90	45.02
8	7440.00	26.82 AV	54.00	-27.18	1.41 V	352	-18.20	45.02

- REMARKS:**
1. Emission level (dBuV/m) = Raw Value (dBuV) + Correction Factor (dB/m).
  2. Correction Factor (dB/m) = Antenna Factor (dB/m) + Cable Factor (dB).
  3. The other emission levels were very low against the limit.
  4. Margin value = Emission level – Limit value.
  5. “ \* “: Fundamental frequency.
  6. The DH5 packet was the worse case duty cycle for a transmit dwell time on a channel, based upon bluetooth theory the transmitter is on 0.625 \* 5 per 296.25 ms per channel. Therefore, the duty cycle correlation factor be equal to:  $20\log(3.125 / 100) = -30.1$  dB.
  7. Average value = peak reading +  $20\log(\text{duty cycle})$ .





**RADIATED BELOW 1GHz WORST-CASE DATA:**

EUT TEST CONDITION		MEASUREMENT DETAIL	
CHANNEL	Channel 0	FREQUENCY RANGE	Below 1000MHz
MODULATION TYPE	8DPSK	DETECTOR FUNCTION	Quasi-Peak
ENVIRONMENTAL CONDITIONS	23deg. C, 70%RH, 1014hPa	INPUT POWER (SYSTEM)	120Vac, 60 Hz
TESTED BY	Lori Chiu	TEST MODE	A

ANTENNA POLARITY & TEST DISTANCE: HORIZONTAL AT 3 M								
NO.	FREQ. (MHz)	EMISSION LEVEL (dBuV/m)	LIMIT (dBuV/m)	MARGIN (dB)	ANTENNA HEIGHT (m)	TABLE ANGLE (Degree)	RAW VALUE (dBuV)	CORRECTION FACTOR (dB/m)
1	115.45	31.09 QP	43.50	-12.41	1.50 H	286	19.89	11.20
2	167.94	28.07 QP	43.50	-15.43	1.50 H	253	14.97	13.10
3	214.61	28.79 QP	43.50	-14.71	1.00 H	256	17.59	11.20
4	239.88	31.11 QP	46.00	-14.89	1.00 H	73	18.79	12.33
5	274.88	29.60 QP	46.00	-16.40	1.00 H	52	16.41	13.18
6	300.16	29.14 QP	46.00	-16.86	1.00 H	55	15.54	13.60
7	799.84	29.43 QP	46.00	-16.57	1.00 H	70	4.50	24.92
8	829.00	32.28 QP	46.00	-13.72	1.00 H	10	7.09	25.20
9	953.44	30.30 QP	46.00	-15.70	1.50 H	316	3.96	26.35

ANTENNA POLARITY & TEST DISTANCE: VERTICAL AT 3 M								
NO.	FREQ. (MHz)	EMISSION LEVEL (dBuV/m)	LIMIT (dBuV/m)	MARGIN (dB)	ANTENNA HEIGHT (m)	TABLE ANGLE (Degree)	RAW VALUE (dBuV)	CORRECTION FACTOR (dB/m)
1	115.45	33.28 QP	43.50	-10.22	1.50 V	358	22.08	11.20
2	167.94	27.10 QP	43.50	-16.40	1.00 V	328	14.00	13.10
3	438.20	29.63 QP	46.00	-16.37	1.00 V	172	12.47	17.16
4	768.73	29.36 QP	46.00	-16.64	2.00 V	43	5.19	24.18
5	799.84	29.33 QP	46.00	-16.67	1.00 V	310	4.41	24.92
6	904.83	37.75 QP	46.00	-8.25	1.00 V	337	11.86	25.89
7	933.99	31.78 QP	46.00	-14.22	1.00 V	259	5.61	26.17
8	955.38	32.74 QP	46.00	-13.26	1.50 V	28	6.39	26.36

- REMARKS:**
1. Emission level (dBuV/m) = Raw Value (dBuV) + Correction Factor (dB/m).
  2. Correction Factor (dB/m) = Antenna Factor (dB/m) + Cable Factor (dB).
  3. The other emission levels were very low against the limit.
  4. Margin value = Emission level – Limit value.

EUT TEST CONDITION		MEASUREMENT DETAIL	
CHANNEL	Channel 0	FREQUENCY RANGE	Below 1000MHz
MODULATION TYPE	8DPSK	DETECTOR FUNCTION	Quasi-Peak
ENVIRONMENTAL CONDITIONS	23deg. C, 70%RH, 1014hPa	INPUT POWER (SYSTEM)	120Vac, 60 Hz
TESTED BY	Mark Liao	TEST MODE	B

ANTENNA POLARITY & TEST DISTANCE: HORIZONTAL AT 3 M								
NO.	FREQ. (MHz)	EMISSION LEVEL (dBuV/m)	LIMIT (dBuV/m)	MARGIN (dB)	ANTENNA HEIGHT (m)	TABLE ANGLE (Degree)	RAW VALUE (dBuV)	CORRECTION FACTOR (dB/m)
1	113.50	36.46 QP	43.50	-7.04	1.50 H	97	24.62	11.84
2	131.00	38.40 QP	43.50	-5.10	2.00 H	223	25.15	13.25
3	154.33	36.06 QP	43.50	-7.44	2.00 H	226	21.77	14.29
4	167.94	37.34 QP	43.50	-6.16	1.50 H	235	23.43	13.91
5	179.61	36.53 QP	43.50	-6.97	2.00 H	241	23.50	13.03
6	667.63	33.09 QP	46.00	-12.91	1.25 H	196	9.28	23.80
ANTENNA POLARITY & TEST DISTANCE: VERTICAL AT 3 M								
NO.	FREQ. (MHz)	EMISSION LEVEL (dBuV/m)	LIMIT (dBuV/m)	MARGIN (dB)	ANTENNA HEIGHT (m)	TABLE ANGLE (Degree)	RAW VALUE (dBuV)	CORRECTION FACTOR (dB/m)
1	113.50	35.08 QP	43.50	-8.42	1.00 V	190	23.23	11.84
2	167.94	34.61 QP	43.50	-8.89	2.00 V	163	20.70	13.91
3	179.61	36.22 QP	43.50	-7.28	2.00 V	172	23.19	13.03
4	191.28	35.92 QP	43.50	-7.58	2.00 V	166	23.90	12.02
5	202.94	35.44 QP	43.50	-8.06	2.00 V	139	24.04	11.39
6	595.69	29.98 QP	46.00	-16.02	1.00 V	4	7.63	22.35

- REMARKS:**
1. Emission level (dBuV/m) = Raw Value (dBuV) + Correction Factor (dB/m).
  2. Correction Factor (dB/m) = Antenna Factor (dB/m) + Cable Factor (dB).
  3. The other emission levels were very low against the limit.
  4. Margin value = Emission level – Limit value.

EUT TEST CONDITION		MEASUREMENT DETAIL	
CHANNEL	Channel 0	FREQUENCY RANGE	Below 1000MHz
MODULATION TYPE	8DPSK	DETECTOR FUNCTION	Quasi-Peak
ENVIRONMENTAL CONDITIONS	23deg. C, 70%RH, 1014hPa	INPUT POWER (SYSTEM)	120Vac, 60 Hz
TESTED BY	Mark Liao	TEST MODE	C

ANTENNA POLARITY & TEST DISTANCE: HORIZONTAL AT 3 M								
NO.	FREQ. (MHz)	EMISSION LEVEL (dBuV/m)	LIMIT (dBuV/m)	MARGIN (dB)	ANTENNA HEIGHT (m)	TABLE ANGLE (Degree)	RAW VALUE (dBuV)	CORRECTION FACTOR (dB/m)
1	120.00	41.99 QP	43.50	-1.51	1.48 H	225	29.35	12.64
2	131.98	42.39 QP	43.50	-1.11	2.01 H	238	29.09	13.30
3	167.94	40.11 QP	43.50	-3.39	1.50 H	235	26.20	13.91
4	179.61	38.28 QP	43.50	-5.22	2.00 H	235	25.25	13.03
5	191.28	36.10 QP	43.50	-7.40	1.50 H	220	24.08	12.02
6	611.24	26.97 QP	46.00	-19.03	1.25 H	232	4.26	22.71
ANTENNA POLARITY & TEST DISTANCE: VERTICAL AT 3 M								
NO.	FREQ. (MHz)	EMISSION LEVEL (dBuV/m)	LIMIT (dBuV/m)	MARGIN (dB)	ANTENNA HEIGHT (m)	TABLE ANGLE (Degree)	RAW VALUE (dBuV)	CORRECTION FACTOR (dB/m)
1	115.45	33.60 QP	43.50	-9.90	1.25 V	10	21.52	12.08
2	131.00	33.64 QP	43.50	-9.86	2.00 V	184	20.39	13.25
3	154.33	30.58 QP	43.50	-12.92	2.00 V	121	16.28	14.29
4	167.94	32.23 QP	43.50	-11.27	2.00 V	151	18.32	13.91
5	179.61	29.93 QP	43.50	-13.57	2.00 V	136	16.90	13.03
6	733.73	27.52 QP	46.00	-18.48	2.00 V	199	2.35	25.18

- REMARKS:**
1. Emission level (dBuV/m) = Raw Value (dBuV) + Correction Factor (dB/m).
  2. Correction Factor (dB/m) = Antenna Factor (dB/m) + Cable Factor (dB).
  3. The other emission levels were very low against the limit.
  4. Margin value = Emission level – Limit value.

## 4.2 CONDUCTED EMISSION MEASUREMENT

### 4.2.1 LIMITS OF CONDUCTED EMISSION MEASUREMENT

FREQUENCY OF EMISSION (MHz)	CONDUCTED LIMIT (dB $\mu$ V)	
	Quasi-peak	Average
0.15 ~ 0.5	66 to 56	56 to 46
0.5 ~ 5	56	46
5 ~ 30	60	50

- NOTE:**
1. The lower limit shall apply at the transition frequencies.
  2. The limit decreases in line with the logarithm of the frequency in the range of 0.15 to 0.50 MHz.
  3. All emanations from a class A/B digital device or system, including any network of conductors and apparatus connected thereto, shall not exceed the level of field strengths specified above.

### 4.2.2 TEST INSTRUMENTS

DESCRIPTION & MANUFACTURER	MODEL NO.	SERIAL NO.	CALIBRATED UNTIL
Test Receiver ROHDE & SCHWARZ	ESCS30	100289	Dec. 06, 2008
RF signal cable Woken	5D-FB	Cable-HYC01-01	Jan. 06, 2009
LISN ROHDE & SCHWARZ	ESH3-Z5	100312	Jan. 30, 2009
LISN ROHDE & SCHWARZ	ESH2-Z5	100104	Sep. 11, 2008
Software ADT	ADT_Cond_V3	NA	NA

- NOTE:**
1. The calibration interval of the above test instruments is 12 months and the calibrations are traceable to NML/ROC and NIST/USA.
  2. The test was performed in HwaYa Shielded Room 1.
  3. The VCCI Site Registration No. is C-2040.

#### 4.2.3 TEST PROCEDURES

- a. The EUT was placed 0.4 meters from the conducting wall of the shielded room with EUT being connected to the power mains through a line impedance stabilization network (LISN). Other support units were connected to the power mains through another LISN. The two LISNs provide 50 ohm/ 50uH of coupling impedance for the measuring instrument.
- b. Both lines of the power mains connected to the EUT were checked for maximum conducted interference.
- c. The frequency range from 150kHz to 30MHz was searched. Emission levels under (Limit - 20dB) was not recorded.

**NOTE:** All modes of operation were investigated and the worst-case emissions are reported.

#### 4.2.4 DEVIATION FROM TEST STANDARD

No deviation

#### 4.2.5 TEST SETUP

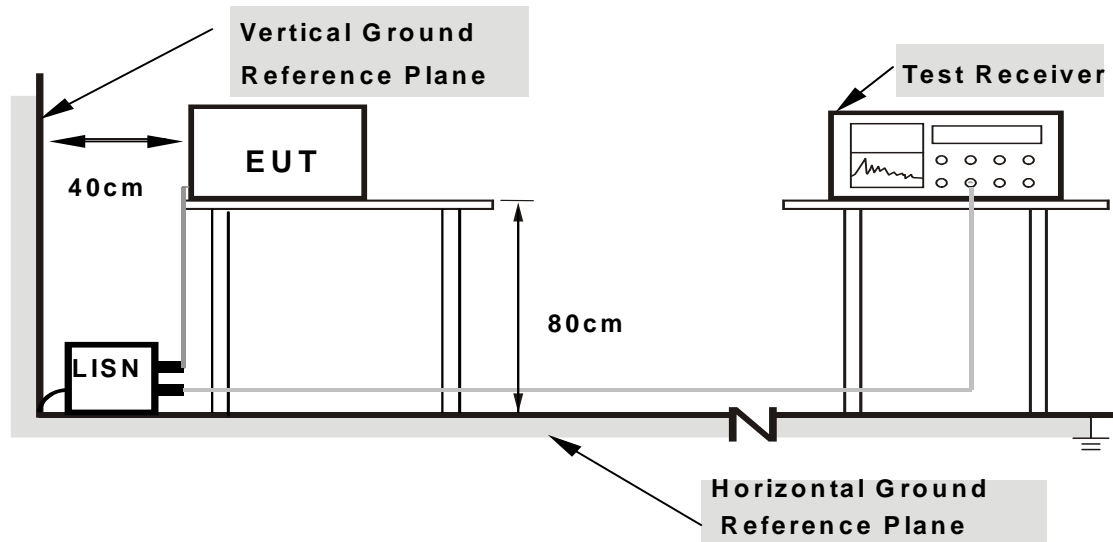

- Note:** 1.Support units were connected to second LISN.  
2.Both of LISNs (AMN) are 80 cm from EUT and at least 80  
from other units and other metal planes

For the actual test configuration, please refer to the attached file (Test Setup Photo).

#### 4.2.6 EUT OPERATING CONDITIONS

Same as 4.1.6

## 4.2.7 TEST RESULTS

### CONDUCTED WORST CASE DATA

EUT TEST CONDITION		MEASUREMENT DETAIL	
CHANNEL	Channel 0	PHASE	Line 1
MODULATION TYPE	8DPSK	6dB BANDWIDTH	9 kHz
ENVIRONMENTAL CONDITIONS	25deg. C, 65%RH, 1017Pa	INPUT POWER (SYSTEM)	120Vac, 60 Hz
TESTED BY	Lori Chiu	TEST MODE	C

No	Freq. [MHz]	Corr. Factor (dB)	Reading Value [dB (uV)]		Emission Level [dB (uV)]		Limit [dB (uV)]		Margin (dB)	
			Q.P.	AV.	Q.P.	AV.	Q.P.	AV.	Q.P.	AV.
1	0.177	0.21	46.70	-	46.91	-	64.61	54.61	-17.70	-
2	0.236	0.21	41.10	-	41.31	-	62.24	52.24	-20.93	-
3	0.353	0.21	31.28	-	31.49	-	58.89	48.89	-27.40	-
4	1.884	0.26	31.82	-	32.08	-	56.00	46.00	-23.92	-
5	3.711	0.37	33.58	-	33.95	-	56.00	46.00	-22.05	-
6	20.480	1.07	18.86	-	19.93	-	60.00	50.00	-40.07	-

- REMARKS:**
1. Q.P. and AV. are abbreviations of quasi-peak and average individually.
  2. "-": The Quasi-peak reading value also meets average limit and measurement with the average detector is unnecessary.
  3. The emission levels of other frequencies were very low against the limit.
  4. Margin value = Emission level - Limit value
  5. Correction factor = Insertion loss + Cable loss
  6. Emission Level = Correction Factor + Reading Value.

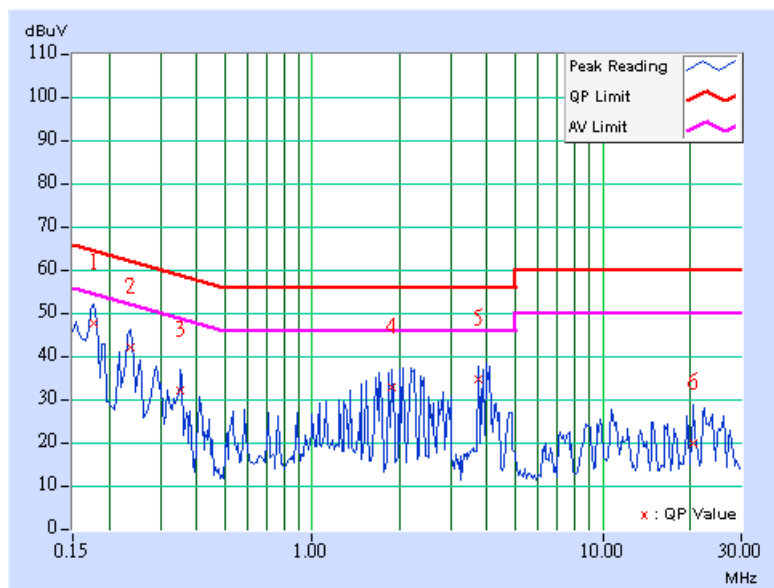

EUT TEST CONDITION		MEASUREMENT DETAIL	
CHANNEL	Channel 0	PHASE	Line 2
MODULATION TYPE	8DPSK	6dB BANDWIDTH	9 kHz
ENVIRONMENTAL CONDITIONS	25deg. C, 65%RH, 1017Pa	INPUT POWER (SYSTEM)	120Vac, 60 Hz
TESTED BY	Lori Chiu	TEST MODE	C

No	Freq. [MHz]	Corr. Factor (dB)	Reading Value [dB (uV)]		Emission Level [dB (uV)]		Limit [dB (uV)]		Margin (dB)	
			Q.P.	AV.	Q.P.	AV.	Q.P.	AV.	Q.P.	AV.
1	0.177	0.21	46.86	-	47.07	-	64.61	54.61	-17.54	-
2	0.236	0.21	41.94	-	42.15	-	62.24	52.24	-20.09	-
3	0.295	0.21	37.42	-	37.63	-	60.40	50.40	-22.77	-
4	0.353	0.21	31.90	-	32.11	-	58.89	48.89	-26.78	-
5	3.656	0.37	30.12	-	30.49	-	56.00	46.00	-25.51	-
6	22.207	0.54	19.42	-	19.96	-	60.00	50.00	-40.04	-

- REMARKS:**
1. Q.P. and AV. are abbreviations of quasi-peak and average individually.
  2. "-": The Quasi-peak reading value also meets average limit and measurement with the average detector is unnecessary.
  3. The emission levels of other frequencies were very low against the limit.
  4. Margin value = Emission level - Limit value
  5. Correction factor = Insertion loss + Cable loss
  6. Emission Level = Correction Factor + Reading Value.

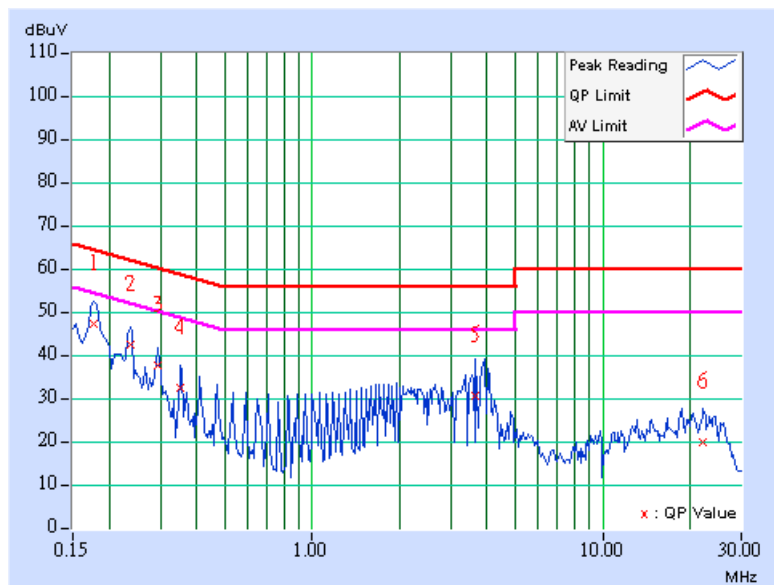





### 4.3 NUMBER OF HOPPING FREQUENCY USED

#### 4.3.1 LIMIT OF HOPPING FREQUENCY USED

At least 15 channels frequencies, and should be equally spaced.

#### 4.3.2 TEST INSTRUMENTS

DESCRIPTION & MANUFACTURER	MODEL NO.	SERIAL NO.	CALIBRATED UNTIL
SPECTRUM ANALYZER	FSP40	100040	Jun. 28, 2008

**NOTE:** The calibration interval of the above test instruments is 12 months. And the calibrations are traceable to NML/ROC and NIST/USA.

#### 4.3.3 TEST PROCEDURES

- a. Check the calibration of the measuring instrument (SA) using either an internal calibrator or a known signal from an external generator.
- b. Turn on the EUT and connect its antenna terminal to measurement via a low loss cable. Then set it to any one measured frequency within its operating range and make sure the instrument is operated in its linear range.
- c. Set the SA on MaxHold Mode, and then keep the EUT in hopping mode. Record all the signals from each channel until each one has been recorded.
- d. Set the SA on View mode and then plot the result on SA screen.
- e. Repeat above procedures until all frequencies measured were complete.

#### 4.3.4 DEVIATION FROM TEST STANDARD

No deviation.

#### 4.3.5 TEST SETUP

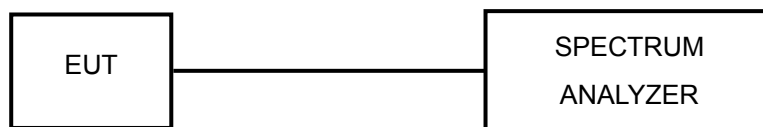

#### 4.3.6 TEST RESULTS

There are 79 hopping frequencies in the hopping mode. Please refer to next two pages for the test result. On the plots, it shows that the hopping frequencies are equally spaced.



## GFSK MODULATION

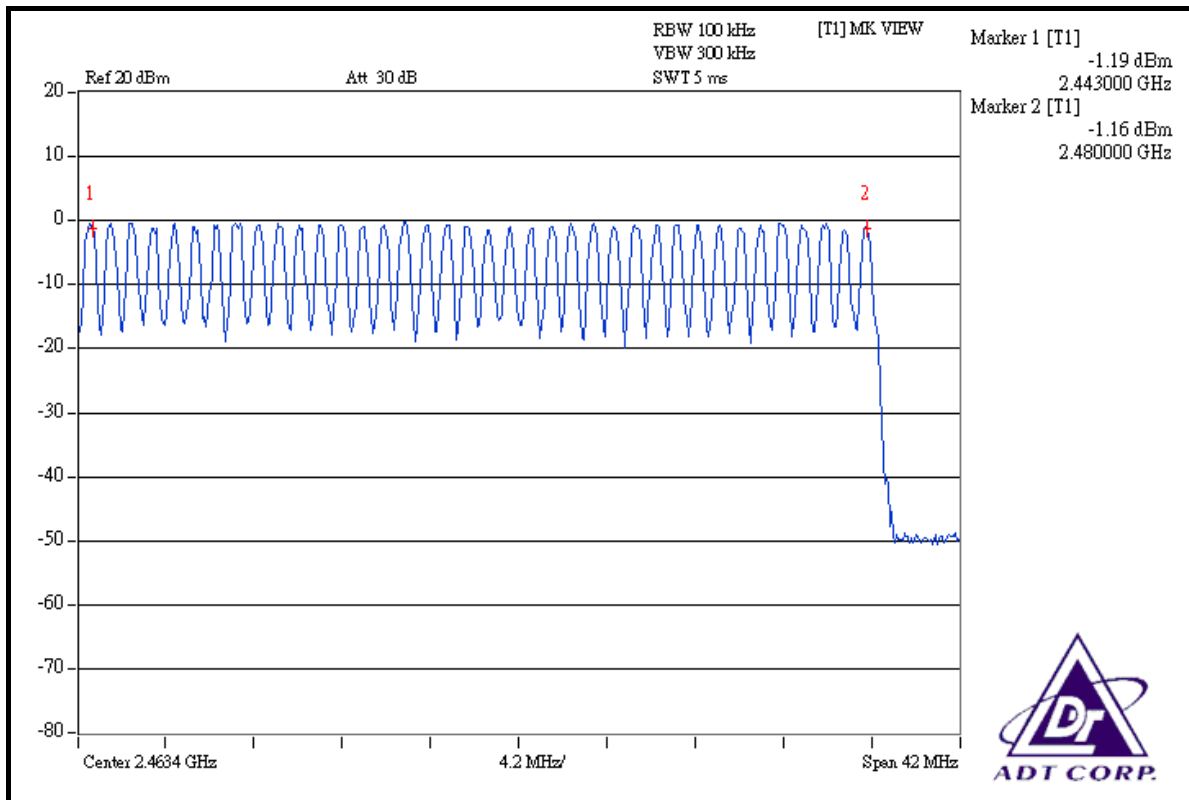
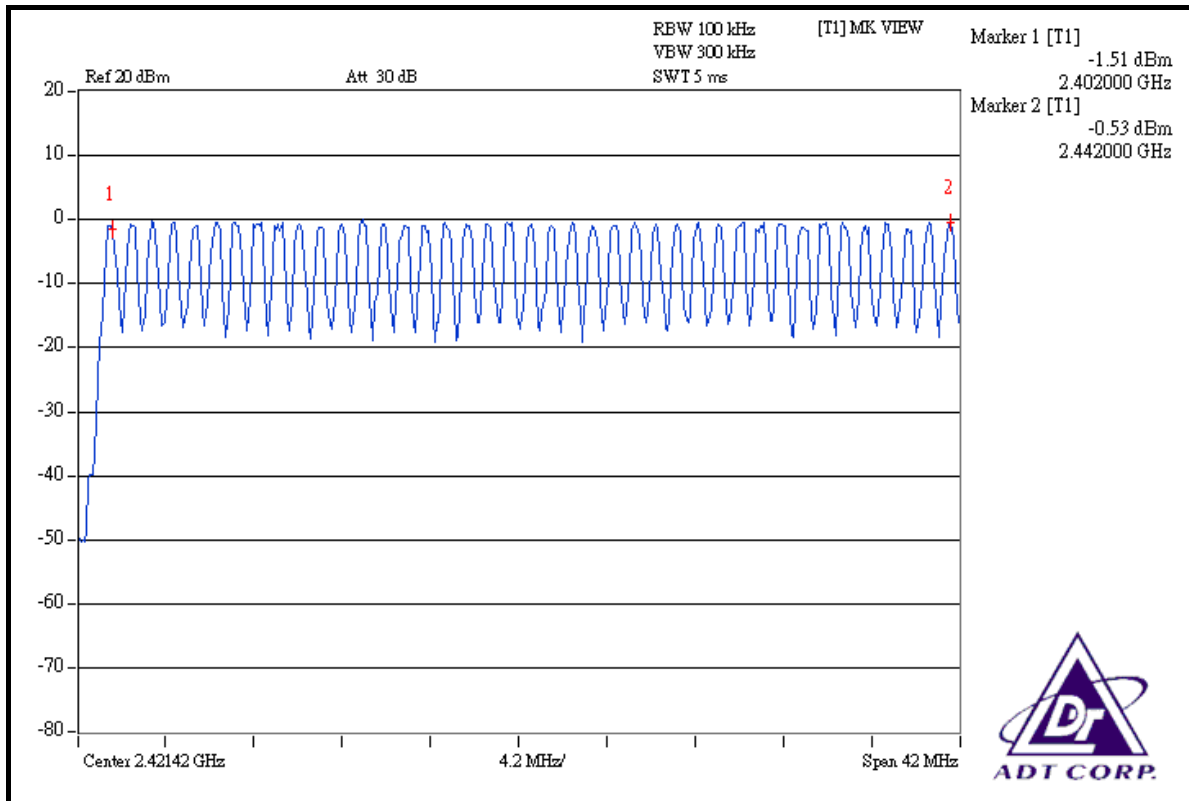

### 8DPSK MODULATION

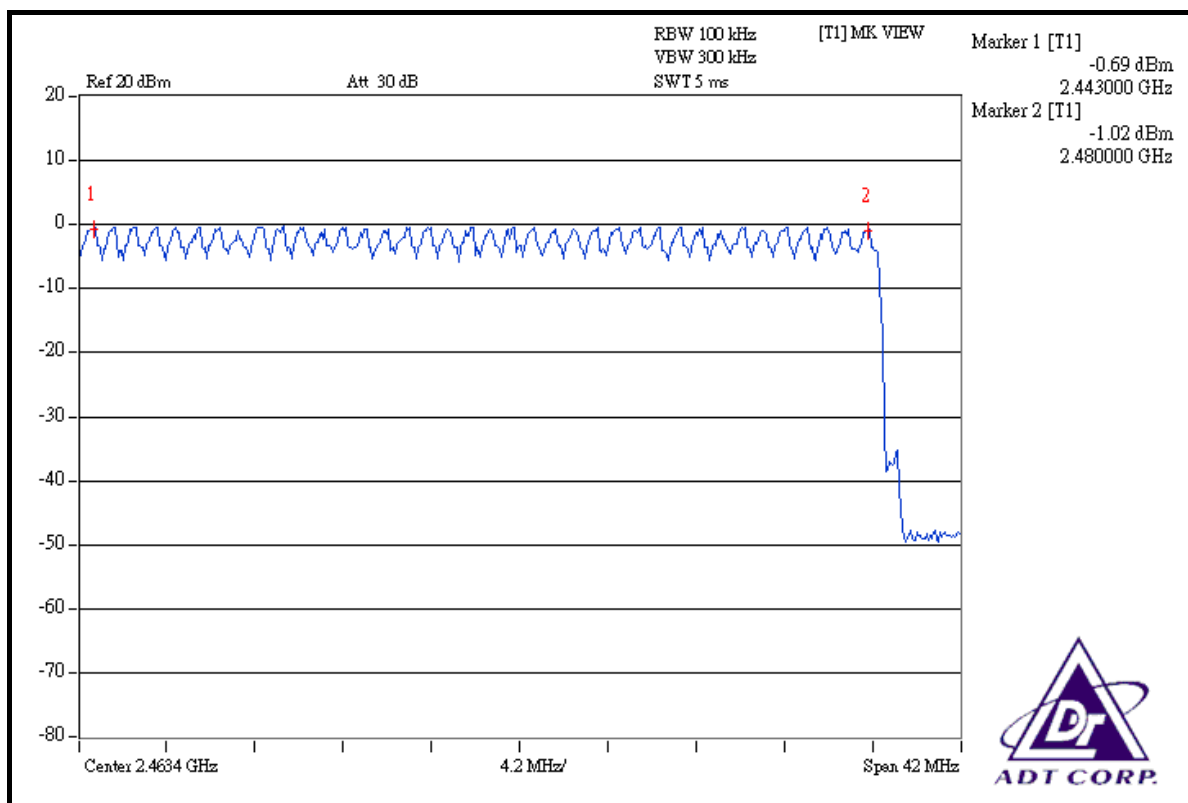
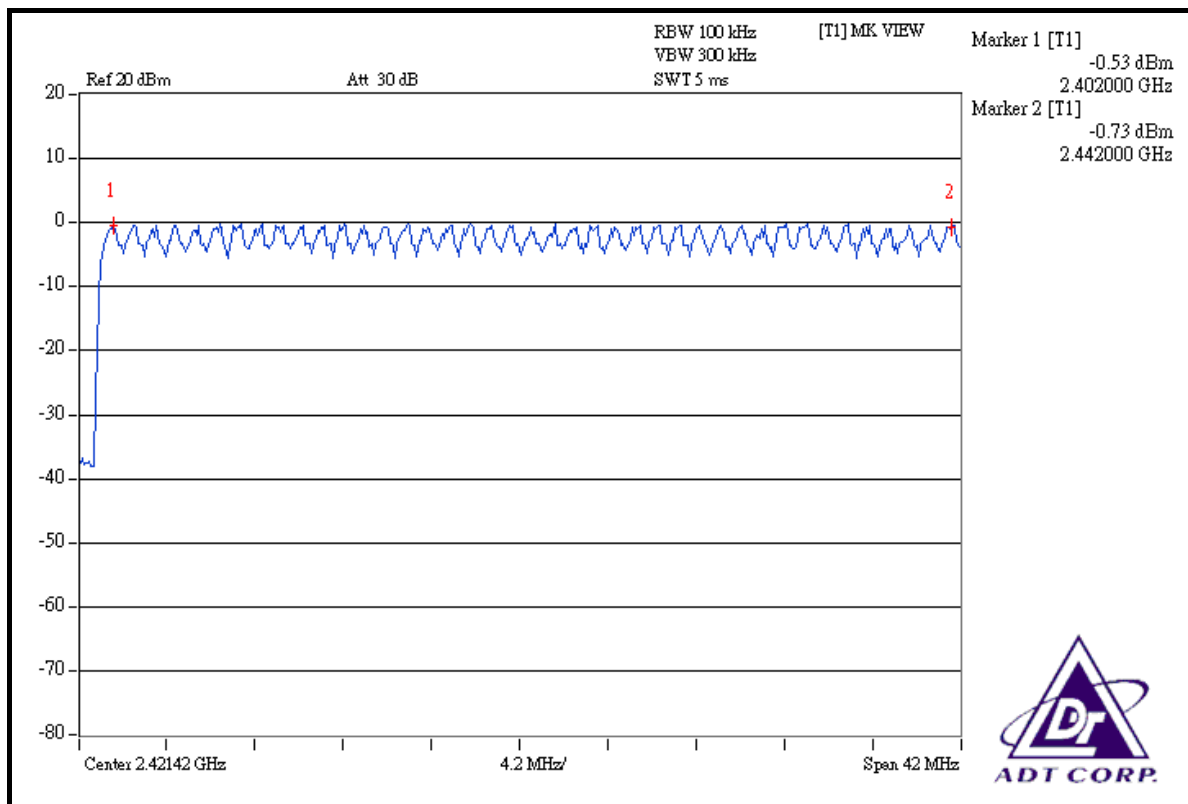



#### 4.4 DWELL TIME ON EACH CHANNEL

##### 4.4.1 LIMIT OF DWELL TIME USED

The average time of occupancy on any channel shall not be greater than 0.4 seconds within a period of 0.4 seconds multiplied by the number of hopping channels employed.

##### 4.4.2 TEST INSTRUMENTS

DESCRIPTION & MANUFACTURER	MODEL NO.	SERIAL NO.	CALIBRATED UNTIL
SPECTRUM ANALYZER	FSP40	100040	Jun. 28, 2008

**NOTES:** The calibration interval of the above test instruments is 12 months. And the calibrations are traceable to NML/ROC and NIST/USA.

##### 4.4.3 TEST PROCEDURES

- a. Check the calibration of the measuring instrument (SA) using either an internal calibrator or a known signal from an external generator.
- b. Turn on the EUT and connect its antenna terminal to measurement via a low loss cable. Then set it to any one measured frequency within its operating range and make sure the instrument is operated in its linear range.
- c. Adjust the center frequency of SA on any frequency be measured and set SA to zero span mode. And then, set RBW and VBW of spectrum analyzer to proper value.
- d. Measure the time duration of one transmission on the measured frequency. And then plot the result with time difference of this time duration.
- e. Repeat above procedures until all different time-slot modes have been completed.

##### 4.4.4 DEVIATION FROM TEST STANDARD

No deviation.

#### 4.4.5 TEST SETUP

Same as 4.3.5.

#### 4.4.6 TEST RESULTS

##### GFSK MODULATION

Mode	Number of transmission in a 31.6 (79Hopping*0.4)	Length of transmission time (msec)	Result (msec)	Limit (msec)
DH1	51 (times / 5 sec) * 6.32 = 322.32 times	0.486	156.648	400
DH3	27 (times / 5 sec) * 6.32 = 170.64 times	1.758	299.985	400
DH5	18 (times / 5 sec) * 6.32 = 113.76 times	2.950	335.592	400

**NOTE:** Test plots of the transmitting time slot are shown on next 3 pages.

DH1

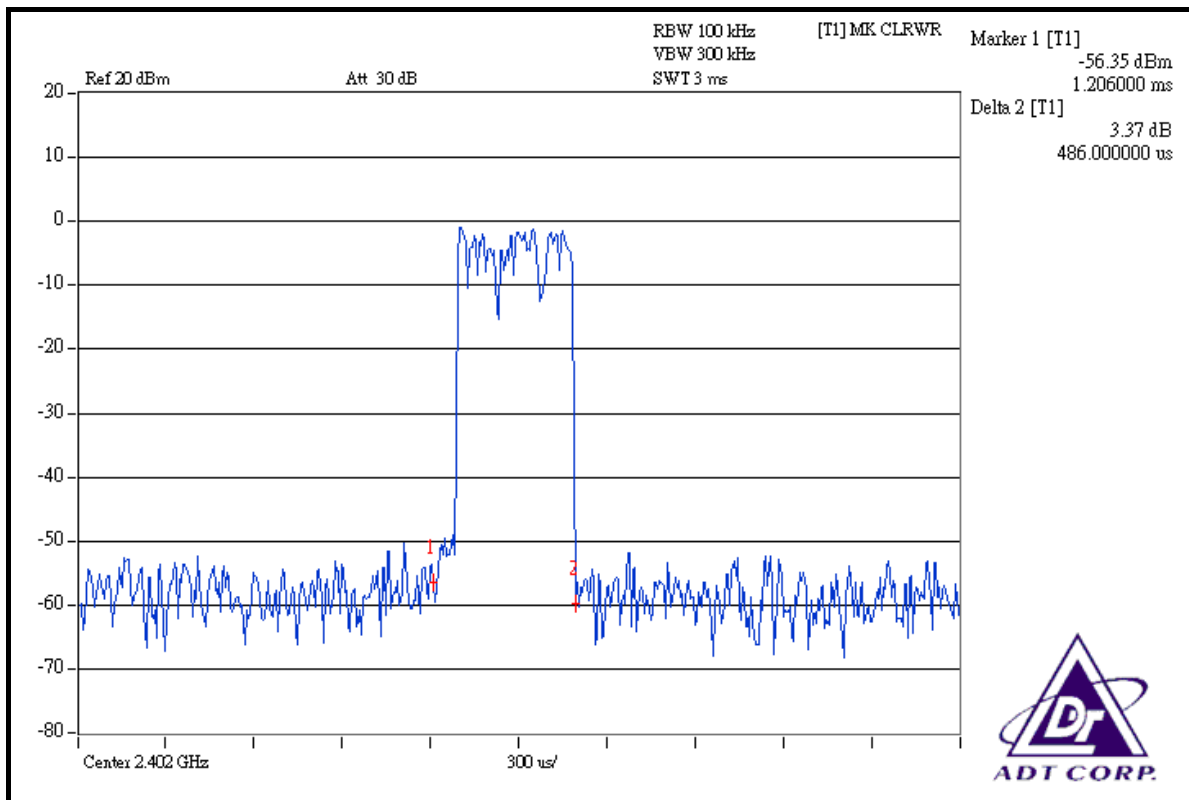
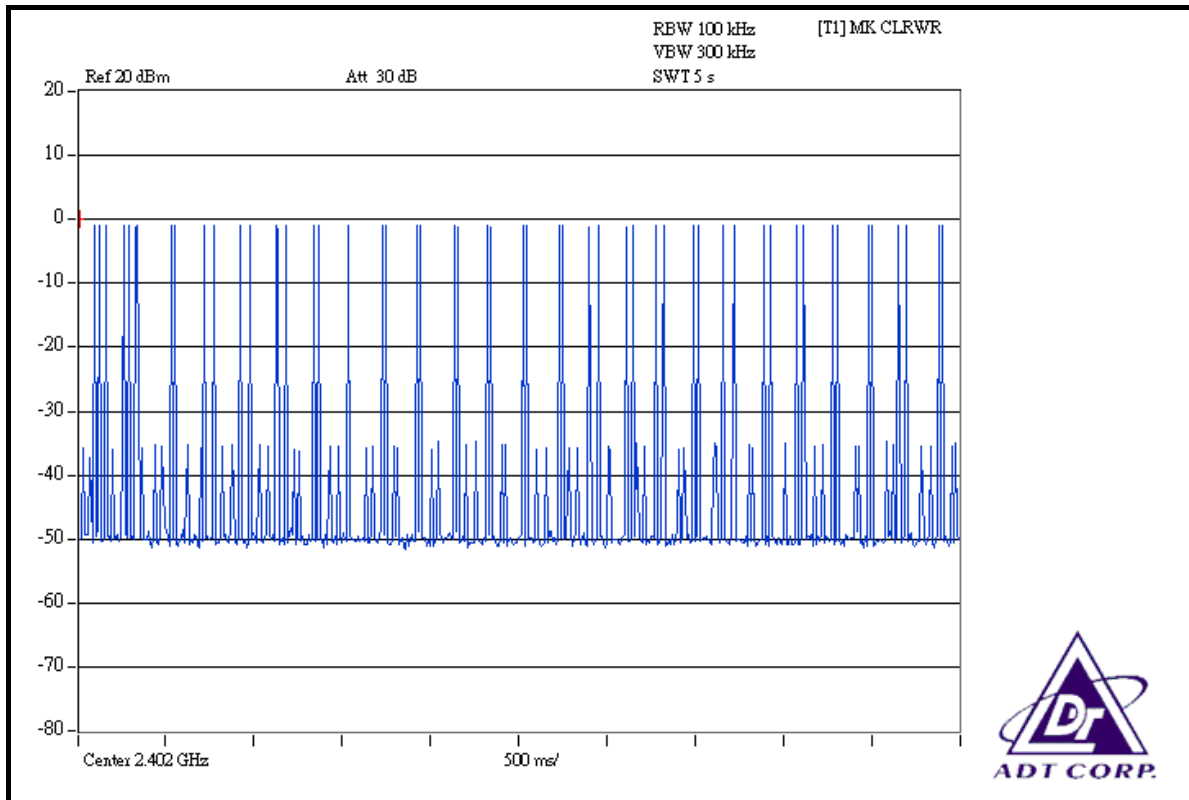

DH3

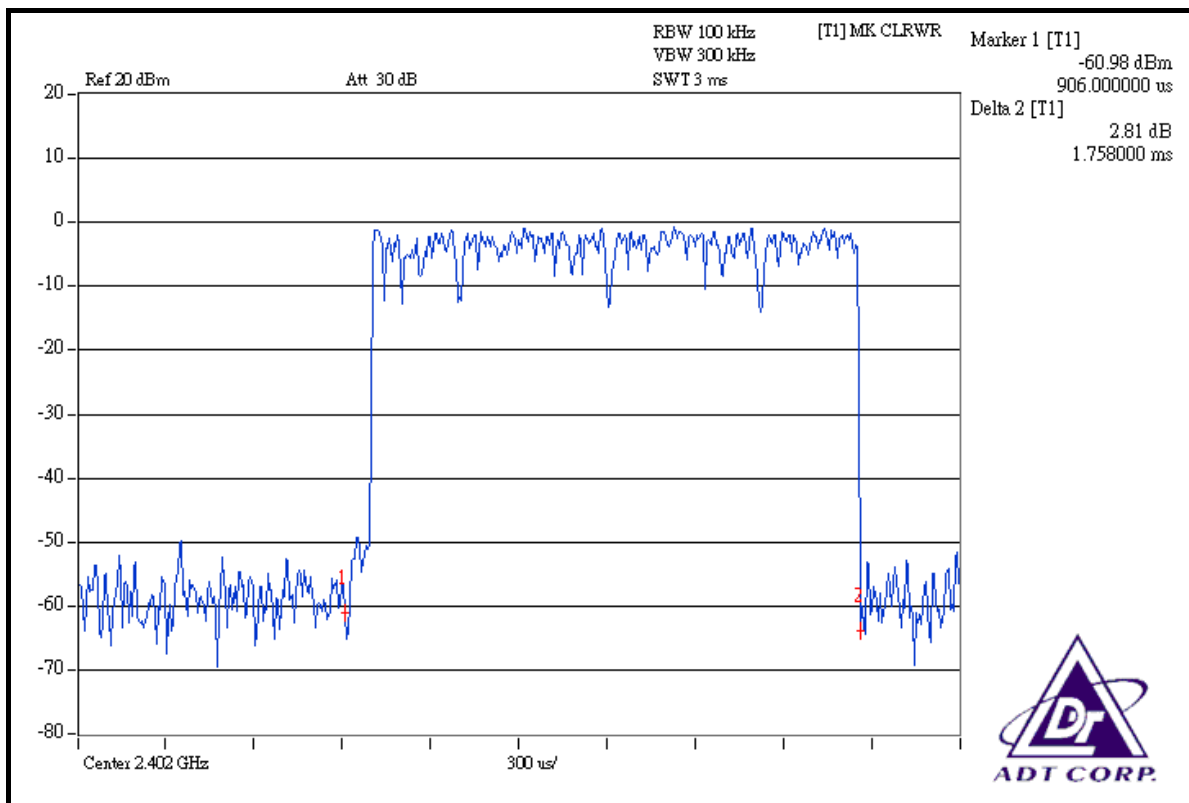
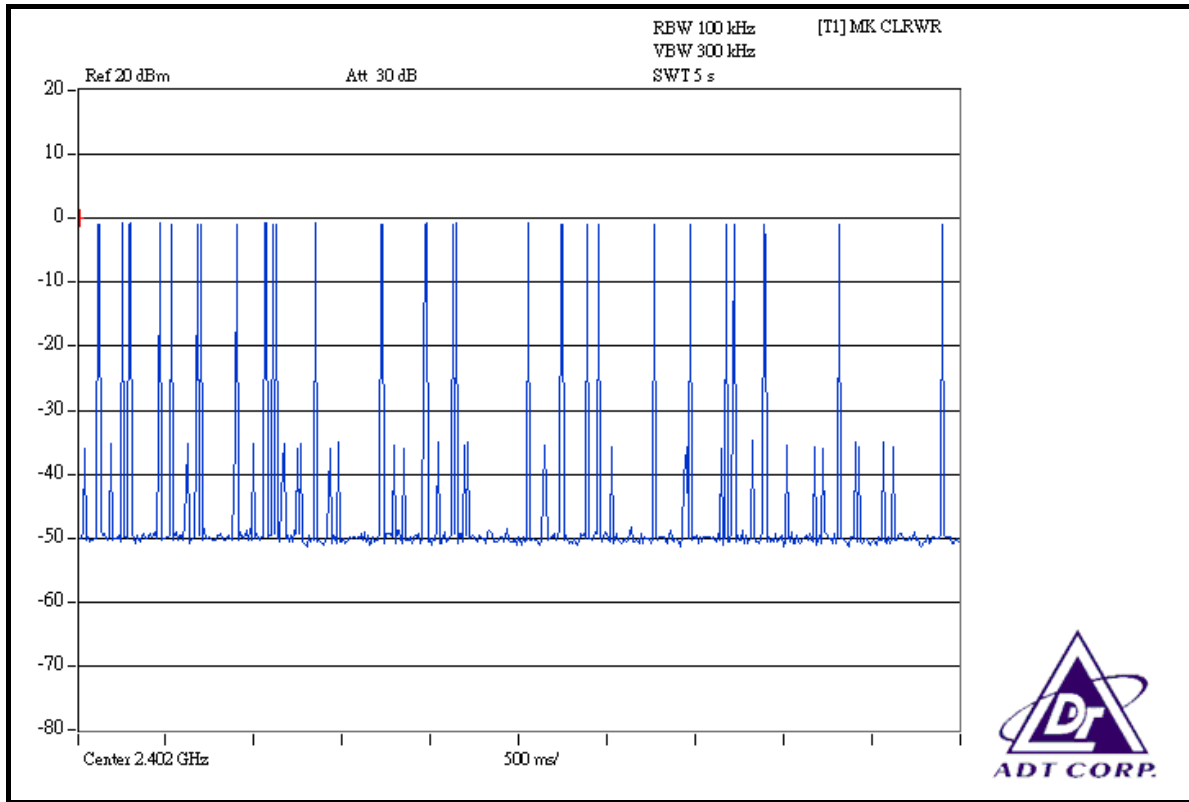



DH5

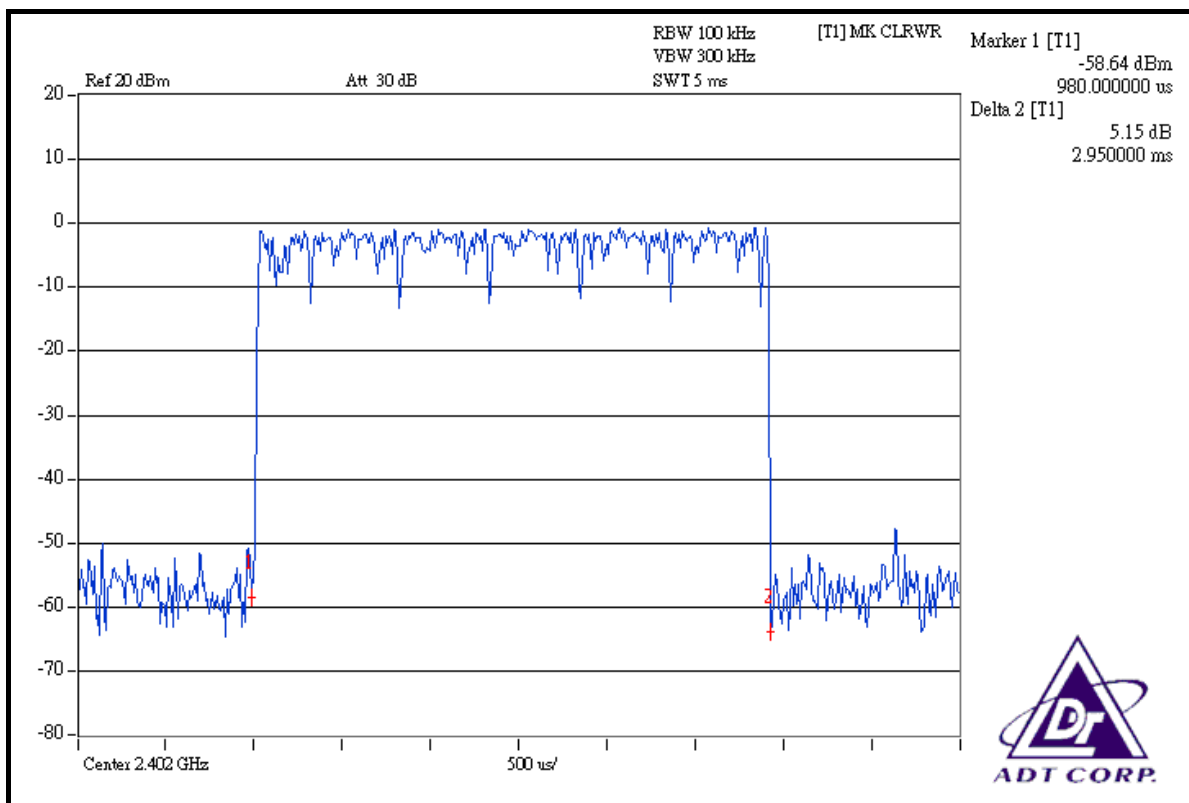
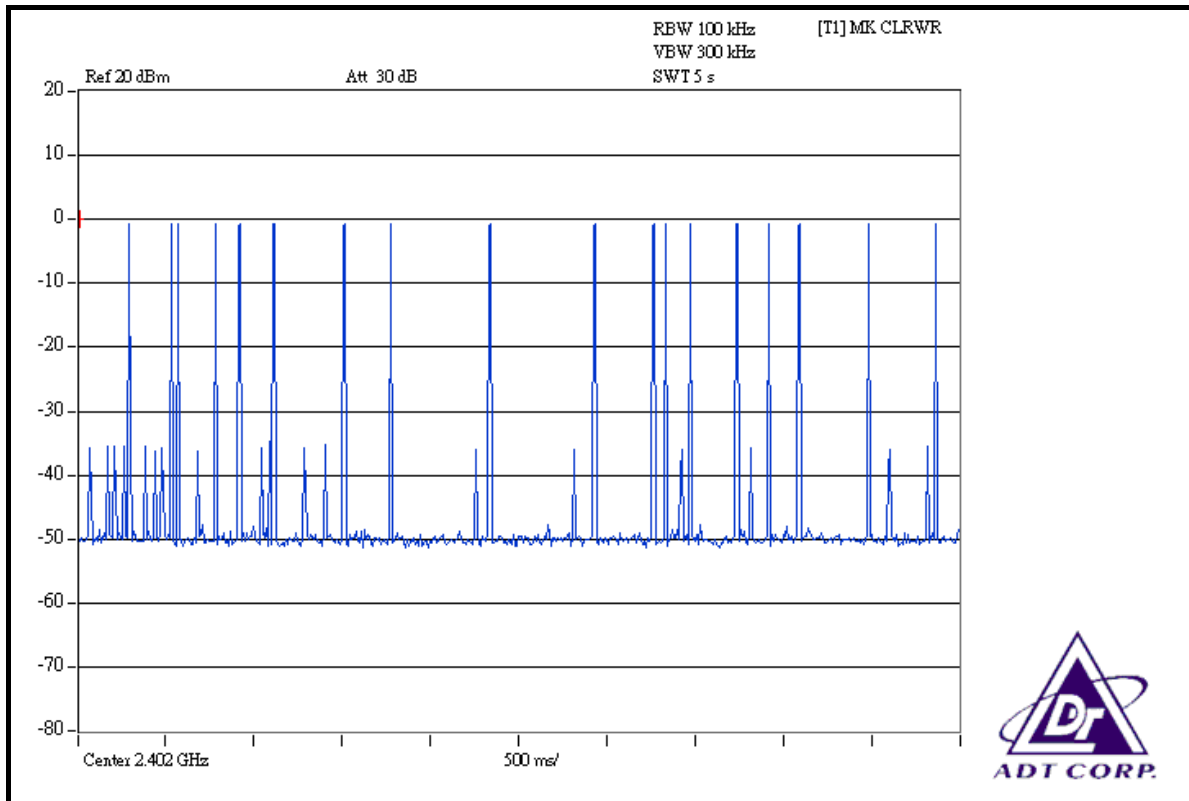

### 8DPSK MODULATION

Mode	Number of transmission in a 31.6 (79Hopping*0.4)	Length of transmission time (msec)	Result (msec)	Limit (msec)
DH1	50 (times / 5 sec) * 6.32 = 316.00 times	0.498	157.368	400
DH3	27 (times / 5 sec) * 6.32 = 170.64 times	1.758	299.985	400
DH5	17 (times / 5 sec) * 6.32 = 107.44 times	3.010	323.394	400

**NOTE:** Test plots of the transmitting time slot are shown on next 3 pages.

DH1

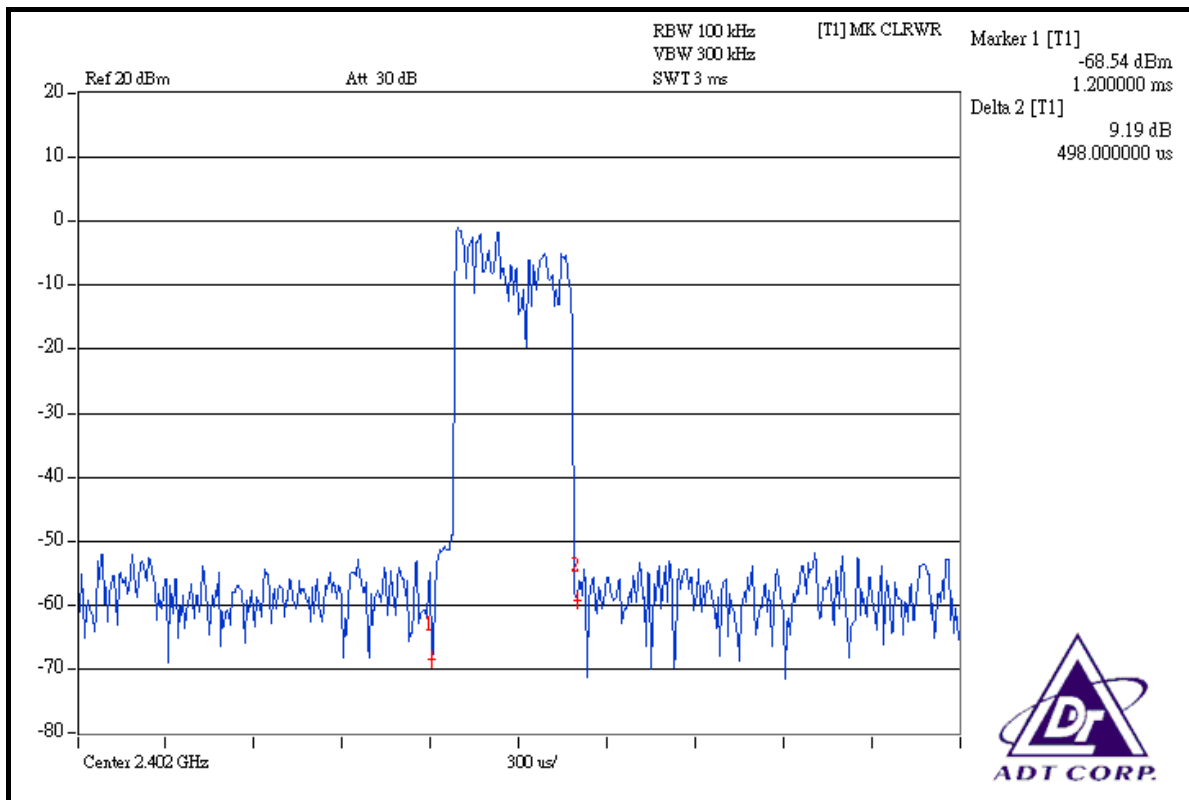
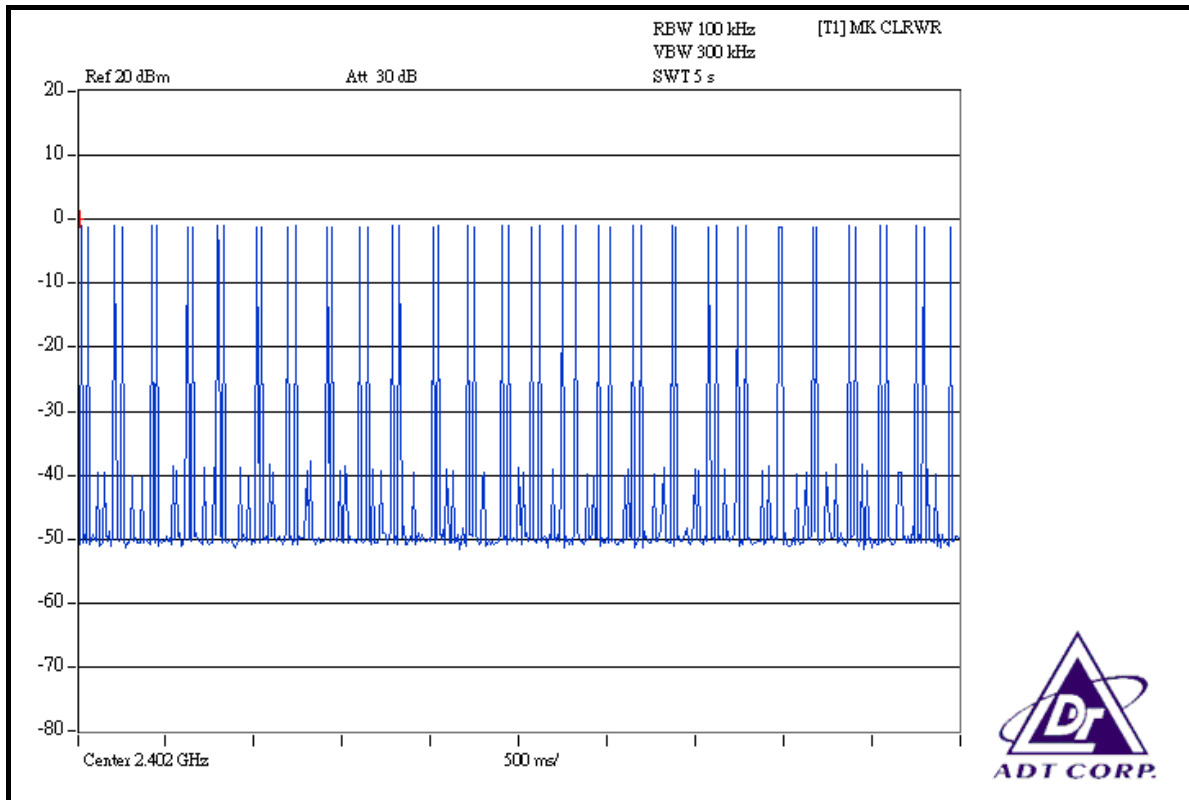

DH3

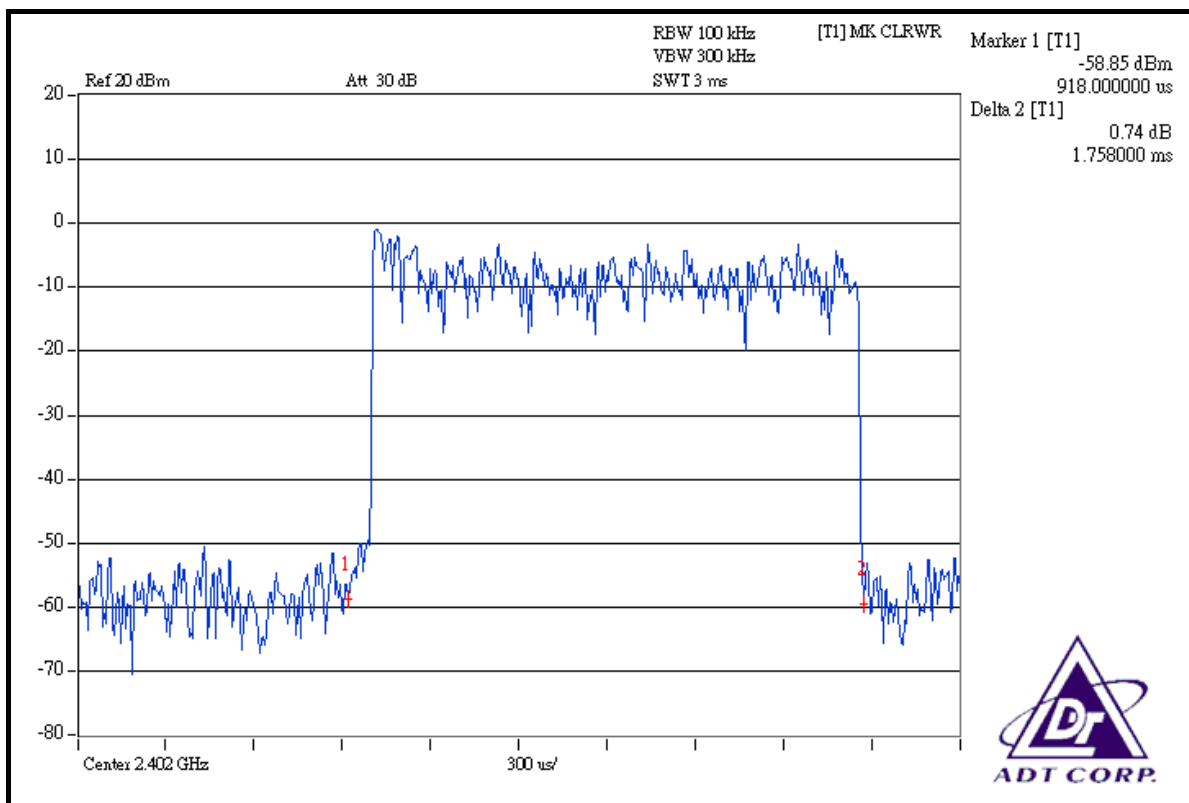
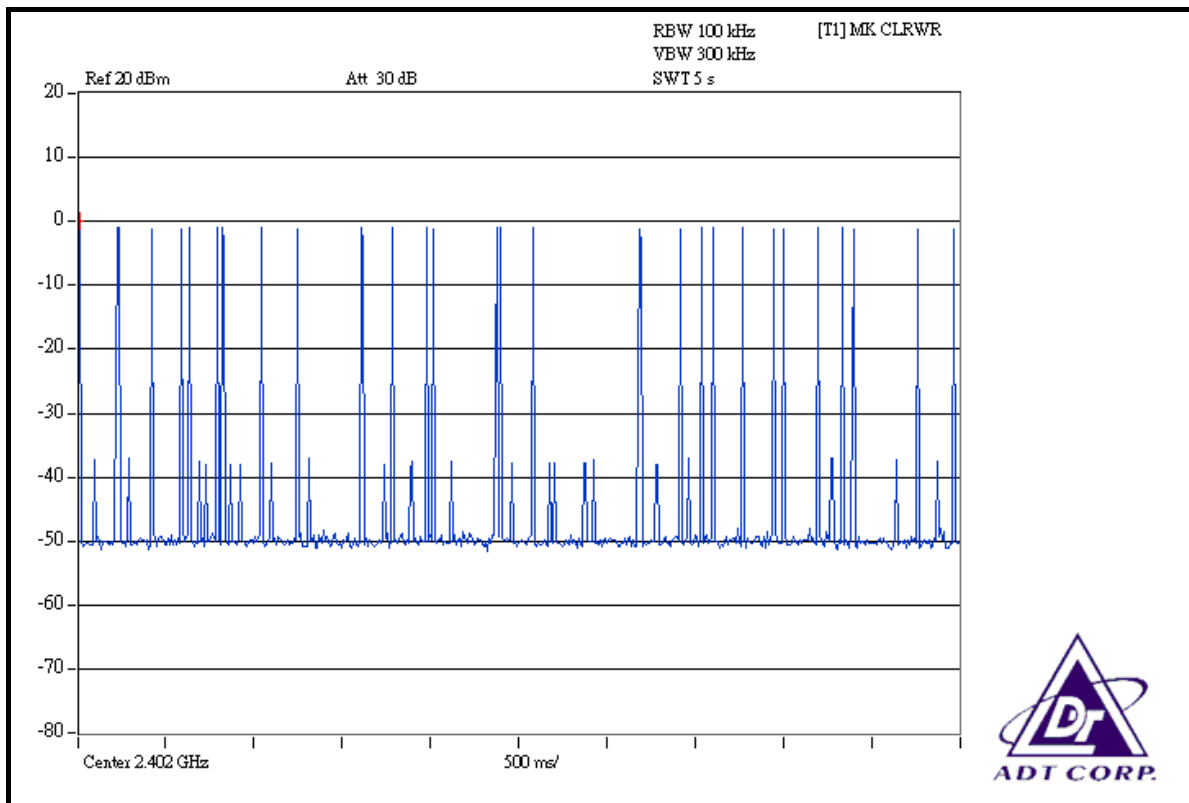

### DH5

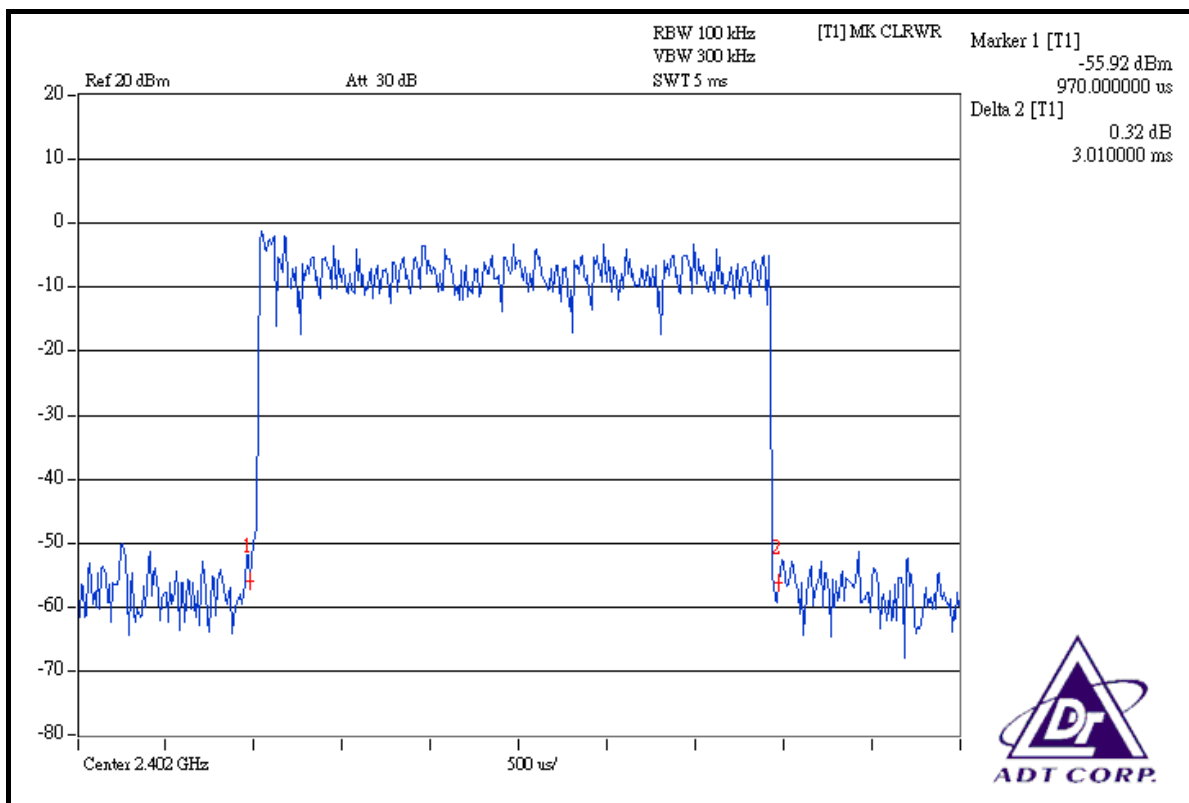
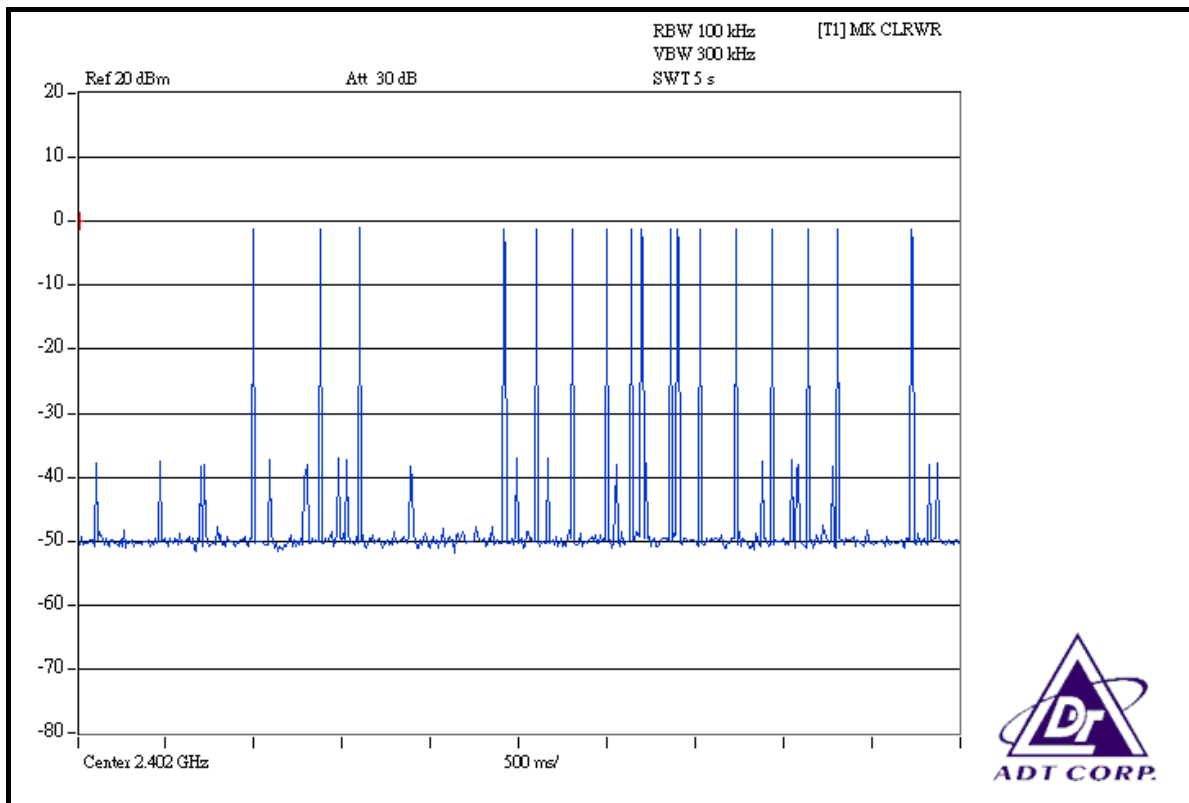



## 4.5 CHANNEL BANDWIDTH

### 4.5.1 LIMITS OF CHANNEL BANDWIDTH

For frequency hopping system operating in the 2400-2483.5MHz, If the 20dB bandwidth of hopping channel is greater than 25kHz, two-thirds 20dB bandwidth of hopping channel shall be a minimum limit for the hopping channel separation.

### 4.5.2 TEST INSTRUMENTS

DESCRIPTION & MANUFACTURER	MODEL NO.	SERIAL NO.	CALIBRATED UNTIL
SPECTRUM ANALYZER	FSP40	100040	Jun. 28, 2008

**NOTE:** The calibration interval of the above test instruments is 12 months. And the calibrations are traceable to NML/ROC and NIST/USA.

### 4.5.3 TEST PROCEDURE

- a. Check the calibration of the measuring instrument using either an internal calibrator or a known signal from an external generator.
- b. Turn on the EUT and connect it to measurement instrument. Then set it to any one convenient frequency within its operating range. Set a reference level on the measuring instrument equal to the highest peak value.
- c. Measure the frequency difference of two frequencies that were attenuated 20dB from the reference level. Record the frequency difference as the emission bandwidth.
- d. Repeat above procedures until all frequencies measured were complete.

### 4.5.4 DEVIATION FROM TEST STANDARD

No deviation.

#### 4.5.5 TEST SETUP

Same as 4.3.5.

#### 4.5.6 EUT OPERATING CONDITION

The software provided by client enabled the EUT to transmit and receive data at lowest, middle and highest channel frequencies individually.

#### 4.5.7 TEST RESULTS

##### GFSK MODULATION

<b>MODULATION TYPE</b>	GFSK	<b>ENVIRONMENTAL CONDITIONS</b>	25deg. C, 65%RH, 1022hPa
<b>INPUT POWER (SYSTEM)</b>	120Vac, 60 Hz	<b>TESTED BY</b>	March Tsui

<b>CHANNEL</b>	<b>CHANNEL FREQUENCY (MHz)</b>	<b>20dB BANDWIDTH (MHz)</b>
0	2402	0.968
39	2441	1.010
78	2480	1.020

### CH 0

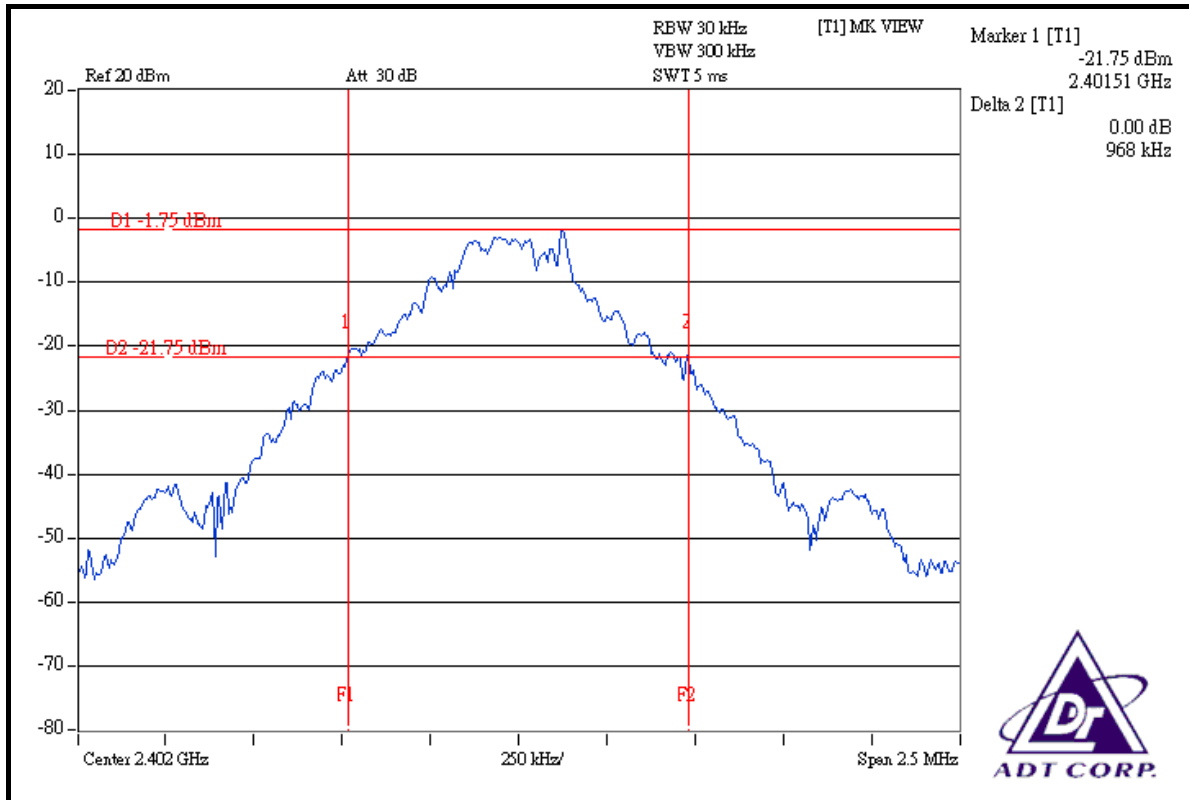

### CH 39

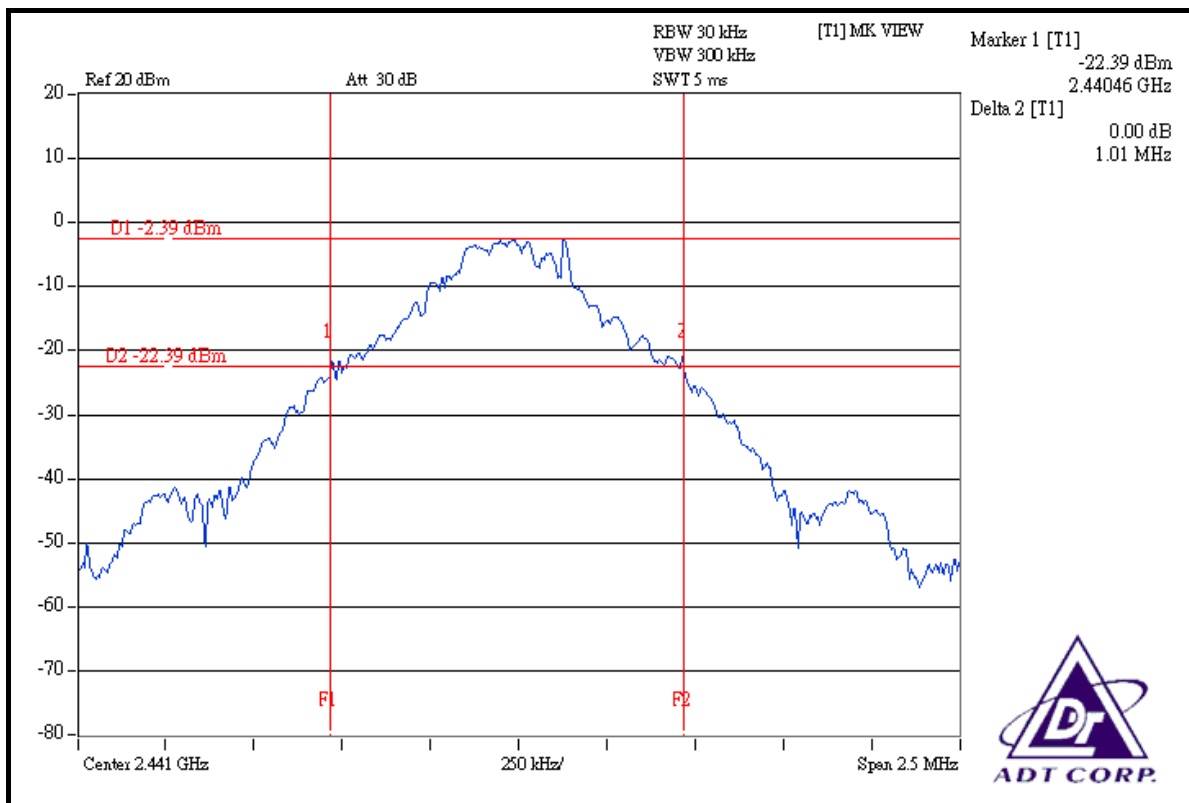



**CH 78**

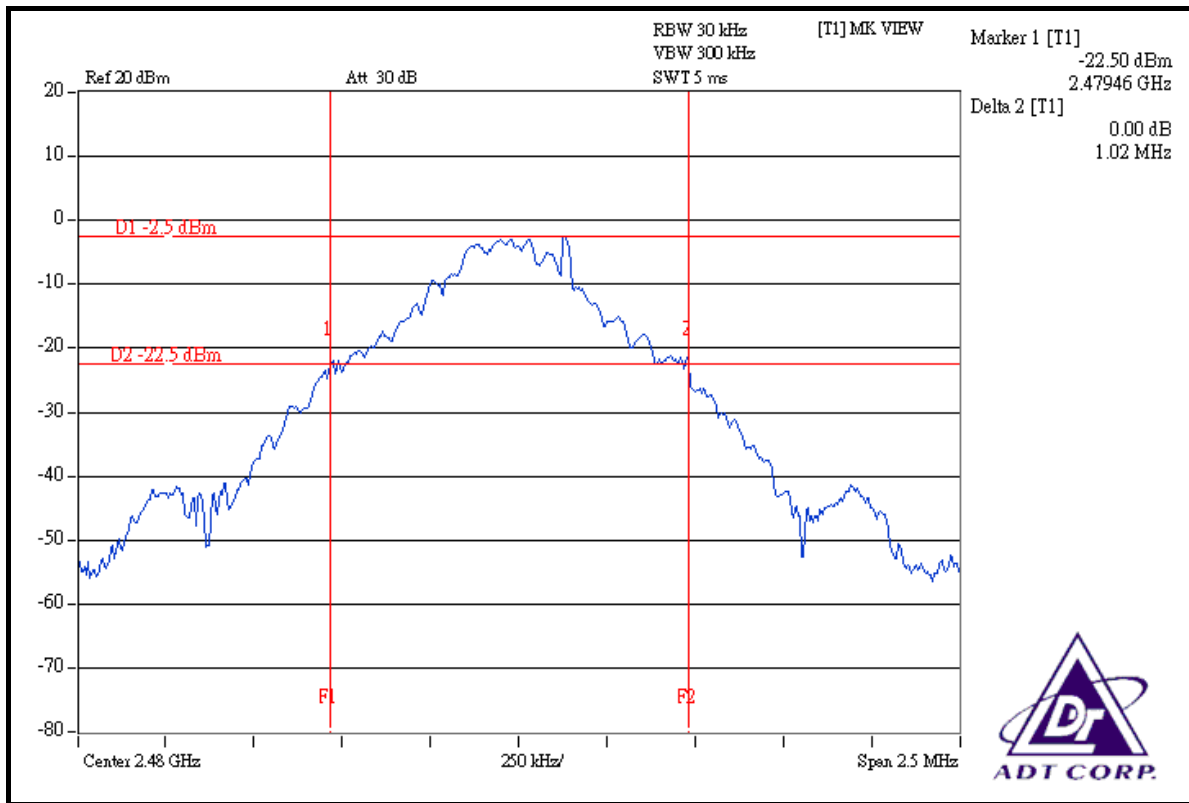

### 8DPSK MODULATION

<b>MODULATION TYPE</b>	8DPSK	<b>ENVIRONMENTAL CONDITIONS</b>	25deg. C, 65%RH, 1022hPa
<b>INPUT POWER (SYSTEM)</b>	120Vac, 60 Hz	<b>TESTED BY</b>	March Tsui

CHANNEL	CHANNEL FREQUENCY (MHz)	20dB BANDWIDTH (MHz)
0	2402	1.310
39	2441	1.300
78	2480	1.310

### CH 0

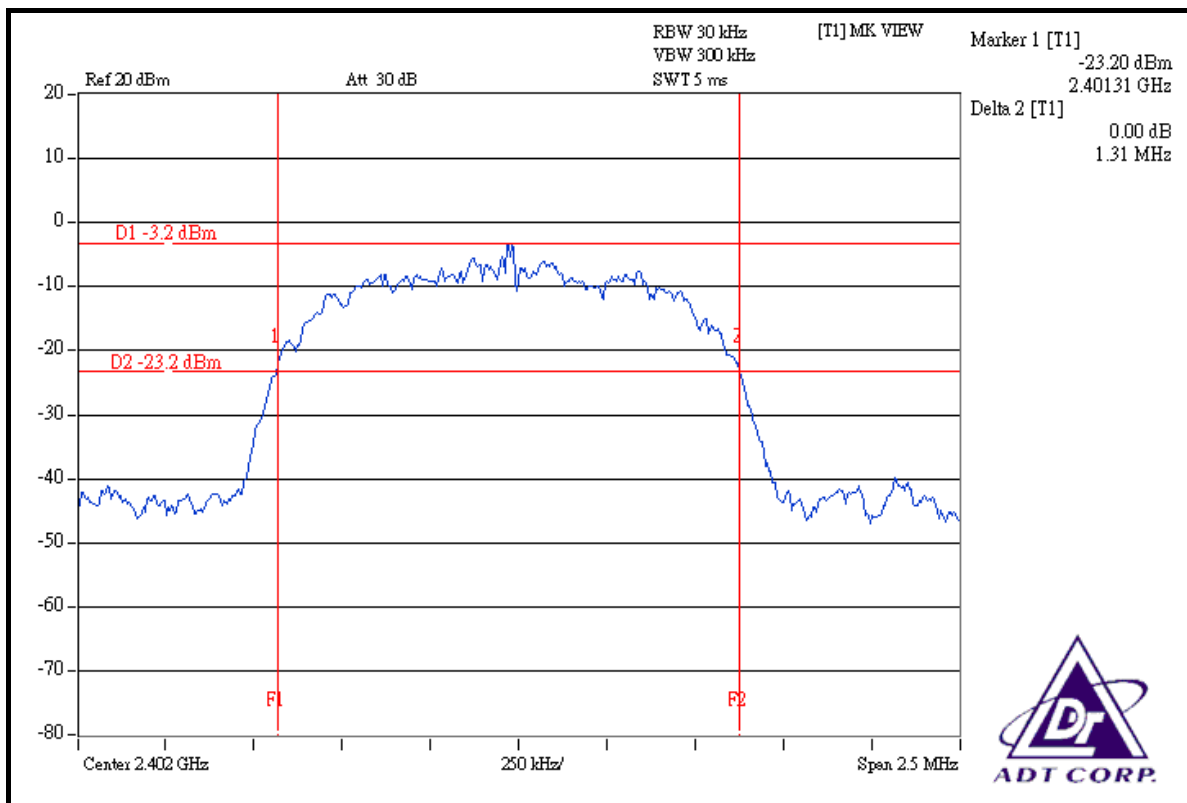

### CH 39

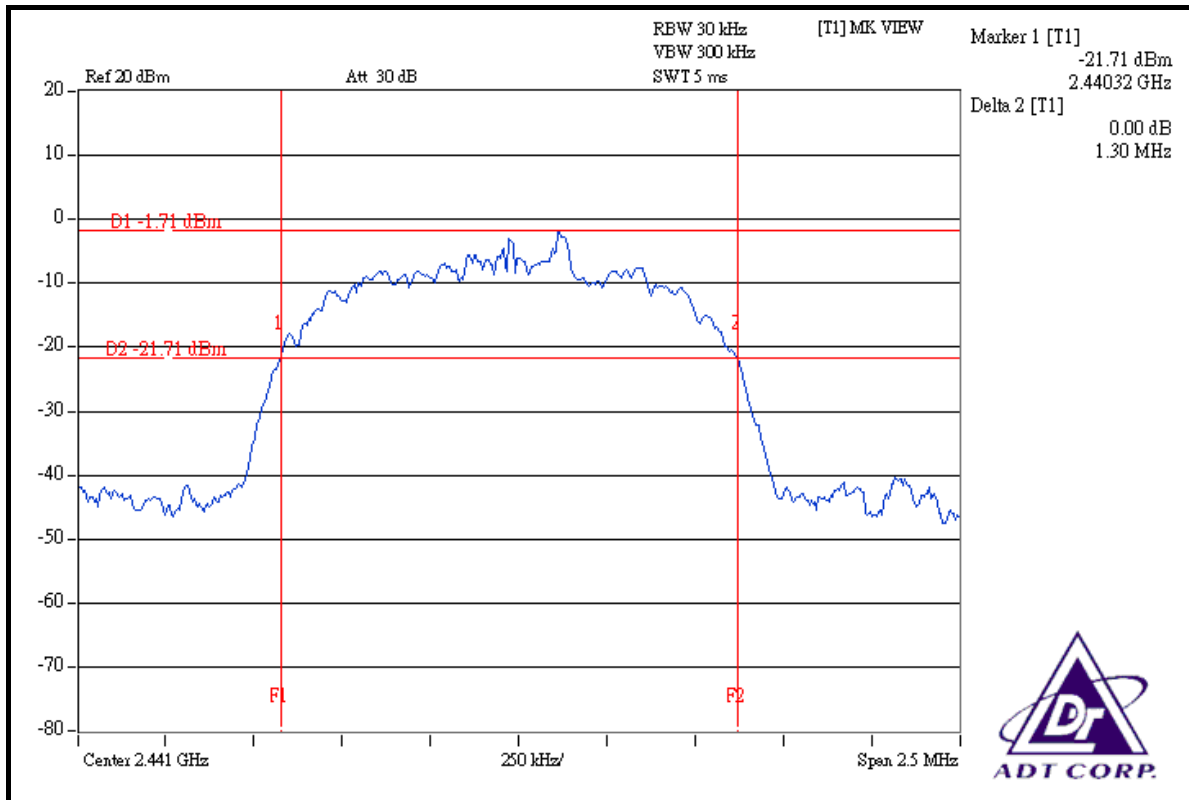

### CH 78

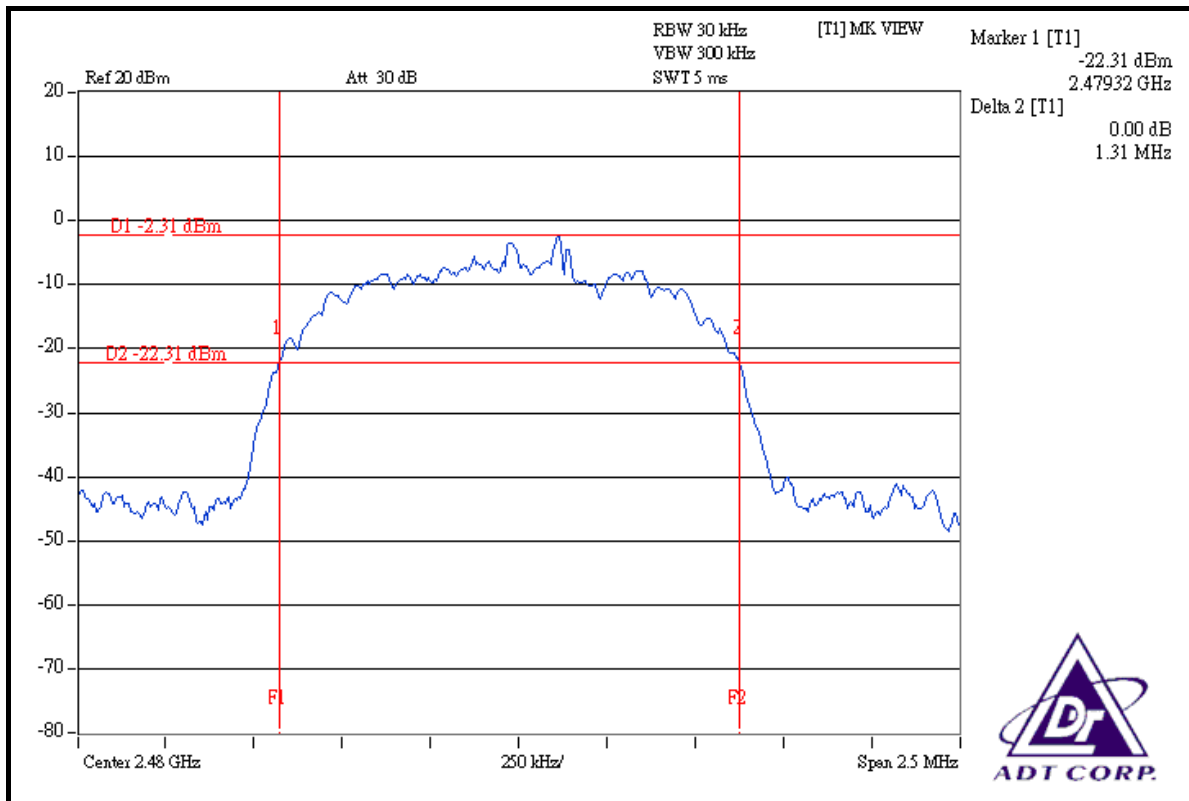



## 4.6 HOPPING CHANNEL SEPARATION

### 4.6.1 LIMIT OF HOPPING CHANNEL SEPARATION

At least 25kHz or two-third of 20dB hopping channel bandwidth (whichever is greater).

### 4.6.2 TEST INSTRUMENTS

DESCRIPTION & MANUFACTURER	MODEL NO.	SERIAL NO.	CALIBRATED UNTIL
SPECTRUM ANALYZER	FSP40	100040	Jun. 28, 2008

**NOTES:** The calibration interval of the above test instruments is 12 months. And the calibrations are traceable to NML/ROC and NIST/USA.

### 4.6.3 TEST PROCEDURES

1. Check the calibration of the measuring instrument using either an internal calibrator or a known signal from an external generator.
2. Turn on the EUT and connect it to measurement instrument. Then set it to any one convenient frequency within its operating range.
3. By using the MaxHold function record the separation of two adjacent channels.
4. Measure the frequency difference of these two adjacent channels by SA MARK function. And then plot the result on SA screen.
5. Repeat above procedures until all frequencies measured were complete.

### 4.6.4 DEVIATION FROM TEST STANDARD

No deviation.

### 4.6.5 TEST SETUP

Same as 4.3.5



### CH 39

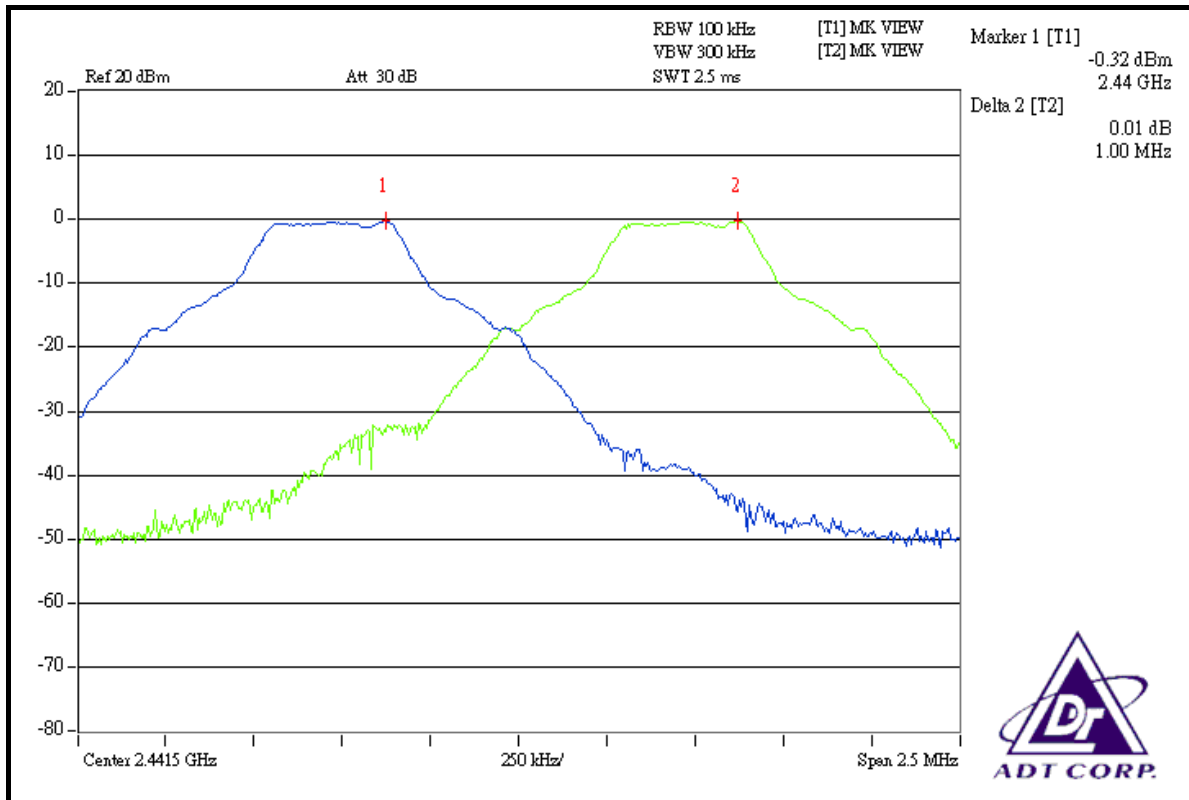

### CH 78

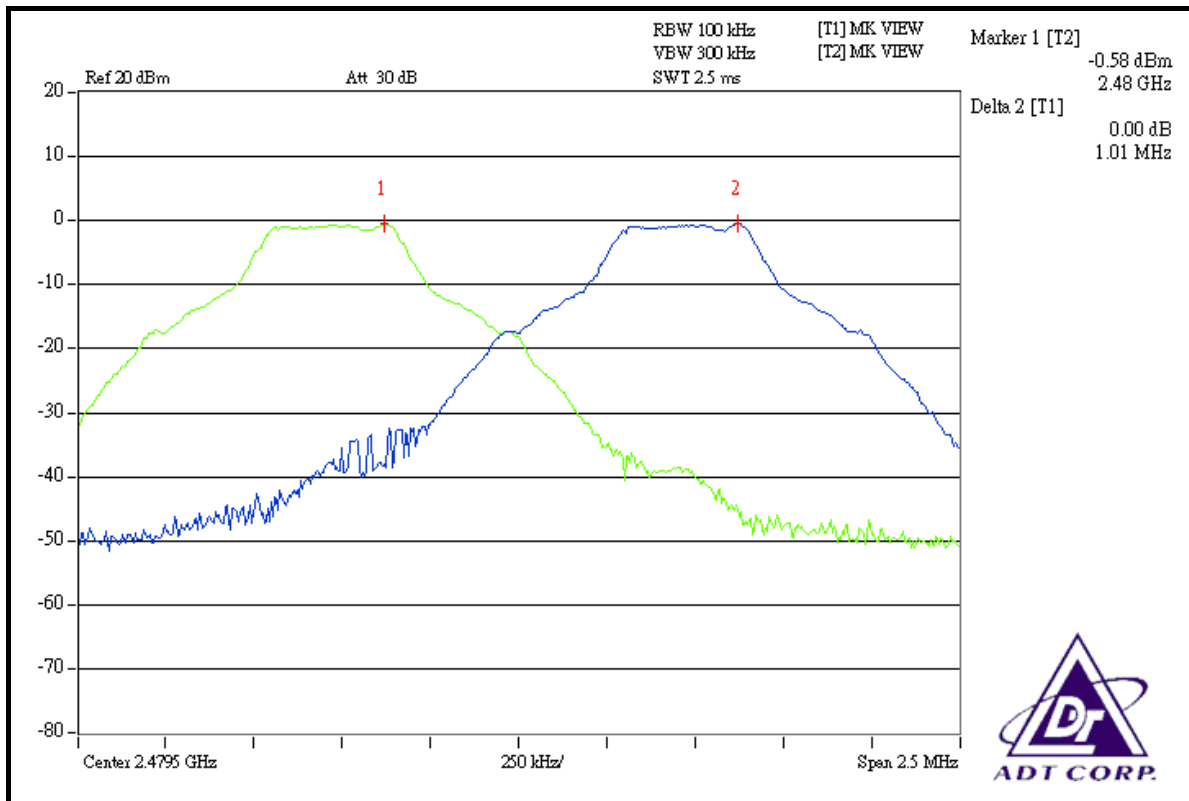



**8DPSK MODULATION**

<b>MODULATION TYPE</b>	8DPSK	<b>ENVIRONMENTAL CONDITIONS</b>	25deg. C, 65%RH, 1022hPa
<b>INPUT POWER (SYSTEM)</b>	120Vac, 60 Hz	<b>TESTED BY</b>	March Tsui

CHANNEL	FREQUENCY (MHz)	ADJACENT CHANNEL SEPARATION (MHz)	20dB BANDWIDTH (MHz)	MINIMUM LIMIT (MHz)	PASS / FAIL
0	2402	1.000	1.310	0.873	PASS
39	2441	1.010	1.300	0.867	PASS
78	2480	1.010	1.310	0.873	PASS

**NOTE:** The minimum limit is two-third 20dB bandwidth. Test results please refer to next two pages.

**CH 0**

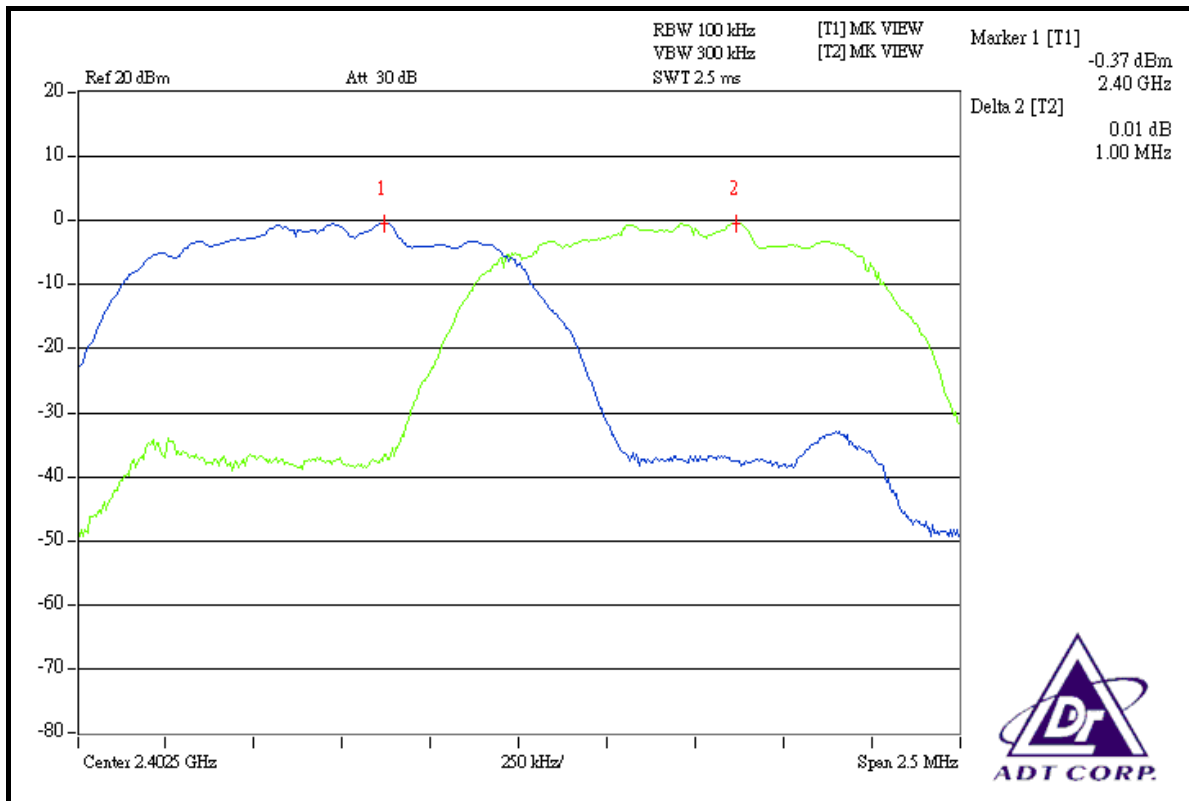



### CH 39

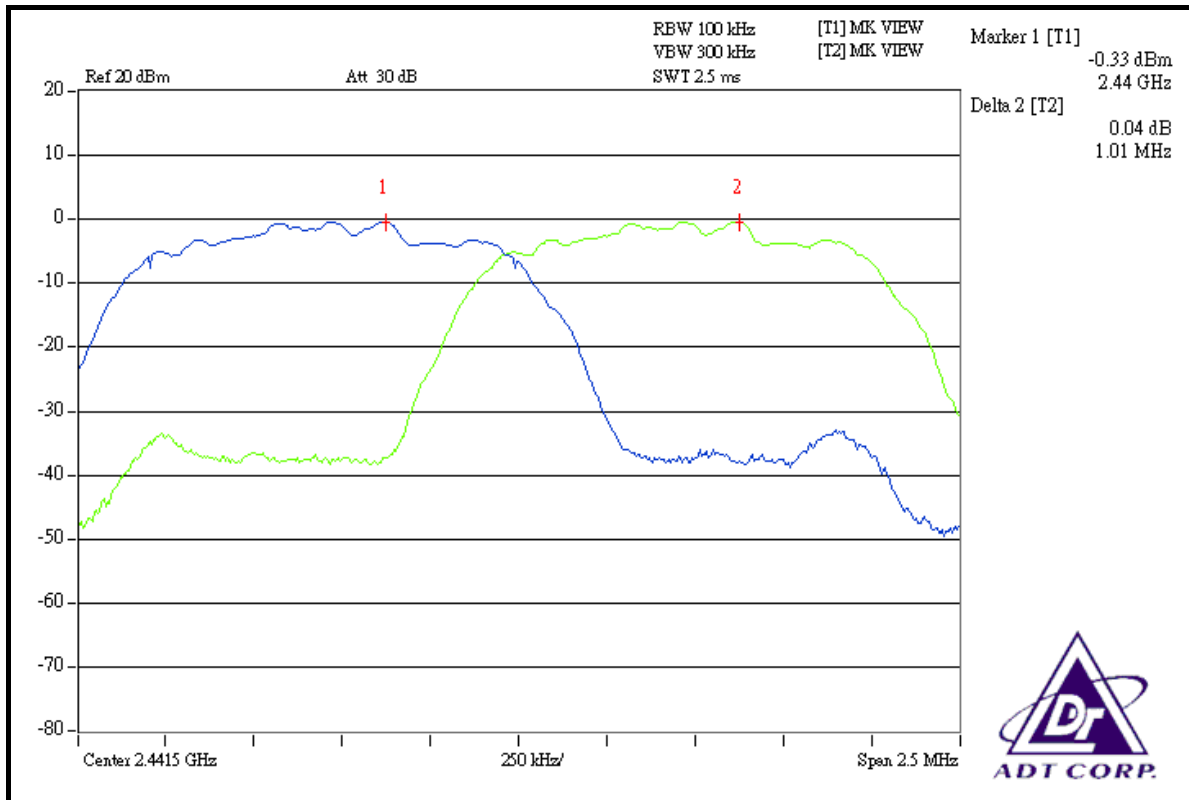

### CH 78

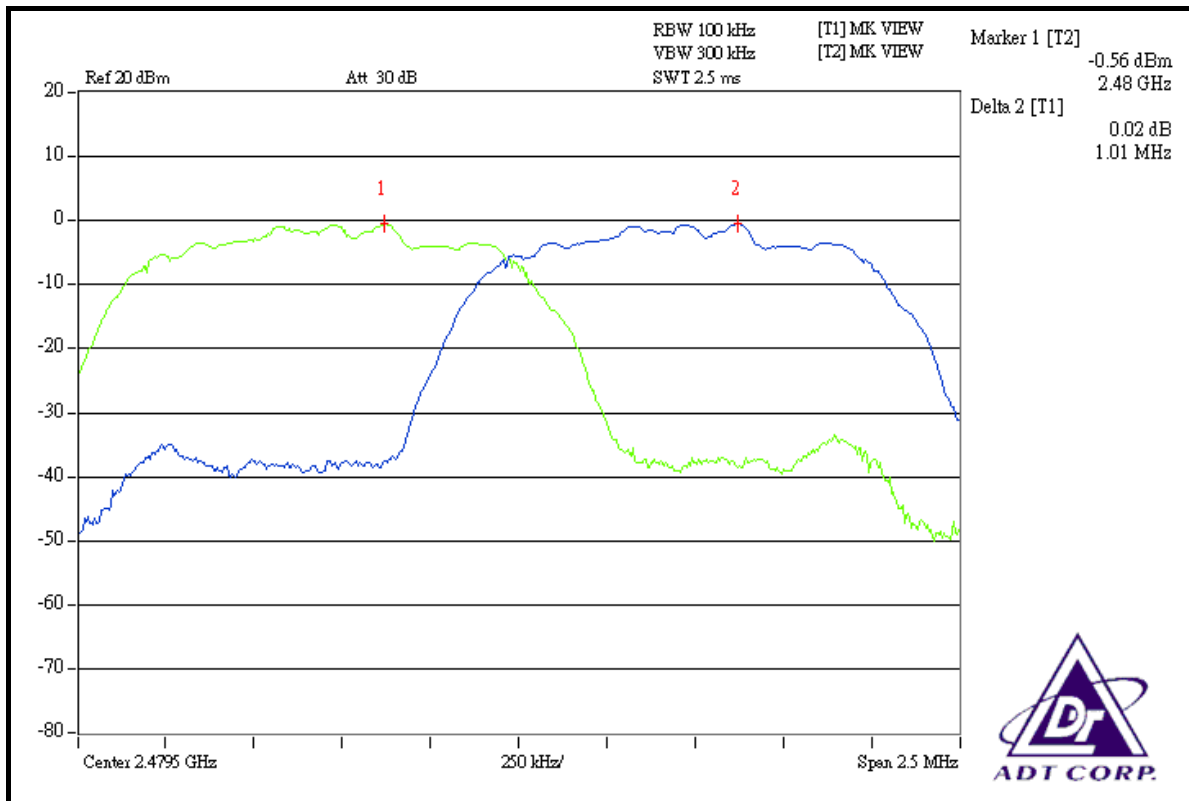





## 4.7 MAXIMUM PEAK OUTPUT POWER

### 4.7.1 LIMITS OF MAXIMUM PEAK OUTPUT POWER MEASUREMENT

The Maximum Peak Output Power Measurement is 125mW.

### 4.7.2 TEST INSTRUMENTS

DESCRIPTION & MANUFACTURER	MODEL NO.	SERIAL NO.	CALIBRATED UNTIL
SPECTRUM ANALYZER	FSP40	100040	Jun. 28, 2008

**NOTE:** The calibration interval of the above test instruments is 12 months and the calibrations are traceable to NML/ROC and NIST/USA.

### 4.7.3 TEST PROCEDURES

- a. Check the calibration of the measuring instrument using either an internal calibrator or a known signal from an external generator.
- b. Turn on the EUT and connect it to measurement instrument. Then set it to any one convenient frequency within its operating range. Set a reference level on the measuring instrument equal to the highest peak value.
- c. The center frequency of the spectrum analyzer is set to the fundamental frequency and using 3MHz RBW and 10 MHz VBW.
- d. Measure the captured power within the band and recording the plot.
- e. Repeat above procedures until all frequencies required were complete.

### 4.7.4 DEVIATION FROM TEST STANDARD

No deviation



#### 4.7.5 TEST SETUP

Same as 4.3.5.

#### 4.7.6 EUT OPERATING CONDITION

The software provided by client enabled the EUT to transmit and receive data at lowest, middle and highest channel frequencies individually.

#### 4.7.7 TEST RESULTS

##### GFSK MODULATION

<b>MODULATION TYPE</b>	GFSK	<b>ENVIRONMENTAL CONDITIONS</b>	25deg. C, 65%RH, 1022hPa
<b>INPUT POWER (SYSTEM)</b>	120Vac, 60 Hz	<b>TESTED BY</b>	March Tsui

CHANNEL	CHANNEL FREQUENCY (MHz)	PEAK POWER OUTPUT (mW)	PEAK POWER OUTPUT (dBm)	PEAK POWER LIMIT (mW)	PASS/FAIL
0	2402	1.099	0.41	125	PASS
39	2441	1.107	0.44	125	PASS
78	2480	1.052	0.22	125	PASS



### CH 0

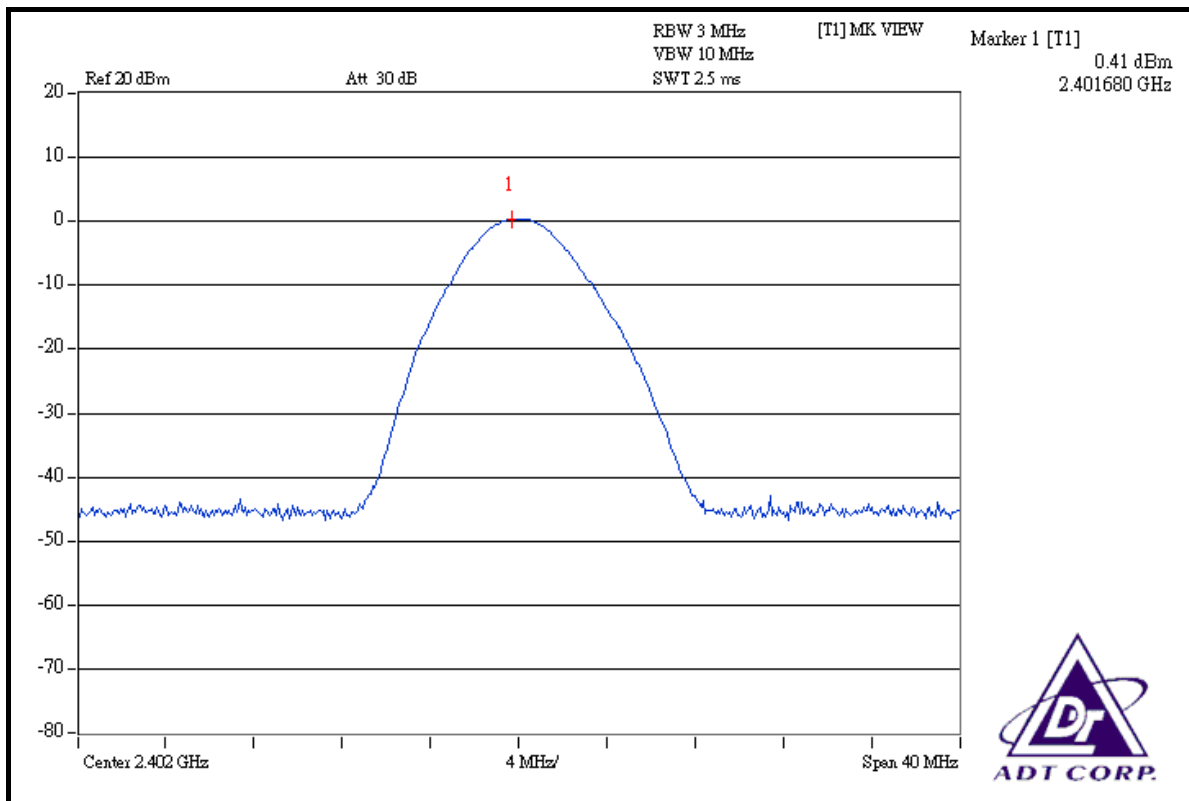

### CH 39

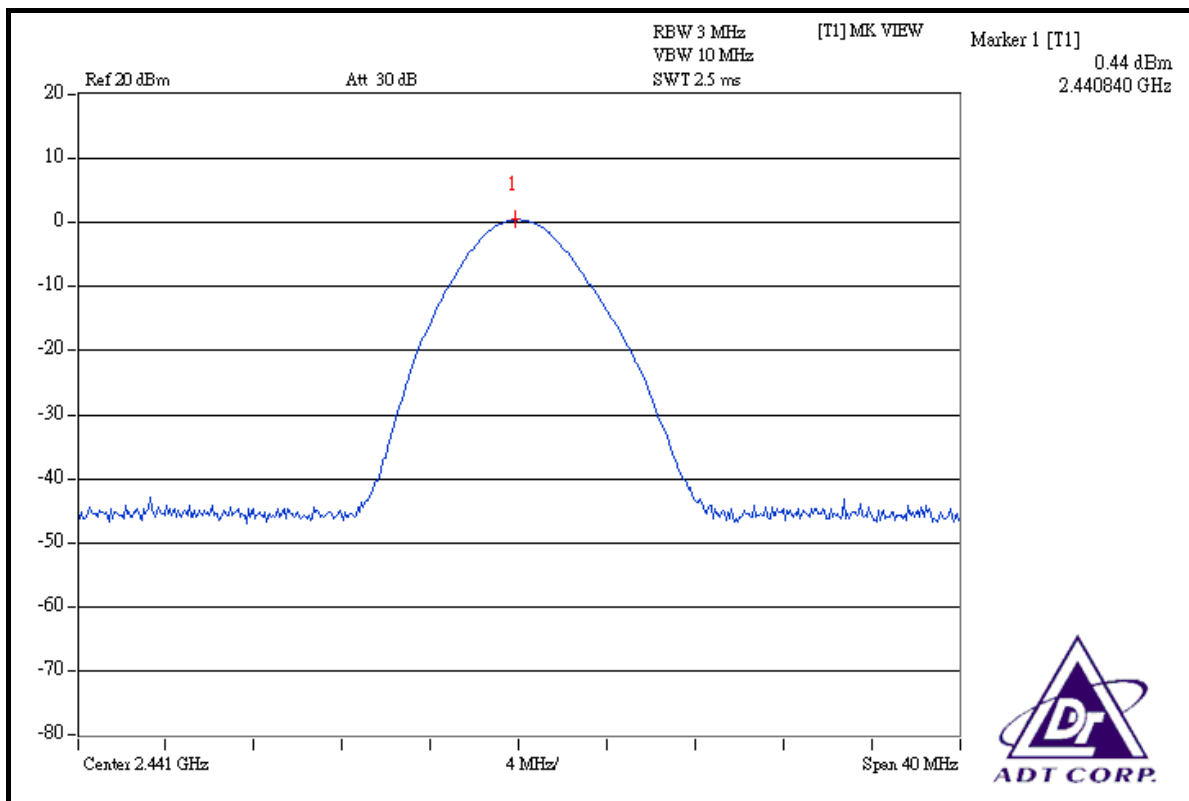

CH 78

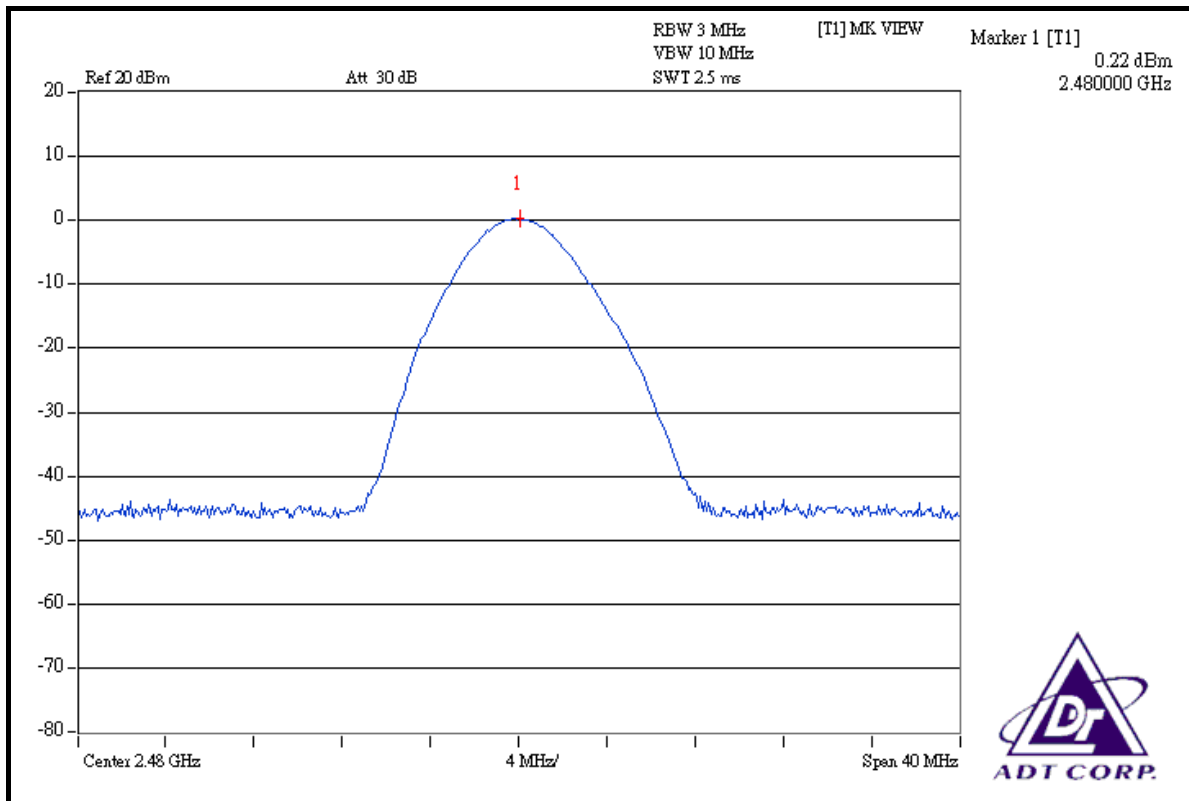



**8DPSK MODULATION**

<b>MODULATION TYPE</b>	8DPSK	<b>ENVIRONMENTAL CONDITIONS</b>	25deg. C, 65%RH, 1022hPa
<b>INPUT POWER (SYSTEM)</b>	120Vac, 60 Hz	<b>TESTED BY</b>	March Tsui

CHANNEL	CHANNEL FREQUENCY (MHz)	PEAK POWER OUTPUT (mW)	PEAK POWER OUTPUT (dBm)	PEAK POWER LIMIT (mW)	PASS/FAIL
0	2402	1.845	2.66	125	PASS
39	2441	1.832	2.63	125	PASS
78	2480	1.734	2.39	125	PASS

**CH 0**

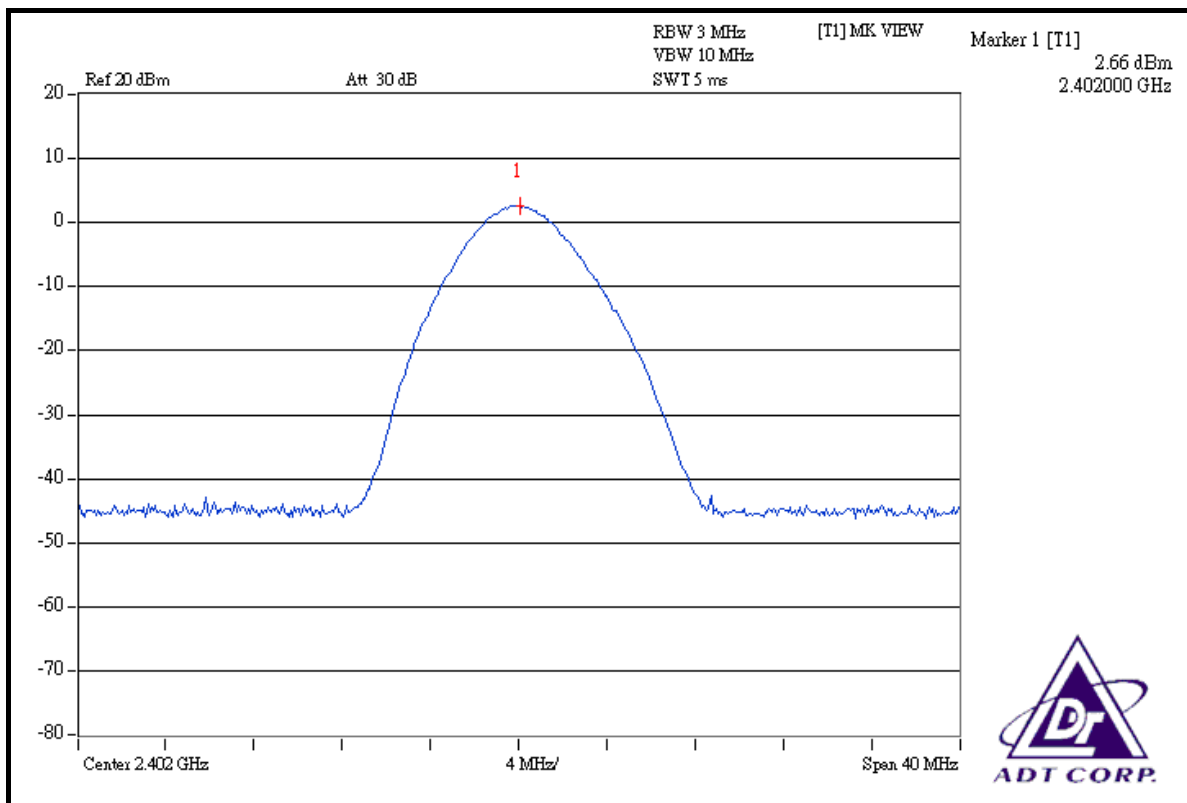



### CH 39

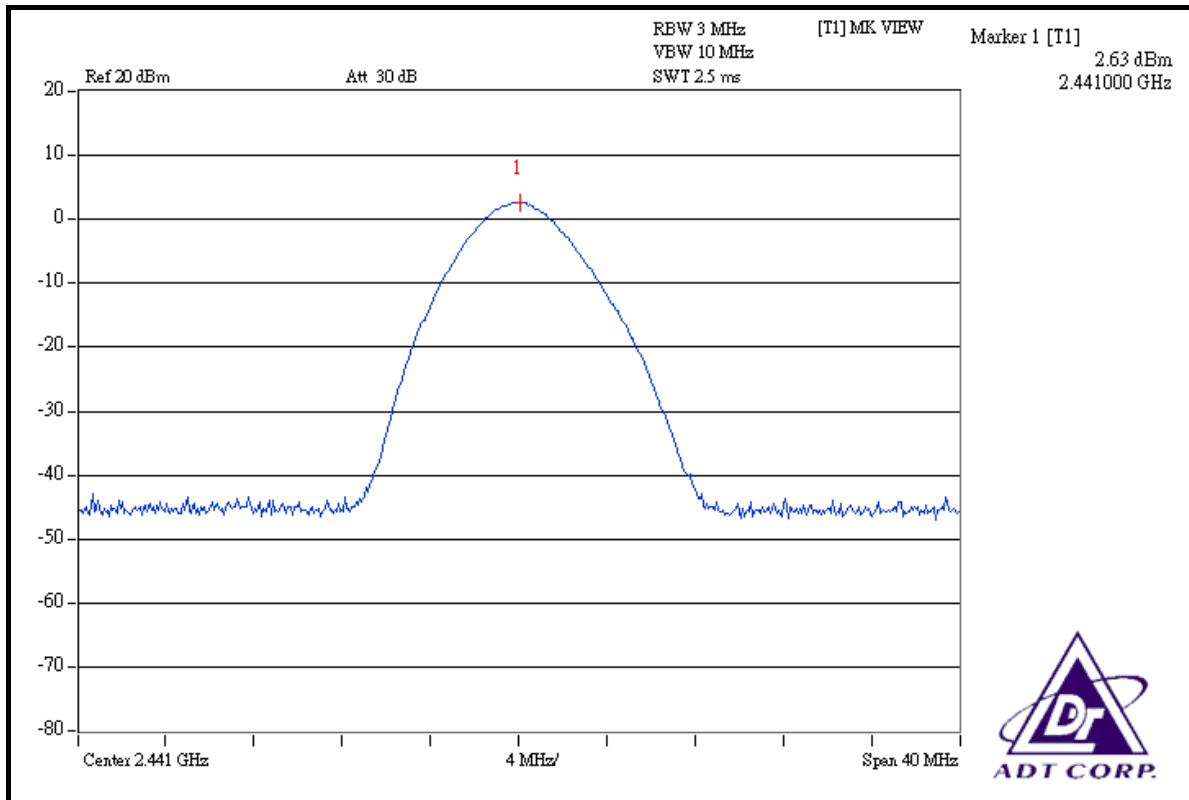

### CH 78

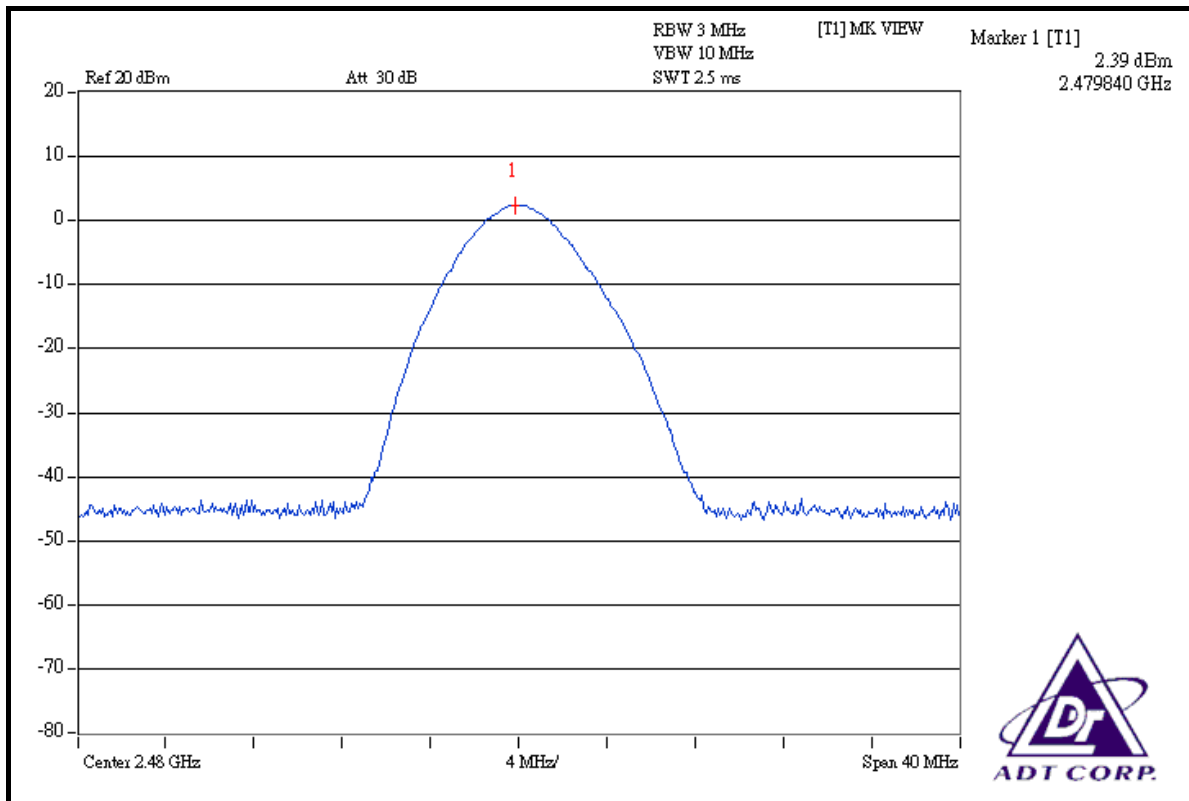



## 4.8 BAND EDGES MEASUREMENT

### 4.8.1 LIMITS OF BAND EDGES MEASUREMENT

Below -20dB of the highest emission level of operating band (in 100KHz RBW).

### 4.8.2 TEST INSTRUMENTS

DESCRIPTION & MANUFACTURER	MODEL NO.	SERIAL NO.	CALIBRATED UNTIL
SPECTRUM ANALYZER	FSP40	100040	Jun. 28, 2008

**NOTES:** The calibration interval of the above test instruments is 12 months. And the calibrations are traceable to NML/ROC and NIST/USA.

### 4.8.3 TEST PROCEDURE

The transmitter output was connected to the spectrum analyzer via a low lose cable. Set both RBW and VBW of spectrum analyzer to 100 kHz with suitable frequency span including 100 MHz bandwidth from band edge. The band edges was measured and recorded.

### 4.8.4 DEVIATION FROM TEST STANDARD

No deviation.

### 4.8.5 EUT OPERATING CONDITION

The software provided by client enabled the EUT to transmit and receive data at lowest, middle and highest channel frequencies individually.

#### 4.8.6 TEST RESULTS

The spectrum plots are attached on the following 8 images. D1 line indicates the highest level, D2 line indicates the 20dB offset below D1. It shows compliance with the requirement in part 15.247(d).

#### GFSK MODULATION – TEST MODE A

**NOTE 1:** The band edge emission plot on the next page shows 47.51dBc between carrier maximum power and local maximum emission in restrict band (2.324800GHz). The emission of carrier strength list in the test result of channel 0 at the item 4.2.7 is 95.78dBuV/m (Peak), so the maximum field strength in restrict band is  $95.78 - 47.51 = 48.27$ dBuV/m, which is under 74dBuV/m limit.

Average value =  $48.27 - 30.10 = 18.17$ dBuV/m, which is under 54dBuV/m limit.

\*The DH5 packet was the worse case duty cycle for a transmit dwell time on a channel, based upon bluetooth theory the transmitter is on  $0.625 * 5$  per 296.25 ms per channel. Therefore, the duty cycle correction factor be equal to:  $20\log(3.125/100) = -30.1$  dB.

Average value = peak reading – 30.1

**NOTE 2:** The band edge emission plot on the next second page shows 48.28dBc between carrier maximum power and local maximum emission in restrict band (2.497400GHz). The emission of carrier strength list in the test result of channel 78 at the item 4.2.7 is 94.96dBuV/m (Peak), so the maximum field strength in restrict band is  $94.96 - 48.28 = 46.68$ dBuV/m, which is under 74 dBuV/m limit.

Average value =  $46.68 - 30.10 = 16.58$ dBuV/m, which is under 54dBuV/m limit.

\*The DH5 packet was the worse case duty cycle for a transmit dwell time on a channel, based upon bluetooth theory the transmitter is on  $0.625 * 5$  per 296.25 ms per channel. Therefore, the duty cycle correction factor be equal to:  $20\log(3.125/100) = -30.1$  dB.

Average value = peak reading – 30.1



## GFSK MODULATION – TEST MODE B

**NOTE 1:** The band edge emission plot on the next page shows 47.51dBc between carrier maximum power and local maximum emission in restrict band (2.324800GHz). The emission of carrier strength list in the test result of channel 0 at the item 4.2.7 is 91.21dBuV/m (Peak), so the maximum field strength in restrict band is  $91.21 - 47.51 = 43.70$ dBuV/m, which is under 74dBuV/m limit.

Average value =  $43.70 - 30.10 = 13.60$ dBuV/m, which is under 54dBuV/m limit.

\*The DH5 packet was the worse case duty cycle for a transmit dwell time on a channel, based upon bluetooth theory the transmitter is on  $0.625 * 5$  per 296.25 ms per channel. Therefore, the duty cycle correction factor be equal to:  $20\log(3.125/100) = -30.1$  dB.

Average value = peak reading – 30.1

**NOTE 2:** The band edge emission plot on the next second page shows 48.28dBc between carrier maximum power and local maximum emission in restrict band (2.497400GHz). The emission of carrier strength list in the test result of channel 78 at the item 4.2.7 is 90.69dBuV/m (Peak), so the maximum field strength in restrict band is  $93.63 - 48.28 = 45.35$ dBuV/m, which is under 74 dBuV/m limit.

Average value =  $45.35 - 30.10 = 15.25$ dBuV/m, which is under 54dBuV/m limit.

\*The DH5 packet was the worse case duty cycle for a transmit dwell time on a channel, based upon bluetooth theory the transmitter is on  $0.625 * 5$  per 296.25 ms per channel. Therefore, the duty cycle correction factor be equal to:  $20\log(3.125/100) = -30.1$  dB.

Average value = peak reading – 30.1

## GFSK MODULATION – TEST MODE C

**NOTE 1:** The band edge emission plot on the next page shows 47.51dBc between carrier maximum power and local maximum emission in restrict band (2.324800GHz). The emission of carrier strength list in the test result of channel 0 at the item 4.2.7 is 98.66dBuV/m (Peak), so the maximum field strength in restrict band is  $98.66 - 47.51 = 51.15$ dBuV/m, which is under 74dBuV/m limit.

Average value =  $51.15 - 30.10 = 21.05$ dBuV/m, which is under 54dBuV/m limit.

\*The DH5 packet was the worse case duty cycle for a transmit dwell time on a channel, based upon bluetooth theory the transmitter is on  $0.625 * 5$  per 296.25 ms per channel. Therefore, the duty cycle correction factor be equal to:  $20\log(3.125/100) = -30.1$  dB.

Average value = peak reading – 30.1

**NOTE 2:** The band edge emission plot on the next second page shows 48.28dBc between carrier maximum power and local maximum emission in restrict band (2.497400GHz). The emission of carrier strength list in the test result of channel 78 at the item 4.2.7 is 95.47dBuV/m (Peak), so the maximum field strength in restrict band is  $95.47 - 48.28 = 47.19$ dBuV/m, which is under 74 dBuV/m limit.

Average value =  $47.19 - 30.10 = 17.09$ dBuV/m, which is under 54dBuV/m limit.

\*The DH5 packet was the worse case duty cycle for a transmit dwell time on a channel, based upon bluetooth theory the transmitter is on  $0.625 * 5$  per 296.25 ms per channel. Therefore, the duty cycle correction factor be equal to:  $20\log(3.125/100) = -30.1$  dB.

Average value = peak reading – 30.1

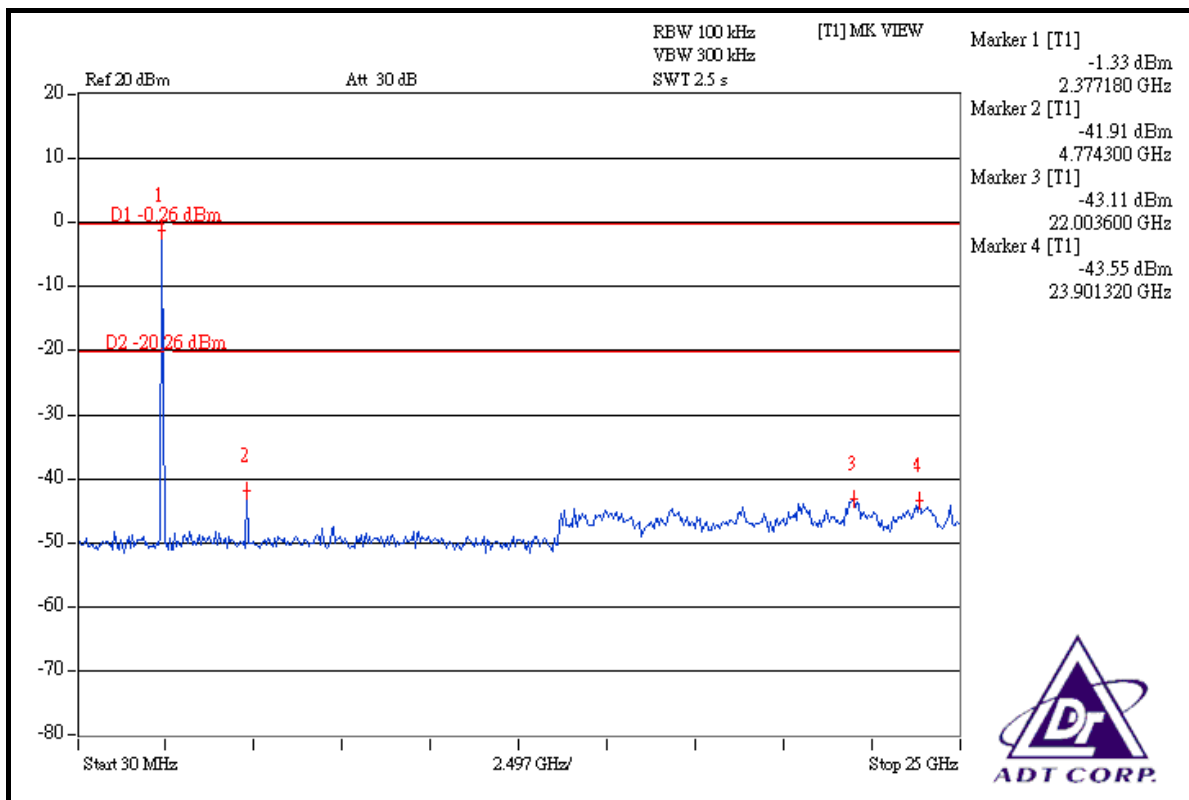
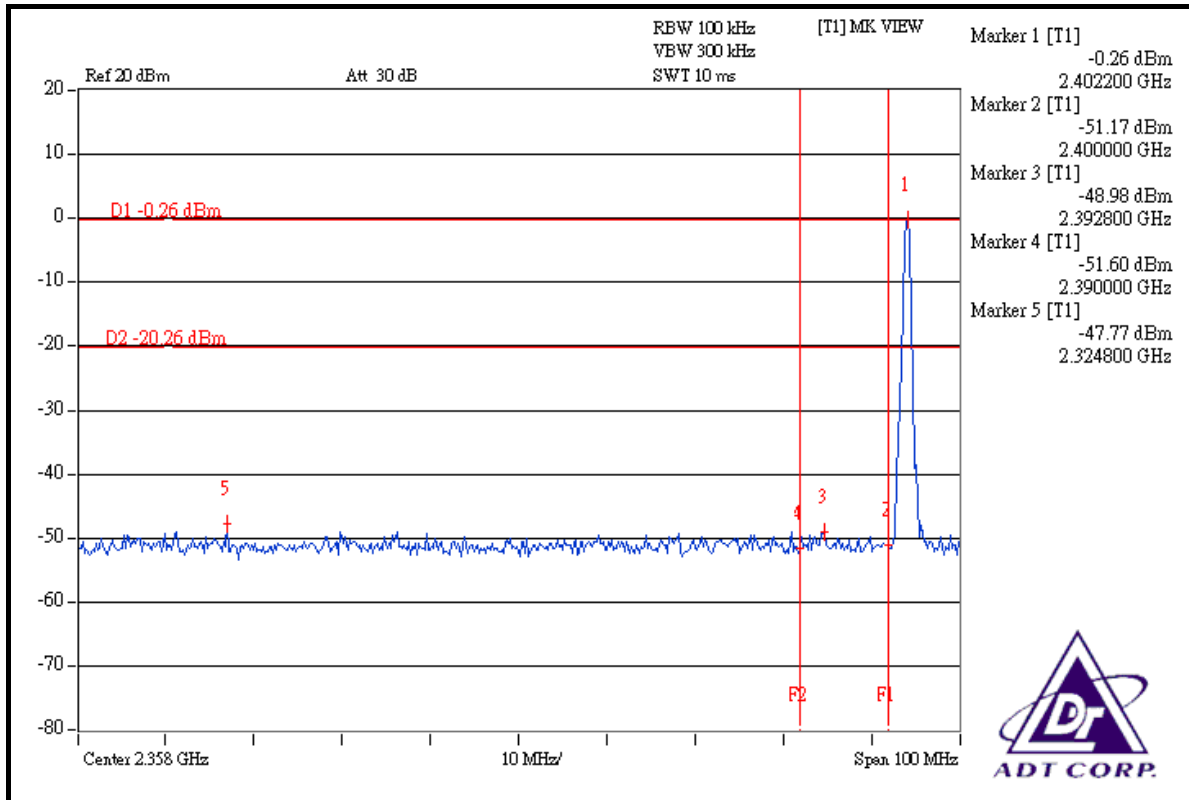

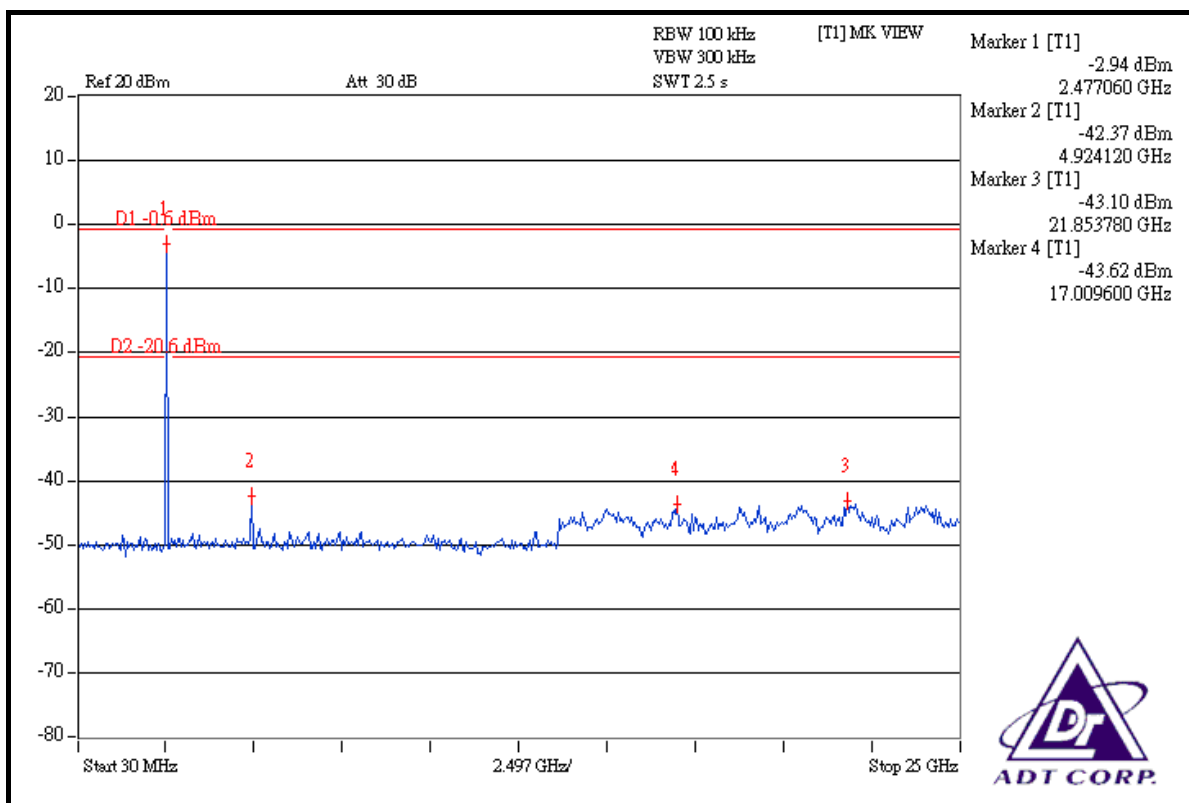
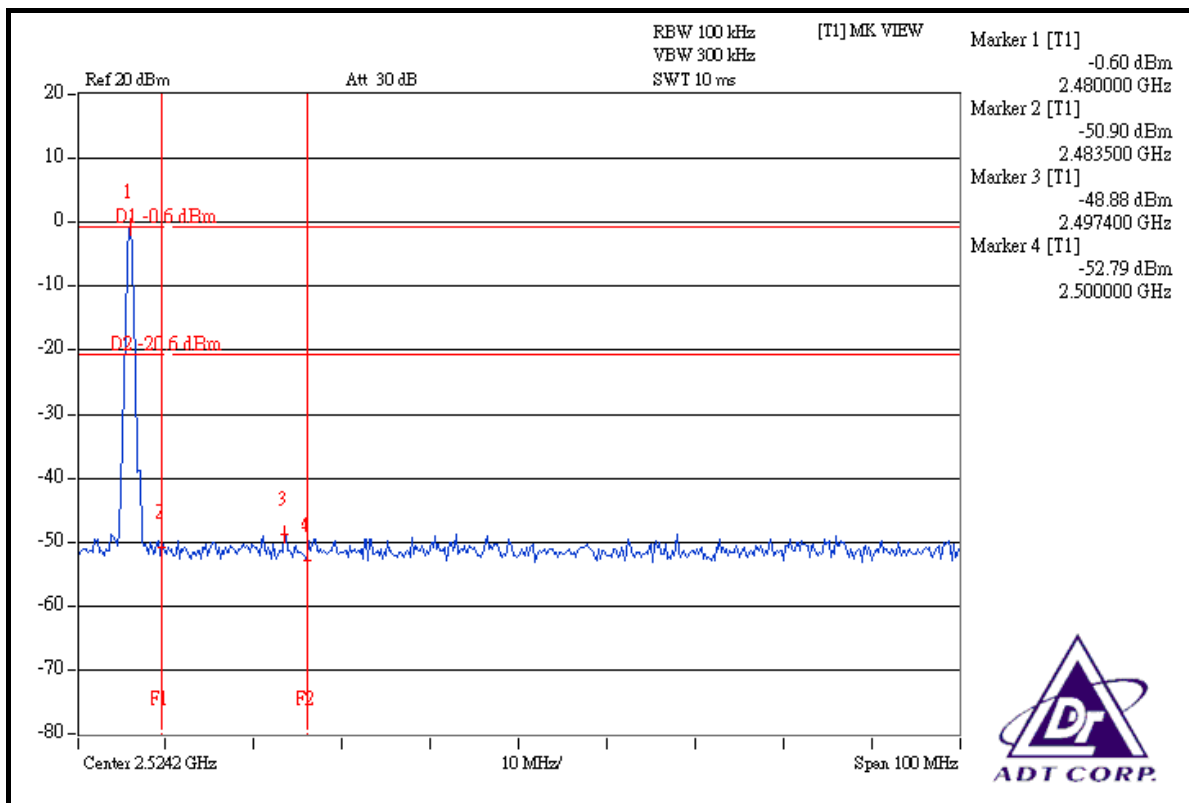

## 8DPSK MODULATION – TEST MODE A

**NOTE 1:** The band edge emission plot on the next page shows 46.23dBc between carrier maximum power and local maximum emission in restrict band (2.387600GHz). The emission of carrier strength list in the test result of channel 0 at the item 4.2.7 is 95.44dBuV/m (Peak), so the maximum field strength in restrict band is  $95.44 - 46.23 = 49.21$ dBuV/m, which is under 74 dBuV/m limit.

Average value =  $49.21 - 30.10 = 19.11$ dBuV/m, which is under 54dBuV/m limit.

\*The DH5 packet was the worse case duty cycle for a transmit dwell time on a channel, based upon bluetooth theory the transmitter is on  $0.625 * 5$  per 296.25 ms per channel. Therefore, the duty cycle be equal to:  $20\log(3.125/100) = -30.1$  dB.

Average value = peak reading – 30.1

**NOTE 2:** The band edge emission plot on the next second page shows 48.42dBc between carrier maximum power and local maximum emission in restrict band (2.495400GHz). The emission of carrier strength list in the test result of channel 78 at the item 4.2.7 is 94.87dBuV/m (Peak), so the maximum field strength in restrict band is  $94.87 - 48.42 = 46.45$ dBuV/m, which is under 74 dBuV/m limit.

Average value =  $46.45 - 30.10 = 16.35$ dBuV/m, which is under 54dBuV/m limit.

\*The DH5 packet was the worse case duty cycle for a transmit dwell time on a channel, based upon bluetooth theory the transmitter is on  $0.625 * 5$  per 296.25 ms per channel. Therefore, the duty cycle be equal to:  $20\log(3.125/100) = -30.1$  dB.

Average value = peak reading – 30.1

## 8DPSK MODULATION – TEST MODE B

**NOTE 1:** The band edge emission plot on the next page shows 46.23dBc between carrier maximum power and local maximum emission in restrict band (2.387600GHz). The emission of carrier strength list in the test result of channel 0 at the item 4.2.7 is 91.07dBuV/m (Peak), so the maximum field strength in restrict band is  $91.07 - 46.23 = 44.84$ dBuV/m, which is under 74 dBuV/m limit.

Average value =  $44.84 - 30.10 = 14.74$ dBuV/m, which is under 54dBuV/m limit.

\*The DH5 packet was the worse case duty cycle for a transmit dwell time on a channel, based upon bluetooth theory the transmitter is on  $0.625 * 5$  per 296.25 ms per channel. Therefore, the duty cycle be equal to:  $20\log(3.125/100) = -30.1$  dB.

Average value = peak reading – 30.1

**NOTE 2:** The band edge emission plot on the next second page shows 48.42dBc between carrier maximum power and local maximum emission in restrict band (2.495400GHz). The emission of carrier strength list in the test result of channel 78 at the item 4.2.7 is 92.58dBuV/m (Peak), so the maximum field strength in restrict band is  $92.58 - 48.42 = 44.16$ dBuV/m, which is under 74 dBuV/m limit.

Average value =  $44.16 - 30.10 = 14.06$ dBuV/m, which is under 54dBuV/m limit.

\*The DH5 packet was the worse case duty cycle for a transmit dwell time on a channel, based upon bluetooth theory the transmitter is on  $0.625 * 5$  per 296.25 ms per channel. Therefore, the duty cycle be equal to:  $20\log(3.125/100) = -30.1$  dB.

Average value = peak reading – 30.1

## 8DPSK MODULATION – TEST MODE C

**NOTE 1:** The band edge emission plot on the next page shows 46.23dBc between carrier maximum power and local maximum emission in restrict band (2.387600GHz). The emission of carrier strength list in the test result of channel 0 at the item 4.2.7 is 97.92dBuV/m (Peak), so the maximum field strength in restrict band is  $97.92 - 46.23 = 51.69$ dBuV/m, which is under 74 dBuV/m limit.

Average value =  $51.69 - 30.10 = 21.59$ dBuV/m, which is under 54dBuV/m limit.

\*The DH5 packet was the worse case duty cycle for a transmit dwell time on a channel, based upon bluetooth theory the transmitter is on  $0.625 * 5$  per 296.25 ms per channel. Therefore, the duty cycle be equal to:  $20\log(3.125/100) = -30.1$  dB.

Average value = peak reading – 30.1

**NOTE 2:** The band edge emission plot on the next second page shows 48.42dBc between carrier maximum power and local maximum emission in restrict band (2.495400GHz). The emission of carrier strength list in the test result of channel 78 at the item 4.2.7 is 94.66dBuV/m (Peak), so the maximum field strength in restrict band is  $94.66 - 48.42 = 46.24$ dBuV/m, which is under 74 dBuV/m limit.

Average value =  $46.24 - 30.10 = 16.14$ dBuV/m, which is under 54dBuV/m limit.

\*The DH5 packet was the worse case duty cycle for a transmit dwell time on a channel, based upon bluetooth theory the transmitter is on  $0.625 * 5$  per 296.25 ms per channel. Therefore, the duty cycle be equal to:  $20\log(3.125/100) = -30.1$  dB.

Average value = peak reading – 30.1

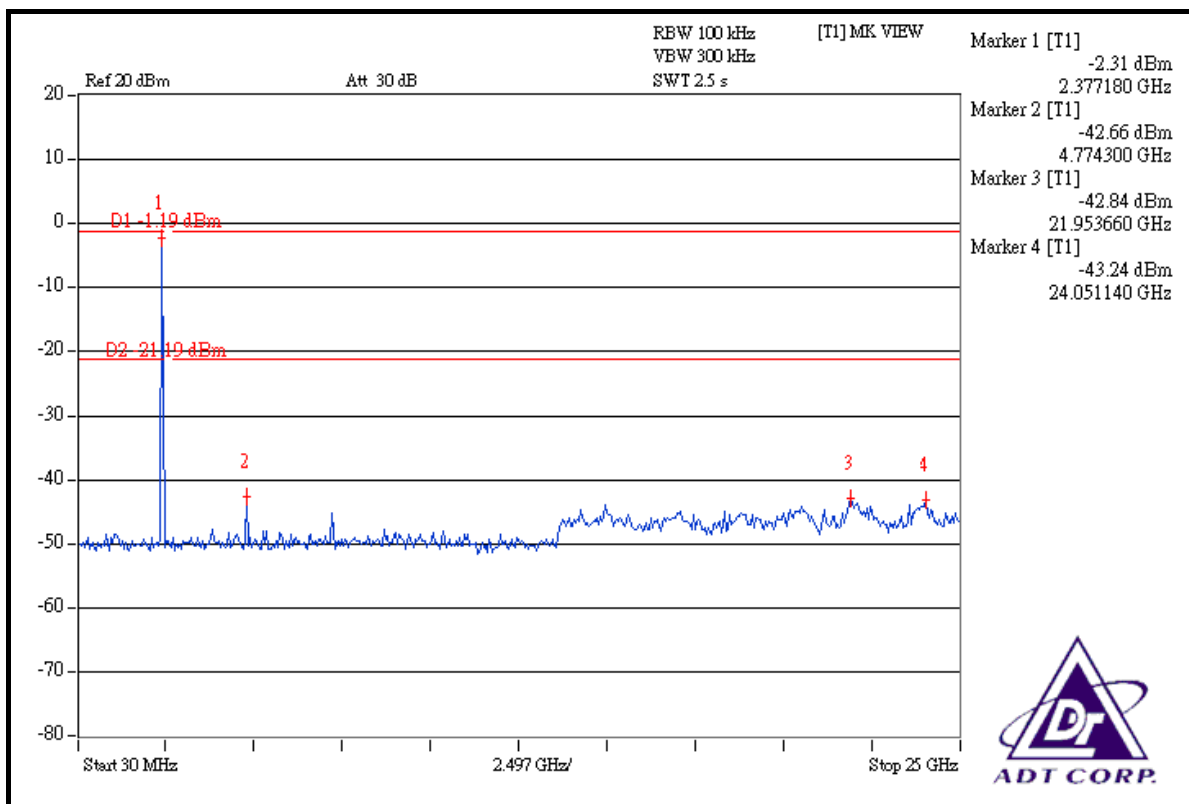
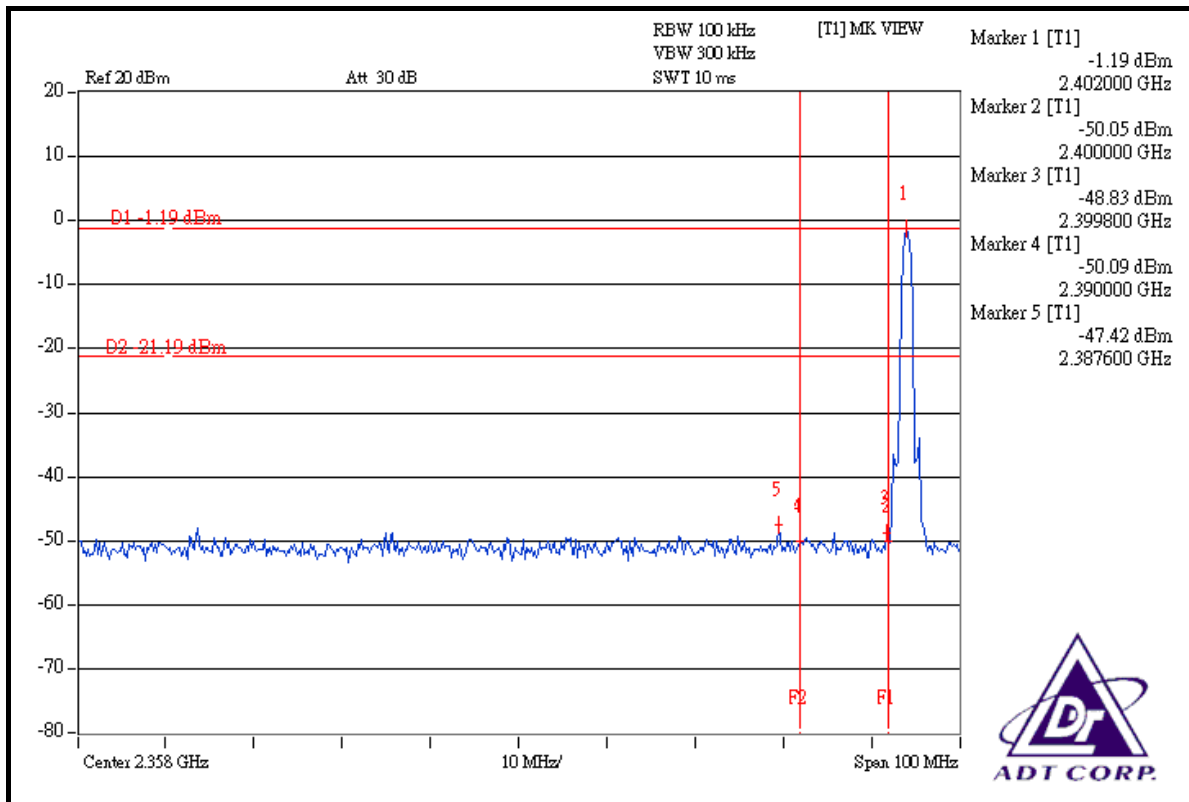



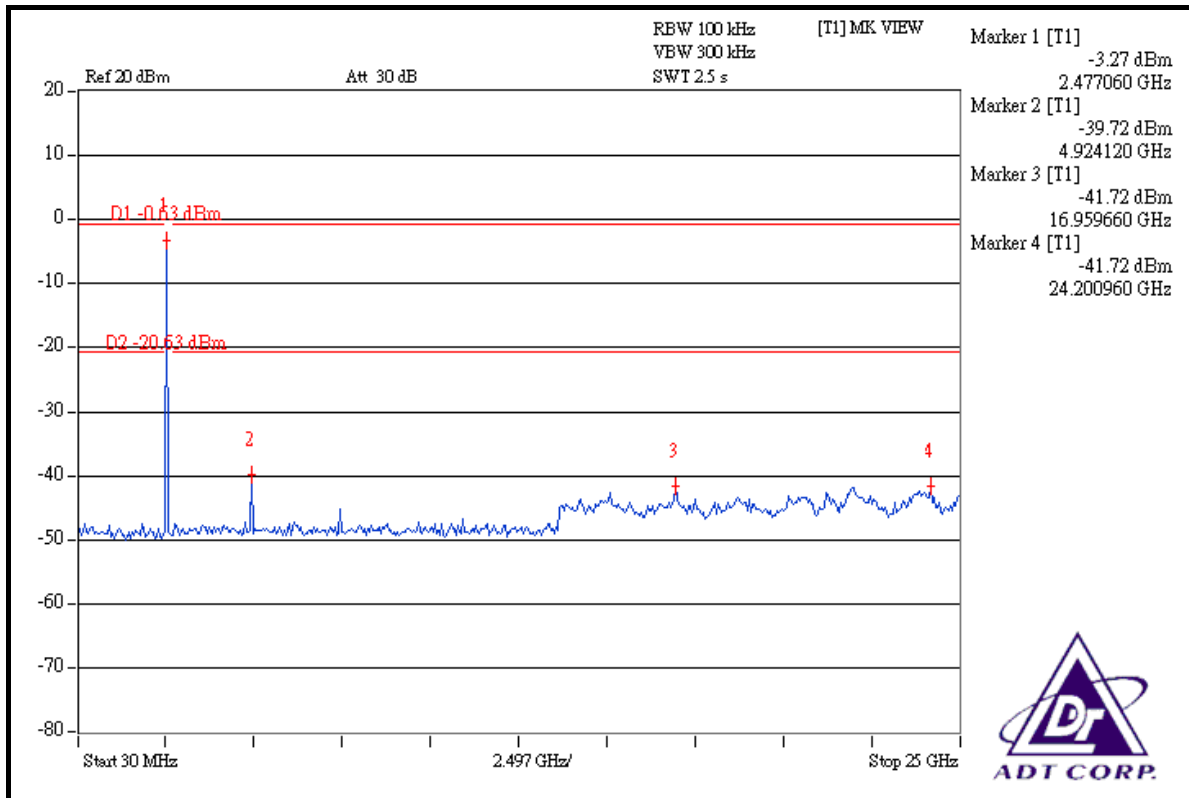
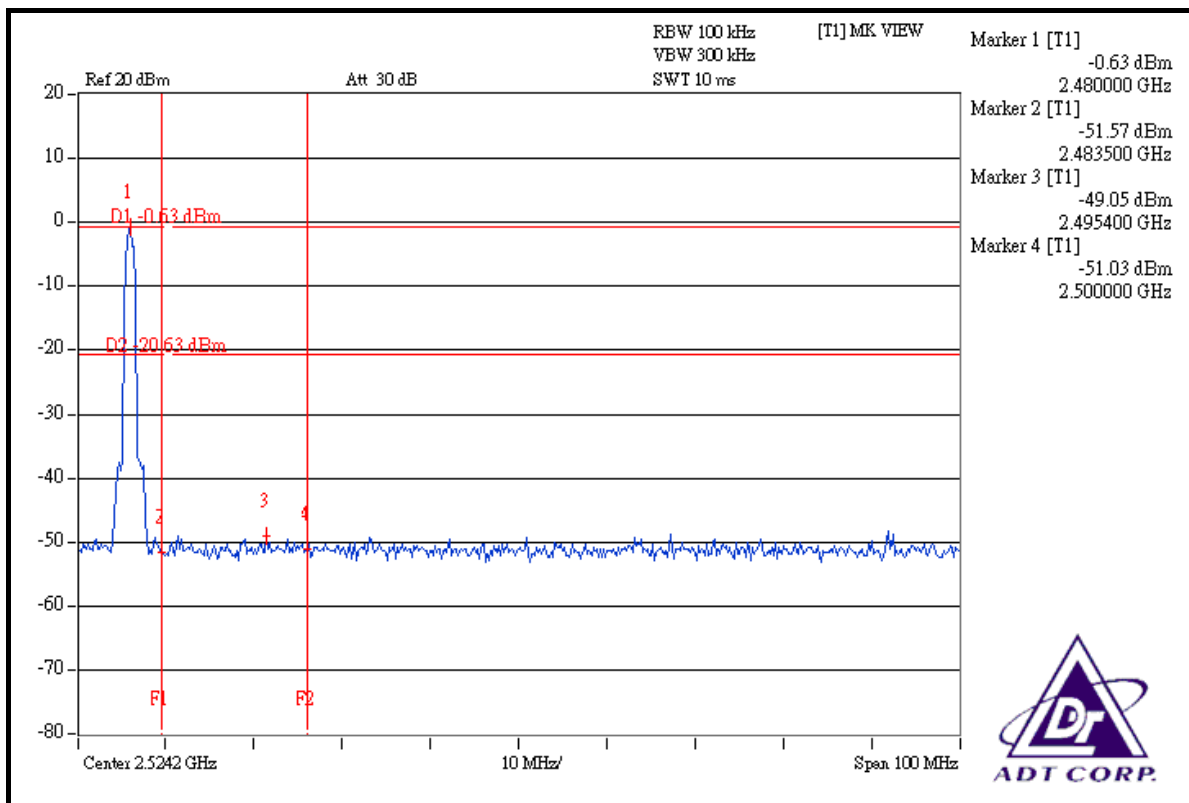

## **4.9 ANTENNA REQUIREMENT**

### **4.9.1 STANDARD APPLICABLE**

For intentional device, according to FCC 47 CFR Section 15.203, an intentional radiator shall be designed to ensure that no antenna other than that furnished by the responsible party shall be used with the device.

And according to FCC 47 CFR Section 15.247 (b), if transmitting antennas of directional gain greater than 6dBi are used, the power shall be reduced by the amount in dB that the directional gain of the antenna exceeds 6dBi.

### **4.9.2 ANTENNA CONNECTED CONSTRUCTION**

The antennas used in this product are chip antenna, PIFA antenna and printed antenna that with U.F.L antenna connector but chip antenna without connector. The maximum gain of this antenna is 1.89dBi.



## 5. PHOTOGRAPHS OF THE TEST CONFIGURATION

Please refer to the attached file (Test Setup Photo).



## 6. INFORMATION ON THE TESTING LABORATORIES

We, ADT Corp., were founded in 1988 to provide our best service in EMC, Radio, Telecom and Safety consultation. Our laboratories are accredited and approved by the following approval agencies according to ISO/IEC 17025.

<b>USA</b>	FCC, UL, A2LA
<b>Germany</b>	TUV Rheinland
<b>Japan</b>	VCCI
<b>Norway</b>	NEMKO
<b>Canada</b>	INDUSTRY CANADA , CSA
<b>R.O.C.</b>	TAF, BSMI, NCC
<b>Netherlands</b>	Telefication
<b>Singapore</b>	GOST-ASIA(MOU)
<b>Russia</b>	CERTIS(MOU)

Copies of accreditation certificates of our laboratories obtained from approval agencies can be downloaded from our web site: [www.adt.com.tw/index.5/phtml](http://www.adt.com.tw/index.5/phtml).  
If you have any comments, please feel free to contact us at the following:

**Linko EMC/RF Lab:**  
Tel: 886-2-26052180  
Fax: 886-2-26051924

**Hsin Chu EMC/RF Lab:**  
Tel: 886-3-5935343  
Fax: 886-3-5935342

**Hwa Ya EMC/RF/Safety Telecom Lab:**  
Tel: 886-3-3183232  
Fax: 886-3-3185050

**Web Site:** [www.adt.com.tw](http://www.adt.com.tw)

The address and road map of all our labs can be found in our web site also.



## **7. APPENDIX A - MODIFICATIONS RECORDERS FOR ENGINEERING CHANGES TO THE EUT BY THE LAB**

No any modifications are made to the EUT by the lab during the test.