



FCC TEST REPORT (15.407)

REPORT NO.: RF990226L03-1

MODEL NO.: AW-NU231

RECEIVED: Feb. 26, 2010

TESTED: Mar. 09 ~ Mar. 18, 2010

ISSUED: Mar. 22, 2010

APPLICANT: AzureWave Technologies, Inc.

ADDRESS: 8F, No.94, Baozhong Rd., Xindian, Taipei,
Taiwan 231.

ISSUED BY: Bureau Veritas Consumer Products Services
(H.K.) Ltd., Taoyuan Branch

LAB ADDRESS: No. 47, 14th Ling, Chia Pau Tsuen, Lin Kou
Hsiang, Taipei Hsien 244, Taiwan, R.O.C.

TEST LOCATION: No. 19, Hwa Ya 2nd Rd, Wen Hwa Tsuen, Kwei
Shan Hsiang, Taoyuan Hsien 333, Taiwan,
R.O.C.

This test report consists of 105 pages in total. It may be duplicated completely for legal use with the approval of the applicant. It should not be reproduced except in full, without the written approval of our laboratory. The client should not use it to claim product endorsement by TAF or any government agencies. The test results in the report only apply to the tested sample.



TABLE OF CONTENTS

| | | |
|-------|---|----|
| 1. | CERTIFICATION..... | 4 |
| 2. | SUMMARY OF TEST RESULTS | 5 |
| 2.1 | MEASUREMENT UNCERTAINTY..... | 5 |
| 3. | GENERAL INFORMATION..... | 6 |
| 3.1 | GENERAL DESCRIPTION OF EUT | 6 |
| 3.2 | DESCRIPTION OF TEST MODES | 8 |
| 3.2.1 | CONFIGURATION OF SYSTEM UNDER TEST | 9 |
| 3.2.2 | TEST MODE APPLICABILITY AND TESTED CHANNEL DETAIL | 10 |
| 3.3 | GENERAL DESCRIPTION OF APPLIED STANDARDS | 13 |
| 3.4 | DESCRIPTION OF SUPPORT UNITS | 13 |
| 4. | TEST TYPES AND RESULTS | 14 |
| 4.1 | RADIATED EMISSION MEASUREMENT | 14 |
| 4.1.1 | LIMITS OF RADIATED EMISSION MEASUREMENT..... | 14 |
| 4.1.2 | LIMITS OF UNWANTED EMISSION OUT OF THE RESTRICTED BANDS | 14 |
| 4.1.3 | TEST INSTRUMENTS..... | 15 |
| 4.1.4 | TEST PROCEDURES | 16 |
| 4.1.5 | DEVIATION FROM TEST STANDARD..... | 16 |
| 4.1.6 | TEST SETUP | 17 |
| 4.1.7 | EUT OPERATING CONDITION..... | 17 |
| 4.1.8 | TEST RESULTS | 18 |
| 4.2 | CONDUCTED EMISSION MEASUREMENT | 47 |
| 4.2.1 | LIMITS OF CONDUCTED EMISSION MEASUREMENT..... | 47 |
| 4.2.2 | TEST INSTRUMENTS..... | 47 |
| 4.2.3 | TEST PROCEDURES | 48 |
| 4.2.4 | DEVIATION FROM TEST STANDARD..... | 48 |
| 4.2.5 | TEST SETUP | 49 |
| 4.2.6 | EUT OPERATING CONDITIONS | 49 |
| 4.2.7 | TEST RESULTS | 50 |
| 4.3 | MAXIMUM CONDUCTED OUTPUT POWER MEASUREMENT | 54 |
| 4.3.1 | LIMITS OF MAXIMUM CONDUCTED OUTPUT POWER MEASUREMENT..... | 54 |
| 4.3.2 | TEST INSTRUMENTS..... | 54 |
| 4.3.3 | TEST PROCEDURE..... | 55 |
| 4.3.4 | DEVIATION FROM TEST STANDARD..... | 55 |
| 4.3.5 | TEST SETUP | 55 |
| 4.3.6 | EUT OPERATING CONDITIONS | 55 |



A D T

| | | |
|-------|--|-----|
| 4.3.7 | TEST RESULTS | 56 |
| 4.4 | PEAK POWER EXCURSION MEASUREMENT | 61 |
| 4.4.1 | LIMITS OF PEAK POWER EXCURSION MEASUREMENT | 61 |
| 4.4.2 | TEST INSTRUMENTS..... | 61 |
| 4.4.3 | TEST PROCEDURE..... | 61 |
| 4.4.4 | DEVIATION FROM TEST STANDARD..... | 62 |
| 4.4.5 | TEST SETUP | 62 |
| 4.4.6 | EUT OPERATING CONDITIONS | 62 |
| 4.4.7 | TEST RESULTS | 63 |
| 4.5 | PEAK POWER SPECTRAL DENSITY MEASUREMENT | 69 |
| 4.5.1 | LIMITS OF PEAK POWER SPECTRAL DENSITY MEASUREMENT | 69 |
| 4.5.2 | TEST INSTRUMENTS..... | 69 |
| 4.5.3 | TEST PROCEDURES | 69 |
| 4.5.4 | DEVIATION FROM TEST STANDARD..... | 70 |
| 4.5.5 | TEST SETUP | 70 |
| 4.5.6 | EUT OPERATING CONDITIONS | 70 |
| 4.5.7 | TEST RESULTS | 71 |
| 4.6 | FREQUENCY STABILITY..... | 74 |
| 4.6.1 | LIMITS OF FREQUENCY STABILITY MEASUREMENT | 74 |
| 4.6.2 | TEST INSTRUMENTS..... | 74 |
| 4.6.3 | TEST PROCEDURE..... | 74 |
| 4.6.4 | DEVIATION FROM TEST STANDARD..... | 75 |
| 4.6.5 | TEST SETUP | 75 |
| 4.6.6 | EUT OPERATING CONDITION..... | 75 |
| 4.6.7 | TEST RESULTS | 76 |
| 4.7 | BAND EDGES MEASUREMENT | 77 |
| 4.7.1 | TEST INSTRUMENTS..... | 77 |
| 4.7.2 | TEST PROCEDURE..... | 78 |
| 4.7.3 | EUT OPERATING CONDITION..... | 78 |
| 4.7.4 | TEST RESULTS | 79 |
| 5. | PHOTOGRAPHS OF THE TEST CONFIGURATION..... | 103 |
| 6. | INFORMATION ON THE TESTING LABORATORIES | 104 |
| 7. | APPENDIX A - MODIFICATIONS RECORDERS FOR ENGINEERING CHANGES TO THE EUT BY THE LAB..... | 105 |



1. CERTIFICATION

PRODUCT: Wireless 802.11 a/b/g/n Module

MODEL: AW-NU231

BRAND: AzureWave

APPLICANT: AzureWave Technologies, Inc.

TEST SAMPLE: ENGINEERING SAMPLE

TESTED: Mar. 09 ~ Mar. 18, 2010

STANDARDS: FCC Part 15, Subpart E (Section 15.407)

ANSI C63.4-2003

The above equipment (Model: AW-NU231) has been tested by **Bureau Veritas Consumer Products Services (H.K.) Ltd., Taoyuan Branch**, and found compliance with the requirement of the above standards. The test record, data evaluation & Equipment Under Test (EUT) configurations represented herein are true and accurate accounts of the measurements of the sample's EMC characteristics under the conditions specified in this report.

PREPARED BY : Polly Chien , **DATE** : Mar. 22, 2010
Polly Chien / Specialist

TECHNICAL ACCEPTANCE : Long Chen , **DATE** : Mar. 22, 2010
Responsible for RF Long Chen / Senior Engineer

APPROVED BY : Gary Chang , **DATE** : Mar. 22, 2010
Gary Chang / Assistant Manager

2. SUMMARY OF TEST RESULTS

The EUT has been tested according to the following specifications:

| APPLIED STANDARD: FCC PART 15, SUBPART E (SECTION 15.407) | | | |
|---|--|--------|--|
| STANDARD SECTION | TEST TYPE AND LIMIT | RESULT | REMARK |
| 15.407(b)(5) | AC Power Conducted Emission | PASS | Meet the requirement of limit. Minimum passing margin is -13.56dB at 0.152MHz. |
| 15.407(b)(1/2/3)(b)(5) | Electric Field Strength Spurious Emissions, 30MHz ~ 40000MHz | PASS | Meet the requirement of limit. Minimum passing margin is -1.1dB at 5725.00MHz. |
| 15.407(a)(1/2/3) | Peak Transmit Power | PASS | Meet the requirement of limit. |
| 15.407(a)(6) | Peak Power Excursion | PASS | Meet the requirement of limit. |
| 15.407(a)(1/2/3) | Peak Power Spectral Density | PASS | Meet the requirement of limit. |
| 15.407(g) | Frequency Stability | PASS | Meet the requirement of limit. |
| 15.203 | Antenna Requirement | PASS | No antenna connector is used. |

2.1 MEASUREMENT UNCERTAINTY

Where relevant, the following measurement uncertainty levels have been estimated for tests performed on the EUT as specified in CISPR 16-4-2:

| MEASUREMENT | FREQUENCY | UNCERTAINTY |
|---------------------|-----------------|-------------|
| Conducted emissions | 150kHz~30MHz | 2.44 dB |
| Radiated emissions | 30MHz ~ 200MHz | 3.34 dB |
| | 200MHz ~1000MHz | 3.35 dB |
| | 1GHz ~ 18GHz | 2.26 dB |
| | 18GHz ~ 40GHz | 1.94 dB |

This uncertainty represents an expanded uncertainty expressed at approximately the 95% confidence level using a coverage factor of $k = 2$.

3. GENERAL INFORMATION

3.1 GENERAL DESCRIPTION OF EUT

| | |
|------------------------------|--|
| EUT | Wireless 802.11 a/b/g/n Module |
| MODEL NO. | AW-NU231 |
| FCC ID | TLZ-AWNU231 |
| POWER SUPPLY | 5Vdc |
| MODULATION TYPE | 64QAM, 16QAM, QPSK, BPSK for OFDM |
| MODULATION TECHNOLOGY | OFDM |
| TRANSFER RATE | 802.11a: 54.0/ 48.0/ 36.0/ 24.0/ 18.0/ 12.0/ 9.0/ 6.0Mbps 802.11n: up to 270.0Mbps |
| OPERATING FREQUENCY | 5180 ~ 5320MHz & 5500 ~ 5700MHz |
| NUMBER OF CHANNEL | 5180 ~ 5320MHz: 8 for 802.11a, 802.11n (20MHz) 4 for 802.11n (40MHz) 5500 ~ 5700MHz: 8 for 802.11a, 802.11n (20MHz) 3 for 802.11n (40MHz) |
| OUTPUT POWER | 45.5mW for 5180 ~ 5240MHz 46.0mW for 5260 ~ 5320MHz 43.8mW for 5500 ~ 5700MHz |
| ANTENNA TYPE | PCB antenna with 1.59dBi gain |
| ANTENNA CONNECTOR | NA |
| I/O PORTS | USB |
| DATA CABLE | NA |
| ACCESSORY DEVICES | NA |

NOTE:

1. The EUT is a wireless 802.11 a/b/g/n Module. The functions of EUT listed as below:

| | TEST STANDARD | REFERENCE REPORT |
|--|--|------------------|
| WLAN 802.11b/g, 802.11n | FCC Part 15, Subpart C (Section 15.247) | RF990226L03 |
| WLAN 802.11a, 802.11n (5745~5825 MHz) | | |
| WLAN 802.11a, 802.11n (5180~5320MHz & 5500 ~5700MHz) | FCC Part 15, Subpart E (Section 15.407) | RF990226L03-1 |
| WLAN 802.11a, 802.11n (For DFS report) (5250~5350MHz & 5470~5725MHz) | | RF990226L03-2 |

2. The frequency bands used in this EUT are listed as follows:

| Frequency Band (MHz) | 2412~2462 | 5180~5320 | 5500~5700 | 5745~5825 |
|---|-----------|-----------|-----------|-----------|
| 802.11b | √ | - | - | - |
| 802.11g | √ | - | - | - |
| 802.11a | - | √ | √ | √ |
| 802.11n (20MHz) (MCS 0-7) / (MCS 8-15) | √ | √ | √ | √ |
| 802.11n (40MHz) (MCS 0-7) / (MCS 8-15) | √ | √ | √ | √ |



A D T

3. The EUT incorporates a MIMO function. Physically, the EUT provides two completed transmitters and two receivers.

| MODULATION MODE | TX FUNCTION |
|-----------------------------------|--------------------|
| 802.11b | 1TX |
| 802.11g | 1TX |
| 802.11a | 1TX |
| 802.11n (20MHz) (MCS 0-7) | 1TX |
| 802.11n (20MHz) (MCS 8-15) | 2TX |
| 802.11n (40MHz) (MCS 0-7) | 1TX |
| 802.11n (40MHz) (MCS 8-15) | 2TX |

4. The above EUT information was declared by manufacturer and for more detailed features description, please refer to the manufacturer's specifications or user's manual.

3.2 DESCRIPTION OF TEST MODES

Operated in 5180 ~ 5320MHz

8 channels are provided for 802.11a, 802.11n (20MHz):

| CHANNEL | FREQUENCY | CHANNEL | FREQUENCY |
|---------|-----------|---------|-----------|
| 36 | 5180 MHz | 52 | 5260 MHz |
| 40 | 5200 MHz | 56 | 5280 MHz |
| 44 | 5220 MHz | 60 | 5300 MHz |
| 48 | 5240 MHz | 64 | 5320 MHz |

4 channels are provided for 802.11n (40MHz):

| CHANNEL | FREQUENCY | CHANNEL | FREQUENCY |
|---------|-----------|---------|-----------|
| 38 | 5190 MHz | 54 | 5270 MHz |
| 46 | 5230 MHz | 62 | 5310 MHz |

Operated in 5500 ~ 5700MHz

8 channels are provided for 802.11a, 802.11n (20MHz):

| CHANNEL | FREQUENCY | CHANNEL | FREQUENCY |
|---------|-----------|---------|-----------|
| 100 | 5500 MHz | 116 | 5580 MHz |
| 104 | 5520 MHz | 132 | 5660 MHz |
| 108 | 5540 MHz | 136 | 5680 MHz |
| 112 | 5560 MHz | 140 | 5700 MHz |

3 channels are provided for 802.11n (40MHz):

| CHANNEL | FREQUENCY | CHANNEL | FREQUENCY |
|---------|-----------|---------|-----------|
| 102 | 5510 MHz | 134 | 5670 MHz |
| 110 | 5550 MHz | | |

3.2.1 CONFIGURATION OF SYSTEM UNDER TEST

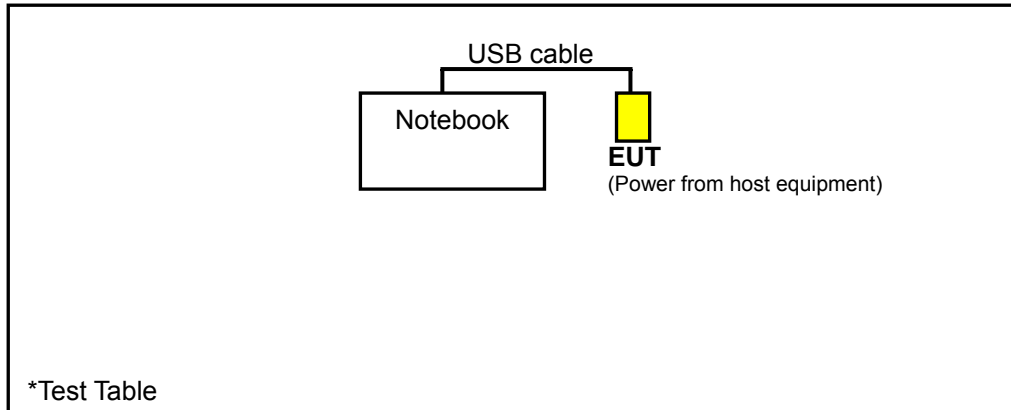

3.2.2 TEST MODE APPLICABILITY AND TESTED CHANNEL DETAIL

| EUT CONFIGURE MODE | APPLICABLE TO | | | | DESCRIPTION |
|--------------------|---------------|-------|-----|------|-------------|
| | RE \geq 1G | RE<1G | PLC | APCM | |
| - | √ | √ | √ | √ | - |

Where **RE \geq 1G**: Radiated Emission above 1GHz **RE<1G**: Radiated Emission below 1GHz
PLC: Power Line Conducted Emission **APCM**: Antenna Port Conducted Measurement

NOTE : Conducted power of single TX chain has no different when operating at 1 TX or 2 TX mode. Therefore, only 2 TX mode will be tested for 802.11n.

RADIATED EMISSION TEST (ABOVE 1GHz):

- Pre-Scan has been conducted to determine the worst-case mode from all possible combinations between available modulations, XYZ axis and antenna ports (if EUT with antenna diversity architecture).
- Following channel(s) was (were) selected for the final test as listed below.

| MODE | FREQ. BAND (MHz) | AVAILABLE CHANNEL | TESTED CHANNEL | MODULATION TECHNOLOGY | MODULATION TYPE | DATA RATE (Mbps) | AXIS |
|----------------------------|------------------|-------------------|------------------------|-----------------------|-----------------|------------------|------|
| 802.11a | 5180-5320 | 36 to 64 | 36, 40, 48, 52, 60, 64 | OFDM | BPSK | 6.0 | Z |
| 802.11n (20MHz) (MCS 8-15) | | 36 to 64 | 36, 40, 48, 52, 60, 64 | OFDM | BPSK | 6.5 | Z |
| 802.11n (40MHz) (MCS 8-15) | | 38 to 62 | 38, 46, 54, 62 | OFDM | BPSK | 13.5 | Z |
| 802.11a | 5500-5700 | 100 to 140 | 100, 116, 132, 140 | OFDM | BPSK | 6.0 | Z |
| 802.11n (20MHz) (MCS 8-15) | | 100 to 140 | 100, 116, 132, 140 | OFDM | BPSK | 6.5 | Z |
| 802.11n (40MHz) (MCS 8-15) | | 102 to 134 | 102, 110, 134 | OFDM | BPSK | 13.5 | Z |

RADIATED EMISSION TEST (BELOW 1GHz):

- Pre-Scan has been conducted to determine the worst-case mode from all possible combinations between available modulations, data rates and antenna ports (if EUT with antenna diversity architecture).
- Following channel(s) was (were) selected for the final test as listed below.

| MODE | FREQ. BAND (MHz) | AVAILABLE CHANNEL | TESTED CHANNEL | MODULATION TECHNOLOGY | MODULATION TYPE | DATA RATE (Mbps) | AXIS |
|----------------------------|------------------|-------------------|----------------|-----------------------|-----------------|------------------|------|
| 802.11n (40MHz) (MCS 8-15) | 5180-5320 | 38 to 62 | 54 | OFDM | BPSK | 13.5 | Z |
| 802.11n (40MHz) (MCS 8-15) | 5500-5700 | 102 to 134 | 134 | OFDM | BPSK | 13.5 | Z |

POWER LINE CONDUCTED EMISSION TEST:

- Pre-Scan has been conducted to determine the worst-case mode from all possible combinations between available modulations, data rates and antenna ports (if EUT with antenna diversity architecture).
- Following channel(s) was (were) selected for the final test as listed below.

| MODE | FREQ. BAND (MHz) | AVAILABLE CHANNEL | TESTED CHANNEL | MODULATION TECHNOLOGY | MODULATION TYPE | DATA RATE (Mbps) |
|-------------------------------|------------------|-------------------|----------------|-----------------------|-----------------|------------------|
| 802.11n (40MHz) (MCS 8-15) | 5180-5320 | 38 to 62 | 54 | OFDM | BPSK | 13.5 |
| 802.11n (40MHz) (MCS 8-15) | 5500-5700 | 102 to 134 | 134 | OFDM | BPSK | 13.5 |

BANDEDGE MEASUREMENT:

- Pre-Scan has been conducted to determine the worst-case mode from all possible combinations between available modulations, data rates and antenna ports (if EUT with antenna diversity architecture).
- Following channel(s) was (were) selected for the final test as listed below.

| MODE | FREQ. BAND (MHz) | AVAILABLE CHANNEL | TESTED CHANNEL | MODULATION TECHNOLOGY | MODULATION TYPE | DATA RATE (Mbps) |
|-------------------------------|------------------|-------------------|----------------|-----------------------|-----------------|------------------|
| 802.11a | 5180-5320 | 36 to 64 | 36, 48, 52, 64 | OFDM | BPSK | 6.0 |
| 802.11n (20MHz) (MCS 8-15) | | 36 to 64 | 36, 48, 52, 64 | OFDM | BPSK | 6.5 |
| 802.11n (40MHz) (MCS 8-15) | | 38 to 62 | 38, 46, 54, 62 | OFDM | BPSK | 13.5 |
| 802.11a | 5500-5700 | 100 to 140 | 100, 140 | OFDM | BPSK | 6.0 |
| 802.11n (20MHz) (MCS 8-15) | | 100 to 140 | 100, 140 | OFDM | BPSK | 6.5 |
| 802.11n (40MHz) (MCS 8-15) | | 102 to 134 | 102, 134 | OFDM | BPSK | 13.5 |

ANTENNA PORT CONDUCTED MEASUREMENT:

- This item includes all test value of each mode, but only includes spectrum plot of worst value of each mode.
- Pre-Scan has been conducted to determine the worst-case mode from all possible combinations between available modulations, data rates and antenna ports (if EUT with antenna diversity architecture).
- Following channel(s) was (were) selected for the final test as listed below.

| MODE | FREQ. BAND (MHz) | AVAILABLE CHANNEL | TESTED CHANNEL | MODULATION TECHNOLOGY | MODULATION TYPE | DATA RATE (Mbps) |
|----------------------------|------------------|-------------------|------------------------|-----------------------|-----------------|------------------|
| 802.11a | 5180-5320 | 36 to 64 | 36, 40, 48, 52, 60, 64 | OFDM | BPSK | 6.0 |
| 802.11n (20MHz) (MCS 8-15) | | 36 to 64 | 36, 40, 48, 52, 60, 64 | OFDM | BPSK | 6.5 |
| 802.11n (40MHz) (MCS 8-15) | | 38 to 62 | 38, 46, 54, 62 | OFDM | BPSK | 13.5 |
| 802.11a | 5500-5700 | 100 to 140 | 100, 116, 132, 140 | OFDM | BPSK | 6.0 |
| 802.11n (20MHz) (MCS 8-15) | | 100 to 140 | 100, 116, 132, 140 | OFDM | BPSK | 6.5 |
| 802.11n (40MHz) (MCS 8-15) | | 102 to 134 | 102, 110, 134 | OFDM | BPSK | 13.5 |

TEST CONDITION:

| APPLICABLE TO | ENVIRONMENTAL CONDITIONS | INPUT POWER (SYSTEM) | TESTED BY |
|---------------|---------------------------|----------------------|-----------|
| RE \geq 1G | 23deg. C, 65%RH, 1011 hPa | 120Vac, 60Hz | Brad Wu |
| RE<1G | 24deg. C, 66%RH, 1008 hPa | 120Vac, 60Hz | Brad Wu |
| PLC | 23deg. C, 66%RH, 1007 hPa | 120Vac, 60Hz | Dean Wang |
| APCM | 25deg. C, 63%RH, 1006 hPa | 120Vac, 60Hz | Brad Wu |

3.3 GENERAL DESCRIPTION OF APPLIED STANDARDS

The EUT is a RF Product. According to the specifications of the manufacturer, it must comply with the requirements of the following standards:

FCC Part 15, Subpart E (15.407)
ANSI C63.4-2003

All test items have been performed and recorded as per the above standards.

NOTE: The EUT is also considered as a kind of computer peripheral, because the connection to computer is necessary for typical use. It has been verified to comply with the requirements of FCC Part 15, Subpart B, Class B (DoC). The test report has been issued separately.

3.4 DESCRIPTION OF SUPPORT UNITS

The EUT has been tested as an independent unit together with other necessary accessories or support units. The following support units or accessories were used to form a representative test configuration during the tests.

| NO. | PRODUCT | BRAND | MODEL NO. | SERIAL NO. | FCC ID |
|-----|----------|-------|-----------|------------|--------|
| 1 | NOTEBOOK | DELL | PP09S | NA | NA |

| NO. | SIGNAL CABLE DESCRIPTION OF THE ABOVE SUPPORT UNITS |
|-----|---|
| 1 | 0.53m non-shielded USB cable without core. |

NOTE:

1. All power cords of the above support units are non shielded (1.8m).
2. Item 1 and 0.53m USB cable were provided by the client.

4. TEST TYPES AND RESULTS

4.1 RADIATED EMISSION MEASUREMENT

4.1.1 LIMITS OF RADIATED EMISSION MEASUREMENT

Emissions radiated outside of the specified bands, shall be according to the general radiated limits in 15.209 as following:

| FREQUENCIES (MHz) | FIELD STRENGTH (microvolts/meter) | MEASUREMENT DISTANCE (meters) |
|-------------------|-----------------------------------|-------------------------------|
| 0.009 ~ 0.490 | 2400/F(kHz) | 300 |
| 0.490 ~ 1.705 | 24000/F(kHz) | 30 |
| 1.705 ~ 30.0 | 30 | 30 |
| 30 ~ 88 | 100 | 3 |
| 88 ~ 216 | 150 | 3 |
| 216 ~ 960 | 200 | 3 |
| Above 960 | 500 | 3 |

NOTE:

1. The lower limit shall apply at the transition frequencies.
2. Emission level (dBuV/m) = 20 log Emission level (uV/m).
3. As shown in 15.35(b), for frequencies above 1000MHz, the field strength limits are based on average detector, however, the peak field strength of any emission shall not exceed the maximum permitted average limits, specified above by more than 20dB under any condition of modulation.

4.1.2 LIMITS OF UNWANTED EMISSION OUT OF THE RESTRICTED BANDS

| FREQUENCIES (MHz) | EIRP LIMIT (dBm) | EQUIVALENT FIELD STRENGTH AT 3m (dBµV/m) *NOTE 3 |
|-------------------|------------------|--|
| | PK | PK |
| 5150 ~ 5350 | -27 | 68.3 |
| 5470 ~ 5725 | -27 | 68.3 |

NOTE: The following formula is used to convert the equipment isotropic radiated power (eirp) to field strength:

$$E = \frac{1000000\sqrt{30P}}{3} \mu\text{V/m, where P is the eirp (Watts).}$$

4.1.3 TEST INSTRUMENTS

| DESCRIPTION & MANUFACTURER | MODEL NO. | SERIAL NO. | DATE OF CALIBRATION | DUE DATE OF CALIBRATION |
|---|------------------------------|-------------|---------------------|-------------------------|
| Test Receiver ROHDE & SCHWARZ | ESI7 | 100033 | Jul. 06, 2009 | Jul. 05, 2010 |
| Spectrum Analyzer ROHDE & SCHWARZ | FSP40 | 100076 | May 26, 2009 | May 25, 2010 |
| BILOG Antenna SCHWARZBECK | VULB9168 | 9168-160 | Apr. 27, 2009 | Apr. 26, 2010 |
| HORN Antenna SCHWARZBECK | 9120D | 9120D-209 | Jul. 01, 2009 | Jun. 30, 2010 |
| HORN Antenna SCHWARZBECK | BBHA 9170 | BBHA9170243 | Dec. 25, 2009 | Dec. 24, 2010 |
| Preamplifier Agilent | 8447D | 2944A10633 | Nov. 10, 2009 | Nov. 09, 2010 |
| Preamplifier Agilent | 8449B | 3008A01964 | Nov. 09, 2009 | Nov. 08, 2010 |
| RF signal cable HUBER+SUHNNER | SUCOFLEX 104 | 238141/4 | May 13, 2009 | May 12, 2010 |
| RF signal cable HUBER+SUHNNER | SUCOFLEX 104 | 12738/6 | May 13, 2009 | May 12, 2010 |
| Software ADT. | ADT_Radiated_ V7.6.15.9.2 | NA | NA | NA |
| Antenna Tower inn-co GmbH | MA 4000 | 013303 | NA | NA |
| Antenna Tower Controller inn-co GmbH | CO2000 | 017303 | NA | NA |
| Turn Table ADT. | TT100. | TT93021703 | NA | NA |
| Turn Table Controller ADT. | SC100. | SC93021703 | NA | NA |
| 26GHz ~ 40GHz Amplifier | EM26400 | 07026401 | Aug. 27, 2009 | Aug. 26, 2010 |

- NOTE:**
1. The calibration interval of the above test instruments is 12 months and the calibrations are traceable to NML/ROC and NIST/USA.
 2. The test was performed in HwaYa Chamber 3.
 3. The horn antenna and HP preamplifier (model: 8449B) are used only for the measurement of emission frequency above 1GHz if tested.
 4. The FCC Site Registration No. is 988962.
 5. The IC Site Registration No. is IC 7450F-3.

4.1.4 TEST PROCEDURES

- a. The EUT was placed on the top of a rotating table 0.8 meters above the ground at a 3 meter semi-anechoic chamber. The table was rotated 360 degrees to determine the position of the highest radiation.
- b. The EUT was set 3 meters away from the interference-receiving antenna, which was mounted on the top of a variable-height antenna tower.
- c. The antenna is a broadband antenna, and its height is varied from one meter to four meters above the ground to determine the maximum value of the field strength. Both horizontal and vertical polarizations of the antenna are set to make the measurement.
- d. For each suspected emission, the EUT was arranged to its worst case and then the antenna was tuned to heights from 1 meter to 4 meters and the rotatable table was turned from 0 degrees to 360 degrees to find the maximum reading.
- e. The test-receiver system was set to Peak Detect Function and Specified Bandwidth with Maximum Hold Mode.
- f. If the emission level of the EUT in peak mode was 10dB lower than the limit specified, then testing could be stopped and the peak values of the EUT would be reported. Otherwise the emissions that did not have 10dB margin would be re-tested one by one using peak, quasi-peak or average method as specified and then reported in a data sheet.

NOTE:

1. The resolution bandwidth and video bandwidth of test receiver/spectrum analyzer is 120kHz for Peak detection (PK) and Quasi-peak detection (QP) at frequency below 1GHz.
2. The resolution bandwidth of test receiver/spectrum analyzer is 1MHz and video bandwidth is 3MHz for Peak detection at frequency above 1GHz.
3. The resolution bandwidth of test receiver/spectrum analyzer is 1MHz and the video bandwidth is 10Hz for Average detection (AV) at frequency above 1GHz.
4. All modes of operation were investigated and the worst-case emissions are reported.

4.1.5 DEVIATION FROM TEST STANDARD

No deviation.

4.1.6 TEST SETUP

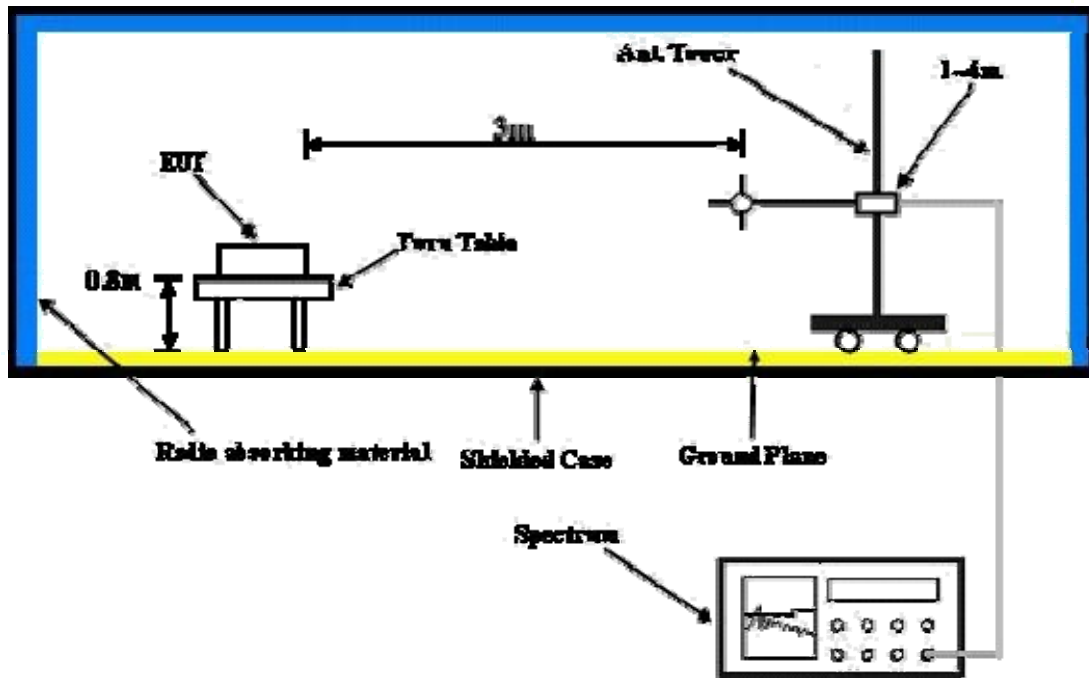

For the actual test configuration, please refer to the attached file (Test Setup Photo).

4.1.7 EUT OPERATING CONDITION

- a. Connected the EUT with notebook system via USB cable on a testing table
- b. The notebook system ran a test program (provided by manufacturer) to enable EUT under transmission condition continuously at specific channel frequency.
- c. The necessary accessories enable the EUT in full functions.

4.1.8 TEST RESULTS

802.11a

| EUT TEST CONDITION | | MEASUREMENT DETAIL | |
|--------------------------|-----------------------------|--------------------|---------------------------|
| CHANNEL | Channel 36 | FREQUENCY RANGE | 1 ~ 40GHz |
| INPUT POWER (SYSTEM) | 120Vac, 60 Hz | DETECTOR FUNCTION | Peak (PK) Average (AV) |
| ENVIRONMENTAL CONDITIONS | 23deg. C, 65%RH 1011 hPa | TESTED BY | Brad Wu |

| ANTENNA POLARITY & TEST DISTANCE: HORIZONTAL AT 3 M | | | | | | | | |
|---|-------------|-------------------------|----------------|-------------|--------------------|----------------------|------------------|--------------------------|
| NO. | FREQ. (MHz) | EMISSION LEVEL (dBuV/m) | LIMIT (dBuV/m) | MARGIN (dB) | ANTENNA HEIGHT (m) | TABLE ANGLE (Degree) | RAW VALUE (dBuV) | CORRECTION FACTOR (dB/m) |
| 1 | 5150.00 | 58.4 PK | 74.0 | -15.6 | 1.08 H | 182 | 21.70 | 36.70 |
| 2 | 5150.00 | 42.3 AV | 54.0 | -11.7 | 1.08 H | 182 | 5.60 | 36.70 |
| 3 | *5180.00 | 106.3 PK | | | 1.06 H | 172 | 69.50 | 36.80 |
| 4 | *5180.00 | 92.4 AV | | | 1.06 H | 172 | 55.60 | 36.80 |
| 5 | #10360.00 | 58.2 PK | 68.3 | -10.1 | 1.00 H | 10 | 10.30 | 47.90 |
| ANTENNA POLARITY & TEST DISTANCE: VERTICAL AT 3 M | | | | | | | | |
| NO. | FREQ. (MHz) | EMISSION LEVEL (dBuV/m) | LIMIT (dBuV/m) | MARGIN (dB) | ANTENNA HEIGHT (m) | TABLE ANGLE (Degree) | RAW VALUE (dBuV) | CORRECTION FACTOR (dB/m) |
| 1 | 5150.00 | 61.7 PK | 74.0 | -12.3 | 1.06 V | 118 | 25.00 | 36.70 |
| 2 | 5150.00 | 42.7 AV | 54.0 | -11.3 | 1.06 V | 118 | 6.00 | 36.70 |
| 3 | *5180.00 | 108.6 PK | | | 1.31 V | 118 | 71.80 | 36.80 |
| 4 | *5180.00 | 94.3 AV | | | 1.31 V | 118 | 57.50 | 36.80 |
| 5 | #10360.00 | 58.0 PK | 68.3 | -10.3 | 1.03 V | 360 | 10.10 | 47.90 |

- REMARKS:**
1. Emission level (dBuV/m) = Raw Value (dBuV) + Correction Factor (dB/m).
 2. Correction Factor (dB/m) = Antenna Factor (dB/m) + Cable Factor (dB).
 3. The other emission levels were very low against the limit.
 4. Margin value = Emission level – Limit value.
 5. “ * “: Fundamental frequency.
 6. “#”:The radiated frequency is out the restricted band.



A D T

| EUT TEST CONDITION | | MEASUREMENT DETAIL | |
|--------------------------|-----------------------------|--------------------|---------------------------|
| CHANNEL | Channel 40 | FREQUENCY RANGE | 1 ~ 40GHz |
| INPUT POWER (SYSTEM) | 120Vac, 60 Hz | DETECTOR FUNCTION | Peak (PK) Average (AV) |
| ENVIRONMENTAL CONDITIONS | 23deg. C, 65%RH 1011 hPa | TESTED BY | Brad Wu |

| ANTENNA POLARITY & TEST DISTANCE: HORIZONTAL AT 3 M | | | | | | | | |
|---|-------------|-------------------------|----------------|-------------|--------------------|----------------------|------------------|--------------------------|
| NO. | FREQ. (MHz) | EMISSION LEVEL (dBuV/m) | LIMIT (dBuV/m) | MARGIN (dB) | ANTENNA HEIGHT (m) | TABLE ANGLE (Degree) | RAW VALUE (dBuV) | CORRECTION FACTOR (dB/m) |
| 1 | *5200.00 | 106.7 PK | | | 1.07 H | 154 | 69.90 | 36.80 |
| 2 | *5200.00 | 92.6 AV | | | 1.07 H | 154 | 55.80 | 36.80 |
| 3 | #10400.00 | 58.6 PK | 68.3 | -9.7 | 1.03 H | 350 | 10.50 | 48.10 |
| ANTENNA POLARITY & TEST DISTANCE: VERTICAL AT 3 M | | | | | | | | |
| NO. | FREQ. (MHz) | EMISSION LEVEL (dBuV/m) | LIMIT (dBuV/m) | MARGIN (dB) | ANTENNA HEIGHT (m) | TABLE ANGLE (Degree) | RAW VALUE (dBuV) | CORRECTION FACTOR (dB/m) |
| 1 | *5200.00 | 109.3 PK | | | 1.00 V | 149 | 72.50 | 36.80 |
| 2 | *5200.00 | 96.0 AV | | | 1.00 V | 149 | 59.20 | 36.80 |
| 3 | #10400.00 | 57.8 PK | 68.3 | -10.5 | 1.00 V | 360 | 9.70 | 48.10 |

- REMARKS:**
1. Emission level (dBuV/m) = Raw Value (dBuV) + Correction Factor (dB/m).
 2. Correction Factor (dB/m) = Antenna Factor (dB/m) + Cable Factor (dB).
 3. The other emission levels were very low against the limit.
 4. Margin value = Emission level – Limit value.
 5. “ * “: Fundamental frequency.
 6. “#”: The radiated frequency is out the restricted band.



A D T

| EUT TEST CONDITION | | MEASUREMENT DETAIL | |
|--------------------------|-----------------------------|--------------------|---------------------------|
| CHANNEL | Channel 48 | FREQUENCY RANGE | 1 ~ 40GHz |
| INPUT POWER (SYSTEM) | 120Vac, 60 Hz | DETECTOR FUNCTION | Peak (PK) Average (AV) |
| ENVIRONMENTAL CONDITIONS | 23deg. C, 65%RH 1011 hPa | TESTED BY | Brad Wu |

| ANTENNA POLARITY & TEST DISTANCE: HORIZONTAL AT 3 M | | | | | | | | |
|---|-------------|-------------------------|----------------|-------------|--------------------|----------------------|------------------|--------------------------|
| NO. | FREQ. (MHz) | EMISSION LEVEL (dBuV/m) | LIMIT (dBuV/m) | MARGIN (dB) | ANTENNA HEIGHT (m) | TABLE ANGLE (Degree) | RAW VALUE (dBuV) | CORRECTION FACTOR (dB/m) |
| 1 | *5240.00 | 106.1 PK | | | 1.06 H | 153 | 69.20 | 36.90 |
| 2 | *5240.00 | 91.8 AV | | | 1.06 H | 153 | 54.90 | 36.90 |
| 3 | #10480.00 | 58.1 PK | 68.3 | -10.2 | 1.03 H | 333 | 9.80 | 48.30 |
| ANTENNA POLARITY & TEST DISTANCE: VERTICAL AT 3 M | | | | | | | | |
| NO. | FREQ. (MHz) | EMISSION LEVEL (dBuV/m) | LIMIT (dBuV/m) | MARGIN (dB) | ANTENNA HEIGHT (m) | TABLE ANGLE (Degree) | RAW VALUE (dBuV) | CORRECTION FACTOR (dB/m) |
| 1 | *5240.00 | 108.0 PK | | | 1.00 V | 165 | 71.10 | 36.90 |
| 2 | *5240.00 | 94.1 AV | | | 1.00 V | 165 | 57.20 | 36.90 |
| 3 | #10480.00 | 58.6 PK | 68.3 | -9.7 | 1.00 V | 10 | 10.30 | 48.30 |

- REMARKS:**
1. Emission level (dBuV/m) = Raw Value (dBuV) + Correction Factor (dB/m).
 2. Correction Factor (dB/m) = Antenna Factor (dB/m) + Cable Factor (dB).
 3. The other emission levels were very low against the limit.
 4. Margin value = Emission level – Limit value.
 5. “ * ”: Fundamental frequency.
 6. “ # ”: The radiated frequency is out the restricted band.



A D T

| EUT TEST CONDITION | | MEASUREMENT DETAIL | |
|--------------------------|-----------------------------|--------------------|---------------------------|
| CHANNEL | Channel 52 | FREQUENCY RANGE | 1 ~ 40GHz |
| INPUT POWER (SYSTEM) | 120Vac, 60 Hz | DETECTOR FUNCTION | Peak (PK) Average (AV) |
| ENVIRONMENTAL CONDITIONS | 23deg. C, 65%RH 1011 hPa | TESTED BY | Brad Wu |

| ANTENNA POLARITY & TEST DISTANCE: HORIZONTAL AT 3 M | | | | | | | | |
|---|-------------|-------------------------|----------------|-------------|--------------------|----------------------|------------------|--------------------------|
| NO. | FREQ. (MHz) | EMISSION LEVEL (dBuV/m) | LIMIT (dBuV/m) | MARGIN (dB) | ANTENNA HEIGHT (m) | TABLE ANGLE (Degree) | RAW VALUE (dBuV) | CORRECTION FACTOR (dB/m) |
| 1 | *5260.00 | 106.1 PK | | | 1.04 H | 151 | 69.10 | 37.00 |
| 2 | *5260.00 | 92.7 AV | | | 1.04 H | 151 | 55.70 | 37.00 |
| 3 | #10520.00 | 58.4 PK | 68.3 | -9.9 | 1.04 H | 360 | 10.00 | 48.40 |
| ANTENNA POLARITY & TEST DISTANCE: VERTICAL AT 3 M | | | | | | | | |
| NO. | FREQ. (MHz) | EMISSION LEVEL (dBuV/m) | LIMIT (dBuV/m) | MARGIN (dB) | ANTENNA HEIGHT (m) | TABLE ANGLE (Degree) | RAW VALUE (dBuV) | CORRECTION FACTOR (dB/m) |
| 1 | *5260.00 | 108.7 PK | | | 1.00 V | 154 | 71.70 | 37.00 |
| 2 | *5260.00 | 94.5 AV | | | 1.00 V | 154 | 57.50 | 37.00 |
| 3 | #10520.00 | 58.4 PK | 68.3 | -9.9 | 1.00 V | 180 | 10.00 | 48.40 |

- REMARKS:**
1. Emission level (dBuV/m) = Raw Value (dBuV) + Correction Factor (dB/m).
 2. Correction Factor (dB/m) = Antenna Factor (dB/m) + Cable Factor (dB).
 3. The other emission levels were very low against the limit.
 4. Margin value = Emission level – Limit value.
 5. “ * “: Fundamental frequency.
 6. “#”: The radiated frequency is out the restricted band.



A D T

| EUT TEST CONDITION | | MEASUREMENT DETAIL | |
|--------------------------|-----------------------------|--------------------|---------------------------|
| CHANNEL | Channel 60 | FREQUENCY RANGE | 1 ~ 40GHz |
| INPUT POWER (SYSTEM) | 120Vac, 60 Hz | DETECTOR FUNCTION | Peak (PK) Average (AV) |
| ENVIRONMENTAL CONDITIONS | 23deg. C, 65%RH 1011 hPa | TESTED BY | Brad Wu |

| ANTENNA POLARITY & TEST DISTANCE: HORIZONTAL AT 3 M | | | | | | | | |
|---|-------------|-------------------------|----------------|-------------|--------------------|----------------------|------------------|--------------------------|
| NO. | FREQ. (MHz) | EMISSION LEVEL (dBuV/m) | LIMIT (dBuV/m) | MARGIN (dB) | ANTENNA HEIGHT (m) | TABLE ANGLE (Degree) | RAW VALUE (dBuV) | CORRECTION FACTOR (dB/m) |
| 1 | *5300.00 | 106.2 PK | | | 1.05 H | 149 | 69.10 | 37.10 |
| 2 | *5300.00 | 92.2 AV | | | 1.05 H | 149 | 55.10 | 37.10 |
| 3 | 10600.00 | 59.1 PK | 74.0 | -14.9 | 1.05 H | 180 | 10.50 | 48.60 |
| 4 | 10600.00 | 46.0 AV | 54.0 | -8.0 | 1.05 H | 180 | -2.60 | 48.60 |
| ANTENNA POLARITY & TEST DISTANCE: VERTICAL AT 3 M | | | | | | | | |
| NO. | FREQ. (MHz) | EMISSION LEVEL (dBuV/m) | LIMIT (dBuV/m) | MARGIN (dB) | ANTENNA HEIGHT (m) | TABLE ANGLE (Degree) | RAW VALUE (dBuV) | CORRECTION FACTOR (dB/m) |
| 1 | *5300.00 | 108.8 PK | | | 1.08 V | 145 | 71.70 | 37.10 |
| 2 | *5300.00 | 94.5 AV | | | 1.08 V | 145 | 57.40 | 37.10 |
| 3 | 10600.00 | 58.9 PK | 74.0 | -15.1 | 1.08 V | 180 | 10.30 | 48.60 |
| 4 | 10600.00 | 45.6 AV | 54.0 | -8.4 | 1.08 V | 180 | -3.00 | 48.60 |

- REMARKS:**
1. Emission level (dBuV/m) = Raw Value (dBuV) + Correction Factor (dB/m).
 2. Correction Factor (dB/m) = Antenna Factor (dB/m) + Cable Factor (dB).
 3. The other emission levels were very low against the limit.
 4. Margin value = Emission level – Limit value.
 5. “ * “: Fundamental frequency.



A D T

| EUT TEST CONDITION | | MEASUREMENT DETAIL | |
|--------------------------|-----------------------------|--------------------|---------------------------|
| CHANNEL | Channel 64 | FREQUENCY RANGE | 1 ~ 40GHz |
| INPUT POWER (SYSTEM) | 120Vac, 60 Hz | DETECTOR FUNCTION | Peak (PK) Average (AV) |
| ENVIRONMENTAL CONDITIONS | 23deg. C, 65%RH 1011 hPa | TESTED BY | Brad Wu |

| ANTENNA POLARITY & TEST DISTANCE: HORIZONTAL AT 3 M | | | | | | | | |
|---|-------------|-------------------------|----------------|-------------|--------------------|----------------------|------------------|--------------------------|
| NO. | FREQ. (MHz) | EMISSION LEVEL (dBuV/m) | LIMIT (dBuV/m) | MARGIN (dB) | ANTENNA HEIGHT (m) | TABLE ANGLE (Degree) | RAW VALUE (dBuV) | CORRECTION FACTOR (dB/m) |
| 1 | *5320.00 | 106.5 PK | | | 1.05 H | 149 | 69.30 | 37.20 |
| 2 | *5320.00 | 92.3 AV | | | 1.05 H | 149 | 55.10 | 37.20 |
| 3 | 5350.00 | 61.7 PK | 74.0 | -12.3 | 1.03 H | 148 | 24.50 | 37.20 |
| 4 | 5350.00 | 40.1 AV | 54.0 | -13.9 | 1.03 H | 148 | 2.90 | 37.20 |
| 5 | 10640.00 | 58.9 PK | 74.0 | -15.1 | 1.00 H | 0 | 10.30 | 48.60 |
| 6 | 10640.00 | 46.0 AV | 54.0 | -8.0 | 1.00 H | 0 | -2.60 | 48.60 |
| ANTENNA POLARITY & TEST DISTANCE: VERTICAL AT 3 M | | | | | | | | |
| NO. | FREQ. (MHz) | EMISSION LEVEL (dBuV/m) | LIMIT (dBuV/m) | MARGIN (dB) | ANTENNA HEIGHT (m) | TABLE ANGLE (Degree) | RAW VALUE (dBuV) | CORRECTION FACTOR (dB/m) |
| 1 | *5320.00 | 109.5 PK | | | 1.07 V | 150 | 72.30 | 37.20 |
| 2 | *5320.00 | 95.6 AV | | | 1.07 V | 150 | 58.40 | 37.20 |
| 3 | 5350.00 | 66.5 PK | 74.0 | -7.5 | 1.06 V | 147 | 29.30 | 37.20 |
| 4 | 5350.00 | 43.8 AV | 54.0 | -10.2 | 1.06 V | 147 | 6.60 | 37.20 |
| 5 | 10640.00 | 58.7 PK | 74.0 | -15.3 | 1.06 V | 180 | 10.10 | 48.60 |
| 6 | 10640.00 | 45.7 AV | 54.0 | -8.3 | 1.06 V | 180 | -2.90 | 48.60 |

- REMARKS:**
1. Emission level (dBuV/m) = Raw Value (dBuV) + Correction Factor (dB/m).
 2. Correction Factor (dB/m) = Antenna Factor (dB/m) + Cable Factor (dB).
 3. The other emission levels were very low against the limit.
 4. Margin value = Emission level – Limit value.
 5. “ * “: Fundamental frequency.



A D T

| EUT TEST CONDITION | | MEASUREMENT DETAIL | |
|--------------------------|-----------------------------|--------------------|---------------------------|
| CHANNEL | Channel 100 | FREQUENCY RANGE | 1 ~ 40GHz |
| INPUT POWER (SYSTEM) | 120Vac, 60 Hz | DETECTOR FUNCTION | Peak (PK) Average (AV) |
| ENVIRONMENTAL CONDITIONS | 23deg. C, 65%RH 1011 hPa | TESTED BY | Brad Wu |

| ANTENNA POLARITY & TEST DISTANCE: HORIZONTAL AT 3 M | | | | | | | | |
|---|-------------|-------------------------|----------------|-------------|--------------------|----------------------|------------------|--------------------------|
| NO. | FREQ. (MHz) | EMISSION LEVEL (dBuV/m) | LIMIT (dBuV/m) | MARGIN (dB) | ANTENNA HEIGHT (m) | TABLE ANGLE (Degree) | RAW VALUE (dBuV) | CORRECTION FACTOR (dB/m) |
| 1 | 5460.00 | 48.9 PK | 74.0 | -25.1 | 1.00 H | 126 | 11.60 | 37.30 |
| 2 | 5460.00 | 38.0 AV | 54.0 | -16.0 | 1.00 H | 126 | 0.70 | 37.30 |
| 3 | #5470.00 | 63.5 PK | 68.3 | -4.8 | 1.00 H | 126 | 26.10 | 37.40 |
| 4 | *5500.00 | 103.8 PK | | | 1.00 H | 127 | 66.40 | 37.40 |
| 5 | *5500.00 | 90.0 AV | | | 1.00 H | 127 | 52.60 | 37.40 |
| 6 | 11000.00 | 59.3 PK | 74.0 | -14.7 | 1.10 H | 350 | 10.60 | 48.70 |
| 7 | 11000.00 | 46.3 AV | 54.0 | -7.7 | 1.10 H | 350 | -2.40 | 48.70 |
| ANTENNA POLARITY & TEST DISTANCE: VERTICAL AT 3 M | | | | | | | | |
| NO. | FREQ. (MHz) | EMISSION LEVEL (dBuV/m) | LIMIT (dBuV/m) | MARGIN (dB) | ANTENNA HEIGHT (m) | TABLE ANGLE (Degree) | RAW VALUE (dBuV) | CORRECTION FACTOR (dB/m) |
| 1 | 5460.00 | 53.6 PK | 74.0 | -20.4 | 1.09 V | 164 | 16.30 | 37.30 |
| 2 | 5460.00 | 39.1 AV | 54.0 | -14.9 | 1.09 V | 164 | 1.80 | 37.30 |
| 3 | #5470.00 | 65.4 PK | 68.3 | -2.9 | 1.09 V | 164 | 28.00 | 37.40 |
| 4 | *5500.00 | 109.3 PK | | | 1.08 V | 185 | 71.90 | 37.40 |
| 5 | *5500.00 | 95.4 AV | | | 1.08 V | 185 | 58.00 | 37.40 |
| 6 | 11000.00 | 59.7 PK | 74.0 | -14.3 | 1.08 V | 200 | 11.00 | 48.70 |
| 7 | 11000.00 | 46.6 AV | 54.0 | -7.4 | 1.08 V | 200 | -2.10 | 48.70 |

- REMARKS:**
1. Emission level (dBuV/m) = Raw Value (dBuV) + Correction Factor (dB/m).
 2. Correction Factor (dB/m) = Antenna Factor (dB/m) + Cable Factor (dB).
 3. The other emission levels were very low against the limit.
 4. Margin value = Emission level – Limit value.
 5. “ * “: Fundamental frequency.
 6. “#“: The radiated frequency is out the restricted band.



A D T

| EUT TEST CONDITION | | MEASUREMENT DETAIL | |
|--------------------------|-----------------------------|--------------------|---------------------------|
| CHANNEL | Channel 116 | FREQUENCY RANGE | 1 ~ 40GHz |
| INPUT POWER (SYSTEM) | 120Vac, 60 Hz | DETECTOR FUNCTION | Peak (PK) Average (AV) |
| ENVIRONMENTAL CONDITIONS | 23deg. C, 65%RH 1011 hPa | TESTED BY | Brad Wu |

| ANTENNA POLARITY & TEST DISTANCE: HORIZONTAL AT 3 M | | | | | | | | |
|---|-------------|-------------------------|----------------|-------------|--------------------|----------------------|------------------|--------------------------|
| NO. | FREQ. (MHz) | EMISSION LEVEL (dBuV/m) | LIMIT (dBuV/m) | MARGIN (dB) | ANTENNA HEIGHT (m) | TABLE ANGLE (Degree) | RAW VALUE (dBuV) | CORRECTION FACTOR (dB/m) |
| 1 | *5580.00 | 103.6 PK | | | 1.01 H | 125 | 66.00 | 37.60 |
| 2 | *5580.00 | 89.8 AV | | | 1.01 H | 125 | 52.20 | 37.60 |
| 3 | 11160.00 | 59.0 PK | 74.0 | -15.0 | 1.13 H | 24 | 10.60 | 48.40 |
| 4 | 11160.00 | 45.8 AV | 54.0 | -8.2 | 1.13 H | 24 | -2.60 | 48.40 |
| ANTENNA POLARITY & TEST DISTANCE: VERTICAL AT 3 M | | | | | | | | |
| NO. | FREQ. (MHz) | EMISSION LEVEL (dBuV/m) | LIMIT (dBuV/m) | MARGIN (dB) | ANTENNA HEIGHT (m) | TABLE ANGLE (Degree) | RAW VALUE (dBuV) | CORRECTION FACTOR (dB/m) |
| 1 | *5580.00 | 108.5 PK | | | 1.04 V | 1 | 70.90 | 37.60 |
| 2 | *5580.00 | 95.3 AV | | | 1.04 V | 1 | 57.70 | 37.60 |
| 3 | 11160.00 | 59.5 PK | 74.0 | -14.5 | 1.01 V | 159 | 11.10 | 48.40 |
| 4 | 11160.00 | 46.3 AV | 54.0 | -7.7 | 1.01 V | 159 | -2.10 | 48.40 |

- REMARKS:**
1. Emission level (dBuV/m) = Raw Value (dBuV) + Correction Factor (dB/m).
 2. Correction Factor (dB/m) = Antenna Factor (dB/m) + Cable Factor (dB).
 3. The other emission levels were very low against the limit.
 4. Margin value = Emission level – Limit value.
 5. “ * “: Fundamental frequency.



A D T

| EUT TEST CONDITION | | MEASUREMENT DETAIL | |
|--------------------------|-----------------------------|--------------------|---------------------------|
| CHANNEL | Channel 132 | FREQUENCY RANGE | 1 ~ 40GHz |
| INPUT POWER (SYSTEM) | 120Vac, 60 Hz | DETECTOR FUNCTION | Peak (PK) Average (AV) |
| ENVIRONMENTAL CONDITIONS | 23deg. C, 65%RH 1011 hPa | TESTED BY | Brad Wu |

| ANTENNA POLARITY & TEST DISTANCE: HORIZONTAL AT 3 M | | | | | | | | |
|---|-------------|-------------------------|----------------|-------------|--------------------|----------------------|------------------|--------------------------|
| NO. | FREQ. (MHz) | EMISSION LEVEL (dBuV/m) | LIMIT (dBuV/m) | MARGIN (dB) | ANTENNA HEIGHT (m) | TABLE ANGLE (Degree) | RAW VALUE (dBuV) | CORRECTION FACTOR (dB/m) |
| 1 | *5660.00 | 103.9 PK | | | 1.03 H | 129 | 66.10 | 37.80 |
| 2 | *5660.00 | 90.1 AV | | | 1.03 H | 129 | 52.30 | 37.80 |
| 3 | 11320.00 | 59.2 PK | 74.0 | -14.8 | 1.09 H | 50 | 10.90 | 48.30 |
| 4 | 11320.00 | 46.0 AV | 54.0 | -8.0 | 1.09 H | 50 | -2.30 | 48.30 |
| ANTENNA POLARITY & TEST DISTANCE: VERTICAL AT 3 M | | | | | | | | |
| NO. | FREQ. (MHz) | EMISSION LEVEL (dBuV/m) | LIMIT (dBuV/m) | MARGIN (dB) | ANTENNA HEIGHT (m) | TABLE ANGLE (Degree) | RAW VALUE (dBuV) | CORRECTION FACTOR (dB/m) |
| 1 | *5660.00 | 108.8 PK | | | 1.05 V | 2 | 71.00 | 37.80 |
| 2 | *5660.00 | 95.5 AV | | | 1.05 V | 2 | 57.70 | 37.80 |
| 3 | 11320.00 | 59.9 PK | 74.0 | -14.1 | 1.02 V | 161 | 11.60 | 48.30 |
| 4 | 11320.00 | 46.8 AV | 54.0 | -7.2 | 1.02 V | 161 | -1.50 | 48.30 |

- REMARKS:**
1. Emission level (dBuV/m) = Raw Value (dBuV) + Correction Factor (dB/m).
 2. Correction Factor (dB/m) = Antenna Factor (dB/m) + Cable Factor (dB).
 3. The other emission levels were very low against the limit.
 4. Margin value = Emission level – Limit value.
 5. “ * “: Fundamental frequency.



A D T

| EUT TEST CONDITION | | MEASUREMENT DETAIL | |
|--------------------------|-----------------------------|--------------------|---------------------------|
| CHANNEL | Channel 140 | FREQUENCY RANGE | 1 ~ 40GHz |
| INPUT POWER (SYSTEM) | 120Vac, 60 Hz | DETECTOR FUNCTION | Peak (PK) Average (AV) |
| ENVIRONMENTAL CONDITIONS | 23deg. C, 65%RH 1011 hPa | TESTED BY | Brad Wu |

| ANTENNA POLARITY & TEST DISTANCE: HORIZONTAL AT 3 M | | | | | | | | |
|---|-------------|-------------------------|----------------|-------------|--------------------|----------------------|------------------|--------------------------|
| NO. | FREQ. (MHz) | EMISSION LEVEL (dBuV/m) | LIMIT (dBuV/m) | MARGIN (dB) | ANTENNA HEIGHT (m) | TABLE ANGLE (Degree) | RAW VALUE (dBuV) | CORRECTION FACTOR (dB/m) |
| 1 | *5700.00 | 103.4 PK | | | 1.04 H | 130 | 65.50 | 37.90 |
| 2 | *5700.00 | 89.6 AV | | | 1.04 H | 130 | 51.70 | 37.90 |
| 3 | #5725.00 | 63.8 PK | 68.3 | -4.5 | 1.04 H | 130 | 25.80 | 38.00 |
| 4 | 11400.00 | 58.6 PK | 74.0 | -15.4 | 1.14 H | 23 | 10.60 | 48.00 |
| 5 | 11400.00 | 45.5 AV | 54.0 | -8.5 | 1.14 H | 23 | -2.50 | 48.00 |
| ANTENNA POLARITY & TEST DISTANCE: VERTICAL AT 3 M | | | | | | | | |
| NO. | FREQ. (MHz) | EMISSION LEVEL (dBuV/m) | LIMIT (dBuV/m) | MARGIN (dB) | ANTENNA HEIGHT (m) | TABLE ANGLE (Degree) | RAW VALUE (dBuV) | CORRECTION FACTOR (dB/m) |
| 1 | *5700.00 | 108.7 PK | | | 1.02 V | 1 | 70.80 | 37.90 |
| 2 | *5700.00 | 95.4 AV | | | 1.02 V | 1 | 57.50 | 37.90 |
| 3 | #5725.00 | 67.2 PK | 68.3 | -1.1 | 1.02 V | 1 | 29.20 | 38.00 |
| 4 | 11400.00 | 59.2 PK | 74.0 | -14.8 | 1.15 V | 148 | 11.20 | 48.00 |
| 5 | 11400.00 | 46.1 AV | 54.0 | -7.9 | 1.15 V | 148 | -1.90 | 48.00 |

- REMARKS:**
1. Emission level (dBuV/m) = Raw Value (dBuV) + Correction Factor (dB/m).
 2. Correction Factor (dB/m) = Antenna Factor (dB/m) + Cable Factor (dB).
 3. The other emission levels were very low against the limit.
 4. Margin value = Emission level – Limit value.
 5. “ * “: Fundamental frequency.
 6. "#":The radiated frequency is out the restricted band.



802.11n (20MHz)

| EUT TEST CONDITION | | MEASUREMENT DETAIL | |
|--------------------------|-----------------------------|--------------------|---------------------------|
| CHANNEL | Channel 36 | FREQUENCY RANGE | 1 ~ 40GHz |
| INPUT POWER (SYSTEM) | 120Vac, 60 Hz | DETECTOR FUNCTION | Peak (PK) Average (AV) |
| ENVIRONMENTAL CONDITIONS | 23deg. C, 65%RH 1011 hPa | TESTED BY | Brad Wu |

| ANTENNA POLARITY & TEST DISTANCE: HORIZONTAL AT 3 M | | | | | | | | |
|---|-------------|-------------------------|----------------|-------------|--------------------|----------------------|------------------|--------------------------|
| NO. | FREQ. (MHz) | EMISSION LEVEL (dBuV/m) | LIMIT (dBuV/m) | MARGIN (dB) | ANTENNA HEIGHT (m) | TABLE ANGLE (Degree) | RAW VALUE (dBuV) | CORRECTION FACTOR (dB/m) |
| 1 | 5150.00 | 56.2 PK | 74.0 | -17.8 | 1.06 H | 2 | 19.50 | 36.70 |
| 2 | 5150.00 | 38.5 AV | 54.0 | -15.5 | 1.06 H | 2 | 1.80 | 36.70 |
| 3 | *5180.00 | 105.6 PK | | | 1.06 H | 2 | 68.80 | 36.80 |
| 4 | *5180.00 | 89.2 AV | | | 1.06 H | 2 | 52.40 | 36.80 |
| 5 | #10360.00 | 57.8 PK | 68.3 | -10.5 | 1.04 H | 51 | 9.90 | 47.90 |
| ANTENNA POLARITY & TEST DISTANCE: VERTICAL AT 3 M | | | | | | | | |
| NO. | FREQ. (MHz) | EMISSION LEVEL (dBuV/m) | LIMIT (dBuV/m) | MARGIN (dB) | ANTENNA HEIGHT (m) | TABLE ANGLE (Degree) | RAW VALUE (dBuV) | CORRECTION FACTOR (dB/m) |
| 1 | 5150.00 | 59.5 PK | 74.0 | -14.5 | 1.00 V | 25 | 22.80 | 36.70 |
| 2 | 5150.00 | 41.8 AV | 54.0 | -12.2 | 1.00 V | 25 | 5.10 | 36.70 |
| 3 | *5180.00 | 107.8 PK | | | 1.00 V | 25 | 71.00 | 36.80 |
| 4 | *5180.00 | 91.1 AV | | | 1.00 V | 25 | 54.30 | 36.80 |
| 5 | #10360.00 | 58.2 PK | 68.3 | -10.1 | 1.01 V | 29 | 10.30 | 47.90 |

- REMARKS:**
1. Emission level (dBuV/m) = Raw Value (dBuV) + Correction Factor (dB/m).
 2. Correction Factor (dB/m) = Antenna Factor (dB/m) + Cable Factor (dB).
 3. The other emission levels were very low against the limit.
 4. Margin value = Emission level – Limit value.
 5. “ * “: Fundamental frequency.
 6. “#”: The radiated frequency is out the restricted band.



A D T

| EUT TEST CONDITION | | MEASUREMENT DETAIL | |
|--------------------------|-----------------------------|--------------------|---------------------------|
| CHANNEL | Channel 40 | FREQUENCY RANGE | 1 ~ 40GHz |
| INPUT POWER (SYSTEM) | 120Vac, 60 Hz | DETECTOR FUNCTION | Peak (PK) Average (AV) |
| ENVIRONMENTAL CONDITIONS | 23deg. C, 65%RH 1011 hPa | TESTED BY | Brad Wu |

| ANTENNA POLARITY & TEST DISTANCE: HORIZONTAL AT 3 M | | | | | | | | |
|---|-------------|-------------------------|----------------|-------------|--------------------|----------------------|------------------|--------------------------|
| NO. | FREQ. (MHz) | EMISSION LEVEL (dBuV/m) | LIMIT (dBuV/m) | MARGIN (dB) | ANTENNA HEIGHT (m) | TABLE ANGLE (Degree) | RAW VALUE (dBuV) | CORRECTION FACTOR (dB/m) |
| 1 | *5200.00 | 105.3 PK | | | 1.05 H | 3 | 68.50 | 36.80 |
| 2 | *5200.00 | 88.9 AV | | | 1.05 H | 3 | 52.10 | 36.80 |
| 3 | #10400.00 | 58.0 PK | 68.3 | -10.3 | 1.01 H | 216 | 9.90 | 48.10 |
| ANTENNA POLARITY & TEST DISTANCE: VERTICAL AT 3 M | | | | | | | | |
| NO. | FREQ. (MHz) | EMISSION LEVEL (dBuV/m) | LIMIT (dBuV/m) | MARGIN (dB) | ANTENNA HEIGHT (m) | TABLE ANGLE (Degree) | RAW VALUE (dBuV) | CORRECTION FACTOR (dB/m) |
| 1 | *5200.00 | 107.6 PK | | | 1.09 V | 9 | 70.80 | 36.80 |
| 2 | *5200.00 | 90.9 AV | | | 1.09 V | 9 | 54.10 | 36.80 |
| 3 | #10400.00 | 58.5 PK | 68.3 | -9.8 | 1.03 V | 34 | 10.40 | 48.10 |

- REMARKS:**
1. Emission level (dBuV/m) = Raw Value (dBuV) + Correction Factor (dB/m).
 2. Correction Factor (dB/m) = Antenna Factor (dB/m) + Cable Factor (dB).
 3. The other emission levels were very low against the limit.
 4. Margin value = Emission level – Limit value.
 5. “ * ”: Fundamental frequency.
 6. “#” :The radiated frequency is out the restricted band.



A D T

| EUT TEST CONDITION | | MEASUREMENT DETAIL | |
|--------------------------|-----------------------------|--------------------|---------------------------|
| CHANNEL | Channel 48 | FREQUENCY RANGE | 1 ~ 40GHz |
| INPUT POWER (SYSTEM) | 120Vac, 60 Hz | DETECTOR FUNCTION | Peak (PK) Average (AV) |
| ENVIRONMENTAL CONDITIONS | 23deg. C, 65%RH 1011 hPa | TESTED BY | Brad Wu |

| ANTENNA POLARITY & TEST DISTANCE: HORIZONTAL AT 3 M | | | | | | | | |
|---|-------------|-------------------------|----------------|-------------|--------------------|----------------------|------------------|--------------------------|
| NO. | FREQ. (MHz) | EMISSION LEVEL (dBuV/m) | LIMIT (dBuV/m) | MARGIN (dB) | ANTENNA HEIGHT (m) | TABLE ANGLE (Degree) | RAW VALUE (dBuV) | CORRECTION FACTOR (dB/m) |
| 1 | *5240.00 | 105.6 PK | | | 1.04 H | 11 | 68.70 | 36.90 |
| 2 | *5240.00 | 89.2 AV | | | 1.04 H | 11 | 52.30 | 36.90 |
| 3 | #10480.00 | 58.3 PK | 68.3 | -10.0 | 1.14 H | 25 | 10.00 | 48.30 |
| ANTENNA POLARITY & TEST DISTANCE: VERTICAL AT 3 M | | | | | | | | |
| NO. | FREQ. (MHz) | EMISSION LEVEL (dBuV/m) | LIMIT (dBuV/m) | MARGIN (dB) | ANTENNA HEIGHT (m) | TABLE ANGLE (Degree) | RAW VALUE (dBuV) | CORRECTION FACTOR (dB/m) |
| 1 | *5240.00 | 108.0 PK | | | 1.08 V | 8 | 71.10 | 36.90 |
| 2 | *5240.00 | 91.2 AV | | | 1.08 V | 8 | 54.30 | 36.90 |
| 3 | #10480.00 | 58.8 PK | 68.3 | -9.5 | 1.14 V | 23 | 10.50 | 48.30 |

- REMARKS:**
1. Emission level (dBuV/m) = Raw Value (dBuV) + Correction Factor (dB/m).
 2. Correction Factor (dB/m) = Antenna Factor (dB/m) + Cable Factor (dB).
 3. The other emission levels were very low against the limit.
 4. Margin value = Emission level – Limit value.
 5. “ * “: Fundamental frequency.
 6. “#”: The radiated frequency is out the restricted band.



A D T

| EUT TEST CONDITION | | MEASUREMENT DETAIL | |
|--------------------------|-----------------------------|--------------------|---------------------------|
| CHANNEL | Channel 52 | FREQUENCY RANGE | 1 ~ 40GHz |
| INPUT POWER (SYSTEM) | 120Vac, 60 Hz | DETECTOR FUNCTION | Peak (PK) Average (AV) |
| ENVIRONMENTAL CONDITIONS | 23deg. C, 65%RH 1011 hPa | TESTED BY | Brad Wu |

| ANTENNA POLARITY & TEST DISTANCE: HORIZONTAL AT 3 M | | | | | | | | |
|---|-------------|-------------------------|----------------|-------------|--------------------|----------------------|------------------|--------------------------|
| NO. | FREQ. (MHz) | EMISSION LEVEL (dBuV/m) | LIMIT (dBuV/m) | MARGIN (dB) | ANTENNA HEIGHT (m) | TABLE ANGLE (Degree) | RAW VALUE (dBuV) | CORRECTION FACTOR (dB/m) |
| 1 | *5260.00 | 105.8 PK | | | 1.06 H | 21 | 68.80 | 37.00 |
| 2 | *5260.00 | 89.4 AV | | | 1.06 H | 21 | 52.40 | 37.00 |
| 3 | #10520.00 | 58.1 PK | 68.3 | -10.2 | 1.11 H | 22 | 9.70 | 48.40 |
| ANTENNA POLARITY & TEST DISTANCE: VERTICAL AT 3 M | | | | | | | | |
| NO. | FREQ. (MHz) | EMISSION LEVEL (dBuV/m) | LIMIT (dBuV/m) | MARGIN (dB) | ANTENNA HEIGHT (m) | TABLE ANGLE (Degree) | RAW VALUE (dBuV) | CORRECTION FACTOR (dB/m) |
| 1 | *5260.00 | 108.3 PK | | | 1.10 V | 12 | 71.30 | 37.00 |
| 2 | *5260.00 | 91.5 AV | | | 1.10 V | 12 | 54.50 | 37.00 |
| 3 | #10520.00 | 58.6 PK | 68.3 | -9.7 | 1.02 V | 46 | 10.20 | 48.40 |

- REMARKS:**
1. Emission level (dBuV/m) = Raw Value (dBuV) + Correction Factor (dB/m).
 2. Correction Factor (dB/m) = Antenna Factor (dB/m) + Cable Factor (dB).
 3. The other emission levels were very low against the limit.
 4. Margin value = Emission level – Limit value.
 5. “ * “: Fundamental frequency.
 6. “#”: The radiated frequency is out the restricted band.



| EUT TEST CONDITION | | MEASUREMENT DETAIL | |
|--------------------------|-----------------------------|--------------------|---------------------------|
| CHANNEL | Channel 60 | FREQUENCY RANGE | 1 ~ 40GHz |
| INPUT POWER (SYSTEM) | 120Vac, 60 Hz | DETECTOR FUNCTION | Peak (PK) Average (AV) |
| ENVIRONMENTAL CONDITIONS | 23deg. C, 65%RH 1011 hPa | TESTED BY | Brad Wu |

| ANTENNA POLARITY & TEST DISTANCE: HORIZONTAL AT 3 M | | | | | | | | |
|---|-------------|-------------------------|----------------|-------------|--------------------|----------------------|------------------|--------------------------|
| NO. | FREQ. (MHz) | EMISSION LEVEL (dBuV/m) | LIMIT (dBuV/m) | MARGIN (dB) | ANTENNA HEIGHT (m) | TABLE ANGLE (Degree) | RAW VALUE (dBuV) | CORRECTION FACTOR (dB/m) |
| 1 | *5300.00 | 105.5 PK | | | 1.08 H | 25 | 68.40 | 37.10 |
| 2 | *5300.00 | 89.1 AV | | | 1.08 H | 25 | 52.00 | 37.10 |
| 3 | 10600.00 | 57.9 PK | 74.0 | -16.1 | 1.11 H | 36 | 9.30 | 48.60 |
| 4 | 10600.00 | 44.8 AV | 54.0 | -9.2 | 1.11 H | 36 | -3.80 | 48.60 |
| ANTENNA POLARITY & TEST DISTANCE: VERTICAL AT 3 M | | | | | | | | |
| NO. | FREQ. (MHz) | EMISSION LEVEL (dBuV/m) | LIMIT (dBuV/m) | MARGIN (dB) | ANTENNA HEIGHT (m) | TABLE ANGLE (Degree) | RAW VALUE (dBuV) | CORRECTION FACTOR (dB/m) |
| 1 | *5300.00 | 107.9 PK | | | 1.07 V | 19 | 70.80 | 37.10 |
| 2 | *5300.00 | 91.2 AV | | | 1.07 V | 19 | 54.10 | 37.10 |
| 3 | 10600.00 | 58.2 PK | 74.0 | -15.8 | 1.08 V | 224 | 9.60 | 48.60 |
| 4 | 10600.00 | 45.1 AV | 54.0 | -8.9 | 1.08 V | 224 | -3.50 | 48.60 |

- REMARKS:**
1. Emission level (dBuV/m) = Raw Value (dBuV) + Correction Factor (dB/m).
 2. Correction Factor (dB/m) = Antenna Factor (dB/m) + Cable Factor (dB).
 3. The other emission levels were very low against the limit.
 4. Margin value = Emission level – Limit value.
 5. “ * “: Fundamental frequency.



A D T

| EUT TEST CONDITION | | MEASUREMENT DETAIL | |
|--------------------------|-----------------------------|--------------------|---------------------------|
| CHANNEL | Channel 64 | FREQUENCY RANGE | 1 ~ 40GHz |
| INPUT POWER (SYSTEM) | 120Vac, 60 Hz | DETECTOR FUNCTION | Peak (PK) Average (AV) |
| ENVIRONMENTAL CONDITIONS | 23deg. C, 65%RH 1011 hPa | TESTED BY | Brad Wu |

| ANTENNA POLARITY & TEST DISTANCE: HORIZONTAL AT 3 M | | | | | | | | |
|---|-------------|-------------------------|----------------|-------------|--------------------|----------------------|------------------|--------------------------|
| NO. | FREQ. (MHz) | EMISSION LEVEL (dBuV/m) | LIMIT (dBuV/m) | MARGIN (dB) | ANTENNA HEIGHT (m) | TABLE ANGLE (Degree) | RAW VALUE (dBuV) | CORRECTION FACTOR (dB/m) |
| 1 | *5320.00 | 105.7 PK | | | 1.03 H | 15 | 68.50 | 37.20 |
| 2 | *5320.00 | 89.3 AV | | | 1.03 H | 15 | 52.10 | 37.20 |
| 3 | 5350.00 | 57.5 PK | 74.0 | -16.5 | 1.03 H | 15 | 20.30 | 37.20 |
| 4 | 5350.00 | 39.8 AV | 54.0 | -14.2 | 1.03 H | 15 | 2.60 | 37.20 |
| 5 | 10640.00 | 58.0 PK | 74.0 | -16.0 | 1.14 H | 23 | 9.40 | 48.60 |
| 6 | 10640.00 | 44.9 AV | 54.0 | -9.1 | 1.14 H | 23 | -3.70 | 48.60 |
| ANTENNA POLARITY & TEST DISTANCE: VERTICAL AT 3 M | | | | | | | | |
| NO. | FREQ. (MHz) | EMISSION LEVEL (dBuV/m) | LIMIT (dBuV/m) | MARGIN (dB) | ANTENNA HEIGHT (m) | TABLE ANGLE (Degree) | RAW VALUE (dBuV) | CORRECTION FACTOR (dB/m) |
| 1 | *5320.00 | 108.3 PK | | | 1.07 V | 8 | 71.10 | 37.20 |
| 2 | *5320.00 | 91.7 AV | | | 1.07 V | 8 | 54.50 | 37.20 |
| 3 | 5350.00 | 60.4 PK | 74.0 | -13.6 | 1.07 V | 8 | 23.20 | 37.20 |
| 4 | 5350.00 | 42.5 AV | 54.0 | -11.5 | 1.07 V | 8 | 5.30 | 37.20 |
| 5 | 10640.00 | 58.6 PK | 74.0 | -15.4 | 1.12 V | 36 | 10.00 | 48.60 |
| 6 | 10640.00 | 45.5 AV | 54.0 | -8.5 | 1.12 V | 36 | -3.10 | 48.60 |

- REMARKS:**
1. Emission level (dBuV/m) = Raw Value (dBuV) + Correction Factor (dB/m).
 2. Correction Factor (dB/m) = Antenna Factor (dB/m) + Cable Factor (dB).
 3. The other emission levels were very low against the limit.
 4. Margin value = Emission level – Limit value.
 5. “ * “: Fundamental frequency.



A D T

| EUT TEST CONDITION | | MEASUREMENT DETAIL | |
|--------------------------|-----------------------------|--------------------|---------------------------|
| CHANNEL | Channel 100 | FREQUENCY RANGE | 1 ~ 40GHz |
| INPUT POWER (SYSTEM) | 120Vac, 60 Hz | DETECTOR FUNCTION | Peak (PK) Average (AV) |
| ENVIRONMENTAL CONDITIONS | 23deg. C, 65%RH 1011 hPa | TESTED BY | Brad Wu |

| ANTENNA POLARITY & TEST DISTANCE: HORIZONTAL AT 3 M | | | | | | | | |
|---|-------------|-------------------------|----------------|-------------|--------------------|----------------------|------------------|--------------------------|
| NO. | FREQ. (MHz) | EMISSION LEVEL (dBuV/m) | LIMIT (dBuV/m) | MARGIN (dB) | ANTENNA HEIGHT (m) | TABLE ANGLE (Degree) | RAW VALUE (dBuV) | CORRECTION FACTOR (dB/m) |
| 1 | 5460.00 | 50.4 PK | 74.0 | -23.6 | 1.01 H | 16 | 13.10 | 37.30 |
| 2 | 5460.00 | 34.6 AV | 54.0 | -19.4 | 1.01 H | 16 | -2.70 | 37.30 |
| 3 | #5470.00 | 53.2 PK | 68.3 | -15.1 | 1.01 H | 16 | 15.80 | 37.40 |
| 4 | *5500.00 | 105.9 PK | | | 1.01 H | 16 | 68.50 | 37.40 |
| 5 | *5500.00 | 89.5 AV | | | 1.01 H | 16 | 52.10 | 37.40 |
| 6 | 11000.00 | 58.6 PK | 74.0 | -15.4 | 1.13 H | 24 | 9.90 | 48.70 |
| 7 | 11000.00 | 45.0 AV | 54.0 | -9.0 | 1.13 H | 24 | -3.70 | 48.70 |
| ANTENNA POLARITY & TEST DISTANCE: VERTICAL AT 3 M | | | | | | | | |
| NO. | FREQ. (MHz) | EMISSION LEVEL (dBuV/m) | LIMIT (dBuV/m) | MARGIN (dB) | ANTENNA HEIGHT (m) | TABLE ANGLE (Degree) | RAW VALUE (dBuV) | CORRECTION FACTOR (dB/m) |
| 1 | 5460.00 | 53.6 PK | 74.0 | -20.4 | 1.04 V | 21 | 16.30 | 37.30 |
| 2 | 5460.00 | 38.0 AV | 54.0 | -16.0 | 1.04 V | 21 | 0.70 | 37.30 |
| 3 | #5470.00 | 56.5 PK | 68.3 | -11.8 | 1.04 V | 21 | 19.10 | 37.40 |
| 4 | *5500.00 | 108.6 PK | | | 1.04 V | 21 | 71.20 | 37.40 |
| 5 | *5500.00 | 92.0 AV | | | 1.04 V | 21 | 54.60 | 37.40 |
| 6 | 11000.00 | 59.1 PK | 74.0 | -14.9 | 1.02 V | 324 | 10.40 | 48.70 |
| 7 | 11000.00 | 45.5 AV | 54.0 | -8.5 | 1.02 V | 324 | -3.20 | 48.70 |

- REMARKS:**
1. Emission level (dBuV/m) = Raw Value (dBuV) + Correction Factor (dB/m).
 2. Correction Factor (dB/m) = Antenna Factor (dB/m) + Cable Factor (dB).
 3. The other emission levels were very low against the limit.
 4. Margin value = Emission level – Limit value.
 5. “ * “: Fundamental frequency.
 6. “#”: The radiated frequency is out the restricted band.



A D T

| EUT TEST CONDITION | | MEASUREMENT DETAIL | |
|--------------------------|-----------------------------|--------------------|---------------------------|
| CHANNEL | Channel 116 | FREQUENCY RANGE | 1 ~ 40GHz |
| INPUT POWER (SYSTEM) | 120Vac, 60 Hz | DETECTOR FUNCTION | Peak (PK) Average (AV) |
| ENVIRONMENTAL CONDITIONS | 23deg. C, 65%RH 1011 hPa | TESTED BY | Brad Wu |

| ANTENNA POLARITY & TEST DISTANCE: HORIZONTAL AT 3 M | | | | | | | | |
|---|-------------|-------------------------|----------------|-------------|--------------------|----------------------|------------------|--------------------------|
| NO. | FREQ. (MHz) | EMISSION LEVEL (dBuV/m) | LIMIT (dBuV/m) | MARGIN (dB) | ANTENNA HEIGHT (m) | TABLE ANGLE (Degree) | RAW VALUE (dBuV) | CORRECTION FACTOR (dB/m) |
| 1 | *5580.00 | 105.4 PK | | | 1.02 H | 15 | 67.80 | 37.60 |
| 2 | *5580.00 | 89.0 AV | | | 1.02 H | 15 | 51.40 | 37.60 |
| 3 | 11160.00 | 58.9 PK | 74.0 | -15.1 | 1.10 H | 29 | 10.50 | 48.40 |
| 4 | 11160.00 | 45.3 AV | 54.0 | -8.7 | 1.10 H | 29 | -3.10 | 48.40 |
| ANTENNA POLARITY & TEST DISTANCE: VERTICAL AT 3 M | | | | | | | | |
| NO. | FREQ. (MHz) | EMISSION LEVEL (dBuV/m) | LIMIT (dBuV/m) | MARGIN (dB) | ANTENNA HEIGHT (m) | TABLE ANGLE (Degree) | RAW VALUE (dBuV) | CORRECTION FACTOR (dB/m) |
| 1 | *5580.00 | 108.1 PK | | | 1.05 V | 24 | 70.50 | 37.60 |
| 2 | *5580.00 | 91.5 AV | | | 1.05 V | 24 | 53.90 | 37.60 |
| 3 | 11160.00 | 59.4 PK | 74.0 | -14.6 | 1.05 V | 310 | 11.00 | 48.40 |
| 4 | 11160.00 | 45.8 AV | 54.0 | -8.2 | 1.05 V | 310 | -2.60 | 48.40 |

- REMARKS:**
1. Emission level (dBuV/m) = Raw Value (dBuV) + Correction Factor (dB/m).
 2. Correction Factor (dB/m) = Antenna Factor (dB/m) + Cable Factor (dB).
 3. The other emission levels were very low against the limit.
 4. Margin value = Emission level – Limit value.
 5. “ * “: Fundamental frequency.



A D T

| EUT TEST CONDITION | | MEASUREMENT DETAIL | |
|--------------------------|-----------------------------|--------------------|---------------------------|
| CHANNEL | Channel 132 | FREQUENCY RANGE | 1 ~ 40GHz |
| INPUT POWER (SYSTEM) | 120Vac, 60 Hz | DETECTOR FUNCTION | Peak (PK) Average (AV) |
| ENVIRONMENTAL CONDITIONS | 23deg. C, 65%RH 1011 hPa | TESTED BY | Brad Wu |

| ANTENNA POLARITY & TEST DISTANCE: HORIZONTAL AT 3 M | | | | | | | | |
|---|-------------|-------------------------|----------------|-------------|--------------------|----------------------|------------------|--------------------------|
| NO. | FREQ. (MHz) | EMISSION LEVEL (dBuV/m) | LIMIT (dBuV/m) | MARGIN (dB) | ANTENNA HEIGHT (m) | TABLE ANGLE (Degree) | RAW VALUE (dBuV) | CORRECTION FACTOR (dB/m) |
| 1 | *5660.00 | 105.6 PK | | | 1.03 H | 16 | 67.80 | 37.80 |
| 2 | *5660.00 | 89.2 AV | | | 1.03 H | 16 | 51.40 | 37.80 |
| 3 | 11320.00 | 58.7 PK | 74.0 | -15.3 | 1.06 H | 34 | 10.40 | 48.30 |
| 4 | 11320.00 | 45.2 AV | 54.0 | -8.8 | 1.06 H | 34 | -3.10 | 48.30 |
| ANTENNA POLARITY & TEST DISTANCE: VERTICAL AT 3 M | | | | | | | | |
| NO. | FREQ. (MHz) | EMISSION LEVEL (dBuV/m) | LIMIT (dBuV/m) | MARGIN (dB) | ANTENNA HEIGHT (m) | TABLE ANGLE (Degree) | RAW VALUE (dBuV) | CORRECTION FACTOR (dB/m) |
| 1 | *5660.00 | 108.4 PK | | | 1.02 V | 19 | 70.60 | 37.80 |
| 2 | *5660.00 | 91.8 AV | | | 1.02 V | 19 | 54.00 | 37.80 |
| 3 | 11320.00 | 59.6 PK | 74.0 | -14.4 | 1.10 V | 24 | 11.30 | 48.30 |
| 4 | 11320.00 | 46.1 AV | 54.0 | -7.9 | 1.10 V | 24 | -2.20 | 48.30 |

- REMARKS:**
1. Emission level (dBuV/m) = Raw Value (dBuV) + Correction Factor (dB/m).
 2. Correction Factor (dB/m) = Antenna Factor (dB/m) + Cable Factor (dB).
 3. The other emission levels were very low against the limit.
 4. Margin value = Emission level – Limit value.
 5. “ * “: Fundamental frequency.



A D T

| EUT TEST CONDITION | | MEASUREMENT DETAIL | |
|--------------------------|-----------------------------|--------------------|---------------------------|
| CHANNEL | Channel 140 | FREQUENCY RANGE | 1 ~ 40GHz |
| INPUT POWER (SYSTEM) | 120Vac, 60 Hz | DETECTOR FUNCTION | Peak (PK) Average (AV) |
| ENVIRONMENTAL CONDITIONS | 23deg. C, 65%RH 1011 hPa | TESTED BY | Brad Wu |

| ANTENNA POLARITY & TEST DISTANCE: HORIZONTAL AT 3 M | | | | | | | | |
|---|-------------|-------------------------|----------------|-------------|--------------------|----------------------|------------------|--------------------------|
| NO. | FREQ. (MHz) | EMISSION LEVEL (dBuV/m) | LIMIT (dBuV/m) | MARGIN (dB) | ANTENNA HEIGHT (m) | TABLE ANGLE (Degree) | RAW VALUE (dBuV) | CORRECTION FACTOR (dB/m) |
| 1 | *5700.00 | 105.4 PK | | | 1.00 H | 19 | 67.50 | 37.90 |
| 2 | *5700.00 | 89.0 AV | | | 1.00 H | 19 | 51.10 | 37.90 |
| 3 | #5725.00 | 63.4 PK | 68.3 | -4.9 | 1.00 H | 19 | 25.40 | 38.00 |
| 4 | 11400.00 | 59.1 PK | 74.0 | -14.9 | 1.10 H | 21 | 11.10 | 48.00 |
| 5 | 11400.00 | 45.6 AV | 54.0 | -8.4 | 1.10 H | 21 | -2.40 | 48.00 |
| ANTENNA POLARITY & TEST DISTANCE: VERTICAL AT 3 M | | | | | | | | |
| NO. | FREQ. (MHz) | EMISSION LEVEL (dBuV/m) | LIMIT (dBuV/m) | MARGIN (dB) | ANTENNA HEIGHT (m) | TABLE ANGLE (Degree) | RAW VALUE (dBuV) | CORRECTION FACTOR (dB/m) |
| 1 | *5700.00 | 108.1 PK | | | 1.00 V | 6 | 70.20 | 37.90 |
| 2 | *5700.00 | 91.7 AV | | | 1.00 V | 6 | 53.80 | 37.90 |
| 3 | #5725.00 | 66.7 PK | 68.3 | -1.6 | 1.00 V | 6 | 28.70 | 38.00 |
| 4 | 11400.00 | 60.1 PK | 74.0 | -13.9 | 1.14 V | 25 | 12.10 | 48.00 |
| 5 | 11400.00 | 46.5 AV | 54.0 | -7.5 | 1.14 V | 25 | -1.50 | 48.00 |

- REMARKS:**
1. Emission level (dBuV/m) = Raw Value (dBuV) + Correction Factor (dB/m).
 2. Correction Factor (dB/m) = Antenna Factor (dB/m) + Cable Factor (dB).
 3. The other emission levels were very low against the limit.
 4. Margin value = Emission level – Limit value.
 5. “ * “: Fundamental frequency.
 6. “#”:The radiated frequency is out the restricted band.

802.11n (40MHz)

| EUT TEST CONDITION | | MEASUREMENT DETAIL | |
|--------------------------|-----------------------------|--------------------|---------------------------|
| CHANNEL | Channel 38 | FREQUENCY RANGE | 1 ~ 40GHz |
| INPUT POWER (SYSTEM) | 120Vac, 60 Hz | DETECTOR FUNCTION | Peak (PK) Average (AV) |
| ENVIRONMENTAL CONDITIONS | 23deg. C, 65%RH 1011 hPa | TESTED BY | Brad Wu |

| ANTENNA POLARITY & TEST DISTANCE: HORIZONTAL AT 3 M | | | | | | | | |
|---|-------------|-------------------------|----------------|-------------|--------------------|----------------------|------------------|--------------------------|
| NO. | FREQ. (MHz) | EMISSION LEVEL (dBuV/m) | LIMIT (dBuV/m) | MARGIN (dB) | ANTENNA HEIGHT (m) | TABLE ANGLE (Degree) | RAW VALUE (dBuV) | CORRECTION FACTOR (dB/m) |
| 1 | 5150.00 | 63.2 PK | 74.0 | -10.8 | 1.05 H | 3 | 26.50 | 36.70 |
| 2 | 5150.00 | 42.9 AV | 54.0 | -11.1 | 1.05 H | 3 | 6.20 | 36.70 |
| 3 | *5190.00 | 101.2 PK | | | 1.05 H | 3 | 64.40 | 36.80 |
| 4 | *5190.00 | 83.0 AV | | | 1.05 H | 3 | 46.20 | 36.80 |
| 5 | #10380.00 | 57.2 PK | 68.3 | -11.1 | 1.05 H | 66 | 9.20 | 48.00 |
| ANTENNA POLARITY & TEST DISTANCE: VERTICAL AT 3 M | | | | | | | | |
| NO. | FREQ. (MHz) | EMISSION LEVEL (dBuV/m) | LIMIT (dBuV/m) | MARGIN (dB) | ANTENNA HEIGHT (m) | TABLE ANGLE (Degree) | RAW VALUE (dBuV) | CORRECTION FACTOR (dB/m) |
| 1 | 5150.00 | 66.5 PK | 74.0 | -7.5 | 1.00 V | 7 | 29.80 | 36.70 |
| 2 | 5150.00 | 46.2 AV | 54.0 | -7.8 | 1.00 V | 7 | 9.50 | 36.70 |
| 3 | *5190.00 | 104.4 PK | | | 1.00 V | 7 | 67.60 | 36.80 |
| 4 | *5190.00 | 86.1 AV | | | 1.00 V | 7 | 49.30 | 36.80 |
| 5 | #10380.00 | 57.8 PK | 68.3 | -10.5 | 1.04 V | 223 | 9.80 | 48.00 |

- REMARKS:**
1. Emission level (dBuV/m) = Raw Value (dBuV) + Correction Factor (dB/m).
 2. Correction Factor (dB/m) = Antenna Factor (dB/m) + Cable Factor (dB).
 3. The other emission levels were very low against the limit.
 4. Margin value = Emission level – Limit value.
 5. “ * “: Fundamental frequency.
 6. “#”:The radiated frequency is out the restricted band.



A D T

| EUT TEST CONDITION | | MEASUREMENT DETAIL | |
|--------------------------|-----------------------------|--------------------|---------------------------|
| CHANNEL | Channel 46 | FREQUENCY RANGE | 1 ~ 40GHz |
| INPUT POWER (SYSTEM) | 120Vac, 60 Hz | DETECTOR FUNCTION | Peak (PK) Average (AV) |
| ENVIRONMENTAL CONDITIONS | 23deg. C, 65%RH 1011 hPa | TESTED BY | Brad Wu |

| ANTENNA POLARITY & TEST DISTANCE: HORIZONTAL AT 3 M | | | | | | | | |
|---|-------------|-------------------------|----------------|-------------|--------------------|----------------------|------------------|--------------------------|
| NO. | FREQ. (MHz) | EMISSION LEVEL (dBuV/m) | LIMIT (dBuV/m) | MARGIN (dB) | ANTENNA HEIGHT (m) | TABLE ANGLE (Degree) | RAW VALUE (dBuV) | CORRECTION FACTOR (dB/m) |
| 1 | *5230.00 | 101.8 PK | | | 1.04 H | 5 | 64.90 | 36.90 |
| 2 | *5230.00 | 83.6 AV | | | 1.04 H | 5 | 46.70 | 36.90 |
| 3 | #10460.00 | 57.6 PK | 68.3 | -10.7 | 1.02 H | 41 | 9.30 | 48.30 |
| ANTENNA POLARITY & TEST DISTANCE: VERTICAL AT 3 M | | | | | | | | |
| NO. | FREQ. (MHz) | EMISSION LEVEL (dBuV/m) | LIMIT (dBuV/m) | MARGIN (dB) | ANTENNA HEIGHT (m) | TABLE ANGLE (Degree) | RAW VALUE (dBuV) | CORRECTION FACTOR (dB/m) |
| 1 | *5230.00 | 104.9 PK | | | 1.01 V | 8 | 68.00 | 36.90 |
| 2 | *5230.00 | 86.6 AV | | | 1.01 V | 8 | 49.70 | 36.90 |
| 3 | #10460.00 | 58.2 PK | 68.3 | -10.1 | 1.13 V | 206 | 9.90 | 48.30 |

- REMARKS:**
1. Emission level (dBuV/m) = Raw Value (dBuV) + Correction Factor (dB/m).
 2. Correction Factor (dB/m) = Antenna Factor (dB/m) + Cable Factor (dB).
 3. The other emission levels were very low against the limit.
 4. Margin value = Emission level – Limit value.
 5. “ * “: Fundamental frequency.
 6. “#”: The radiated frequency is out the restricted band.



A D T

| EUT TEST CONDITION | | MEASUREMENT DETAIL | |
|--------------------------|-----------------------------|--------------------|---------------------------|
| CHANNEL | Channel 54 | FREQUENCY RANGE | 1 ~ 40GHz |
| INPUT POWER (SYSTEM) | 120Vac, 60 Hz | DETECTOR FUNCTION | Peak (PK) Average (AV) |
| ENVIRONMENTAL CONDITIONS | 23deg. C, 65%RH 1011 hPa | TESTED BY | Brad Wu |

| ANTENNA POLARITY & TEST DISTANCE: HORIZONTAL AT 3 M | | | | | | | | |
|---|-------------|-------------------------|----------------|-------------|--------------------|----------------------|------------------|--------------------------|
| NO. | FREQ. (MHz) | EMISSION LEVEL (dBuV/m) | LIMIT (dBuV/m) | MARGIN (dB) | ANTENNA HEIGHT (m) | TABLE ANGLE (Degree) | RAW VALUE (dBuV) | CORRECTION FACTOR (dB/m) |
| 1 | *5270.00 | 102.4 PK | | | 1.05 H | 8 | 65.40 | 37.00 |
| 2 | *5270.00 | 84.2 AV | | | 1.05 H | 8 | 47.20 | 37.00 |
| 3 | #10540.00 | 57.9 PK | 68.3 | -10.4 | 1.10 H | 63 | 9.50 | 48.40 |
| ANTENNA POLARITY & TEST DISTANCE: VERTICAL AT 3 M | | | | | | | | |
| NO. | FREQ. (MHz) | EMISSION LEVEL (dBuV/m) | LIMIT (dBuV/m) | MARGIN (dB) | ANTENNA HEIGHT (m) | TABLE ANGLE (Degree) | RAW VALUE (dBuV) | CORRECTION FACTOR (dB/m) |
| 1 | *5270.00 | 105.5 PK | | | 1.00 V | 38 | 68.50 | 37.00 |
| 2 | *5270.00 | 87.2 AV | | | 1.00 V | 38 | 50.20 | 37.00 |
| 3 | #10540.00 | 58.5 PK | 68.3 | -9.8 | 1.08 V | 194 | 10.10 | 48.40 |

- REMARKS:**
1. Emission level (dBuV/m) = Raw Value (dBuV) + Correction Factor (dB/m).
 2. Correction Factor (dB/m) = Antenna Factor (dB/m) + Cable Factor (dB).
 3. The other emission levels were very low against the limit.
 4. Margin value = Emission level – Limit value.
 5. “ * “: Fundamental frequency.
 6. “#”: The radiated frequency is out the restricted band.



A D T

| EUT TEST CONDITION | | MEASUREMENT DETAIL | |
|--------------------------|-----------------------------|--------------------|---------------------------|
| CHANNEL | Channel 62 | FREQUENCY RANGE | 1 ~ 40GHz |
| INPUT POWER (SYSTEM) | 120Vac, 60 Hz | DETECTOR FUNCTION | Peak (PK) Average (AV) |
| ENVIRONMENTAL CONDITIONS | 23deg. C, 65%RH 1011 hPa | TESTED BY | Brad Wu |

| ANTENNA POLARITY & TEST DISTANCE: HORIZONTAL AT 3 M | | | | | | | | |
|---|-------------|-------------------------|----------------|-------------|--------------------|----------------------|------------------|--------------------------|
| NO. | FREQ. (MHz) | EMISSION LEVEL (dBuV/m) | LIMIT (dBuV/m) | MARGIN (dB) | ANTENNA HEIGHT (m) | TABLE ANGLE (Degree) | RAW VALUE (dBuV) | CORRECTION FACTOR (dB/m) |
| 1 | *5310.00 | 101.6 PK | | | 1.04 H | 9 | 64.50 | 37.10 |
| 2 | *5310.00 | 83.4 AV | | | 1.04 H | 9 | 46.30 | 37.10 |
| 3 | 5350.00 | 59.2 PK | 74.0 | -14.8 | 1.04 H | 9 | 22.00 | 37.20 |
| 4 | 5350.00 | 40.8 AV | 54.0 | -13.2 | 1.04 H | 9 | 3.60 | 37.20 |
| 5 | 10620.00 | 57.8 PK | 74.0 | -16.2 | 1.10 H | 22 | 9.20 | 48.60 |
| 6 | 10620.00 | 44.7 AV | 54.0 | -9.3 | 1.10 H | 22 | -3.90 | 48.60 |
| ANTENNA POLARITY & TEST DISTANCE: VERTICAL AT 3 M | | | | | | | | |
| NO. | FREQ. (MHz) | EMISSION LEVEL (dBuV/m) | LIMIT (dBuV/m) | MARGIN (dB) | ANTENNA HEIGHT (m) | TABLE ANGLE (Degree) | RAW VALUE (dBuV) | CORRECTION FACTOR (dB/m) |
| 1 | *5310.00 | 104.5 PK | | | 1.11 V | 20 | 67.40 | 37.10 |
| 2 | *5310.00 | 86.2 AV | | | 1.11 V | 20 | 49.10 | 37.10 |
| 3 | 5350.00 | 62.4 PK | 74.0 | -11.6 | 1.11 V | 20 | 25.20 | 37.20 |
| 4 | 5350.00 | 44.0 AV | 54.0 | -10.0 | 1.11 V | 20 | 6.80 | 37.20 |
| 5 | 10620.00 | 58.3 PK | 74.0 | -15.7 | 1.10 V | 39 | 9.70 | 48.60 |
| 6 | 10620.00 | 45.2 AV | 54.0 | -8.8 | 1.10 V | 39 | -3.40 | 48.60 |

- REMARKS:**
1. Emission level (dBuV/m) = Raw Value (dBuV) + Correction Factor (dB/m).
 2. Correction Factor (dB/m) = Antenna Factor (dB/m) + Cable Factor (dB).
 3. The other emission levels were very low against the limit.
 4. Margin value = Emission level – Limit value.
 5. “ * “: Fundamental frequency.



A D T

| EUT TEST CONDITION | | MEASUREMENT DETAIL | |
|--------------------------|-----------------------------|--------------------|---------------------------|
| CHANNEL | Channel 102 | FREQUENCY RANGE | 1 ~ 40GHz |
| INPUT POWER (SYSTEM) | 120Vac, 60 Hz | DETECTOR FUNCTION | Peak (PK) Average (AV) |
| ENVIRONMENTAL CONDITIONS | 23deg. C, 65%RH 1011 hPa | TESTED BY | Brad Wu |

| ANTENNA POLARITY & TEST DISTANCE: HORIZONTAL AT 3 M | | | | | | | | |
|---|-------------|-------------------------|----------------|-------------|--------------------|----------------------|------------------|--------------------------|
| NO. | FREQ. (MHz) | EMISSION LEVEL (dBuV/m) | LIMIT (dBuV/m) | MARGIN (dB) | ANTENNA HEIGHT (m) | TABLE ANGLE (Degree) | RAW VALUE (dBuV) | CORRECTION FACTOR (dB/m) |
| 1 | 5460.00 | 56.9 PK | 74.0 | -17.1 | 1.21 H | 2 | 19.60 | 37.30 |
| 2 | 5460.00 | 38.6 AV | 54.0 | -15.4 | 1.21 H | 2 | 1.30 | 37.30 |
| 3 | #5470.00 | 62.7 PK | 68.3 | -5.6 | 1.21 H | 2 | 25.30 | 37.40 |
| 4 | *5510.00 | 101.8 PK | | | 1.21 H | 2 | 64.40 | 37.40 |
| 5 | *5510.00 | 84.0 AV | | | 1.21 H | 2 | 46.60 | 37.40 |
| 6 | 11020.00 | 57.6 PK | 74.0 | -16.4 | 1.14 H | 222 | 8.90 | 48.70 |
| 7 | 11020.00 | 44.5 AV | 54.0 | -9.5 | 1.14 H | 222 | -4.20 | 48.70 |

| ANTENNA POLARITY & TEST DISTANCE: VERTICAL AT 3 M | | | | | | | | |
|---|-------------|-------------------------|----------------|-------------|--------------------|----------------------|------------------|--------------------------|
| NO. | FREQ. (MHz) | EMISSION LEVEL (dBuV/m) | LIMIT (dBuV/m) | MARGIN (dB) | ANTENNA HEIGHT (m) | TABLE ANGLE (Degree) | RAW VALUE (dBuV) | CORRECTION FACTOR (dB/m) |
| 1 | 5460.00 | 60.2 PK | 74.0 | -13.8 | 1.05 V | 13 | 22.90 | 37.30 |
| 2 | 5460.00 | 41.9 AV | 54.0 | -12.1 | 1.05 V | 13 | 4.60 | 37.30 |
| 3 | #5470.00 | 66.1 PK | 68.3 | -2.2 | 1.05 V | 13 | 28.70 | 37.40 |
| 4 | *5510.00 | 105.1 PK | | | 1.05 V | 13 | 67.70 | 37.40 |
| 5 | *5510.00 | 86.8 AV | | | 1.05 V | 13 | 49.40 | 37.40 |
| 6 | 11020.00 | 58.6 PK | 74.0 | -15.4 | 1.14 V | 221 | 9.90 | 48.70 |
| 7 | 11020.00 | 45.5 AV | 54.0 | -8.5 | 1.14 V | 221 | -3.20 | 48.70 |

- REMARKS:**
1. Emission level (dBuV/m) = Raw Value (dBuV) + Correction Factor (dB/m).
 2. Correction Factor (dB/m) = Antenna Factor (dB/m) + Cable Factor (dB).
 3. The other emission levels were very low against the limit.
 4. Margin value = Emission level – Limit value.
 5. “ * “: Fundamental frequency.
 6. “#”: The radiated frequency is out the restricted band.



A D T

| EUT TEST CONDITION | | MEASUREMENT DETAIL | |
|--------------------------|-----------------------------|--------------------|---------------------------|
| CHANNEL | Channel 110 | FREQUENCY RANGE | 1 ~ 40GHz |
| INPUT POWER (SYSTEM) | 120Vac, 60 Hz | DETECTOR FUNCTION | Peak (PK) Average (AV) |
| ENVIRONMENTAL CONDITIONS | 23deg. C, 65%RH 1011 hPa | TESTED BY | Brad Wu |

| ANTENNA POLARITY & TEST DISTANCE: HORIZONTAL AT 3 M | | | | | | | | |
|---|-------------|-------------------------|----------------|-------------|--------------------|----------------------|------------------|--------------------------|
| NO. | FREQ. (MHz) | EMISSION LEVEL (dBuV/m) | LIMIT (dBuV/m) | MARGIN (dB) | ANTENNA HEIGHT (m) | TABLE ANGLE (Degree) | RAW VALUE (dBuV) | CORRECTION FACTOR (dB/m) |
| 1 | *5550.00 | 102.0 PK | | | 1.19 H | 5 | 64.50 | 37.50 |
| 2 | *5550.00 | 84.2 AV | | | 1.19 H | 5 | 46.70 | 37.50 |
| 3 | 11100.00 | 57.8 PK | 74.0 | -16.2 | 1.09 H | 215 | 9.30 | 48.50 |
| 4 | 11100.00 | 44.7 AV | 54.0 | -9.3 | 1.09 H | 215 | -3.80 | 48.50 |
| ANTENNA POLARITY & TEST DISTANCE: VERTICAL AT 3 M | | | | | | | | |
| NO. | FREQ. (MHz) | EMISSION LEVEL (dBuV/m) | LIMIT (dBuV/m) | MARGIN (dB) | ANTENNA HEIGHT (m) | TABLE ANGLE (Degree) | RAW VALUE (dBuV) | CORRECTION FACTOR (dB/m) |
| 1 | *5550.00 | 105.3 PK | | | 1.06 V | 14 | 67.80 | 37.50 |
| 2 | *5550.00 | 87.0 AV | | | 1.06 V | 14 | 49.50 | 37.50 |
| 3 | 11100.00 | 58.4 PK | 74.0 | -15.6 | 1.09 V | 208 | 9.90 | 48.50 |
| 4 | 11100.00 | 45.3 AV | 54.0 | -8.7 | 1.09 V | 208 | -3.20 | 48.50 |

- REMARKS:**
1. Emission level (dBuV/m) = Raw Value (dBuV) + Correction Factor (dB/m).
 2. Correction Factor (dB/m) = Antenna Factor (dB/m) + Cable Factor (dB).
 3. The other emission levels were very low against the limit.
 4. Margin value = Emission level – Limit value.
 5. “ * “: Fundamental frequency.



A D T

| EUT TEST CONDITION | | MEASUREMENT DETAIL | |
|--------------------------|-----------------------------|--------------------|---------------------------|
| CHANNEL | Channel 134 | FREQUENCY RANGE | 1 ~ 40GHz |
| INPUT POWER (SYSTEM) | 120Vac, 60 Hz | DETECTOR FUNCTION | Peak (PK) Average (AV) |
| ENVIRONMENTAL CONDITIONS | 23deg. C, 65%RH 1011 hPa | TESTED BY | Brad Wu |

| ANTENNA POLARITY & TEST DISTANCE: HORIZONTAL AT 3 M | | | | | | | | |
|---|-------------|-------------------------|----------------|-------------|--------------------|----------------------|------------------|--------------------------|
| NO. | FREQ. (MHz) | EMISSION LEVEL (dBuV/m) | LIMIT (dBuV/m) | MARGIN (dB) | ANTENNA HEIGHT (m) | TABLE ANGLE (Degree) | RAW VALUE (dBuV) | CORRECTION FACTOR (dB/m) |
| 1 | *5670.00 | 101.6 PK | | | 1.20 H | 6 | 63.80 | 37.80 |
| 2 | *5670.00 | 83.8 AV | | | 1.20 H | 6 | 46.00 | 37.80 |
| 3 | #5725.00 | 56.2 PK | 68.3 | -12.1 | 1.20 H | 6 | 18.20 | 38.00 |
| 4 | 11340.00 | 58.1 PK | 74.0 | -15.9 | 1.06 H | 228 | 9.90 | 48.20 |
| 5 | 11340.00 | 45.0 AV | 54.0 | -9.0 | 1.06 H | 228 | -3.20 | 48.20 |
| ANTENNA POLARITY & TEST DISTANCE: VERTICAL AT 3 M | | | | | | | | |
| NO. | FREQ. (MHz) | EMISSION LEVEL (dBuV/m) | LIMIT (dBuV/m) | MARGIN (dB) | ANTENNA HEIGHT (m) | TABLE ANGLE (Degree) | RAW VALUE (dBuV) | CORRECTION FACTOR (dB/m) |
| 1 | *5670.00 | 105.2 PK | | | 1.00 V | 15 | 67.40 | 37.80 |
| 2 | *5670.00 | 86.8 AV | | | 1.00 V | 15 | 49.00 | 37.80 |
| 3 | #5725.00 | 59.8 PK | 68.3 | -8.5 | 1.00 V | 15 | 21.80 | 38.00 |
| 4 | 11340.00 | 58.9 PK | 74.0 | -15.1 | 1.01 V | 224 | 10.70 | 48.20 |
| 5 | 11340.00 | 45.8 AV | 54.0 | -8.2 | 1.01 V | 224 | -2.40 | 48.20 |

- REMARKS:**
1. Emission level (dBuV/m) = Raw Value (dBuV) + Correction Factor (dB/m).
 2. Correction Factor (dB/m) = Antenna Factor (dB/m) + Cable Factor (dB).
 3. The other emission levels were very low against the limit.
 4. Margin value = Emission level – Limit value.
 5. “ * “: Fundamental frequency.
 6. “#”:The radiated frequency is out the restricted band.

BELOW 1GHz WORST-CASE DATA : 802.11n (40MHz)

| EUT TEST CONDITION | | MEASUREMENT DETAIL | |
|--------------------------|-----------------------------|--------------------|---------------|
| CHANNEL | Channel 54 | FREQUENCY RANGE | Below 1000MHz |
| INPUT POWER (SYSTEM) | 120Vac, 60 Hz | DETECTOR FUNCTION | Quasi-Peak |
| ENVIRONMENTAL CONDITIONS | 24deg. C, 66%RH 1008 hPa | TESTED BY | Brad Wu |

| ANTENNA POLARITY & TEST DISTANCE: HORIZONTAL AT 3 M | | | | | | | | |
|---|-------------|-------------------------|----------------|-------------|--------------------|----------------------|------------------|--------------------------|
| NO. | FREQ. (MHz) | EMISSION LEVEL (dBuV/m) | LIMIT (dBuV/m) | MARGIN (dB) | ANTENNA HEIGHT (m) | TABLE ANGLE (Degree) | RAW VALUE (dBuV) | CORRECTION FACTOR (dB/m) |
| 1 | 125.17 | 30.9 QP | 43.5 | -12.6 | 1.50 H | 25 | 19.10 | 11.80 |
| 2 | 284.60 | 39.0 QP | 46.0 | -7.0 | 1.00 H | 10 | 25.20 | 13.80 |
| 3 | 675.40 | 39.6 QP | 46.0 | -6.4 | 1.00 H | 10 | 15.10 | 24.50 |
| 4 | 764.84 | 43.6 QP | 46.0 | -2.4 | 2.00 H | 280 | 17.90 | 25.70 |
| 5 | 795.95 | 43.1 QP | 46.0 | -2.9 | 1.00 H | 310 | 17.10 | 26.00 |
| 6 | 959.27 | 39.7 QP | 46.0 | -6.3 | 2.00 H | 49 | 11.10 | 28.60 |
| ANTENNA POLARITY & TEST DISTANCE: VERTICAL AT 3 M | | | | | | | | |
| NO. | FREQ. (MHz) | EMISSION LEVEL (dBuV/m) | LIMIT (dBuV/m) | MARGIN (dB) | ANTENNA HEIGHT (m) | TABLE ANGLE (Degree) | RAW VALUE (dBuV) | CORRECTION FACTOR (dB/m) |
| 1 | 249.60 | 35.00 QP | 46.00 | -11.0 | 1.00 V | 298 | 21.10 | 13.90 |
| 2 | 317.65 | 34.70 QP | 46.00 | -11.3 | 1.50 V | 10 | 20.10 | 14.60 |
| 3 | 366.26 | 34.60 QP | 46.00 | -11.4 | 1.50 V | 10 | 17.90 | 16.70 |
| 4 | 675.40 | 35.10 QP | 46.00 | -10.9 | 2.00 V | 43 | 10.60 | 24.50 |
| 5 | 764.84 | 43.20 QP | 46.00 | -2.8 | 1.00 V | 10 | 17.50 | 25.70 |
| 6 | 961.21 | 42.70 QP | 54.00 | -11.3 | 1.50 V | 31 | 14.00 | 28.70 |

- REMARKS:**
1. Emission level (dBuV/m) = Raw Value (dBuV) + Correction Factor (dB/m).
 2. Correction Factor (dB/m) = Antenna Factor (dB/m) + Cable Factor (dB).
 3. The other emission levels were very low against the limit.
 4. Margin value = Emission level – Limit value.



A D T

| EUT TEST CONDITION | | MEASUREMENT DETAIL | |
|--------------------------|-----------------------------|--------------------|---------------|
| CHANNEL | Channel 134 | FREQUENCY RANGE | Below 1000MHz |
| INPUT POWER (SYSTEM) | 120Vac, 60 Hz | DETECTOR FUNCTION | Quasi-Peak |
| ENVIRONMENTAL CONDITIONS | 24deg. C, 66%RH 1008 hPa | TESTED BY | Brad Wu |

| ANTENNA POLARITY & TEST DISTANCE: HORIZONTAL AT 3 M | | | | | | | | |
|---|-------------|-------------------------|----------------|-------------|--------------------|----------------------|------------------|--------------------------|
| NO. | FREQ. (MHz) | EMISSION LEVEL (dBuV/m) | LIMIT (dBuV/m) | MARGIN (dB) | ANTENNA HEIGHT (m) | TABLE ANGLE (Degree) | RAW VALUE (dBuV) | CORRECTION FACTOR (dB/m) |
| 1 | 284.60 | 39.3 QP | 46.0 | -6.7 | 1.00 H | 10 | 25.50 | 13.80 |
| 2 | 675.40 | 40.3 QP | 46.0 | -5.7 | 2.00 H | 85 | 15.80 | 24.50 |
| 3 | 764.84 | 43.4 QP | 46.0 | -2.6 | 2.00 H | 307 | 17.70 | 25.70 |
| 4 | 795.95 | 40.8 QP | 46.0 | -5.2 | 2.00 H | 307 | 14.80 | 26.00 |
| 5 | 908.72 | 42.1 QP | 46.0 | -3.9 | 1.50 H | 337 | 14.00 | 28.10 |
| 6 | 961.21 | 42.6 QP | 54.0 | -11.4 | 1.50 H | 271 | 13.90 | 28.70 |
| ANTENNA POLARITY & TEST DISTANCE: VERTICAL AT 3 M | | | | | | | | |
| NO. | FREQ. (MHz) | EMISSION LEVEL (dBuV/m) | LIMIT (dBuV/m) | MARGIN (dB) | ANTENNA HEIGHT (m) | TABLE ANGLE (Degree) | RAW VALUE (dBuV) | CORRECTION FACTOR (dB/m) |
| 1 | 249.60 | 36.5 QP | 46.0 | -9.5 | 1.00 V | 157 | 22.60 | 13.90 |
| 2 | 319.60 | 34.7 QP | 46.0 | -11.3 | 1.50 V | 13 | 20.10 | 14.60 |
| 3 | 366.26 | 34.6 QP | 46.0 | -11.4 | 1.50 V | 4 | 17.90 | 16.70 |
| 4 | 675.40 | 39.3 QP | 46.0 | -6.7 | 1.00 V | 16 | 14.80 | 24.50 |
| 5 | 764.84 | 38.8 QP | 46.0 | -7.2 | 2.00 V | 124 | 13.10 | 25.70 |
| 6 | 960.00 | 36.9 QP | 46.0 | -9.1 | 1.50 V | 34 | 8.20 | 28.70 |

- REMARKS:**
1. Emission level (dBuV/m) = Raw Value (dBuV) + Correction Factor (dB/m).
 2. Correction Factor (dB/m) = Antenna Factor (dB/m) + Cable Factor (dB).
 3. The other emission levels were very low against the limit.
 4. Margin value = Emission level – Limit value.

4.2 CONDUCTED EMISSION MEASUREMENT

4.2.1 LIMITS OF CONDUCTED EMISSION MEASUREMENT

| FREQUENCY OF EMISSION (MHz) | CONDUCTED LIMIT (dB μ V) | |
|-----------------------------|------------------------------|----------|
| | Quasi-peak | Average |
| 0.15 ~ 0.5 | 66 to 56 | 56 to 46 |
| 0.5 ~ 5 | 56 | 46 |
| 5 ~ 30 | 60 | 50 |

- NOTE:** 1. The lower limit shall apply at the transition frequencies.
2. The limit decreases in line with the logarithm of the frequency in the range of 0.15 to 0.50MHz.
3. All emanations from a class A/B digital device or system, including any network of conductors and apparatus connected thereto, shall not exceed the level of field strengths specified above.

4.2.2 TEST INSTRUMENTS

| DESCRIPTION & MANUFACTURER | MODEL NO. | SERIAL NO. | DATE OF CALIBRATION | DUE DATE OF CALIBRATION |
|----------------------------------|---------------------|----------------|---------------------|-------------------------|
| Test Receiver ROHDE & SCHWARZ | ESCS30 | 100288 | Sep. 24, 2009 | Sep. 23, 2010 |
| RF signal cable Woken | 5D-FB | Cable-HYCO2-01 | Dec. 31, 2009 | Dec. 30, 2010 |
| LISN ROHDE & SCHWARZ | ESH2-Z5 | 100100 | Aug. 24, 2009 | Aug. 23, 2010 |
| LISN ROHDE & SCHWARZ | ESH3-Z5 | 100311 | Jul. 29, 2009 | Jul. 28, 2010 |
| Software ADT | ADT_Cond_ V7.3.7 | NA | NA | NA |

- NOTE:** 1. The calibration interval of the above test instruments is 12 months and the calibrations are traceable to NML/ROC and NIST/USA.
2. The test was performed in HwaYa Shielded Room 2.
3. The VCCI Site Registration No. is C-2047.

4.2.3 TEST PROCEDURES

- a. The EUT was placed 0.4 meters from the conducting wall of the shielded room with EUT being connected to the power mains through a line impedance stabilization network (LISN). Other support units were connected to the power mains through another LISN. The two LISNs provide 50 ohm/ 50uH of coupling impedance for the measuring instrument.
- b. Both lines of the power mains connected to the EUT were checked for maximum conducted interference.
- c. The frequency range from 150kHz to 30MHz was searched. Emission levels under (Limit - 20dB) was not recorded.

4.2.4 DEVIATION FROM TEST STANDARD

No deviation.

4.2.5 TEST SETUP

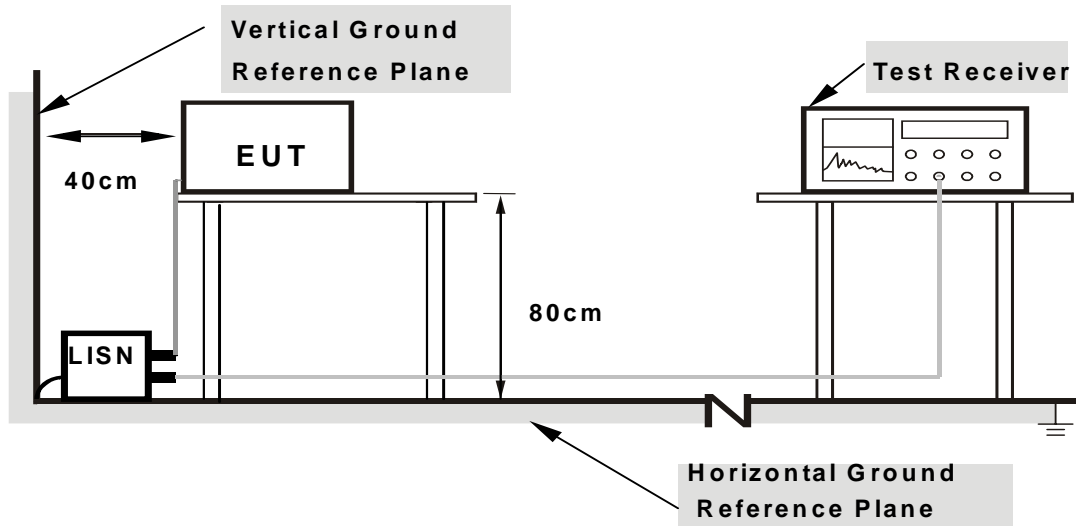

Note: 1.Support units were connected to second LISN.

2.Both of LISNs (AMN) are 80 cm from EUT and at least 80 from other units and other metal planes

For the actual test configuration, please refer to the attached file (Test Setup Photo).

4.2.6 EUT OPERATING CONDITIONS

Same as 4.1.6.

4.2.7 TEST RESULTS

CONDUCTED WORST-CASE DATA : 802.11n (40MHz)

| | | | |
|----------------------|------------|--------------|--------|
| CHANNEL | Channel 54 | PHASE | Line 1 |
| 6dB BANDWIDTH | 9kHz | | |

| No | Freq. [MHz] | Corr. Factor (dB) | Reading Value [dB (uV)] | | Emission Level [dB (uV)] | | Limit [dB (uV)] | | Margin (dB) | |
|----|----------------|-------------------------|----------------------------|-------|-----------------------------|-------|--------------------|-------|----------------|-------|
| | | | Q.P. | AV. | Q.P. | AV. | Q.P. | AV. | Q.P. | AV. |
| | | | 1 | 0.152 | 0.16 | 52.19 | - | 52.35 | - | 65.90 |
| 2 | 0.306 | 0.17 | 33.38 | - | 33.55 | - | 60.07 | 50.07 | -26.52 | - |
| 3 | 0.576 | 0.19 | 31.10 | - | 31.29 | - | 56.00 | 46.00 | -24.71 | - |
| 4 | 0.865 | 0.22 | 25.27 | - | 25.49 | - | 56.00 | 46.00 | -30.51 | - |
| 5 | 13.733 | 0.46 | 24.10 | - | 24.56 | - | 60.00 | 50.00 | -35.44 | - |
| 6 | 17.324 | 0.59 | 30.17 | - | 30.76 | - | 60.00 | 50.00 | -29.24 | - |

- REMARKS:**
1. Q.P. and AV. are abbreviations of quasi-peak and average individually.
 2. "-": The Quasi-peak reading value also meets average limit and measurement with the average detector is unnecessary.
 3. The emission levels of other frequencies were very low against the limit.
 4. Margin value = Emission level - Limit value
 5. Correction factor = Insertion loss + Cable loss
 6. Emission Level = Correction Factor + Reading Value.

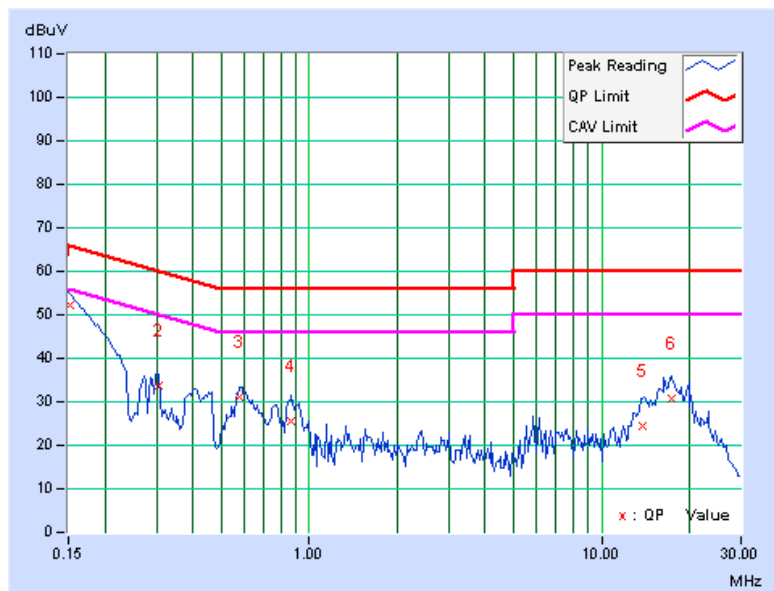



A D T

| | | | |
|----------------------|------------|--------------|--------|
| CHANNEL | Channel 54 | PHASE | Line 2 |
| 6dB BANDWIDTH | 9kHz | | |

| No | Freq. [MHz] | Corr. Factor (dB) | Reading Value | | Emission Level | | Limit | | Margin | |
|----|----------------|-------------------------|---------------|-----|----------------|-----|-----------|-------|--------|-----|
| | | | [dB (uV)] | | [dB (uV)] | | [dB (uV)] | | (dB) | |
| | | | Q.P. | AV. | Q.P. | AV. | Q.P. | AV. | Q.P. | AV. |
| 1 | 0.152 | 0.13 | 50.81 | - | 50.94 | - | 65.90 | 55.90 | -14.97 | - |
| 2 | 0.302 | 0.15 | 36.92 | - | 37.07 | - | 60.18 | 50.18 | -23.11 | - |
| 3 | 0.459 | 0.17 | 32.10 | - | 32.27 | - | 56.72 | 46.72 | -24.45 | - |
| 4 | 0.576 | 0.18 | 33.18 | - | 33.36 | - | 56.00 | 46.00 | -22.64 | - |
| 5 | 0.869 | 0.21 | 28.50 | - | 28.71 | - | 56.00 | 46.00 | -27.29 | - |
| 6 | 17.188 | 0.77 | 30.36 | - | 31.13 | - | 60.00 | 50.00 | -28.87 | - |

- REMARKS:**
1. Q.P. and AV. are abbreviations of quasi-peak and average individually.
 2. "-": The Quasi-peak reading value also meets average limit and measurement with the average detector is unnecessary.
 3. The emission levels of other frequencies were very low against the limit.
 4. Margin value = Emission level - Limit value
 5. Correction factor = Insertion loss + Cable loss
 6. Emission Level = Correction Factor + Reading Value.

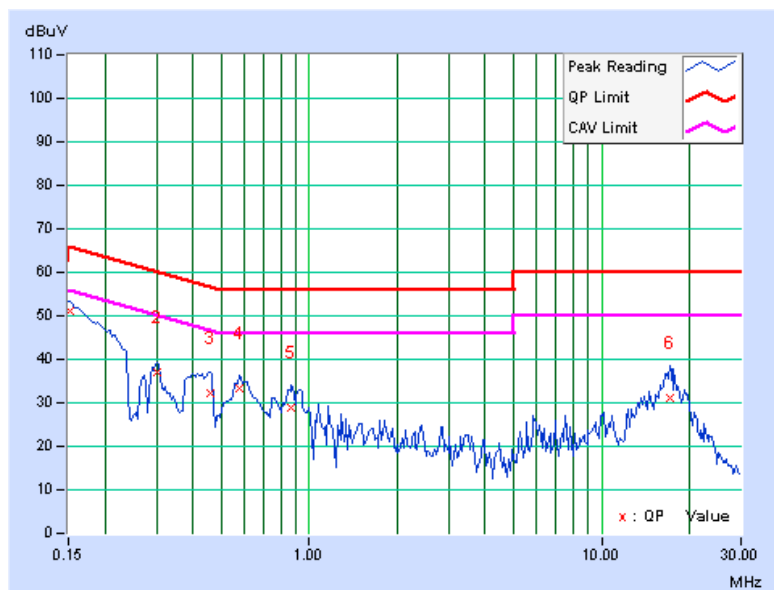

| | | | |
|----------------------|-------------|--------------|--------|
| CHANNEL | Channel 134 | PHASE | Line 1 |
| 6dB BANDWIDTH | 9kHz | | |

| No | Freq. [MHz] | Corr. Factor (dB) | Reading Value | | Emission Level | | Limit | | Margin | |
|----|----------------|-------------------------|---------------|-----|----------------|-----|-----------|-------|--------|-----|
| | | | [dB (uV)] | | [dB (uV)] | | [dB (uV)] | | (dB) | |
| | | | Q.P. | AV. | Q.P. | AV. | Q.P. | AV. | Q.P. | AV. |
| 1 | 0.153 | 0.16 | 51.77 | - | 51.93 | - | 65.86 | 55.86 | -13.93 | - |
| 2 | 0.302 | 0.17 | 34.78 | - | 34.95 | - | 60.18 | 50.18 | -25.23 | - |
| 3 | 0.463 | 0.19 | 28.22 | - | 28.41 | - | 56.65 | 46.65 | -28.24 | - |
| 4 | 0.591 | 0.20 | 28.35 | - | 28.55 | - | 56.00 | 46.00 | -27.45 | - |
| 5 | 14.188 | 0.48 | 24.69 | - | 25.17 | - | 60.00 | 50.00 | -34.83 | - |
| 6 | 17.836 | 0.61 | 28.68 | - | 29.29 | - | 60.00 | 50.00 | -30.71 | - |

- REMARKS:**
1. Q.P. and AV. are abbreviations of quasi-peak and average individually.
 2. "-": The Quasi-peak reading value also meets average limit and measurement with the average detector is unnecessary.
 3. The emission levels of other frequencies were very low against the limit.
 4. Margin value = Emission level - Limit value
 5. Correction factor = Insertion loss + Cable loss
 6. Emission Level = Correction Factor + Reading Value.

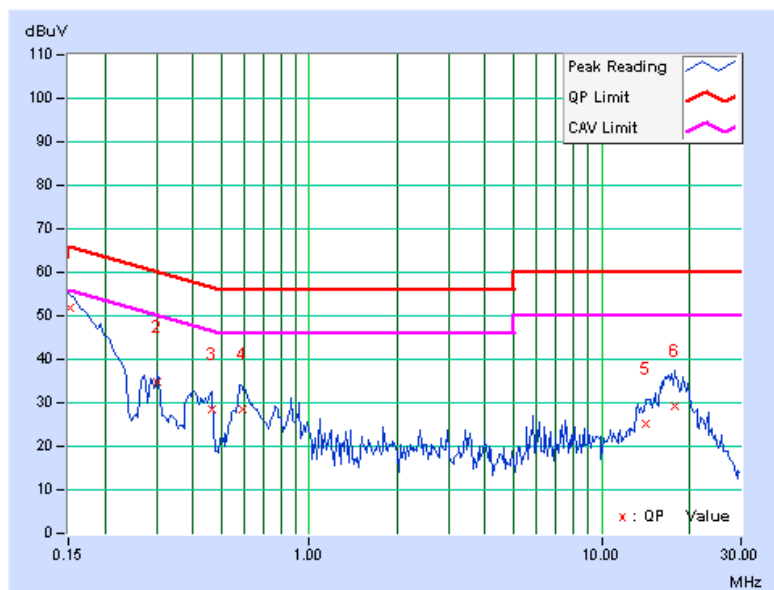

| | | | |
|----------------------|-------------|--------------|--------|
| CHANNEL | Channel 134 | PHASE | Line 2 |
| 6dB BANDWIDTH | 9kHz | | |

| No | Freq. [MHz] | Corr. Factor (dB) | Reading Value | | Emission Level | | Limit | | Margin | |
|----|----------------|-------------------------|---------------|-----|----------------|-----|-----------|-------|--------|-----|
| | | | [dB (uV)] | | [dB (uV)] | | [dB (uV)] | | (dB) | |
| | | | Q.P. | AV. | Q.P. | AV. | Q.P. | AV. | Q.P. | AV. |
| 1 | 0.154 | 0.13 | 50.18 | - | 50.31 | - | 65.79 | 55.79 | -15.49 | - |
| 2 | 0.305 | 0.15 | 36.25 | - | 36.40 | - | 60.11 | 50.11 | -23.71 | - |
| 3 | 0.463 | 0.17 | 33.90 | - | 34.07 | - | 56.65 | 46.65 | -22.58 | - |
| 4 | 0.591 | 0.18 | 31.21 | - | 31.39 | - | 56.00 | 46.00 | -24.61 | - |
| 5 | 0.873 | 0.21 | 28.72 | - | 28.93 | - | 56.00 | 46.00 | -27.07 | - |
| 6 | 16.617 | 0.74 | 29.88 | - | 30.62 | - | 60.00 | 50.00 | -29.38 | - |

- REMARKS:**
1. Q.P. and AV. are abbreviations of quasi-peak and average individually.
 2. "-": The Quasi-peak reading value also meets average limit and measurement with the average detector is unnecessary.
 3. The emission levels of other frequencies were very low against the limit.
 4. Margin value = Emission level - Limit value
 5. Correction factor = Insertion loss + Cable loss
 6. Emission Level = Correction Factor + Reading Value.

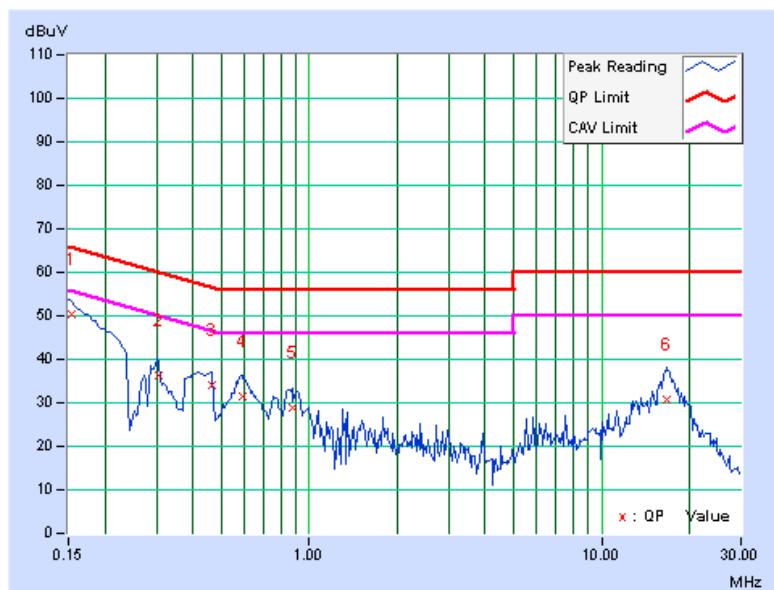

4.3 MAXIMUM CONDUCTED OUTPUT POWER MEASUREMENT

4.3.1 LIMITS OF MAXIMUM CONDUCTED OUTPUT POWER MEASUREMENT

| FREQUENCY BAND | LIMIT |
|------------------|---|
| 5.150 ~ 5.250GHz | The lesser of 50mW (17dBm) or 4dBm + 10logB |
| 5.250 ~ 5.350GHz | The lesser of 250mW (24dBm) or 11dBm + 10logB |
| 5.470 ~ 5.725GHz | The lesser of 250mW (24dBm) or 11dBm + 10logB |

NOTE: Where B is the 26dB emission bandwidth in MHz.

4.3.2 TEST INSTRUMENTS

FOR POWER OUTPUT MEASUREMENT

| DESCRIPTION & MANUFACTURER | MODEL NO. | SERIAL NO. | DATE OF CALIBRATION | CALIBRATED UNTIL |
|-----------------------------|-----------|------------|---------------------|------------------|
| High Speed Peak Power Meter | ML2495A | 0824012 | Aug. 10, 2009 | Aug. 09, 2010 |
| Power Sensor | MA2411B | 0738138 | Aug. 10, 2009 | Aug. 09, 2010 |

Note:

1. The calibration interval of the above test instruments is 12 months and the calibrations are traceable to NML/ROC and NIST/USA.
2. Measurement Bandwidth of ML2495A is 65MHz greater than 26dB bandwidth of emission.

FOR 26dB OCCUPIED BANDWIDTH

| DESCRIPTION & MANUFACTURER | MODEL NO. | SERIAL NO. | DATE OF CALIBRATION | DUE DATE OF CALIBRATION |
|----------------------------|-----------|------------|---------------------|-------------------------|
| R&S SPECTRUM ANALYZER | FSP40 | 100040 | Jul. 07, 2009 | Jul. 06, 2010 |

NOTE: The calibration interval of the above test instruments is 12 months and the calibrations are traceable to NML/ROC and NIST/USA.

4.3.3 TEST PROCEDURE

FOR POWER OUTPUT MEASUREMENT

A power sensor was used on the output port of the EUT. A power meter was used to read the response of the power sensor. Record the power level.

FOR 26dB OCCUPIED BANDWIDTH

The transmitter output was connected to the spectrum analyzer through an attenuator. The bandwidth of the fundamental frequency was measured by spectrum analyzer with 300kHz RBW and 1MHz VBW. The 26dB bandwidth is defined as the total spectrum the power of which is higher than peak power minus 26dB.

4.3.4 DEVIATION FROM TEST STANDARD

No deviation.

4.3.5 TEST SETUP

FOR POWER OUTPUT MEASUREMENT

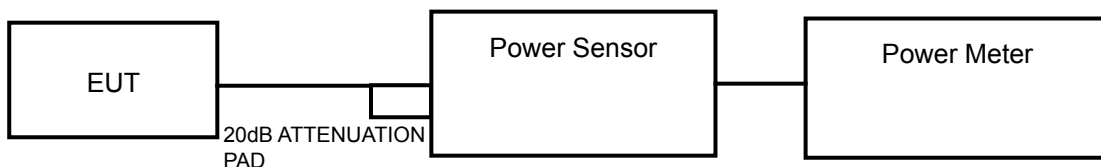

FOR 26dB OCCUPIED BANDWIDTH

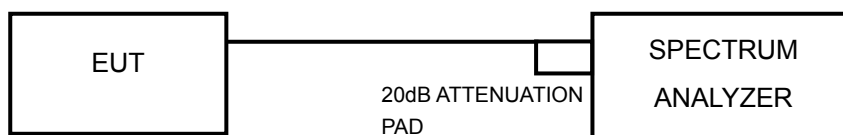

4.3.6 EUT OPERATING CONDITIONS

The software provided by client to enable the EUT under transmission condition continuously at specific channel frequencies individually.

4.3.7 TEST RESULTS

POWER OUTPUT: 802.11a

| CHANNEL | CHANNEL FREQUENCY (MHz) | OUTPUT POWER (mW) | OUTPUT POWER (dBm) | POWER LIMIT (dBm) | PASS / FAIL |
|---------|-------------------------|-------------------|--------------------|-------------------|-------------|
| 36 | 5180 | 32.4 | 15.1 | 17 | PASS |
| 40 | 5200 | 33.1 | 15.2 | 17 | PASS |
| 48 | 5240 | 32.4 | 15.1 | 17 | PASS |
| 52 | 5260 | 33.9 | 15.3 | 24 | PASS |
| 60 | 5300 | 32.4 | 15.1 | 24 | PASS |
| 64 | 5320 | 33.1 | 15.2 | 24 | PASS |
| 100 | 5500 | 30.9 | 14.9 | 24 | PASS |
| 116 | 5580 | 30.9 | 14.9 | 24 | PASS |
| 132 | 5660 | 32.4 | 15.1 | 24 | PASS |
| 140 | 5700 | 30.9 | 14.9 | 24 | PASS |

**802.11n (20MHz)**

| CHAN. | CHAN. FREQ. (MHz) | POWER OUTPUT (dBm) | | TOTAL POWER (mW) | TOTAL POWER (dBm) | POWER LIMIT (dBm) | PASS / FAIL |
|-------|-------------------|--------------------|---------|------------------|-------------------|-------------------|-------------|
| | | CHAIN 0 | CHAIN 1 | | | | |
| 36 | 5180 | 13.1 | 13.2 | 41.3 | 16.2 | 17 | PASS |
| 40 | 5200 | 13.1 | 13.5 | 42.8 | 16.3 | 17 | PASS |
| 48 | 5240 | 13.1 | 13.4 | 42.3 | 16.3 | 17 | PASS |
| 52 | 5260 | 13.1 | 13.5 | 42.8 | 16.3 | 24 | PASS |
| 60 | 5300 | 13.2 | 13.5 | 43.3 | 16.4 | 24 | PASS |
| 64 | 5320 | 13.1 | 13.6 | 43.3 | 16.4 | 24 | PASS |
| 100 | 5500 | 13.2 | 13.1 | 41.3 | 16.2 | 24 | PASS |
| 116 | 5580 | 13.3 | 13.2 | 42.3 | 16.3 | 24 | PASS |
| 132 | 5660 | 12.9 | 13.1 | 39.9 | 16.0 | 24 | PASS |
| 140 | 5700 | 12.9 | 13.3 | 40.9 | 16.1 | 24 | PASS |

802.11n (40MHz)

| CHAN. | CHAN. FREQ. (MHz) | POWER OUTPUT (dBm) | | TOTAL POWER (mW) | TOTAL POWER (dBm) | POWER LIMIT (dBm) | PASS / FAIL |
|-------|-------------------|--------------------|---------|------------------|-------------------|-------------------|-------------|
| | | CHAIN 0 | CHAIN 1 | | | | |
| 38 | 5190 | 13.1 | 13.8 | 44.4 | 16.5 | 17 | PASS |
| 46 | 5230 | 13.1 | 14.0 | 45.5 | 16.6 | 17 | PASS |
| 54 | 5270 | 13.2 | 14.0 | 46.0 | 16.6 | 24 | PASS |
| 62 | 5310 | 13.0 | 13.9 | 44.5 | 16.5 | 24 | PASS |
| 102 | 5510 | 13.1 | 13.5 | 42.8 | 16.3 | 24 | PASS |
| 110 | 5550 | 13.0 | 13.5 | 42.3 | 16.3 | 24 | PASS |
| 134 | 5670 | 13.2 | 13.6 | 43.8 | 16.4 | 24 | PASS |



A D T

26dB OCCUPIED BANDWIDTH: 802.11a

| CHANNEL | CHANNEL FREQUENCY (MHz) | 26dBc OCCUPIED BANDWIDTH (MHz) | PASS / FAIL |
|---------|-------------------------|--------------------------------|-------------|
| 36 | 5180 | 25.52 | PASS |
| 40 | 5200 | 22.99 | PASS |
| 48 | 5240 | 25.55 | PASS |
| 52 | 5260 | 25.15 | PASS |
| 60 | 5300 | 25.38 | PASS |
| 64 | 5320 | 25.28 | PASS |
| 100 | 5500 | 23.38 | PASS |
| 116 | 5580 | 25.83 | PASS |
| 132 | 5660 | 25.96 | PASS |
| 140 | 5700 | 25.89 | PASS |

CH 132

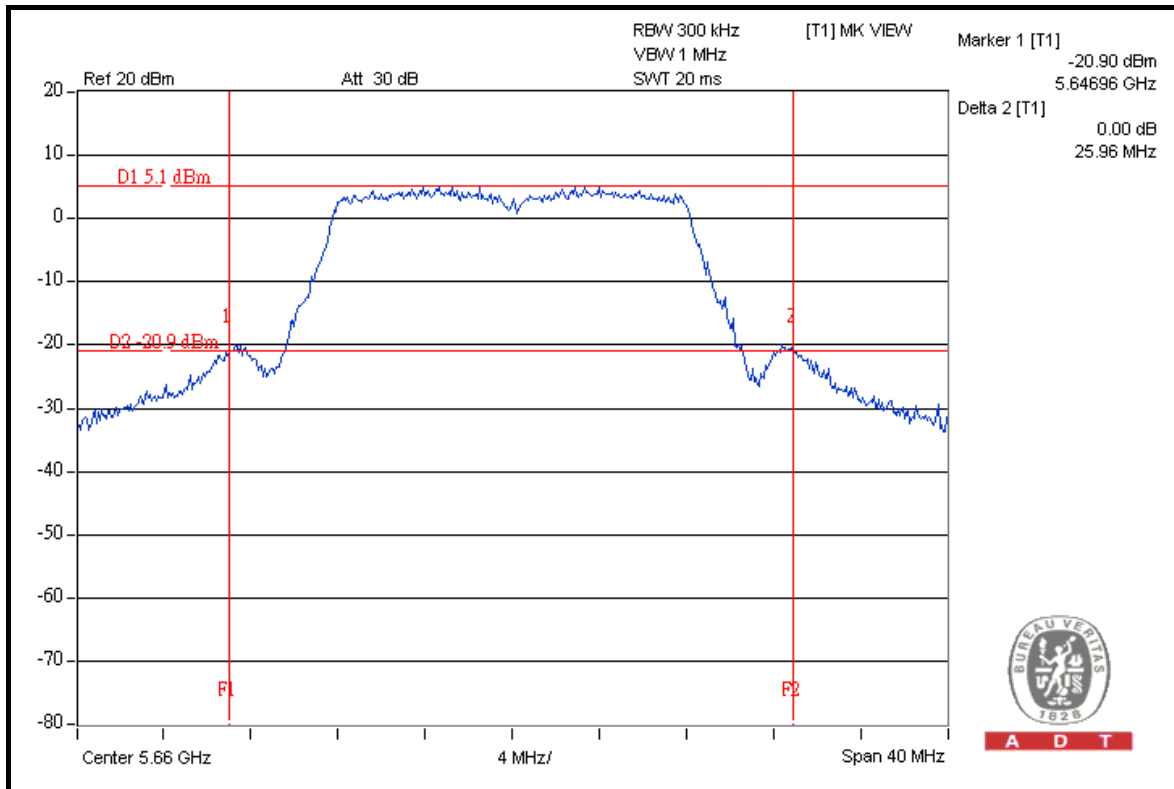



A D T

802.11n (20MHz)

| CHANNEL | CHANNEL FREQUENCY (MHz) | 26dBc OCCUPIED BANDWIDTH (MHz) | | PASS / FAIL |
|---------|-------------------------|--------------------------------|---------|-------------|
| | | CHAIN 0 | CHAIN 1 | |
| 36 | 5180 | 23.05 | 21.28 | PASS |
| 40 | 5200 | 24.96 | 23.07 | PASS |
| 48 | 5240 | 25.03 | 21.00 | PASS |
| 52 | 5260 | 23.28 | 23.12 | PASS |
| 60 | 5300 | 25.19 | 23.22 | PASS |
| 64 | 5320 | 24.88 | 25.21 | PASS |
| 100 | 5500 | 21.73 | 21.27 | PASS |
| 116 | 5580 | 26.06 | 24.82 | PASS |
| 132 | 5660 | 26.16 | 26.27 | PASS |
| 140 | 5700 | 25.52 | 21.10 | PASS |

FOR CHAIN 1: CH 132

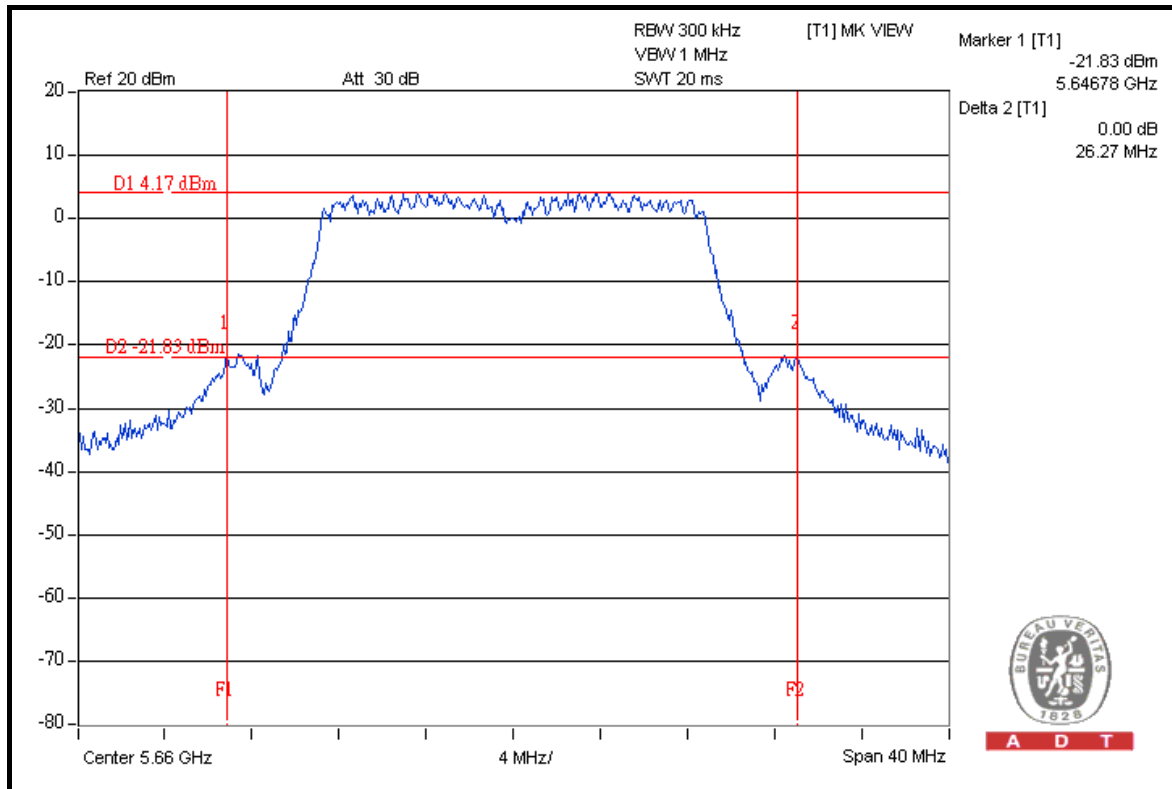

A D T



A D T

802.11n (40MHz)

| CHANNEL | CHANNEL FREQUENCY (MHz) | 26dBc OCCUPIED BANDWIDTH (MHz) | | PASS / FAIL |
|---------|-------------------------|--------------------------------|---------|-------------|
| | | CHAIN 0 | CHAIN 1 | |
| 38 | 5190 | 44.70 | 42.03 | PASS |
| 46 | 5230 | 42.47 | 43.97 | PASS |
| 54 | 5270 | 45.24 | 44.42 | PASS |
| 62 | 5310 | 44.89 | 44.13 | PASS |
| 102 | 5510 | 45.75 | 44.61 | PASS |
| 110 | 5550 | 45.33 | 44.59 | PASS |
| 134 | 5670 | 45.43 | 44.24 | PASS |

CHAIN 0: CH 102

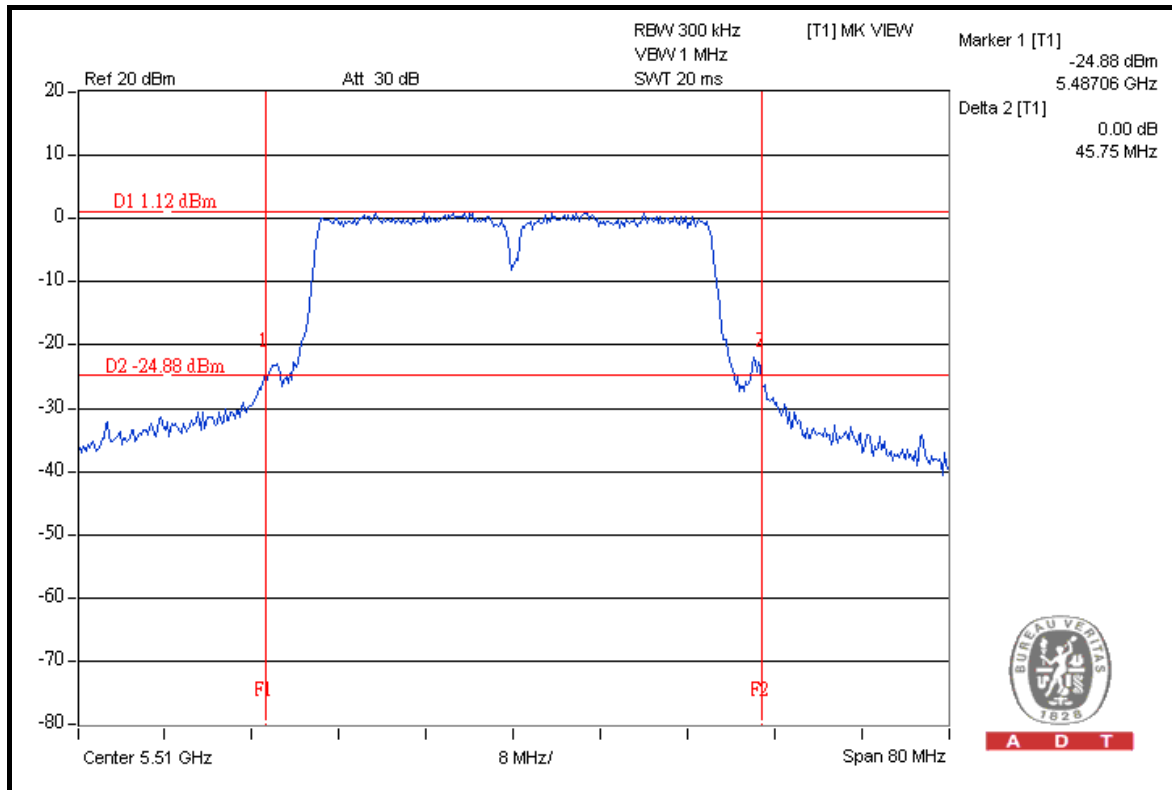

4.4 PEAK POWER EXCURSION MEASUREMENT

4.4.1 LIMITS OF PEAK POWER EXCURSION MEASUREMENT

| FREQUENCY BAND | LIMIT |
|------------------|-------|
| 5.150 ~ 5.250GHz | 13dB |
| 5.250 ~ 5.350GHz | 13dB |
| 5.470 ~ 5.725GHz | 13dB |

4.4.2 TEST INSTRUMENTS

| DESCRIPTION & MANUFACTURER | MODEL NO. | SERIAL NO. | DATE OF CALIBRATION | CALIBRATED UNTIL |
|----------------------------|-----------|------------|---------------------|------------------|
| R&S SPECTRUM ANALYZER | FSP40 | 100040 | Jul. 07, 2009 | Jul. 06, 2010 |

NOTE: The calibration interval of the above test instruments is 12 months and the calibrations are traceable to NML/ROC and NIST/USA.

4.4.3 TEST PROCEDURE

- a. The transmitter output was connected to the spectrum analyzer.
- b. Set the spectrum bandwidth span to view the entire spectrum.
- c. Using peak detector and Max-hold function for Trace 1 (RB = 1MHz, VB = 3MHz) and 2 (RB = 1MHz, VB = 300kHz).
- d. The differences between Trace1 and Trace 2 in any 1MHz band at f1 to f2 range were recorded and showed to another trace.

4.4.4 DEVIATION FROM TEST STANDARD

No deviation.

4.4.5 TEST SETUP

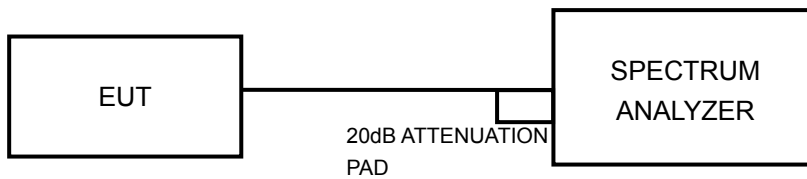

4.4.6 EUT OPERATING CONDITIONS

The software provided by client to enable the EUT under transmission condition continuously at specific channel frequencies individually.

4.4.7 TEST RESULTS

802.11a

| CHANNEL | CHANNEL FREQUENCY (MHz) | PEAK POWER EXCURSION (dB) | PEAK TO AVERAGE EXCURSION LIMIT (dB) | PASS/FAIL |
|---------|-------------------------|---------------------------|--------------------------------------|-----------|
| 36 | 5180 | 7.85 | 13 | PASS |
| 40 | 5200 | 9.80 | 13 | PASS |
| 48 | 5240 | 8.20 | 13 | PASS |
| 52 | 5260 | 8.16 | 13 | PASS |
| 60 | 5300 | 9.66 | 13 | PASS |
| 64 | 5320 | 8.53 | 13 | PASS |
| 100 | 5500 | 9.43 | 13 | PASS |
| 116 | 5580 | 8.78 | 13 | PASS |
| 132 | 5660 | 8.00 | 13 | PASS |
| 140 | 5700 | 8.59 | 13 | PASS |



A D T

CH 40

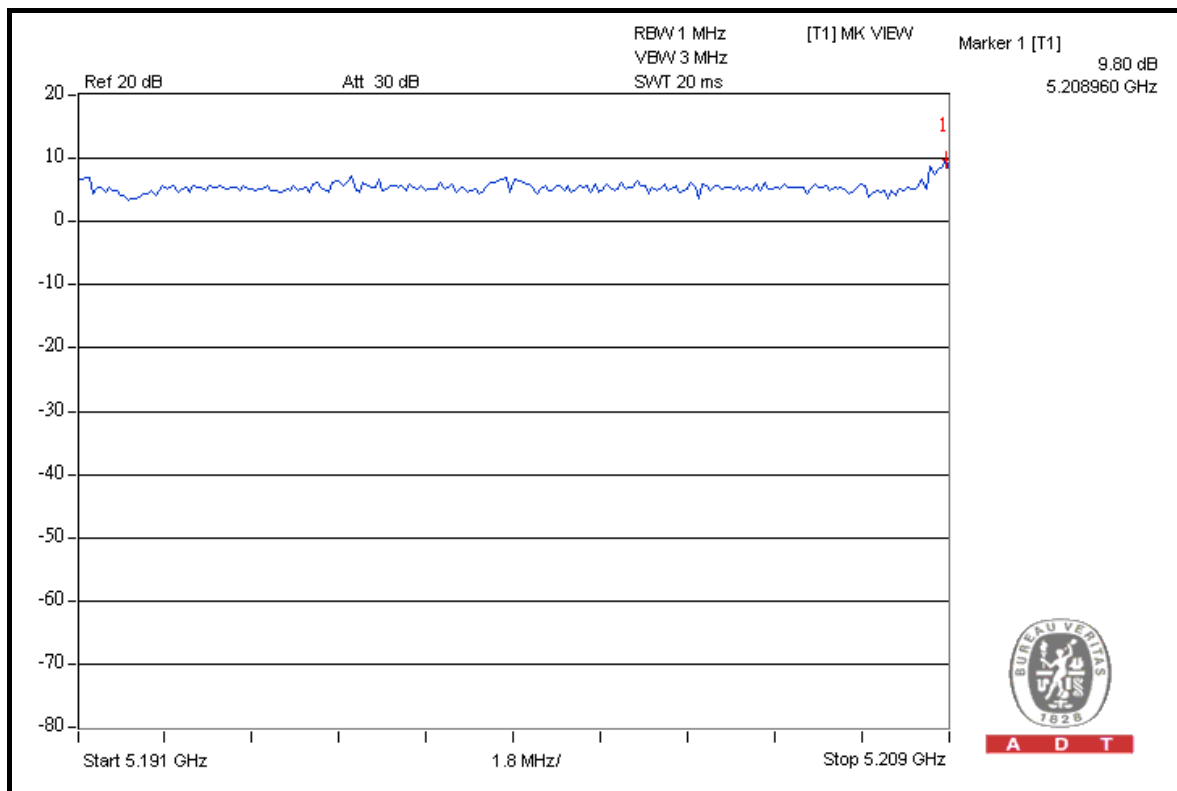
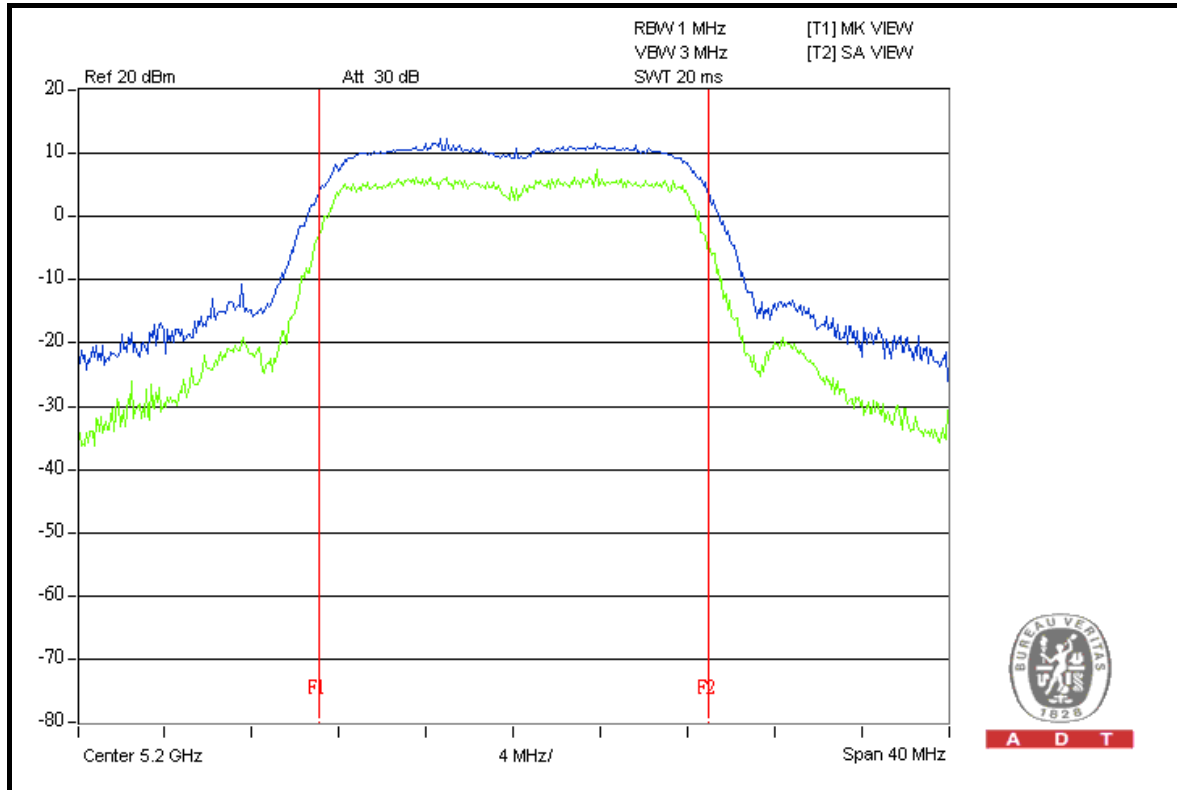



A D T

802.11n (20MHz)

| CHANNEL | CHANNEL FREQUENCY (MHz) | PEAK POWER EXCURSION (dB) | | PEAK to AVERAGE EXCURSION LIMIT (dB) | PASS/FAIL |
|---------|-------------------------|---------------------------|---------|--------------------------------------|-----------|
| | | CHAIN 0 | CHAIN 1 | | |
| 36 | 5180 | 7.40 | 7.07 | 13 | PASS |
| 40 | 5200 | 7.21 | 7.16 | 13 | PASS |
| 48 | 5240 | 8.40 | 7.70 | 13 | PASS |
| 52 | 5260 | 7.76 | 7.58 | 13 | PASS |
| 60 | 5300 | 7.99 | 7.26 | 13 | PASS |
| 64 | 5320 | 7.97 | 7.19 | 13 | PASS |
| 100 | 5500 | 8.53 | 7.46 | 13 | PASS |
| 116 | 5580 | 7.85 | 7.41 | 13 | PASS |
| 132 | 5660 | 7.57 | 7.73 | 13 | PASS |
| 140 | 5700 | 8.13 | 7.46 | 13 | PASS |



A D T

CHAIN 0: CH 100

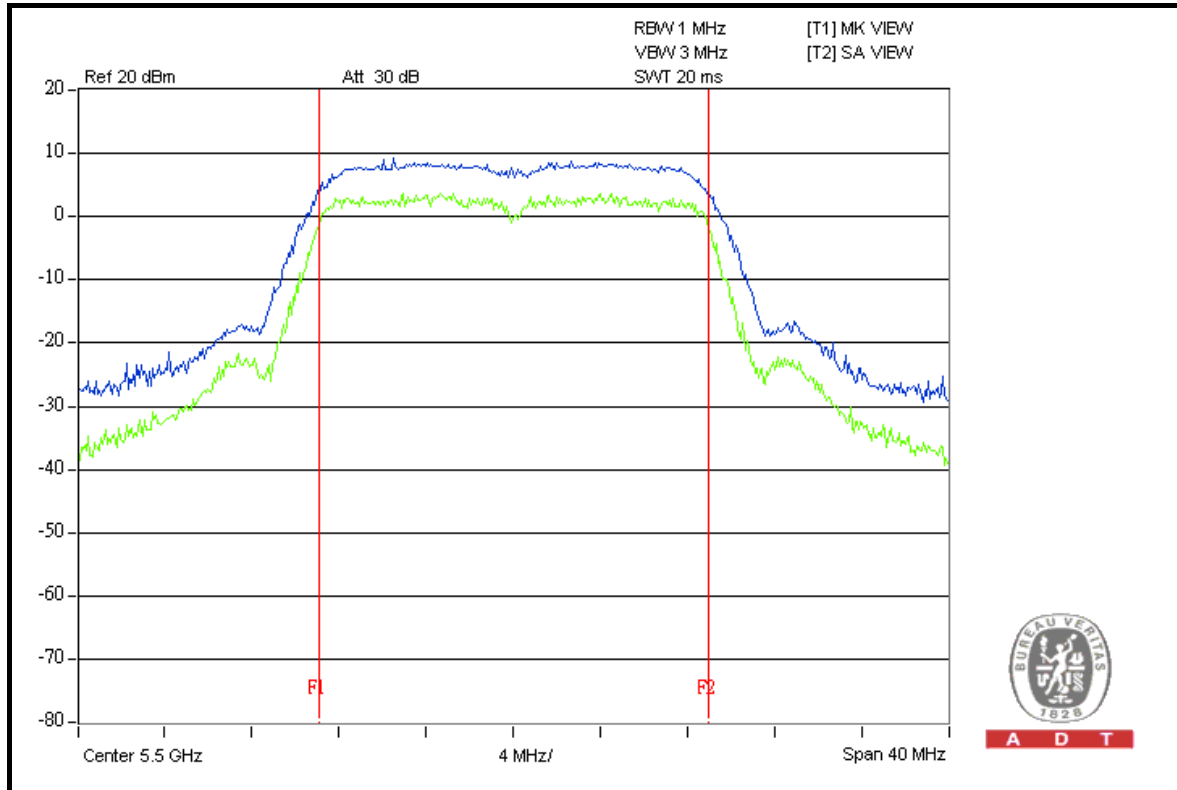

A D T

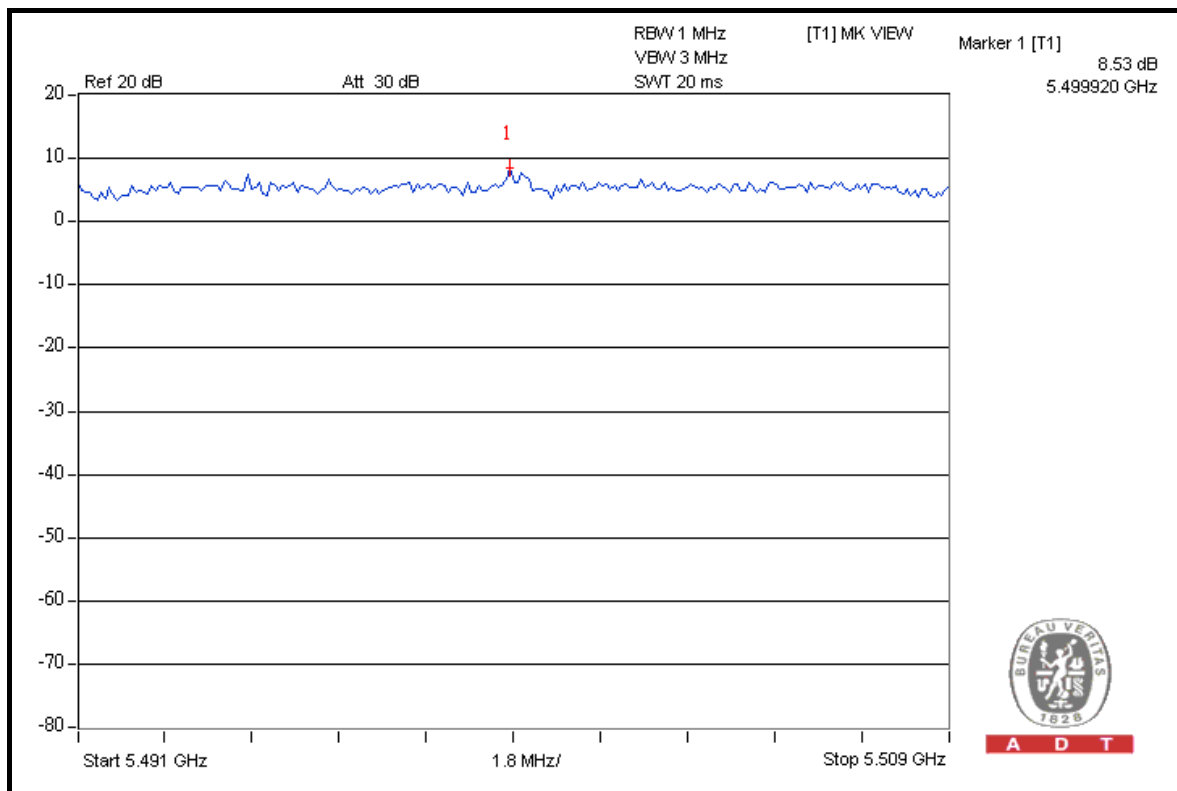

A D T



A D T

802.11n (40MHz)

| CHANNEL | CHANNEL FREQUENCY (MHz) | PEAK POWER EXCURSION (dB) | | PEAK to AVERAGE EXCURSION LIMIT (dB) | PASS/FAIL |
|---------|-------------------------|---------------------------|---------|--------------------------------------|-----------|
| | | CHAIN 0 | CHAIN 1 | | |
| 38 | 5190 | 8.53 | 8.38 | 13 | PASS |
| 46 | 5230 | 9.55 | 7.85 | 13 | PASS |
| 54 | 5270 | 8.03 | 8.00 | 13 | PASS |
| 62 | 5310 | 8.44 | 8.42 | 13 | PASS |
| 102 | 5510 | 8.23 | 8.49 | 13 | PASS |
| 110 | 5550 | 8.36 | 8.36 | 13 | PASS |
| 134 | 5670 | 8.68 | 7.60 | 13 | PASS |



A D T

CHAIN 0: CH 46

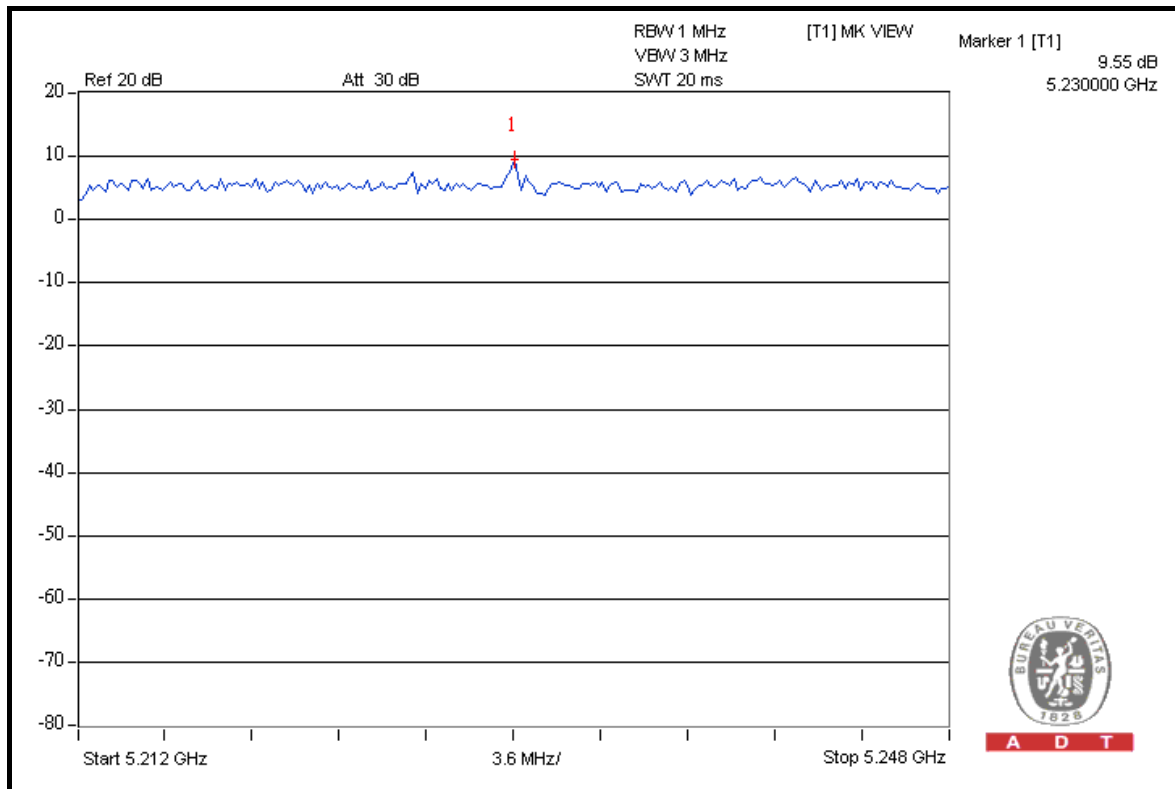
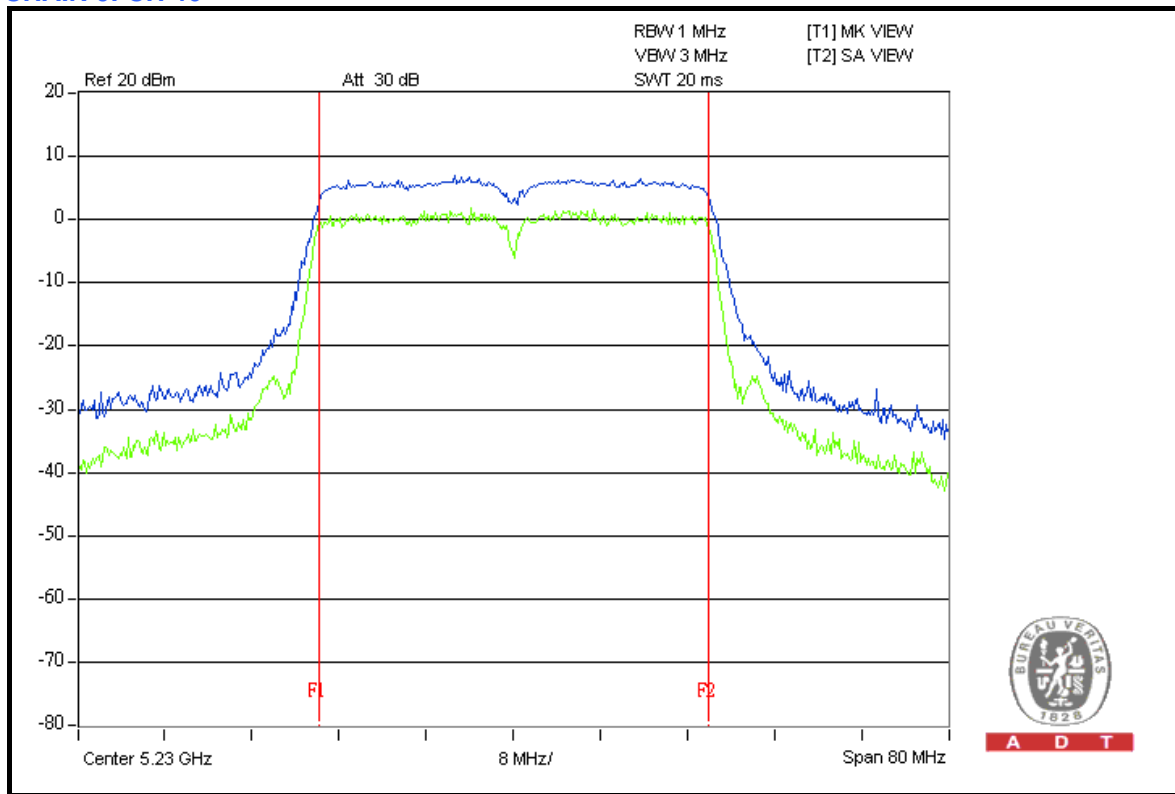

4.5 PEAK POWER SPECTRAL DENSITY MEASUREMENT

4.5.1 LIMITS OF PEAK POWER SPECTRAL DENSITY MEASUREMENT

| FREQUENCY BAND | LIMIT |
|------------------|-------|
| 5.150 ~ 5.250GHz | 4dBm |
| 5.250 ~ 5.350GHz | 11dBm |
| 5.470 ~ 5.725GHz | 11dBm |

4.5.2 TEST INSTRUMENTS

| DESCRIPTION & MANUFACTURER | MODEL NO. | SERIAL NO. | DATE OF CALIBRATION | CALIBRATED UNTIL |
|----------------------------|-----------|------------|---------------------|------------------|
| R&S SPECTRUM ANALYZER | FSP40 | 100040 | Jul. 07, 2009 | Jul. 06, 2010 |

NOTE: The calibration interval of the above test instruments is 12 months and the calibrations are traceable to NML/ROC and NIST/USA.

4.5.3 TEST PROCEDURES

- a. The transmitter output was connected to the spectrum analyzer.
- b. Set RBW = 1MHz, VBW = 3MHz. The PPSD is the highest level found across the emission in any 1MHz band.

4.5.4 DEVIATION FROM TEST STANDARD

No deviation.

4.5.5 TEST SETUP

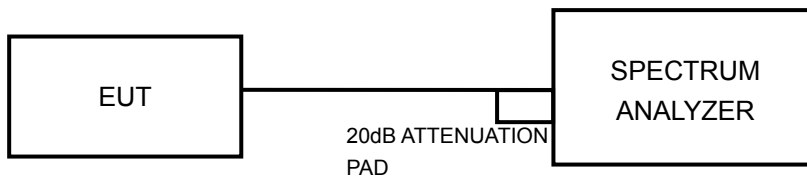

4.5.6 EUT OPERATING CONDITIONS

Same as 5.3.6.



A D T

4.5.7 TEST RESULTS

802.11a

| CHANNEL | CHANNEL FREQUENCY (MHz) | RF POWER LEVEL IN 1MHz BW (dBm) | MAXIMUM LIMIT (dBm) | PASS / FAIL |
|---------|--------------------------|---------------------------------|---------------------|-------------|
| 36 | 5180 | -2.3 | 4 | PASS |
| 40 | 5200 | -2.0 | 4 | PASS |
| 48 | 5240 | -2.0 | 4 | PASS |
| 52 | 5260 | -1.8 | 11 | PASS |
| 60 | 5300 | -2.1 | 11 | PASS |
| 64 | 5320 | -2.0 | 11 | PASS |
| 100 | 5500 | -2.3 | 11 | PASS |
| 116 | 5580 | -2.3 | 11 | PASS |
| 132 | 5660 | -2.1 | 11 | PASS |
| 140 | 5700 | -2.6 | 11 | PASS |

CH 52

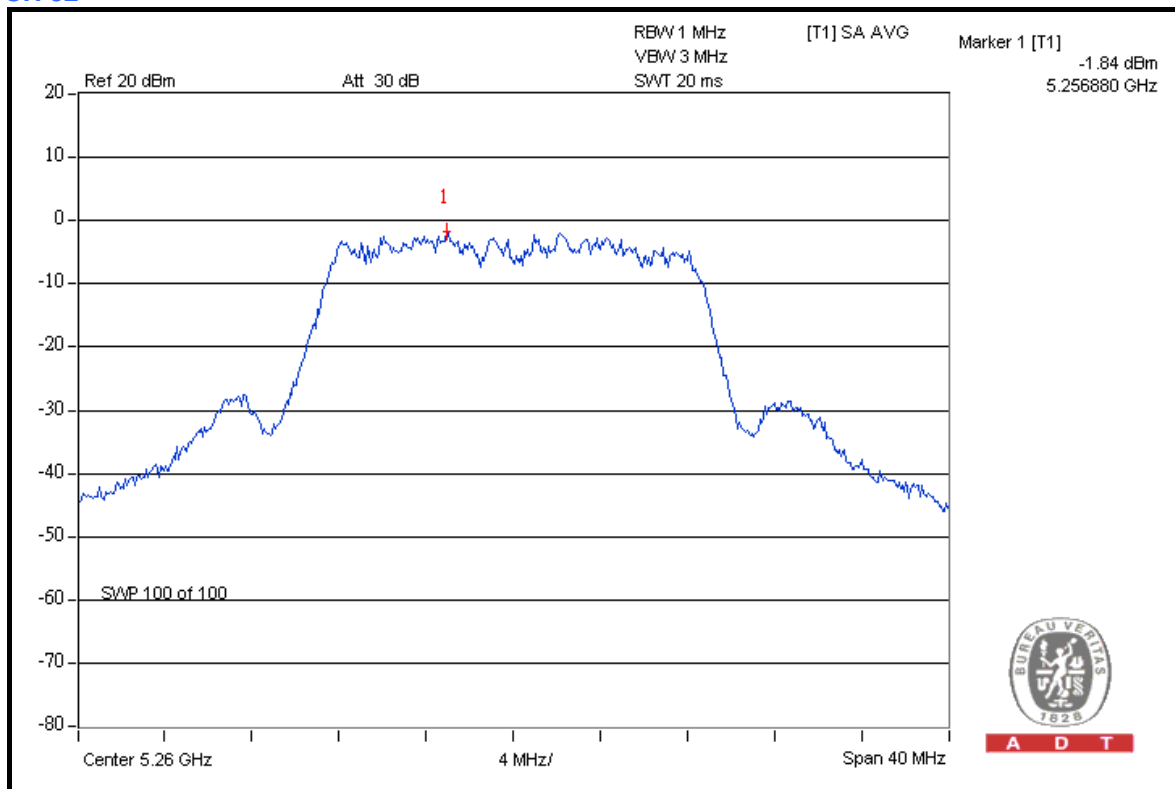

A D T



A D T

802.11n (20MHz)

| CHAN. | CHAN. FREQ. (MHz) | RF POWER LEVEL IN 1MHz BW (dBm) | | TOTAL POWER DENSITY (mW) | TOTAL POWER DENSITY (dBm) | MAX. LIMIT (dBm) | PASS / FAIL |
|-------|-------------------|---------------------------------|---------|--------------------------|---------------------------|------------------|-------------|
| | | CHAIN 0 | CHAIN 1 | | | | |
| 36 | 5180 | -5.9 | -7.3 | 0.4 | -3.5 | 4 | PASS |
| 40 | 5200 | -5.7 | -6.9 | 0.5 | -3.3 | 4 | PASS |
| 48 | 5240 | -5.7 | -6.9 | 0.5 | -3.3 | 4 | PASS |
| 52 | 5260 | -5.7 | -6.8 | 0.5 | -3.2 | 11 | PASS |
| 60 | 5300 | -6.0 | -6.9 | 0.5 | -3.3 | 11 | PASS |
| 64 | 5320 | -5.8 | -6.7 | 0.5 | -3.2 | 11 | PASS |
| 100 | 5500 | -5.8 | -7.4 | 0.4 | -3.5 | 11 | PASS |
| 116 | 5580 | -5.5 | -7.4 | 0.5 | -3.4 | 11 | PASS |
| 132 | 5660 | -6.0 | -7.3 | 0.4 | -3.6 | 11 | PASS |
| 140 | 5700 | -5.9 | -7.1 | 0.5 | -3.5 | 11 | PASS |

CHAIN 0: CH 116

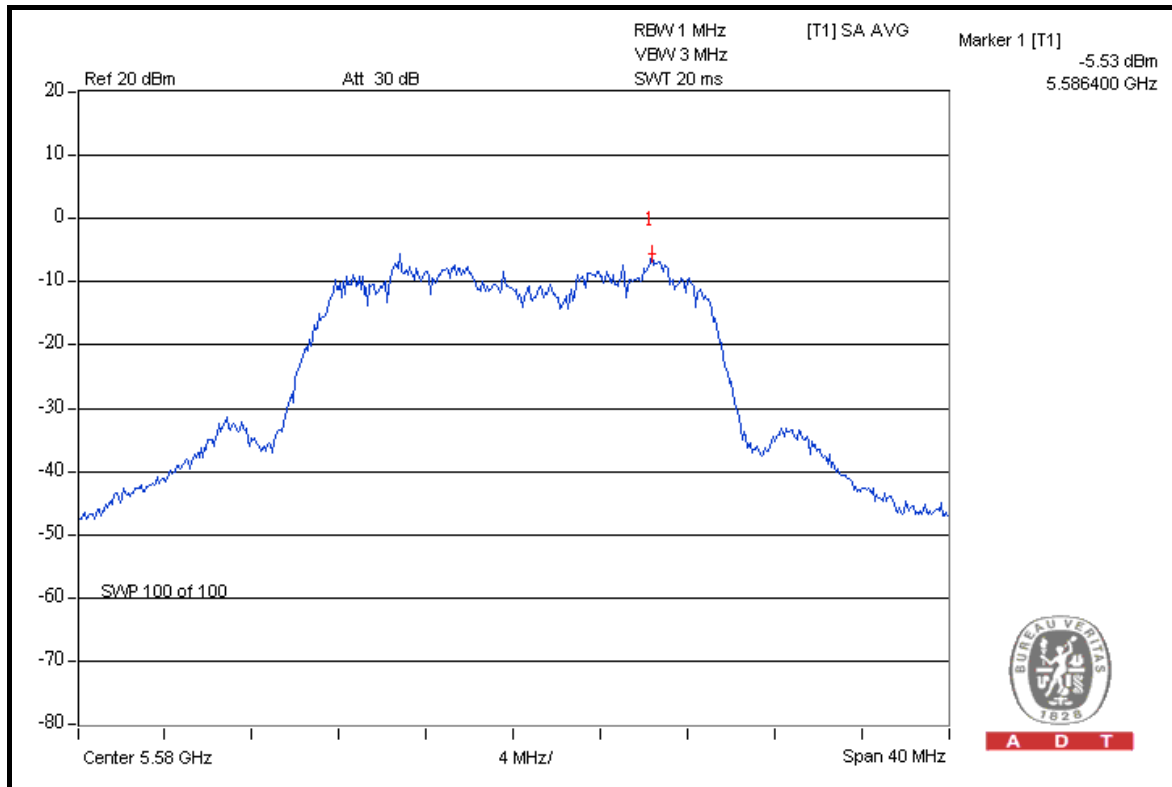



A D T

802.11n (40MHz)

| CHAN. | CHAN. FREQ. (MHz) | RF POWER LEVEL IN 1MHz BW (dBm) | | TOTAL POWER DENSITY (mW) | TOTAL POWER DENSITY (dBm) | MAX. LIMIT (dBm) | PASS / FAIL |
|-------|-------------------|---------------------------------|---------|--------------------------|---------------------------|------------------|-------------|
| | | CHAIN 0 | CHAIN 1 | | | | |
| 38 | 5190 | -13.0 | -12.3 | 0.1 | -9.6 | 4 | PASS |
| 46 | 5230 | -12.9 | -11.9 | 0.1 | -9.3 | 4 | PASS |
| 54 | 5270 | -12.8 | -11.8 | 0.1 | -9.2 | 11 | PASS |
| 62 | 5310 | -12.9 | -12.0 | 0.1 | -9.4 | 11 | PASS |
| 102 | 5510 | -12.9 | -12.4 | 0.1 | -9.6 | 11 | PASS |
| 110 | 5550 | -13.2 | -12.6 | 0.1 | -9.9 | 11 | PASS |
| 134 | 5670 | -12.8 | -12.3 | 0.1 | -9.5 | 11 | PASS |

CHAIN 1: CH 54

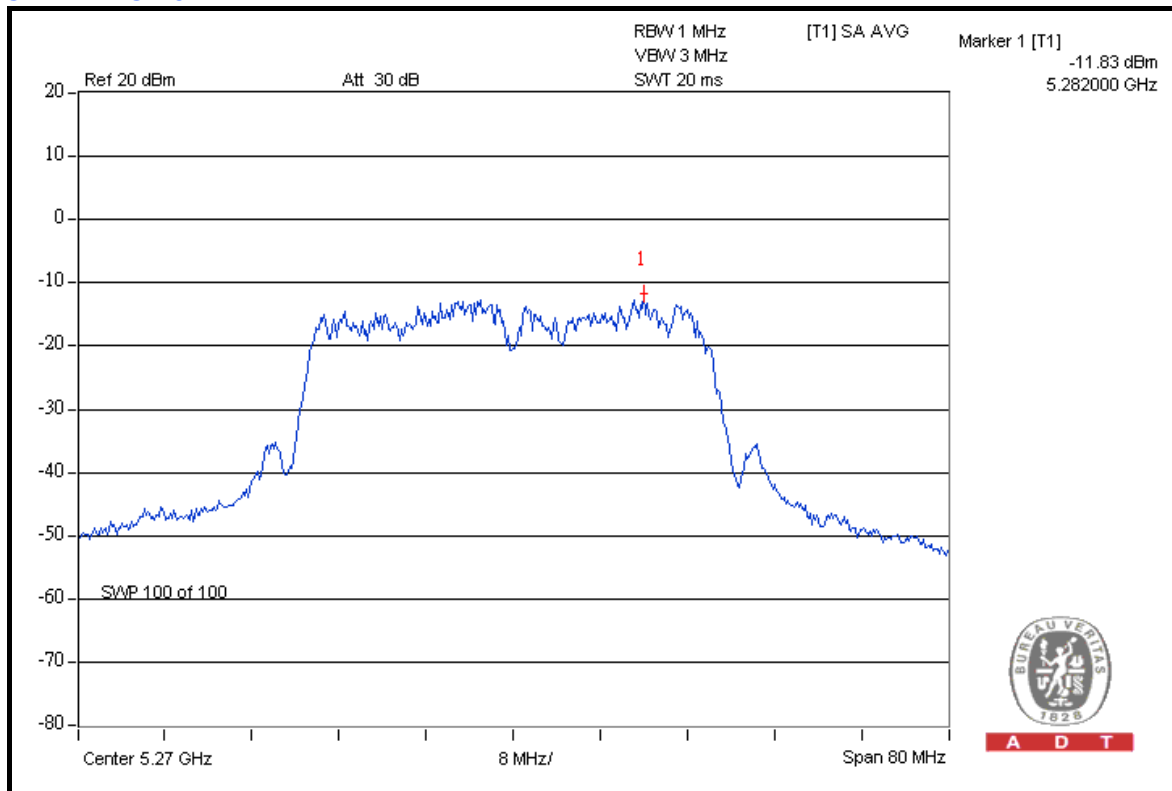

4.6 FREQUENCY STABILITY

4.6.1 LIMITS OF FREQUENCY STABILITY MEASUREMENT

The frequency tolerance of the carrier signal shall be maintained within the band of operation frequency over a temperature variation of –30 degrees to 50 degrees C at normal supply voltage, and for a variation in the primary supply voltage from 85% to 115% of the rated supply voltage at a temperature of 20 degrees C.

4.6.2 TEST INSTRUMENTS

| DESCRIPTION & MANUFACTURER | MODEL NO. | SERIAL NO. | DATE OF CALIBRATION | CALIBRATED UNTIL |
|---|-----------|------------|---------------------|------------------|
| R&S SPECTRUM ANALYZER | FSP40 | 100040 | Jul. 07, 2009 | Jul. 06, 2010 |
| WIT STANDARD TEMPERATURE AND HUMIDITY CHAMBER | TH-4S-C | W981030 | Jun. 24, 2008 | Jun. 23, 2010 |

NOTE: The calibration interval of the above test instruments is 12 months and the calibrations are traceable to NML/ROC and NIST/USA.

4.6.3 TEST PROCEDURE

- a. The EUT was placed inside the environmental test chamber and powered by nominal DC voltage.
- b. Turn the EUT on and couple its output to a spectrum analyzer.
- c. Turn the EUT off and set the chamber to the highest temperature specified.
- d. Allow sufficient time (approximately 30 min) for the temperature of the chamber to stabilize, turn the EUT on and measure the operating frequency after 2, 5, and 10 minutes.
- e. Repeat step 2 and 3 with the temperature chamber set to the lowest temperature.
- f. The test chamber was allowed to stabilize at +20 degree C for a minimum of 30 minutes. The supply voltage was then adjusted on the EUT from 85% to 115% and the frequency record.

4.6.4 DEVIATION FROM TEST STANDARD

No deviation.

4.6.5 TEST SETUP

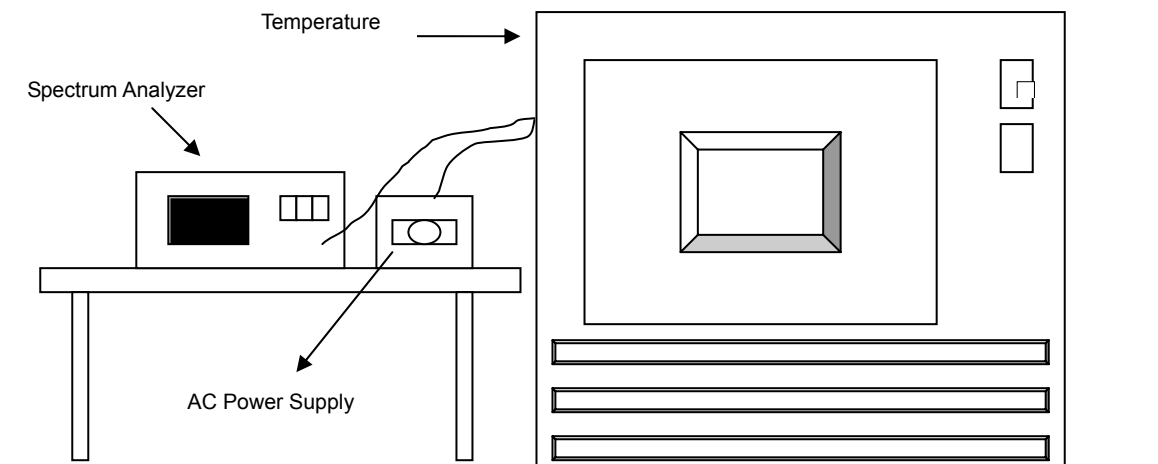

4.6.6 EUT OPERATING CONDITION

Same as Item 4.1.6.



4.6.7 TEST RESULTS

| FREQUENCY STABILITY VERSUS TEMP. | | | | | | | | | |
|----------------------------------|--------------------|--------------------------|-----------------------|--------------------------|-----------------------|--------------------------|-----------------------|--------------------------|-----------------------|
| OPERATING FREQUENCY: 5320MHz | | | | | | | | | |
| TEMP. (°C) | POWER SUPPLY (Vac) | 0 MINUTE | | 2 MINUTE | | 5 MINUTE | | 10 MINUTE | |
| | | Measured Frequency (MHz) | Frequency Drift (ppm) | Measured Frequency (MHz) | Frequency Drift (ppm) | Measured Frequency (MHz) | Frequency Drift (ppm) | Measured Frequency (MHz) | Frequency Drift (ppm) |
| 70 | 110.0 | 5319.988467 | -2.168 | 5319.988584 | -2.146 | 5319.988921 | -2.083 | 5319.988809 | -2.104 |
| 60 | 110.0 | 5319.987658 | -2.320 | 5319.988288 | -2.202 | 5319.987650 | -2.321 | 5319.988195 | -2.219 |
| 50 | 110.0 | 5319.987984 | -2.259 | 5319.987683 | -2.315 | 5319.987793 | -2.295 | 5319.988066 | -2.243 |
| 40 | 110.0 | 5319.987861 | -2.282 | 5319.987840 | -2.286 | 5319.987926 | -2.270 | 5319.987982 | -2.259 |
| 30 | 110.0 | 5319.989938 | -1.891 | 5319.990517 | -1.783 | 5319.990114 | -1.858 | 5319.989759 | -1.925 |
| 20 | 110.0 | 5319.991238 | -1.647 | 5319.991027 | -1.687 | 5319.991415 | -1.614 | 5319.991435 | -1.610 |
| 10 | 110.0 | 5319.993024 | -1.311 | 5319.993159 | -1.286 | 5319.993506 | -1.221 | 5319.993191 | -1.280 |
| 0 | 110.0 | 5319.991097 | -1.673 | 5319.991228 | -1.649 | 5319.990993 | -1.693 | 5319.991192 | -1.656 |
| -10 | 110.0 | 5319.989489 | -1.976 | 5319.989450 | -1.983 | 5319.989477 | -1.978 | 5319.989222 | -2.026 |
| -20 | 110.0 | 5319.989379 | -1.996 | 5319.989203 | -2.030 | 5319.989563 | -1.962 | 5319.989753 | -1.926 |
| -30 | 110.0 | 5319.988434 | -2.174 | 5319.988516 | -2.159 | 5319.988854 | -2.095 | 5319.988236 | -2.211 |

| FREQUENCY STABILITY VERSUS VOLTAGE | | | | | | | | | |
|------------------------------------|--------------------|--------------------------|-----------------------|--------------------------|-----------------------|--------------------------|-----------------------|--------------------------|-----------------------|
| OPERATING FREQUENCY: 5320MHz | | | | | | | | | |
| TEMP. (°C) | POWER SUPPLY (Vac) | 0 MINUTE | | 2 MINUTE | | 5 MINUTE | | 10 MINUTE | |
| | | Measured Frequency (MHz) | Frequency Drift (ppm) | Measured Frequency (MHz) | Frequency Drift (ppm) | Measured Frequency (MHz) | Frequency Drift (ppm) | Measured Frequency (MHz) | Frequency Drift (ppm) |
| 20 | 93.5 | 5319.989390 | -1.994 | 5319.989273 | -2.016 | 5319.989781 | -1.921 | 5319.989604 | -1.954 |
| | 110.0 | 5319.990981 | -1.695 | 5319.990787 | -1.732 | 5319.991197 | -1.655 | 5319.991385 | -1.619 |
| | 126.5 | 5319.992589 | -1.393 | 5319.992253 | -1.456 | 5319.992424 | -1.424 | 5319.992531 | -1.404 |



4.7 BAND EDGES MEASUREMENT

4.7.1 TEST INSTRUMENTS

| DESCRIPTION & MANUFACTURER | MODEL NO. | SERIAL NO. | DATE OF CALIBRATION | DUE DATE OF CALIBRATION |
|---|--------------------------|-------------|---------------------|-------------------------|
| FOR CONDUCTED MEASUREMENT: | | | | |
| R&S SPECTRUM ANALYZER | FSP40 | 100040 | Jul. 07, 2009 | Jul. 06, 2010 |
| FOR RADIATED MEASUREMENT: | | | | |
| Test Receiver ROHDE & SCHWARZ | ESI7 | 100033 | Jul. 06, 2009 | Jul. 05, 2010 |
| Spectrum Analyzer ROHDE & SCHWARZ | FSP40 | 100076 | May 26, 2009 | May 25, 2010 |
| BILOG Antenna SCHWARZBECK | VULB9168 | 9168-160 | Apr. 27, 2009 | Apr. 26, 2010 |
| HORN Antenna SCHWARZBECK | 9120D | 9120D-209 | Jul. 01, 2009 | Jun. 30, 2010 |
| HORN Antenna SCHWARZBECK | BBHA 9170 | BBHA9170243 | Dec. 25, 2009 | Dec. 24, 2010 |
| Preamplifier Agilent | 8447D | 2944A10633 | Nov. 10, 2009 | Nov. 09, 2010 |
| Preamplifier Agilent | 8449B | 3008A01964 | Nov. 09, 2009 | Nov. 08, 2010 |
| RF signal cable HUBER+SUHNNER | SUCOFLEX 104 | 238141/4 | May 13, 2009 | May 12, 2010 |
| RF signal cable HUBER+SUHNNER | SUCOFLEX 104 | 12738/6 | May 13, 2009 | May 12, 2010 |
| Software ADT. | ADT_Radiated_V7.6.15.9.2 | NA | NA | NA |
| Antenna Tower inn-co GmbH | MA 4000 | 013303 | NA | NA |
| Antenna Tower Controller inn-co GmbH | CO2000 | 017303 | NA | NA |
| Turn Table ADT. | TT100. | TT93021703 | NA | NA |
| Turn Table Controller ADT. | SC100. | SC93021703 | NA | NA |
| 26GHz ~ 40GHz Amplifier | EM26400 | 07026401 | Aug. 27, 2009 | Aug. 26, 2010 |

NOTE: The calibration interval of the above test instruments is 12 months and the calibrations are traceable to NML/ROC and NIST/USA.

4.7.2 TEST PROCEDURE

FOR CONDUCTED MEASUREMENT:

The transmitter output was connected to the spectrum analyzer via a low loss cable. Set both RBW and VBW of spectrum analyzer to 1MHz and 3MHz with suitable frequency span including 100MHz bandwidth from band edge. The band edges was measured and recorded.

FOR RADIATED MEASUREMENT:

- a. The EUT was placed on the top of a rotating table 0.8 meters above the ground at a 3 meter semi-anechoic chamber. The table was rotated 360 degrees to determine the position of the highest radiation.
- b. The EUT was set 3 meters away from the interference-receiving antenna, which was mounted on the top of a variable-height antenna tower.
- c. The antenna is a broadband antenna, and its height is varied from one meter to four meters above the ground to determine the maximum value of the field strength. Both horizontal and vertical polarizations of the antenna are set to make the measurement.
- d. For each suspected emission, the EUT was arranged to its worst case and then the antenna was tuned to heights from 1 meter to 4 meters and the rotatable table was turned from 0 degrees to 360 degrees to find the maximum reading.
- e. Set both RBW and VBW of spectrum analyzer to 1MHz and 3MHz with suitable frequency span including 100MHz bandwidth from band edge. The band edges was measured and recorded.

NOTE: The resolution bandwidth of test receiver/spectrum analyzer is 1MHz and the video bandwidth is 10Hz for Average detection (AV) at frequency above 1GHz

4.7.3 EUT OPERATING CONDITION

The software provided by client to enable the EUT under transmission condition continuously at specific channel frequencies individually.

4.7.4 TEST RESULTS

For signals in the restricted bands above and below the 5.15 to 5.25GHz allocated band a measurement was made of the amplitude of the spurious emissions with respect to the intentional signals. The relative amplitude, in dBc, was applied to the average and peak field strength of the intentional signal made on the OATS to calculate the field strength of the unintentional signals.

The spectrum plots (Peak RBW = 1MHz, VBW = 3MHz) are attached on the following pages.

FOR 5180-5320MHz BAND: 802.11a

RESTRICT BAND (4500 ~ 5150 MHz)

| FREQUENCY (MHz) | FUNDAMENTAL EMISSION (dBuV/m) | DELTA (dB) | MAXIMUM FIELD STRENGTH IN RESTRICT BAND (dBuV/m) | LIMIT (dBuV/m) |
|-----------------|-------------------------------|------------|--|----------------|
| 5180.00 (PK) | 108.6 | 45.58 | 63.02 | 74.00 |
| 5180.00 (AV) | 94.3 | 52.40 | 41.90 | 54.00 |

RESTRICT BAND (5350 ~ 5460 MHz)

| FREQUENCY (MHz) | FUNDAMENTAL EMISSION (dBuV/m) | DELTA (dB) | MAXIMUM FIELD STRENGTH IN RESTRICT BAND (dBuV/m) | LIMIT (dBuV/m) |
|-----------------|-------------------------------|------------|--|----------------|
| 5320.00 (PK) | 109.5 | 42.28 | 67.22 | 74.00 |
| 5320.00 (AV) | 95.6 | 51.78 | 43.82 | 54.00 |

NOTE:

- Delta = Amplitude between the peak of the fundamental and the peak of the band edge emission. Please check following 3 pages.
- Maximum field strength in restrict band = Fundamental emission – Delta.



A D T

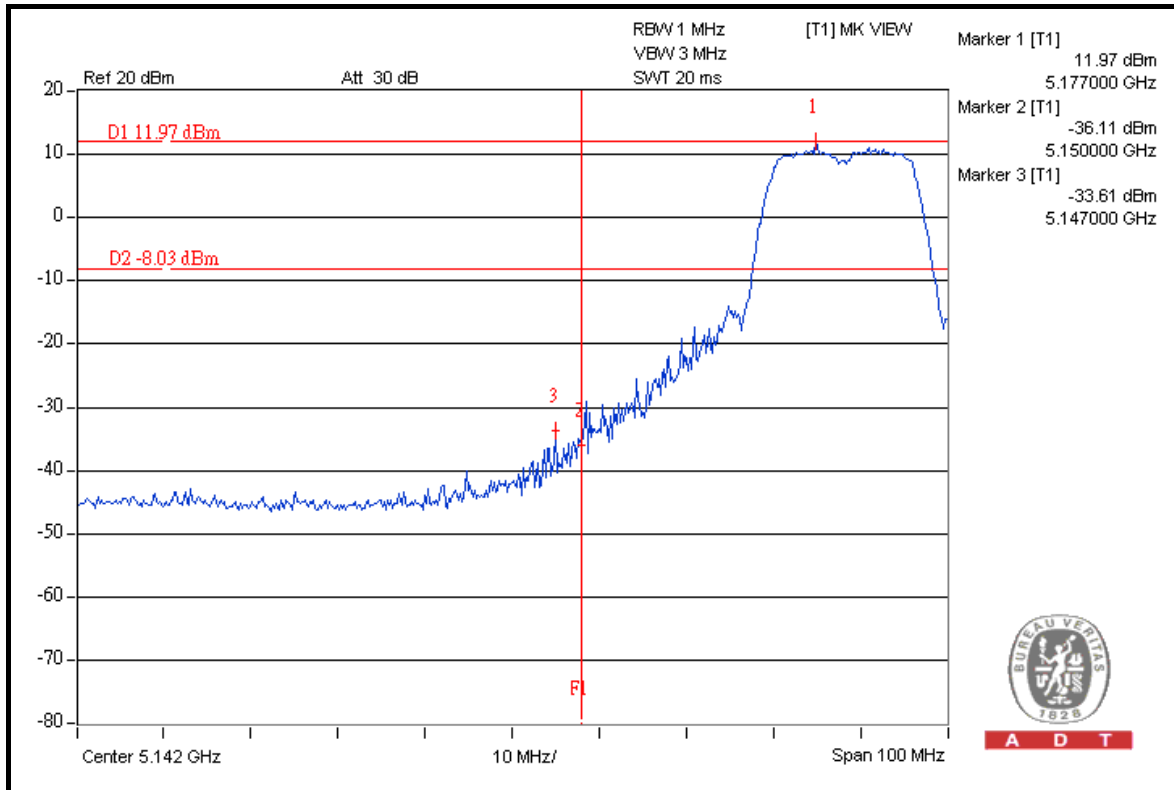

A D T

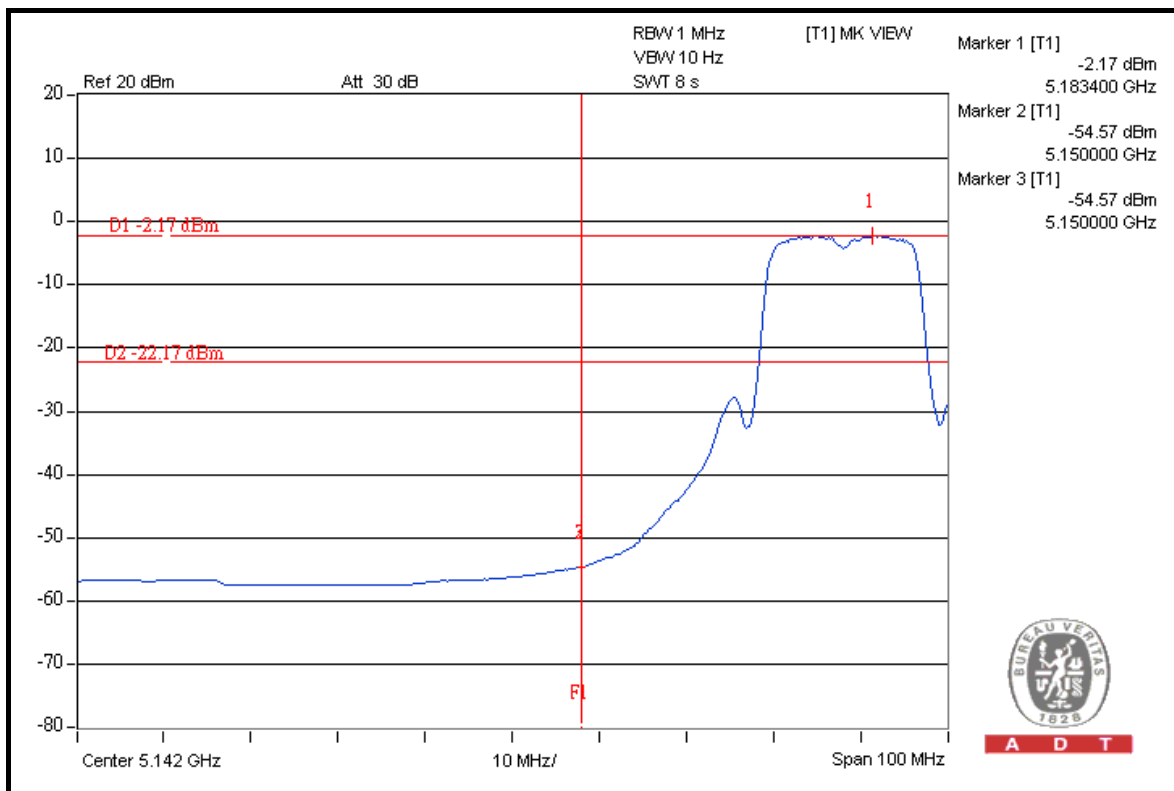

A D T



A D T

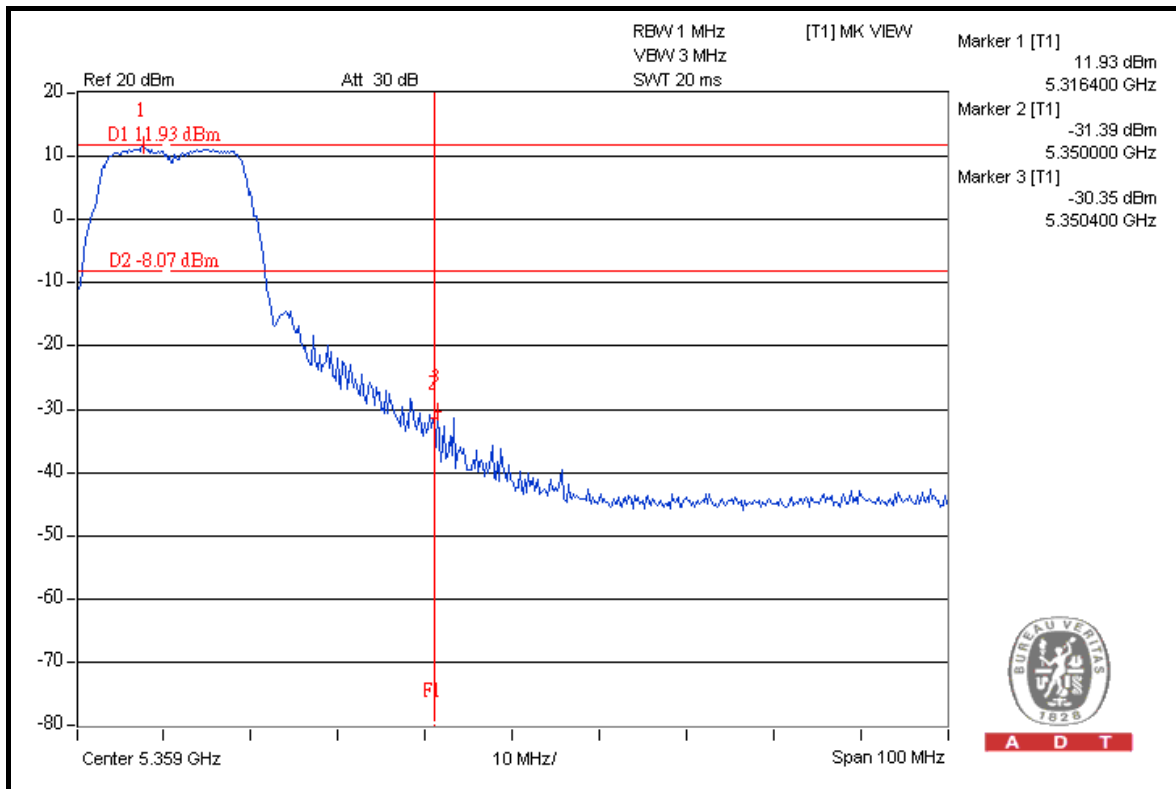
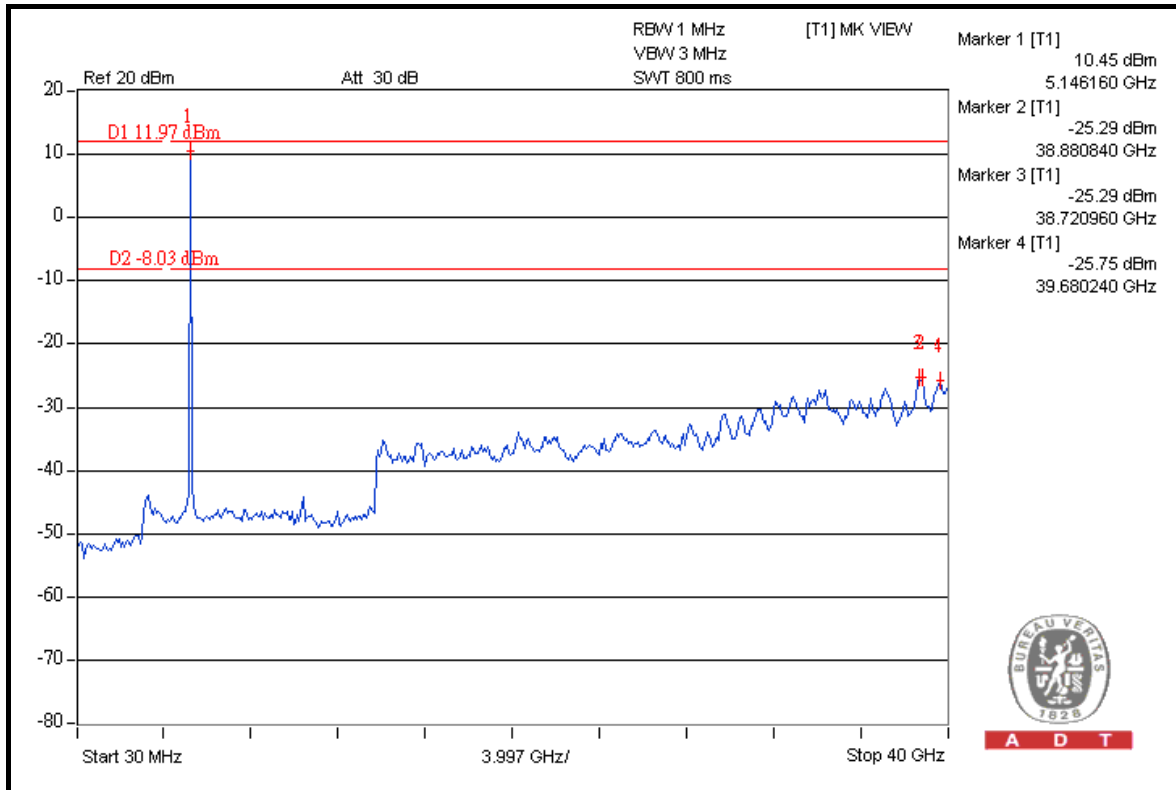



A D T

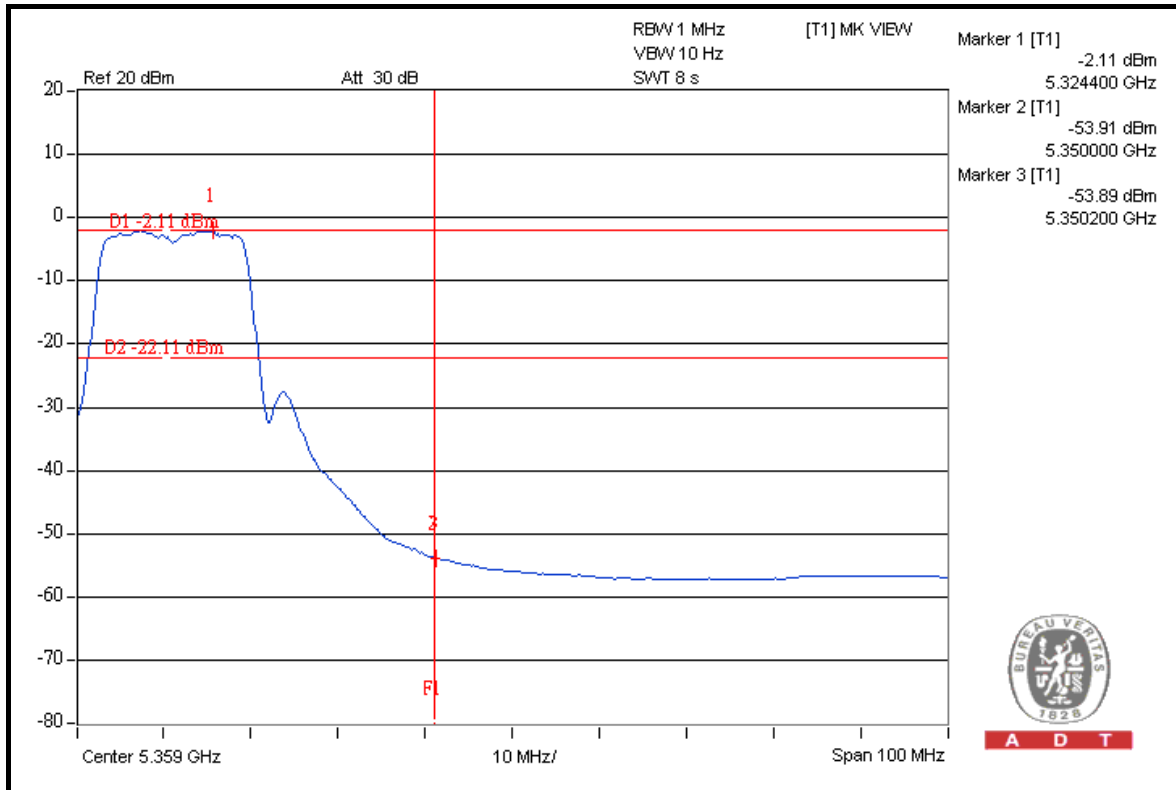

A D T

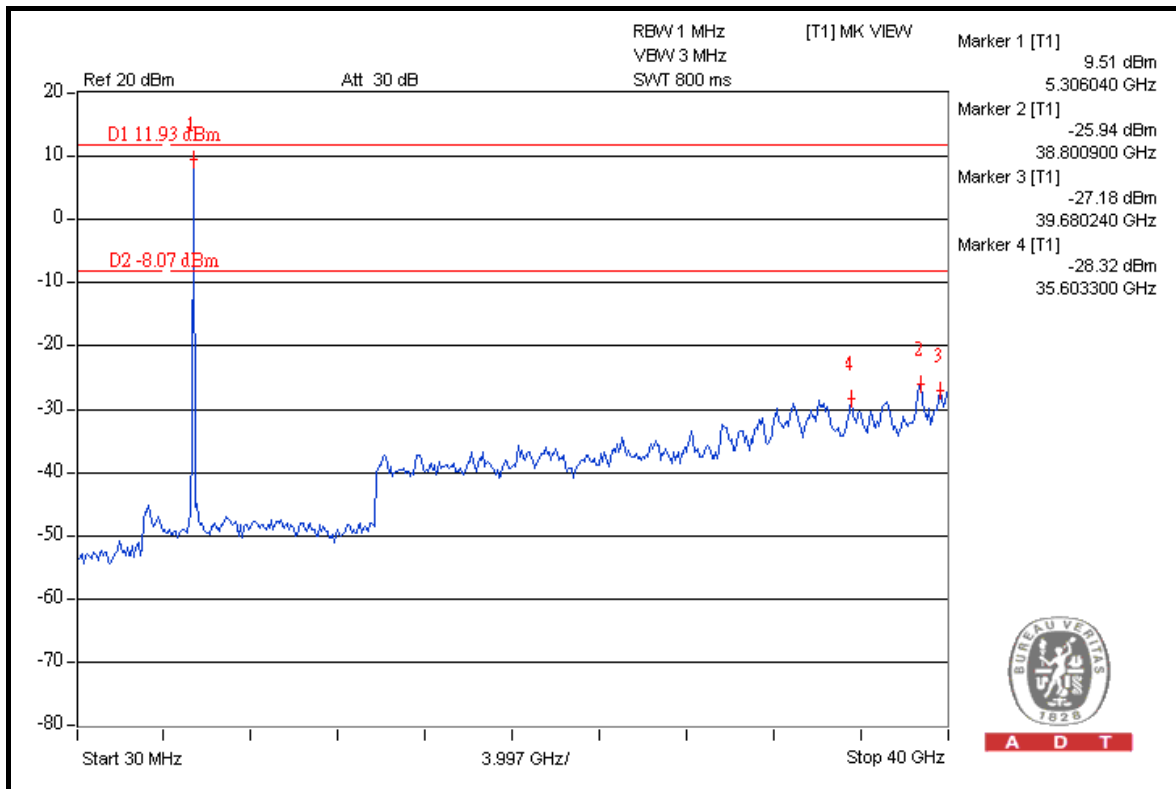

A D T

FOR 5500-5700MHz BAND:

802.11a

5500MHz

RESTRICT BAND (5350 ~ 5460 MHz)

| FREQUENCY (MHz) | FUNDAMENTAL EMISSION (dBuV/m) | DELTA (dB) | MAXIMUM FIELD STRENGTH IN RESTRICT BAND (dBuV/m) | LIMIT (dBuV/m) |
|-----------------|-------------------------------|------------|--|----------------|
| 5500.00 (PK) | 109.3 | 51.17 | 58.13 | 74.00 |
| 5500.00 (AV) | 95.4 | 53.44 | 41.96 | 54.00 |

FREQUENCY BAND (5460 ~ 5470 MHz)

| FREQUENCY (MHz) | FUNDAMENTAL EMISSION (dBuV/m) | DELTA (dB) | MAXIMUM FIELD STRENGTH (dBuV/m) | LIMIT (dBuV/m) |
|-----------------|-------------------------------|------------|---------------------------------|----------------|
| 5500.00 (PK) | 109.3 | 43.31 | 65.99 | 68.30 |

5700MHz

ABOVE 5725 MHz

| FREQUENCY (MHz) | FUNDAMENTAL EMISSION (dBuV/m) | DELTA (dB) | MAXIMUM FIELD STRENGTH (dBuV/m) | LIMIT (dBuV/m) |
|-----------------|-------------------------------|------------|---------------------------------|----------------|
| 5700.00 (PK) | 108.7 | 41.93 | 66.77 | 68.30 |

NOTE:

1. Delta = Amplitude between the peak of the fundamental and the peak of the band edge emission. Please check following 3 pages.
2. Maximum field strength in restrict band = Fundamental emission – Delta.



A D T

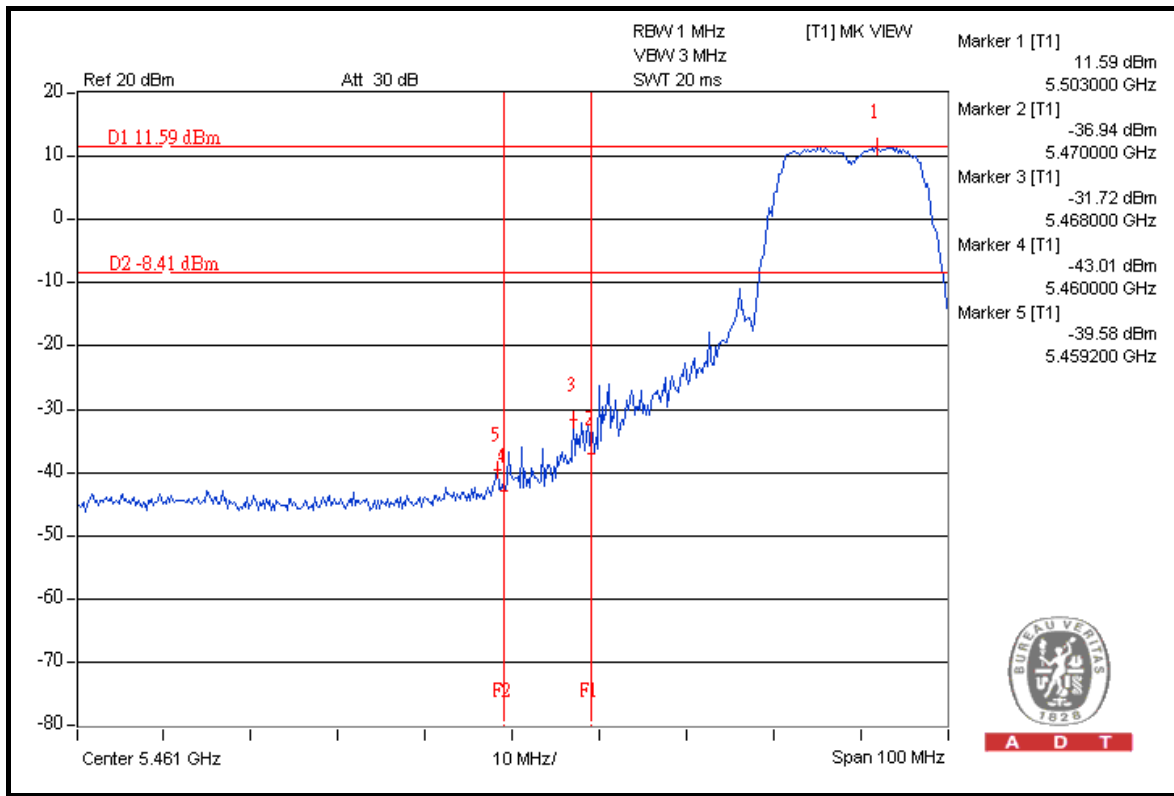

A D T

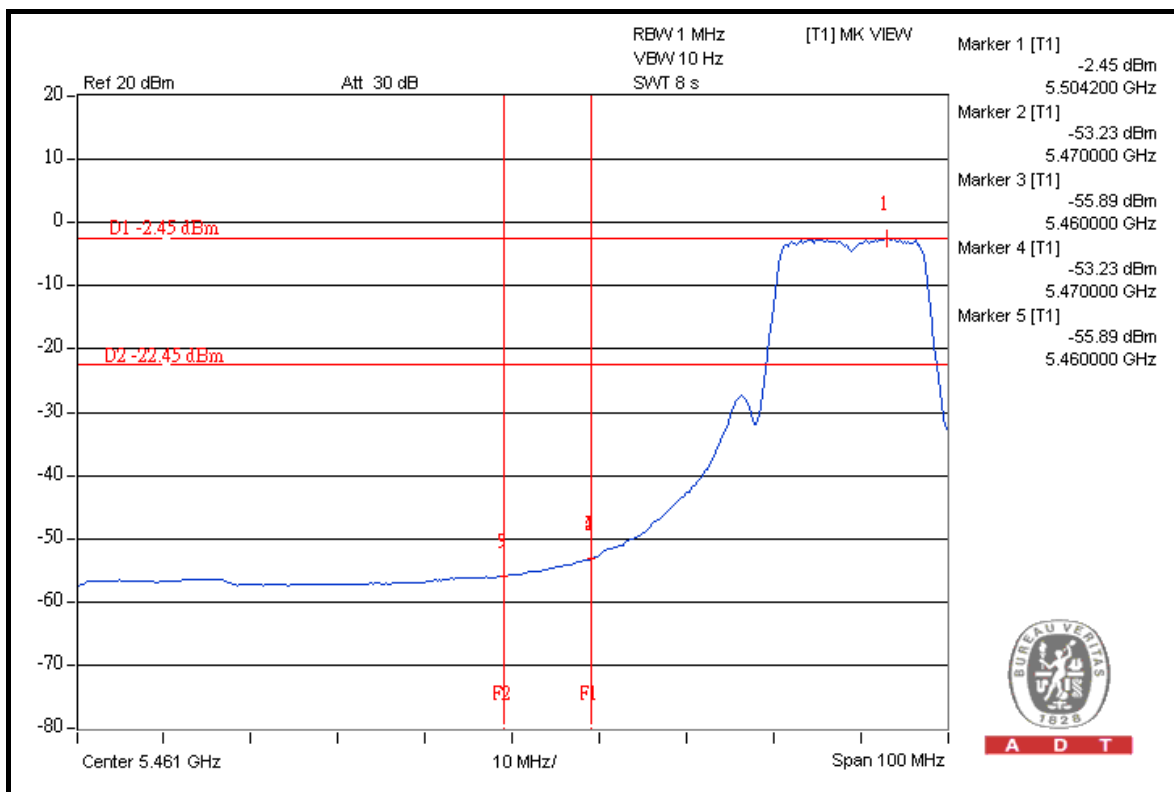

A D T



A D T

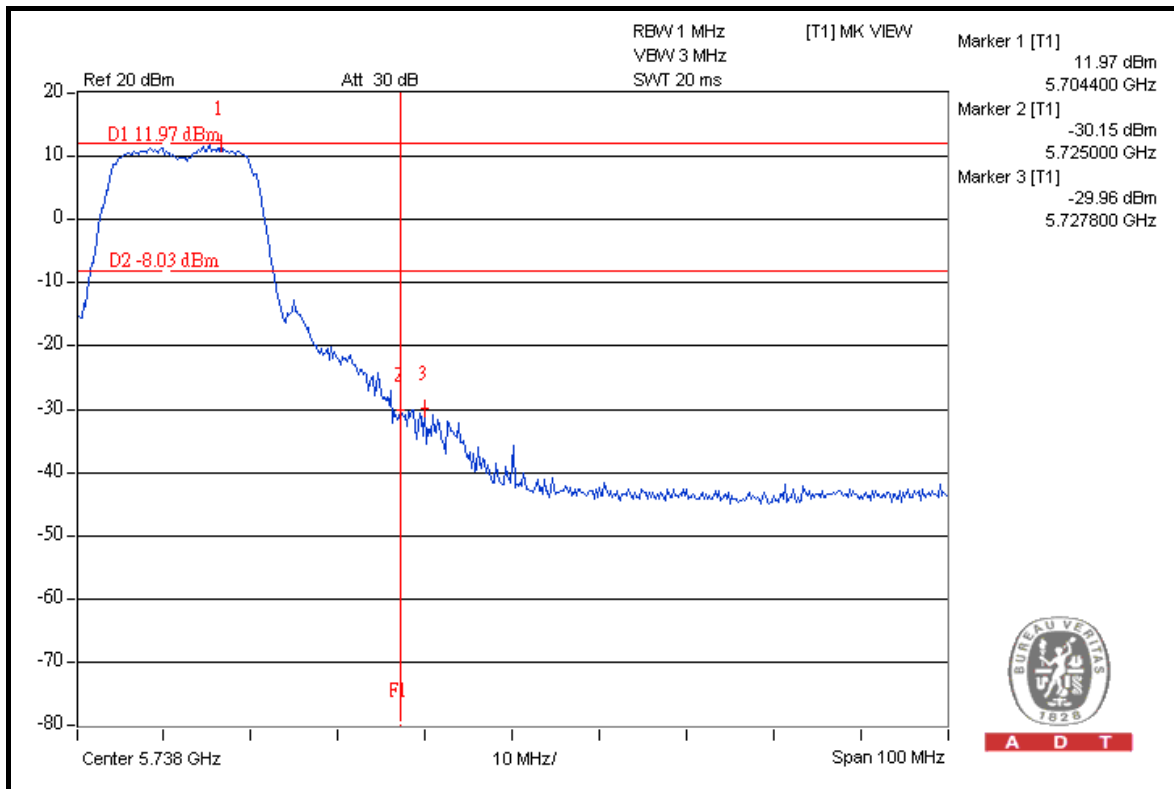
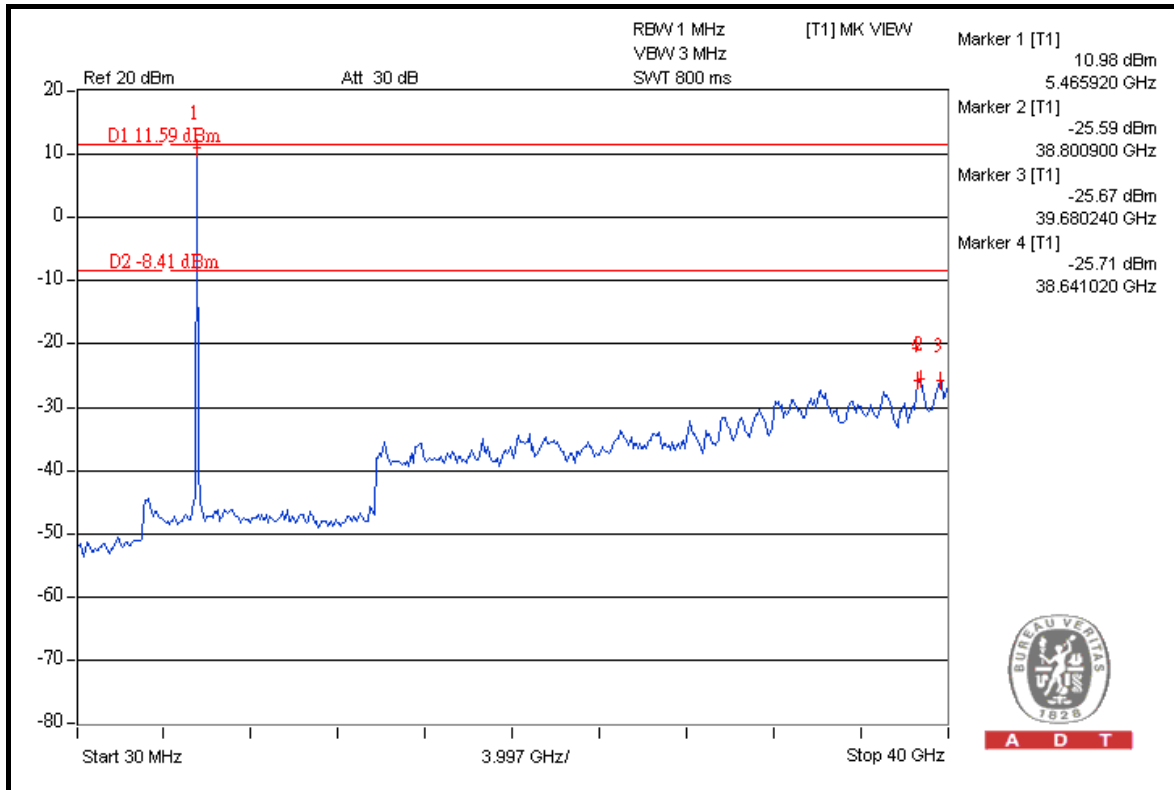



A D T

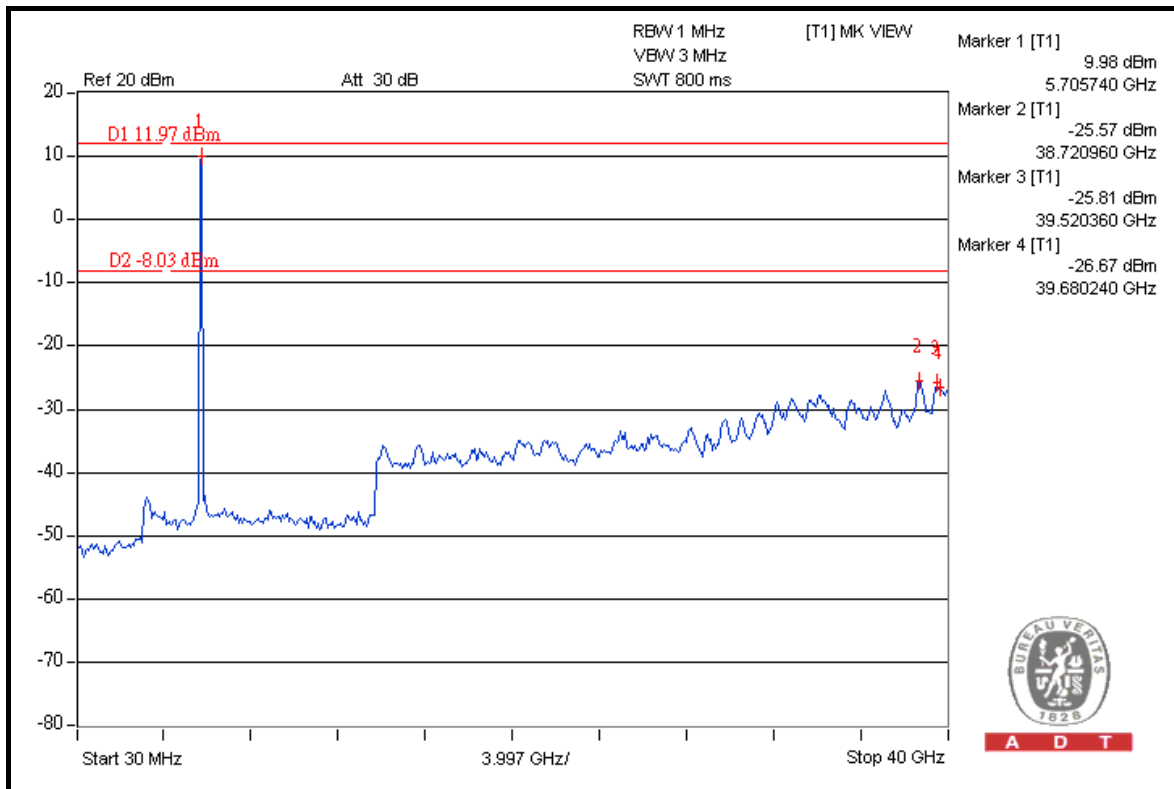
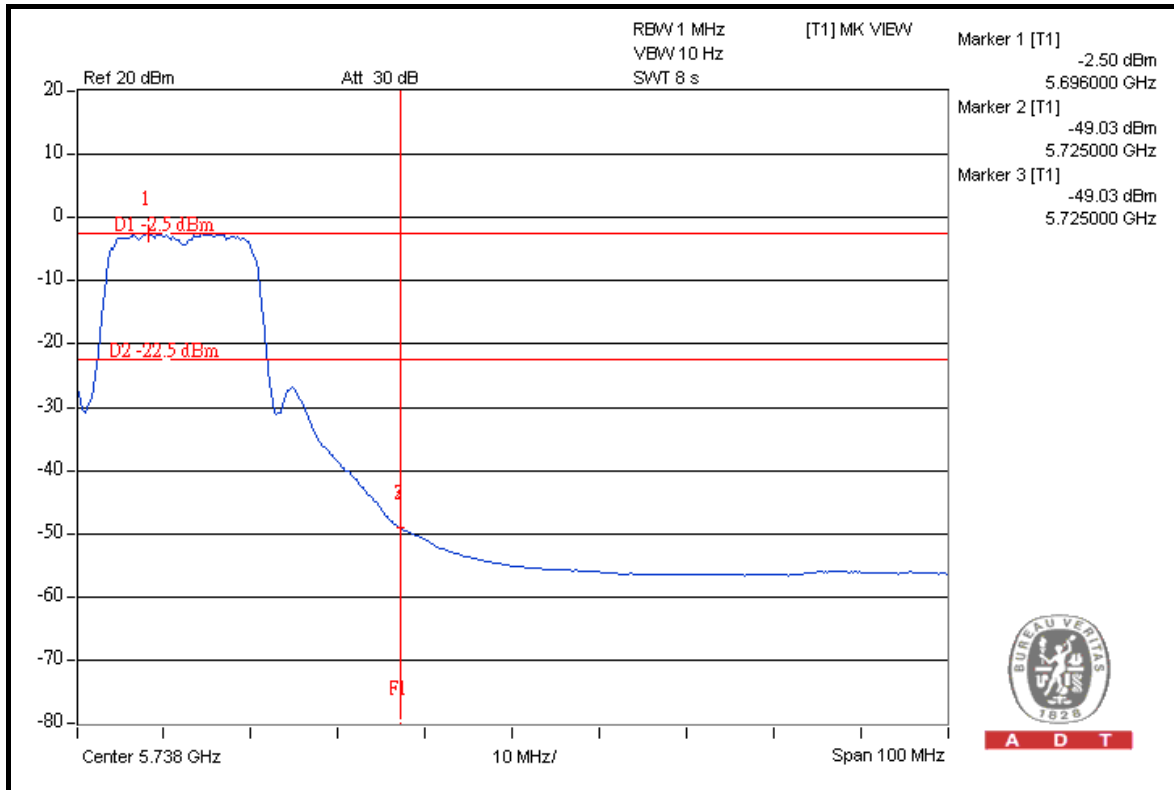

FOR 5180-5320MHz BAND:

802.11n (20MHz)

RESTRICT BAND (4500 ~ 5150 MHz)

| FREQUENCY (MHz) | FUNDAMENTAL EMISSION (dBuV/m) | DELTA (dB) | MAXIMUM FIELD STRENGTH IN RESTRICT BAND (dBuV/m) | LIMIT (dBuV/m) |
|-----------------|-------------------------------|------------|--|----------------|
| 5180.00 (PK) | 107.8 | 48.96 | 58.84 | 74.00 |
| 5180.00 (AV) | 91.1 | 46.35 | 44.75 | 54.00 |

RESTRICT BAND (5350 ~ 5460 MHz)

| FREQUENCY (MHz) | FUNDAMENTAL EMISSION (dBuV/m) | DELTA (dB) | MAXIMUM FIELD STRENGTH IN RESTRICT BAND (dBuV/m) | LIMIT (dBuV/m) |
|-----------------|-------------------------------|------------|--|----------------|
| 5320.00 (PK) | 108.3 | 49.59 | 58.71 | 74.00 |
| 5320.00 (AV) | 91.7 | 46.16 | 45.54 | 54.00 |

NOTE:

1. Delta = Amplitude between the peak of the fundamental and the peak of the band edge emission. Please check following 3 pages.
2. Maximum field strength in restrict band = Fundamental emission – Delta.



A D T

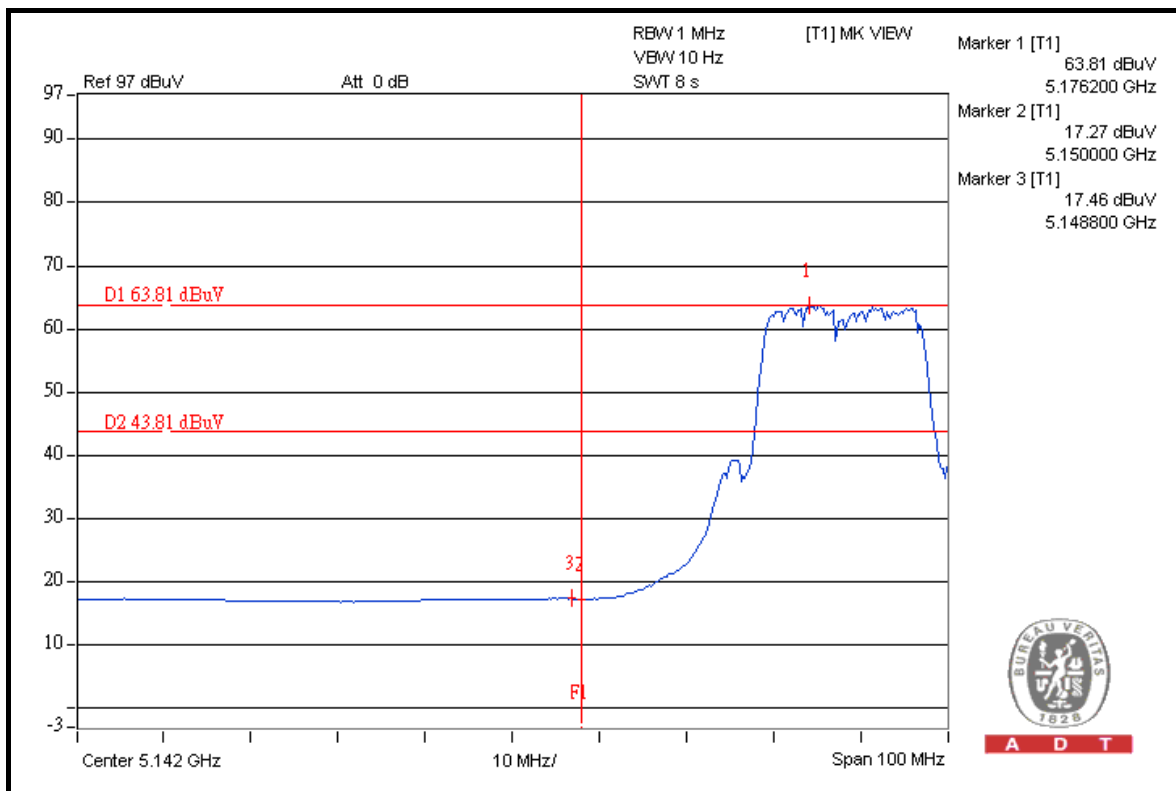
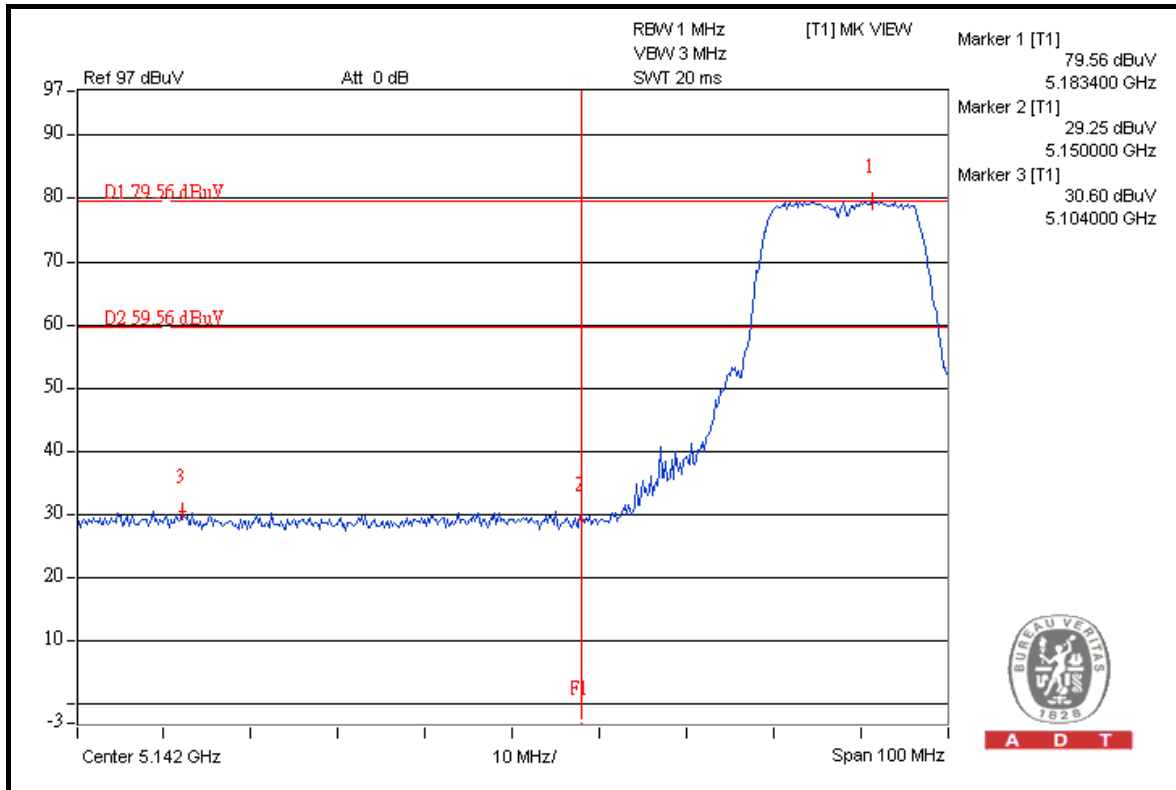



A D T

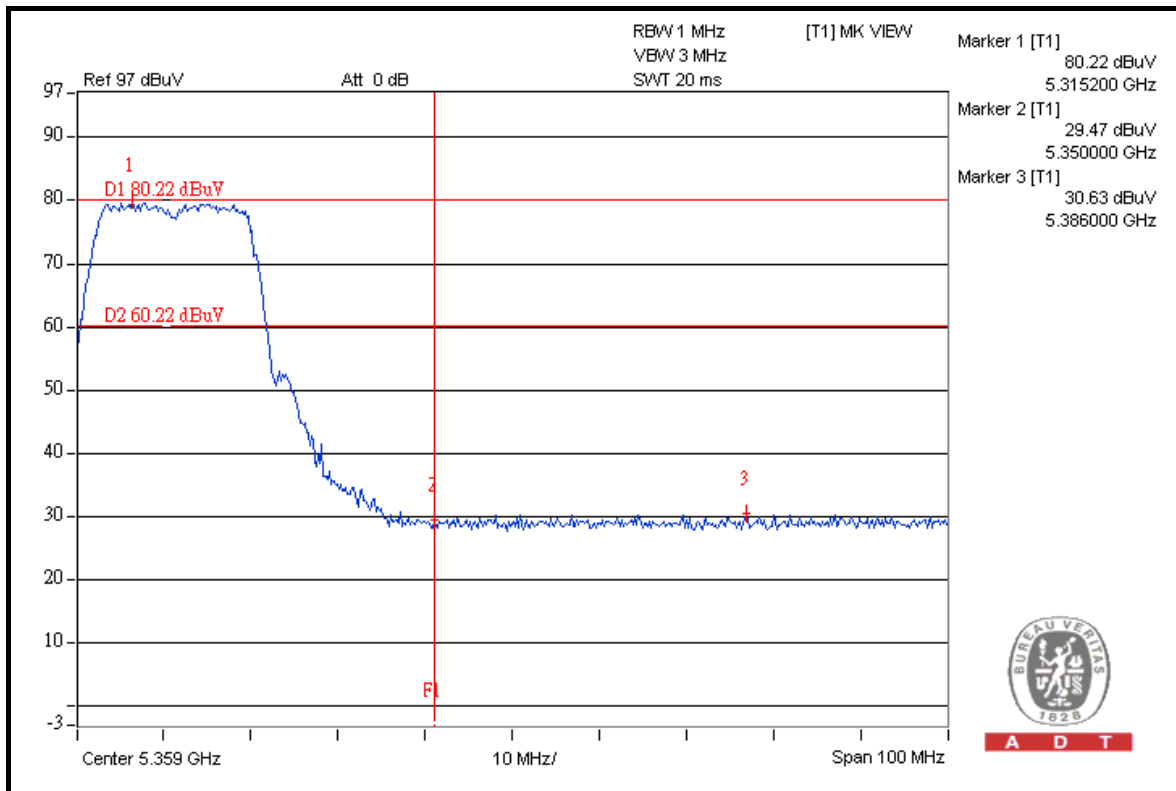
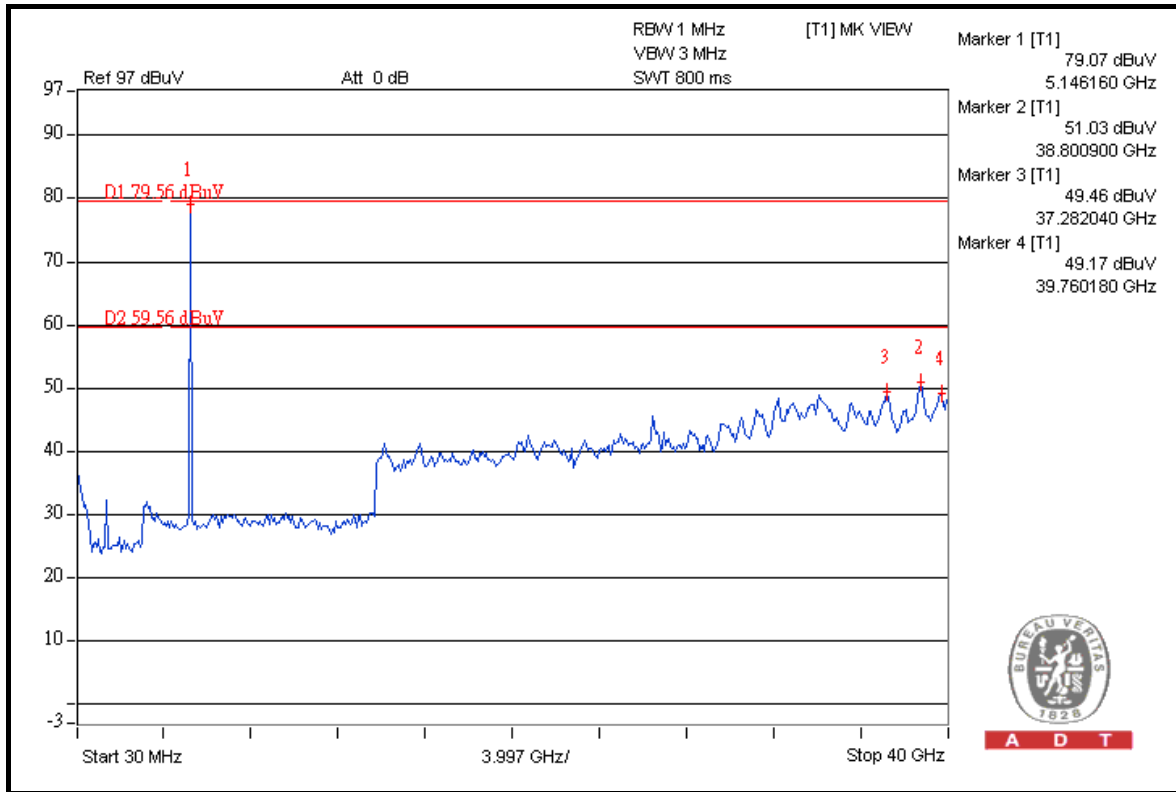



A D T

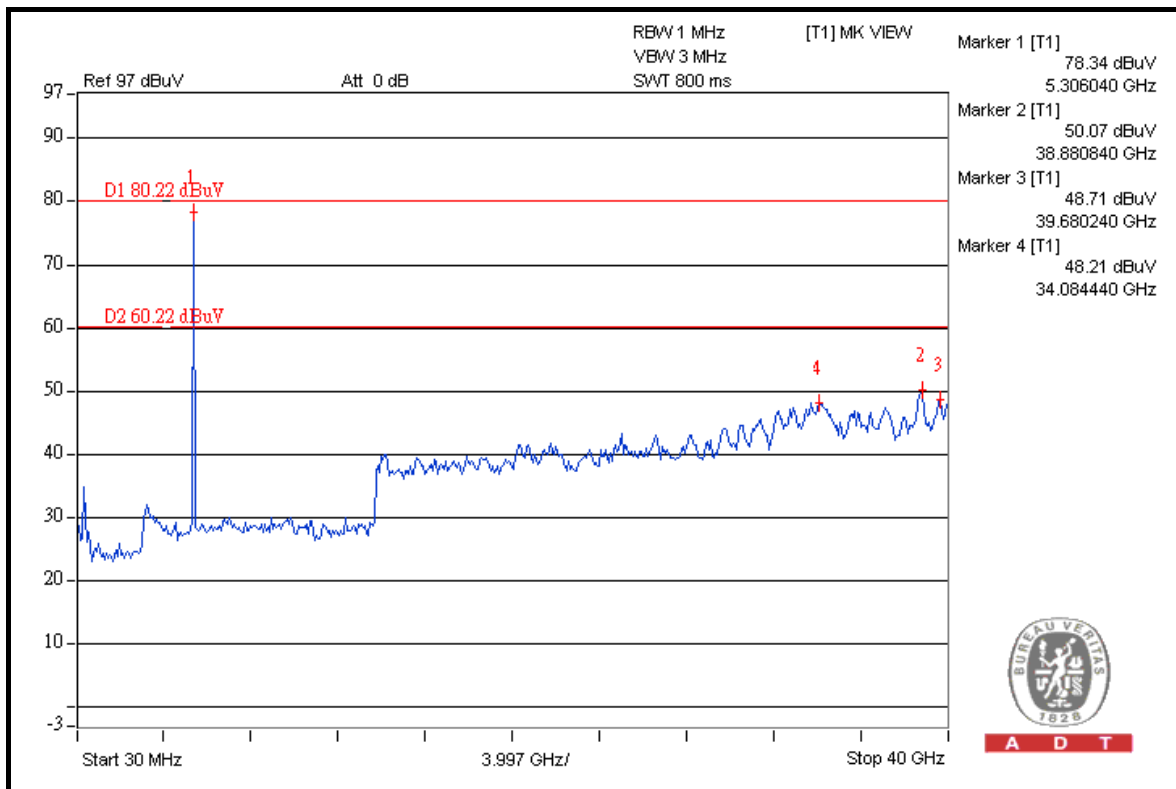
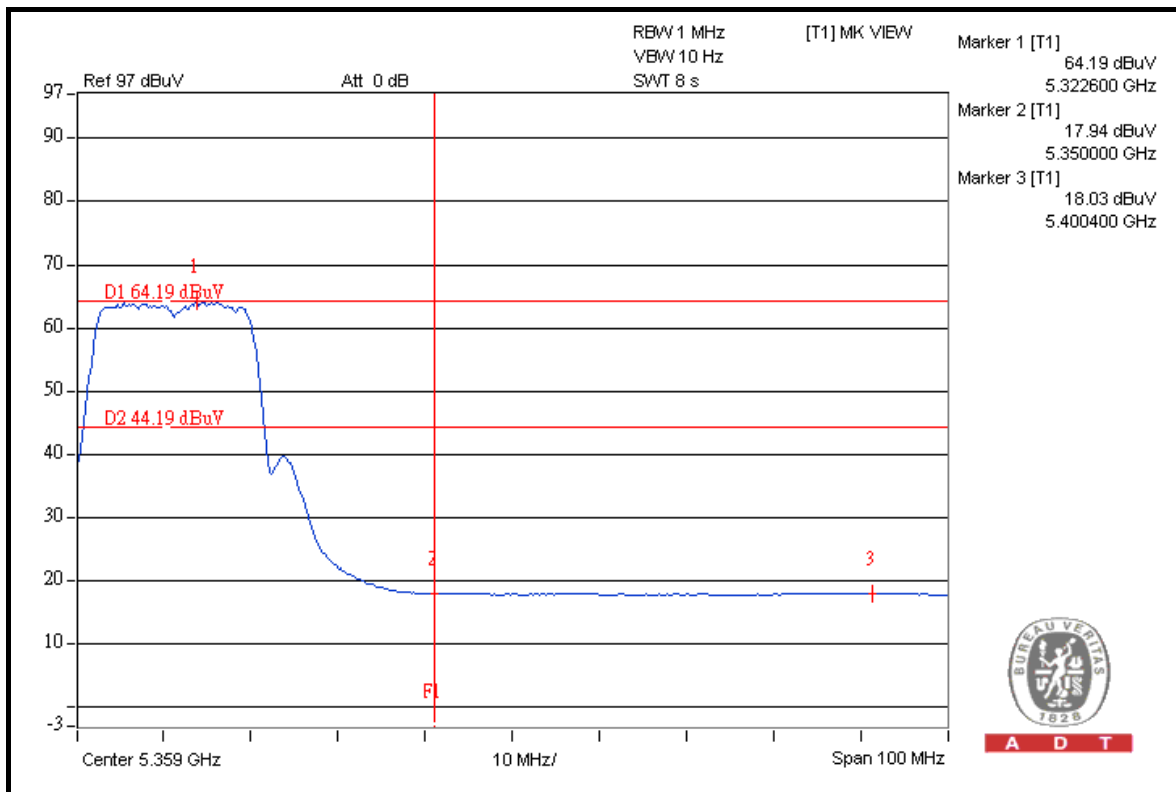

FOR 5500-5700MHz BAND:

802.11n (20MHz)

5500MHz

RESTRICT BAND (5350 ~ 5460 MHz)

| FREQUENCY (MHz) | FUNDAMENTAL EMISSION (dBuV/m) | DELTA (dB) | MAXIMUM FIELD STRENGTH IN RESTRICT BAND (dBuV/m) | LIMIT (dBuV/m) |
|-----------------|-------------------------------|------------|--|----------------|
| 5500.00 (PK) | 108.6 | 49.10 | 59.50 | 74.00 |
| 5500.00 (AV) | 92.0 | 45.80 | 46.2 | 54.00 |

FREQUENCY BAND (5460 ~ 5470 MHz)

| FREQUENCY (MHz) | FUNDAMENTAL EMISSION (dBuV/m) | DELTA (dB) | MAXIMUM FIELD STRENGTH (dBuV/m) | LIMIT (dBuV/m) |
|-----------------|-------------------------------|------------|---------------------------------|----------------|
| 5500.00 (PK) | 108.6 | 49.76 | 58.84 | 68.30 |

5700MHz

ABOVE 5725 MHz

| FREQUENCY (MHz) | FUNDAMENTAL EMISSION (dBuV/m) | DELTA (dB) | MAXIMUM FIELD STRENGTH (dBuV/m) | LIMIT (dBuV/m) |
|-----------------|-------------------------------|------------|---------------------------------|----------------|
| 5700.00 (PK) | 108.1 | 48.80 | 59.30 | 68.30 |

NOTE:

- Delta = Amplitude between the peak of the fundamental and the peak of the band edge emission. Please check following 3 pages.
- Maximum field strength in restrict band = Fundamental emission – Delta.



A D T

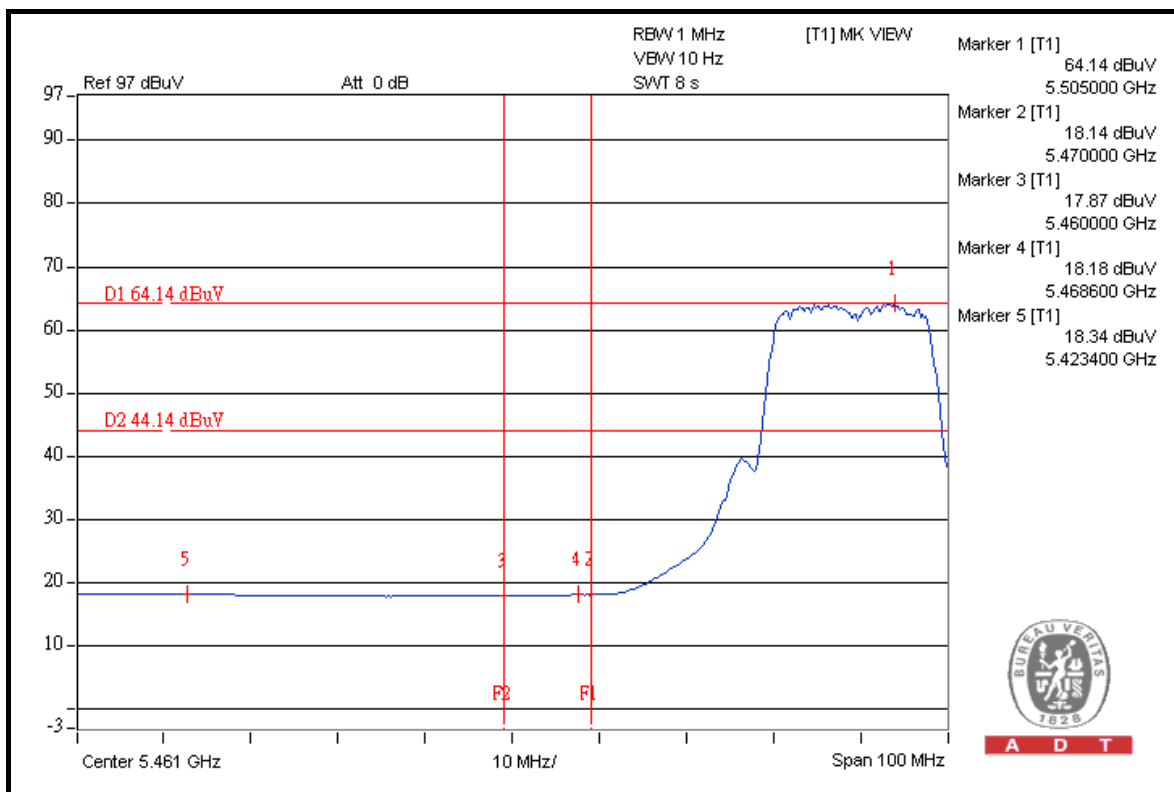
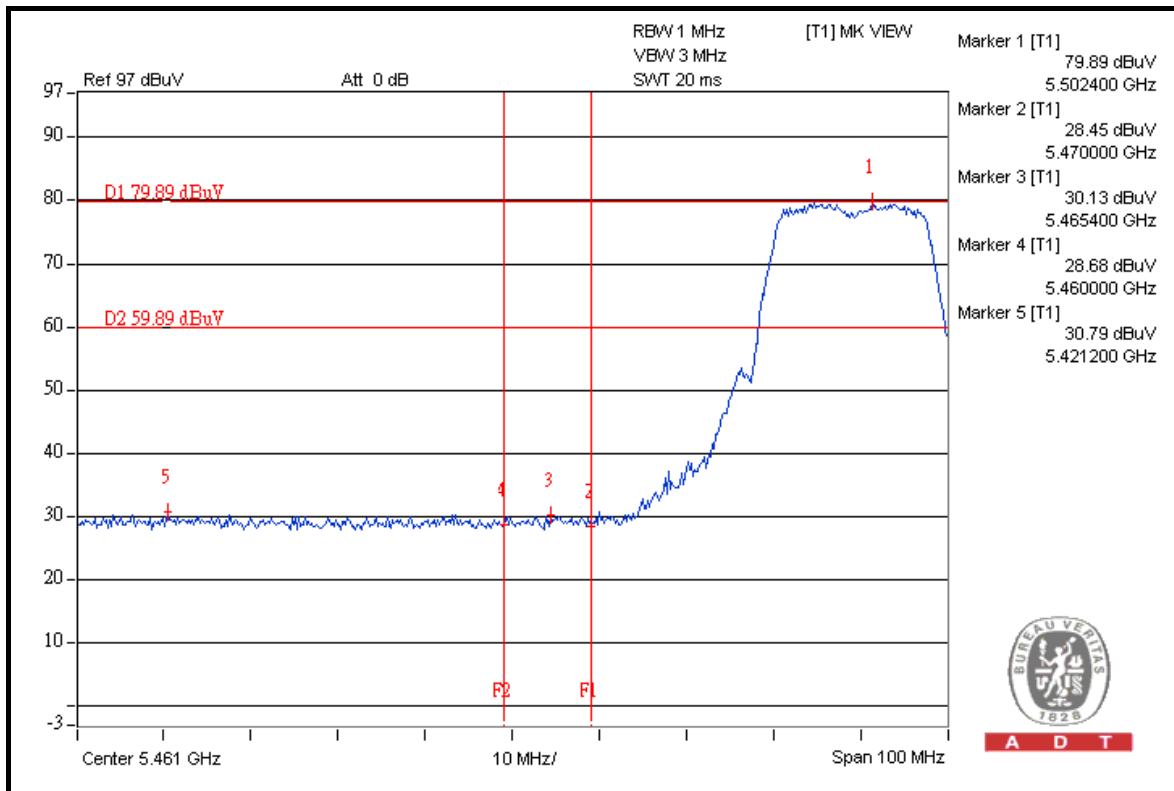



A D T

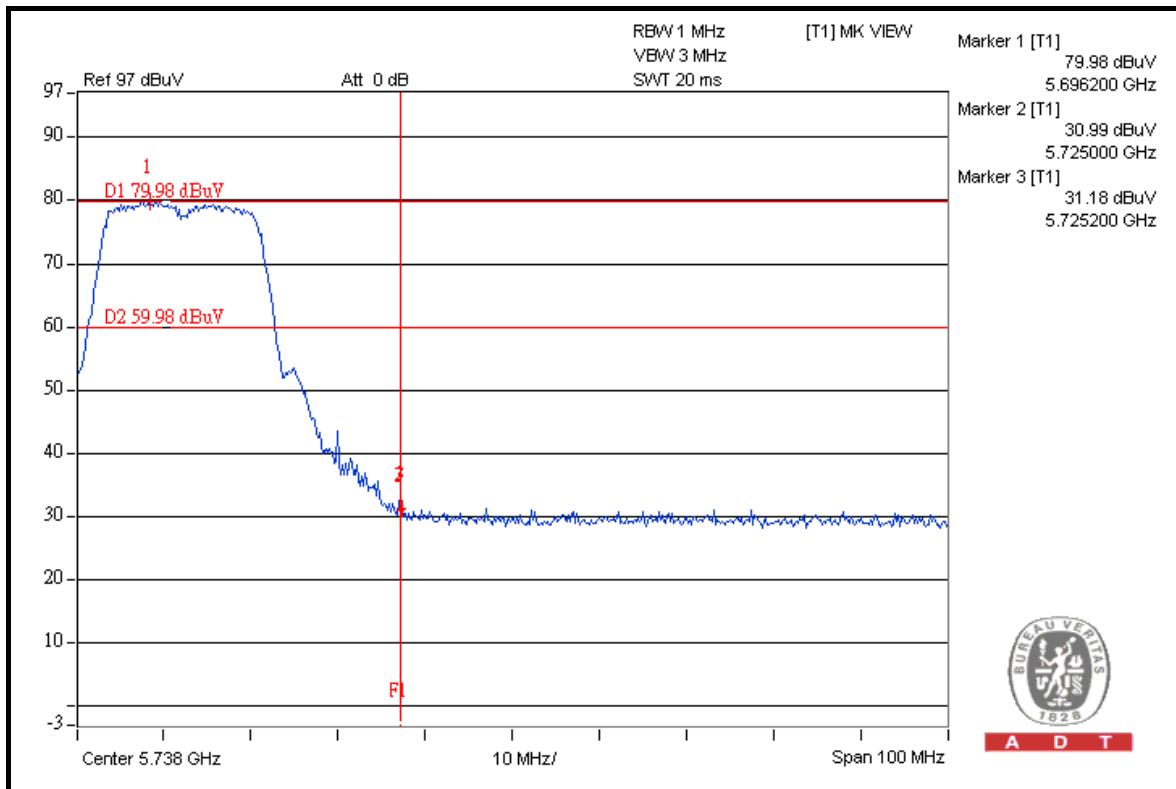
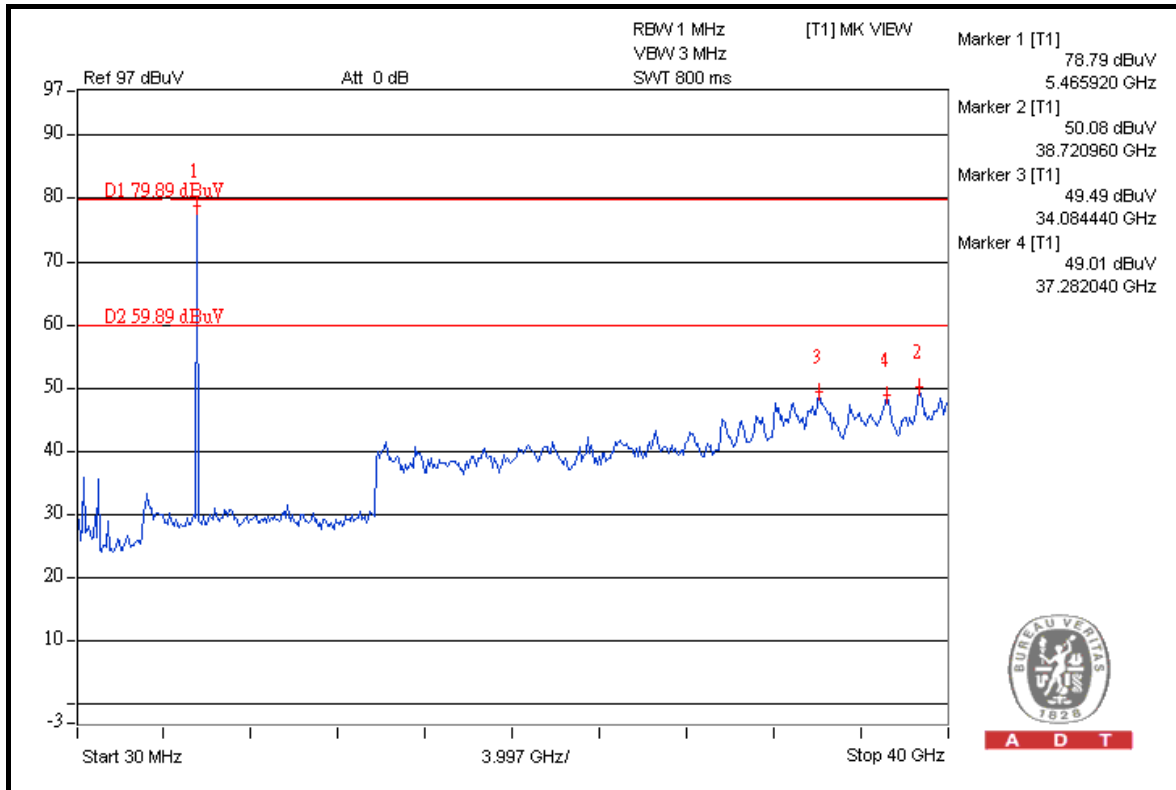



A D T

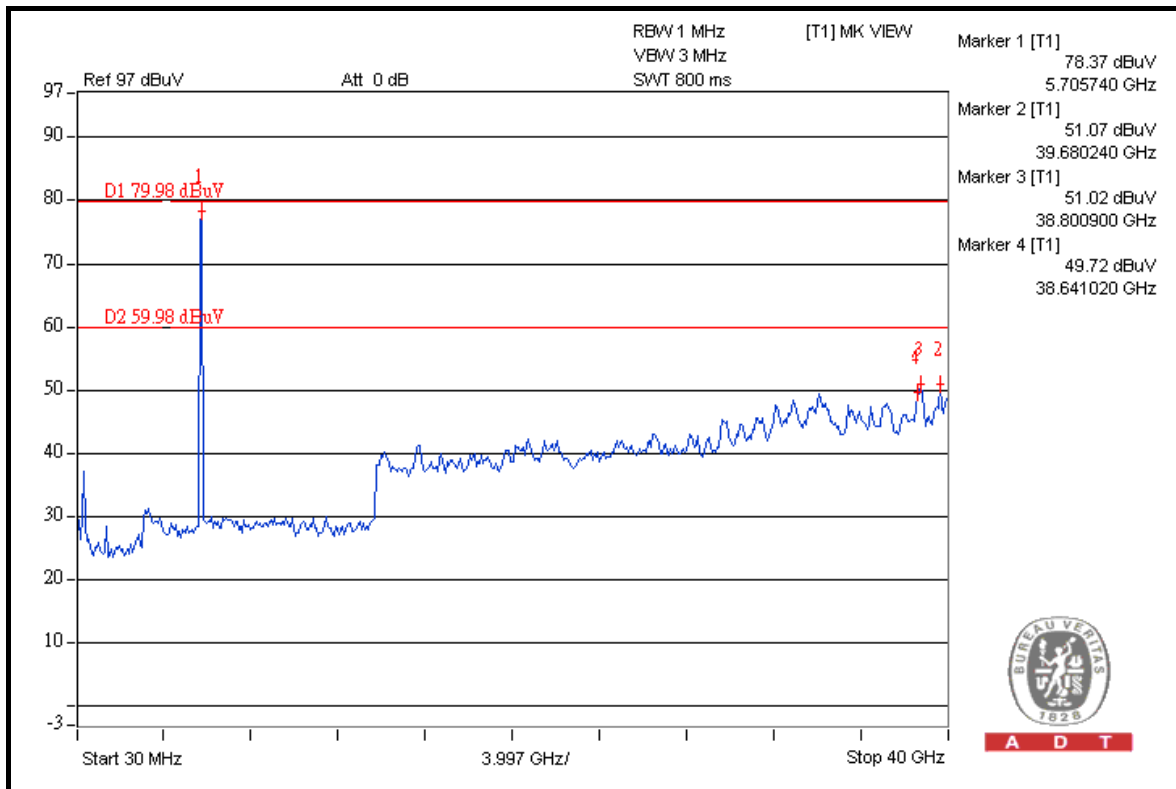
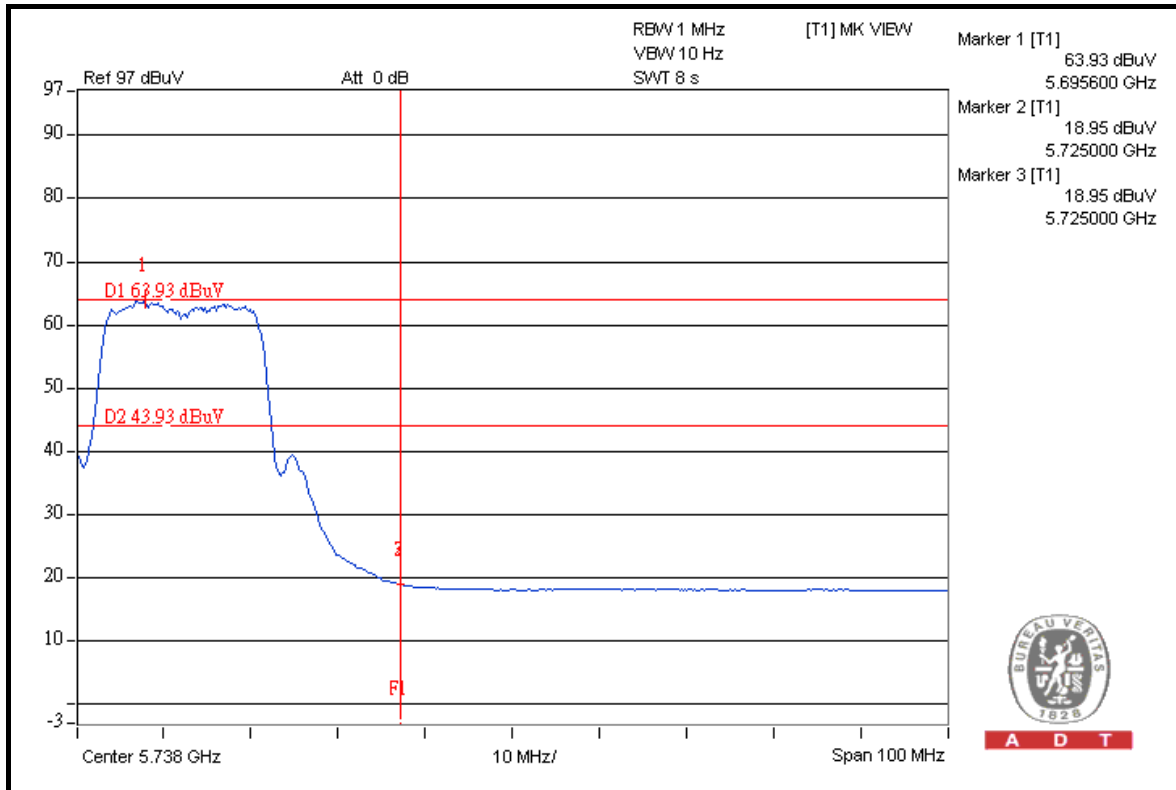

FOR 5180-5320MHz BAND:

802.11n (40MHz)

RESTRICT BAND (4500 ~ 5150 MHz)

| FREQUENCY (MHz) | FUNDAMENTAL EMISSION (dBuV/m) | DELTA (dB) | MAXIMUM FIELD STRENGTH IN RESTRICT BAND (dBuV/m) | LIMIT (dBuV/m) |
|-----------------|-------------------------------|------------|--|----------------|
| 5190.00 (PK) | 104.4 | 41.07 | 63.33 | 74.00 |
| 5190.00 (AV) | 86.1 | 39.04 | 47.06 | 54.00 |

RESTRICT BAND (5350 ~ 5460 MHz)

| FREQUENCY (MHz) | FUNDAMENTAL EMISSION (dBuV/m) | DELTA (dB) | MAXIMUM FIELD STRENGTH IN RESTRICT BAND (dBuV/m) | LIMIT (dBuV/m) |
|-----------------|-------------------------------|------------|--|----------------|
| 5310.00 (PK) | 104.5 | 46.33 | 58.17 | 74.00 |
| 5310.00 (AV) | 86.2 | 39.48 | 46.72 | 54.00 |

NOTE:

- Delta = Amplitude between the peak of the fundamental and the peak of the band edge emission. Please check following 3 pages.
- Maximum field strength in restrict band = Fundamental emission – Delta.



A D T

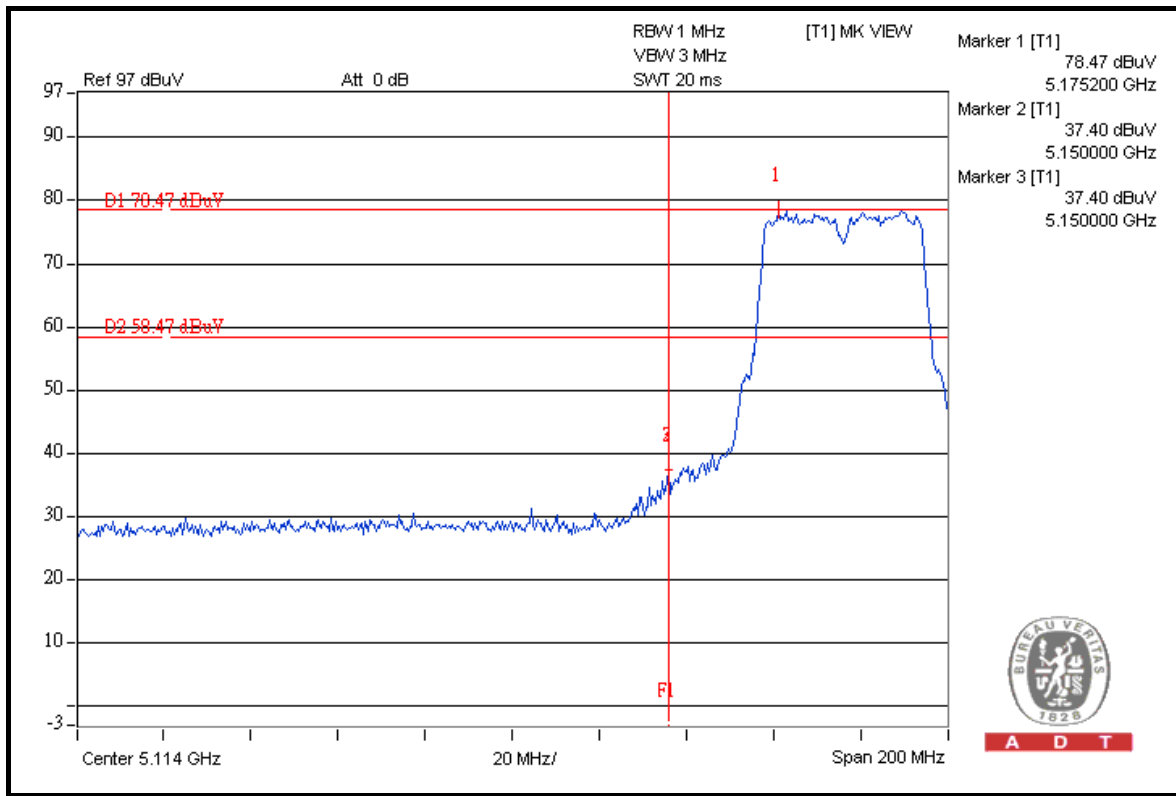

A D T

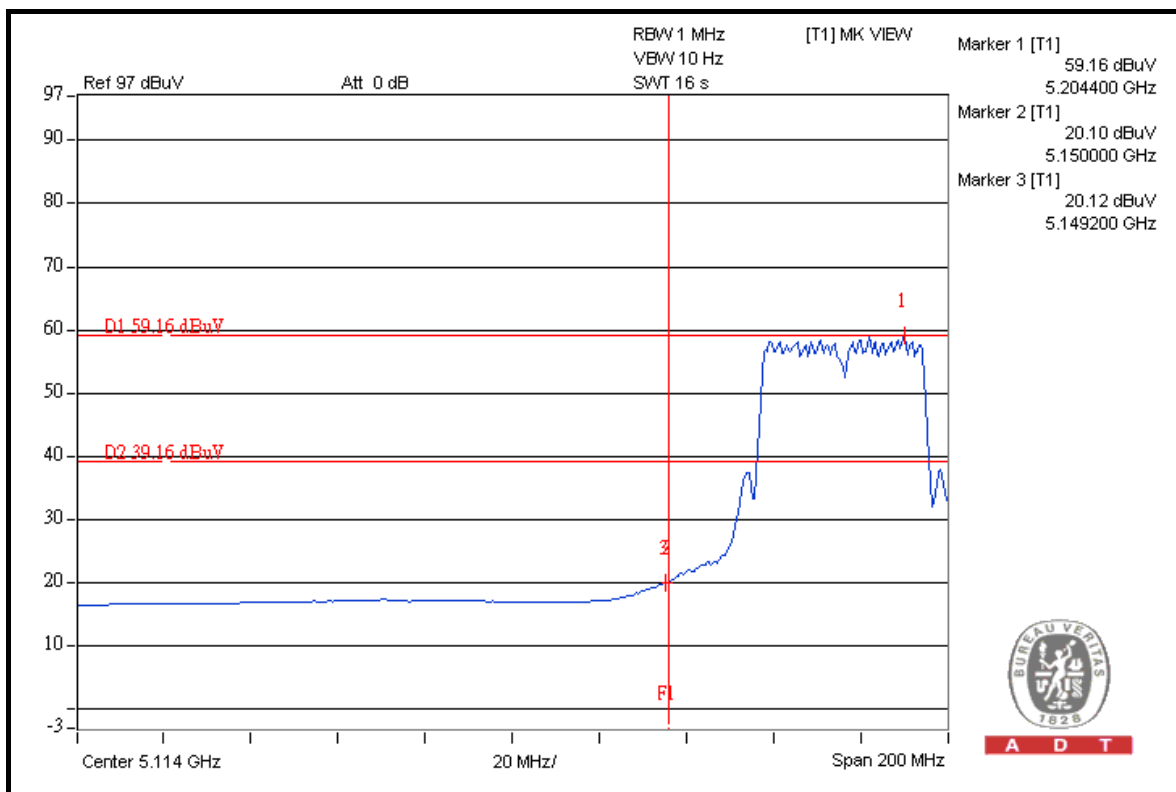

A D T



A D T

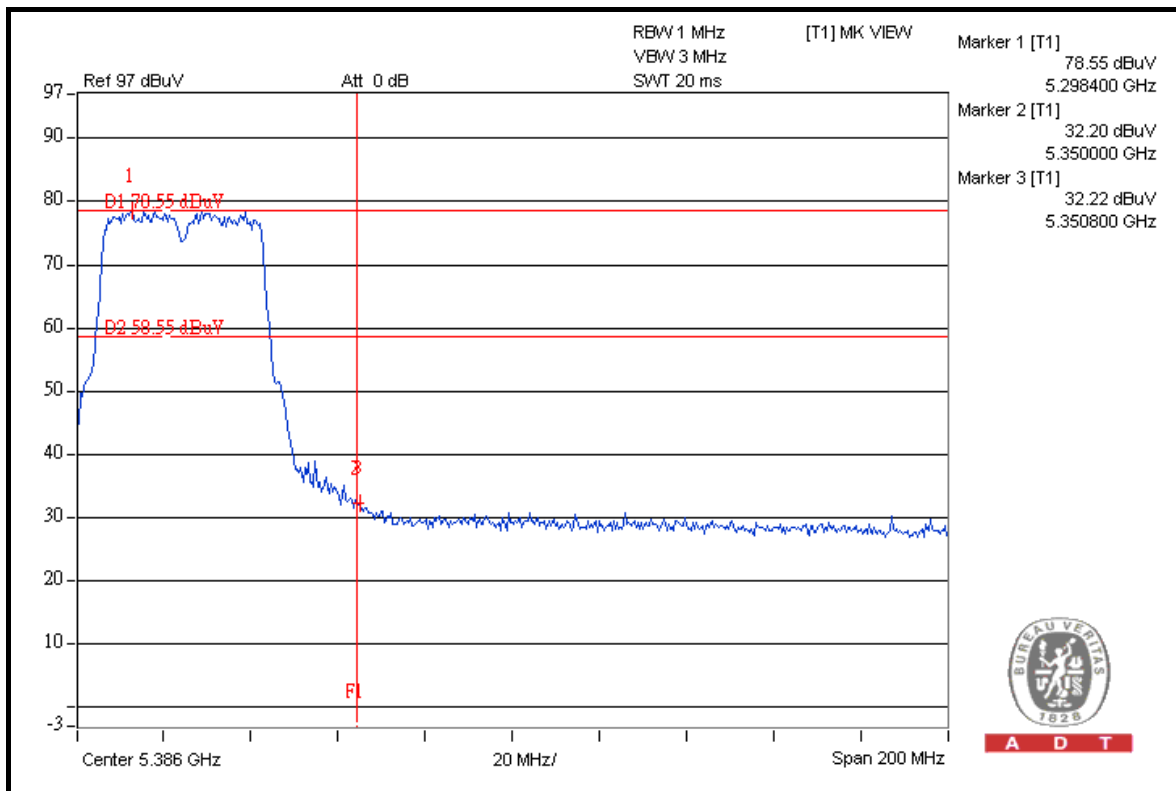
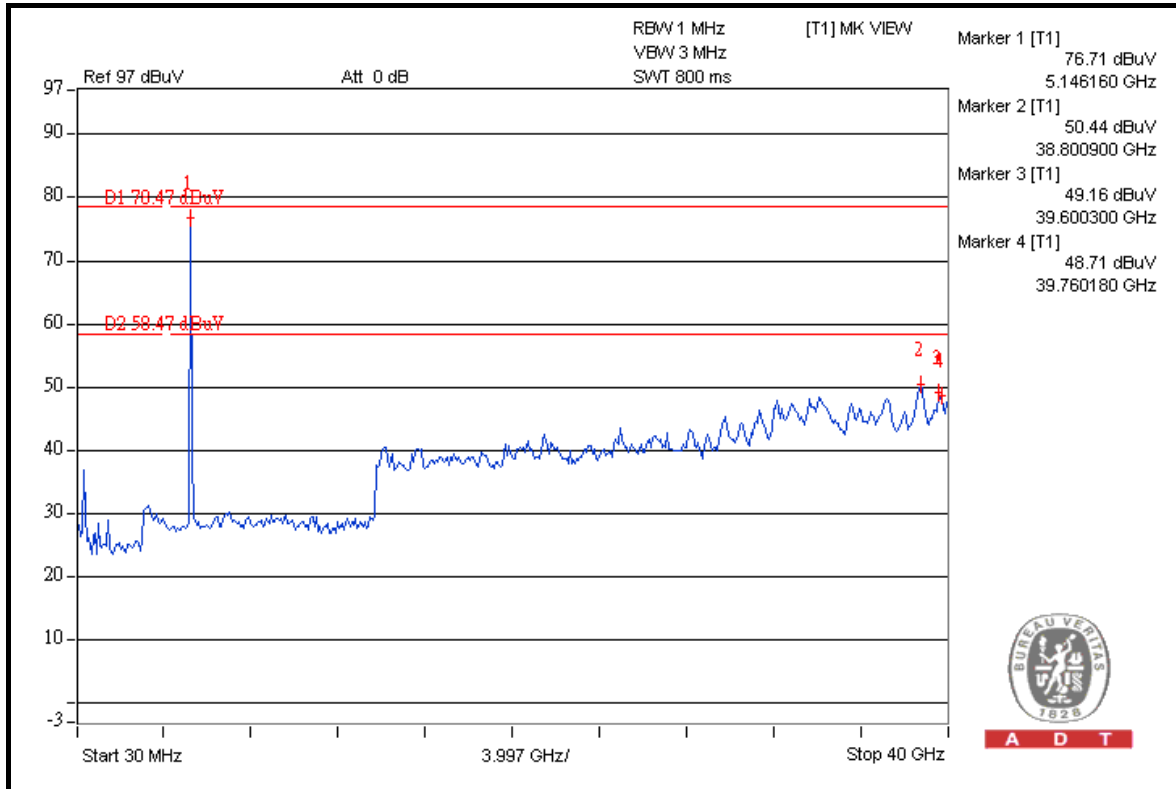



A D T

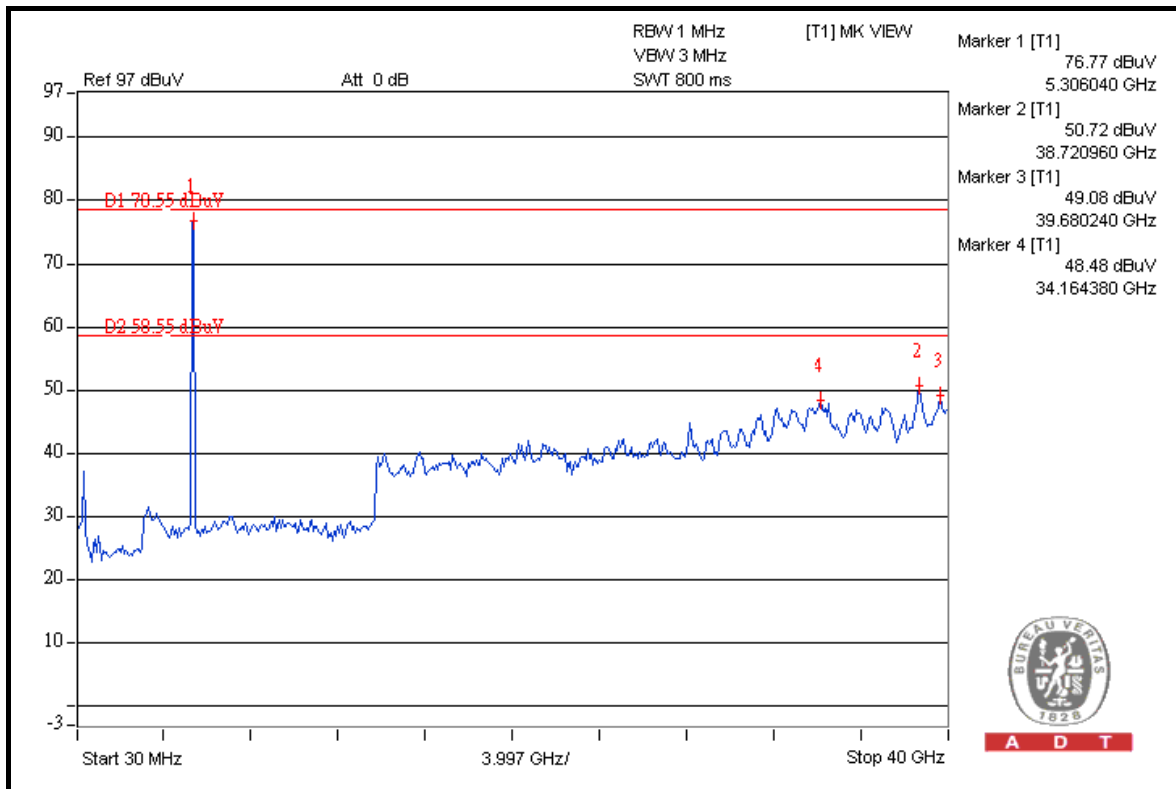
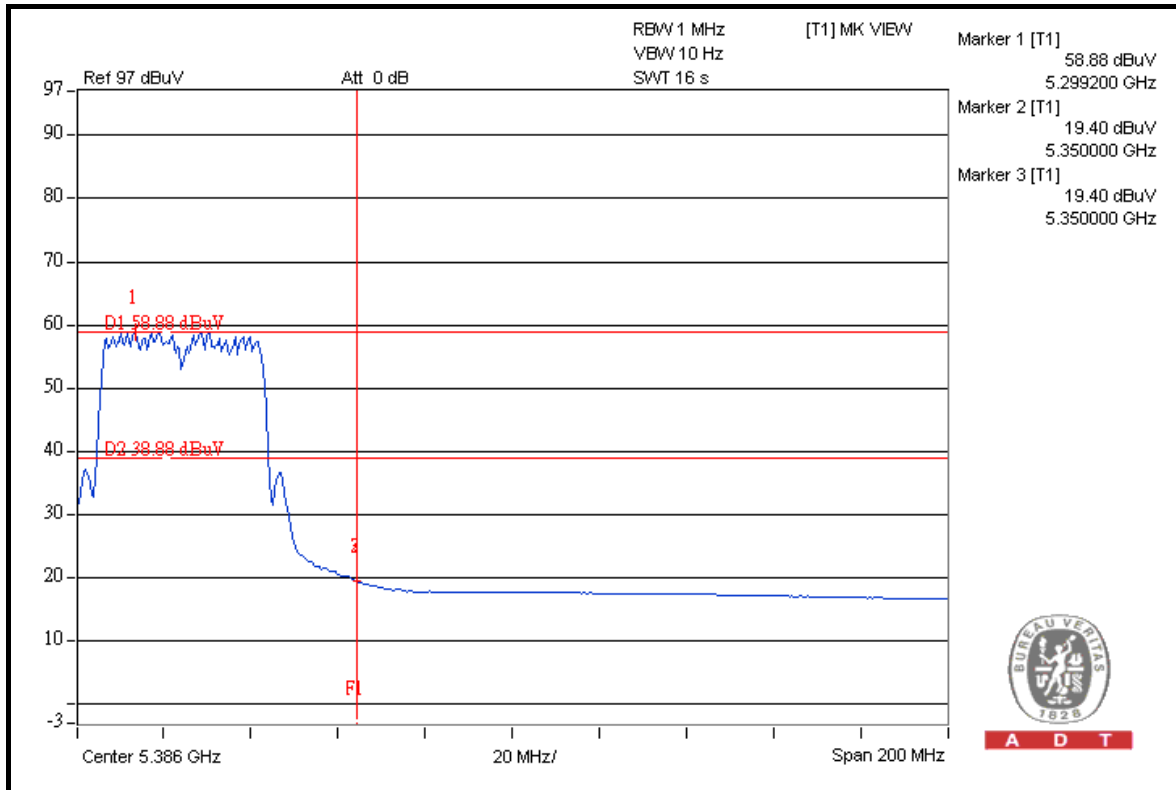

FOR 5500-5700MHz BAND:

802.11n (40MHz)

5510MHz

RESTRICT BAND (5350 ~ 5460 MHz)

| FREQUENCY (MHz) | FUNDAMENTAL EMISSION (dBuV/m) | DELTA (dB) | MAXIMUM FIELD STRENGTH IN RESTRICT BAND (dBuV/m) | LIMIT (dBuV/m) |
|-----------------|-------------------------------|------------|--|----------------|
| 5510.00 (PK) | 105.1 | 44.89 | 60.21 | 74.00 |
| 5510.00 (AV) | 86.8 | 39.89 | 46.91 | 54.00 |

FREQUENCY BAND (5460 ~ 5470 MHz)

| FREQUENCY (MHz) | FUNDAMENTAL EMISSION (dBuV/m) | DELTA (dB) | MAXIMUM FIELD STRENGTH (dBuV/m) | LIMIT (dBuV/m) |
|-----------------|-------------------------------|------------|---------------------------------|----------------|
| 5510.00 (PK) | 105.1 | 37.85 | 67.25 | 68.30 |

5670MHz

ABOVE 5725 MHz

| FREQUENCY (MHz) | FUNDAMENTAL EMISSION (dBuV/m) | DELTA (dB) | MAXIMUM FIELD STRENGTH (dBuV/m) | LIMIT (dBuV/m) |
|-----------------|-------------------------------|------------|---------------------------------|----------------|
| 5670.00 (PK) | 105.2 | 48.05 | 57.15 | 68.30 |

NOTE:

1. Delta = Amplitude between the peak of the fundamental and the peak of the band edge emission. Please check following 3 pages.
2. Maximum field strength in restrict band = Fundamental emission – Delta.



A D T

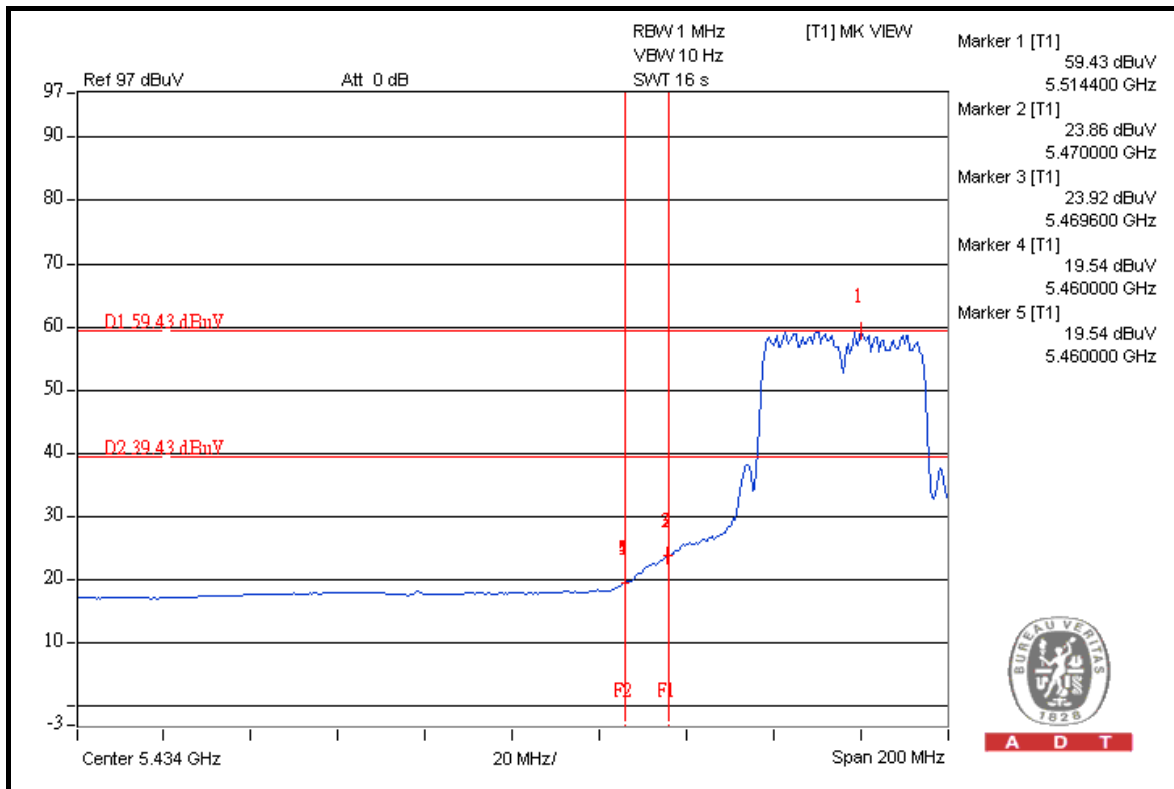
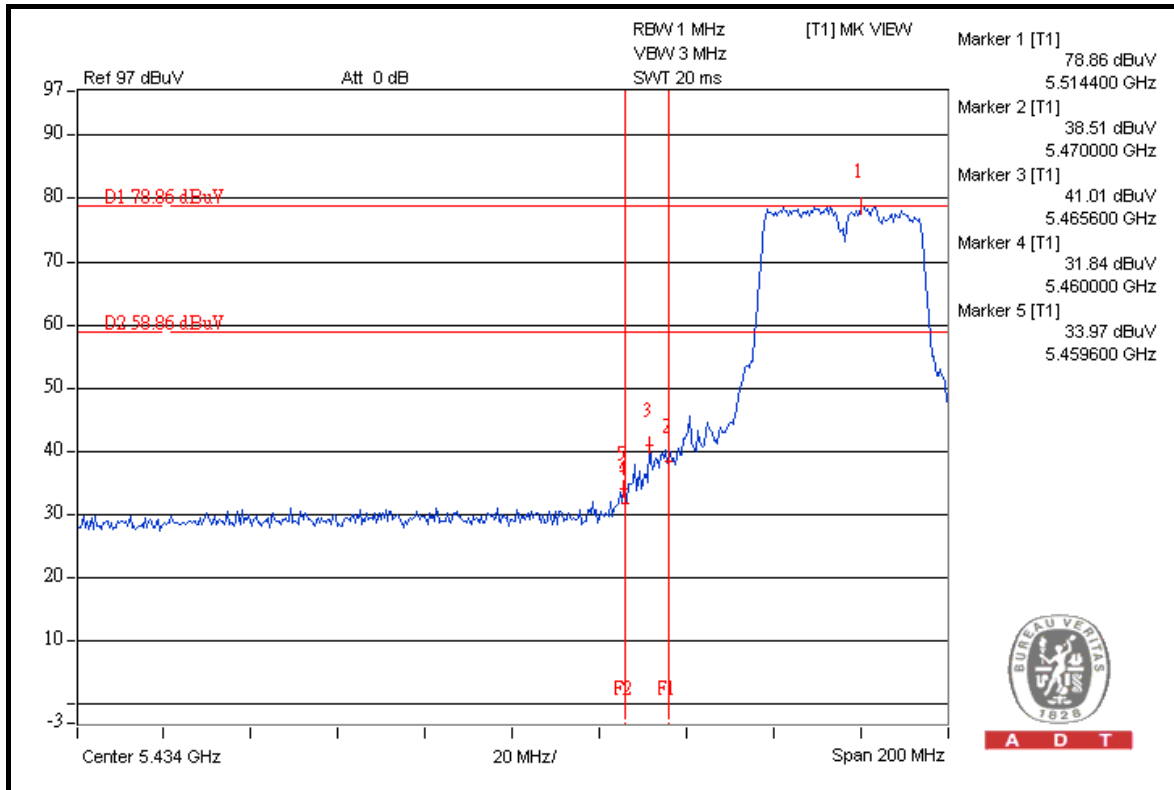



A D T

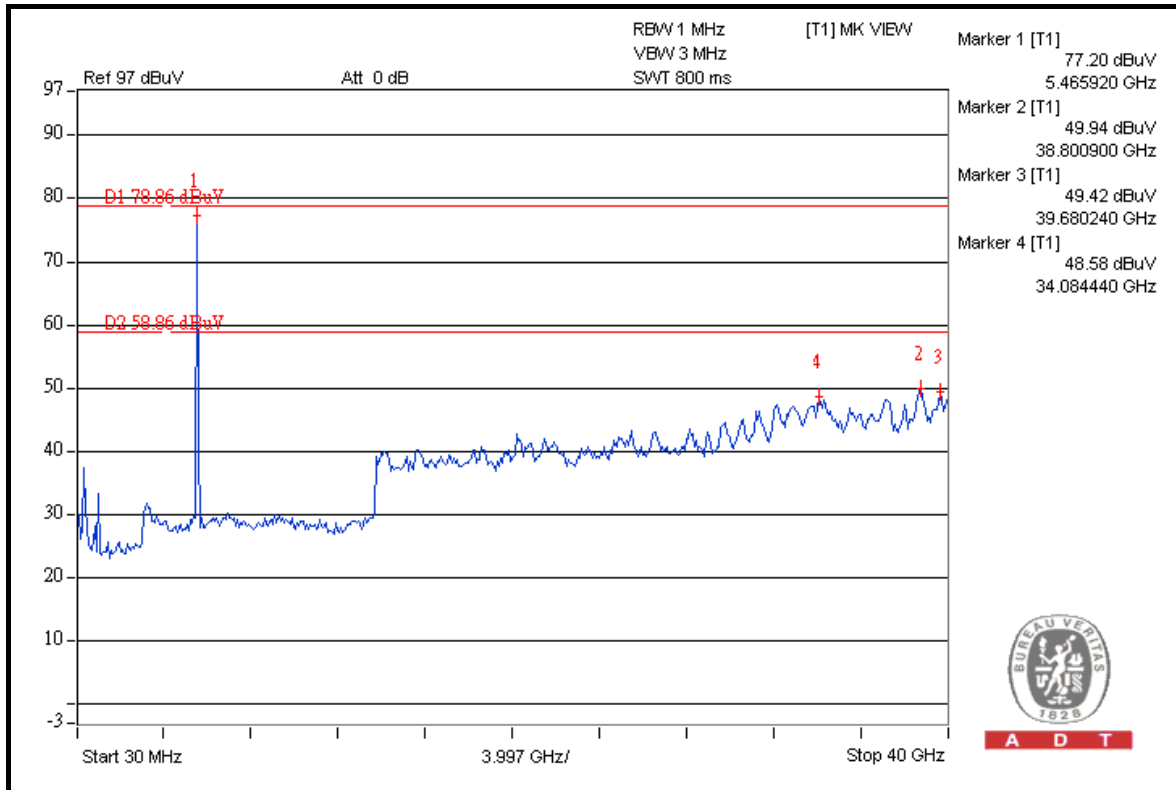

A D T

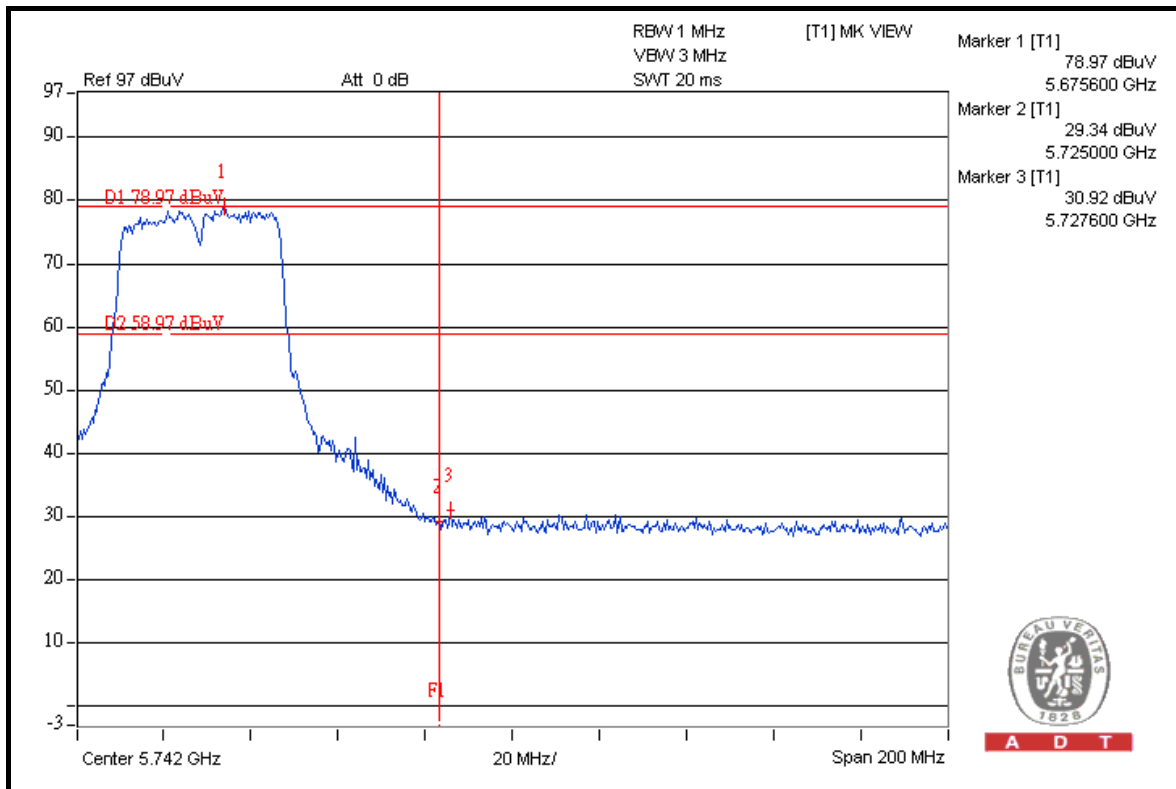

A D T



A D T

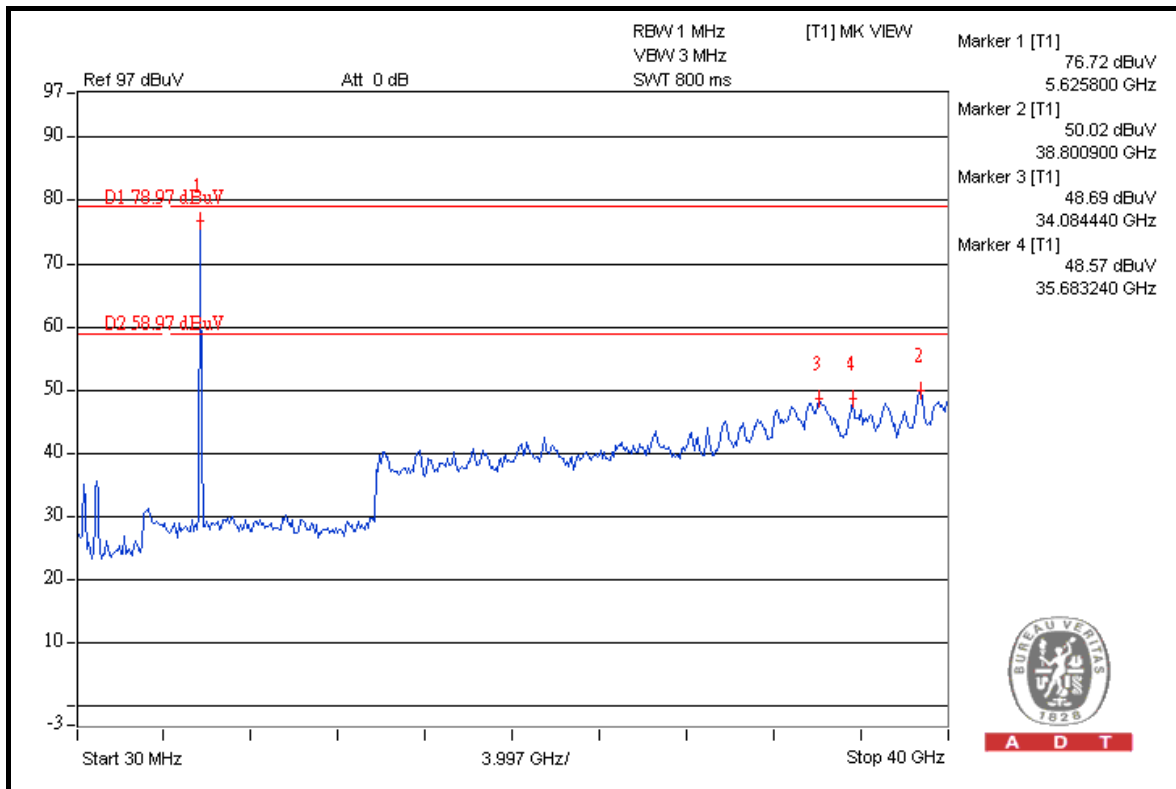
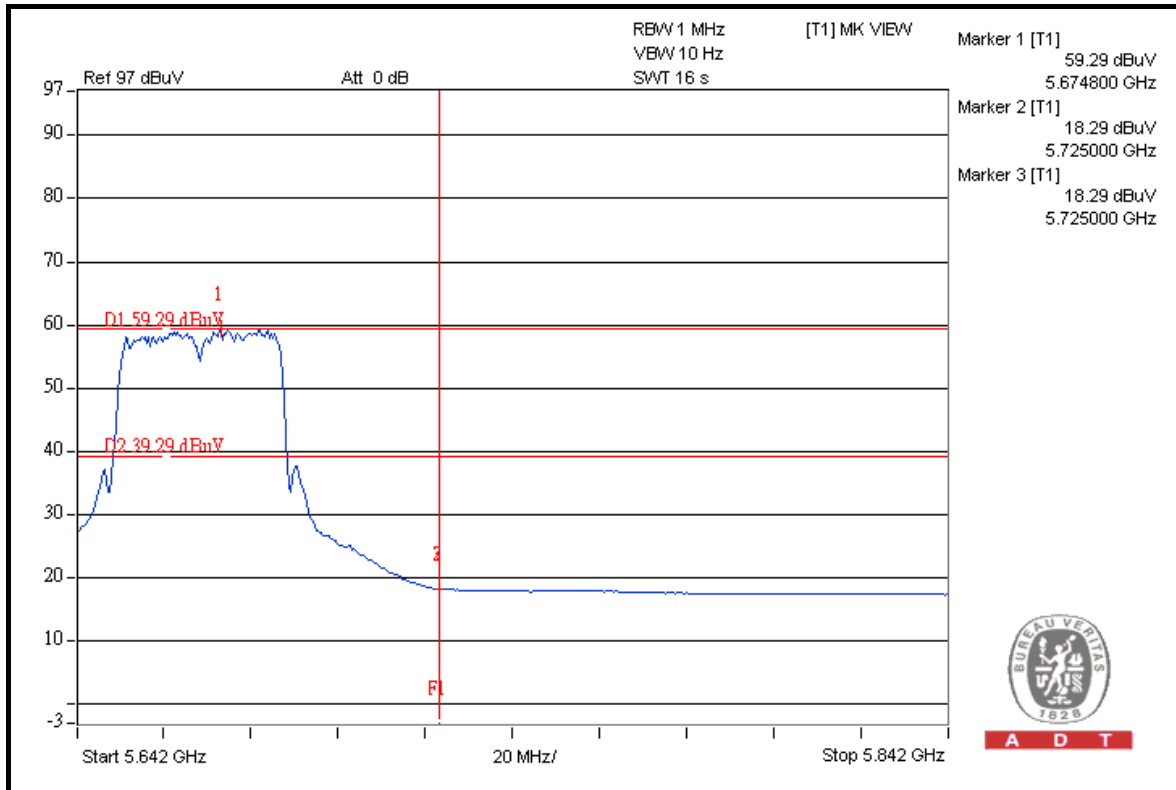

5. PHOTOGRAPHS OF THE TEST CONFIGURATION

Please refer to the attached file (Test Setup Photo).

6. INFORMATION ON THE TESTING LABORATORIES

We, Bureau Veritas Consumer Products Services (H.K.) Ltd., Taoyuan Branch, were founded in 1988 to provide our best service in EMC, Radio, Telecom and Safety consultation. Our laboratories are accredited and approved according to ISO/IEC 17025.

Copies of accreditation certificates of our laboratories obtained from approval agencies can be downloaded from our web site:

www.adt.com.tw/index.5/phtml. If you have any comments, please feel free to contact us at the following:

Linko EMC/RF Lab:

Tel: 886-2-26052180

Fax: 886-2-26051924

Hsin Chu EMC/RF Lab:

Tel: 886-3-5935343

Fax: 886-3-5935342

Hwa Ya EMC/RF/Safety Telecom Lab:

Tel: 886-3-3183232

Fax: 886-3-3185050

Web Site: www.adt.com.tw

The address and road map of all our labs can be found in our web site also.

7. APPENDIX A - MODIFICATIONS RECORDERS FOR ENGINEERING CHANGES TO THE EUT BY THE LAB

No any modifications are made to the EUT by the lab during the test.

---END---