



A D T

FCC TEST REPORT (15.247)

REPORT NO.: RF990226L03

MODEL NO.: AW-NU231

RECEIVED: Feb. 26, 2010

TESTED: Mar. 09 ~ Mar. 18, 2010

ISSUED: Mar. 22, 2010

APPLICANT: AzureWave Technologies, Inc.

ADDRESS: 8F, No.94, Baozhong Rd., Xindian, Taipei,
Taiwan 231.

ISSUED BY: Bureau Veritas Consumer Products Services
(H.K.) Ltd., Taoyuan Branch

LAB ADDRESS: No. 47, 14th Ling, Chia Pau Tsuen, Lin Kou
Hsiang, Taipei Hsien 244, Taiwan, R.O.C.

TEST LOCATION: No. 19, Hwa Ya 2nd Rd, Wen Hwa Tsuen, Kwei
Shan Hsiang, Taoyuan Hsien 333, Taiwan,
R.O.C.

This test report consists of 116 pages in total. It may be duplicated completely for legal use with the approval of the applicant. It should not be reproduced except in full, without the written approval of our laboratory. The client should not use it to claim product endorsement by TAF or any government agencies. The test results in the report only apply to the tested sample.



Testing Laboratory
2021



TABLE OF CONTENTS

1.	CERTIFICATION.....	5
2.	SUMMARY OF TEST RESULTS	6
2.1	MEASUREMENT UNCERTAINTY.....	6
3.	GENERAL INFORMATION.....	7
3.1	GENERAL DESCRIPTION OF EUT	7
3.2	DESCRIPTION OF TEST MODES	9
3.2.1	CONFIGURATION OF SYSTEM UNDER TEST	9
3.2.2	TEST MODE APPLICABILITY AND TESTED CHANNEL DETAIL	10
3.3	GENERAL DESCRIPTION OF APPLIED STANDARDS	14
3.4	DESCRIPTION OF SUPPORT UNITS	14
4.	TEST TYPES AND RESULTS (FOR 2.4GHz BAND).....	15
4.1	RADIATED EMISSION MEASUREMENT	15
4.1.1	LIMITS OF RADIATED EMISSION MEASUREMENT.....	15
4.1.2	TEST INSTRUMENTS.....	16
4.1.3	TEST PROCEDURES	17
4.1.4	DEVIATION FROM TEST STANDARD.....	17
4.1.5	TEST SETUP.....	18
4.1.6	EUT OPERATING CONDITIONS	18
4.1.7	TEST RESULTS	19
4.2	CONDUCTED EMISSION MEASUREMENT	32
4.2.1	LIMITS OF CONDUCTED EMISSION MEASUREMENT	32
4.2.2	TEST INSTRUMENTS.....	32
4.2.3	TEST PROCEDURES	33
4.2.4	DEVIATION FROM TEST STANDARD.....	33
4.2.5	TEST SETUP.....	34
4.2.6	EUT OPERATING CONDITIONS	34
4.2.7	TEST RESULTS	35
4.3	6dB BANDWIDTH MEASUREMENT.....	37
4.3.1	LIMITS OF 6dB BANDWIDTH MEASUREMENT	37
4.3.2	TEST INSTRUMENTS.....	37
4.3.3	TEST PROCEDURE.....	37
4.3.4	DEVIATION FROM TEST STANDARD.....	37
4.3.5	TEST SETUP.....	38
4.3.6	EUT OPERATING CONDITIONS	38
4.3.7	TEST RESULTS	39
4.4	MAXIMUM OUTPUT POWER.....	43
4.4.1	LIMITS OF MAXIMUM OUTPUT POWER MEASUREMENT.....	43
4.4.2	INSTRUMENTS.....	43
4.4.3	TEST PROCEDURE.....	43
4.4.4	DEVIATION FROM TEST STANDARD.....	44
4.4.5	TEST SETUP.....	44
4.4.6	EUT OPERATING CONDITIONS	44
4.4.7	TEST RESULTS	45
4.5	POWER SPECTRAL DENSITY MEASUREMENT.....	46
4.5.1	LIMITS OF POWER SPECTRAL DENSITY MEASUREMENT	46
4.5.2	TEST INSTRUMENTS.....	46
4.5.3	TEST PROCEDURE.....	46
4.5.4	DEVIATION FROM TEST STANDARD.....	47
4.5.5	TEST SETUP.....	47



A D T

4.5.6	EUT OPERATING CONDITION.....	47
4.5.7	TEST RESULTS	48
4.6	BAND EDGES MEASUREMENT	52
4.6.1	LIMITS OF BAND EDGES MEASUREMENT	52
4.6.2	TEST INSTRUMENTS.....	52
4.6.3	TEST PROCEDURE.....	53
4.6.4	DEVIATION FROM TEST STANDARD.....	53
4.6.5	EUT OPERATING CONDITION.....	54
4.6.6	TEST RESULTS	54
5.	TEST TYPES AND RESULTS (FOR 5.0GHz BAND)	70
5.1	RADIATED EMISSION MEASUREMENT	70
5.1.1	LIMITS OF RADIATED EMISSION MEASUREMENT	70
5.1.2	TEST INSTRUMENTS.....	71
5.1.3	TEST PROCEDURES	72
5.1.4	DEVIATION FROM TEST STANDARD.....	72
5.1.5	TEST SETUP	73
5.1.6	EUT OPERATING CONDITIONS	73
5.1.7	TEST RESULTS	74
5.2	CONDUCTED EMISSION MEASUREMENT	83
5.2.1	LIMITS OF CONDUCTED EMISSION MEASUREMENT	83
5.2.2	TEST INSTRUMENTS.....	83
5.2.3	TEST PROCEDURES	84
5.2.4	DEVIATION FROM TEST STANDARD.....	84
5.2.5	TEST SETUP	85
5.2.6	EUT OPERATING CONDITIONS	85
5.2.7	TEST RESULTS	86
5.3	6dB BANDWIDTH MEASUREMENT.....	88
5.3.1	LIMITS OF 6dB BANDWIDTH MEASUREMENT	88
5.3.2	TEST INSTRUMENTS.....	88
5.3.3	TEST PROCEDURE.....	88
5.3.4	DEVIATION FROM TEST STANDARD.....	89
5.3.5	TEST SETUP	89
5.3.6	EUT OPERATING CONDITIONS	89
5.3.7	TEST RESULTS	90
5.4	MAXIMUM OUTPUT POWER.....	93
5.4.1	LIMITS OF MAXIMUM OUTPUT POWER MEASUREMENT.....	93
5.4.2	INSTRUMENTS.....	93
5.4.3	TEST PROCEDURE.....	93
5.4.4	DEVIATION FROM TEST STANDARD.....	94
5.4.5	TEST SETUP	94
5.4.6	EUT OPERATING CONDITIONS	94
5.4.7	TEST RESULTS	95
5.5	POWER SPECTRAL DENSITY MEASUREMENT	96
5.5.1	LIMITS OF POWER SPECTRAL DENSITY MEASUREMENT	96
5.5.2	TEST INSTRUMENTS.....	96
5.5.3	TEST PROCEDURE.....	96
5.5.4	DEVIATION FROM TEST STANDARD.....	97
5.5.5	TEST SETUP	97
5.5.6	EUT OPERATING CONDITION.....	97
5.5.7	TEST RESULTS	98
5.6	BAND EDGES MEASUREMENT	101
5.6.1	LIMITS OF BAND EDGES MEASUREMENT	101



A D T

5.6.2	TEST INSTRUMENTS.....	102
5.6.3	TEST PROCEDURE.....	103
5.6.4	DEVIATION FROM TEST STANDARD.....	103
5.6.5	EUT OPERATING CONDITION.....	104
5.6.6	TEST RESULTS	104
6.	PHOTOGRAPHS OF THE TEST CONFIGURATION.....	114
7.	INFORMATION ON THE TESTING LABORATORIES	115
8.	APPENDIX A - MODIFICATIONS RECORDERS FOR ENGINEERING CHANGES TO THE EUT BY THE LAB.....	116



A D T

1. CERTIFICATION

PRODUCT: Wireless 802.11 a/b/g/n Module

MODEL: AW-NU231

BRAND: AzureWave

APPLICANT: AzureWave Technologies, Inc.

TEST SAMPLE: ENGINEERING SAMPLE

TESTED: Mar. 09 ~ Mar. 18, 2010

STANDARDS: FCC Part 15, Subpart C (Section 15.247)

ANSI C63.4-2003

The above equipment (Model: AW-NU231) has been tested by **Bureau Veritas Consumer Products Services (H.K.) Ltd., Taoyuan Branch**, and found compliance with the requirement of the above standards. The test record, data evaluation & Equipment Under Test (EUT) configurations represented herein are true and accurate accounts of the measurements of the sample's EMC characteristics under the conditions specified in this report.

PREPARED BY : Polly Chien , **DATE** : Mar. 22, 2010
Polly Chien / Specialist

TECHNICAL ACCEPTANCE : Long Chen , **DATE** : Mar. 22, 2010
Responsible for RF Long Chen / Senior Engineer

APPROVED BY : Gary Chang , **DATE** : Mar. 22, 2010
Gary Chang / Assistant Manager



2. SUMMARY OF TEST RESULTS

The EUT has been tested according to the following specifications:

APPLIED STANDARD: FCC PART 15, SUBPART C (SECTION 15.247)			
STANDARD SECTION	TEST TYPE AND LIMIT	RESULT	REMARK
15.207	AC Power Conducted Emission	PASS	Meet the requirement of limit. Minimum passing margin is -13.24dB at 0.151MHz.
15.247(a)(2)	Spectrum Bandwidth of a Direct Sequence Spread Spectrum System Limit: min. 500kHz	PASS	Meet the requirement of limit.
15.247(b)	Maximum Output Power Limit: max. 30dBm	PASS	Meet the requirement of limit.
15.247(d)	Radiated Emissions Limit: Table 15.209	PASS	Meet the requirement of limit. Minimum passing margin is -1.1dB at 2483.50MHz.
15.247(e)	Power Spectral Density Limit: max. 8dBm	PASS	Meet the requirement of limit.
15.247(d)	Band Edge Measurement Limit: 20dB less than the peak value of fundamental frequency	PASS	Meet the requirement of limit.
15.203	Antenna Requirement	PASS	No antenna connector is used.

2.1 MEASUREMENT UNCERTAINTY

Where relevant, the following measurement uncertainty levels have been estimated for tests performed on the EUT as specified in CISPR 16-4-2:

MEASUREMENT	FREQUENCY	UNCERTAINTY
Conducted emissions	150kHz~30MHz	2.44 dB
Radiated emissions	30MHz ~ 200MHz	3.34 dB
	200MHz ~1000MHz	3.35 dB
	1GHz ~ 18GHz	2.26 dB
	18GHz ~ 40GHz	1.94 dB

This uncertainty represents an expanded uncertainty expressed at approximately the 95% confidence level using a coverage factor of $k = 2$.



A D T

3. GENERAL INFORMATION

3.1 GENERAL DESCRIPTION OF EUT

EUT	Wireless 802.11 a/b/g/n Module
MODEL NO.	AW-NU231
FCC ID	TLZ-AWNU231
POWER SUPPLY	5Vdc
MODULATION TYPE	CCK, DQPSK, DBPSK for DSSS 64QAM, 16QAM, QPSK, BPSK for OFDM
MODULATION TECHNOLOGY	DSSS, OFDM
TRANSFER RATE	802.11b: 11.0/ 5.5/ 2.0/ 1.0Mbps 802.11g: 54.0/ 48.0/ 36.0/ 24.0/ 18.0/ 12.0/ 9.0/ 6.0Mbps 802.11a: 54.0/ 48.0/ 36.0/ 24.0/ 18.0/ 12.0/ 9.0/ 6.0Mbps 802.11n: up to 270.0Mbps
OPERATING FREQUENCY	2.4GHz: 2412 ~ 2462MHz 5.0GHz: 5745 ~ 5825MHz
NUMBER OF CHANNEL	2.4GHz: 11 for 802.11b, 802.11g, 802.11n (20MHz) 7 for 802.11n (40MHz) 5.0GHz: 5 for 802.11a, 802.11n (20MHz) 2 for 802.11n (40MHz)
OUTPUT POWER	474.3mW for 2412 ~ 2462MHz 328.1mW for 5745 ~ 5825MHz
ANTENNA TYPE	2.4GHz: PCB antenna with 0.54dBi gain 5.0GHz: PCB antenna with 1.59dBi gain
ANTENNA CONNECTOR	NA
I/O PORTS	USB
DATA CABLE	NA
ACCESSORY DEVICES	NA

NOTE:

1. The EUT is a wireless 802.11 a/b/g/n Module. The functions of EUT listed as below:

	TEST STANDARD	REFERENCE REPORT
WLAN 802.11b/g, 802.11n	FCC Part 15, Subpart C (Section 15.247)	RF990226L03
WLAN 802.11a, 802.11n (5745~5825 MHz)		
WLAN 802.11a, 802.11n (5180~5320MHz & 5500 ~5700MHz)	FCC Part 15, Subpart E (Section 15.407)	RF990226L03-1
WLAN 802.11a, 802.11n (For DFS report) (5250~5350MHz & 5470~5725MHz)		RF990226L03-2



A D T

2. The frequency bands used in this EUT are listed as follows:

Frequency Band (MHz)	2412~2462	5180~5320	5500~5700	5745~5825
802.11b	√	-	-	-
802.11g	√	-	-	-
802.11a	-	√	√	√
802.11n (20MHz) (MCS 0-7) / (MCS 8-15)	√	√	√	√
802.11n (40MHz) (MCS 0-7) / (MCS 8-15)	√	√	√	√

3. The EUT incorporates a MIMO function. Physically, the EUT provides two completed transmitters and two receivers.

MODULATION MODE	TX FUNCTION
802.11b	1TX
802.11g	1TX
802.11a	1TX
802.11n (20MHz) (MCS 0-7)	1TX
802.11n (20MHz) (MCS 8-15)	2TX
802.11n (40MHz) (MCS 0-7)	1TX
802.11n (40MHz) (MCS 8-15)	2TX

4. The above EUT information was declared by manufacturer and for more detailed features description, please refer to the manufacturer's specifications or user's manual.

3.2 DESCRIPTION OF TEST MODES

FOR 2.4GHz:

11 channels are provided for 802.11b, 802.11g and 802.11n (20MHz):

CHANNEL	FREQUENCY	CHANNEL	FREQUENCY
1	2412MHz	7	2442MHz
2	2417MHz	8	2447MHz
3	2422MHz	9	2452MHz
4	2427MHz	10	2457MHz
5	2432MHz	11	2462MHz
6	2437MHz		

7 channels are provided for 802.11n (40MHz):

CHANNEL	FREQUENCY	CHANNEL	FREQUENCY
1	2422MHz	5	2442MHz
2	2427MHz	6	2447MHz
3	2432MHz	7	2452MHz
4	2437MHz		

FOR 5.0GHz (5745 ~ 5825MHz):

5 channels are provided for 802.11a, 802.11n (20MHz):

CHANNEL	FREQUENCY	CHANNEL	FREQUENCY
149	5745MHz	161	5805MHz
153	5765MHz	165	5825MHz
157	5785MHz		

2 channels are provided for 802.11n (40MHz):

CHANNEL	FREQUENCY	CHANNEL	FREQUENCY
151	5755MHz	159	5795MHz

3.2.1 CONFIGURATION OF SYSTEM UNDER TEST

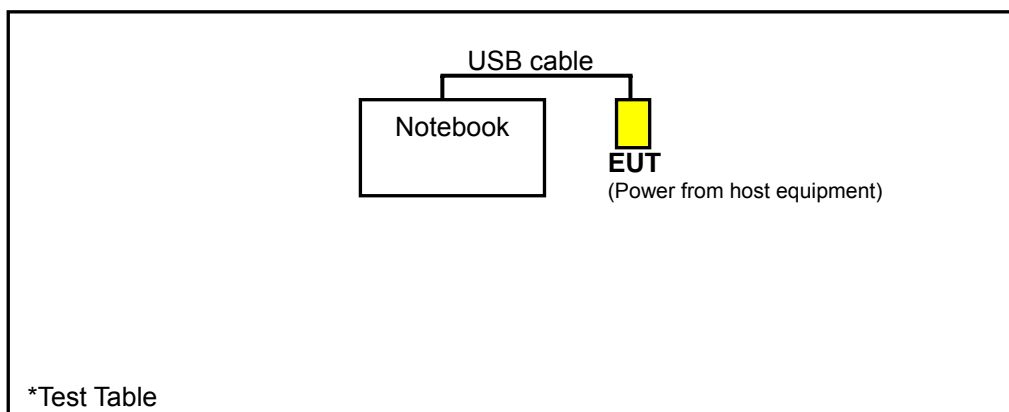



3.2.2 TEST MODE APPLICABILITY AND TESTED CHANNEL DETAIL

FOR 2.4GHz:

EUT CONFIGURE MODE	APPLICABLE TO				DESCRIPTION
	RE \geq 1G	RE<1G	PLC	APCM	
-	√	√	√	√	-

Where **RE \geq 1G:** Radiated Emission above 1GHz **RE<1G:** Radiated Emission below 1GHz
PLC: Power Line Conducted Emission **APCM:** Antenna Port Conducted Measurement

NOTE : Conducted power of single TX chain has no different when operating at 1 TX or 2 TX mode. Therefore, only 2 TX mode will be tested for 802.11n.

RADIATED EMISSION TEST (ABOVE 1GHz):

- Pre-Scan has been conducted to determine the worst-case mode from all possible combinations between available modulations, XYZ axis and antenna ports (if EUT with antenna diversity architecture).
- Following channel(s) was (were) selected for the final test as listed below.

MODE	AVAILABLE CHANNEL	TESTED CHANNEL	MODULATION TECHNOLOGY	MODULATION TYPE	DATA RATE (Mbps)	AXIS
802.11b	1 to 11	1, 6, 11	DSSS	DBPSK	1.0	Z
802.11g	1 to 11	1, 6, 11	OFDM	BPSK	6.0	Z
802.11n (20MHz) (MCS 8-15)	1 to 11	1, 6, 11	OFDM	BPSK	6.5	Y
802.11n (40MHz) (MCS 8-15)	1 to 7	1, 4, 7	OFDM	BPSK	13.5	Y

RADIATED EMISSION TEST (BELOW 1GHz):

- Pre-Scan has been conducted to determine the worst-case mode from all possible combinations between available modulations, XYZ axis and antenna ports (if EUT with antenna diversity architecture).
- Following channel(s) was (were) selected for the final test as listed below.

MODE	AVAILABLE CHANNEL	TESTED CHANNEL	MODULATION TECHNOLOGY	MODULATION TYPE	DATA RATE (Mbps)	AXIS
802.11n (20MHz) (MCS 8-15)	1 to 11	11	OFDM	BPSK	13.5	Y

POWER LINE CONDUCTED EMISSION TEST:

- Pre-Scan has been conducted to determine the worst-case mode from all possible combinations between available modulations, data rates and antenna ports (if EUT with antenna diversity architecture).
- Following channel(s) was (were) selected for the final test as listed below.

MODE	AVAILABLE CHANNEL	TESTED CHANNEL	MODULATION TECHNOLOGY	MODULATION TYPE	DATA RATE (Mbps)
802.11n (20MHz) (MCS 8-15)	1 to 11	11	OFDM	BPSK	13.5



BANDEDGE MEASUREMENT:

- Pre-Scan has been conducted to determine the worst-case mode from all possible combinations between available modulations, data rates and antenna ports (if EUT with antenna diversity architecture).
- Following channel(s) was (were) selected for the final test as listed below.

MODE	AVAILABLE CHANNEL	TESTED CHANNEL	MODULATION TECHNOLOGY	MODULATION TYPE	DATA RATE (Mbps)
802.11b	1 to 11	1, 11	DSSS	DBPSK	1.0
802.11g	1 to 11	1, 11	OFDM	BPSK	6.0
802.11n (20MHz) (MCS 8-15)	1 to 11	1, 11	OFDM	BPSK	6.5
802.11n (40MHz) (MCS 8-15)	1 to 7	1, 7	OFDM	BPSK	13.5

ANTENNA PORT CONDUCTED MEASUREMENT:

- This item includes all test value of each mode, but only includes spectrum plot of worst value of each mode.
- Pre-Scan has been conducted to determine the worst-case mode from all possible combinations between available modulations, data rates and antenna ports (if EUT with antenna diversity architecture).
- Following channel(s) was (were) selected for the final test as listed below.

MODE	AVAILABLE CHANNEL	TESTED CHANNEL	MODULATION TECHNOLOGY	MODULATION TYPE	DATA RATE (Mbps)
802.11b	1 to 11	1, 6, 11	DSSS	DBPSK	1.0
802.11g	1 to 11	1, 6, 11	OFDM	BPSK	6.0
802.11n (20MHz) (MCS 8-15)	1 to 11	1, 6, 11	OFDM	BPSK	6.5
802.11n (40MHz) (MCS 8-15)	1 to 7	1, 4, 7	OFDM	BPSK	13.5

TEST CONDITION:

APPLICABLE TO	ENVIRONMENTAL CONDITIONS	INPUT POWER (SYSTEM)	TESTED BY
RE≥1G	23deg. C, 65%RH, 1011 hPa	120Vac, 60Hz	Brad Wu
RE<1G	24deg. C, 66%RH, 1008 hPa	120Vac, 60Hz	Brad Wu
PLC	23deg. C, 66%RH, 1007 hPa	120Vac, 60Hz	Dean Wang
APCM	25deg. C, 63%RH, 1006 hPa	120Vac, 60Hz	Brad Wu



A D T

FOR 5.745 ~ 5.825GHz:

EUT CONFIGURE MODE	APPLICABLE TO				DESCRIPTION
	RE \geq 1G	RE<1G	PLC	APCM	
-	√	√	√	√	-

Where **RE \geq 1G**: Radiated Emission above 1GHz **RE<1G**: Radiated Emission below 1GHz
PLC: Power Line Conducted Emission **APCM**: Antenna Port Conducted Measurement

NOTE : Conducted power of single TX chain has no different when operating at 1 TX or 2 TX mode. Therefore, only 2 TX mode will be tested for 802.11n.

RADIATED EMISSION TEST (ABOVE 1GHz):

- Pre-Scan has been conducted to determine the worst-case mode from all possible combinations between available modulations, XYZ axis and antenna ports (if EUT with antenna diversity architecture).
- Following channel(s) was (were) selected for the final test as listed below.

MODE	AVAILABLE CHANNEL	TESTED CHANNEL	MODULATION TECHNOLOGY	MODULATION TYPE	DATA RATE (Mbps)	AXIS
802.11a	149 to 165	149, 157, 165	OFDM	BPSK	6.0	Z
802.11n (20MHz) (MCS 8-15)	149 to 165	149, 157, 165	OFDM	BPSK	6.5	Z
802.11n (40MHz) (MCS 8-15)	151 to 159	151, 159	OFDM	BPSK	13.5	Z

RADIATED EMISSION TEST (BELOW 1GHz):

- Pre-Scan has been conducted to determine the worst-case mode from all possible combinations between available modulations, XYZ axis and antenna ports (if EUT with antenna diversity architecture).
- Following channel(s) was (were) selected for the final test as listed below.

MODE	AVAILABLE CHANNEL	TESTED CHANNEL	MODULATION TECHNOLOGY	MODULATION TYPE	DATA RATE (Mbps)	AXIS
802.11n (20MHz) (MCS 8-15)	149 to 165	157	OFDM	BPSK	6.5	Z

POWER LINE CONDUCTED EMISSION TEST:

- Pre-Scan has been conducted to determine the worst-case mode from all possible combinations between available modulations, data rates and antenna ports (if EUT with antenna diversity architecture).
- Following channel(s) was (were) selected for the final test as listed below.

MODE	AVAILABLE CHANNEL	TESTED CHANNEL	MODULATION TECHNOLOGY	MODULATION TYPE	DATA RATE (Mbps)
802.11n (20MHz) (MCS 8-15)	149 to 165	157	OFDM	BPSK	6.5



BANDEDGE MEASUREMENT:

- Pre-Scan has been conducted to determine the worst-case mode from all possible combinations between available modulations, data rates and antenna ports (if EUT with antenna diversity architecture).
- Following channel(s) was (were) selected for the final test as listed below.

MODE	AVAILABLE CHANNEL	TESTED CHANNEL	MODULATION TECHNOLOGY	MODULATION TYPE	DATA RATE (Mbps)
802.11a	149 to 165	149, 165	OFDM	BPSK	6.0
802.11n (20MHz) (MCS 8-15)	149 to 165	149, 165	OFDM	BPSK	6.5
802.11n (40MHz) (MCS 8-15)	151 to 159	151, 159	OFDM	BPSK	13.5

ANTENNA PORT CONDUCTED MEASUREMENT:

- This item includes all test value of each mode, but only includes spectrum plot of worst value of each mode.
- Pre-Scan has been conducted to determine the worst-case mode from all possible combinations between available modulations, data rates and antenna ports (if EUT with antenna diversity architecture).
- Following channel(s) was (were) selected for the final test as listed below.

MODE	AVAILABLE CHANNEL	TESTED CHANNEL	MODULATION TECHNOLOGY	MODULATION TYPE	DATA RATE (Mbps)
802.11a	149 to 165	149, 157, 165	OFDM	BPSK	6.0
802.11n (20MHz) (MCS 8-15)	149 to 165	149, 157, 165	OFDM	BPSK	6.5
802.11n (40MHz) (MCS 8-15)	151 to 159	151, 159	OFDM	BPSK	13.5

TEST CONDITION:

APPLICABLE TO	ENVIRONMENTAL CONDITIONS	INPUT POWER (SYSTEM)	TESTED BY
RE≥1G	23deg. C, 65%RH, 1011 hPa	120Vac, 60Hz	Brad Wu
RE<1G	24deg. C, 66%RH, 1008 hPa	120Vac, 60Hz	Brad Wu
PLC	23deg. C, 66%RH, 1007 hPa	120Vac, 60Hz	Dean Wang
APCM	25deg. C, 63%RH, 1006 hPa	120Vac, 60Hz	Brad Wu



3.3 GENERAL DESCRIPTION OF APPLIED STANDARDS

The EUT is a RF Product. According to the specifications of the manufacturer, it must comply with the requirements of the following standards:

FCC Part 15, Subpart C (15.247)

ANSI C63.4-2003

All test items have been performed and recorded as per the above standards.

NOTE: The EUT is also considered as a kind of computer peripheral, because the connection to computer is necessary for typical use. It has been verified to comply with the requirements of FCC Part 15, Subpart B, Class B (DoC). The test report has been issued separately.

3.4 DESCRIPTION OF SUPPORT UNITS

The EUT has been tested as an independent unit together with other necessary accessories or support units. The following support units or accessories were used to form a representative test configuration during the tests.

NO.	PRODUCT	BRAND	MODEL NO.	SERIAL NO.	FCC ID
1	NOTEBOOK	DELL	PP09S	NA	NA

NO.	SIGNAL CABLE DESCRIPTION OF THE ABOVE SUPPORT UNITS
1	0.53m non-shielded USB cable without core.

NOTE:

- 1. All power cords of the above support units are non shielded (1.8m).
- 2. Item 1 and 0.53m USB cable were provided by the client.



A D T

4. TEST TYPES AND RESULTS (FOR 2.4GHz BAND)

4.1 RADIATED EMISSION MEASUREMENT

4.1.1 LIMITS OF RADIATED EMISSION MEASUREMENT

Emissions radiated outside of the specified bands, shall be according to the general radiated limits in 15.209 as following:

FREQUENCIES (MHz)	FIELD STRENGTH (microvolts/meter)	MEASUREMENT DISTANCE (meters)
0.009 ~ 0.490	2400/F(kHz)	300
0.490 ~ 1.705	24000/F(kHz)	30
1.705 ~ 30.0	30	30
30 ~ 88	100	3
88 ~ 216	150	3
216 ~ 960	200	3
Above 960	500	3

NOTE:

1. The lower limit shall apply at the transition frequencies.
2. Emission level (dBuV/m) = 20 log Emission level (uV/m).
3. As shown in 15.35(b), for frequencies above 1000MHz, the field strength limits are based on average detector, however, the peak field strength of any emission shall not exceed the maximum permitted average limits, specified above by more than 20dB under any condition of modulation.



ADT

4.1.2 TEST INSTRUMENTS

DESCRIPTION & MANUFACTURER	MODEL NO.	SERIAL NO.	DATE OF CALIBRATION	DUE DATE OF CALIBRATION
Test Receiver ROHDE & SCHWARZ	ESI7	100033	Jul. 06, 2009	Jul. 05, 2010
Spectrum Analyzer ROHDE & SCHWARZ	FSP40	100076	May 26, 2009	May 25, 2010
BILOG Antenna SCHWARZBECK	VULB9168	9168-160	Apr. 27, 2009	Apr. 26, 2010
HORN Antenna SCHWARZBECK	9120D	9120D-209	Jul. 01, 2009	Jun. 30, 2010
HORN Antenna SCHWARZBECK	BBHA 9170	BBHA9170243	Dec. 25, 2009	Dec. 24, 2010
Preamplifier Agilent	8447D	2944A10633	Nov. 10, 2009	Nov. 09, 2010
Preamplifier Agilent	8449B	3008A01964	Nov. 09, 2009	Nov. 08, 2010
RF signal cable HUBER+SUHNNER	SUCOFLEX 104	238141/4	May 13, 2009	May 12, 2010
RF signal cable HUBER+SUHNNER	SUCOFLEX 104	12738/6	May 13, 2009	May 12, 2010
Software ADT.	ADT_Radiated_ V7.6.15.9.2	NA	NA	NA
Antenna Tower inn-co GmbH	MA 4000	013303	NA	NA
Antenna Tower Controller inn-co GmbH	CO2000	017303	NA	NA
Turn Table ADT.	TT100.	TT93021703	NA	NA
Turn Table Controller ADT.	SC100.	SC93021703	NA	NA

- NOTE:**
1. The calibration interval of the above test instruments is 12 months and the calibrations are traceable to NML/ROC and NIST/USA.
 2. The test was performed in HwaYa Chamber 3.
 3. The horn antenna and HP preamplifier (model: 8449B) are used only for the measurement of emission frequency above 1GHz if tested.
 4. The FCC Site Registration No. is 988962.
 5. The IC Site Registration No. is IC 7450F-3.



4.1.3 TEST PROCEDURES

- a. The EUT was placed on the top of a rotating table 0.8 meters above the ground at a 3 meters semi-anechoic chamber. The table was rotated 360 degrees to determine the position of the highest radiation.
- b. The EUT was set 3 meters away from the interference-receiving antenna, which was mounted on the top of a variable-height antenna tower.
- c. The antenna is a broadband antenna, and its height is varied from one meter to four meters above the ground to determine the maximum value of the field strength. Both horizontal and vertical polarizations of the antenna are set to make the measurement.
- d. For each suspected emission, the EUT was arranged to its worst case and then the antenna was tuned to heights from 1 meter to 4 meters and the rotatable table was turned from 0 degrees to 360 degrees to find the maximum reading.
- e. The test-receiver system was set to Peak Detect Function and Specified Bandwidth with Maximum Hold Mode.
- f. If the emission level of the EUT in peak mode was lower than the limit specified, then testing could be stopped and the peak values of the EUT would be reported. Otherwise the emissions would be re-tested one by one using peak, quasi-peak or average method as specified and then reported in a data sheet.

NOTE:

1. The resolution bandwidth and video bandwidth of test receiver/spectrum analyzer is 120kHz for Quasi-peak detection at frequency below 1GHz.
2. The resolution bandwidth of test receiver/spectrum analyzer is 1MHz and video bandwidth is 3MHz for Peak detection at frequency above 1GHz.
3. The resolution bandwidth of test receiver/spectrum analyzer is 1MHz and the video bandwidth is 10Hz for Average detection (AV) at frequency above 1GHz.
4. All modes of operation were investigated and the worst-case emissions are reported.

4.1.4 DEVIATION FROM TEST STANDARD

No deviation.

4.1.5 TEST SETUP

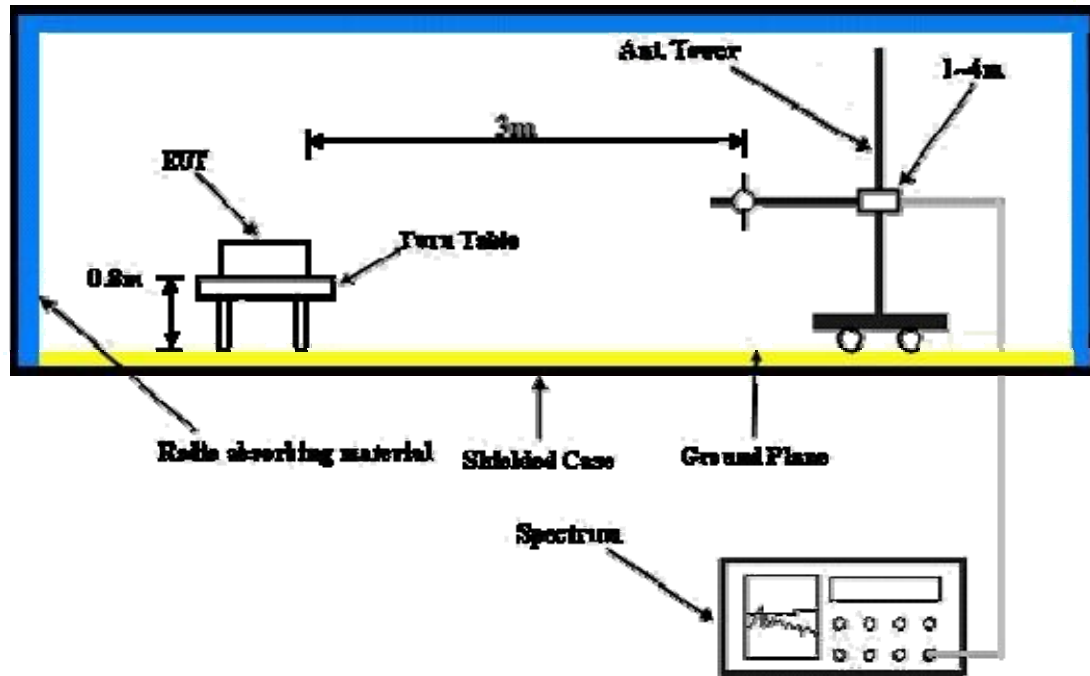

For the actual test configuration, please refer to the attached file (Test Setup Photo).

4.1.6 EUT OPERATING CONDITIONS

- Connected the EUT with notebook system via USB cable on a testing table
- The notebook system ran a test program (provided by manufacturer) to enable EUT under transmission condition continuously at specific channel frequency.
- The necessary accessories enable the EUT in full functions.



A D T

4.1.7 TEST RESULTS

802.11b

EUT TEST CONDITION		MEASUREMENT DETAIL	
CHANNEL	Channel 1	FREQUENCY RANGE	1 ~ 25GHz
INPUT POWER (SYSTEM)	120Vac, 60 Hz	DETECTOR FUNCTION	Peak (PK) Average (AV)
ENVIRONMENTAL CONDITIONS	23deg. C, 65%RH 1011 hPa	TESTED BY	Brad Wu

ANTENNA POLARITY & TEST DISTANCE: HORIZONTAL AT 3 M								
NO.	FREQ. (MHz)	EMISSION LEVEL (dBuV/m)	LIMIT (dBuV/m)	MARGIN (dB)	ANTENNA HEIGHT (m)	TABLE ANGLE (Degree)	RAW VALUE (dBuV)	CORRECTION FACTOR (dB/m)
1	2389.00	58.6 PK	74.0	-15.4	1.27 H	44	28.10	30.50
2	2389.00	49.3 AV	54.0	-4.7	1.27 H	44	18.80	30.50
3	*2412.00	106.1 PK			1.27 H	44	75.50	30.60
4	*2412.00	101.9 AV			1.27 H	44	71.30	30.60
5	4824.00	48.1 PK	74.0	-25.9	1.44 H	335	12.00	36.10
6	4824.00	40.8 AV	54.0	-13.2	1.44 H	335	4.70	36.10
ANTENNA POLARITY & TEST DISTANCE: VERTICAL AT 3 M								
NO.	FREQ. (MHz)	EMISSION LEVEL (dBuV/m)	LIMIT (dBuV/m)	MARGIN (dB)	ANTENNA HEIGHT (m)	TABLE ANGLE (Degree)	RAW VALUE (dBuV)	CORRECTION FACTOR (dB/m)
1	2389.00	61.7 PK	74.0	-12.3	1.00 V	11	31.20	30.50
2	2389.00	52.8 AV	54.0	-1.2	1.00 V	11	22.30	30.50
3	*2412.00	109.2 PK			1.00 V	12	78.60	30.60
4	*2412.00	105.0 AV			1.00 V	12	74.40	30.60
5	4824.00	49.6 PK	74.0	-24.4	1.03 V	262	13.50	36.10
6	4824.00	43.5 AV	54.0	-10.5	1.03 V	262	7.40	36.10

- REMARKS:**
1. Emission level (dBuV/m) = Raw Value (dBuV) + Correction Factor (dB/m).
 2. Correction Factor (dB/m) = Antenna Factor (dB/m) + Cable Factor (dB).
 3. The other emission levels were very low against the limit.
 4. Margin value = Emission level – Limit value.
 5. “ * “: Fundamental frequency.



A D T

EUT TEST CONDITION		MEASUREMENT DETAIL	
CHANNEL	Channel 6	FREQUENCY RANGE	1 ~ 25GHz
INPUT POWER (SYSTEM)	120Vac, 60 Hz	DETECTOR FUNCTION	Peak (PK) Average (AV)
ENVIRONMENTAL CONDITIONS	23deg. C, 65%RH 1011 hPa	TESTED BY	Brad Wu

ANTENNA POLARITY & TEST DISTANCE: HORIZONTAL AT 3 M								
NO.	FREQ. (MHz)	EMISSION LEVEL (dBuV/m)	LIMIT (dBuV/m)	MARGIN (dB)	ANTENNA HEIGHT (m)	TABLE ANGLE (Degree)	RAW VALUE (dBuV)	CORRECTION FACTOR (dB/m)
1	*2437.00	106.3 PK			1.26 H	45	75.70	30.60
2	*2437.00	102.1 AV			1.26 H	45	71.50	30.60
3	4874.00	48.3 PK	74.0	-25.7	1.46 H	338	12.10	36.20
4	4874.00	41.0 AV	54.0	-13.0	1.46 H	338	4.80	36.20
ANTENNA POLARITY & TEST DISTANCE: VERTICAL AT 3 M								
NO.	FREQ. (MHz)	EMISSION LEVEL (dBuV/m)	LIMIT (dBuV/m)	MARGIN (dB)	ANTENNA HEIGHT (m)	TABLE ANGLE (Degree)	RAW VALUE (dBuV)	CORRECTION FACTOR (dB/m)
1	*2437.00	109.4 PK			1.01 V	13	78.80	30.60
2	*2437.00	105.2 AV			1.01 V	13	74.60	30.60
3	4874.00	49.8 PK	74.0	-24.2	1.05 V	265	13.60	36.20
4	4874.00	43.6 AV	54.0	-10.4	1.05 V	265	7.40	36.20

- REMARKS:**
1. Emission level (dBuV/m) = Raw Value (dBuV) + Correction Factor (dB/m).
 2. Correction Factor (dB/m) = Antenna Factor (dB/m) + Cable Factor (dB).
 3. The other emission levels were very low against the limit.
 4. Margin value = Emission level – Limit value.
 5. “ * ”: Fundamental frequency.



A D T

EUT TEST CONDITION		MEASUREMENT DETAIL	
CHANNEL	Channel 11	FREQUENCY RANGE	1 ~ 25GHz
INPUT POWER (SYSTEM)	120Vac, 60 Hz	DETECTOR FUNCTION	Peak (PK) Average (AV)
ENVIRONMENTAL CONDITIONS	23deg. C, 65%RH 1011 hPa	TESTED BY	Brad Wu

ANTENNA POLARITY & TEST DISTANCE: HORIZONTAL AT 3 M								
NO.	FREQ. (MHz)	EMISSION LEVEL (dBuV/m)	LIMIT (dBuV/m)	MARGIN (dB)	ANTENNA HEIGHT (m)	TABLE ANGLE (Degree)	RAW VALUE (dBuV)	CORRECTION FACTOR (dB/m)
1	*2462.00	106.5 PK			1.25 H	46	75.80	30.70
2	*2462.00	102.3 AV			1.25 H	46	71.60	30.70
3	2483.50	60.2 PK	74.0	-13.8	1.25 H	46	29.40	30.80
4	2483.50	49.8 AV	54.0	-4.2	1.25 H	46	19.00	30.80
5	4924.00	48.6 PK	74.0	-25.4	1.14 H	22	12.30	36.30
6	4924.00	41.3 AV	54.0	-12.7	1.14 H	22	5.00	36.30
ANTENNA POLARITY & TEST DISTANCE: VERTICAL AT 3 M								
NO.	FREQ. (MHz)	EMISSION LEVEL (dBuV/m)	LIMIT (dBuV/m)	MARGIN (dB)	ANTENNA HEIGHT (m)	TABLE ANGLE (Degree)	RAW VALUE (dBuV)	CORRECTION FACTOR (dB/m)
1	*2462.00	109.6 PK			1.00 V	3	78.90	30.70
2	*2462.00	105.3 AV			1.00 V	3	74.60	30.70
3	2483.50	63.6 PK	74.0	-10.4	1.00 V	3	32.80	30.80
4	2483.50	52.9 AV	54.0	-1.1	1.00 V	3	22.10	30.80
5	4924.00	50.1 PK	74.0	-23.9	1.08 V	249	13.80	36.30
6	4924.00	43.9 AV	54.0	-10.1	1.08 V	249	7.60	36.30

- REMARKS:**
1. Emission level (dBuV/m) = Raw Value (dBuV) + Correction Factor (dB/m).
 2. Correction Factor (dB/m) = Antenna Factor (dB/m) + Cable Factor (dB).
 3. The other emission levels were very low against the limit.
 4. Margin value = Emission level – Limit value.
 5. “ * “: Fundamental frequency.



A D T

802.11g

EUT TEST CONDITION		MEASUREMENT DETAIL	
CHANNEL	Channel 1	FREQUENCY RANGE	1 ~ 25GHz
INPUT POWER (SYSTEM)	120Vac, 60 Hz	DETECTOR FUNCTION	Peak (PK) Average (AV)
ENVIRONMENTAL CONDITIONS	23deg. C, 65%RH 1011 hPa	TESTED BY	Brad Wu

ANTENNA POLARITY & TEST DISTANCE: HORIZONTAL AT 3 M								
NO.	FREQ. (MHz)	EMISSION LEVEL (dBuV/m)	LIMIT (dBuV/m)	MARGIN (dB)	ANTENNA HEIGHT (m)	TABLE ANGLE (Degree)	RAW VALUE (dBuV)	CORRECTION FACTOR (dB/m)
1	2390.00	64.6 PK	74.0	-9.4	1.55 H	43	34.10	30.50
2	2390.00	48.9 AV	54.0	-5.1	1.55 H	43	18.40	30.50
3	*2412.00	106.4 PK			1.55 H	43	75.80	30.60
4	*2412.00	93.2 AV			1.55 H	43	62.60	30.60
5	4824.00	46.5 PK	74.0	-27.5	1.00 H	21	10.40	36.10
6	4824.00	33.9 AV	54.0	-20.1	1.00 H	21	-2.20	36.10

ANTENNA POLARITY & TEST DISTANCE: VERTICAL AT 3 M								
NO.	FREQ. (MHz)	EMISSION LEVEL (dBuV/m)	LIMIT (dBuV/m)	MARGIN (dB)	ANTENNA HEIGHT (m)	TABLE ANGLE (Degree)	RAW VALUE (dBuV)	CORRECTION FACTOR (dB/m)
1	2390.00	66.8 PK	74.0	-7.2	1.00 V	12	36.30	30.50
2	2390.00	51.2 AV	54.0	-2.8	1.00 V	12	20.70	30.50
3	*2412.00	108.6 PK			1.00 V	12	78.00	30.60
4	*2412.00	95.5 AV			1.00 V	12	64.90	30.60
5	4824.00	46.1 PK	74.0	-27.9	1.02 V	25	10.00	36.10
6	4824.00	33.5 AV	54.0	-20.5	1.02 V	25	-2.60	36.10

- REMARKS:**
1. Emission level (dBuV/m) = Raw Value (dBuV) + Correction Factor (dB/m).
 2. Correction Factor (dB/m) = Antenna Factor (dB/m) + Cable Factor (dB).
 3. The other emission levels were very low against the limit.
 4. Margin value = Emission level – Limit value.
 5. “ * “: Fundamental frequency.



A D T

EUT TEST CONDITION		MEASUREMENT DETAIL	
CHANNEL	Channel 6	FREQUENCY RANGE	1 ~ 25GHz
INPUT POWER (SYSTEM)	120Vac, 60 Hz	DETECTOR FUNCTION	Peak (PK) Average (AV)
ENVIRONMENTAL CONDITIONS	23deg. C, 65%RH 1011 hPa	TESTED BY	Brad Wu

ANTENNA POLARITY & TEST DISTANCE: HORIZONTAL AT 3 M								
NO.	FREQ. (MHz)	EMISSION LEVEL (dBuV/m)	LIMIT (dBuV/m)	MARGIN (dB)	ANTENNA HEIGHT (m)	TABLE ANGLE (Degree)	RAW VALUE (dBuV)	CORRECTION FACTOR (dB/m)
1	*2437.00	106.6 PK			1.54 H	45	76.00	30.60
2	*2437.00	93.5 AV			1.54 H	45	62.90	30.60
3	4874.00	46.2 PK	74.0	-27.8	1.01 H	54	10.00	36.20
4	4874.00	33.6 AV	54.0	-20.4	1.01 H	54	-2.60	36.20
ANTENNA POLARITY & TEST DISTANCE: VERTICAL AT 3 M								
NO.	FREQ. (MHz)	EMISSION LEVEL (dBuV/m)	LIMIT (dBuV/m)	MARGIN (dB)	ANTENNA HEIGHT (m)	TABLE ANGLE (Degree)	RAW VALUE (dBuV)	CORRECTION FACTOR (dB/m)
1	*2437.00	108.9 PK			1.02 V	15	78.30	30.60
2	*2437.00	95.8 AV			1.02 V	15	65.20	30.60
3	4874.00	47.2 PK	74.0	-26.8	1.05 V	66	11.00	36.20
4	4874.00	34.5 AV	54.0	-19.5	1.05 V	66	-1.70	36.20

- REMARKS:**
1. Emission level (dBuV/m) = Raw Value (dBuV) + Correction Factor (dB/m).
 2. Correction Factor (dB/m) = Antenna Factor (dB/m) + Cable Factor (dB).
 3. The other emission levels were very low against the limit.
 4. Margin value = Emission level – Limit value.
 5. “ * “: Fundamental frequency.



A D T

EUT TEST CONDITION		MEASUREMENT DETAIL	
CHANNEL	Channel 11	FREQUENCY RANGE	1 ~ 25GHz
INPUT POWER (SYSTEM)	120Vac, 60 Hz	DETECTOR FUNCTION	Peak (PK) Average (AV)
ENVIRONMENTAL CONDITIONS	23deg. C, 65%RH 1011 hPa	TESTED BY	Brad Wu

ANTENNA POLARITY & TEST DISTANCE: HORIZONTAL AT 3 M								
NO.	FREQ. (MHz)	EMISSION LEVEL (dBuV/m)	LIMIT (dBuV/m)	MARGIN (dB)	ANTENNA HEIGHT (m)	TABLE ANGLE (Degree)	RAW VALUE (dBuV)	CORRECTION FACTOR (dB/m)
1	*2462.00	106.8 PK			1.55 H	46	76.10	30.70
2	*2462.00	93.6 AV			1.55 H	46	62.90	30.70
3	2483.50	63.4 PK	74.0	-10.6	1.55 H	46	32.60	30.80
4	2483.50	47.5 AV	54.0	-6.5	1.55 H	46	16.70	30.80
5	4924.00	46.5 PK	74.0	-27.5	1.01 H	263	10.20	36.30
6	4924.00	33.9 AV	54.0	-20.1	1.01 H	263	-2.40	36.30
ANTENNA POLARITY & TEST DISTANCE: VERTICAL AT 3 M								
NO.	FREQ. (MHz)	EMISSION LEVEL (dBuV/m)	LIMIT (dBuV/m)	MARGIN (dB)	ANTENNA HEIGHT (m)	TABLE ANGLE (Degree)	RAW VALUE (dBuV)	CORRECTION FACTOR (dB/m)
1	*2462.00	109.1 PK			1.00 V	4	78.40	30.70
2	*2462.00	96.0 AV			1.00 V	4	65.30	30.70
3	2483.50	67.6 PK	74.0	-6.4	1.00 V	9	36.80	30.80
4	2483.50	51.1 AV	54.0	-2.9	1.00 V	9	20.30	30.80
5	4924.00	47.4 PK	74.0	-26.6	1.03 V	29	11.10	36.30
6	4924.00	34.6 AV	54.0	-19.4	1.03 V	29	-1.70	36.30

- REMARKS:**
1. Emission level (dBuV/m) = Raw Value (dBuV) + Correction Factor (dB/m).
 2. Correction Factor (dB/m) = Antenna Factor (dB/m) + Cable Factor (dB).
 3. The other emission levels were very low against the limit.
 4. Margin value = Emission level – Limit value.
 5. “ * “: Fundamental frequency.



A D T

802.11n (20MHz)

EUT TEST CONDITION		MEASUREMENT DETAIL	
CHANNEL	Channel 1	FREQUENCY RANGE	1 ~ 25GHz
INPUT POWER (SYSTEM)	120Vac, 60 Hz	DETECTOR FUNCTION	Peak (PK) Average (AV)
ENVIRONMENTAL CONDITIONS	23deg. C, 65%RH 1011 hPa	TESTED BY	Brad Wu

ANTENNA POLARITY & TEST DISTANCE: HORIZONTAL AT 3 M								
NO.	FREQ. (MHz)	EMISSION LEVEL (dBuV/m)	LIMIT (dBuV/m)	MARGIN (dB)	ANTENNA HEIGHT (m)	TABLE ANGLE (Degree)	RAW VALUE (dBuV)	CORRECTION FACTOR (dB/m)
1	2390.00	70.7 PK	74.0	-3.3	1.06 H	144	40.20	30.50
2	2390.00	51.2 AV	54.0	-2.8	1.06 H	144	20.70	30.50
3	*2412.00	110.9 PK			1.06 H	146	80.30	30.60
4	*2412.00	93.2 AV			1.06 H	146	62.60	30.60
5	4824.00	46.8 PK	74.0	-27.2	1.04 H	229	10.70	36.10
6	4824.00	34.1 AV	54.0	-19.9	1.04 H	229	-2.00	36.10

ANTENNA POLARITY & TEST DISTANCE: VERTICAL AT 3 M								
NO.	FREQ. (MHz)	EMISSION LEVEL (dBuV/m)	LIMIT (dBuV/m)	MARGIN (dB)	ANTENNA HEIGHT (m)	TABLE ANGLE (Degree)	RAW VALUE (dBuV)	CORRECTION FACTOR (dB/m)
1	2390.00	63.6 PK	74.0	-10.4	1.34 V	188	33.10	30.50
2	2390.00	46.1 AV	54.0	-7.9	1.34 V	188	15.60	30.50
3	*2412.00	106.4 PK			1.34 V	188	75.80	30.60
4	*2412.00	88.7 AV			1.34 V	188	58.10	30.60
5	4824.00	46.4 PK	74.0	-27.6	1.02 V	55	10.30	36.10
6	4824.00	33.8 AV	54.0	-20.2	1.02 V	55	-2.30	36.10

- REMARKS:**
1. Emission level (dBuV/m) = Raw Value (dBuV) + Correction Factor (dB/m).
 2. Correction Factor (dB/m) = Antenna Factor (dB/m) + Cable Factor (dB).
 3. The other emission levels were very low against the limit.
 4. Margin value = Emission level – Limit value.
 5. “ * “: Fundamental frequency.



A D T

EUT TEST CONDITION		MEASUREMENT DETAIL	
CHANNEL	Channel 6	FREQUENCY RANGE	1 ~ 25GHz
INPUT POWER (SYSTEM)	120Vac, 60 Hz	DETECTOR FUNCTION	Peak (PK) Average (AV)
ENVIRONMENTAL CONDITIONS	23deg. C, 65%RH 1011 hPa	TESTED BY	Brad Wu

ANTENNA POLARITY & TEST DISTANCE: HORIZONTAL AT 3 M								
NO.	FREQ. (MHz)	EMISSION LEVEL (dBuV/m)	LIMIT (dBuV/m)	MARGIN (dB)	ANTENNA HEIGHT (m)	TABLE ANGLE (Degree)	RAW VALUE (dBuV)	CORRECTION FACTOR (dB/m)
1	*2437.00	111.2 PK			1.06 H	137	80.60	30.60
2	*2437.00	93.5 AV			1.06 H	137	62.90	30.60
3	4874.00	46.6 PK	74.0	-27.4	1.05 H	311	10.40	36.20
4	4874.00	33.9 AV	54.0	-20.1	1.05 H	311	-2.30	36.20
ANTENNA POLARITY & TEST DISTANCE: VERTICAL AT 3 M								
NO.	FREQ. (MHz)	EMISSION LEVEL (dBuV/m)	LIMIT (dBuV/m)	MARGIN (dB)	ANTENNA HEIGHT (m)	TABLE ANGLE (Degree)	RAW VALUE (dBuV)	CORRECTION FACTOR (dB/m)
1	*2437.00	106.9 PK			1.31 V	191	76.30	30.60
2	*2437.00	89.1 AV			1.31 V	191	58.50	30.60
3	4874.00	46.6 PK	74.0	-27.4	1.06 V	180	10.40	36.20
4	4874.00	33.9 AV	54.0	-20.1	1.06 V	180	-2.30	36.20

- REMARKS:**
1. Emission level (dBuV/m) = Raw Value (dBuV) + Correction Factor (dB/m).
 2. Correction Factor (dB/m) = Antenna Factor (dB/m) + Cable Factor (dB).
 3. The other emission levels were very low against the limit.
 4. Margin value = Emission level – Limit value.
 5. “ * “: Fundamental frequency.



A D T

EUT TEST CONDITION		MEASUREMENT DETAIL	
CHANNEL	Channel 11	FREQUENCY RANGE	1 ~ 25GHz
INPUT POWER (SYSTEM)	120Vac, 60 Hz	DETECTOR FUNCTION	Peak (PK) Average (AV)
ENVIRONMENTAL CONDITIONS	23deg. C, 65%RH 1011 hPa	TESTED BY	Brad Wu

ANTENNA POLARITY & TEST DISTANCE: HORIZONTAL AT 3 M								
NO.	FREQ. (MHz)	EMISSION LEVEL (dBuV/m)	LIMIT (dBuV/m)	MARGIN (dB)	ANTENNA HEIGHT (m)	TABLE ANGLE (Degree)	RAW VALUE (dBuV)	CORRECTION FACTOR (dB/m)
1	*2462.00	110.8 PK			1.02 H	135	80.10	30.70
2	*2462.00	92.2 AV			1.02 H	135	61.50	30.70
3	2483.50	67.8 PK	74.0	-6.2	1.02 H	135	37.00	30.80
4	2483.50	52.4 AV	54.0	-1.6	1.02 H	135	21.60	30.80
5	4924.00	47.1 PK	74.0	-26.9	1.05 H	300	10.80	36.30
6	4924.00	34.5 AV	54.0	-19.5	1.05 H	300	-1.80	36.30
ANTENNA POLARITY & TEST DISTANCE: VERTICAL AT 3 M								
NO.	FREQ. (MHz)	EMISSION LEVEL (dBuV/m)	LIMIT (dBuV/m)	MARGIN (dB)	ANTENNA HEIGHT (m)	TABLE ANGLE (Degree)	RAW VALUE (dBuV)	CORRECTION FACTOR (dB/m)
1	*2462.00	105.9 PK			1.31 V	211	75.20	30.70
2	*2462.00	88.4 AV			1.31 V	211	57.70	30.70
3	2483.50	67.2 PK	74.0	-6.8	1.31 V	211	36.40	30.80
4	2483.50	51.6 AV	54.0	-2.4	1.31 V	211	20.80	30.80
5	4924.00	46.2 PK	74.0	-27.8	1.00 V	360	9.90	36.30
6	4924.00	33.6 AV	54.0	-20.4	1.00 V	360	-2.70	36.30

- REMARKS:**
1. Emission level (dBuV/m) = Raw Value (dBuV) + Correction Factor (dB/m).
 2. Correction Factor (dB/m) = Antenna Factor (dB/m) + Cable Factor (dB).
 3. The other emission levels were very low against the limit.
 4. Margin value = Emission level – Limit value.
 5. “ * “: Fundamental frequency.



A D T

802.11n (40MHz)

EUT TEST CONDITION		MEASUREMENT DETAIL	
CHANNEL	Channel 1	FREQUENCY RANGE	1 ~ 25GHz
INPUT POWER (SYSTEM)	120Vac, 60 Hz	DETECTOR FUNCTION	Peak (PK) Average (AV)
ENVIRONMENTAL CONDITIONS	23deg. C, 65%RH 1011 hPa	TESTED BY	Brad Wu

ANTENNA POLARITY & TEST DISTANCE: HORIZONTAL AT 3 M								
NO.	FREQ. (MHz)	EMISSION LEVEL (dBuV/m)	LIMIT (dBuV/m)	MARGIN (dB)	ANTENNA HEIGHT (m)	TABLE ANGLE (Degree)	RAW VALUE (dBuV)	CORRECTION FACTOR (dB/m)
1	2390.00	66.4 PK	74.0	-7.6	1.34 H	133	35.90	30.50
2	2390.00	50.5 AV	54.0	-3.5	1.34 H	133	20.00	30.50
3	*2422.00	105.1 PK			1.34 H	133	74.50	30.60
4	*2422.00	84.5 AV			1.34 H	133	53.90	30.60
5	4844.00	45.9 PK	74.0	-28.1	1.02 H	245	9.70	36.20
6	4844.00	33.3 AV	54.0	-20.7	1.02 H	245	-2.90	36.20
ANTENNA POLARITY & TEST DISTANCE: VERTICAL AT 3 M								
NO.	FREQ. (MHz)	EMISSION LEVEL (dBuV/m)	LIMIT (dBuV/m)	MARGIN (dB)	ANTENNA HEIGHT (m)	TABLE ANGLE (Degree)	RAW VALUE (dBuV)	CORRECTION FACTOR (dB/m)
1	2390.00	61.6 PK	74.0	-12.4	1.35 V	188	31.10	30.50
2	2390.00	45.6 AV	54.0	-8.4	1.35 V	188	15.10	30.50
3	*2422.00	100.7 PK			1.35 V	188	70.10	30.60
4	*2422.00	80.4 AV			1.35 V	188	49.80	30.60
5	4844.00	45.5 PK	74.0	-28.5	1.05 V	231	9.30	36.20
6	4844.00	32.9 AV	54.0	-21.1	1.05 V	231	-3.30	36.20

- REMARKS:**
1. Emission level (dBuV/m) = Raw Value (dBuV) + Correction Factor (dB/m).
 2. Correction Factor (dB/m) = Antenna Factor (dB/m) + Cable Factor (dB).
 3. The other emission levels were very low against the limit.
 4. Margin value = Emission level – Limit value.
 5. “ * “: Fundamental frequency.



A D T

EUT TEST CONDITION		MEASUREMENT DETAIL	
CHANNEL	Channel 4	FREQUENCY RANGE	1 ~ 25GHz
INPUT POWER (SYSTEM)	120Vac, 60 Hz	DETECTOR FUNCTION	Peak (PK) Average (AV)
ENVIRONMENTAL CONDITIONS	23deg. C, 65%RH 1011 hPa	TESTED BY	Brad Wu

ANTENNA POLARITY & TEST DISTANCE: HORIZONTAL AT 3 M								
NO.	FREQ. (MHz)	EMISSION LEVEL (dBuV/m)	LIMIT (dBuV/m)	MARGIN (dB)	ANTENNA HEIGHT (m)	TABLE ANGLE (Degree)	RAW VALUE (dBuV)	CORRECTION FACTOR (dB/m)
1	*2437.00	105.4 PK			1.34 H	136	74.80	30.60
2	*2437.00	84.8 AV			1.34 H	136	54.20	30.60
3	4874.00	46.2 PK	74.0	-27.8	1.05 H	225	10.00	36.20
4	4874.00	33.5 AV	54.0	-20.5	1.05 H	225	-2.70	36.20
ANTENNA POLARITY & TEST DISTANCE: VERTICAL AT 3 M								
NO.	FREQ. (MHz)	EMISSION LEVEL (dBuV/m)	LIMIT (dBuV/m)	MARGIN (dB)	ANTENNA HEIGHT (m)	TABLE ANGLE (Degree)	RAW VALUE (dBuV)	CORRECTION FACTOR (dB/m)
1	*2437.00	101.0 PK			1.36 V	189	70.40	30.60
2	*2437.00	80.7 AV			1.36 V	189	50.10	30.60
3	4874.00	45.8 PK	74.0	-28.2	1.08 V	188	9.60	36.20
4	4874.00	33.2 AV	54.0	-20.8	1.08 V	188	-3.00	36.20

- REMARKS:**
1. Emission level (dBuV/m) = Raw Value (dBuV) + Correction Factor (dB/m).
 2. Correction Factor (dB/m) = Antenna Factor (dB/m) + Cable Factor (dB).
 3. The other emission levels were very low against the limit.
 4. Margin value = Emission level – Limit value.
 5. “ * “: Fundamental frequency.



A D T

EUT TEST CONDITION		MEASUREMENT DETAIL	
CHANNEL	Channel 7	FREQUENCY RANGE	1 ~ 25GHz
INPUT POWER (SYSTEM)	120Vac, 60 Hz	DETECTOR FUNCTION	Peak (PK) Average (AV)
ENVIRONMENTAL CONDITIONS	23deg. C, 65%RH 1011 hPa	TESTED BY	Brad Wu

ANTENNA POLARITY & TEST DISTANCE: HORIZONTAL AT 3 M								
NO.	FREQ. (MHz)	EMISSION LEVEL (dBuV/m)	LIMIT (dBuV/m)	MARGIN (dB)	ANTENNA HEIGHT (m)	TABLE ANGLE (Degree)	RAW VALUE (dBuV)	CORRECTION FACTOR (dB/m)
1	*2452.00	105.6 PK			1.35 H	134	74.90	30.70
2	*2452.00	85.0 AV			1.35 H	134	54.30	30.70
3	2483.50	68.9 PK	74.0	-5.1	1.35 H	134	38.10	30.80
4	2483.50	51.4 AV	54.0	-2.6	1.35 H	134	20.60	30.80
5	4904.00	46.5 PK	74.0	-27.5	1.01 H	225	10.30	36.20
6	4904.00	33.9 AV	54.0	-20.1	1.01 H	225	-2.30	36.20
ANTENNA POLARITY & TEST DISTANCE: VERTICAL AT 3 M								
NO.	FREQ. (MHz)	EMISSION LEVEL (dBuV/m)	LIMIT (dBuV/m)	MARGIN (dB)	ANTENNA HEIGHT (m)	TABLE ANGLE (Degree)	RAW VALUE (dBuV)	CORRECTION FACTOR (dB/m)
1	*2452.00	101.3 PK			1.35 V	188	70.60	30.70
2	*2452.00	81.0 AV			1.35 V	188	50.30	30.70
3	2483.50	63.6 PK	74.0	-10.4	1.35 V	188	32.80	30.80
4	2483.50	46.1 AV	54.0	-7.9	1.35 V	188	15.30	30.80
5	4904.00	46.1 PK	74.0	-27.9	1.01 V	226	9.90	36.20
6	4904.00	33.5 AV	54.0	-20.5	1.01 V	226	-2.70	36.20

- REMARKS:**
1. Emission level (dBuV/m) = Raw Value (dBuV) + Correction Factor (dB/m).
 2. Correction Factor (dB/m) = Antenna Factor (dB/m) + Cable Factor (dB).
 3. The other emission levels were very low against the limit.
 4. Margin value = Emission level – Limit value.
 5. “ * “: Fundamental frequency.



A D T

BELOW 1GHz WORST-CASE DATA : 802.11n (20MHz)

EUT TEST CONDITION		MEASUREMENT DETAIL	
CHANNEL	Channel 11	FREQUENCY RANGE	Below 1000MHz
INPUT POWER (SYSTEM)	120Vac, 60 Hz	DETECTOR FUNCTION	Quasi-Peak
ENVIRONMENTAL CONDITIONS	24deg. C, 66%RH 1008 hPa	TESTED BY	Brad Wu

ANTENNA POLARITY & TEST DISTANCE: HORIZONTAL AT 3 M								
NO.	FREQ. (MHz)	EMISSION LEVEL (dBuV/m)	LIMIT (dBuV/m)	MARGIN (dB)	ANTENNA HEIGHT (m)	TABLE ANGLE (Degree)	RAW VALUE (dBuV)	CORRECTION FACTOR (dB/m)
1	284.60	38.2 QP	46.0	-7.8	1.00 H	319	24.40	13.80
2	595.69	37.7 QP	46.0	-8.3	1.50 H	262	15.30	22.40
3	675.40	44.5 QP	46.0	-1.5	1.00 H	100	20.00	24.50
4	764.84	44.7 QP	46.0	-1.3	1.50 H	7	19.00	25.70
5	795.95	40.9 QP	46.0	-5.1	1.50 H	7	14.90	26.00
6	961.21	41.7 QP	54.0	-12.3	2.00 H	292	13.00	28.70

ANTENNA POLARITY & TEST DISTANCE: VERTICAL AT 3 M								
NO.	FREQ. (MHz)	EMISSION LEVEL (dBuV/m)	LIMIT (dBuV/m)	MARGIN (dB)	ANTENNA HEIGHT (m)	TABLE ANGLE (Degree)	RAW VALUE (dBuV)	CORRECTION FACTOR (dB/m)
1	113.50	34.2 QP	43.5	-9.3	1.50 V	10	22.70	11.50
2	249.60	34.8 QP	46.0	-11.2	1.00 V	301	20.90	13.90
3	366.26	34.8 QP	46.0	-11.2	1.50 V	340	18.10	16.70
4	675.40	38.3 QP	46.0	-7.7	2.00 V	82	13.80	24.50
5	795.95	38.2 QP	46.0	-7.8	1.00 V	10	12.20	26.00
6	961.21	39.2 QP	54.0	-14.8	2.00 V	130	10.50	28.70

- REMARKS:**
1. Emission level (dBuV/m) = Raw Value (dBuV) + Correction Factor (dB/m).
 2. Correction Factor (dB/m) = Antenna Factor (dB/m) + Cable Factor (dB).
 3. The other emission levels were very low against the limit.
 4. Margin value = Emission level – Limit value.



4.2 CONDUCTED EMISSION MEASUREMENT

4.2.1 LIMITS OF CONDUCTED EMISSION MEASUREMENT

FREQUENCY OF EMISSION (MHz)	CONDUCTED LIMIT (dBµV)	
	Quasi-peak	Average
0.15 ~ 0.5	66 to 56	56 to 46
0.5 ~ 5	56	46
5 ~ 30	60	50

- NOTE:** 1. The lower limit shall apply at the transition frequencies.
 2. The limit decreases in line with the logarithm of the frequency in the range of 0.15 to 0.50MHz.
 3. All emanations from a class A/B digital device or system, including any network of conductors and apparatus connected thereto, shall not exceed the level of field strengths specified above.

4.2.2 TEST INSTRUMENTS

DESCRIPTION & MANUFACTURER	MODEL NO.	SERIAL NO.	DATE OF CALIBRATION	DUE DATE OF CALIBRATION
Test Receiver ROHDE & SCHWARZ	ESCS30	100288	Sep. 24, 2009	Sep. 23, 2010
RF signal cable Woken	5D-FB	Cable-HYCO2-01	Dec. 31, 2009	Dec. 30, 2010
LISN ROHDE & SCHWARZ	ESH2-Z5	100100	Aug. 24, 2009	Aug. 23, 2010
LISN ROHDE & SCHWARZ	ESH3-Z5	100311	Jul. 29, 2009	Jul. 28, 2010
Software ADT	ADT_Cond_ V7.3.7	NA	NA	NA

- NOTE:** 1. The calibration interval of the above test instruments is 12 months and the calibrations are traceable to NML/ROC and NIST/USA.
 2. The test was performed in HwaYa Shielded Room 2.
 3. The VCCI Site Registration No. is C-2047.



A D T

4.2.3 TEST PROCEDURES

- a. The EUT was placed 0.4 meters from the conducting wall of the shielded room with EUT being connected to the power mains through a line impedance stabilization network (LISN). Other support units were connected to the power mains through another LISN. The two LISNs provide 50 ohm/ 50uH of coupling impedance for the measuring instrument.
- b. Both lines of the power mains connected to the EUT were checked for maximum conducted interference.
- c. The frequency range from 150kHz to 30MHz was searched. Emission levels under (Limit - 20dB) was not recorded.

NOTE: All modes of operation were investigated and the worst-case emissions are reported.

4.2.4 DEVIATION FROM TEST STANDARD

No deviation.

4.2.5 TEST SETUP

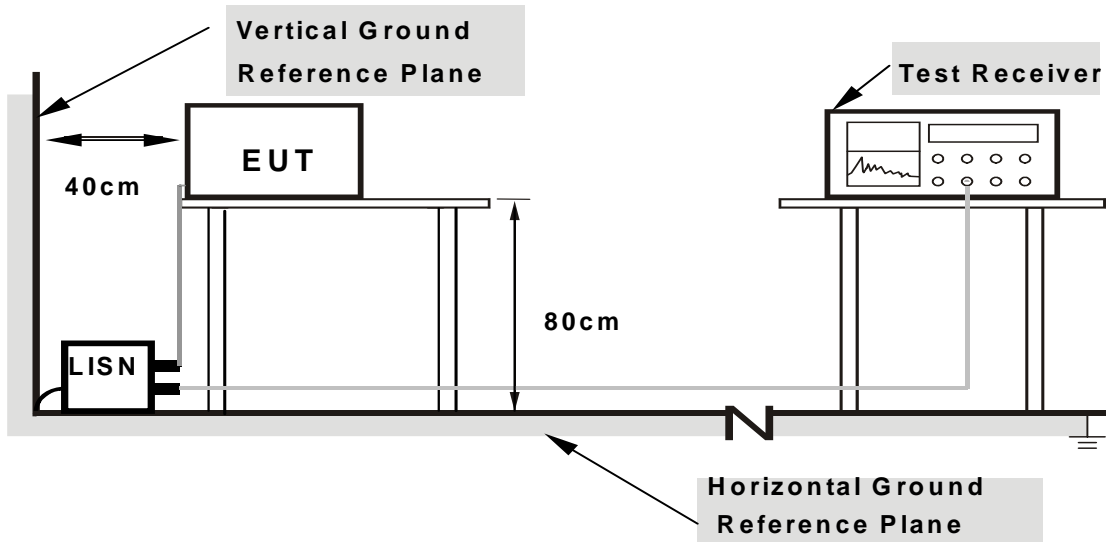

Note: 1.Support units were connected to second LISN.

2.Both of LISNs (AMN) are 80 cm from EUT and at least 80 from other units and other metal planes

For the actual test configuration, please refer to the attached file (Test Setup Photo).

4.2.6 EUT OPERATING CONDITIONS

Same as 4.1.6.

4.2.7 TEST RESULTS

CONDUCTED WORST-CASE DATA : 802.11n (20MHz)

PHASE	Line 1	6dB BANDWIDTH	9kHz
-------	--------	---------------	------

No	Freq. [MHz]	Corr. Factor (dB)	Reading Value		Emission Level		Limit		Margin	
			[dB (uV)]		[dB (uV)]		[dB (uV)]		(dB)	
			Q.P.	AV.	Q.P.	AV.	Q.P.	AV.	Q.P.	AV.
1	0.151	0.16	52.53	-	52.69	-	65.92	55.92	-13.24	-
2	0.304	0.17	34.48	-	34.65	-	60.14	50.14	-25.49	-
3	0.580	0.19	27.63	-	27.82	-	56.00	46.00	-28.18	-
4	0.863	0.22	21.61	-	21.83	-	56.00	46.00	-34.17	-
5	13.625	0.46	22.83	-	23.29	-	60.00	50.00	-36.71	-
6	17.043	0.58	30.22	-	30.80	-	60.00	50.00	-29.20	-

- REMARKS:**
1. Q.P. and AV. are abbreviations of quasi-peak and average individually.
 2. "-": The Quasi-peak reading value also meets average limit and measurement with the average detector is unnecessary.
 3. The emission levels of other frequencies were very low against the limit.
 4. Margin value = Emission level - Limit value
 5. Correction factor = Insertion loss + Cable loss
 6. Emission Level = Correction Factor + Reading Value.

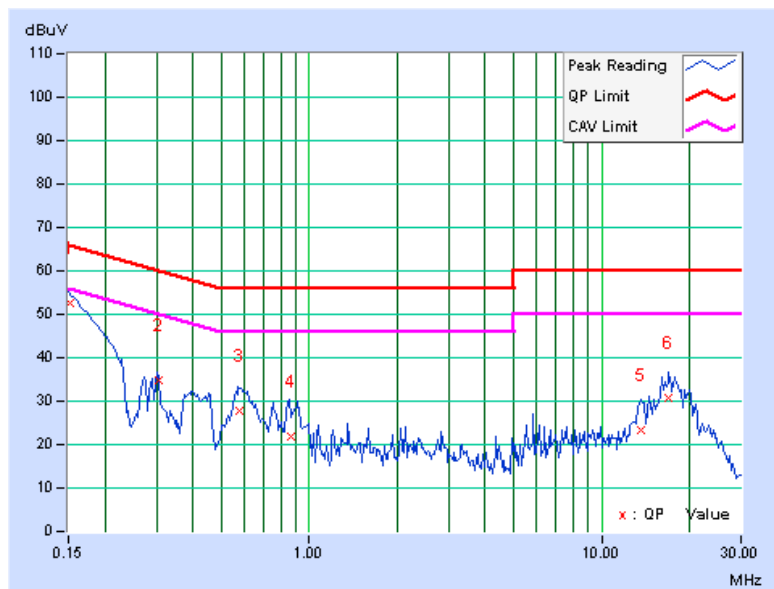

PHASE	Line 2	6dB BANDWIDTH	9kHz
-------	--------	---------------	------

No	Freq. [MHz]	Corr.	Reading Value		Emission Level		Limit		Margin	
		Factor	[dB (uV)]		[dB (uV)]		[dB (uV)]		(dB)	
		(dB)	Q.P.	AV.	Q.P.	AV.	Q.P.	AV.	Q.P.	AV.
1	0.153	0.13	50.50	-	50.63	-	65.86	55.86	-15.23	-
2	0.302	0.15	36.63	-	36.78	-	60.18	50.18	-23.40	-
3	0.463	0.17	33.33	-	33.50	-	56.65	46.65	-23.15	-
4	0.577	0.18	33.16	-	33.34	-	56.00	46.00	-22.66	-
5	0.865	0.21	28.68	-	28.89	-	56.00	46.00	-27.11	-
6	16.953	0.76	30.02	-	30.78	-	60.00	50.00	-29.22	-

- REMARKS:**
1. Q.P. and AV. are abbreviations of quasi-peak and average individually.
 2. "-": The Quasi-peak reading value also meets average limit and measurement with the average detector is unnecessary.
 3. The emission levels of other frequencies were very low against the limit.
 4. Margin value = Emission level - Limit value
 5. Correction factor = Insertion loss + Cable loss
 6. Emission Level = Correction Factor + Reading Value.

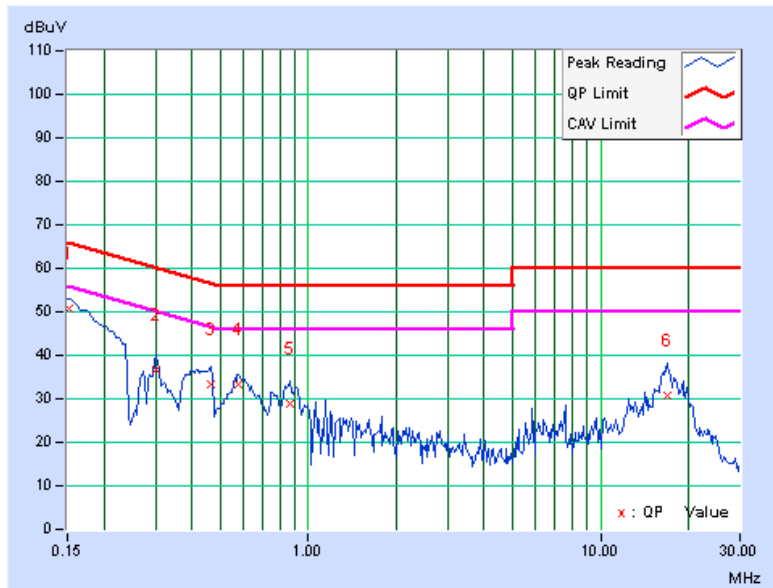



A D T

4.3 6dB BANDWIDTH MEASUREMENT

4.3.1 LIMITS OF 6dB BANDWIDTH MEASUREMENT

The minimum of 6dB Bandwidth Measurement is 0.5 MHz.

4.3.2 TEST INSTRUMENTS

DESCRIPTION & MANUFACTURER	MODEL NO.	SERIAL NO.	DATE OF CALIBRATION	CALIBRATED UNTIL
R&S SPECTRUM ANALYZER	FSP40	100040	Jul. 07, 2009	Jul. 06, 2010

NOTE: The calibration interval of the above test instruments is 12 months and the calibrations are traceable to NML/ROC and NIST/USA.

4.3.3 TEST PROCEDURE

The transmitter output was connected to the spectrum analyzer through an attenuator. The bandwidth of the fundamental frequency was measured by spectrum analyzer with 100kHz RBW and 300kHz VBW. The 6dB bandwidth is defined as the total spectrum the power of which is higher than peak power minus 6dB.

4.3.4 DEVIATION FROM TEST STANDARD

No deviation.

4.3.5 TEST SETUP

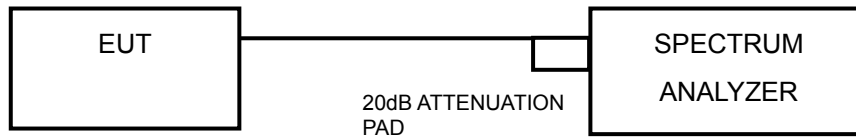

4.3.6 EUT OPERATING CONDITIONS

The software provided by client to enable the EUT under transmission condition continuously at lowest, middle and highest channel frequencies individually.



A D T

4.3.7 TEST RESULTS

802.11b

CHANNEL	CHANNEL FREQUENCY (MHz)	6dB BANDWIDTH (MHz) CHAIN 0	MINIMUM LIMIT (MHz)	PASS / FAIL
1	2412	10.21	0.5	PASS
6	2437	10.19	0.5	PASS
11	2462	10.21	0.5	PASS

CH 11

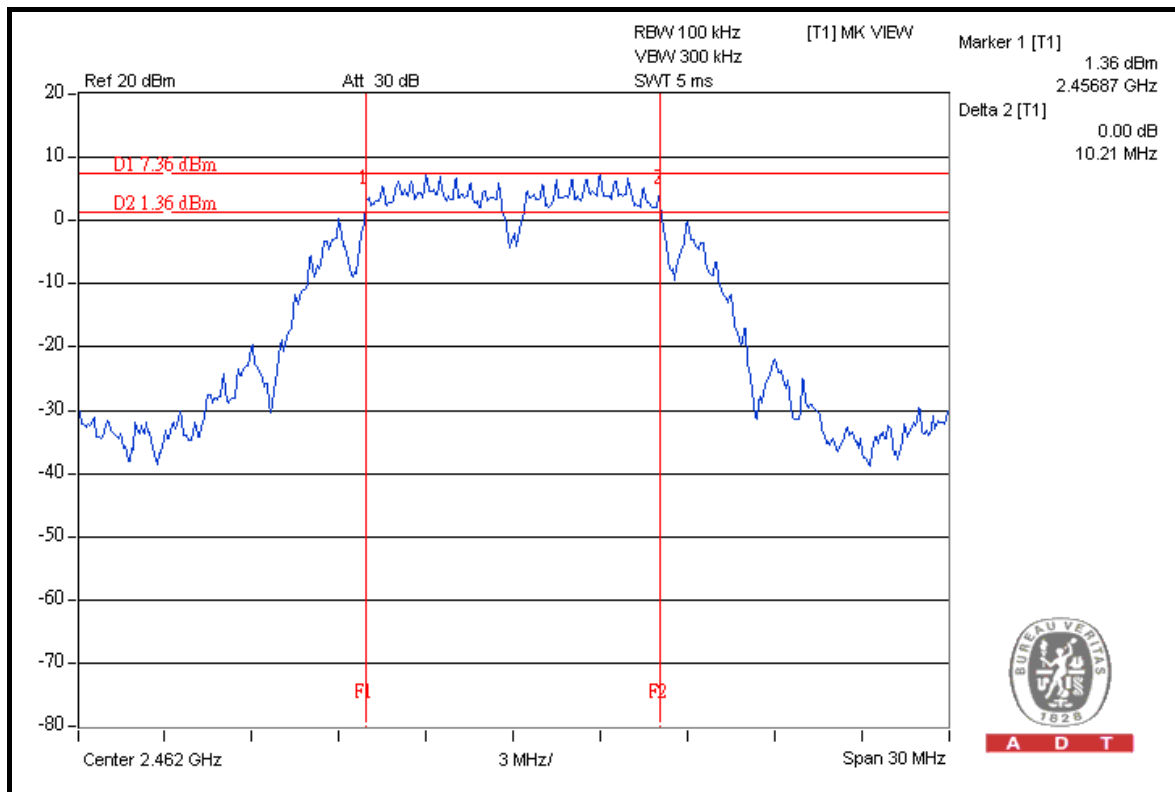

A D T



A D T

802.11g

CHANNEL	CHANNEL FREQUENCY (MHz)	6dB BANDWIDTH (MHz) CHAIN 0	MINIMUM LIMIT (MHz)	PASS / FAIL
1	2412	16.46	0.5	PASS
6	2437	16.41	0.5	PASS
11	2462	16.45	0.5	PASS

CH 1

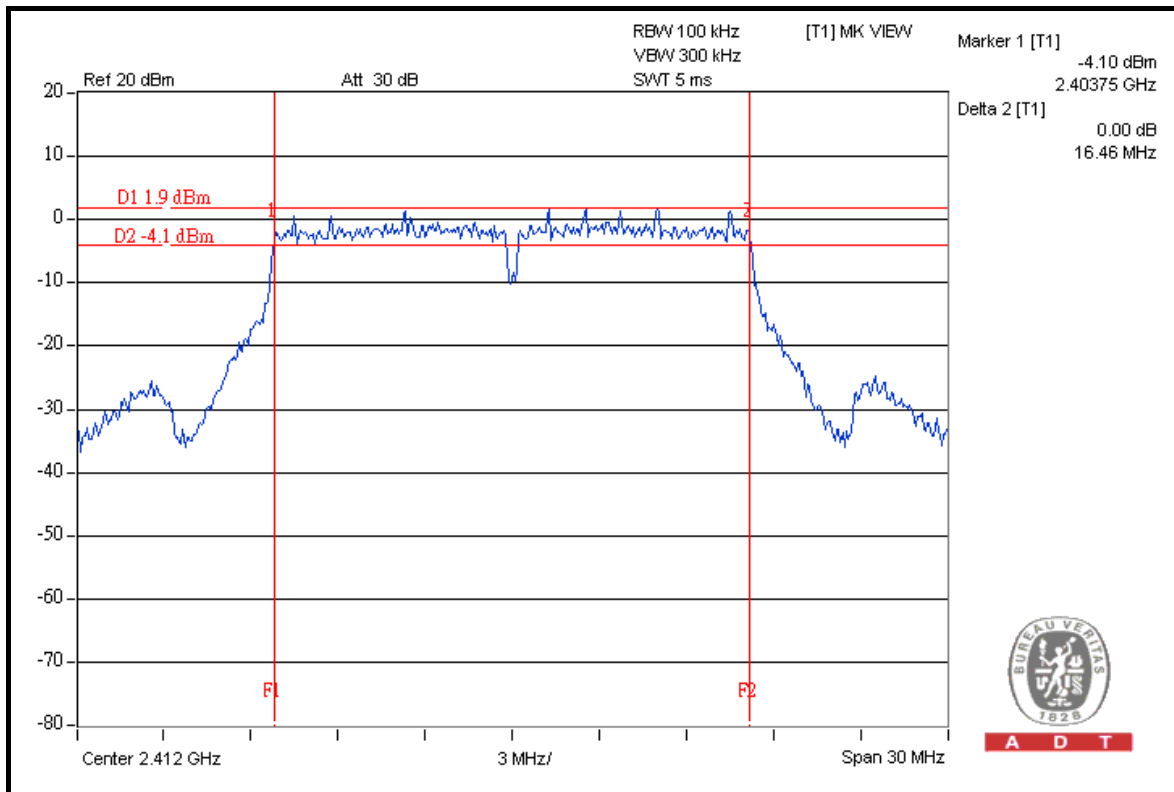



A D T

802.11n (20MHz)

CHANNEL	CHANNEL FREQUENCY (MHz)	6dB BANDWIDTH (MHz)		MINIMUM LIMIT (MHz)	PASS / FAIL
		CHAIN 0	CHAIN 1		
1	2412	17.64	17.68	0.5	PASS
6	2437	17.66	17.67	0.5	PASS
11	2462	17.67	17.67	0.5	PASS

FOR CHAIN 1: CH 1

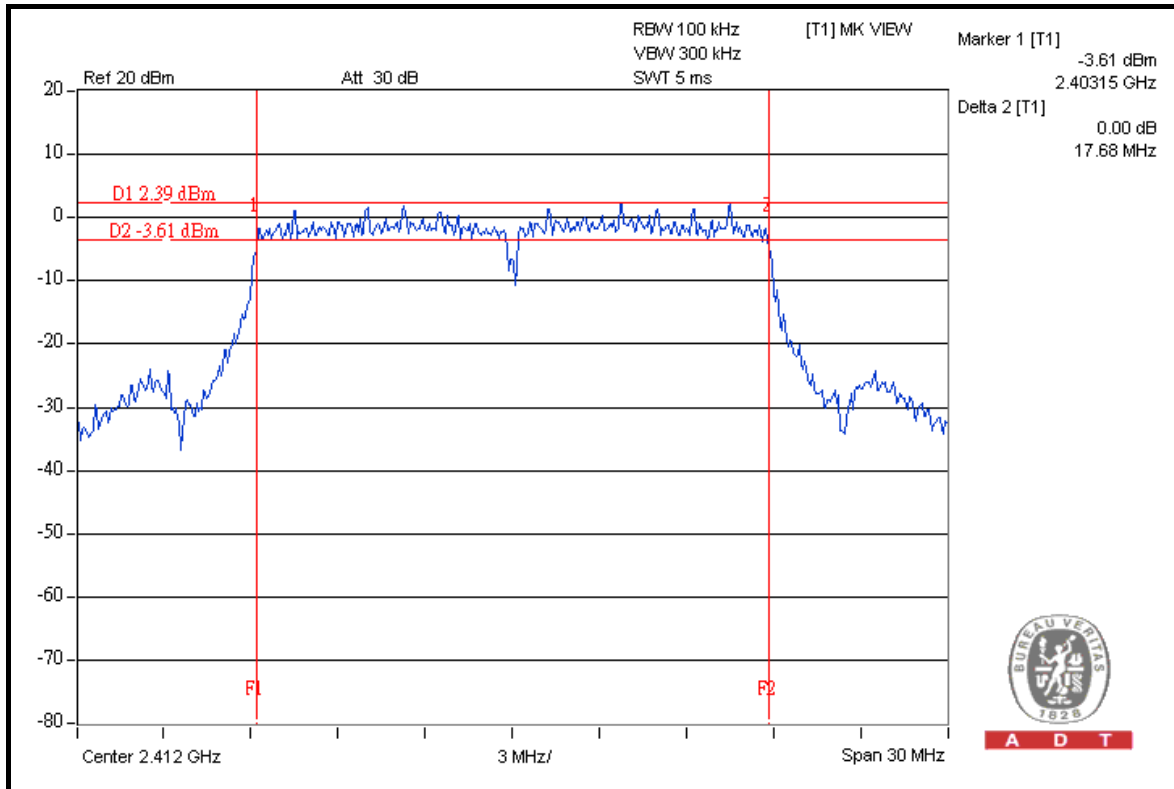



A D T

802.11n (40MHz)

CHANNEL	CHANNEL FREQUENCY (MHz)	6dB BANDWIDTH (MHz)		MINIMUM LIMIT (MHz)	PASS / FAIL
		CHAIN 0	CHAIN 1		
1	2422	36.44	36.35	0.5	PASS
4	2437	36.47	36.43	0.5	PASS
7	2452	36.48	36.49	0.5	PASS

FOR CHAIN 1: CH 7

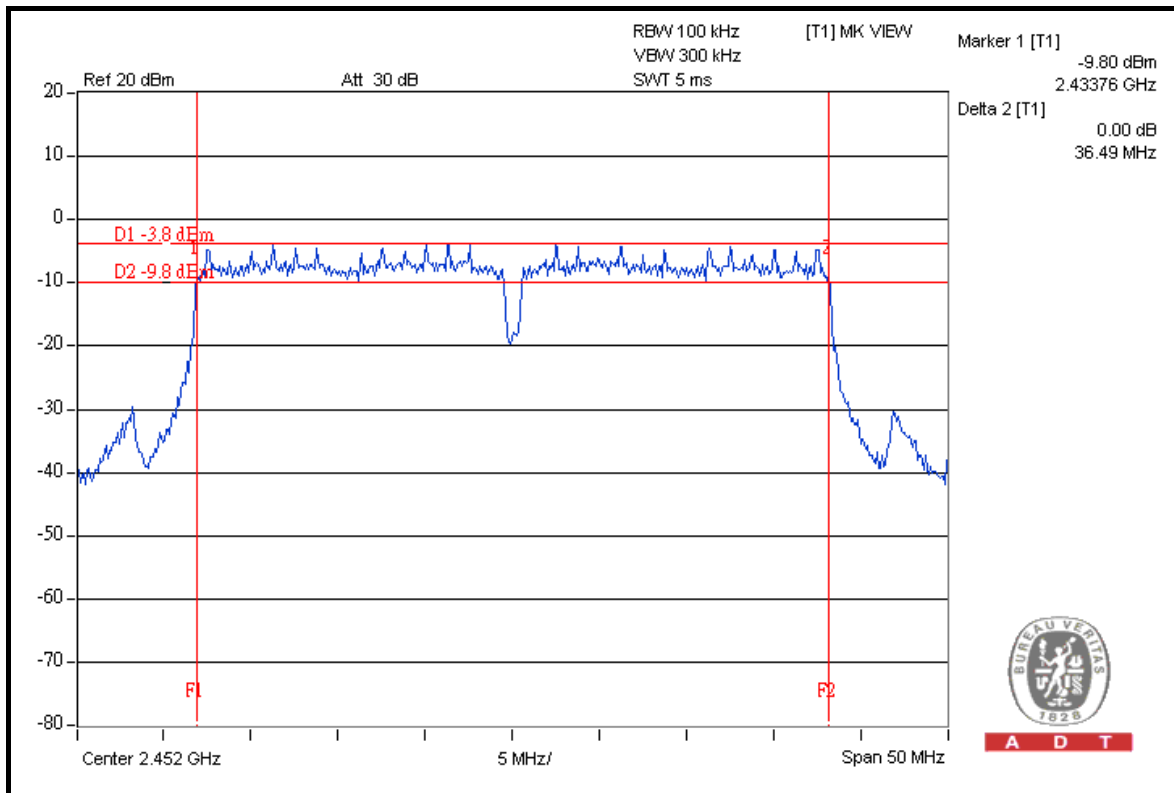



A D T

4.4 MAXIMUM OUTPUT POWER

4.4.1 LIMITS OF MAXIMUM OUTPUT POWER MEASUREMENT

The Maximum Output Power Measurement is 30dBm.

4.4.2 INSTRUMENTS

DESCRIPTION & MANUFACTURER	MODEL NO.	SERIAL NO.	DATE OF CALIBRATION	DUE DATE OF CALIBRATION
High Speed Peak Power Meter	ML2495A	0824012	Aug. 10, 2009	Aug. 09, 2010
Power Sensor	MA2411B	0738138	Aug. 10, 2009	Aug. 09, 2010

NOTE:

1. The calibration interval of the above test instruments is 12 months and the calibrations are traceable to NML/ROC and NIST/USA.
2. Measurement Bandwidth of ML2495A is 65MHz greater than 6dB bandwidth of emission.

4.4.3 TEST PROCEDURE

A power sensor was used on the output port of the EUT. A power meter was used to read the response of the power sensor. Record the power level.

4.4.4 DEVIATION FROM TEST STANDARD

No deviation.

4.4.5 TEST SETUP

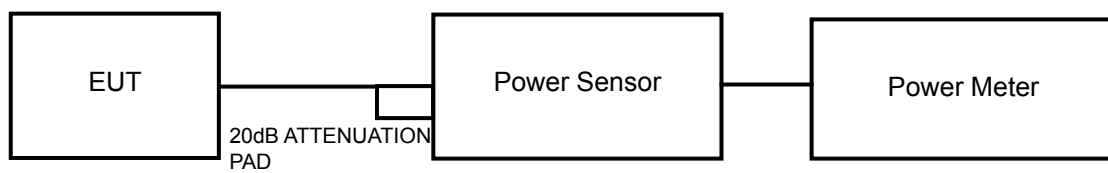

4.4.6 EUT OPERATING CONDITIONS

Same as Item 4.3.6.



4.4.7 TEST RESULTS

802.11b

CHAN.	CHANNEL FREQUENCY (MHz)	POWER OUTPUT (mW)	POWER OUTPUT (dBm)	POWER LIMIT (dBm)	PASS/FAIL
1	2412	169.8	22.3	30	PASS
6	2437	166.0	22.2	30	PASS
11	2462	173.8	22.4	30	PASS

802.11g

CHAN.	CHANNEL FREQUENCY (MHz)	POWER OUTPUT (mW)	POWER OUTPUT (dBm)	POWER LIMIT (dBm)	PASS/FAIL
1	2412	234.4	23.7	30	PASS
6	2437	234.4	23.7	30	PASS
11	2462	229.1	23.6	30	PASS

802.11n (20MHz)

CHAN.	CHAN. FREQ. (MHz)	POWER OUTPUT (dBm)		TOTAL POWER (mW)	TOTAL POWER (dBm)	POWER LIMIT (dBm)	PASS / FAIL
		CHAIN 0	CHAIN 1				
1	2412	23.6	23.7	461.9	26.6	30	PASS
6	2437	23.7	23.8	474.3	26.8	30	PASS
11	2462	23.6	23.8	469.0	26.7	30	PASS

802.11n (40MHz)

CHAN.	CHAN. FREQ. (MHz)	POWER OUTPUT (dBm)		TOTAL POWER (mW)	TOTAL POWER (dBm)	POWER LIMIT (dBm)	PASS / FAIL
		CHAIN 0	CHAIN 1				
1	2422	21.1	21.9	283.7	24.5	30	PASS
4	2437	21.1	21.8	280.2	24.5	30	PASS
7	2452	21.4	21.9	292.9	24.7	30	PASS



4.5 POWER SPECTRAL DENSITY MEASUREMENT

4.5.1 LIMITS OF POWER SPECTRAL DENSITY MEASUREMENT

The Maximum of Power Spectral Density Measurement is 8dBm.

4.5.2 TEST INSTRUMENTS

DESCRIPTION & MANUFACTURER	MODEL NO.	SERIAL NO.	DATE OF CALIBRATION	CALIBRATED UNTIL
R&S SPECTRUM ANALYZER	FSP40	100040	Jul. 07, 2009	Jul. 06, 2010

NOTE: The calibration interval of the above test instruments is 12 months and the calibrations are traceable to NML/ROC and NIST/USA.

4.5.3 TEST PROCEDURE

1. Follow DTS measurement (PSD Option 2), the transmitter output was connected to the spectrum analyzer through an attenuator, the bandwidth of the fundamental frequency was measured with the spectrum analyzer. Locate and zoom in on emission peak(s) within the pass band.
2. Set RBW = 3 kHz /VBW > 9 kHz and sweep time to Automatic.
3. Detector use peak mode and a video trigger with the trigger level set to enable triggering only on full power pulses.
4. Trace average 100 traces in power averaging mode. The power spectral density was measured and recorded.



A D T

4.5.4 DEVIATION FROM TEST STANDARD

No deviation

4.5.5 TEST SETUP

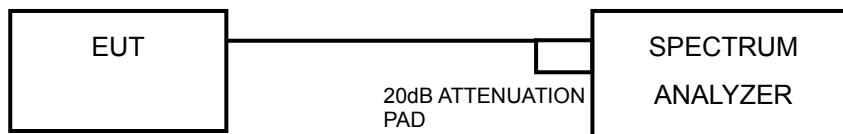

4.5.6 EUT OPERATING CONDITION

Same as Item 4.3.6



A D T

4.5.7 TEST RESULTS

802.11b

CHANNEL	CHANNEL FREQUENCY (MHz)	RF POWER LEVEL IN 3 kHz BW (dBm)	MAXIMUM LIMIT (dBm)	PASS/FAIL
1	2412	-6.0	8	PASS
6	2437	-6.0	8	PASS
11	2462	-5.7	8	PASS

CH 11

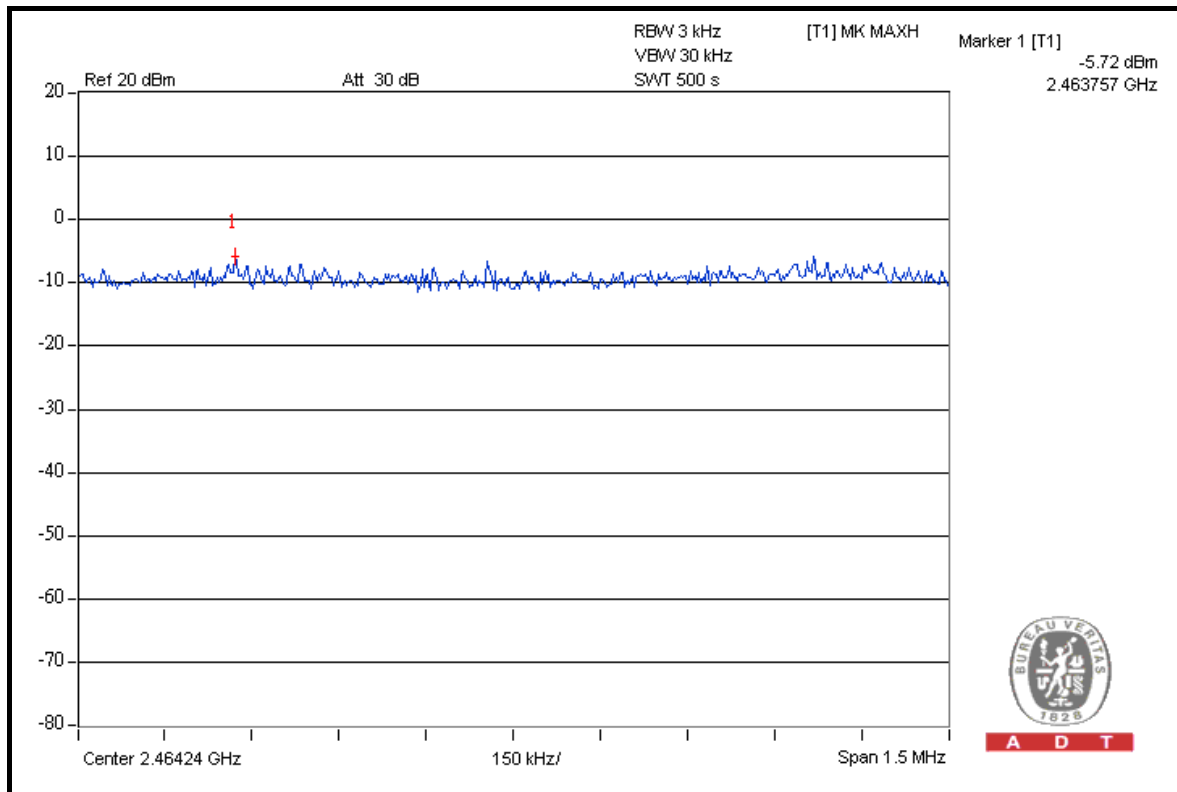



A D T

802.11g

CHANNEL	CHANNEL FREQUENCY (MHz)	RF POWER LEVEL IN 3 kHz BW (dBm)	MAXIMUM LIMIT (dBm)	PASS/FAIL
1	2412	-12.4	8	PASS
6	2437	-12.3	8	PASS
11	2462	-12.2	8	PASS

CH 11

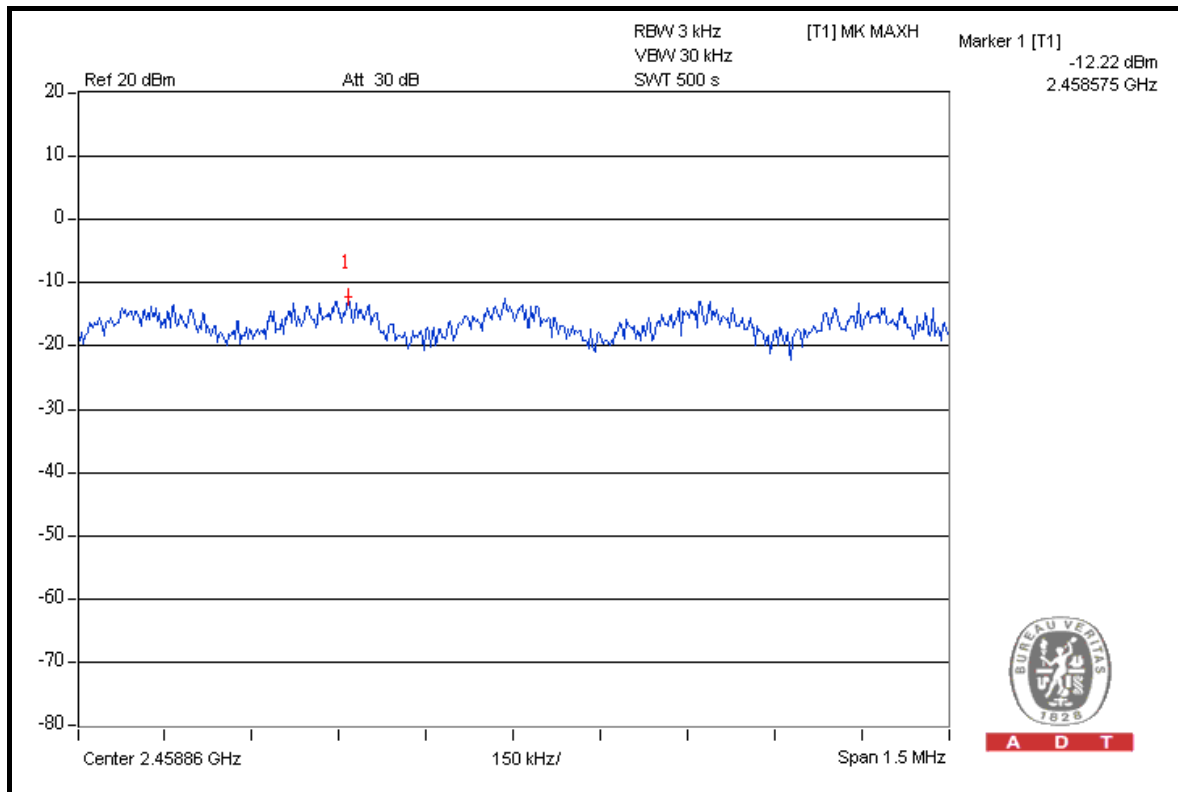



A D T

802.11n (20MHz)

CHAN.	CHAN. FREQ. (MHz)	RF POWER LEVEL IN 3kHz BW (dBm)		TOTAL POWER DENSITY (dBm)	MAX. LIMIT (dBm)	PASS / FAIL
		CHAIN 0	CHAIN 1			
1	2412	-12.3	-12.2	-9.2	8	PASS
6	2437	-12.1	-12.3	-9.1	8	PASS
11	2462	-12.2	-12.4	-9.3	8	PASS

FOR CHAIN 0: CH 6

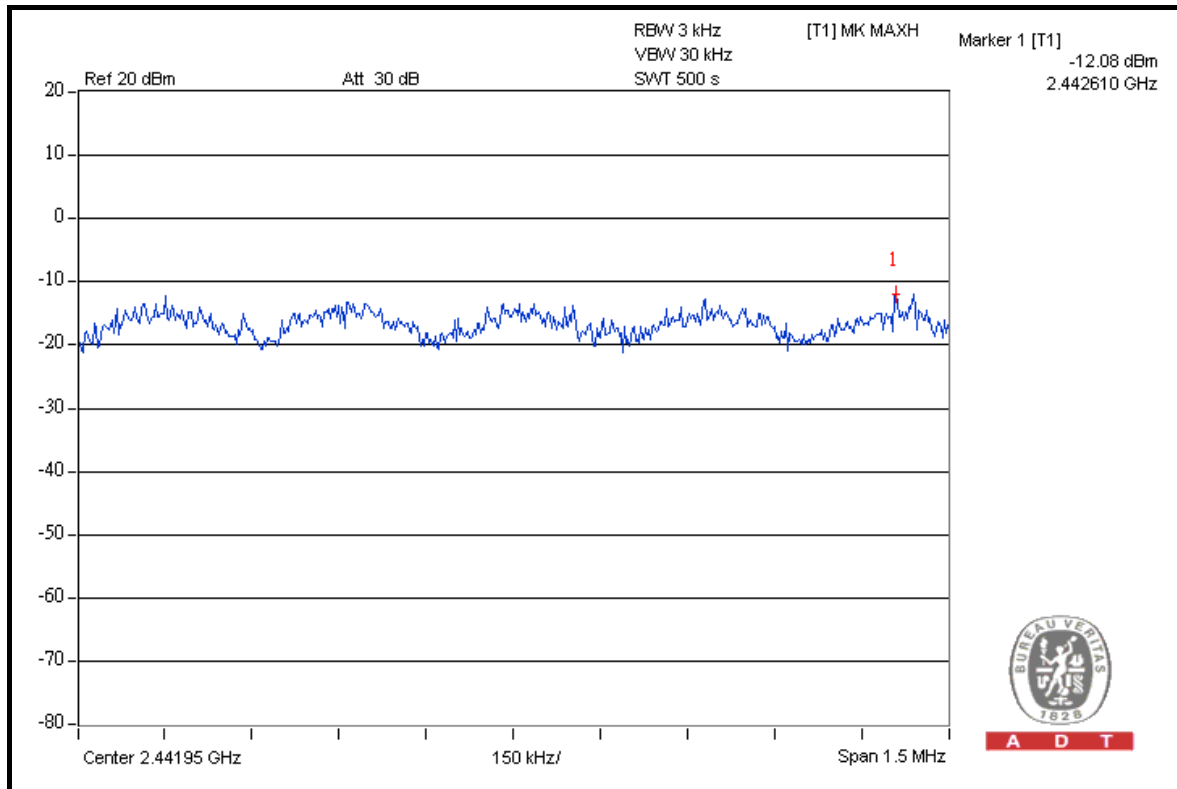

A D T



A D T

802.11n (40MHz)

CHAN.	CHAN. FREQ. (MHz)	RF POWER LEVEL IN 3kHz BW (dBm)		TOTAL POWER DENSITY (dBm)	MAX. LIMIT (dBm)	PASS / FAIL
		CHAIN 0	CHAIN 1			
1	2422	-16.9	-17.4	-14.2	8	PASS
4	2437	-17.1	-17.5	-14.3	8	PASS
7	2452	-16.6	-17.2	-13.9	8	PASS

FOR CHAIN 0: CH 7

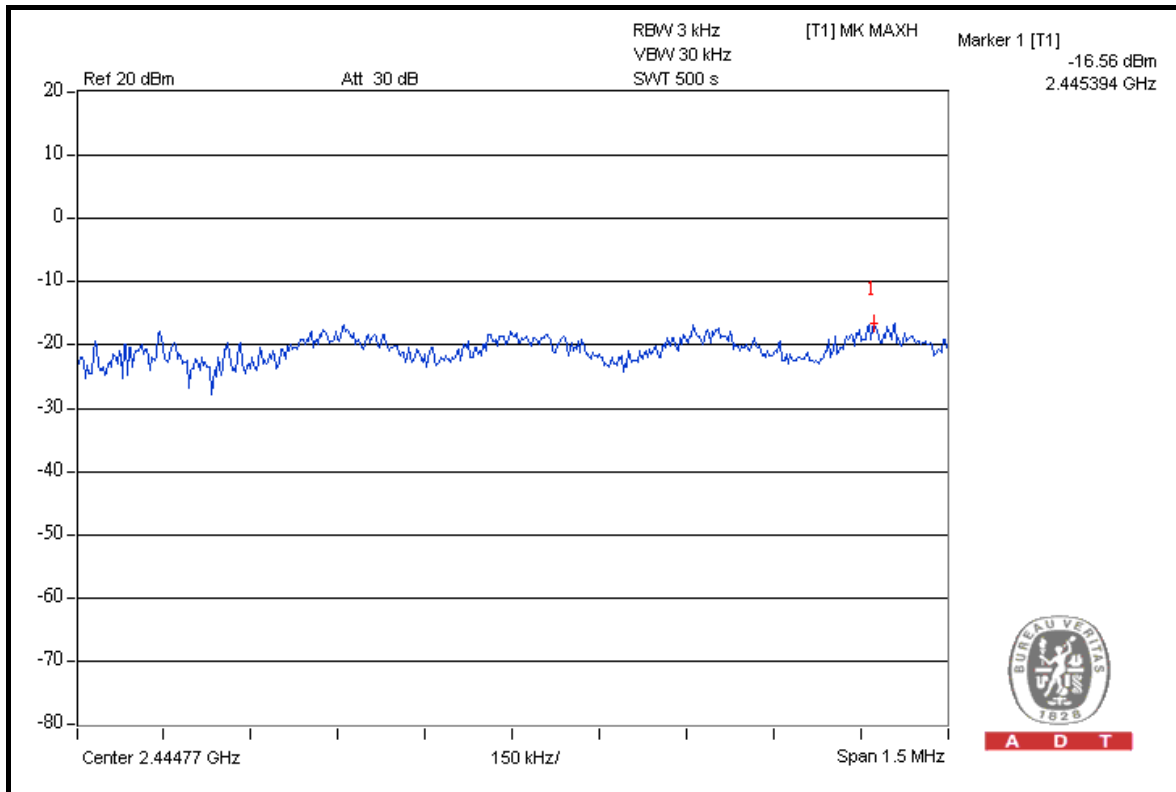

4.6 BAND EDGES MEASUREMENT

4.6.1 LIMITS OF BAND EDGES MEASUREMENT

Below -20 dB of the highest emission level of operating band (in 100kHz Resolution Bandwidth).

Note: Follow DTS measurement, If the device complies with the use of power option 2 the attenuation under this paragraph shall be 30 dB instead of 20 dB.

4.6.2 TEST INSTRUMENTS

DESCRIPTION & MANUFACTURER	MODEL NO.	SERIAL NO.	DATE OF CALIBRATION	DUE DATE OF CALIBRATION
FOR CONDUCTED MEASUREMENT				
R&S SPECTRUM ANALYZER	FSP40	100040	Jul. 07, 2009	Jul. 06, 2010
FOR RADIATED MEASUREMENT				
Test Receiver ROHDE & SCHWARZ	ESI7	100033	Jul. 06, 2009	Jul. 05, 2010
Spectrum Analyzer ROHDE & SCHWARZ	FSP40	100076	May 26, 2009	May 25, 2010
BILOG Antenna SCHWARZBECK	VULB9168	9168-160	Apr. 27, 2009	Apr. 26, 2010
HORN Antenna SCHWARZBECK	9120D	9120D-209	Jul. 01, 2009	Jun. 30, 2010
HORN Antenna SCHWARZBECK	BBHA 9170	BBHA9170243	Dec. 25, 2009	Dec. 24, 2010
Preamplifier Agilent	8447D	2944A10633	Nov. 10, 2009	Nov. 09, 2010
Preamplifier Agilent	8449B	3008A01964	Nov. 09, 2009	Nov. 08, 2010
RF signal cable HUBER+SUHNNER	SUCOFLEX 104	238141/4	May 13, 2009	May 12, 2010
RF signal cable HUBER+SUHNNER	SUCOFLEX 104	12738/6	May 13, 2009	May 12, 2010
Software ADT.	ADT_Radiated_ V7.6.15.9.2	NA	NA	NA
Antenna Tower inn-co GmbH	MA 4000	013303	NA	NA
Antenna Tower Controller inn-co GmbH	CO2000	017303	NA	NA
Turn Table ADT.	TT100.	TT93021703	NA	NA
Turn Table Controller ADT.	SC100.	SC93021703	NA	NA

NOTE: The calibration interval of the above test instruments is 12 months and the calibrations are traceable to NML/ROC and NIST/USA.



A D T

4.6.3 TEST PROCEDURE

FOR CONDUCTED MEASUREMENT

The transmitter output was connected to the spectrum analyzer via a low loss cable. Set both RBW and VBW of spectrum analyzer to 100kHz and 300kHz with suitable frequency span including 100MHz bandwidth from band edge. The band edges was measured and recorded.

The spectrum plots (Peak RBW = 100kHz, VBW = 300kHz; Average RBW = 1MHz, VBW = 10Hz) are attached on the following pages.

FOR RADIATED MEASUREMENT

- a. The EUT was placed on the top of a rotating table 0.8 meters above the ground at a 3 meter semi-anechoic chamber. The table was rotated 360 degrees to determine the position of the highest radiation.
- b. The EUT was set 3 meters away from the interference-receiving antenna, which was mounted on the top of a variable-height antenna tower.
- c. The antenna is a broadband antenna, and its height is varied from one meter to four meters above the ground to determine the maximum value of the field strength. Both horizontal and vertical polarizations of the antenna are set to make the measurement.
- d. For each suspected emission, the EUT was arranged to its worst case and then the antenna was tuned to heights from 1 meter to 4 meters and the rotatable table was turned from 0 degrees to 360 degrees to find the maximum reading.
- e. Set both RBW and VBW of spectrum analyzer to 100kHz with suitable frequency span including 100MHz bandwidth from band edge. The band edges was measured and recorded.

The spectrum plots (Peak RBW = 100kHz, VBW = 300kHz; Average RBW = 1MHz, VBW = 10Hz)

NOTE: The resolution bandwidth of test receiver/spectrum analyzer is 1MHz and the video bandwidth is 10Hz for Average detection (AV) at frequency above 1GHz.

4.6.4 DEVIATION FROM TEST STANDARD

No deviation.

4.6.5 EUT OPERATING CONDITION

Same as Item 4.3.6.

4.6.6 TEST RESULTS

The spectrum plots are attached on the following pages. D1 line indicates the highest level, and D2 line indicates the 20dB offset below D1. It shows compliance with the requirement in part 15.247(d).

802.11b

RESTRICT BAND (2310 ~ 2390 MHz)

FREQUENCY (MHz)	FUNDAMENTAL EMISSION (dBuV/m)	DELTA (dB)	MAXIMUM FIELD STRENGTH IN RESTRICT BAND (dBuV/m)	LIMIT (dBuV/m)
2412.00 (PK)	109.2	54.32	54.88	74.00
2412.00 (AV)	105.0	56.85	48.15	54.00

RESTRICT BAND (2483.5 ~ 2500 MHz)

FREQUENCY (MHz)	FUNDAMENTAL EMISSION (dBuV/m)	DELTA (dB)	MAXIMUM FIELD STRENGTH IN RESTRICT BAND (dBuV/m)	LIMIT (dBuV/m)
2462.00 (PK)	109.6	52.23	57.37	74.00
2462.00 (AV)	105.3	54.42	50.88	54.00

NOTE:

- Delta = Amplitude between the peak of the fundamental and the peak of the band edge emission. Please check following 3 pages.
- Maximum field strength in restrict band = Fundamental emission – Delta.



A D T

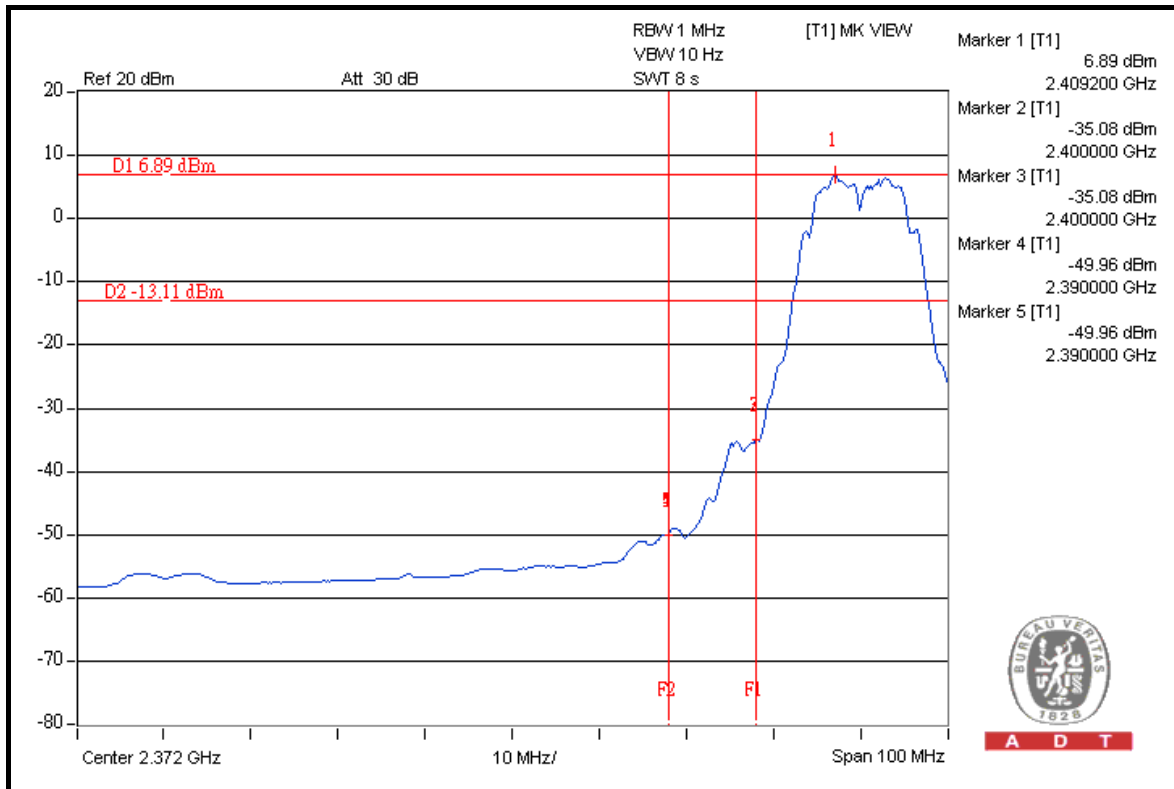
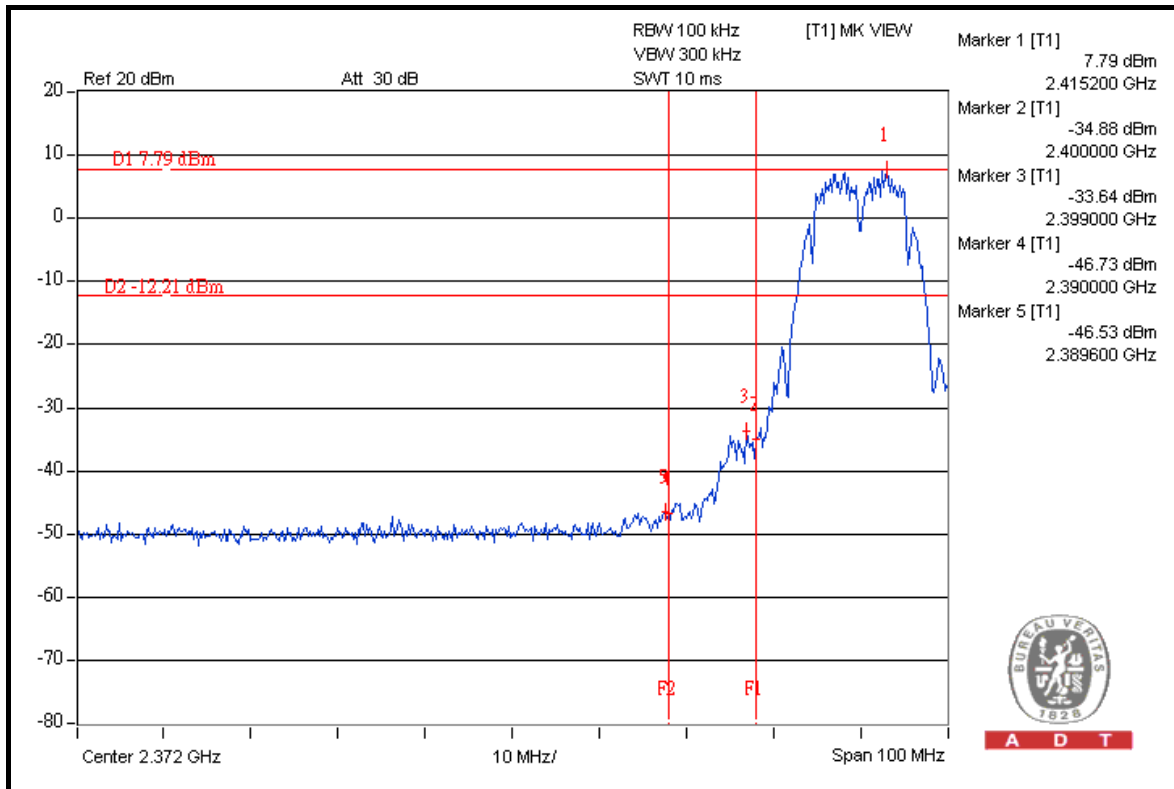



A D T

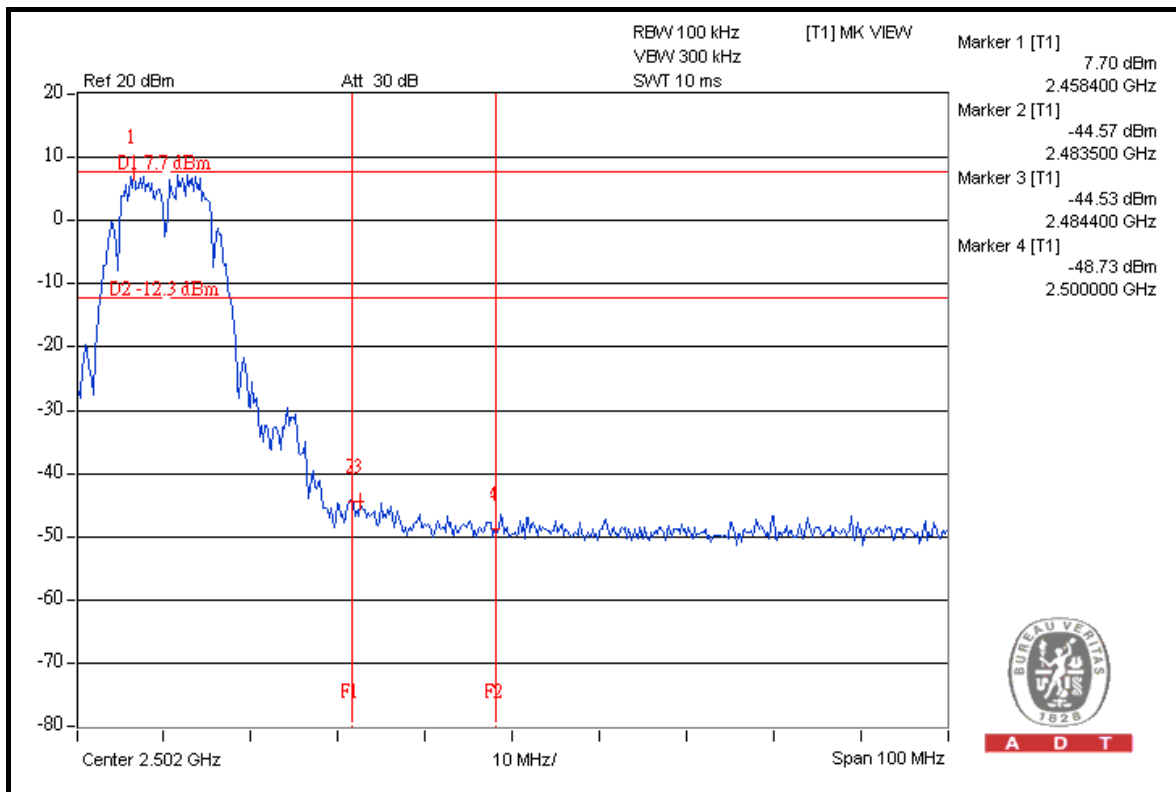
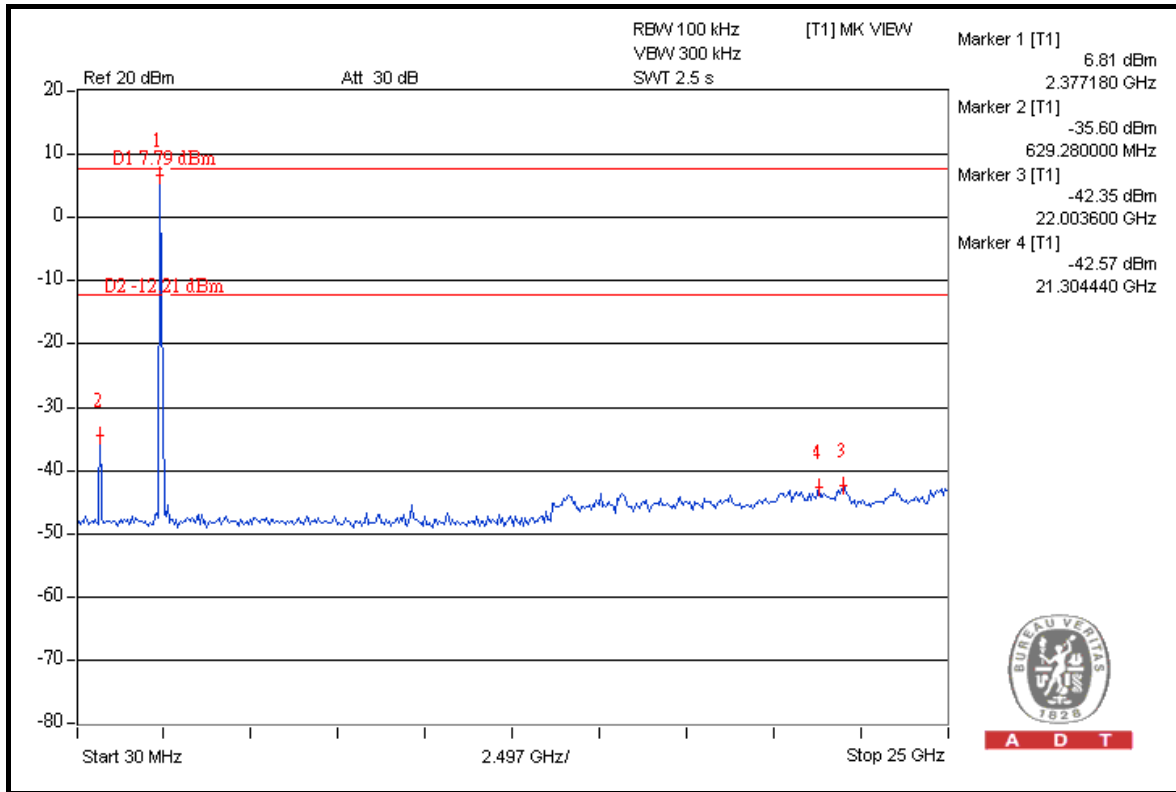



A D T

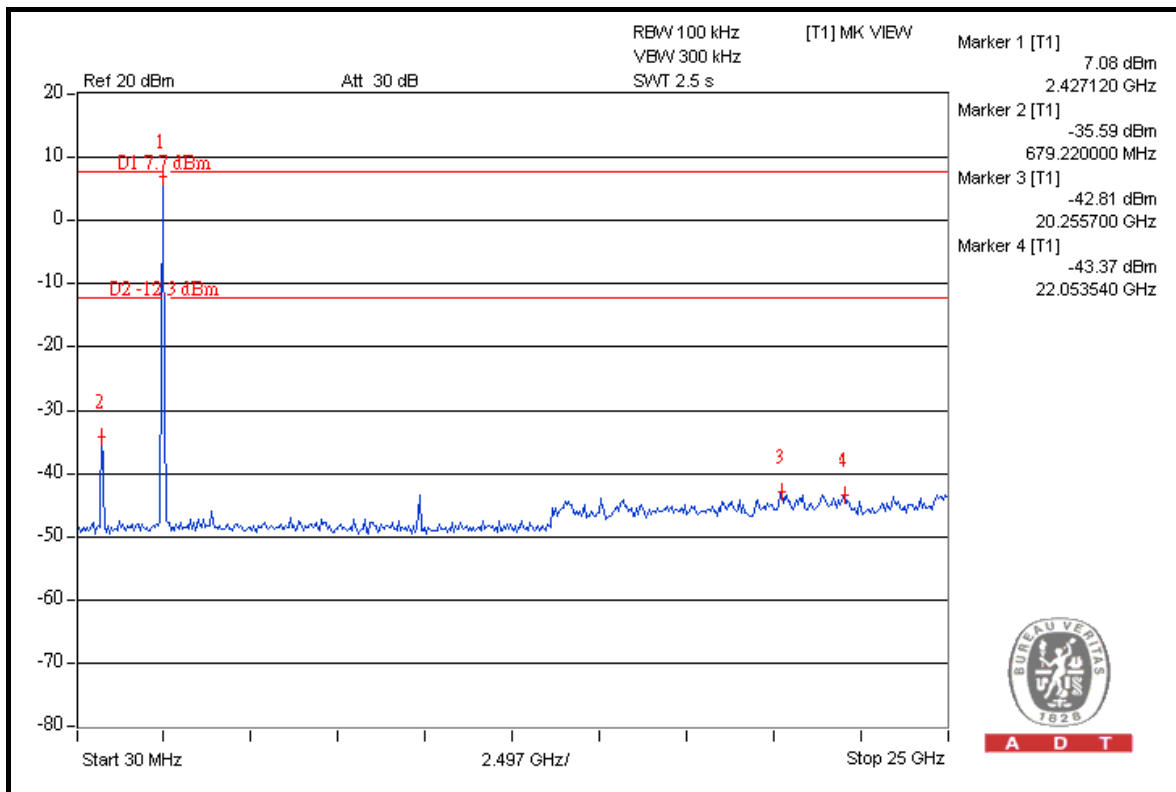
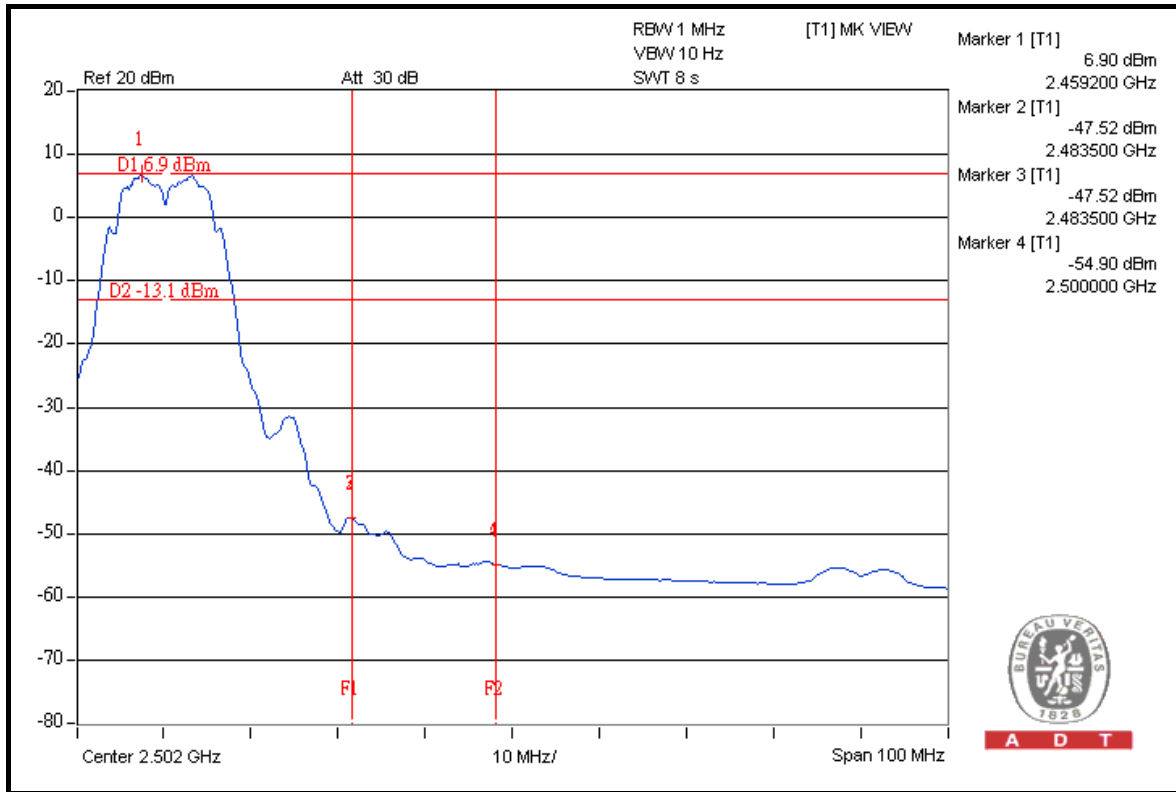



A D T

802.11g

RESTRICT BAND (2310 ~ 2390 MHz)

FREQUENCY (MHz)	FUNDAMENTAL EMISSION (dBuV/m)	DELTA (dB)	MAXIMUM FIELD STRENGTH IN RESTRICT BAND (dBuV/m)	LIMIT (dBuV/m)
2412.00 (PK)	108.6	48.31	60.29	74.00
2412.00 (AV)	95.5	48.80	46.70	54.00

RESTRICT BAND (2483.5 ~ 2500 MHz)

FREQUENCY (MHz)	FUNDAMENTAL EMISSION (dBuV/m)	DELTA (dB)	MAXIMUM FIELD STRENGTH IN RESTRICT BAND (dBuV/m)	LIMIT (dBuV/m)
2462.00 (PK)	109.1	46.54	62.56	74.00
2462.00 (AV)	96.0	46.87	49.13	54.00

NOTE:

1. Delta = Amplitude between the peak of the fundamental and the peak of the band edge emission. Please check following 3 pages.
2. Maximum field strength in restrict band = Fundamental emission – Delta.



A D T

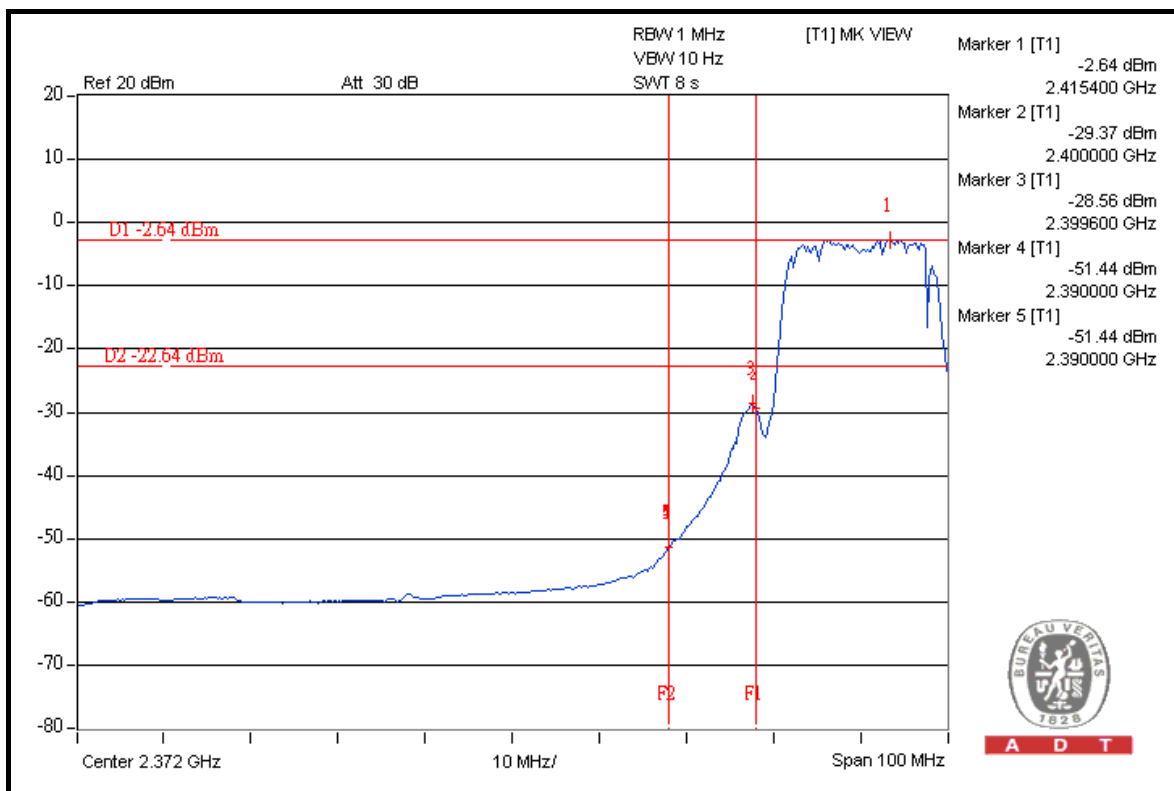
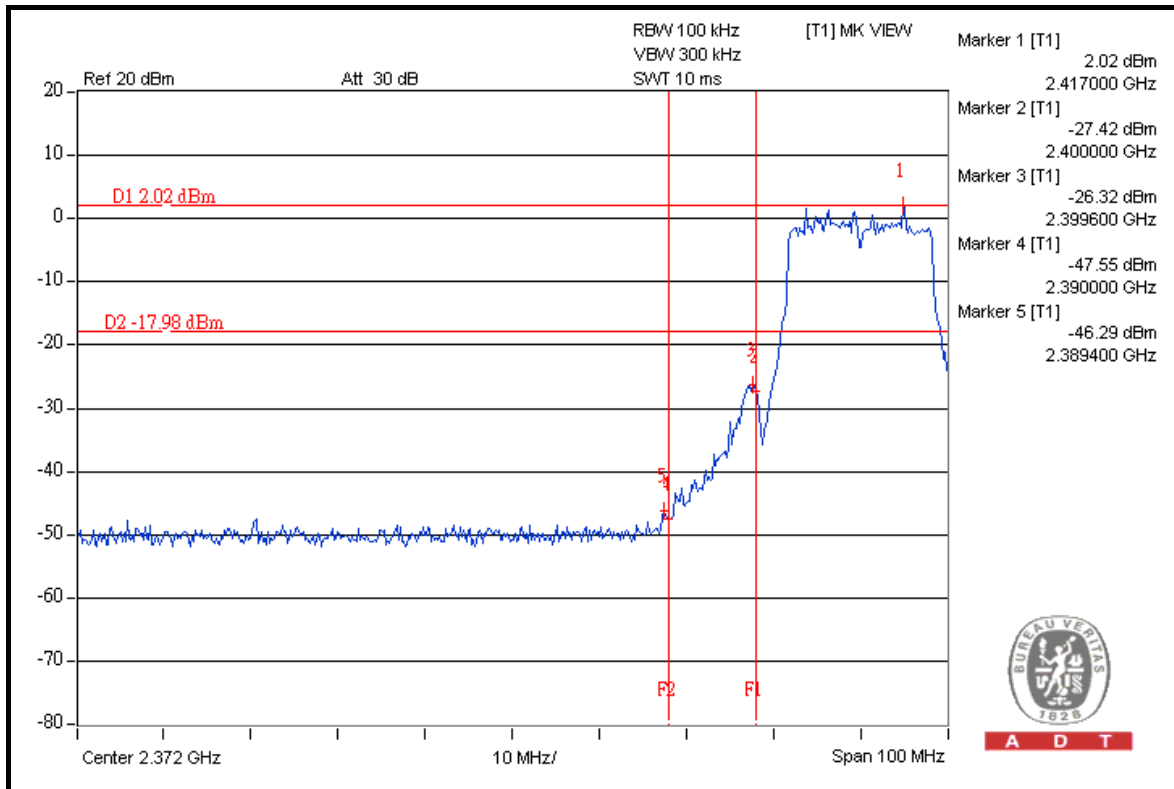



A D T

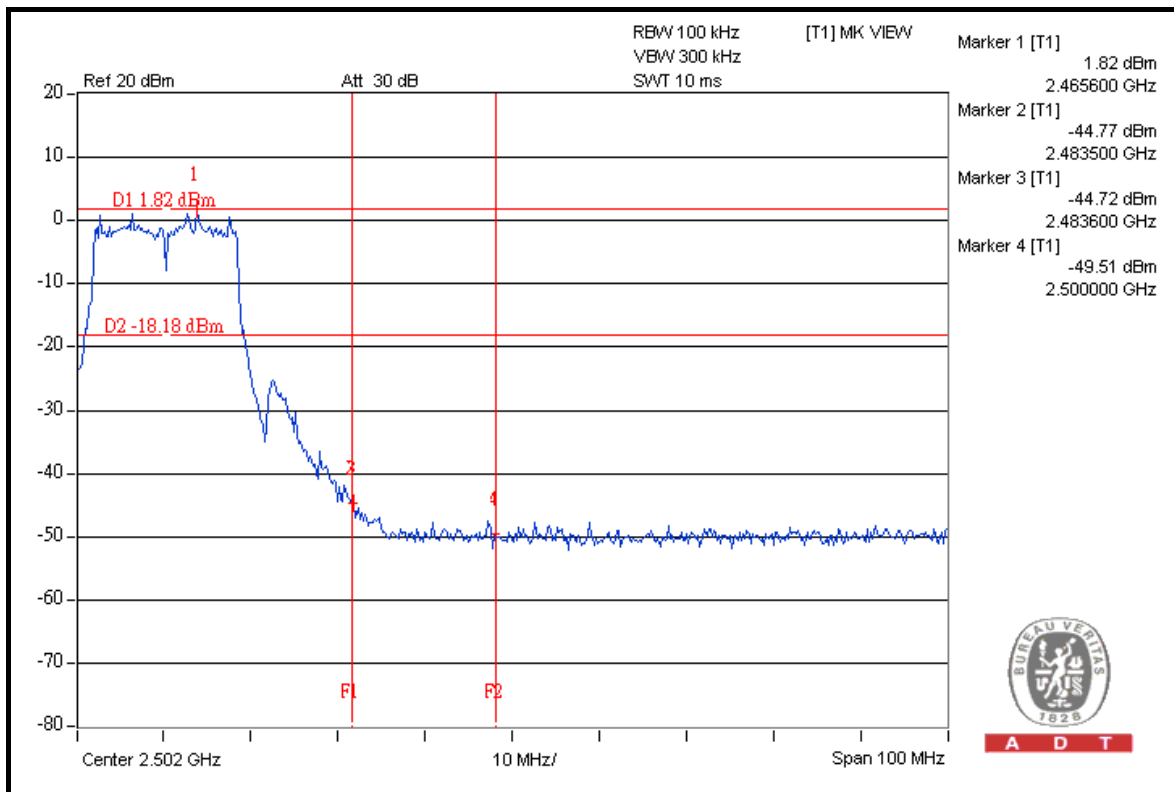
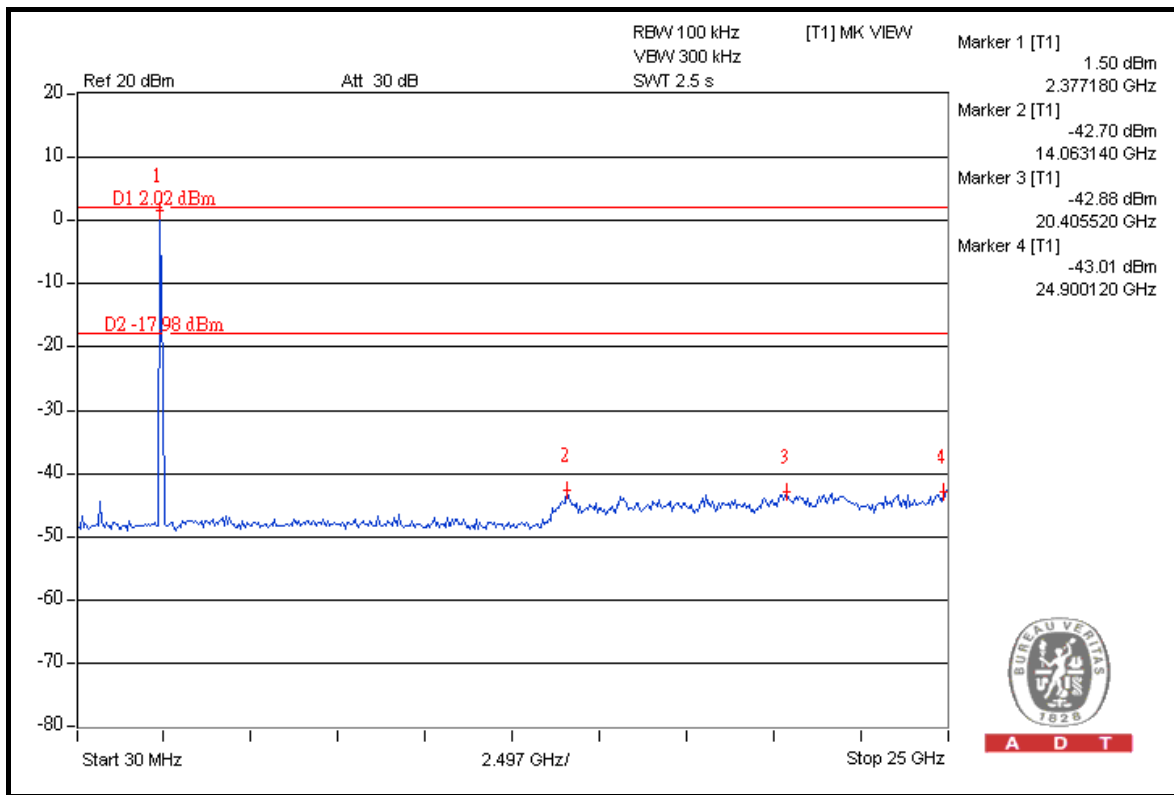



A D T

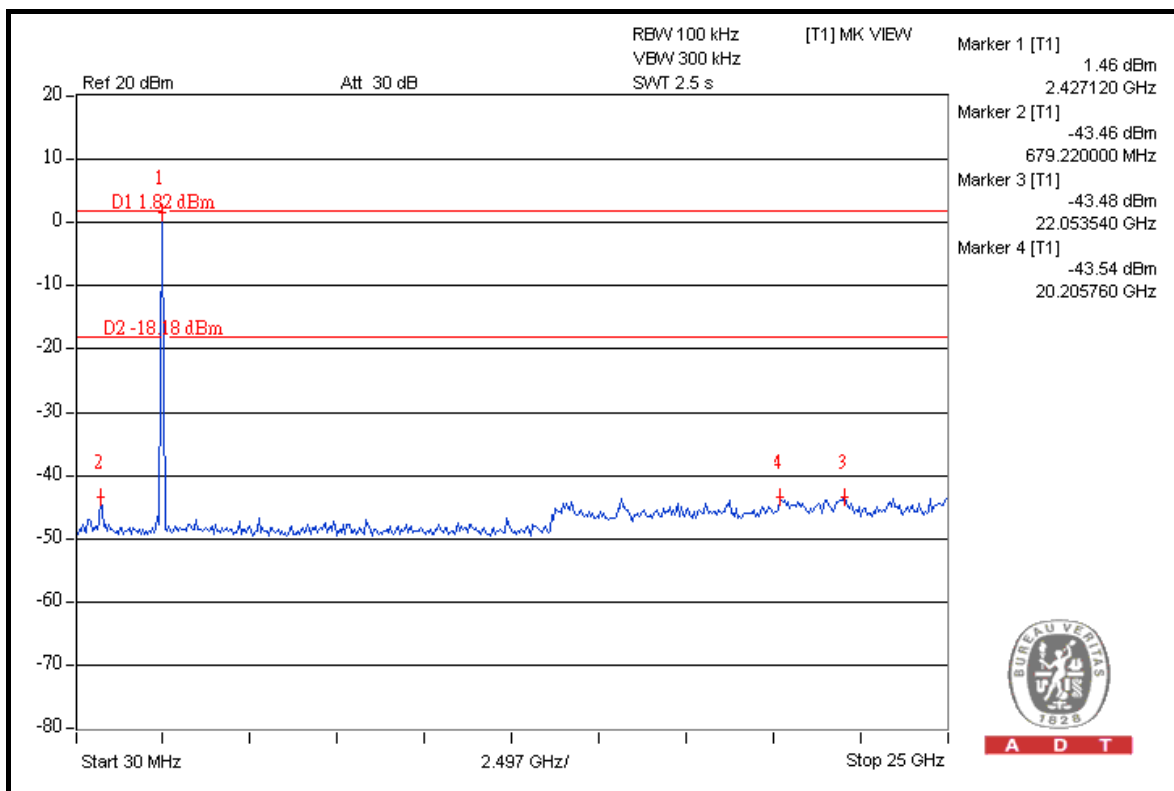
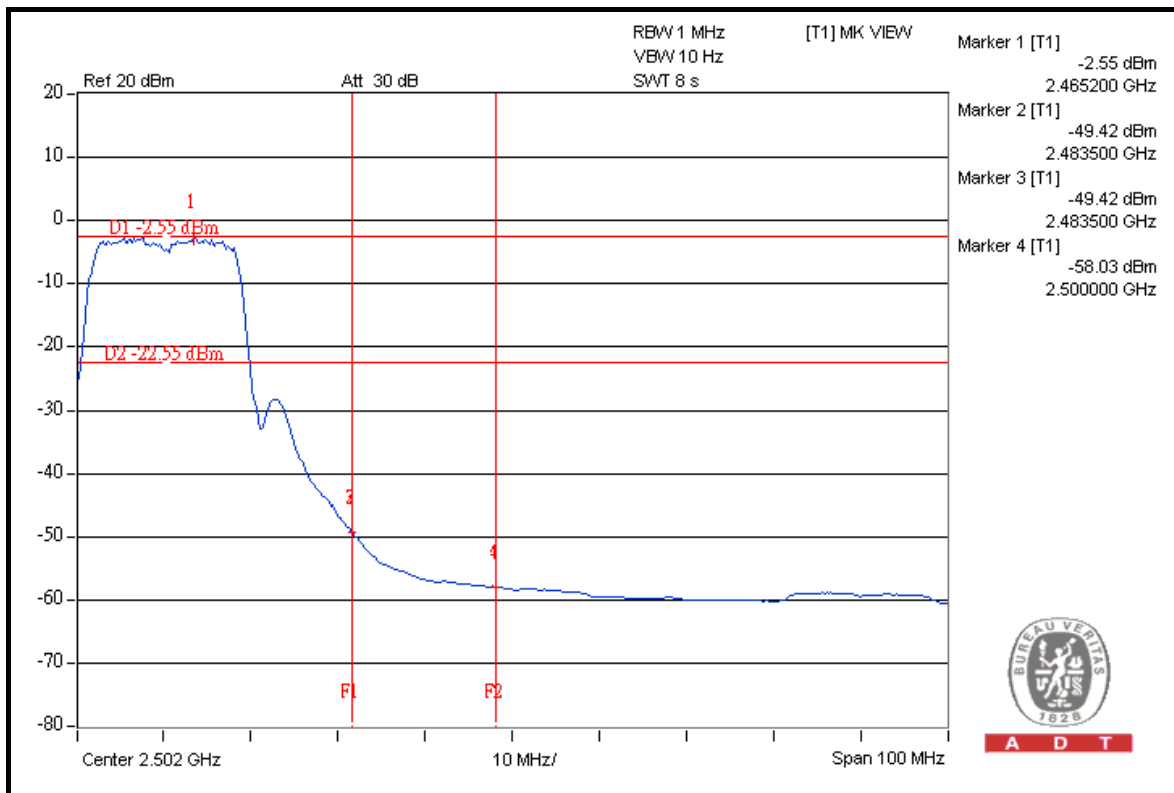



A D T

802.11n (20MHz)

RESTRICT BAND (2310 ~ 2390 MHz)

FREQUENCY (MHz)	FUNDAMENTAL EMISSION (dBuV/m)	DELTA (dB)	MAXIMUM FIELD STRENGTH IN RESTRICT BAND (dBuV/m)	LIMIT (dBuV/m)
2412.00 (PK)	110.9	45.87	65.03	74.00
2412.00 (AV)	93.2	41.22	51.98	54.00

RESTRICT BAND (2483.5 ~ 2500 MHz)

FREQUENCY (MHz)	FUNDAMENTAL EMISSION (dBuV/m)	DELTA (dB)	MAXIMUM FIELD STRENGTH IN RESTRICT BAND (dBuV/m)	LIMIT (dBuV/m)
2462.00 (PK)	110.8	45.76	65.04	74.00
2462.00 (AV)	92.2	41.72	50.48	54.00

NOTE:

1. Delta = Amplitude between the peak of the fundamental and the peak of the band edge emission. Please check following 3 pages.
2. Maximum field strength in restrict band = Fundamental emission – Delta.



A D T

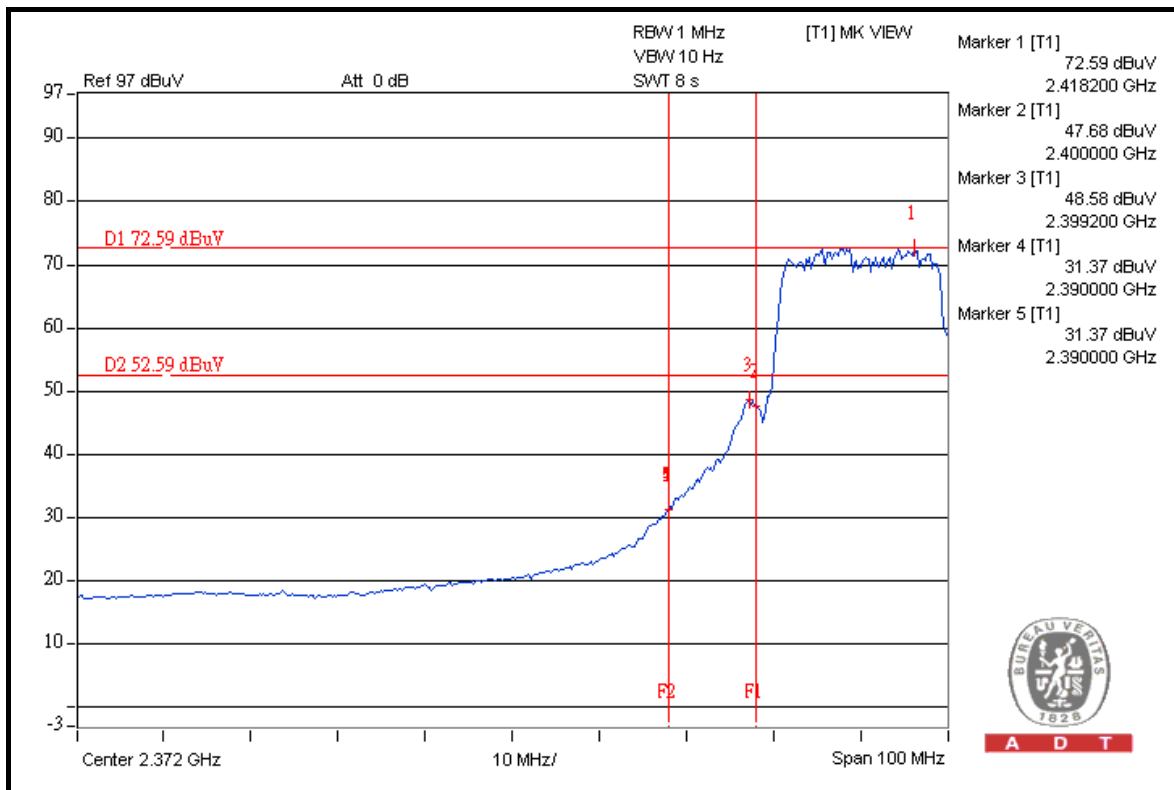
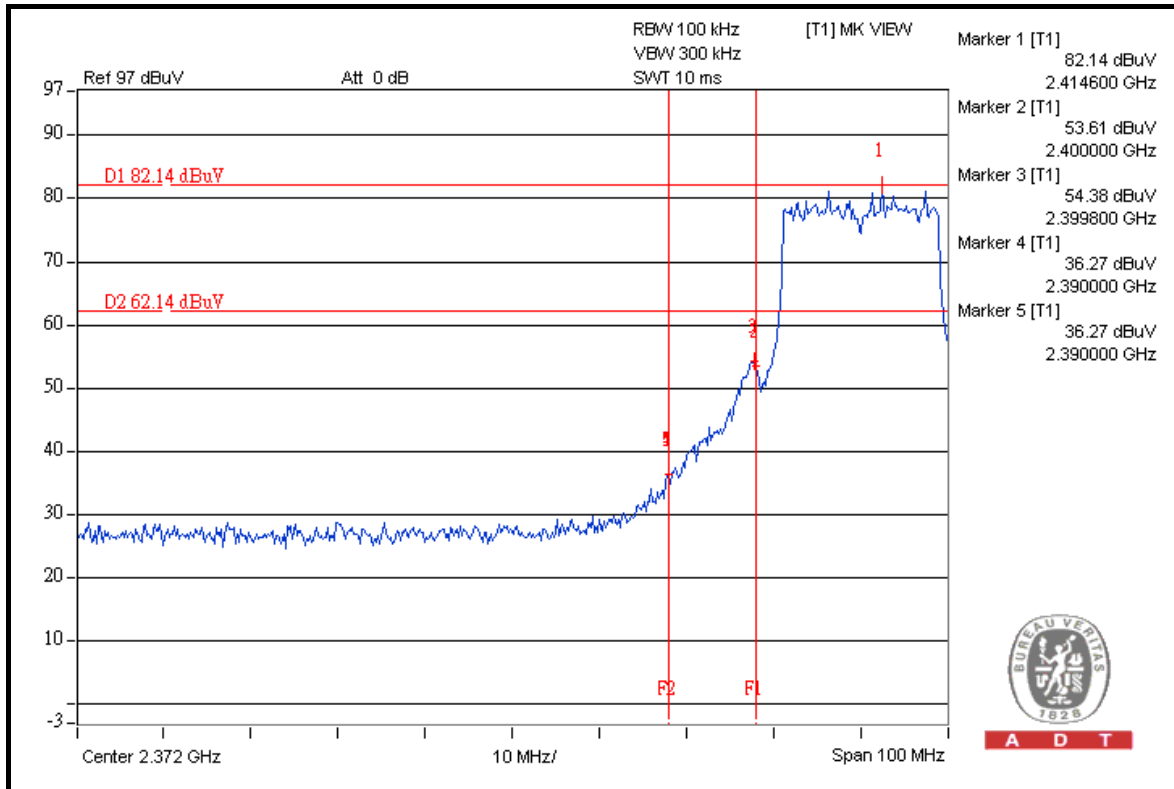



A D T

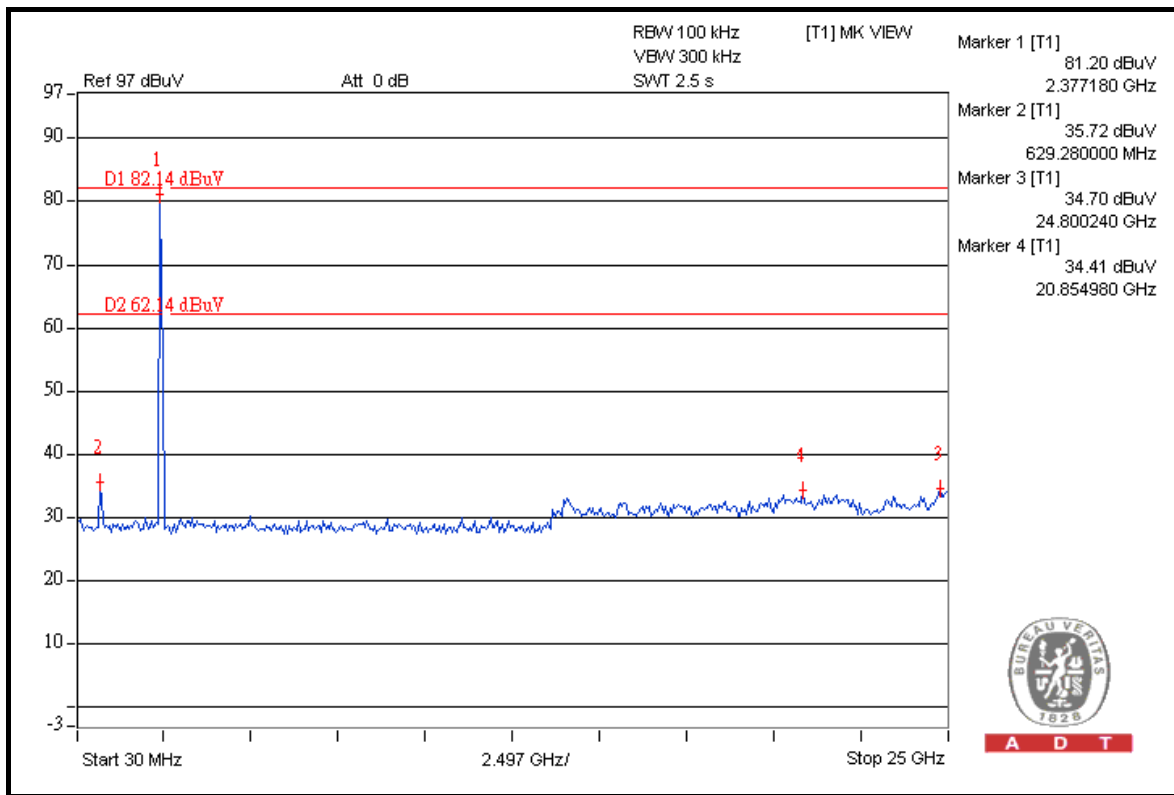

A D T

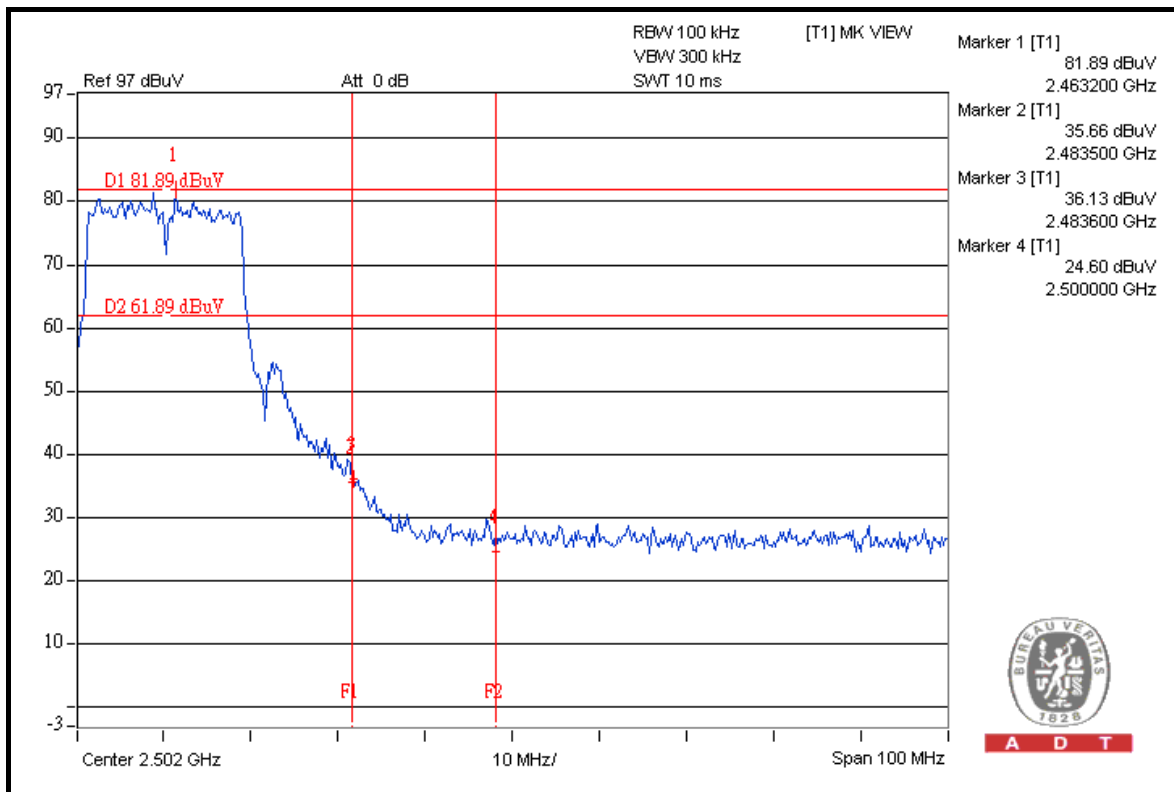

A D T



A D T

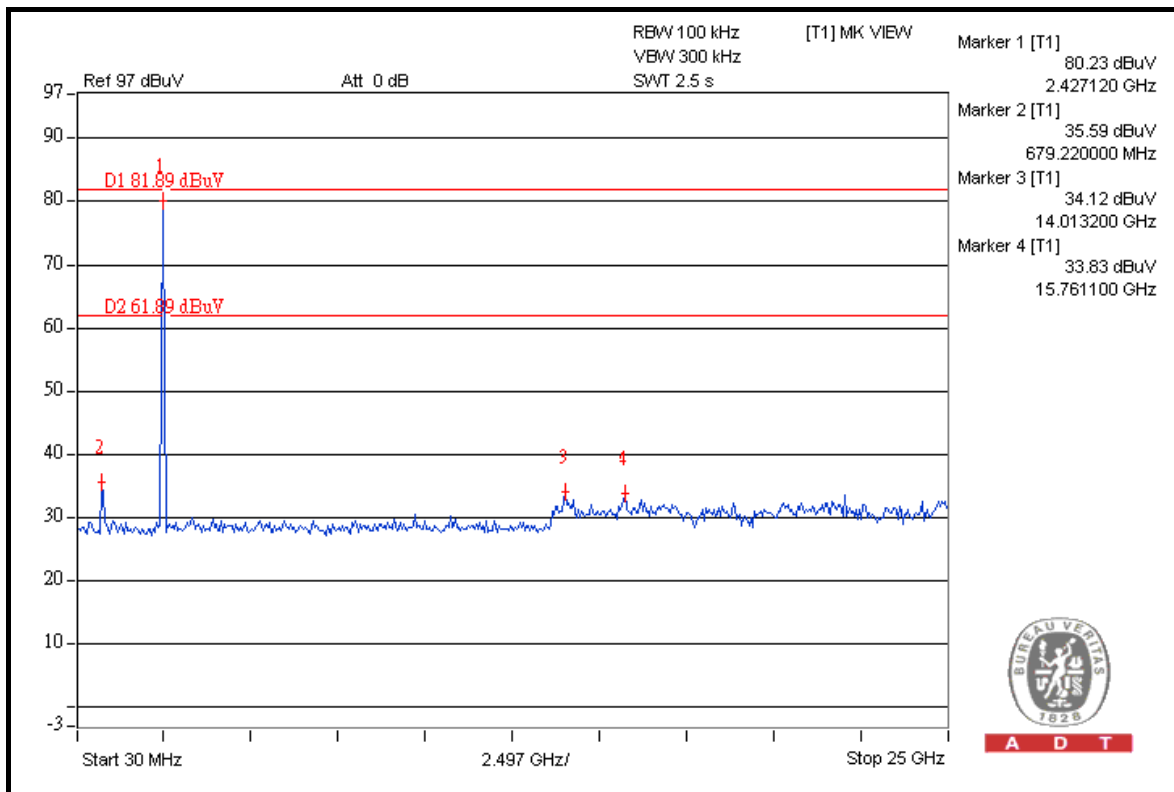
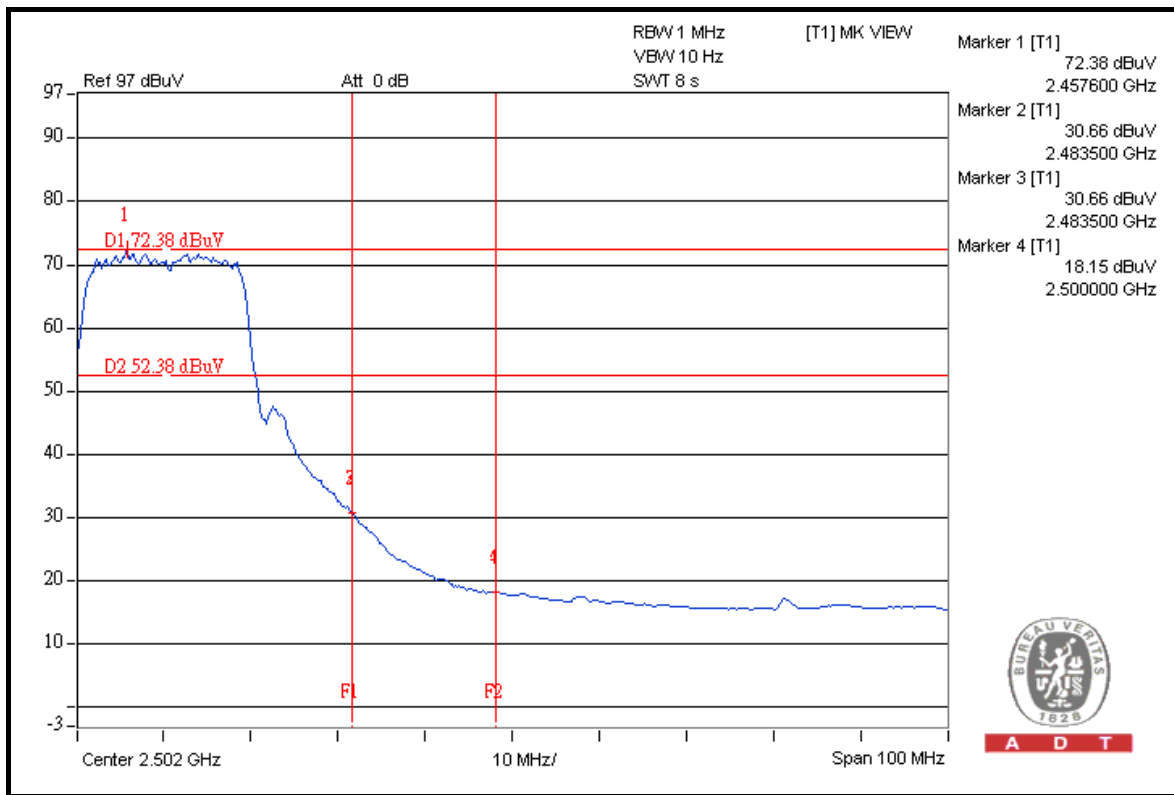



A D T

802.11n (40MHz)

RESTRICT BAND (2310 ~ 2390 MHz)

FREQUENCY (MHz)	FUNDAMENTAL EMISSION (dBuV/m)	DELTA (dB)	MAXIMUM FIELD STRENGTH IN RESTRICT BAND (dBuV/m)	LIMIT (dBuV/m)
2422.00 (PK)	105.1	37.44	67.66	74.00
2422.00 (AV)	84.5	32.08	52.42	54.00

RESTRICT BAND (2483.5 ~ 2500 MHz)

FREQUENCY (MHz)	FUNDAMENTAL EMISSION (dBuV/m)	DELTA (dB)	MAXIMUM FIELD STRENGTH IN RESTRICT BAND (dBuV/m)	LIMIT (dBuV/m)
2452.00 (PK)	105.6	36.60	69.00	74.00
2452.00 (AV)	85.0	35.05	49.95	54.00

NOTE:

1. Delta = Amplitude between the peak of the fundamental and the peak of the band edge emission. Please check following 3 pages.
2. Maximum field strength in restrict band = Fundamental emission – Delta.



A D T

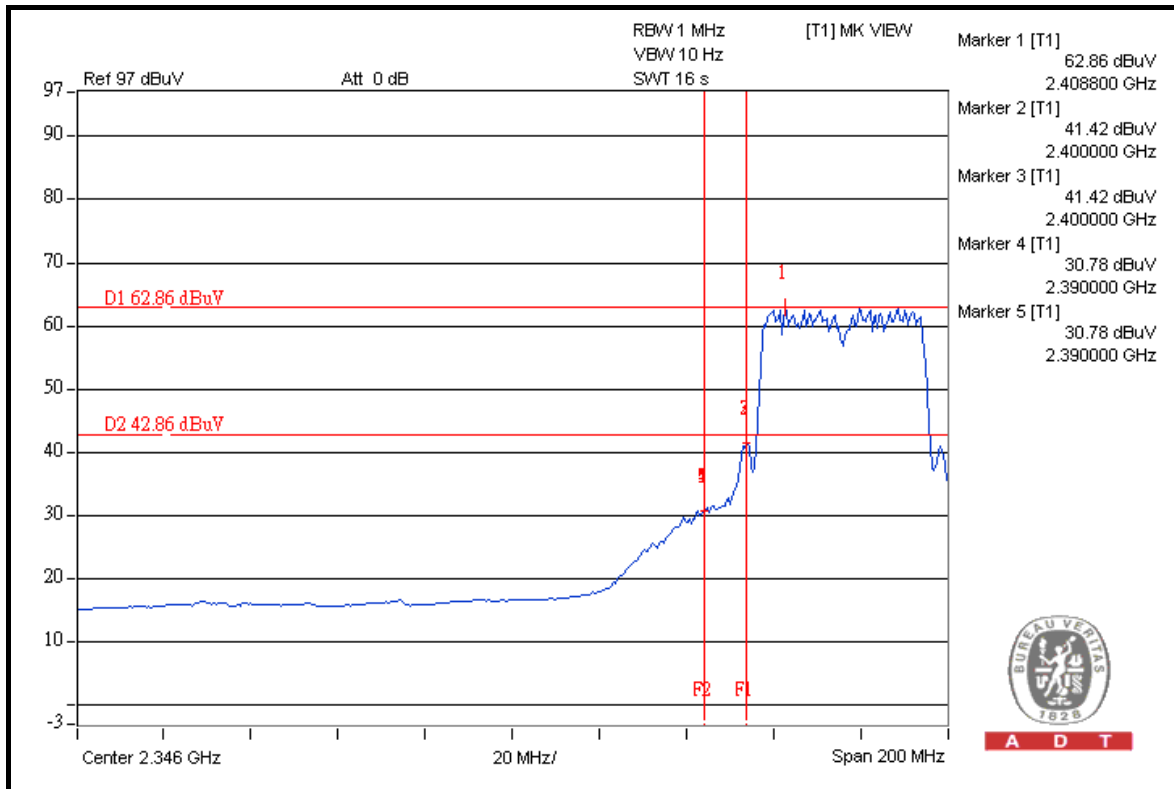
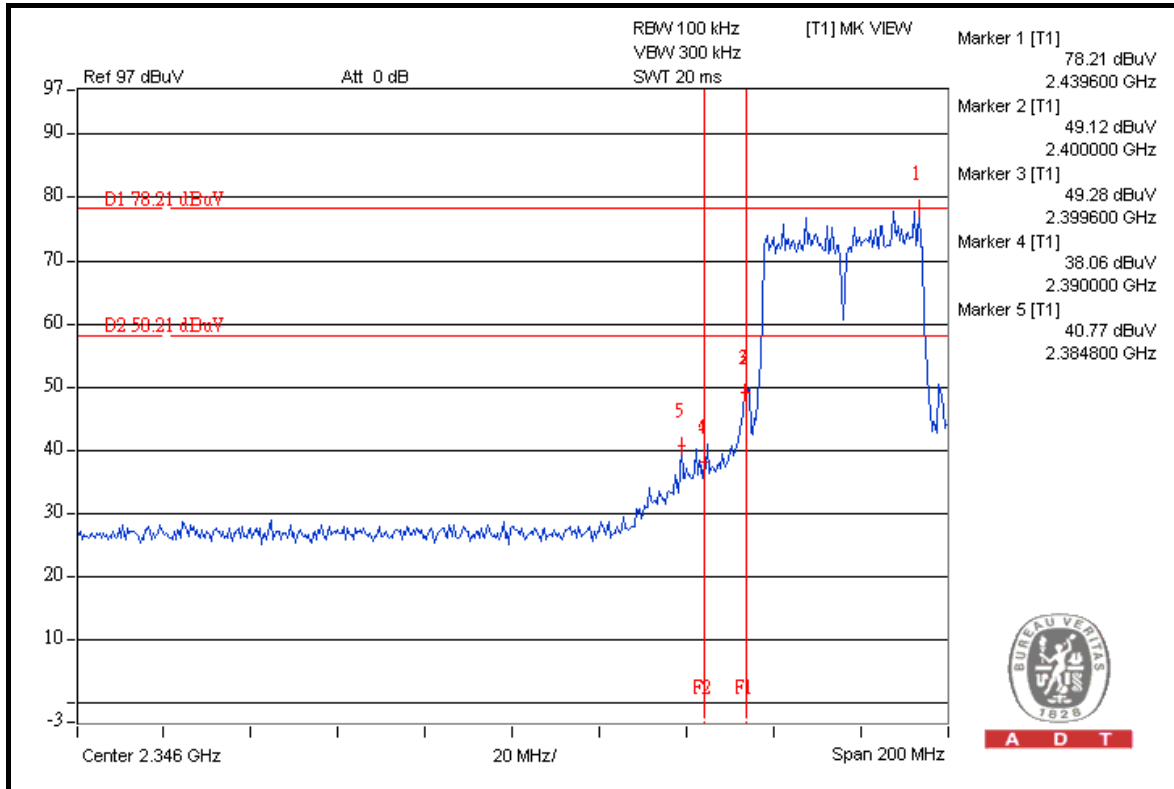



A D T

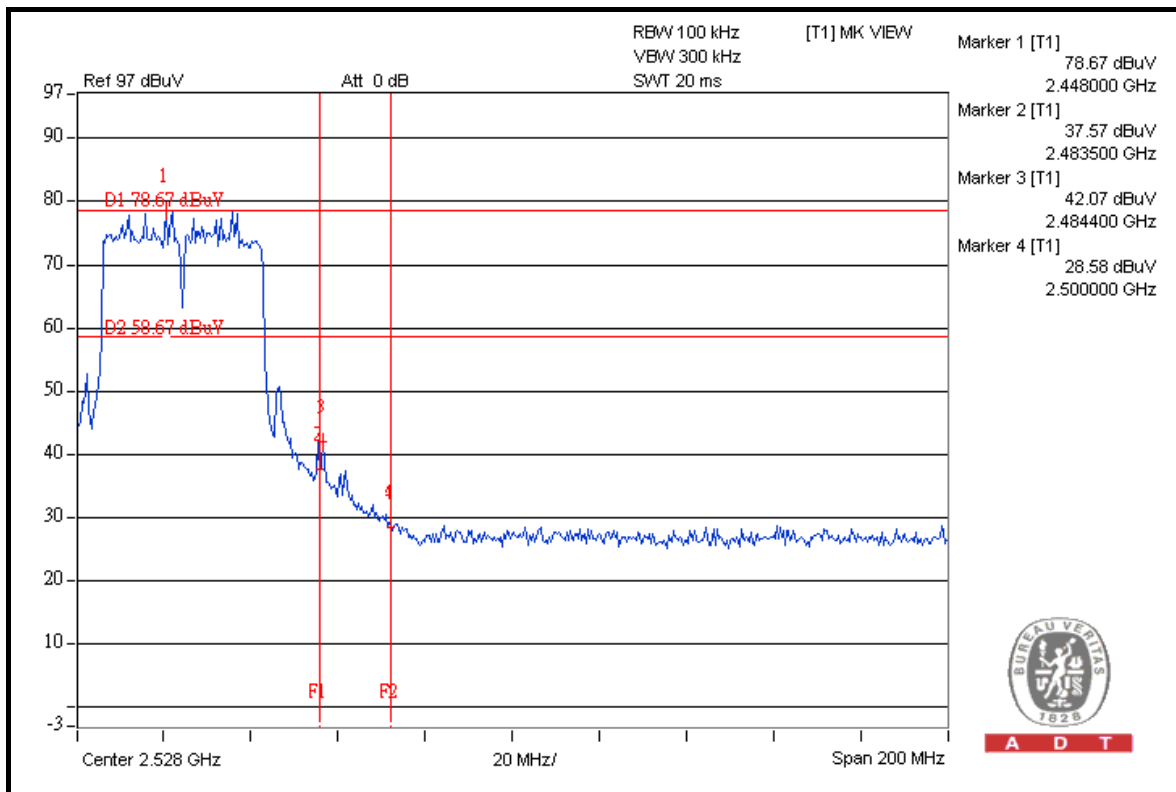
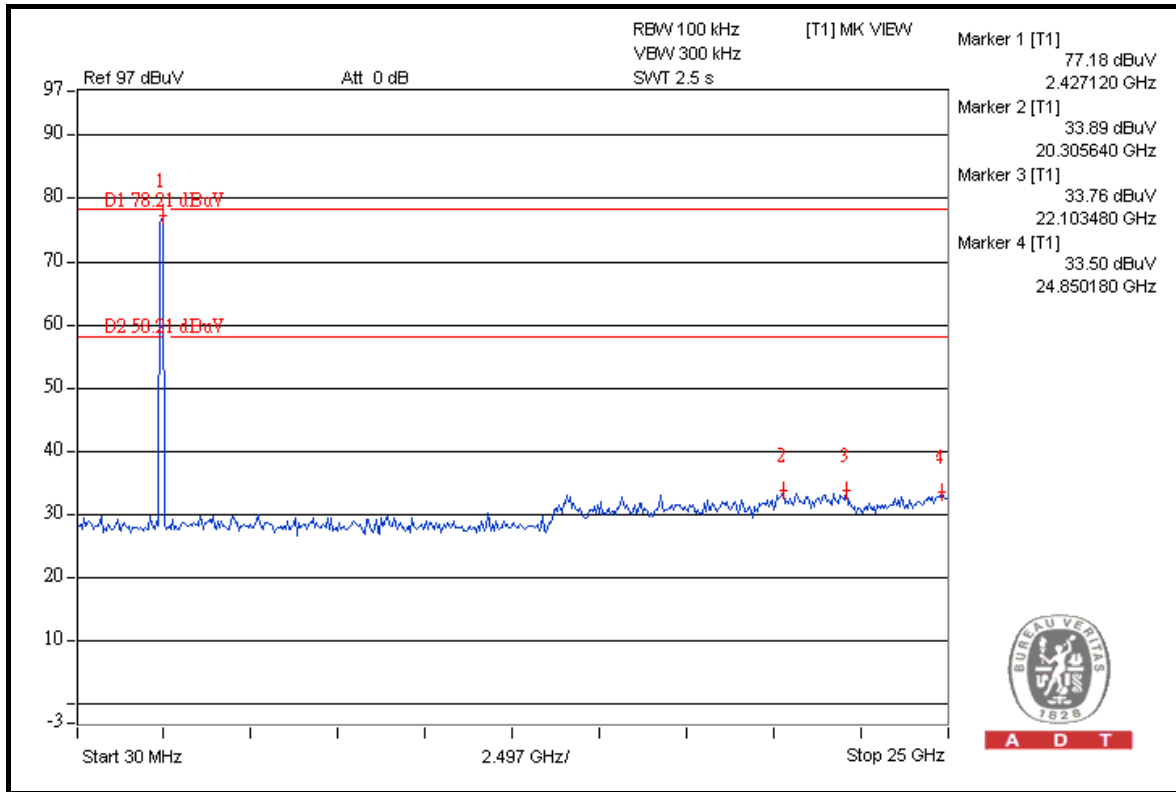



A D T

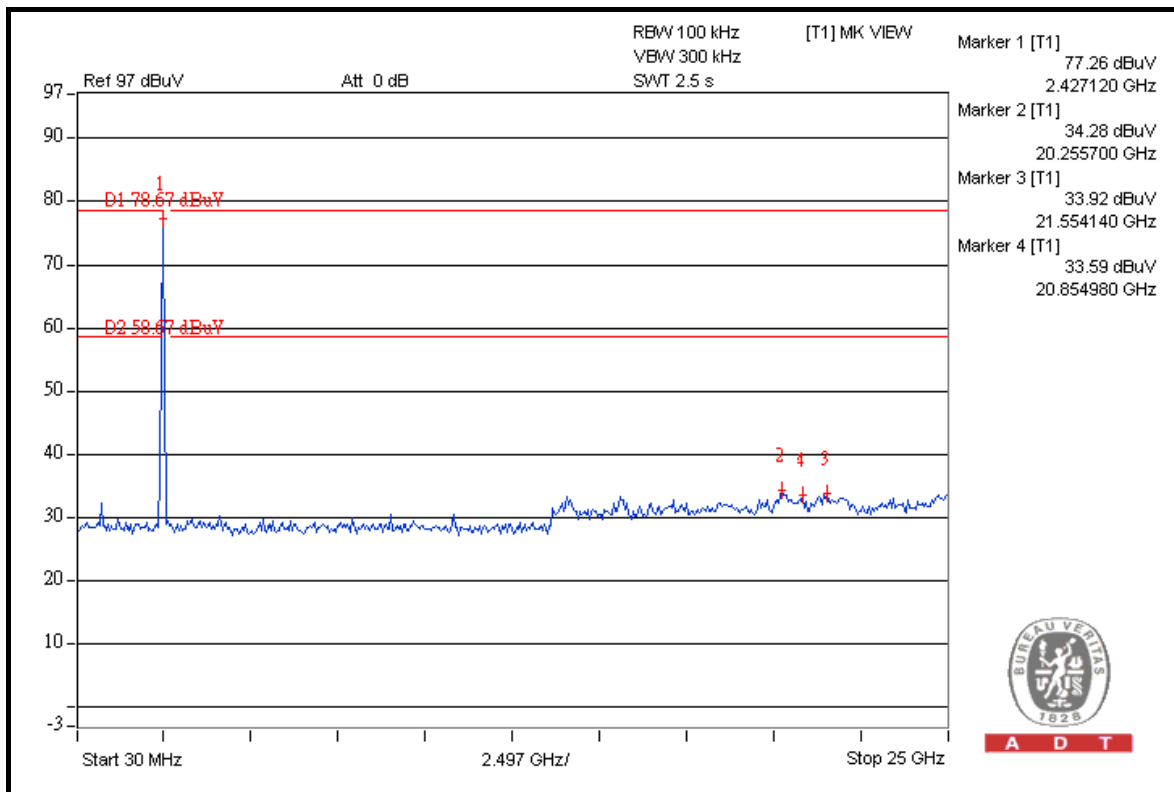
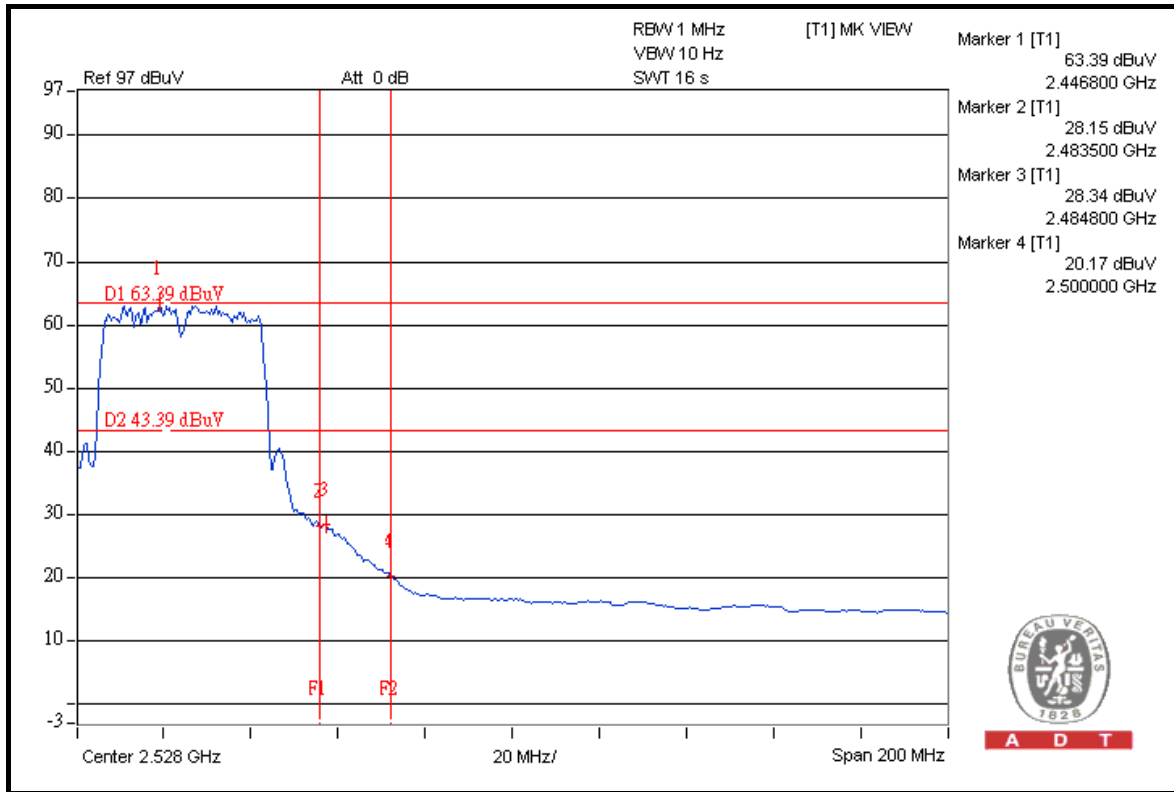



5. TEST TYPES AND RESULTS (FOR 5.0GHz BAND)

5.1 RADIATED EMISSION MEASUREMENT

5.1.1 LIMITS OF RADIATED EMISSION MEASUREMENT

Emissions radiated outside of the specified bands, shall be according to the general radiated limits in 15.209 as following:

FREQUENCIES (MHz)	FIELD STRENGTH (microvolts/meter)	MEASUREMENT DISTANCE (meters)
0.009 ~ 0.490	2400/F(kHz)	300
0.490 ~ 1.705	24000/F(kHz)	30
1.705 ~ 30.0	30	30
30 ~ 88	100	3
88 ~ 216	150	3
216 ~ 960	200	3
Above 960	500	3

NOTE:

1. The lower limit shall apply at the transition frequencies.
2. Emission level (dBuV/m) = 20 log Emission level (uV/m).
3. As shown in 15.35(b), for frequencies above 1000MHz, the field strength limits are based on average detector, however, the peak field strength of any emission shall not exceed the maximum permitted average limits, specified above by more than 20dB under any condition of modulation.



A D T

5.1.2 TEST INSTRUMENTS

DESCRIPTION & MANUFACTURER	MODEL NO.	SERIAL NO.	DATE OF CALIBRATION	DUE DATE OF CALIBRATION
Test Receiver ROHDE & SCHWARZ	ESI7	100033	Jul. 06, 2009	Jul. 05, 2010
Spectrum Analyzer ROHDE & SCHWARZ	FSP40	100076	May 26, 2009	May 25, 2010
BILOG Antenna SCHWARZBECK	VULB9168	9168-160	Apr. 27, 2009	Apr. 26, 2010
HORN Antenna SCHWARZBECK	9120D	9120D-209	Jul. 01, 2009	Jun. 30, 2010
HORN Antenna SCHWARZBECK	BBHA 9170	BBHA9170243	Dec. 25, 2009	Dec. 24, 2010
Preamplifier Agilent	8447D	2944A10633	Nov. 10, 2009	Nov. 09, 2010
Preamplifier Agilent	8449B	3008A01964	Nov. 09, 2009	Nov. 08, 2010
RF signal cable HUBER+SUHNNER	SUCOFLEX 104	238141/4	May 13, 2009	May 12, 2010
RF signal cable HUBER+SUHNNER	SUCOFLEX 104	12738/6	May 13, 2009	May 12, 2010
Software ADT.	ADT_Radiated_ V7.6.15.9.2	NA	NA	NA
Antenna Tower inn-co GmbH	MA 4000	013303	NA	NA
Antenna Tower Controller inn-co GmbH	CO2000	017303	NA	NA
Turn Table ADT.	TT100.	TT93021703	NA	NA
Turn Table Controller ADT.	SC100.	SC93021703	NA	NA
26GHz ~ 40GHz Amplifier	EM26400	07026401	Aug. 27, 2009	Aug. 26, 2010

- NOTE:**
1. The calibration interval of the above test instruments is 12 months and the calibrations are traceable to NML/ROC and NIST/USA.
 2. The test was performed in HwaYa Chamber 3.
 3. The horn antenna and HP preamplifier (model: 8449B) are used only for the measurement of emission frequency above 1GHz if tested.
 4. The FCC Site Registration No. is 988962.
 5. The IC Site Registration No. is IC 7450F-3.



5.1.3 TEST PROCEDURES

- a. The EUT was placed on the top of a rotating table 0.8 meters above the ground at a 3 meters semi-anechoic chamber. The table was rotated 360 degrees to determine the position of the highest radiation.
- b. The EUT was set 3 meters away from the interference-receiving antenna, which was mounted on the top of a variable-height antenna tower.
- c. The antenna is a broadband antenna, and its height is varied from one meter to four meters above the ground to determine the maximum value of the field strength. Both horizontal and vertical polarizations of the antenna are set to make the measurement.
- d. For each suspected emission, the EUT was arranged to its worst case and then the antenna was tuned to heights from 1 meter to 4 meters and the rotatable table was turned from 0 degrees to 360 degrees to find the maximum reading.
- e. The test-receiver system was set to Peak Detect Function and Specified Bandwidth with Maximum Hold Mode.
- f. If the emission level of the EUT in peak mode was lower than the limit specified, then testing could be stopped and the peak values of the EUT would be reported. Otherwise the emissions would be re-tested one by one using peak, quasi-peak or average method as specified and then reported in a data sheet.

NOTE:

1. The resolution bandwidth and video bandwidth of test receiver/spectrum analyzer is 120kHz for Quasi-peak detection at frequency below 1GHz.
2. The resolution bandwidth of test receiver/spectrum analyzer is 1MHz and video bandwidth is 3MHz for Peak detection at frequency above 1GHz.
3. The resolution bandwidth of test receiver/spectrum analyzer is 1MHz and the video bandwidth is 10Hz for Average detection (AV) at frequency above 1GHz.
4. All modes of operation were investigated and the worst-case emissions are reported.

5.1.4 DEVIATION FROM TEST STANDARD

No deviation.

5.1.5 TEST SETUP

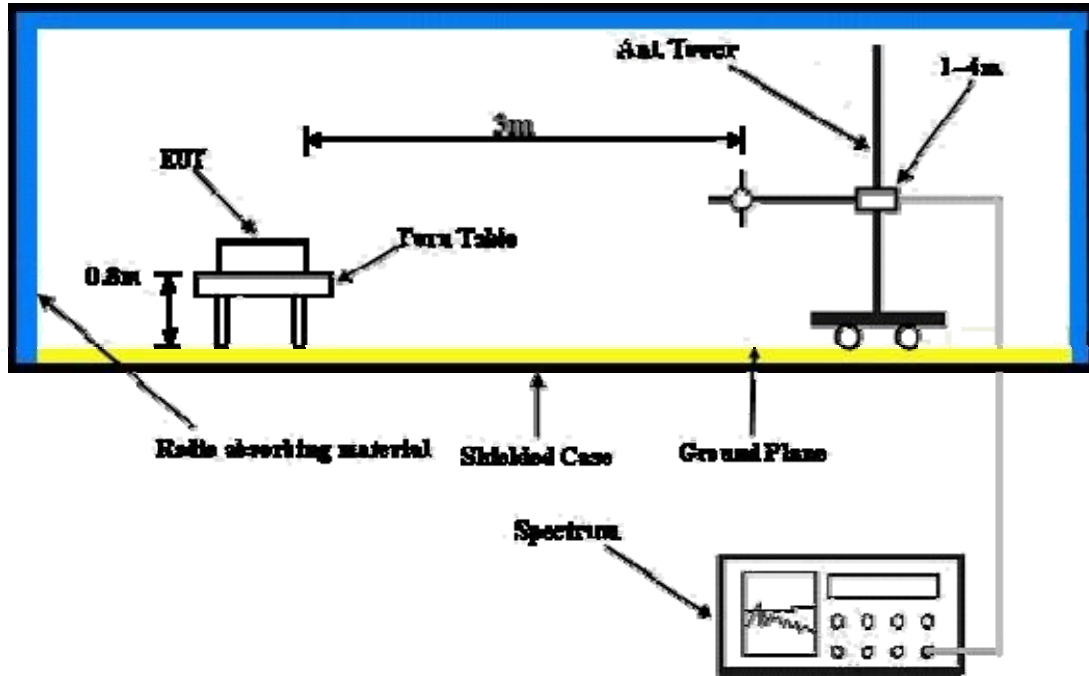

For the actual test configuration, please refer to the attached file (Test Setup Photo).

5.1.6 EUT OPERATING CONDITIONS

Same as 4.1.6.



A D T

5.1.7 TEST RESULTS

802.11a

EUT TEST CONDITION		MEASUREMENT DETAIL	
CHANNEL	Channel 149	FREQUENCY RANGE	1 ~ 40GHz
INPUT POWER (SYSTEM)	120Vac, 60 Hz	DETECTOR FUNCTION	Peak (PK) Average (AV)
ENVIRONMENTAL CONDITIONS	23deg. C, 65%RH 1011 hPa	TESTED BY	Brad Wu

ANTENNA POLARITY & TEST DISTANCE: HORIZONTAL AT 3 M								
NO.	FREQ. (MHz)	EMISSION LEVEL (dBuV/m)	LIMIT (dBuV/m)	MARGIN (dB)	ANTENNA HEIGHT (m)	TABLE ANGLE (Degree)	RAW VALUE (dBuV)	CORRECTION FACTOR (dB/m)
1	#5725.00	68.1 PK	83.2	-15.1	1.05 H	135	30.10	38.00
2	#5725.00	49.8 AV	69.4	-19.6	1.05 H	135	11.80	38.00
3	*5745.00	103.2 PK			1.05 H	135	65.20	38.00
4	*5745.00	89.4 AV			1.05 H	135	51.40	38.00
5	11490.00	58.6 PK	74.0	-15.4	1.09 H	236	10.60	48.00
6	11490.00	45.4 AV	54.0	-8.6	1.09 H	236	-2.60	48.00
ANTENNA POLARITY & TEST DISTANCE: VERTICAL AT 3 M								
NO.	FREQ. (MHz)	EMISSION LEVEL (dBuV/m)	LIMIT (dBuV/m)	MARGIN (dB)	ANTENNA HEIGHT (m)	TABLE ANGLE (Degree)	RAW VALUE (dBuV)	CORRECTION FACTOR (dB/m)
1	#5725.00	74.4 PK	88.4	-14.0	1.00 V	5	36.40	38.00
2	#5725.00	55.3 AV	75.2	-19.9	1.00 V	5	17.30	38.00
3	*5745.00	108.4 PK			1.00 V	5	70.40	38.00
4	*5745.00	95.2 AV			1.00 V	5	57.20	38.00
5	11490.00	59.5 PK	74.0	-14.5	1.14 V	221	11.50	48.00
6	11490.00	46.3 AV	54.0	-7.7	1.14 V	221	-1.70	48.00

- REMARKS:**
1. Emission level (dBuV/m) = Raw Value (dBuV) + Correction Factor (dB/m).
 2. Correction Factor (dB/m) = Antenna Factor (dB/m) + Cable Factor (dB).
 3. The other emission levels were very low against the limit.
 4. Margin value = Emission level – Limit value.
 5. “ * “: Fundamental frequency.
 6. The limit value is defined as per 15.247.
 7. "#":The radiated frequency is out the restricted band.



A D T

EUT TEST CONDITION		MEASUREMENT DETAIL	
CHANNEL	Channel 157	FREQUENCY RANGE	1 ~ 40GHz
INPUT POWER (SYSTEM)	120Vac, 60 Hz	DETECTOR FUNCTION	Peak (PK) Average (AV)
ENVIRONMENTAL CONDITIONS	23deg. C, 65%RH 1011 hPa	TESTED BY	Brad Wu

ANTENNA POLARITY & TEST DISTANCE: HORIZONTAL AT 3 M								
NO.	FREQ. (MHz)	EMISSION LEVEL (dBuV/m)	LIMIT (dBuV/m)	MARGIN (dB)	ANTENNA HEIGHT (m)	TABLE ANGLE (Degree)	RAW VALUE (dBuV)	CORRECTION FACTOR (dB/m)
1	*5785.00	103.0 PK			1.04 H	139	65.00	38.00
2	*5785.00	89.2 AV			1.04 H	139	51.20	38.00
3	11570.00	58.4 PK	74.0	-15.6	1.10 H	239	10.50	47.90
4	11570.00	45.1 AV	54.0	-8.9	1.10 H	239	-2.80	47.90

ANTENNA POLARITY & TEST DISTANCE: VERTICAL AT 3 M								
NO.	FREQ. (MHz)	EMISSION LEVEL (dBuV/m)	LIMIT (dBuV/m)	MARGIN (dB)	ANTENNA HEIGHT (m)	TABLE ANGLE (Degree)	RAW VALUE (dBuV)	CORRECTION FACTOR (dB/m)
1	*5785.00	108.2 PK			1.01 V	6	70.20	38.00
2	*5785.00	95.0 AV			1.01 V	6	57.00	38.00
3	11570.00	59.2 PK	74.0	-14.8	1.12 V	209	11.30	47.90
4	11570.00	46.0 AV	54.0	-8.0	1.12 V	209	-1.90	47.90

- REMARKS:**
1. Emission level (dBuV/m) = Raw Value (dBuV) + Correction Factor (dB/m).
 2. Correction Factor (dB/m) = Antenna Factor (dB/m) + Cable Factor (dB).
 3. The other emission levels were very low against the limit.
 4. Margin value = Emission level – Limit value.
 5. “ * ”: Fundamental frequency.
 6. The limit value is defined as per 15.247.



A D T

EUT TEST CONDITION		MEASUREMENT DETAIL	
CHANNEL	Channel 165	FREQUENCY RANGE	1 ~ 40GHz
INPUT POWER (SYSTEM)	120Vac, 60 Hz	DETECTOR FUNCTION	Peak (PK) Average (AV)
ENVIRONMENTAL CONDITIONS	23deg. C, 65%RH 1011 hPa	TESTED BY	Brad Wu

ANTENNA POLARITY & TEST DISTANCE: HORIZONTAL AT 3 M								
NO.	FREQ. (MHz)	EMISSION LEVEL (dBuV/m)	LIMIT (dBuV/m)	MARGIN (dB)	ANTENNA HEIGHT (m)	TABLE ANGLE (Degree)	RAW VALUE (dBuV)	CORRECTION FACTOR (dB/m)
1	*5825.00	102.8 PK			1.05 H	141	64.70	38.10
2	*5825.00	89.0 AV			1.05 H	141	50.90	38.10
3	#5850.00	67.6 PK	82.8	-15.2	1.05 H	141	29.40	38.20
4	#5850.00	49.2 AV	69.0	-19.8	1.05 H	141	11.00	38.20
5	11650.00	58.3 PK	74.0	-15.7	1.01 H	25	10.60	47.70
6	11650.00	45.0 AV	54.0	-9.0	1.01 H	25	-2.70	47.70
ANTENNA POLARITY & TEST DISTANCE: VERTICAL AT 3 M								
NO.	FREQ. (MHz)	EMISSION LEVEL (dBuV/m)	LIMIT (dBuV/m)	MARGIN (dB)	ANTENNA HEIGHT (m)	TABLE ANGLE (Degree)	RAW VALUE (dBuV)	CORRECTION FACTOR (dB/m)
1	*5825.00	107.9 PK			1.03 V	12	69.80	38.10
2	*5825.00	94.7 AV			1.03 V	12	56.60	38.10
3	#5850.00	73.8 PK	87.9	-14.1	1.03 V	12	35.60	38.20
4	#5850.00	54.6 AV	74.7	-20.1	1.03 V	12	16.40	38.20
5	11650.00	59.7 PK	74.0	-14.3	1.14 V	22	12.00	47.70
6	11650.00	46.4 AV	54.0	-7.6	1.14 V	22	-1.30	47.70

- REMARKS:**
1. Emission level (dBuV/m) = Raw Value (dBuV) + Correction Factor (dB/m).
 2. Correction Factor (dB/m) = Antenna Factor (dB/m) + Cable Factor (dB).
 3. The other emission levels were very low against the limit.
 4. Margin value = Emission level – Limit value.
 5. “ * “: Fundamental frequency.
 6. The limit value is defined as per 15.247.
 7. “#“: The radiated frequency is out the restricted band.



A D T

802.11n (20MHz)

EUT TEST CONDITION		MEASUREMENT DETAIL	
CHANNEL	Channel 149	FREQUENCY RANGE	1 ~ 40GHz
INPUT POWER (SYSTEM)	120Vac, 60 Hz	DETECTOR FUNCTION	Peak (PK) Average (AV)
ENVIRONMENTAL CONDITIONS	23deg. C, 65%RH 1011 hPa	TESTED BY	Brad Wu

ANTENNA POLARITY & TEST DISTANCE: HORIZONTAL AT 3 M								
NO.	FREQ. (MHz)	EMISSION LEVEL (dBuV/m)	LIMIT (dBuV/m)	MARGIN (dB)	ANTENNA HEIGHT (m)	TABLE ANGLE (Degree)	RAW VALUE (dBuV)	CORRECTION FACTOR (dB/m)
1	#5725.00	72.8 PK	85.8	-13.0	1.06 H	14	34.80	38.00
2	#5725.00	53.0 AV	69.4	-16.4	1.06 H	14	15.00	38.00
3	*5745.00	105.8 PK			1.06 H	14	67.80	38.00
4	*5745.00	89.4 AV			1.06 H	14	51.40	38.00
5	11490.00	56.8 PK	74.0	-17.2	1.14 H	225	8.80	48.00
6	11490.00	43.5 AV	54.0	-10.5	1.14 H	225	-4.50	48.00

ANTENNA POLARITY & TEST DISTANCE: VERTICAL AT 3 M								
NO.	FREQ. (MHz)	EMISSION LEVEL (dBuV/m)	LIMIT (dBuV/m)	MARGIN (dB)	ANTENNA HEIGHT (m)	TABLE ANGLE (Degree)	RAW VALUE (dBuV)	CORRECTION FACTOR (dB/m)
1	#5725.00	76.2 PK	88.9	-12.7	1.00 V	19	38.20	38.00
2	#5725.00	56.3 AV	72.3	-16.0	1.00 V	19	18.30	38.00
3	*5745.00	108.9 PK			1.00 V	19	70.90	38.00
4	*5745.00	92.3 AV			1.00 V	19	54.30	38.00
5	11490.00	57.2 PK	74.0	-16.8	1.01 V	225	9.20	48.00
6	11490.00	43.9 AV	54.0	-10.1	1.01 V	225	-4.10	48.00

- REMARKS:**
1. Emission level (dBuV/m) = Raw Value (dBuV) + Correction Factor (dB/m).
 2. Correction Factor (dB/m) = Antenna Factor (dB/m) + Cable Factor (dB).
 3. The other emission levels were very low against the limit.
 4. Margin value = Emission level – Limit value.
 5. “ * “: Fundamental frequency.
 6. The limit value is defined as per 15.247.
 7. "#":The radiated frequency is out the restricted band.



A D T

EUT TEST CONDITION		MEASUREMENT DETAIL	
CHANNEL	Channel 157	FREQUENCY RANGE	1 ~ 40GHz
INPUT POWER (SYSTEM)	120Vac, 60 Hz	DETECTOR FUNCTION	Peak (PK) Average (AV)
ENVIRONMENTAL CONDITIONS	23deg. C, 65%RH 1011 hPa	TESTED BY	Brad Wu

ANTENNA POLARITY & TEST DISTANCE: HORIZONTAL AT 3 M								
NO.	FREQ. (MHz)	EMISSION LEVEL (dBuV/m)	LIMIT (dBuV/m)	MARGIN (dB)	ANTENNA HEIGHT (m)	TABLE ANGLE (Degree)	RAW VALUE (dBuV)	CORRECTION FACTOR (dB/m)
1	*5785.00	105.6 PK			1.08 H	15	67.60	38.00
2	*5785.00	89.2 AV			1.08 H	15	51.20	38.00
3	11570.00	57.1 PK	74.0	-16.9	1.11 H	219	9.20	47.90
4	11570.00	43.8 AV	54.0	-10.2	1.11 H	219	-4.10	47.90
ANTENNA POLARITY & TEST DISTANCE: VERTICAL AT 3 M								
NO.	FREQ. (MHz)	EMISSION LEVEL (dBuV/m)	LIMIT (dBuV/m)	MARGIN (dB)	ANTENNA HEIGHT (m)	TABLE ANGLE (Degree)	RAW VALUE (dBuV)	CORRECTION FACTOR (dB/m)
1	*5785.00	108.6 PK			1.01 V	21	70.60	38.00
2	*5785.00	92.0 AV			1.01 V	21	54.00	38.00
3	11570.00	57.8 PK	74.0	-16.2	1.14 V	235	9.90	47.90
4	11570.00	44.5 AV	54.0	-9.5	1.14 V	235	-3.40	47.90

- REMARKS:**
1. Emission level (dBuV/m) = Raw Value (dBuV) + Correction Factor (dB/m).
 2. Correction Factor (dB/m) = Antenna Factor (dB/m) + Cable Factor (dB).
 3. The other emission levels were very low against the limit.
 4. Margin value = Emission level – Limit value.
 5. “ * “: Fundamental frequency.
 6. The limit value is defined as per 15.247.



A D T

EUT TEST CONDITION		MEASUREMENT DETAIL	
CHANNEL	Channel 165	FREQUENCY RANGE	1 ~ 40GHz
INPUT POWER (SYSTEM)	120Vac, 60 Hz	DETECTOR FUNCTION	Peak (PK) Average (AV)
ENVIRONMENTAL CONDITIONS	23deg. C, 65%RH 1011 hPa	TESTED BY	Brad Wu

ANTENNA POLARITY & TEST DISTANCE: HORIZONTAL AT 3 M								
NO.	FREQ. (MHz)	EMISSION LEVEL (dBuV/m)	LIMIT (dBuV/m)	MARGIN (dB)	ANTENNA HEIGHT (m)	TABLE ANGLE (Degree)	RAW VALUE (dBuV)	CORRECTION FACTOR (dB/m)
1	*5825.00	105.5 PK			1.10 H	16	67.40	38.10
2	*5825.00	89.1 AV			1.10 H	16	51.00	38.10
3	#5850.00	65.4 PK	85.5	-20.1	1.10 H	16	27.20	38.20
4	#5850.00	49.6 AV	69.1	-19.5	1.10 H	16	11.40	38.20
5	11650.00	57.3 PK	74.0	-16.7	1.09 H	224	9.60	47.70
6	11650.00	44.0 AV	54.0	-10.0	1.09 H	224	-3.70	47.70
ANTENNA POLARITY & TEST DISTANCE: VERTICAL AT 3 M								
NO.	FREQ. (MHz)	EMISSION LEVEL (dBuV/m)	LIMIT (dBuV/m)	MARGIN (dB)	ANTENNA HEIGHT (m)	TABLE ANGLE (Degree)	RAW VALUE (dBuV)	CORRECTION FACTOR (dB/m)
1	*5825.00	108.7 PK			1.02 V	25	70.60	38.10
2	*5825.00	92.1 AV			1.02 V	25	54.00	38.10
3	#5850.00	68.6 PK	88.7	-20.1	1.09 V	9	30.40	38.20
4	#5850.00	52.7 AV	72.1	-19.4	1.09 V	9	14.50	38.20
5	11650.00	57.5 PK	74.0	-16.5	1.12 V	246	9.80	47.70
6	11650.00	44.2 AV	54.0	-9.8	1.12 V	246	-3.50	47.70

- REMARKS:**
1. Emission level (dBuV/m) = Raw Value (dBuV) + Correction Factor (dB/m).
 2. Correction Factor (dB/m) = Antenna Factor (dB/m) + Cable Factor (dB).
 3. The other emission levels were very low against the limit.
 4. Margin value = Emission level – Limit value.
 5. “ * “: Fundamental frequency.
 6. The limit value is defined as per 15.247.
 7. “#“: The radiated frequency is out the restricted band.



A D T

802.11n (40MHz)

EUT TEST CONDITION		MEASUREMENT DETAIL	
CHANNEL	Channel 151	FREQUENCY RANGE	1 ~ 40GHz
INPUT POWER (SYSTEM)	120Vac, 60 Hz	DETECTOR FUNCTION	Peak (PK) Average (AV)
ENVIRONMENTAL CONDITIONS	23deg. C, 65%RH 1011 hPa	TESTED BY	Brad Wu

ANTENNA POLARITY & TEST DISTANCE: HORIZONTAL AT 3 M								
NO.	FREQ. (MHz)	EMISSION LEVEL (dBuV/m)	LIMIT (dBuV/m)	MARGIN (dB)	ANTENNA HEIGHT (m)	TABLE ANGLE (Degree)	RAW VALUE (dBuV)	CORRECTION FACTOR (dB/m)
1	#5725.00	69.8 PK	81.3	-11.5	1.18 H	9	31.80	38.00
2	#5725.00	54.2 AV	63.5	-9.3	1.18 H	9	16.20	38.00
3	*5755.00	101.3 PK			1.18 H	9	63.30	38.00
4	*5755.00	83.5 AV			1.18 H	9	45.50	38.00
5	11510.00	58.1 PK	74.0	-15.9	1.02 H	29	10.10	48.00
6	11510.00	45.0 AV	54.0	-9.0	1.02 H	29	-3.00	48.00

ANTENNA POLARITY & TEST DISTANCE: VERTICAL AT 3 M								
NO.	FREQ. (MHz)	EMISSION LEVEL (dBuV/m)	LIMIT (dBuV/m)	MARGIN (dB)	ANTENNA HEIGHT (m)	TABLE ANGLE (Degree)	RAW VALUE (dBuV)	CORRECTION FACTOR (dB/m)
1	#5725.00	73.2 PK	84.9	-11.7	1.00 V	15	35.20	38.00
2	#5725.00	57.7 AV	66.9	-9.2	1.00 V	15	19.70	38.00
3	*5755.00	104.9 PK			1.00 V	15	66.90	38.00
4	*5755.00	86.9 AV			1.00 V	15	48.90	38.00
5	11510.00	58.5 PK	74.0	-15.5	1.03 V	256	10.50	48.00
6	11510.00	45.4 AV	54.0	-8.6	1.03 V	256	-2.60	48.00

- REMARKS:**
1. Emission level (dBuV/m) = Raw Value (dBuV) + Correction Factor (dB/m).
 2. Correction Factor (dB/m) = Antenna Factor (dB/m) + Cable Factor (dB).
 3. The other emission levels were very low against the limit.
 4. Margin value = Emission level – Limit value.
 5. “ * “: Fundamental frequency.
 6. The limit value is defined as per 15.247.
 7. "#":The radiated frequency is out the restricted band.



A D T

EUT TEST CONDITION		MEASUREMENT DETAIL	
CHANNEL	Channel 159	FREQUENCY RANGE	1 ~ 40GHz
INPUT POWER (SYSTEM)	120Vac, 60 Hz	DETECTOR FUNCTION	Peak (PK) Average (AV)
ENVIRONMENTAL CONDITIONS	23deg. C, 65%RH 1011 hPa	TESTED BY	Brad Wu

ANTENNA POLARITY & TEST DISTANCE: HORIZONTAL AT 3 M								
NO.	FREQ. (MHz)	EMISSION LEVEL (dBuV/m)	LIMIT (dBuV/m)	MARGIN (dB)	ANTENNA HEIGHT (m)	TABLE ANGLE (Degree)	RAW VALUE (dBuV)	CORRECTION FACTOR (dB/m)
1	*5795.00	102.1 PK			1.16 H	11	64.00	38.10
2	*5795.00	84.3 AV			1.16 H	11	46.20	38.10
3	#5850.00	60.8 PK	82.1	-21.3	1.16 H	11	22.60	38.20
4	#5850.00	45.2 AV	64.3	-19.1	1.16 H	11	7.00	38.20
5	11590.00	57.5 PK	74.0	-16.5	1.10 H	62	9.60	47.90
6	11590.00	44.5 AV	54.0	-9.5	1.10 H	62	-3.40	47.90
ANTENNA POLARITY & TEST DISTANCE: VERTICAL AT 3 M								
NO.	FREQ. (MHz)	EMISSION LEVEL (dBuV/m)	LIMIT (dBuV/m)	MARGIN (dB)	ANTENNA HEIGHT (m)	TABLE ANGLE (Degree)	RAW VALUE (dBuV)	CORRECTION FACTOR (dB/m)
1	*5795.00	105.9 PK			1.01 V	16	67.80	38.10
2	*5795.00	87.8 AV			1.01 V	16	49.70	38.10
3	#5850.00	64.1 PK	85.9	-21.8	1.14 V	250	25.90	38.20
4	#5850.00	48.6 AV	67.8	-19.2	1.14 V	250	10.40	38.20
5	11590.00	59.0 PK	74.0	-15.0	1.02 V	243	11.10	47.90
6	11590.00	45.9 AV	54.0	-8.1	1.02 V	243	-2.00	47.90

- REMARKS:**
1. Emission level (dBuV/m) = Raw Value (dBuV) + Correction Factor (dB/m).
 2. Correction Factor (dB/m) = Antenna Factor (dB/m) + Cable Factor (dB).
 3. The other emission levels were very low against the limit.
 4. Margin value = Emission level – Limit value.
 5. “ * “: Fundamental frequency.
 6. The limit value is defined as per 15.247.
 7. “#“: The radiated frequency is out the restricted band.



A D T

BELOW 1GHz WORST-CASE DATA : 802.11n (20MHz)

EUT TEST CONDITION		MEASUREMENT DETAIL	
CHANNEL	Channel 157	FREQUENCY RANGE	Below 1000MHz
INPUT POWER (SYSTEM)	120Vac, 60 Hz	DETECTOR FUNCTION	Quasi-Peak
ENVIRONMENTAL CONDITIONS	24deg. C, 66%RH 1008 hPa	TESTED BY	Brad Wu

ANTENNA POLARITY & TEST DISTANCE: HORIZONTAL AT 3 M								
NO.	FREQ. (MHz)	EMISSION LEVEL (dBuV/m)	LIMIT (dBuV/m)	MARGIN (dB)	ANTENNA HEIGHT (m)	TABLE ANGLE (Degree)	RAW VALUE (dBuV)	CORRECTION FACTOR (dB/m)
1	31.84	29.2 QP	40.0	-10.8	2.00 H	10	16.10	13.10
2	284.60	39.0 QP	46.0	-7.0	1.00 H	313	25.20	13.80
3	675.40	38.6 QP	46.0	-7.4	1.00 H	10	14.10	24.50
4	764.84	43.4 QP	46.0	-2.6	1.50 H	10	17.70	25.70
5	795.95	42.4 QP	46.0	-3.6	1.50 H	10	16.40	26.00
6	961.21	41.7 QP	54.0	-12.3	1.50 H	271	13.00	28.70
ANTENNA POLARITY & TEST DISTANCE: VERTICAL AT 3 M								
NO.	FREQ. (MHz)	EMISSION LEVEL (dBuV/m)	LIMIT (dBuV/m)	MARGIN (dB)	ANTENNA HEIGHT (m)	TABLE ANGLE (Degree)	RAW VALUE (dBuV)	CORRECTION FACTOR (dB/m)
1	249.60	36.3 QP	46.0	-9.7	1.00 V	172	22.40	13.90
2	366.26	33.9 QP	46.0	-12.1	2.00 V	10	17.20	16.70
3	675.40	38.0 QP	46.0	-8.0	2.00 V	13	13.50	24.50
4	764.84	42.4 QP	46.0	-3.6	1.50 V	37	16.70	25.70
5	795.95	40.0 QP	46.0	-6.0	1.00 V	37	14.00	26.00
6	960.00	37.1 QP	46.0	-8.9	2.00 V	25	8.40	28.70

- REMARKS:**
1. Emission level (dBuV/m) = Raw Value (dBuV) + Correction Factor (dB/m).
 2. Correction Factor (dB/m) = Antenna Factor (dB/m) + Cable Factor (dB).
 3. The other emission levels were very low against the limit.
 4. Margin value = Emission level – Limit value.



5.2 CONDUCTED EMISSION MEASUREMENT

5.2.1 LIMITS OF CONDUCTED EMISSION MEASUREMENT

FREQUENCY OF EMISSION (MHz)	CONDUCTED LIMIT (dBµV)	
	Quasi-peak	Average
0.15 ~ 0.5	66 to 56	56 to 46
0.5 ~ 5	56	46
5 ~ 30	60	50

- NOTE:**
1. The lower limit shall apply at the transition frequencies.
 2. The limit decreases in line with the logarithm of the frequency in the range of 0.15 to 0.50MHz.
 3. All emanations from a class A/B digital device or system, including any network of conductors and apparatus connected thereto, shall not exceed the level of field strengths specified above.

5.2.2 TEST INSTRUMENTS

DESCRIPTION & MANUFACTURER	MODEL NO.	SERIAL NO.	DATE OF CALIBRATION	DUE DATE OF CALIBRATION
Test Receiver ROHDE & SCHWARZ	ESCS30	100288	Sep. 24, 2009	Sep. 23, 2010
RF signal cable Woken	5D-FB	Cable-HYCO2-01	Dec. 31, 2009	Dec. 30, 2010
LISN ROHDE & SCHWARZ	ESH2-Z5	100100	Aug. 24, 2009	Aug. 23, 2010
LISN ROHDE & SCHWARZ	ESH3-Z5	100311	Jul. 29, 2009	Jul. 28, 2010
Software ADT	ADT_Cond_ V7.3.7	NA	NA	NA

- NOTE:**
1. The calibration interval of the above test instruments is 12 months and the calibrations are traceable to NML/ROC and NIST/USA.
 2. The test was performed in HwaYa Shielded Room 2.
 3. The VCCI Site Registration No. is C-2047.



A D T

5.2.3 TEST PROCEDURES

- a. The EUT was placed 0.4 meters from the conducting wall of the shielded room with EUT being connected to the power mains through a line impedance stabilization network (LISN). Other support units were connected to the power mains through another LISN. The two LISNs provide 50 ohm/ 50uH of coupling impedance for the measuring instrument.
- b. Both lines of the power mains connected to the EUT were checked for maximum conducted interference.
- c. The frequency range from 150kHz to 30MHz was searched. Emission levels under (Limit - 20dB) was not recorded.

5.2.4 DEVIATION FROM TEST STANDARD

No deviation.

5.2.5 TEST SETUP

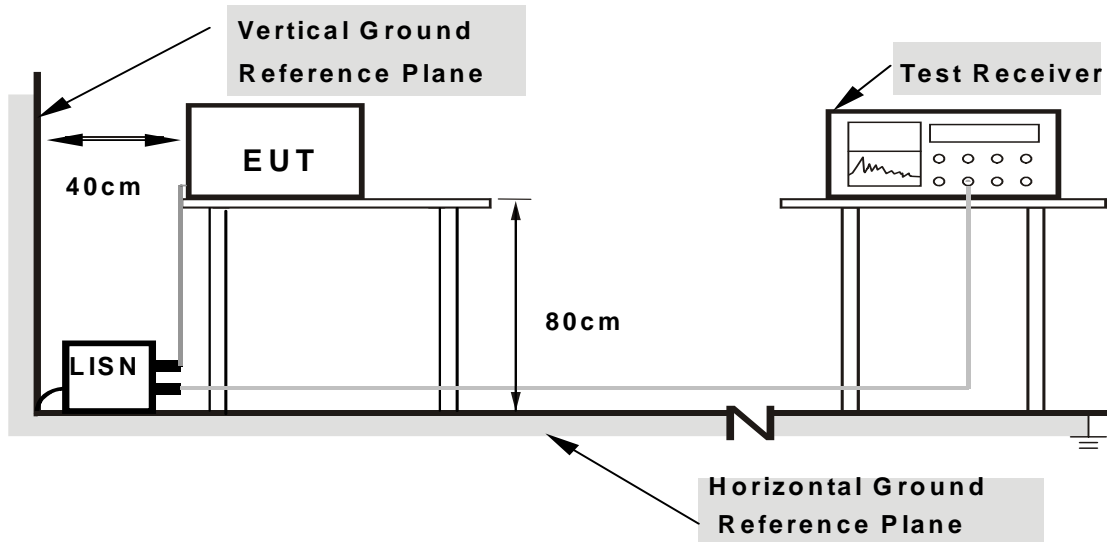

Note: 1.Support units were connected to second LISN.

2.Both of LISNs (AMN) are 80 cm from EUT and at least 80 from other units and other metal planes

For the actual test configuration, please refer to the attached file (Test Setup Photo).

5.2.6 EUT OPERATING CONDITIONS

Same as 4.1.6

5.2.7 TEST RESULTS

CONDUCTED WORST-CASE DATA : 802.11n (20MHz)

PHASE	Line 1	6dB BANDWIDTH	9kHz
-------	--------	---------------	------

No	Freq. [MHz]	Corr. Factor (dB)	Reading Value		Emission Level		Limit		Margin	
			[dB (uV)]		[dB (uV)]		[dB (uV)]		(dB)	
			Q.P.	AV.	Q.P.	AV.	Q.P.	AV.	Q.P.	AV.
1	0.152	0.16	52.07	-	52.23	-	65.90	55.90	-13.68	-
2	0.302	0.17	34.80	-	34.97	-	60.18	50.18	-25.21	-
3	0.591	0.20	28.80	-	29.00	-	56.00	46.00	-27.00	-
4	0.927	0.22	25.02	-	25.24	-	56.00	46.00	-30.76	-
5	17.582	0.60	28.16	-	28.76	-	60.00	50.00	-31.24	-
6	19.613	0.68	25.93	-	26.61	-	60.00	50.00	-33.39	-

- REMARKS:**
1. Q.P. and AV. are abbreviations of quasi-peak and average individually.
 2. "-": The Quasi-peak reading value also meets average limit and measurement with the average detector is unnecessary.
 3. The emission levels of other frequencies were very low against the limit.
 4. Margin value = Emission level - Limit value
 5. Correction factor = Insertion loss + Cable loss
 6. Emission Level = Correction Factor + Reading Value.

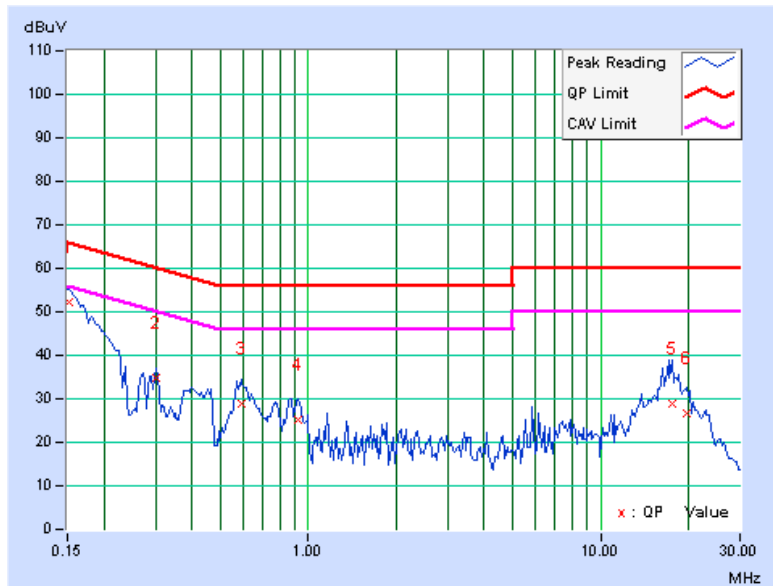

PHASE	Line 2	6dB BANDWIDTH	9kHz
-------	--------	---------------	------

No	Freq. [MHz]	Corr. Factor (dB)	Reading Value		Emission Level		Limit		Margin	
			[dB (uV)]		[dB (uV)]		[dB (uV)]		(dB)	
			Q.P.	AV.	Q.P.	AV.	Q.P.	AV.	Q.P.	AV.
1	0.153	0.13	50.57	-	50.70	-	65.85	55.85	-15.15	-
2	0.302	0.15	36.76	-	36.91	-	60.18	50.18	-23.27	-
3	0.459	0.17	32.28	-	32.45	-	56.72	46.72	-24.27	-
4	0.591	0.18	31.21	-	31.39	-	56.00	46.00	-24.61	-
5	0.869	0.21	28.52	-	28.73	-	56.00	46.00	-27.27	-
6	16.871	0.76	29.75	-	30.51	-	60.00	50.00	-29.49	-

- REMARKS:**
1. Q.P. and AV. are abbreviations of quasi-peak and average individually.
 2. "-": The Quasi-peak reading value also meets average limit and measurement with the average detector is unnecessary.
 3. The emission levels of other frequencies were very low against the limit.
 4. Margin value = Emission level - Limit value
 5. Correction factor = Insertion loss + Cable loss
 6. Emission Level = Correction Factor + Reading Value.

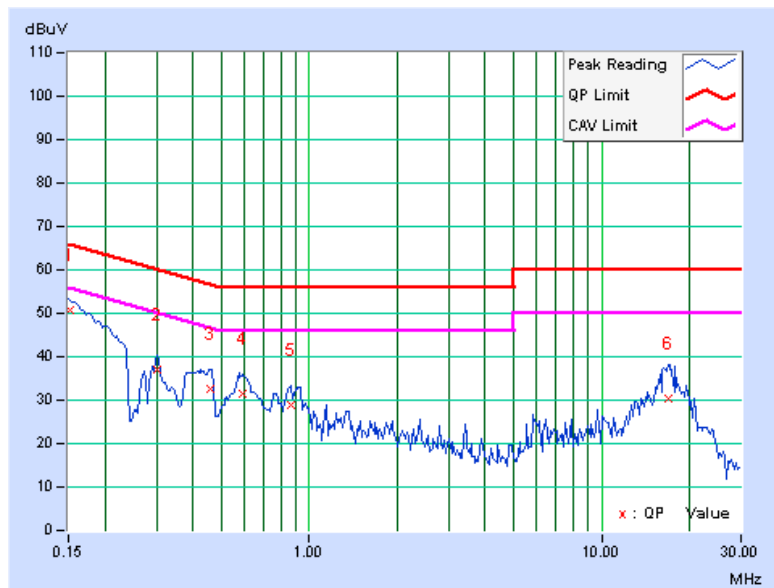



A D T

5.3 6dB BANDWIDTH MEASUREMENT

5.3.1 LIMITS OF 6dB BANDWIDTH MEASUREMENT

The minimum of 6dB Bandwidth Measurement is 0.5MHz.

5.3.2 TEST INSTRUMENTS

DESCRIPTION & MANUFACTURER	MODEL NO.	SERIAL NO.	DATE OF CALIBRATION	CALIBRATED UNTIL
R&S SPECTRUM ANALYZER	FSP40	100040	Jul. 07, 2009	Jul. 06, 2010

NOTE: The calibration interval of the above test instruments is 12 months and the calibrations are traceable to NML/ROC and NIST/USA.

5.3.3 TEST PROCEDURE

The transmitter output was connected to the spectrum analyzer through an attenuator. The bandwidth of the fundamental frequency was measured by spectrum analyzer with 100kHz RBW and 300kHz VBW. The 6dB bandwidth is defined as the total spectrum the power of which is higher than peak power minus 6dB.

5.3.4 DEVIATION FROM TEST STANDARD

No deviation

5.3.5 TEST SETUP

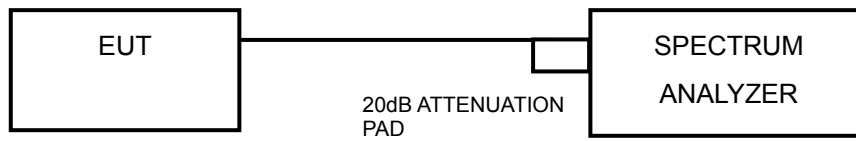

5.3.6 EUT OPERATING CONDITIONS

The software provided by client to enable the EUT under transmission condition continuously at lowest, middle and highest channel frequencies individually.



A D T

5.3.7 TEST RESULTS

802.11a

CHANNEL	CHANNEL FREQUENCY (MHz)	6dB BANDWIDTH (MHz)	MINIMUM LIMIT (MHz)	PASS / FAIL
149	5745	16.43	0.5	PASS
157	5785	16.46	0.5	PASS
165	5825	16.44	0.5	PASS

CH 157

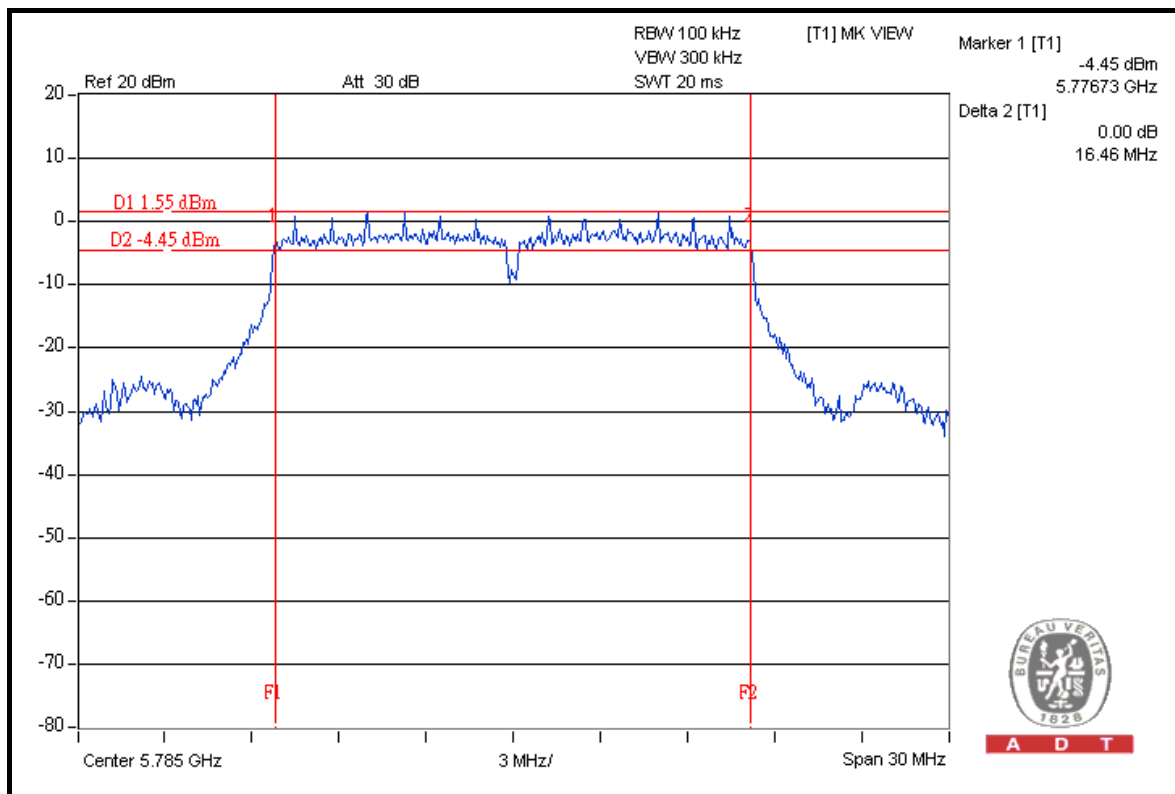



A D T

802.11n (20MHz)

CHANNEL	CHANNEL FREQUENCY (MHz)	6dB BANDWIDTH (MHz)		MINIMUM LIMIT (MHz)	PASS / FAIL
		CHAIN 0	CHAIN 1		
149	5745	17.62	17.65	0.5	PASS
157	5785	17.59	17.62	0.5	PASS
165	5825	17.56	17.67	0.5	PASS

FOR CHAIN 1: CH 165

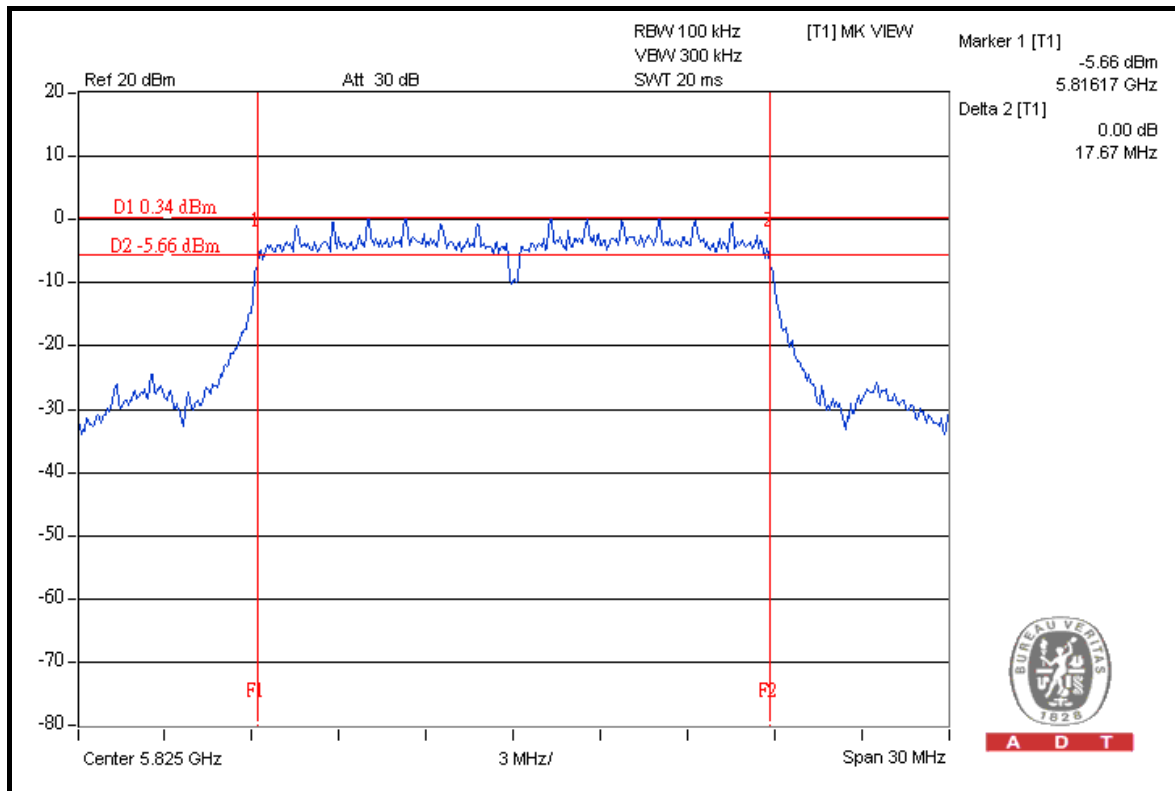



A D T

802.11n (40MHz)

CHANNEL	CHANNEL FREQUENCY (MHz)	6dB BANDWIDTH (MHz)		MINIMUM LIMIT (MHz)	PASS / FAIL
		CHAIN 0	CHAIN 1		
151	5755	36.39	35.98	0.5	PASS
159	5795	36.42	36.42	0.5	PASS

FOR CHAIN 1: CH 159

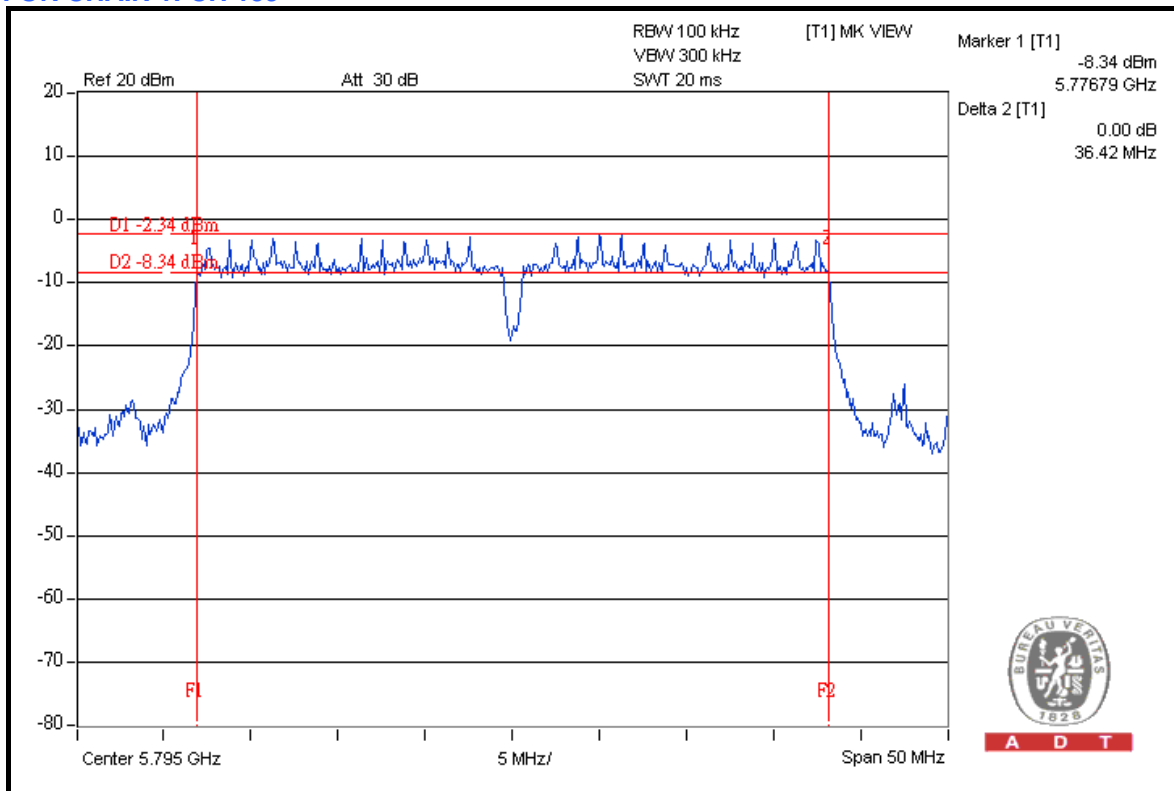

A D T



A D T

5.4 MAXIMUM OUTPUT POWER

5.4.1 LIMITS OF MAXIMUM OUTPUT POWER MEASUREMENT

The Maximum Output Power Measurement is 30dBm.

5.4.2 INSTRUMENTS

DESCRIPTION & MANUFACTURER	MODEL NO.	SERIAL NO.	DATE OF CALIBRATION	DUE DATE OF CALIBRATION
High Speed Peak Power Meter	ML2495A	0824012	Aug. 10, 2009	Aug. 09, 2010
Power Sensor	MA2411B	0738138	Aug. 10, 2009	Aug. 09, 2010

NOTE:

1. The calibration interval of the above test instruments is 12 months and the calibrations are traceable to NML/ROC and NIST/USA.
2. Measurement Bandwidth of ML2495A is 65MHz greater than 6dB bandwidth of emission.

5.4.3 TEST PROCEDURE

A power sensor was used on the output port of the EUT. A power meter was used to read the response of the power sensor. Record the power level.

5.4.4 DEVIATION FROM TEST STANDARD

No deviation.

5.4.5 TEST SETUP

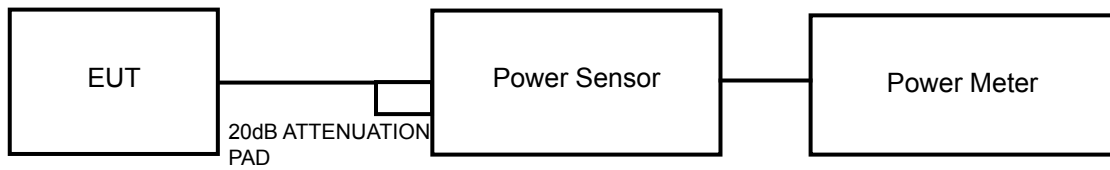

5.4.6 EUT OPERATING CONDITIONS

Same as Item 5.3.6



5.4.7 TEST RESULTS

802.11a

CHAN.	CHANNEL FREQUENCY (MHz)	POWER OUTPUT (mW)	POWER OUTPUT (dBm)	POWER LIMIT (dBm)	PASS/FAIL
149	5745	208.9	23.2	30	PASS
157	5785	199.5	23.0	30	PASS
165	5825	213.8	23.3	30	PASS

802.11n (20MHz)

CHAN.	CHAN. FREQ. (MHz)	POWER OUTPUT (dBm)		TOTAL POWER (mW)	TOTAL POWER (dBm)	POWER LIMIT (dBm)	PASS / FAIL
		CHAIN 0	CHAIN 1				
149	5745	22.0	22.1	320.7	25.1	30	PASS
157	5785	22.1	22.2	328.1	25.2	30	PASS
165	5825	22.2	22.0	324.4	25.1	30	PASS

802.11n (40MHz)

CHAN.	CHAN. FREQ. (MHz)	POWER OUTPUT (dBm)		TOTAL POWER (mW)	TOTAL POWER (dBm)	POWER LIMIT (dBm)	PASS / FAIL
		CHAIN 0	CHAIN 1				
151	5755	22.0	22.1	320.7	25.1	30	PASS
159	5795	22.1	22.2	328.1	25.2	30	PASS



5.5 POWER SPECTRAL DENSITY MEASUREMENT

5.5.1 LIMITS OF POWER SPECTRAL DENSITY MEASUREMENT

The Maximum of Power Spectral Density Measurement is 8dBm.

5.5.2 TEST INSTRUMENTS

DESCRIPTION & MANUFACTURER	MODEL NO.	SERIAL NO.	DATE OF CALIBRATION	CALIBRATED UNTIL
R&S SPECTRUM ANALYZER	FSP40	100040	Jul. 07, 2009	Jul. 06, 2010

NOTE: The calibration interval of the above test instruments is 12 months and the calibrations are traceable to NML/ROC and NIST/USA.

5.5.3 TEST PROCEDURE

1. Follow DTS measurement (PSD Option 2), the transmitter output was connected to the spectrum analyzer through an attenuator, the bandwidth of the fundamental frequency was measured with the spectrum analyzer. Locate and zoom in on emission peak(s) within the pass band.
2. Set RBW = 3 kHz /VBW > 9 kHz and sweep time to Automatic.
3. Detector use peak mode and a video trigger with the trigger level set to enable triggering only on full power pulses.
4. Trace average 100 traces in power averaging mode. The power spectral density was measured and recorded.

5.5.4 DEVIATION FROM TEST STANDARD

No deviation.

5.5.5 TEST SETUP

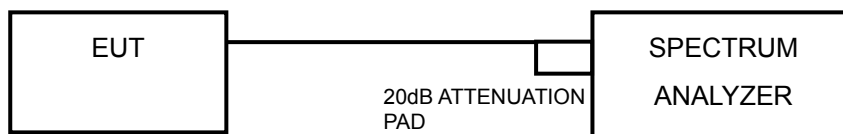

5.5.6 EUT OPERATING CONDITION

Same as Item 5.3.6.



A D T

5.5.7 TEST RESULTS

802.11a

CHANNEL	CHANNEL FREQUENCY (MHz)	RF POWER LEVEL IN 3 kHz BW (dBm)	MAXIMUM LIMIT (dBm)	PASS/FAIL
149	5745	-12.1	8	PASS
157	5785	-12.5	8	PASS
165	5825	-12.0	8	PASS

CH 165

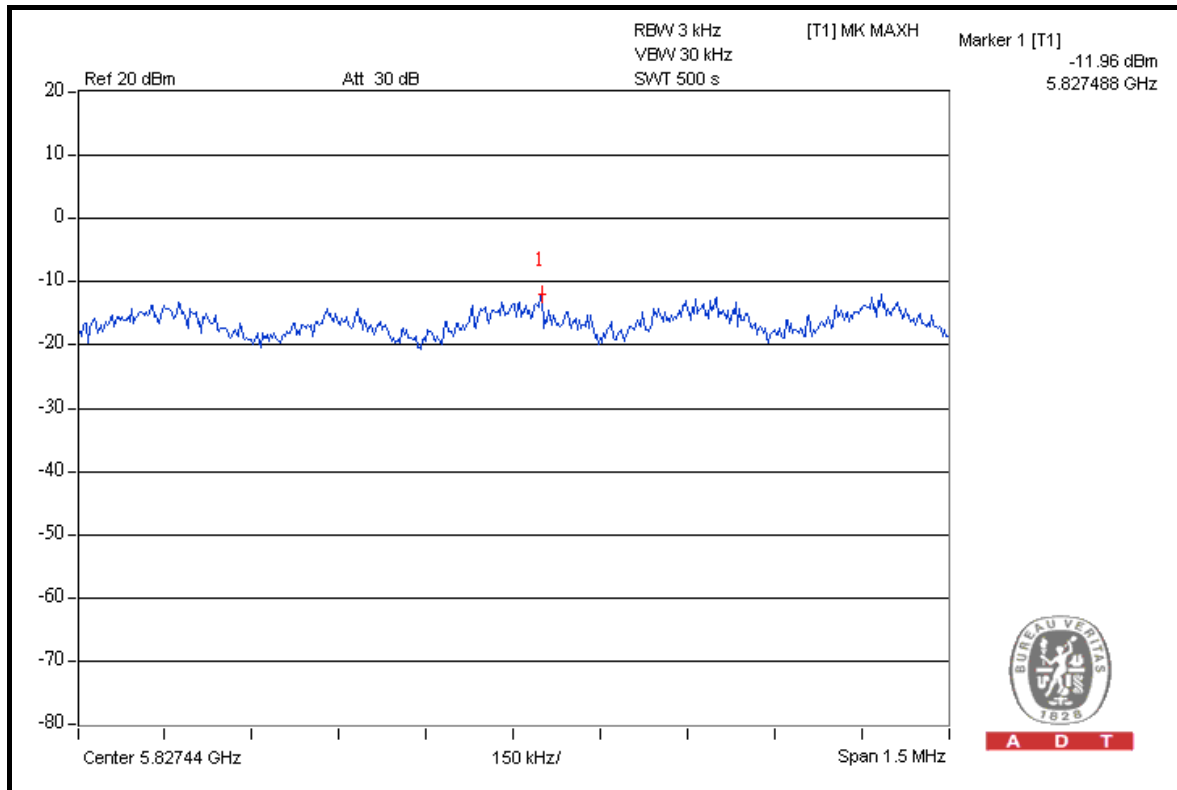



A D T

802.11n (20MHz)

CHAN.	CHAN. FREQ. (MHz)	RF POWER LEVEL IN 3kHz BW (dBm)		TOTAL POWER DENSITY (dBm)	MAX. LIMIT (dBm)	PASS / FAIL
		CHAIN 0	CHAIN 1			
149	5745	-13.6	-14.7	-11.1	8	PASS
157	5785	-13.6	-14.8	-11.1	8	PASS
165	5825	-13.2	-15.0	-11.0	8	PASS

FOR CHAIN 0: CH 165

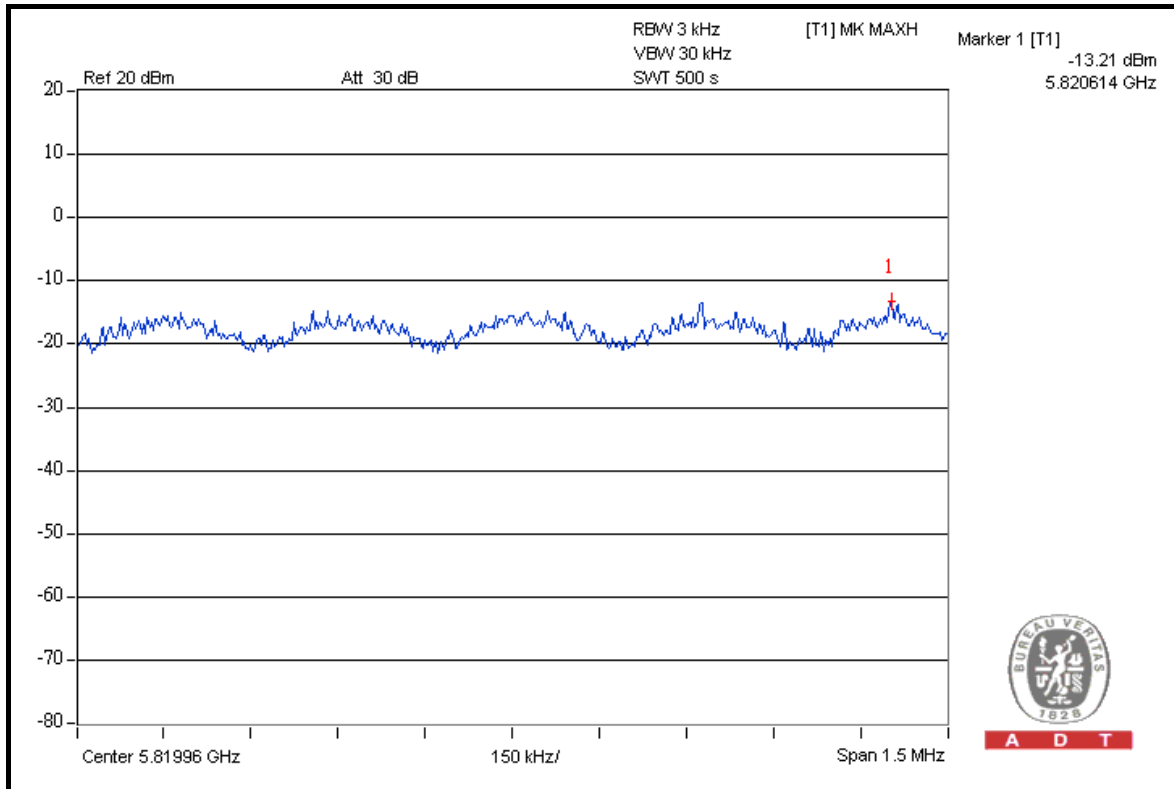



A D T

802.11n (40MHz)

CHAN.	CHAN. FREQ. (MHz)	RF POWER LEVEL IN 3kHz BW (dBm)		TOTAL POWER DENSITY (dBm)	MAX. LIMIT (dBm)	PASS / FAIL
		CHAIN 0	CHAIN 1			
151	5755	-16.2	-17.8	-13.9	8	PASS
159	5795	-15.9	-17.8	-13.7	8	PASS

FOR CHAIN 0: CH 159

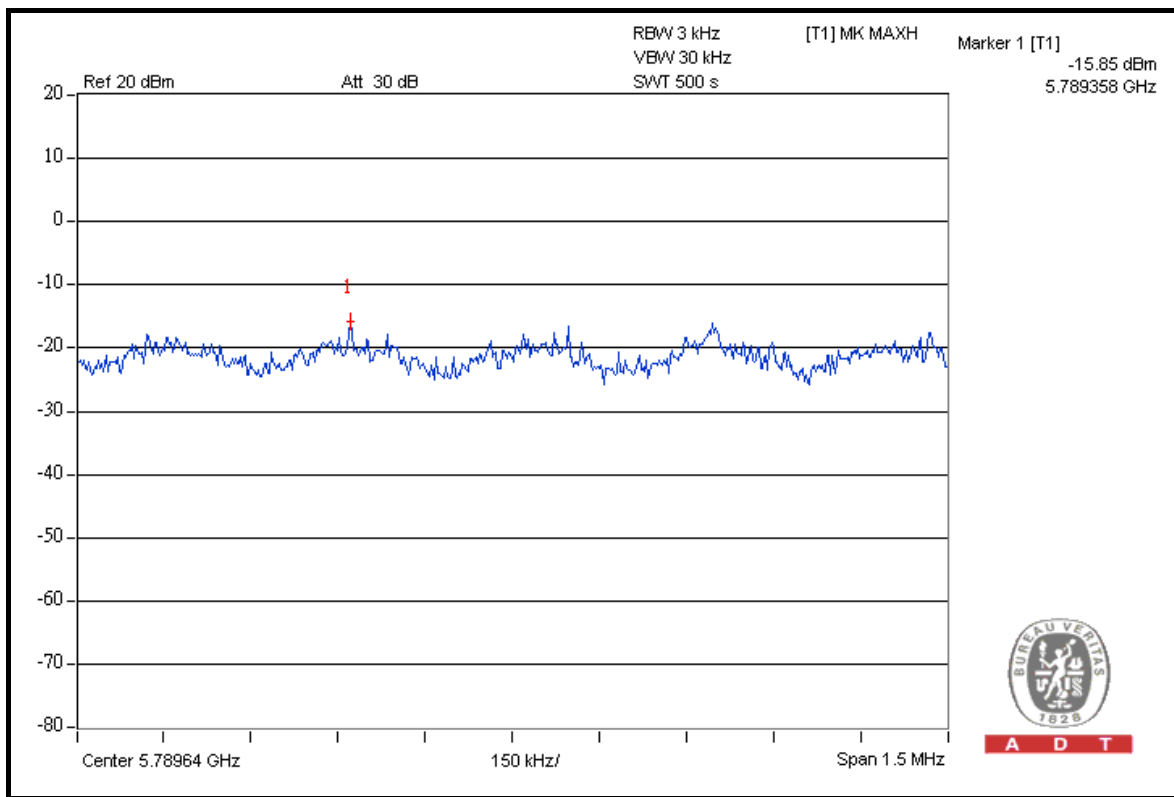

A D T



A D T

5.6 BAND EDGES MEASUREMENT

5.6.1 LIMITS OF BAND EDGES MEASUREMENT

Below -20 dB of the highest emission level of operating band (in 100kHz Resolution Bandwidth).

Note: Follow DTS measurement, If the device complies with the use of power option 2 the attenuation under this paragraph shall be 30 dB instead of 20 dB.



A D T

5.6.2 TEST INSTRUMENTS

DESCRIPTION & MANUFACTURER	MODEL NO.	SERIAL NO.	DATE OF CALIBRATION	DUE DATE OF CALIBRATION
FOR CONDUCTED MEASUREMENT				
R&S SPECTRUM ANALYZER	FSP40	100040	Jul. 07, 2009	Jul. 06, 2010
FOR RADIATED MEASUREMENT				
Test Receiver ROHDE & SCHWARZ	ESI7	100033	Jul. 06, 2009	Jul. 05, 2010
Spectrum Analyzer ROHDE & SCHWARZ	FSP40	100076	May 26, 2009	May 25, 2010
BILOG Antenna SCHWARZBECK	VULB9168	9168-160	Apr. 27, 2009	Apr. 26, 2010
HORN Antenna SCHWARZBECK	9120D	9120D-209	Jul. 01, 2009	Jun. 30, 2010
HORN Antenna SCHWARZBECK	BBHA 9170	BBHA9170243	Dec. 25, 2009	Dec. 24, 2010
Preamplifier Agilent	8447D	2944A10633	Nov. 10, 2009	Nov. 09, 2010
Preamplifier Agilent	8449B	3008A01964	Nov. 09, 2009	Nov. 08, 2010
RF signal cable HUBER+SUHNNER	SUCOFLEX 104	238141/4	May 13, 2009	May 12, 2010
RF signal cable HUBER+SUHNNER	SUCOFLEX 104	12738/6	May 13, 2009	May 12, 2010
Software ADT.	ADT_Radiated_ V7.6.15.9.2	NA	NA	NA
Antenna Tower inn-co GmbH	MA 4000	013303	NA	NA
Antenna Tower Controller inn-co GmbH	CO2000	017303	NA	NA
Turn Table ADT.	TT100.	TT93021703	NA	NA
Turn Table Controller ADT.	SC100.	SC93021703	NA	NA
26GHz ~ 40GHz Amplifier	EM26400	07026401	Aug. 27, 2009	Aug. 26, 2010

NOTE: The calibration interval of the above test instruments is 12 months and the calibrations are traceable to NML/ROC and NIST/USA.



A D T

5.6.3 TEST PROCEDURE

FOR CONDUCTED MEASUREMENT

The transmitter output was connected to the spectrum analyzer via a low loss cable. Set both RBW and VBW of spectrum analyzer to 100kHz and 300kHz with suitable frequency span including 100MHz bandwidth from band edge. The band edges was measured and recorded.

The spectrum plots (Peak RBW = 100kHz, VBW = 300kHz; Average RBW = 1MHz, VBW = 10Hz) are attached on the following pages.

FOR RADIATED MEASUREMENT

- a. The EUT was placed on the top of a rotating table 0.8 meters above the ground at a 3 meter semi-anechoic chamber. The table was rotated 360 degrees to determine the position of the highest radiation.
- b. The EUT was set 3 meters away from the interference-receiving antenna, which was mounted on the top of a variable-height antenna tower.
- c. The antenna is a broadband antenna, and its height is varied from one meter to four meters above the ground to determine the maximum value of the field strength. Both horizontal and vertical polarizations of the antenna are set to make the measurement.
- d. For each suspected emission, the EUT was arranged to its worst case and then the antenna was tuned to heights from 1 meter to 4 meters and the rotatable table was turned from 0 degrees to 360 degrees to find the maximum reading.
- e. Set both RBW and VBW of spectrum analyzer to 100kHz and 300kHz with suitable frequency span including 100MHz bandwidth from band edge. The band edges was measured and recorded.

NOTE: The resolution bandwidth of test receiver/spectrum analyzer is 1MHz and the video bandwidth is 10Hz for Average detection (AV) at frequency above 1GHz.

5.6.4 DEVIATION FROM TEST STANDARD

No deviation



A D T

5.6.5 EUT OPERATING CONDITION

Same as Item 5.3.6

5.6.6 TEST RESULTS

The spectrum plots are attached on the following pages. D1 line indicates the highest level, D2 line indicates the 20dB offset below D1. It shows compliance with the requirement in part 15.247(d).



A D T

802.11a

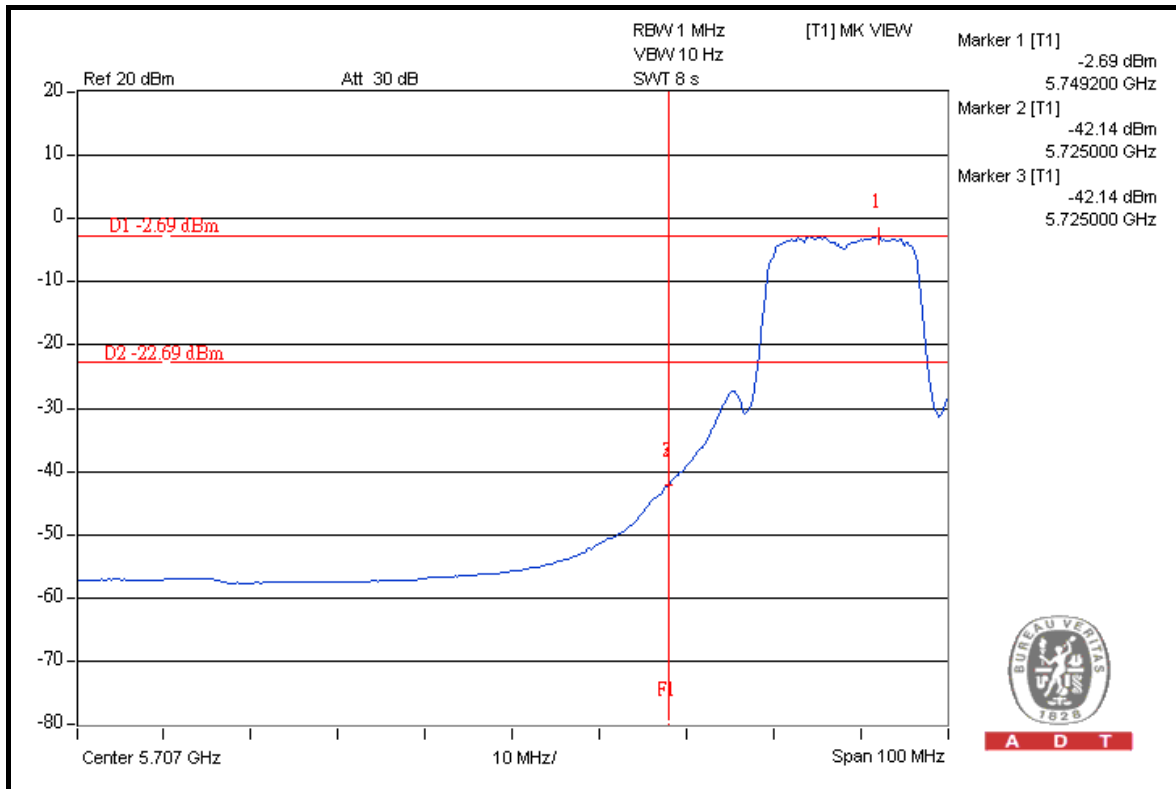
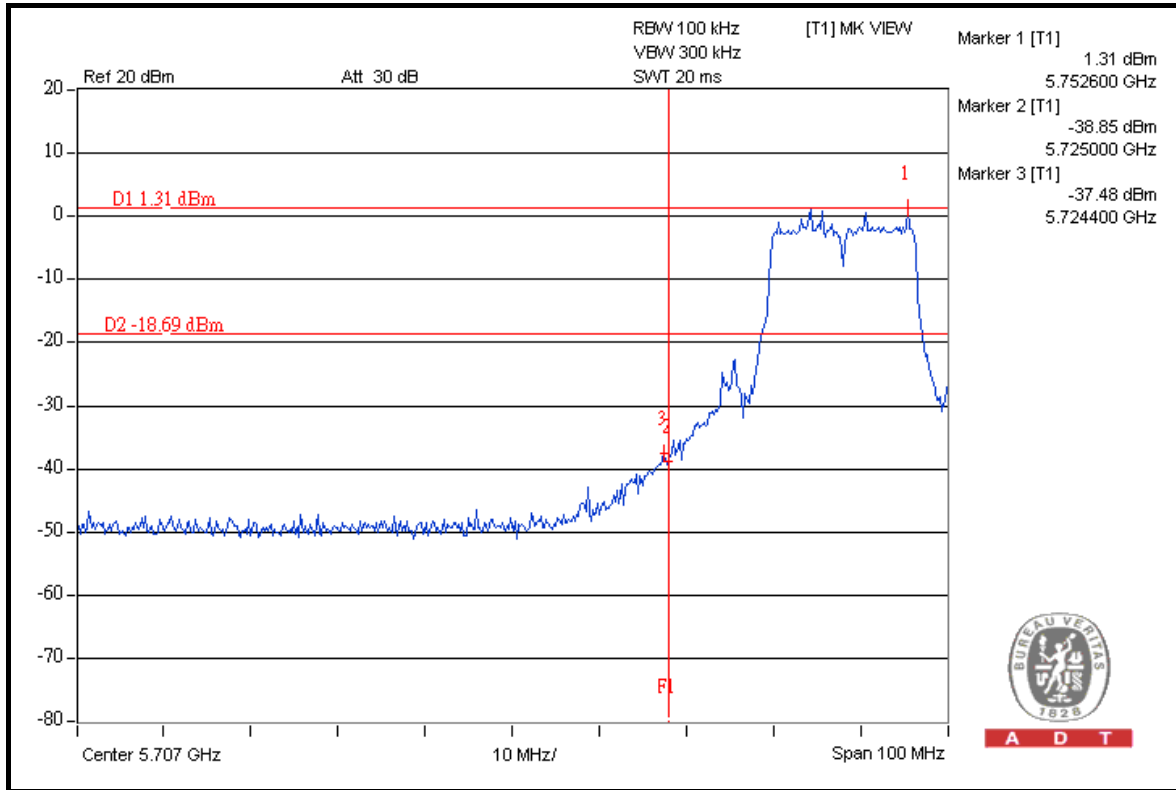



A D T

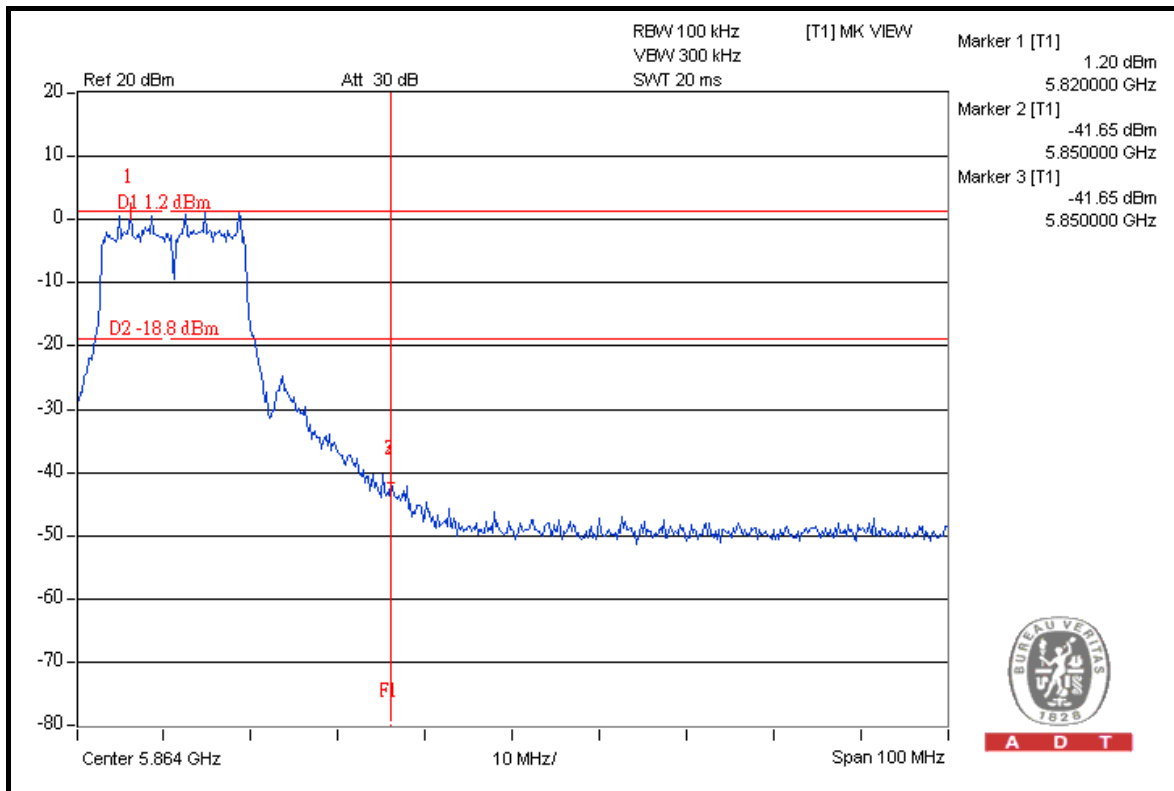
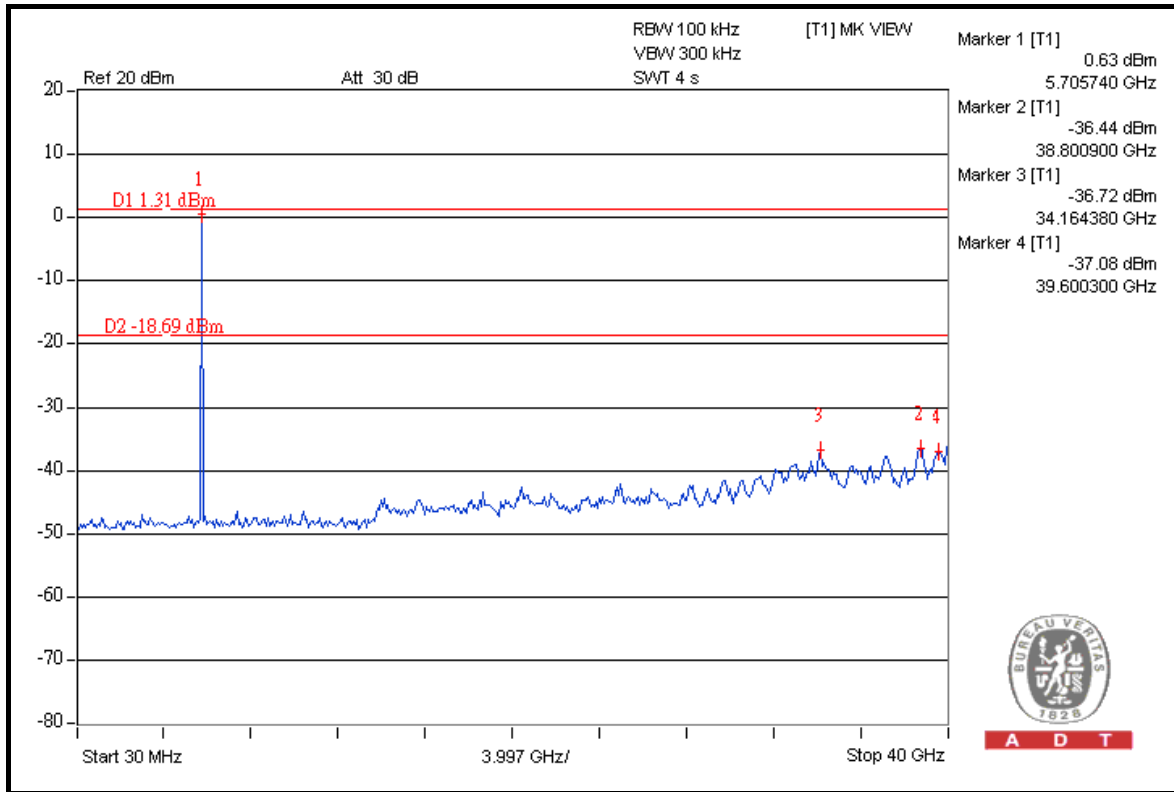



A D T

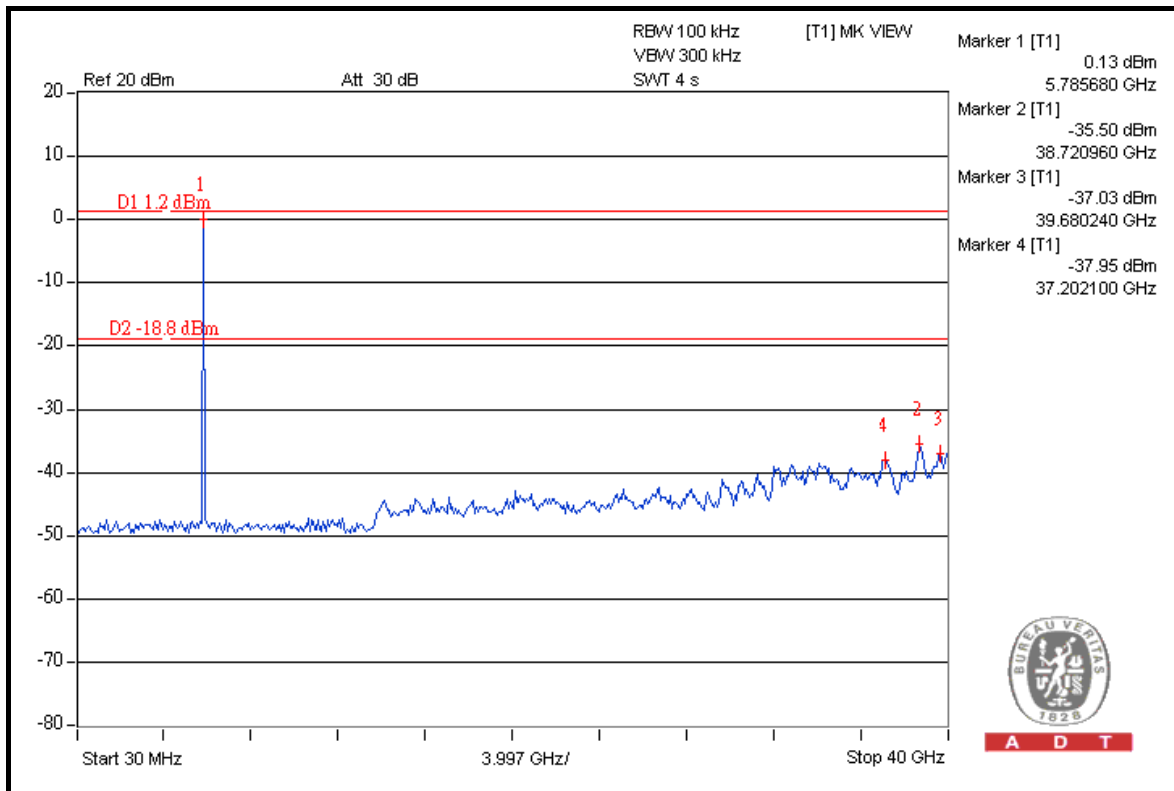
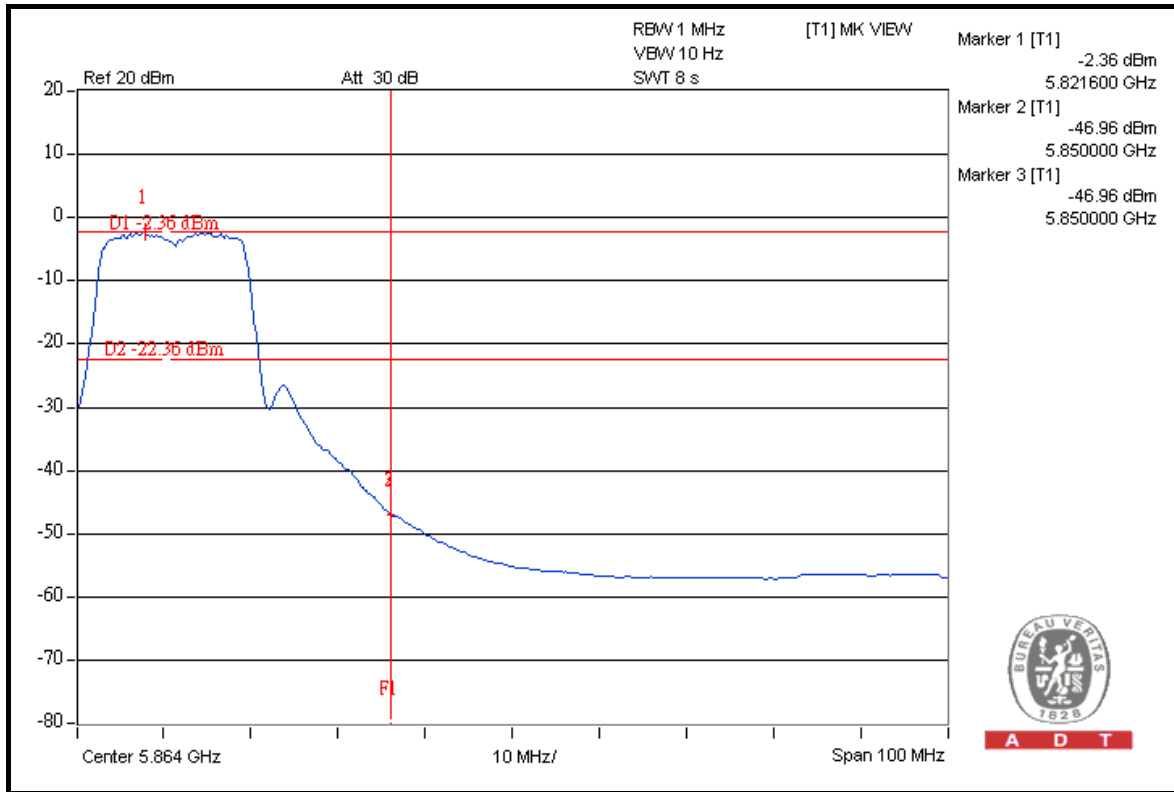



A D T

802.11n (20MHz)

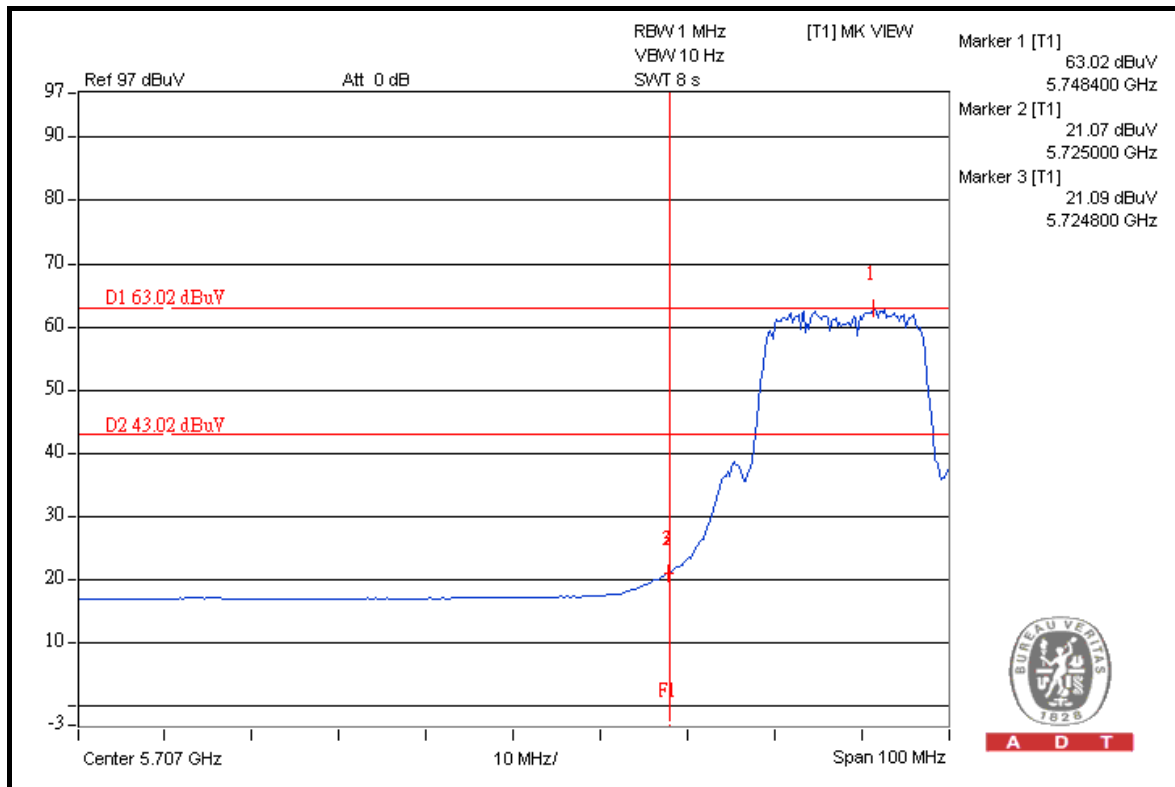
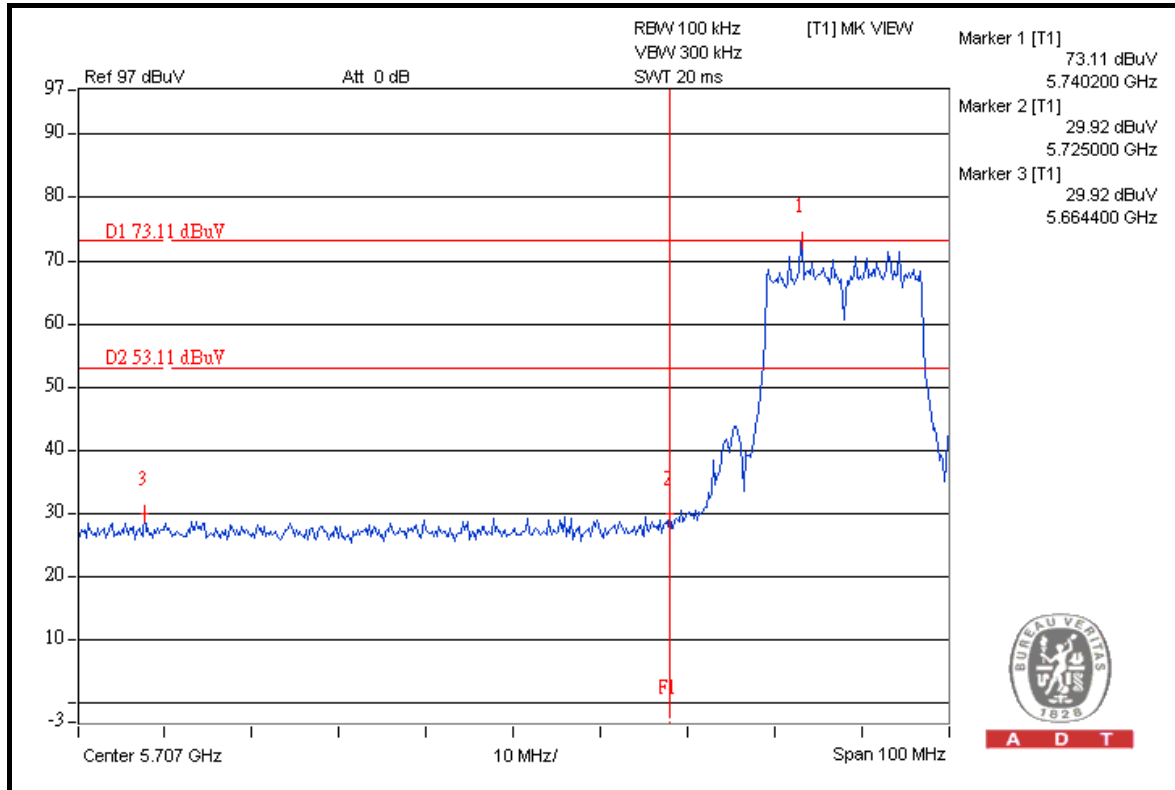



A D T

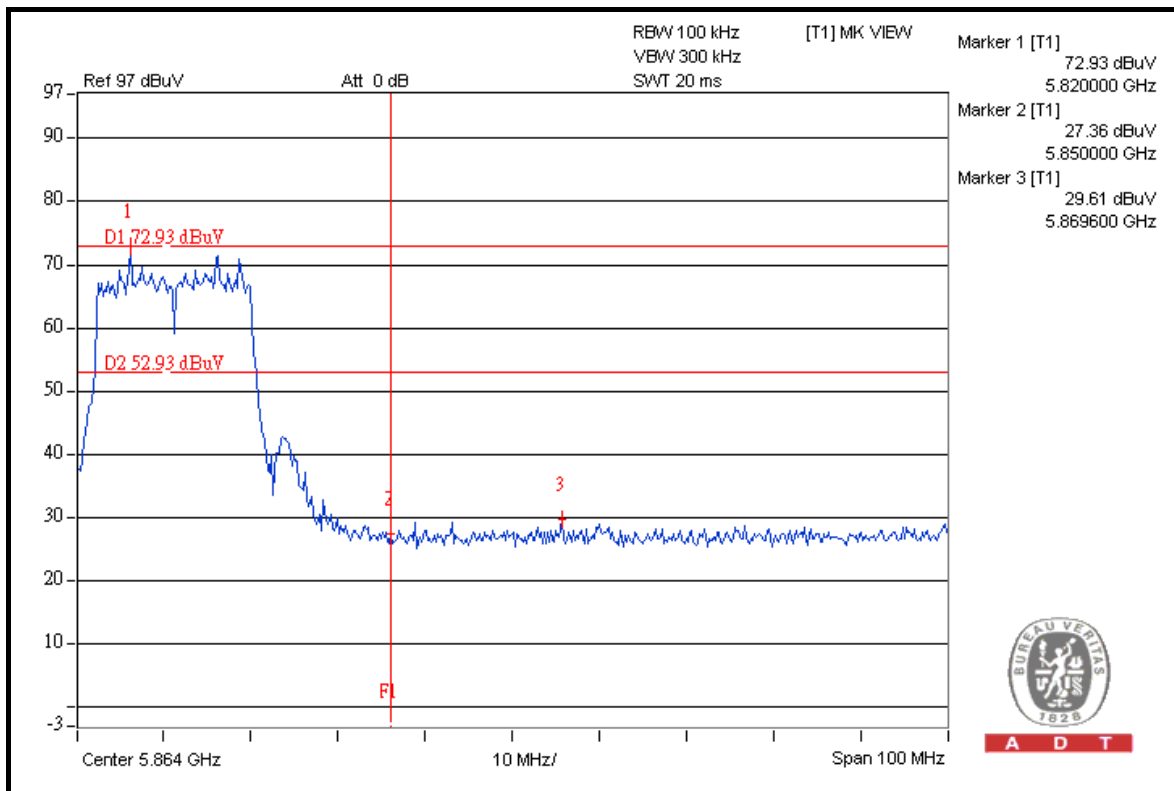
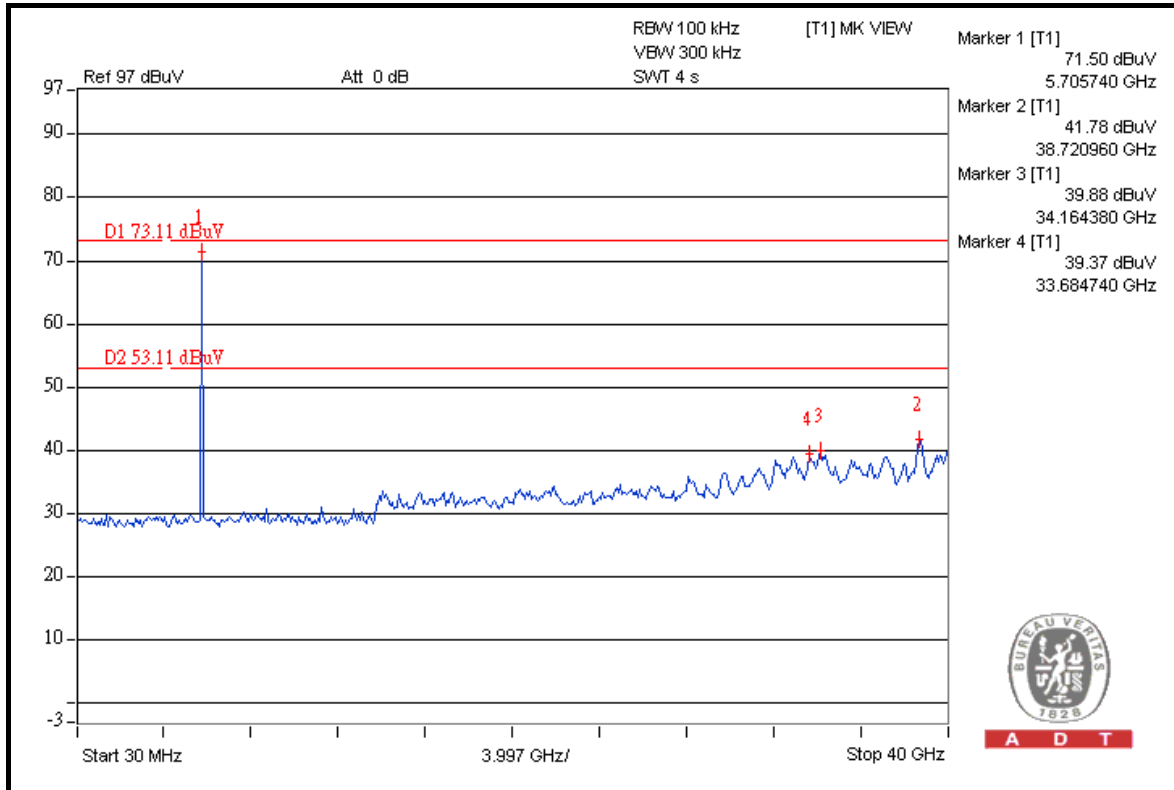



A D T

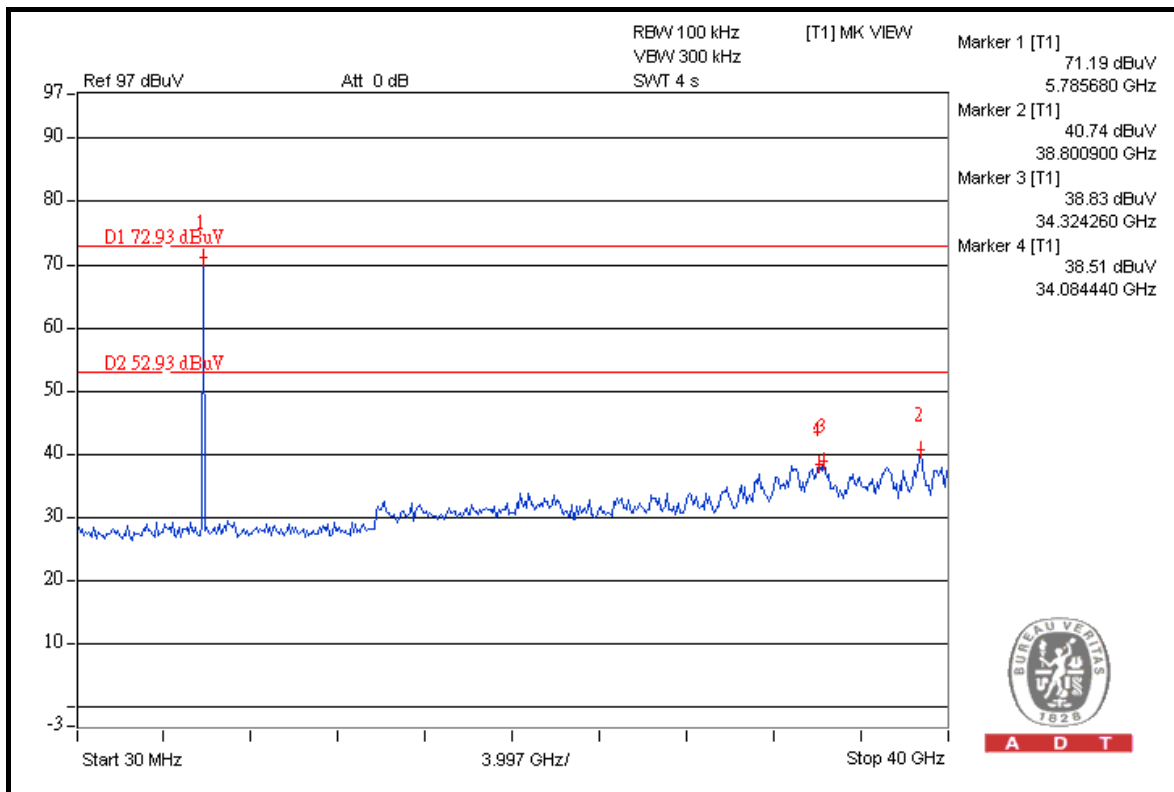
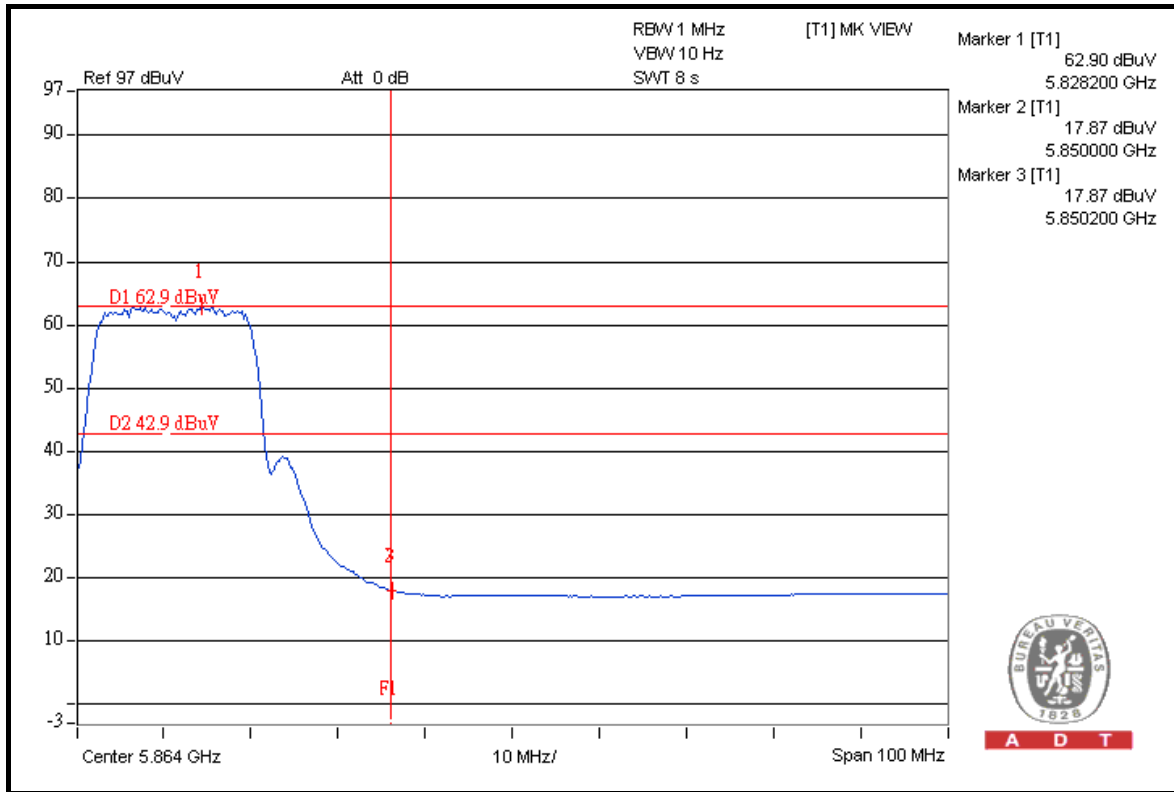



A D T

802.11n (40MHz)

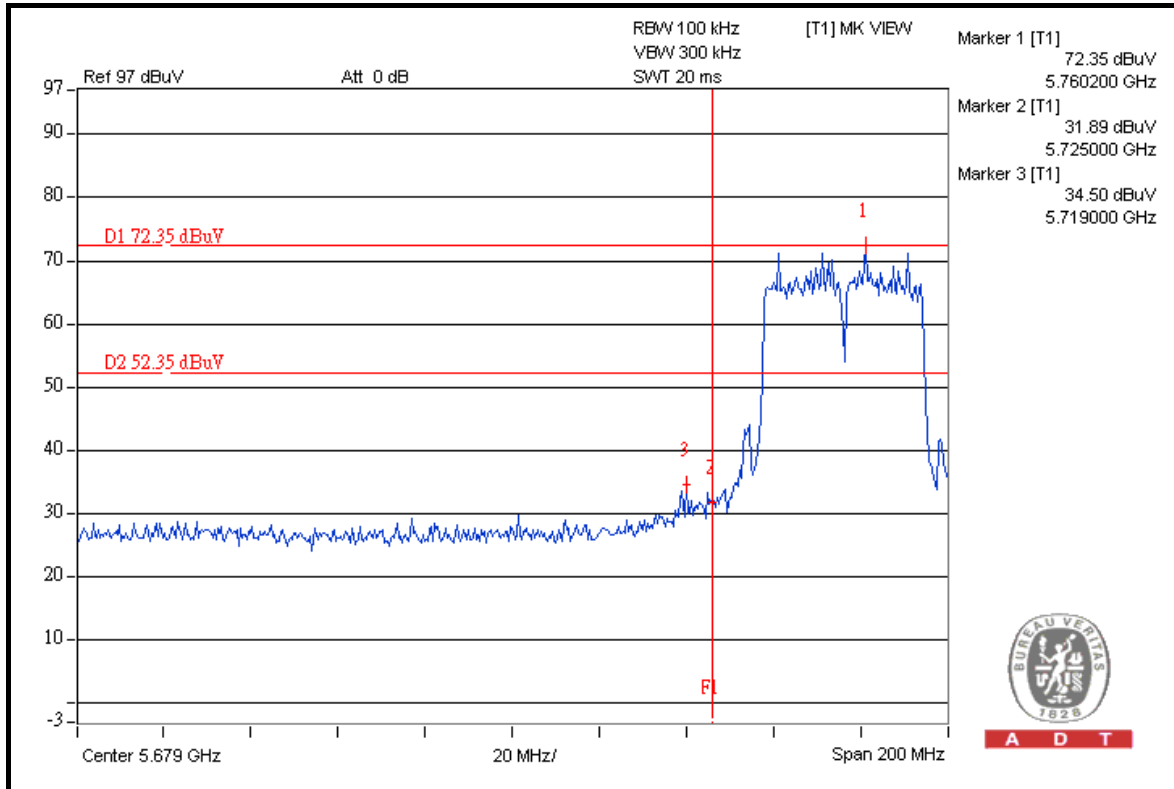

A D T

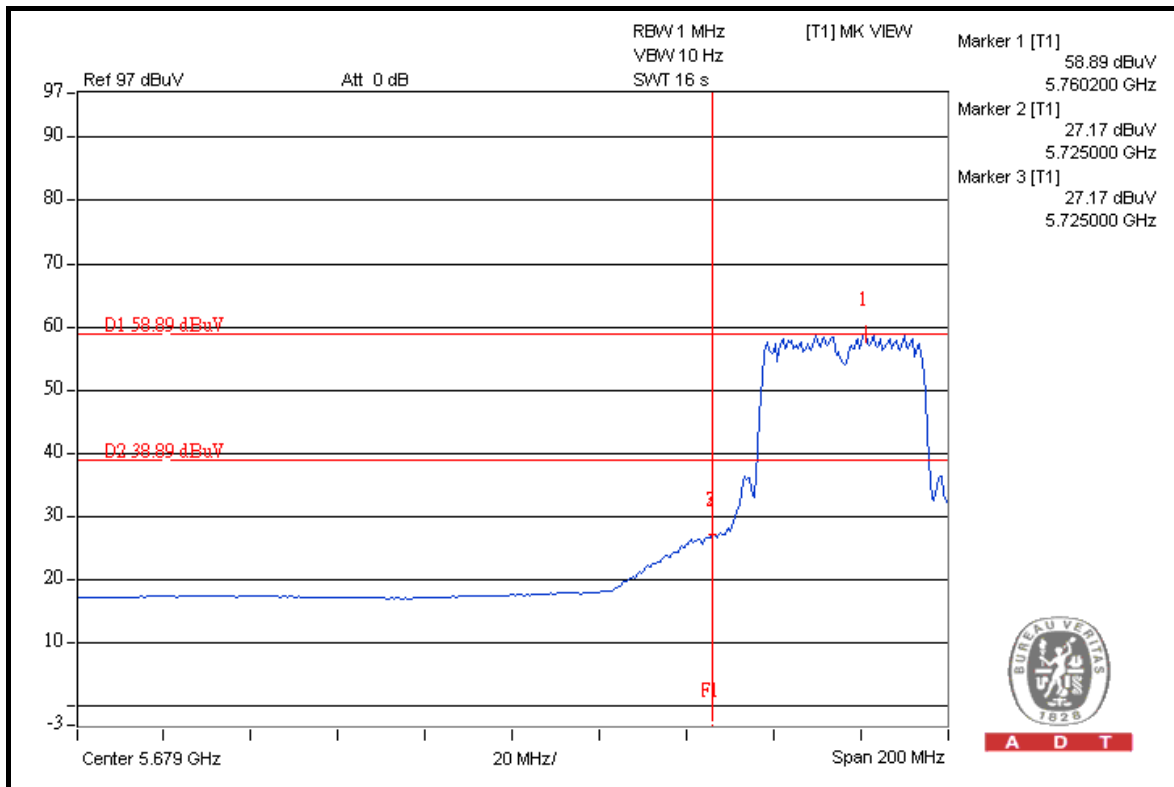

A D T



A D T

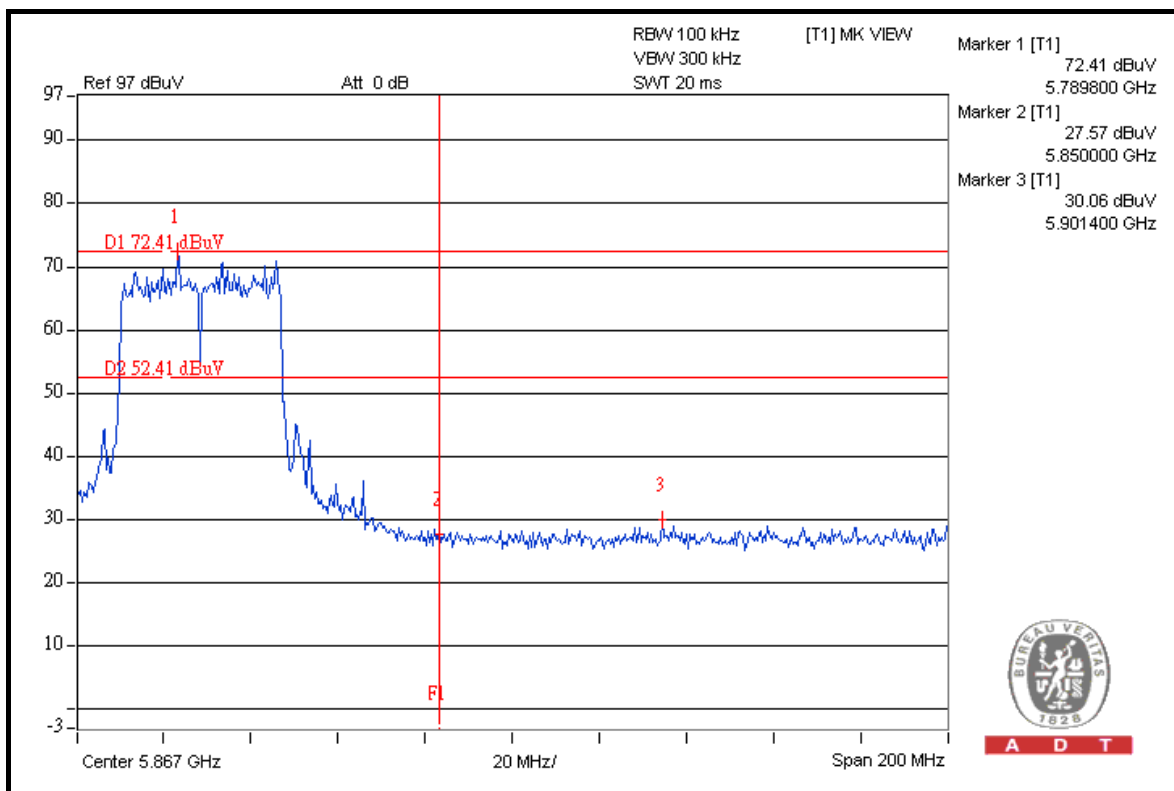
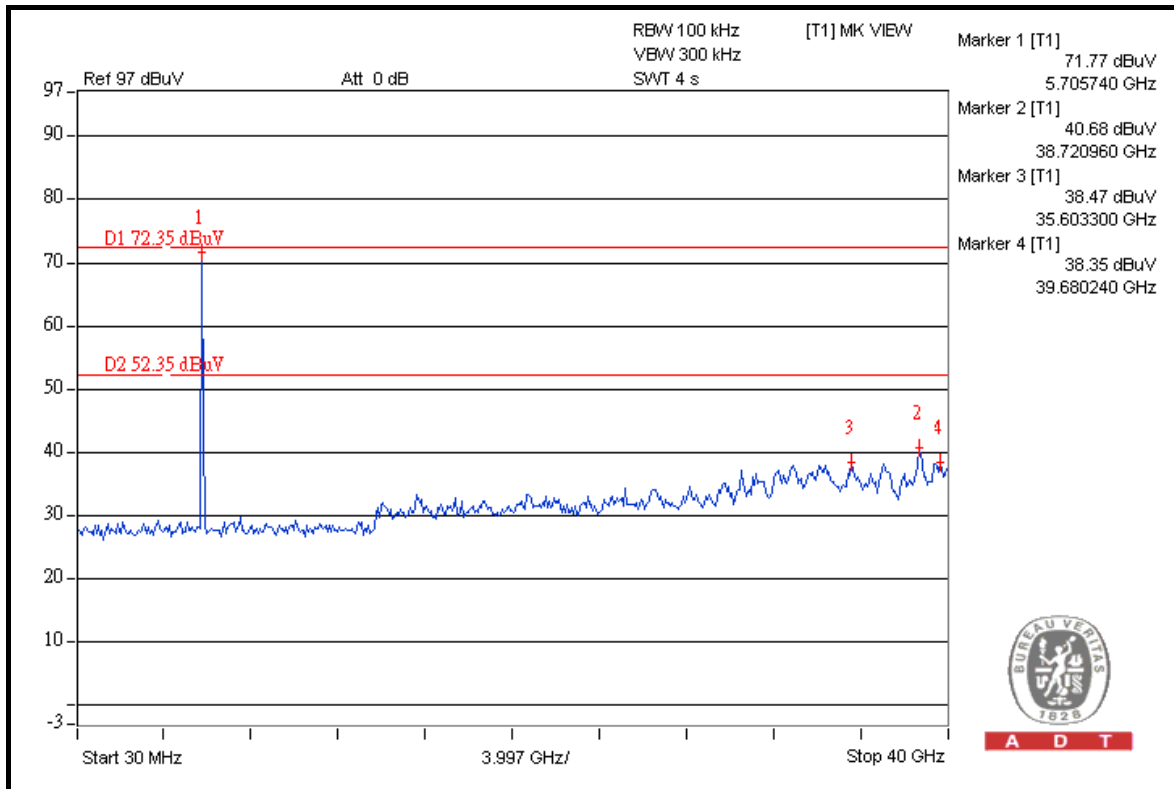



A D T

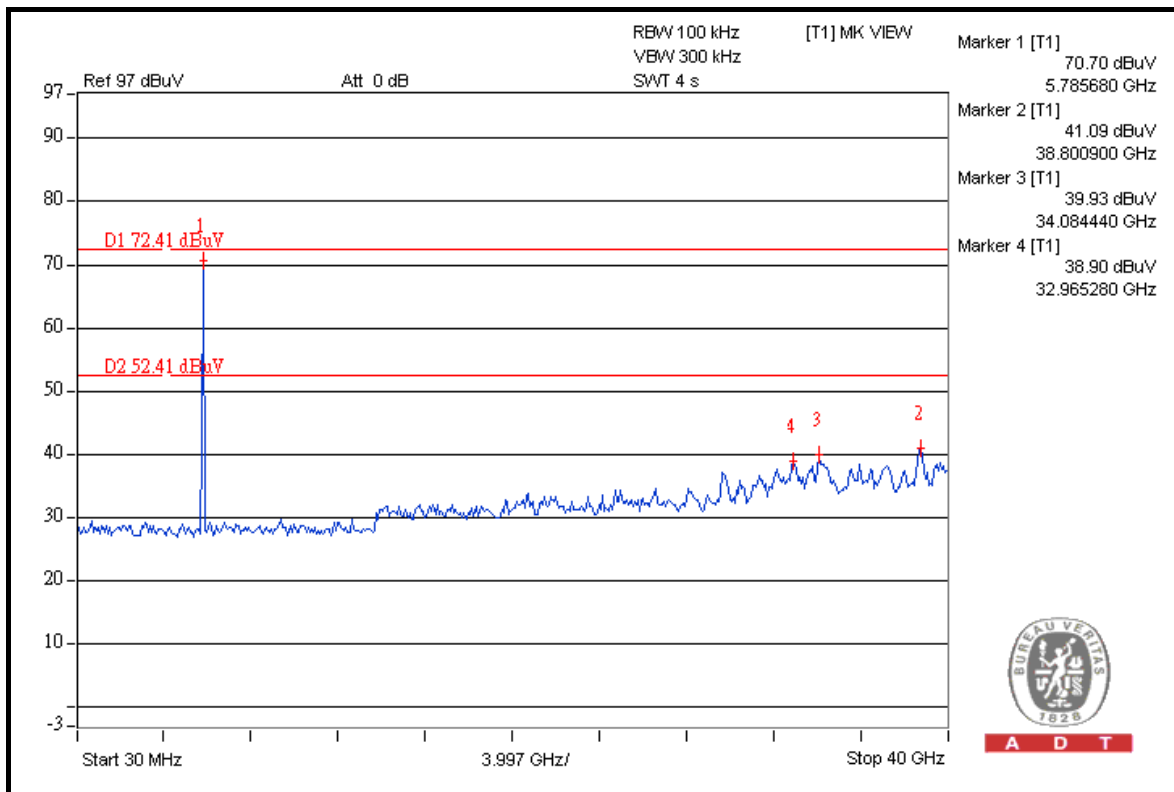
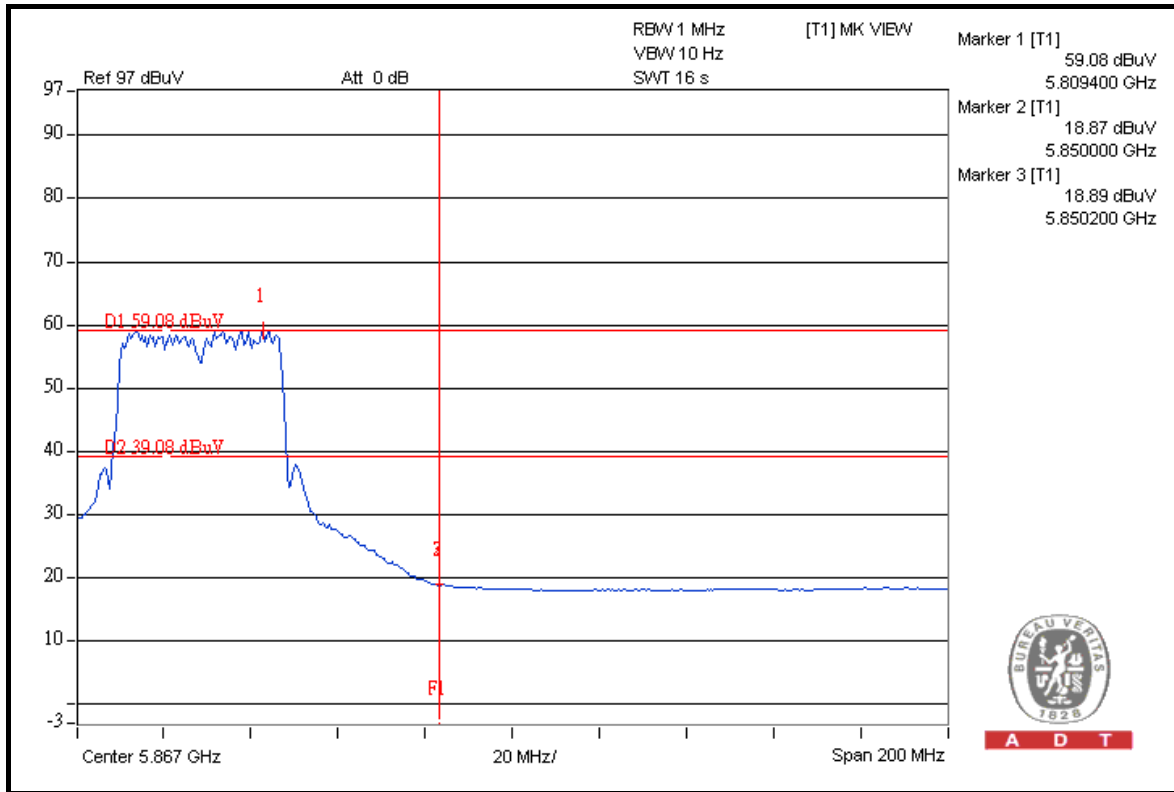



A D T

6. PHOTOGRAPHS OF THE TEST CONFIGURATION

Please refer to the attached file (Test Setup Photo).



A D T

7. INFORMATION ON THE TESTING LABORATORIES

We, Bureau Veritas Consumer Products Services (H.K.) Ltd., Taoyuan Branch., were founded in 1988 to provide our best service in EMC, Radio, Telecom and Safety consultation. Our laboratories are accredited and approved according to ISO/IEC 17025:

Copies of accreditation certificates of our laboratories obtained from approval agencies can be downloaded from our web site:

www.adt.com.tw/index.5/phtml. If you have any comments, please feel free to contact us at the following:

Linko EMC/RF Lab:

Tel: 886-2-26052180

Fax: 886-2-26051924

Hsin Chu EMC/RF Lab:

Tel: 886-3-5935343

Fax: 886-3-5935342

Hwa Ya EMC/RF/Safety/TPCI Lab:

Tel: 886-3-3183232

Fax: 886-3-3185050

Web Site: www.adt.com.tw

The address and road map of all our labs can be found in our web site also.



A D T

8. APPENDIX A - MODIFICATIONS RECORDERS FOR ENGINEERING CHANGES TO THE EUT BY THE LAB

No any modifications are made to the EUT by the lab during the test.

---END---