



A D T

DFS TEST REPORT

REPORT NO.: RF130726E06-3

MODEL NO.: AW-AM691NF

FCC ID: TLZ-AM691NF

RECEIVED: July 26, 2013

TESTED: Aug. 27, 2013

ISSUED: Sep. 06, 2013

APPLICANT: AzureWave Technologies, Inc.

ADDRESS: 8 F., No. 94, Baozhong Rd., Xindian, Taipei,
Taiwan 231

ISSUED BY: Bureau Veritas Consumer Products Services
(H.K.) Ltd., Taoyuan Branch Hsin Chu Laboratory

LAB ADDRESS : No. 81-1, Lu Liao Keng, 9th Ling, Wu Lung Tsuen,
Chiung Lin Hsiang, Hsin Chu Hsien 307, Taiwan,
R.O.C.

This report should not be used by the client to claim product certification, approval, or endorsement by TAF or any government agencies.



This report is for your exclusive use. Any copying or replication of this report to or for any other person or entity, or use of our name or trademark, is permitted only with our prior written permission. This report sets forth our findings solely with respect to the test samples identified herein. The results set forth in this report are not indicative or representative of the quality or characteristics of the lot from which a test sample was taken or any similar or identical product unless specifically and expressly noted. Our report includes all of the tests requested by you and the results thereof based upon the information that you provided to us. You have 60 days from date of issuance of this report to notify us of any material error or omission caused by our negligence, provided, however, that such notice shall be in writing and shall specifically address the issue you wish to raise. A failure to raise such issue within the prescribed time shall constitute your unqualified acceptance of the completeness of this report, the tests conducted and the correctness of the report contents. Unless specific mention, the uncertainty of measurement has been explicitly taken into account to declare the compliance or non-compliance to the specification



A D T

Table of Contents

RELEASE CONTROL RECORD	3
1. CERTIFICATION	4
2. EUT INFORMATION.....	5
2.1 OPERATING FREQUENCY BANDS AND MODE OF EUT.....	5
2.2 EUT SOFTWARE AND FIRMWARE VERSION	5
2.3 DESCRIPTION OF AVAILABLE ANTENNAS TO THE EUT	6
2.4 EUT MAXIMUM CONDUCTED POWER	7
2.5 EUT MAXIMUM EIRP POWER.....	8
2.6 TRANSMIT POWER CONTROL (TPC)	9
2.7 STATEMENT OF MAUNFACTURER.....	9
3. U-NII DFS RULE REQUIREMENTS	10
3.1 WORKING MODES AND REQUIRED TEST ITEMS	10
3.2 TEST LIMITS AND RADAR SIGNAL PARAMETERS	11
4. TEST & SUPPORT EQUIPMENT LIST.....	14
4.1 TEST INSTRUMENTS.....	14
4.2 DESCRIPTION OF SUPPORT UNITS.....	14
5. TEST PROCEDURE.....	15
5.1 BVADT DFS MEASUREMENT SYSTEM:.....	15
5.2 CALIBRATION OF DFS DETECTION THRESHOLD LEVEL:.....	16
5.3 DEVIATION FROM TEST STANDARD.....	17
5.4 CONDUCTED TEST SETUP CONFIGURATION.....	17
5.4.1 CLIENT WITHOUT RADAR DETECTION MODE	17
6. TEST RESULTS	18
6.1 SUMMARY OF TEST RESULTS	18
6.2 DETAILED TEST RESULTS	19
6.2.1 TEST MODE: DEVICE OPERATING IN CLIENT WITHOUT RADAR DETECTION MODE.....	19
6.2.1.1 DFS DETECTION THRESHOLD.....	19
6.2.1.2 CHANNEL CLOSING TRANSMISSION AND CHANNEL MOVE TIME	20
6.2.1.3 NON- OCCUPANCY PERIOD	21
6.2.1.4 NON-ASSOCIATED TEST.....	23
6.2.1.5 NON- CO-CHANNEL TEST	23
7. INFORMATION ON THE TESTING LABORATORIES	24
8. APPENDIX-A.....	25
9. APPENDIX B - MODIFICATIONS RECORDERS FOR ENGINEERING CHANGES TO THE EUT BY THE LAB.....	27



A D T

RELEASE CONTROL RECORD

ISSUE NO.	REASON FOR CHANGE	DATE ISSUED
RF130726E06-3	Original release	Sep. 06, 2013



A D T

1. CERTIFICATION

PRODUCT: IEEE 802.11 a/b/g/n Wireless LAN and Bluetooth Combo LGA Module
BRAND NAME : AzureWave
MODEL NO.: AW-AM691NF
TEST SAMPLE: ENGINEERING SAMPLE
APPLICANT: AzureWave Technologies, Inc.
TESTED: Aug. 27, 2013
STANDARDS: FCC Part 15, Subpart E (Section 15.407)
FCC 06-96

The above equipment (Model: AW-AM691NF) has been tested by **Bureau Veritas Consumer Products Services (H.K.) Ltd., Taoyuan Branch**, and was in compliance with the requirement of the above standards. The test record, data evaluation & Equipment Under Test (EUT) configurations represented herein are true and accurate accounts of the measurements of the sample's EMC characteristics under the conditions specified in this report.

PREPARED BY : , **DATE:** Sep. 06, 2013
(Lori Chung, Specialist)

APPROVED BY : , **DATE:** Sep. 06, 2013
(May Chen, Manager)



A D T

2. EUT INFORMATION

2.1 OPERATING FREQUENCY BANDS AND MODE OF EUT

TABLE 1: OPERATING FREQUENCY BANDS AND MODE OF EUT

OPERATIONAL MODE	OPERATING FREQUENCY RANGE	
	5250~5350MHz	5470~5725MHz (Disable 5600 ~ 5650MHz)
Client without radar detection and ad hoc function	ü	ü

2.2 EUT SOFTWARE AND FIRMWARE VERSION

TABLE 2: THE EUT SOFTWARE/FIRMWARE VERSION

PLATFORM	NO.	PRODUCT	MODEL NO.	SOFTWARE/FIRMWARE VERSION
Linux	1	IEEE 802.11 a/b/g/n Wireless LAN and Bluetooth Combo LGA Module	AW-AM691NF	Driver Version: 6.10.197.38(r400241 WLTEST) FWID 01-0



A D T

2.3 DESCRIPTION OF AVAILABLE ANTENNAS TO THE EUT

TABLE 3: ANTENNA LIST

Ant.	Brand	Model	Antenna Type	Connector	Antenna Gain <include cable lose> (dB)	Antenna Cable Loss (dB)	Cable Length (mm)	Frequency range (MHz to MHz)
1	MAG.LAYERS	MSA-4008-25GC1-A1	PIFA	I-PEX	2.98	0.5	150	2400 ~ 2500
					5.16			4900 ~ 5900
2	INPAQ	WA-C-XT-02-001	PIFA	I-PEX	2.40	1	721	2400 ~ 2500
					2.06			5150 ~ 5850
3	INPAQ	WA-P-LB-02-035	PIFA	I-PEX	2.97	1	440	2400 ~ 2500
					2.77			5150 ~ 5850
4	WHA YU	SSR-31604	PIFA	I-PEX	2.6	0.5	125	2400 ~ 2500
					4.3			4900 ~ 5825
5	Smart Approach Co., Ltd	SE-ECJH0-001	PIFA	I-PEX	-0.56	0.66	206	2400 ~ 2500
					1.25	0.98		5150 ~ 5350
					0.08	1.03		5740 ~ 5725
					0.75	1.06		5725 ~ 5850
6	Smart Approach Co., Ltd	SE-ECJH0-002	PIFA	I-PEX	-0.57	0.14	43	2400 ~ 2500
					-0.64	0.20		5150 ~ 5350
					1.79	0.22		5740 ~ 5725
					1.27	0.22		5725 ~ 5850
7	JiengtaiCorporation	JT1301209Y0311	PIFA	I-PEX	1.82	0.76	208	2400 ~ 2500
					0.45	1.22		5150 ~ 5350
					0.76	1.27		5740 ~ 5725
					0.38	1.32		5725 ~ 5850
8	JiengtaiCorporation	JT1301209Y1511	PIFA	I-PEX	-0.44	0.13	48	2400 ~ 2500
					2.08	0.25		5150 ~ 5350
					2.48	0.26		5740 ~ 5725
					1.66	0.33		5725 ~ 5850
9	Hua Chen Technology Co.,Ltd	0ACCN013008N	PIFA	I-PEX	-1.04	0.12	213	2400 ~ 2500
					-1.67	0.19		5150 ~ 5350
					-0.64	0.20		5740 ~ 5725
					-0.75	0.21		5725 ~ 5850
10	Hua Chen Technology Co.,Ltd	0ACCN013009N	PIFA	I-PEX	-5.82	0.5	49	2400 ~ 2500
					0.54	0.77		5150 ~ 5350
					2.33	0.80		5740 ~ 5725
					2.33	0.82		5725 ~ 5850

From the above antennas, antenna 1 was selected for the test and its data was recorded in this report.



A D T

2.4 EUT MAXIMUM CONDUCTED POWER

IEEE 802.11a

ANT SET.	FREQUENCY BAND (MHz)	MAX. POWER	
		OUTPUT POWER(dBm)	OUTPUT POWER(mW)
1	5250~5350	20.54	113.24
1	5470~5725	19.03	79.983

IEEE 802.11n HT20

ANT SET.	FREQUENCY BAND (MHz)	MAX. POWER	
		OUTPUT POWER(dBm)	OUTPUT POWER(mW)
1	5250~5350	22.62	182.666
1	5470~5725	22.37	172.699

IEEE 802.11n HT40

ANT SET.	FREQUENCY BAND (MHz)	MAX. POWER	
		OUTPUT POWER(dBm)	OUTPUT POWER(mW)
1	5250~5350	19.69	93.077
1	5470~5725	17.62	57.858



A D T

2.5 EUT MAXIMUM EIRP POWER

IEEE 802.11a

ANT SET.	FREQUENCY BAND (MHz)	MAX. POWER	
		OUTPUT POWER(dBm)	OUTPUT POWER(mW)
1	5250~5350	25.7	371.535
1	5470~5725	24.19	262.422

IEEE 802.11n HT20

ANT SET.	FREQUENCY BAND (MHz)	MAX. POWER	
		OUTPUT POWER(dBm)	OUTPUT POWER(mW)
1	5250~5350	27.78	599.791
1	5470~5725	27.53	566.239

IEEE 802.11n HT40

ANT SET.	FREQUENCY BAND (MHz)	MAX. POWER	
		OUTPUT POWER(dBm)	OUTPUT POWER(mW)
1	5250~5350	24.85	305.492
1	5470~5725	22.78	189.671



A D T

2.6 TRANSMIT POWER CONTROL (TPC)

U-NII devices operating in the 5.25-5.35 GHz band and the 5.47-5.725 GHz band shall employ a TPC mechanism. The U-NII device is required to have the capability to operate at least 6 dB below the mean EIRP value of 30 dBm. A TPC mechanism is not required for systems with an EIRP of less than 500 mW.

Maximum EIRP of this device is 599.791mW which more than 500mW, therefore it's require TPC function.

TPC is auto controlled by software to adjust power level when the TX power needs to increase or decrease. So it is automatic TPC.

2.7 STATEMENT OF MAUNFACTURER

This device (Client) is without radar detection, then the manufacturer statement confirming that information regarding the parameters of the detected Radar Waveforms is not available to the end user. **And the device doesn't have Ad Hoc mode on DFS frequency band.**



3. U-NII DFS RULE REQUIREMENTS

3.1 WORKING MODES AND REQUIRED TEST ITEMS

The manufacturer shall state whether the UUT is capable of operating as a Master and/or a Client. If the UUT is capable of operating in more than one operating mode then each operating mode shall be tested separately. See tables 1 and 2 for the applicability of DFS requirements for each of the operational modes.

TABLE 6: APPLICABILITY OF DFS REQUIREMENTS PRIOR TO USE A CHANNEL

REQUIREMENT	OPERATIONAL MODE		
	MASTER	CLIENT WITHOUT RADAR DETECTION	CLIENT WITH RADAR DETECTION
Non-Occupancy Period	ü	ü	ü
DFS Detection Threshold	ü	Not required	ü
Channel Availability Check Time	ü	Not required	Not required
Uniform Spreading	ü	Not required	Not required
U-NII Detection Bandwidth	ü	Not required	ü

TABLE 7: APPLICABILITY OF DFS REQUIREMENTS DURING NORMAL OPERATION

REQUIREMENT	OPERATIONAL MODE		
	MASTER	CLIENT WITHOUT RADAR DETECTION	CLIENT WITH RADAR DETECTION
DFS Detection Threshold	ü	Not required	ü
Channel Closing Transmission Time	ü	ü	ü
Channel Move Time	ü	ü	ü
U-NII Detection Bandwidth	ü	Not required	ü



A D T

3.2 TEST LIMITS AND RADAR SIGNAL PARAMETERS

DETECTION THRESHOLD VALUES

TABLE 8: DFS DETECTION THRESHOLDS FOR MASTER DEVICES AND CLIENT DEVICES WITH RADAR DETECTION

MAXIMUM TRANSMIT POWER	VALUE (SEE Note 1 and 2)
≥ 200 milliwatt	-64 dBm
< 200 milliwatt	-62 dBm

Note 1: This is the level at the input of the receiver assuming a 0 dBi receive antenna.

Note 2: Throughout these test procedures an additional 1 dB has been added to the amplitude of the test transmission waveforms to account for variations in measurement equipment. This will ensure that the test signal is at or above the detection threshold level to trigger a DFS response.



A D T

TABLE 9: DFS RESPONSE REQUIREMENT VALUES

PARAMETER	VALUE
Non-occupancy period	Minimum 30 minutes
Channel Availability Check Time	60 seconds
Channel Move Time	10 seconds See Note 1.
Channel Closing Transmission Time	200 milliseconds + an aggregate of 60 milliseconds over remaining 10 second period. See Notes 1 and 2.
U-NII Detection Bandwidth	Minimum 80% of the UNII 99% transmission power bandwidth. See Note 3.
<p>Note 1: The instant that the Channel Move Time and the Channel Closing Transmission Time begins is as follows:</p> <ul style="list-style-type: none">• For the Short Pulse Radar Test Signals this instant is the end of the Burst.• For the Frequency Hopping radar Test Signal, this instant is the end of the last radar Burst generated.• For the Long Pulse Radar Test Signal this instant is the end of the 12 second period defining the Radar Waveform. <p>Note 2: The Channel Closing Transmission Time is comprised of 200 milliseconds starting at the beginning of the Channel Move Time plus any additional intermittent control signals required to facilitate a Channel move (an aggregate of 60 milliseconds) during the remainder of the 10 second period. The aggregate duration of control signals will not count quiet periods in between transmissions.</p> <p>Note 3: During the U-NII Detection Bandwidth detection test, radar type 1 is used and for each frequency step the minimum percentage of detection is 90 percent. Measurements are performed with no data traffic.</p>	



PARAMETERS OF DFS TEST SIGNALS

Step intervals of 0.1 microsecond for Pulse Width, 1 microsecond for PRI, 1 MHz for chirp width and 1 for the number of pulses will be utilized for the random determination of specific test waveforms.

TABLE 10: SHORT PULSE RADAR TEST WAVEFORMS

RADAR TYPE	PULSE WIDTH (μsec)	PRI (μsec)	NUMBER OF PULSES	MINIMUM PERCENTAGE OF SUCCESSFUL DETECTION	MINIMUM NUMBER OF TRIALS
1	1	1428	18	60%	30
2	1-5	150-230	23-29	60%	30
3	6-10	200-500	16-18	60%	30
4	11-20	200-500	12-16	60%	30
Aggregate (Radar Types 1-4)				80%	120

TABLE 11: LONG PULSE RADAR TEST WAVEFORM

RADAR TYPE	PULSE WIDTH (μsec)	CHIRP WIDTH (MHz)	PRI (μsec)	NUMBER OF PULSES PER BURST	NUMBER OF BURSTS	MINIMUM PERCENTAGE OF SUCCESSFUL DETECTION	MINIMUM NUMBER OF TRIALS
5	50-100	5-20	1000-2000	1-3	8-20	80%	30

TABLE 12: FREQUENCY HOPPING RADAR TEST WAVEFORM

RADAR TYPE	PULSE WIDTH (μsec)	PRI (μsec)	PULSES PER HOP	HOPPING RATE (kHz)	HOPPING SEQUENCE LENGTH (msec)	MINIMUM PERCENTAGE OF SUCCESSFUL DETECTION	MINIMUM NUMBER OF TRIALS
6	1	333	9	0.333	300	70%	30



A D T

4. TEST & SUPPORT EQUIPMENT LIST

4.1 TEST INSTRUMENTS

TABLE 1: TEST INSTRUMENTS LIST.

DESCRIPTION & MANUFACTURER	MODEL NO.	BRAND	CALIBRATED DATE	CALIBRATED UNTIL
R&S Spectrum analyzer	FSP40	R&S	Jan 21, 2013	Jan 20, 2014
Signal generator	8645A	Agilent	Aug 24, 2013	Aug 23, 2014

4.2 DESCRIPTION OF SUPPORT UNITS

TABLE 2: SUPPORT UNIT INFORMATION.

NO.	PRODUCT	BRAND	MODEL NO.	ID	SPEC.
1	WIRELESS AC MODULE	D-Link	WMC-AC01	RRK201206005 6-1	The maximum EIRP is 27.64 dBm, Antenna Gain is 3.82dBi

NOTE: The module (WMC-AC01) was installed in the DIR-868L AP.

This device was functioned as a Master Slave device during the DFS test.

TABLE 3: SOFTWARE/FIRMWARE INFORMATION.

NO.	PRODUCT	MODEL NO.	SOFTWARE/FIRMWARE VERSION
1.	WIRELESS AC MODULE	WMC-AC01	1.00 Wed 06 Mar 2013

5. TEST PROCEDURE

5.1 BVADT DFS MEASUREMENT SYSTEM:

A complete BVADT DFS Measurement System consists of two subsystems: (1) the Radar Signal Generating Subsystem and (2) the Traffic Monitoring Subsystem. The control PC is necessary for generating the Radar waveforms in Table 6, 7 and 8. The traffic monitoring subsystem is specified to the type of unit under test (UUT).

CONDUCTED SETUP CONFIGURATION OF ADT DFS MEASUREMENT SYSTEM

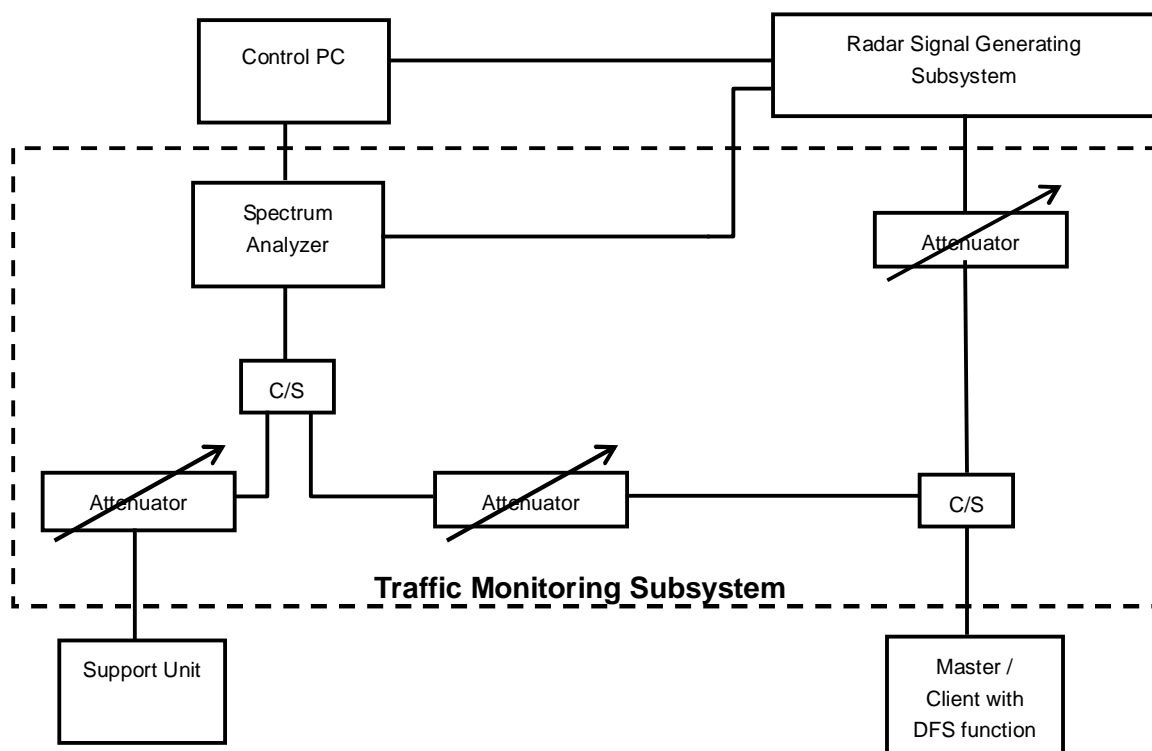

The test transmission will always be from the Master Device to the Client Device. While the Client device is set up to associate with the Master device and play the MPEG file (6 y Magic Hours) from Master device, the designated MPEG test file and instructions are located at:

<http://ntiacsd.ntia.doc.gov/dfs/>.

5.2 CALIBRATION OF DFS DETECTION THRESHOLD LEVEL:

The measured channel is 5500 MHz in 20MHz Bandwidth and 5510MHz in 40MHz Bandwidth. The radar signal was the same as transmitted channels, and injected into the antenna port of AP (master) or Client Device with Radar Detection, measured the channel closing transmission time and channel move time. The Master antenna gain is 3.82dBi and required detection threshold is -59.18dBm (= -64 +1+3.82)dBm. The calibrated conducted detection threshold level is set to -59.18 dBm.

CONDUCTED SETUP CONFIGURATION OF CALIBRATION OF DFS DETECTION THRESHOLD LEVEL

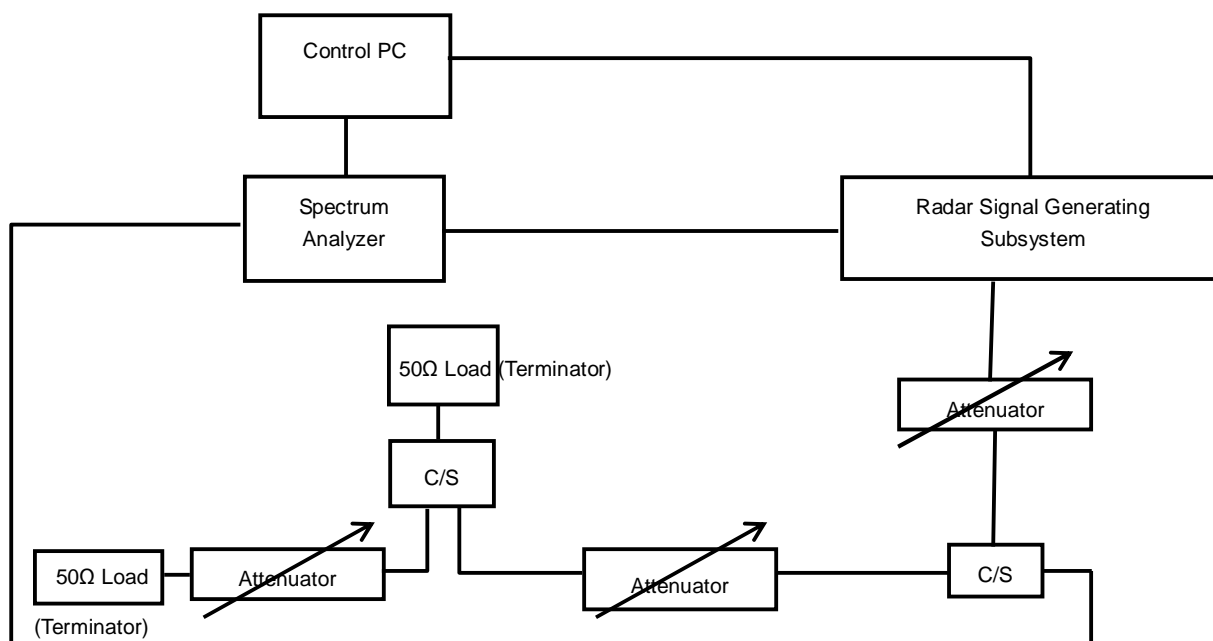

5.3 DEVIATION FROM TEST STANDARD

No deviation.

5.4 CONDUCTED TEST SETUP CONFIGURATION

5.4.1 CLIENT WITHOUT RADAR DETECTION MODE

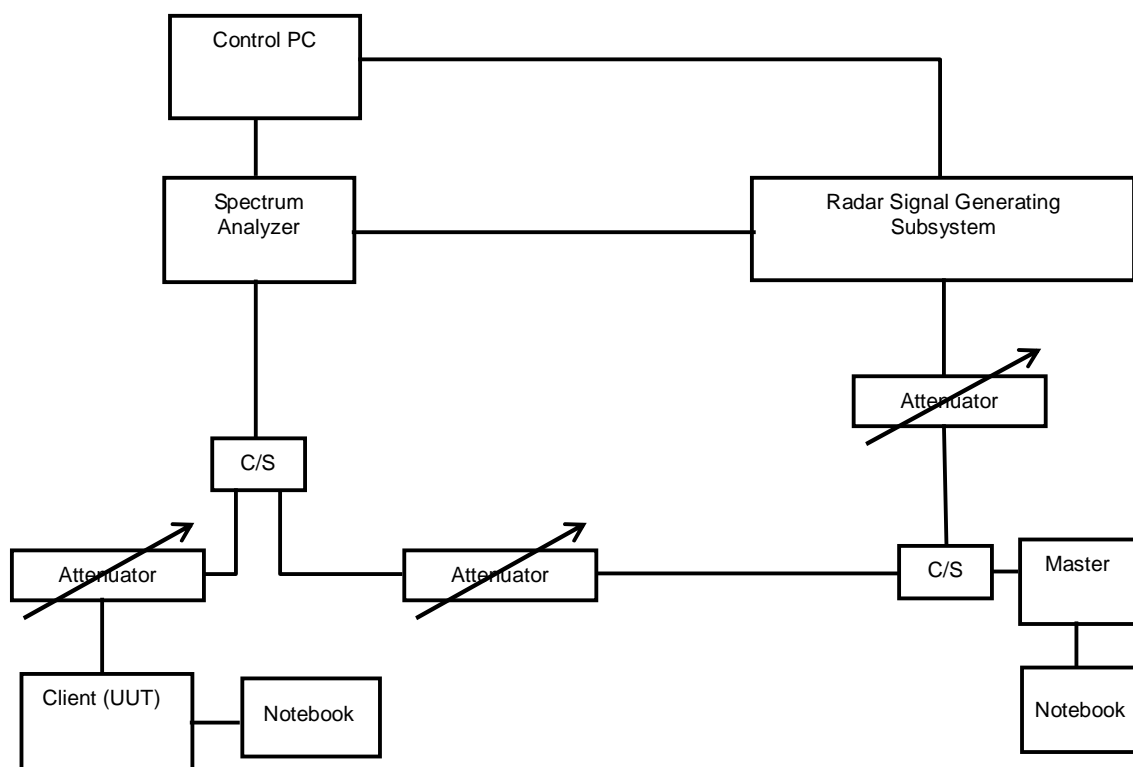

The UUT is a U-NII Device operating in Client mode without radar detection. The radar test signals are injected into the Master Device.



A D T

6. TEST RESULTS

6.1 SUMMARY OF TEST RESULTS

CLAUSE	TEST PARAMETER	REMARKS	PASS/FAIL
15.407	DFS Detection Threshold	Not Applicable	NA
15.407	Channel Availability Check Time	Not Applicable	NA
15.407	Channel Move Time	Applicable	Pass
15.407	Channel Closing Transmission Time	Applicable	Pass
15.407	Non- Occupancy Period	Applicable	Pass
15.407	Uniform Spreading	Not Applicable	NA
15.407	U-NII Detection Bandwidth	Not Applicable	NA
15.407	Non-associated test	Applicable	Pass
15.407	Non-Co-Channel test	Applicable	Pass

6.2 DETAILED TEST RESULTS

6.2.1 TEST MODE: DEVICE OPERATING IN CLIENT WITHOUT RADAR DETECTION MODE.

The radar test signals are injected into the Master Device.

This test was investigated for different bandwidth (20MHz and 40MHz). The following plots was done on 40MHz as a representative

6.2.1.1 DFS DETECTION THRESHOLD

The required detection threshold is -59.18dBm ($= -64 + 3.82 + 1$) dBm. The conducted radar burst level is set to -59.18dBm .

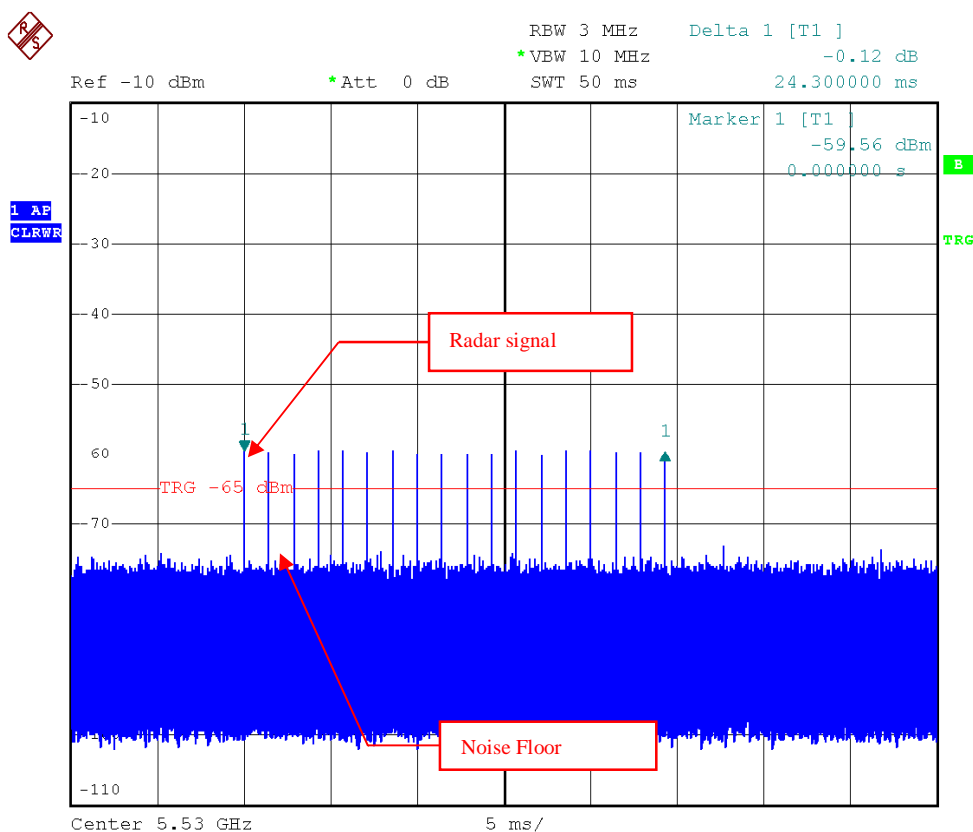

Radar Signal 1

6.2.1.2 CHANNEL CLOSING TRANSMISSION AND CHANNEL MOVE TIME

Channel Closing Transmission Time & Channel Move Time @ CH102 - 5510MHz

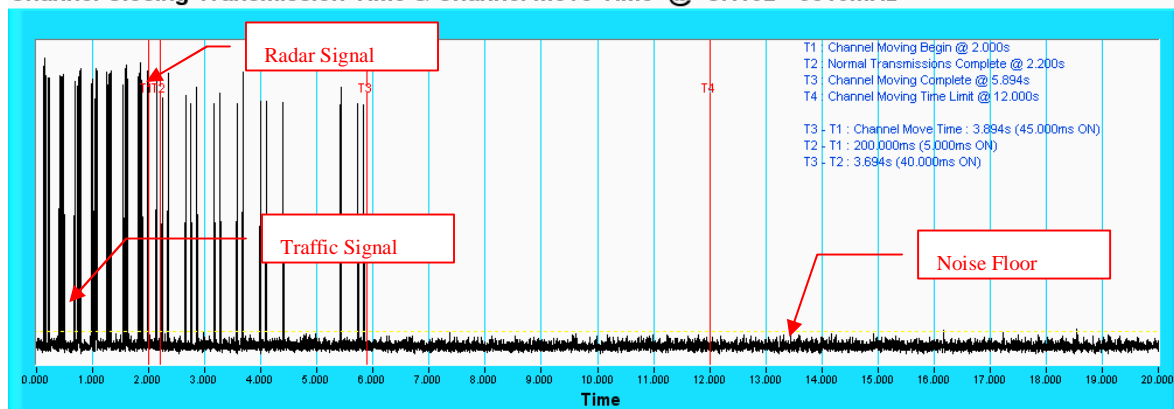

NOTE: T1 denotes the start of Channel Move Time upon the end of the last Radar burst. T2 denotes the data transmission time of 200ms from T1. T4 denotes the 10 second from T1 to observe the aggregate duration of transmissions.

Channel Closing Transmission Time & Channel Move Time @ CH102 - 5510MHz

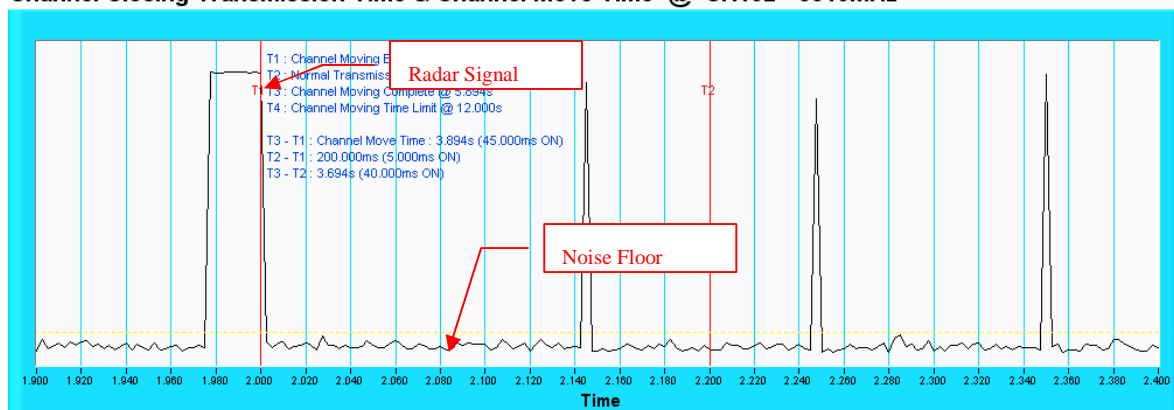

NOTE: An expanded plot for the device vacates the channel in the required 500ms.

6.2.1.3 NON- OCCUPANCY PERIOD

ASSOCIATED TEST

1) Test results demonstrating an associated client link is established with the master on a test frequency.

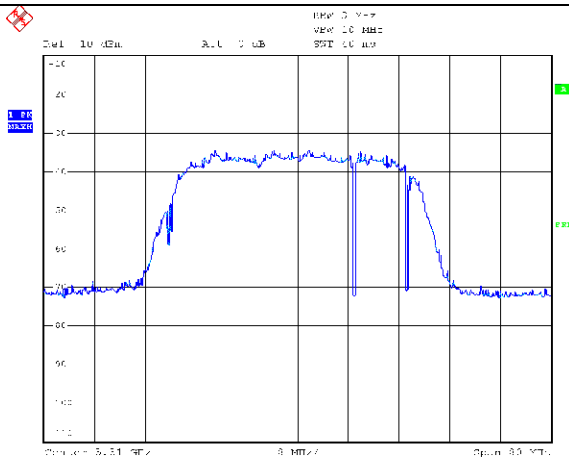

EUT (Client) links with master on 5510MHz

2) The client and DFS-certified master device are associated, and the movie can be streamed as specified in the DFS Order for a non-occupancy period test.

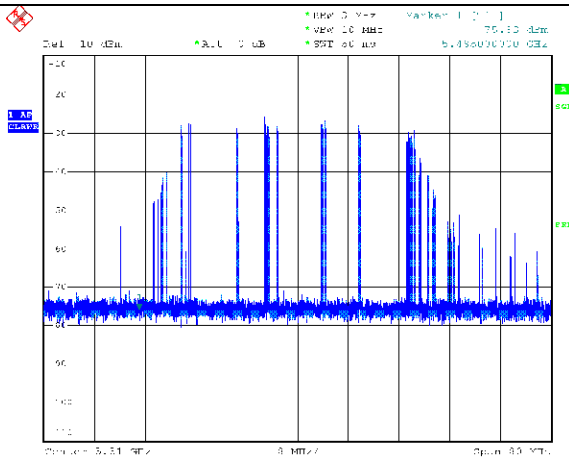

Client plays a specified files via master.

3). The device transmits one type of radar as specified in the DFS Order.

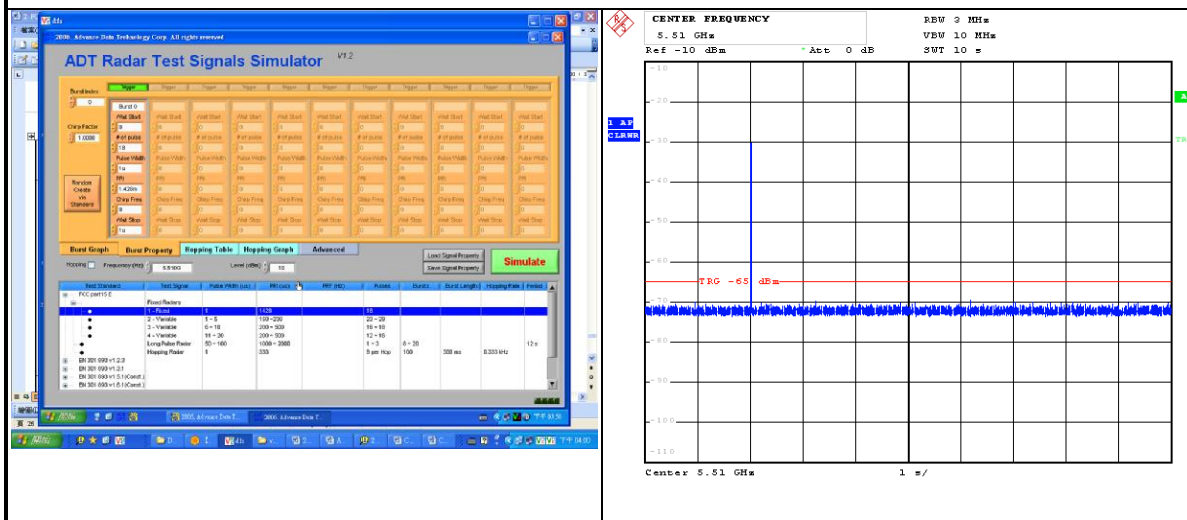

Radar 1 is used to test during DFS testing.

4) The test frequency has been monitored to ensure no transmission of any type has occurred for 30 minutes;

Note: If the client moves with the master, the device is considered compliant if nothing appears in the client non-occupancy period test. For devices that shut down (rather than moving channels), no beacons should appear;

5)An analyzer plot that contains a single 30-minute sweep on the original test frequency.

Non - Occupancy Period @ CH102 - 5510MHz

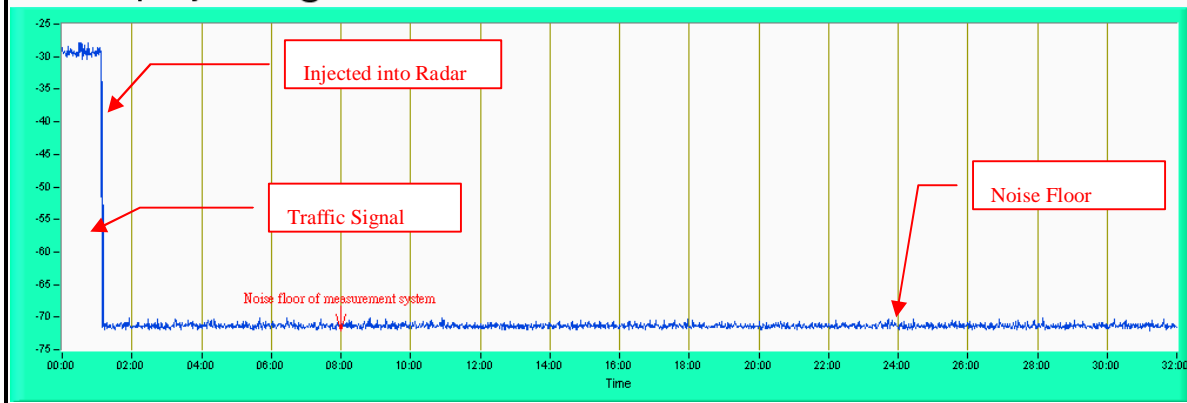

6.2.1.4 NON-ASSOCIATED TEST

Master was off.

During the 30 minutes observation time, The UUT did not make any transmissions in the DFS band after UUT power up.

Non - Associated Test @ CH102 - 5510MHz

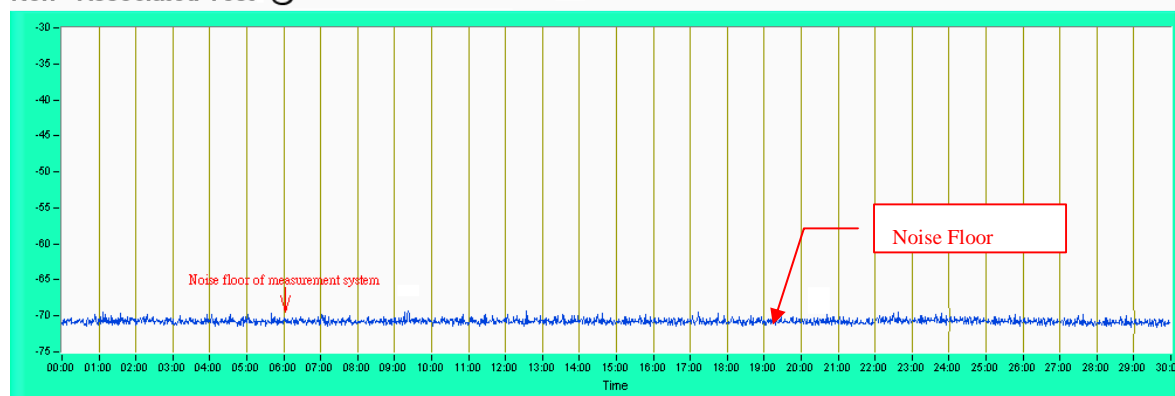

6.2.1.5 NON- CO-CHANNEL TEST

The UUT was investigated after radar was detected the channel and made sure no co-channel operation with radars.



A D T

7. INFORMATION ON THE TESTING LABORATORIES

We, Bureau Veritas Consumer Products Services (H.K.) Ltd., Taoyuan Branch, were founded in 1988 to provide our best service in EMC, Radio, Telecom and Safety consultation. Our laboratories are accredited and approved according to ISO/IEC 17025.

If you have any comments, please feel free to contact us at the following:

Linko EMC/RF Lab:

Tel: 886-2-26052180

Fax: 886-2-26052943

Hsin Chu EMC/RF Lab:

Tel: 886-3-5935343

Fax: 886-3-5935342

Hwa Ya EMC/RF/Safety/Telecom Lab:

Tel: 886-3-3183232

Fax: 886-3-3270892

Email: service.adt@tw.bureauveritas.com

Web Site: www.bureauveritas-adt.com

The address and road map of all our labs can be found in our web site also.

8. APPENDIX-A

Notch band in 5600-5650MHz

Verify that the 5600 - 5650 MHz band is notched.
Test results demonstrating last channel shall not exceed the band edge on 5600~5650MHz.

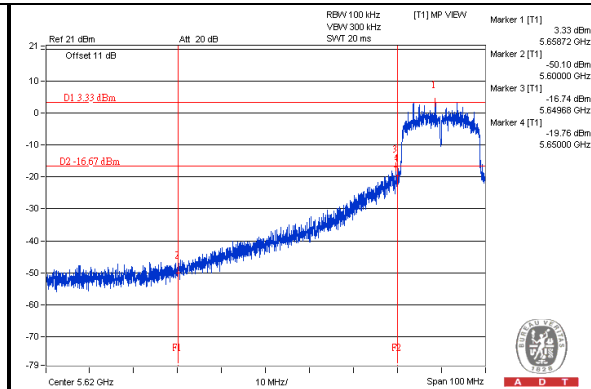
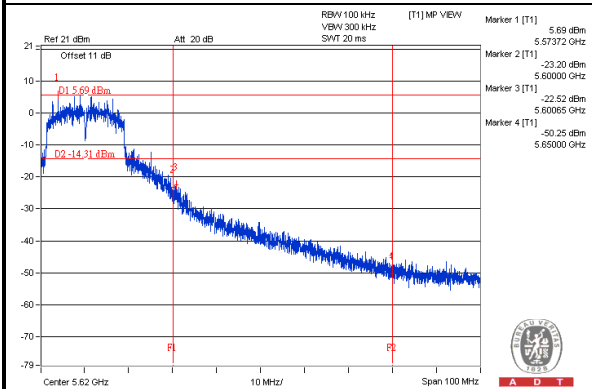

802.11n (20MHz) OFDM MODULATION (CH 116: 5580MHz)

802.11n (20MHz) OFDM MODULATION (CH 132: 5660MHz)

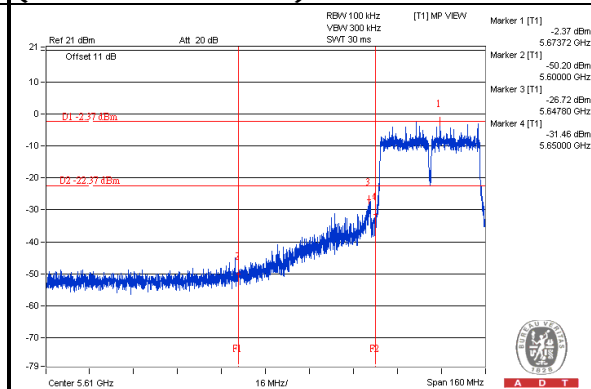
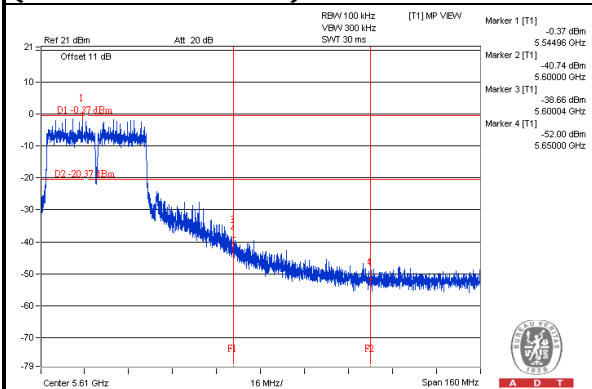

802.11n (40MHz) OFDM MODULATION (CH 110: 5550MHz)

802.11n (40MHz) OFDM MODULATION (CH 134: 5670MHz)

NON BEACON ON DFS BAND

- 1) Test results demonstrating no any beacon on DFS band after power up.
- 2) Observation time is 10min after power up.

<p>EUT (Client) links with master on 11n HT20 mode</p>	<p>EUT (Client) links with master on 11n HT40 mode</p>

BAND EDGE AT NEARBY DFS BAND

- 1) Test results demonstrating last channel (20dB BW) shall not exceed the band edge on 5150~5250MHz.

<p>EUT (Client) links with master on 11n HT20 mode</p>	<p>EUT (Client) links with master on 11n HT40 mode</p>



A D T

9. APPENDIX B - MODIFICATIONS RECORDERS FOR ENGINEERING CHANGES TO THE EUT BY THE LAB

No modifications were made to the EUT by the lab during the test.

--- END ---