



MEASUREMENT REPORT

FCC PART 15.247 WLAN 802.11b/g/n

FCC ID: TKZAWM003
APPLICANT: DynaScan Technology Corp.
Application Type: Certification
Product: WiFi AP Router Module
Model No.: AWM003
Host Product Number: WIFI CONTROL BOX
Host Model No.: WCB001
Brand Name: 
FCC Classification: (DTS) Digital Transmission System
FCC Rule Part(s): Part 15.247
Test Procedure(s): ANSI C63.10-2013, KDB 558074 D01v04
 KDB 996369 D01 v01r04
Test Date: October 30 ~ November 06, 2017

Tested By : *Peter Syu*
 (Peter Syu)
 Reviewed By : *Paddy Chen*
 (Paddy Chen)
 Approved By : *Chenz Ker*
 (Chenz Ker)



The test results relate only to the samples tested.

This equipment has been shown to be capable of compliance with the applicable technical standards as indicated in the measurement report and was tested in accordance with the measurement procedures specified in KDB 558074 D01v04. Test results reported herein relate only to the item(s) tested.

The test report shall not be reproduced except in full without the written approval of MRT Technology (Taiwan) Co., Ltd.

Revision History

Report No.	Version	Description	Issue Date	Note
1710TW0112-U1	1.0	Original Report	2017-11-07	

CONTENTS

Description	Page
§2.1033 General Information	5
1. INTRODUCTION	6
1.1. Scope	6
1.2. MRT Test Location.....	6
2. PRODUCT INFORMATION	7
2.1. Equipment Description	7
2.2. Working Frequencies for this Report.....	8
2.3. Test Mode	8
2.4. Test Software	8
2.5. Test Configuration.....	9
2.6. EMI Suppression Device(s)/Modifications.....	9
2.7. Labeling Requirements	9
3. DESCRIPTION of TEST	10
3.1. Evaluation Procedure.....	10
3.2. AC Line Conducted Emissions.....	10
3.3. Radiated Emissions	11
4. ANTENNA REQUIREMENTS	12
5. TEST EQUIPMENT CALIBRATION DATE	13
6. MEASUREMENT UNCERTAINTY	14
7. TEST RESULT	15
7.1. Summary.....	15
7.2. 6dB Bandwidth Measurement.....	16
7.2.1. Test Limit	16
7.2.2. Test Procedure used	16
7.2.3. Test Setting	16
7.2.4. Test Setup	16
7.2.5. Test Result	17
7.3. Output Power Measurement	20
7.3.1. Test Limit.....	20
7.3.2. Test Procedure Used.....	20
7.3.3. Test Setting	20
7.3.4. Test Setup	20
7.3.5. Test Result of Output Power	21
7.4. Power Spectral Density Measurement.....	22
7.4.1. Test Limit.....	22
7.4.2. Test Procedure Used.....	22
7.4.3. Test Setting	22
7.4.4. Test Setup	22
7.4.5. Test Result	23
7.5. Out-of-Band Spurious Emissions Emissions Measurement.....	26

7.5.1.	Test Limit	26
7.5.2.	Test Procedure Used.....	26
7.5.3.	Test Settintg	26
7.5.4.	Test Setup	26
7.5.5.	Test Result	27
7.6.	Radiated Spurious Emission Measurement	36
7.6.1.	Test Limit	36
7.6.2.	Test Procedure Used.....	36
7.6.3.	Test Setting	36
7.6.4.	Test Setup	38
7.6.5.	Test Result	40
7.7.	Radiated Restricted Band Edge Measurement.....	66
7.7.1.	Test Limit	66
7.7.2.	Test Procedure Used.....	66
7.7.3.	Test Setting	66
7.7.4.	Test Setup	68
7.7.5.	Test Result	69
7.8.	AC Conducted Emissions Measurement	91
7.8.1.	Test Limit	91
7.8.2.	Test Setup	91
7.8.3.	Test Result	92
8.	CONCLUSION	94

§2.1033 General Information

Applicant	AsiaRF Co., Ltd
Applicant Address	3F, 215, Dehe Road, Yonghe Dist. New Taipei City 234, Taiwan
Manufacturer	AsiaRF Co., Ltd
Manufacturer Address	3F, 215, Dehe Road, Yonghe Dist. New Taipei City 234, Taiwan
Test Site	MRT Technology (Taiwan) Co., Ltd
Test Site Address	No. 38, Fuxing Second Rd., Guishan Dist., Taoyuan City 333, Taiwan (R.O.C)
MRT FCC Registration No.	291082
FCC Rule Part(s)	Part 15.247
Test Device Serial No.	N/A <input type="checkbox"/> Production <input checked="" type="checkbox"/> Pre-Production <input type="checkbox"/> Engineering

Test Facility / Accreditations

1. MRT facility is a FCC registered (Reg. No. 291082) test facility with the site description report on file and is designated by the FCC as an Accredited Test Film.
2. MRT facility is an IC registered (MRT Reg. No. 21723-1) test laboratory with the site description on file at Industry Canada.
3. MRT Lab is accredited to ISO 17025 by the Taiwan Accreditation Foundation (TAF Cert. No. 3261) in EMC, Telecommunications and Radio testing for FCC, Industry Taiwan, EU and TELEC Rules.

1. INTRODUCTION

1.1. Scope

Measurement and determination of electromagnetic emissions (EMC) of radio frequency devices including intentional and/or unintentional radiators for compliance with the technical rules and regulations of the Federal Communications Commission and the Industry Canada Certification and Engineering Bureau.

1.2. MRT Test Location

The map below shows the location of the MRT LABORATORY, its proximity to the Taoyuan City. These measurement tests were conducted at the MRT Technology (Taiwan) Co., Ltd. Facility located at No.38, Fuxing 2nd Rd., Guishan Dist., Taoyuan City 33377, Taiwan (R.O.C).

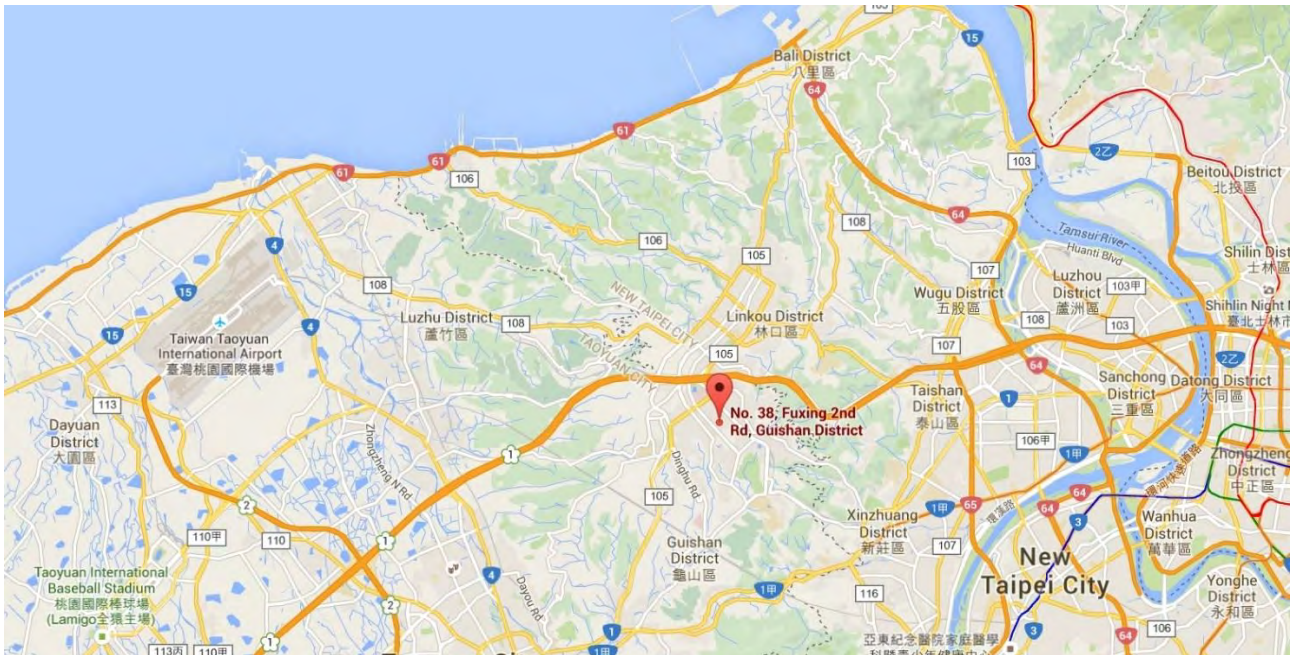

2. PRODUCT INFORMATION

2.1. Equipment Description

Product Name	WiFi AP Router Module
FCC ID	TKZAWM003
Model No.	AWM003
Brand Name	
Supports Radios Spec.	WLAN :2.4G : 802.11b/g/n-20/n-40
Wi-Fi Specification	802.11b/g/n
Frequency Range	2.4GHz: For 802.11b/g/n-20M: 2412 ~ 2462 MHz For 802.11n-40M: 2422 ~ 2452 MHz
2.4GHz Maximum Output Peak Power	802.11b: 18.79dBm 802.11g: 22.98dBm 802.11n-20M: 22.77dBm 802.11n-40M: 19.99dBm
Type of Modulation	802.11b: DSSS, DBPSK, DQPSK, CCK 802.11g/n-20M/n-40M: OFDM (BPSK, QPSK, 16QAM, 64QAM)
Host Adapter	MRF: DVE Model No: DSA-12G-12FUS 120120 Input: AC 100-240V~0.3A, 50-60Hz Output: DC 12V, 1.0A Cable Out: Non- Shielded 1.5m

Note: Since KDB 996369 D01, If the module is limited because it is not shielded, only the module grantee can make the test evaluation that the module is compliant in the host (Product Name : WIFI CONTROL BOX; Model Number : WCB001).

2.2. Working Frequencies for this Report

802.11b/g/n-20M

Channel	Frequency	Channel	Frequency	Channel	Frequency
01	2412 MHz	02	2417 MHz	03	2422 MHz
04	2427 MHz	05	2432 MHz	06	2437 MHz
07	2442 MHz	08	2447 MHz	09	2452 MHz
10	2457 MHz	11	2462 MHz	--	--

802.11n-40M

Channel	Frequency	Channel	Frequency	Channel	Frequency
03	2422 MHz	04	2427 MHz	05	2432 MHz
06	2437 MHz	07	2442 MHz	08	2447 MHz
09	2452 MHz	--	--	--	--

2.3. Test Mode

Test Mode	Mode 1: Transmit by 802.11b
	Mode 2: Transmit by 802.11g
	Mode 3: Transmit by 802.11n-20M
	Mode 4: Transmit by 802.11n-40M

2.4. Test Software

The test utility software used during testing was "RT5350QA".

2.5. Test Configuration

This device was tested per the guidance of KDB 558074 D01v04. ANSI C63.10-2013 was used to reference the appropriate EUT setup for radiated spurious emissions testing and AC line conducted testing.

2.6. EMI Suppression Device(s)/Modifications

No EMI suppression device(s) were added and/or no modifications were made during testing.

2.7. Labeling Requirements

Per 2.1074 & 15.19; Docket 95-19

The label shall be permanently affixed at a conspicuous location on the device; instruction manual or pamphlet supplied to the user and be readily visible to the purchaser at the time of purchase. However, when the device is so small wherein placement of the label with specified statement is not practical, only the FCC ID must be displayed on the device per Section 15.19(a)(5). Please see attachment for FCC ID label and label location.

3. DESCRIPTION of TEST

3.1. Evaluation Procedure

The measurement procedures described in the American National Standard for Testing Unlicensed Wireless Devices (ANSI C63.10-2013), and the guidance provided in KDB 558074 D01v04 were used in the measurement of this device.

Deviation from measurement procedure.....None

3.2. AC Line Conducted Emissions

The line-conducted facility is located inside an 9'x4'x3' shielded enclosure. A 1m x 2m wooden table 80cm high is placed 40cm away from the vertical wall and 80cm away from the sidewall of the shielded room. Two 10kHz-30MHz, 50Ω/50uH Line-Impedance Stabilization Networks (LISNs) are bonded to the shielded room floor. Power to the LISNs is filtered by external high-current high-insertion loss power line filters. These filters attenuate ambient signal noise from entering the measurement lines. These filters are also bonded to the shielded enclosure.

The EUT is powered from one LISN and the support equipment is powered from the second LISN. All interconnecting cables more than 1 meter were shortened to a 1 meter length by non-inductive bundling (serpentine fashion) and draped over the back edge of the test table. All cables were at least 40cm above the horizontal reference ground-plane. Power cables for support equipment were routed down to the second LISN while ensuring that that cables were not draped over the second LISN.

Sufficient time for the EUT, support equipment, and test equipment was allowed in order for them to warm up to their normal operating condition. The RF output of the LISN was connected to the receiver and exploratory measurements were made to determine the frequencies producing the maximum emission from the EUT. The receiver was scanned from 150kHz to 30MHz. The detector function was set to peak mode for exploratory measurements while the bandwidth of the analyzer was set to 9kHz. The EUT, support equipment, and interconnecting cables were arranged and manipulated to maximize each emission. Each emission was also maximized by varying: power lines, the mode of operation or data exchange speed, or support equipment which determined the worst-case emission. Once the worst case emissions have been identified, the one EUT cable configuration/arrangement and mode of operation that produced these emissions are used for final measurements on the same test site. The analyzer is set to CISPR quasi-peak and average detectors with a 9kHz resolution bandwidth for final measurements.

An extension cord was used to connect to a single LISN which powered by EUT. The extension cord was calibrated with LISN, the impedance and insertion loss are compliance with the requirements as stated in ANSI C63.10-2013.

Line conducted emissions test results are shown in Section 7.8.

3.3. Radiated Emissions

The radiated test facilities consisted of an indoor 3 meter semi-anechoic chamber used for final measurements and exploratory measurements, when necessary. The measurement area is contained within the semi-anechoic chamber which is shielded from any ambient interference. For measurements above 1GHz absorbers are arranged on the floor between the turn table and the antenna mast in such a way so as to maximize the reduction of reflections. For measurements below 1GHz, the absorbers are removed. A MF Model 210SS turntable is used for radiated measurement. It is a continuously rotatable, remote controlled, metallic turntable and 2 meters (6.56 ft.) in diameter. The turn table is flush with the raised floor of the chamber in order to maintain its function as a ground plane. An 80cm high PVC support structure is placed on top of the turntable.

For all measurements, the spectrum was scanned through all EUT azimuths and from 1 to 4 meter receive antenna height using a broadband antenna from 30MHz up to the upper frequency shown in 15.33(b)(1) depending on the highest frequency generated or used in the device or on which the device operates or tunes. For frequencies above 1GHz, linearly polarized double ridge horn antennas were used. For frequencies below 30MHz, a calibrated loop antenna was used. When exploratory measurements were necessary, they were performed at 1 meter test distance inside the semi-anechoic chamber using broadband antennas, broadband amplifiers, and spectrum analyzers to determine the frequencies and modes producing the maximum emissions. Sufficient time for the EUT, support equipment, and test equipment was allowed in order for them to warm up to their normal operating condition. The test set-up for frequencies below 1GHz was placed on top of the 0.8 meter high, 1 x 1.5 meter table; and test set-up for frequencies 1-40GHz was placed on top of the 1.5 meter high, 1 x 1.5 meter table. The EUT, support equipment, and interconnecting cables were arranged and manipulated to maximize each emission. Appropriate precaution was taken to ensure that all emissions from the EUT were maximized and investigated. The system configuration, clock speed, mode of operation or video resolution, if applicable, turntable azimuth, and receive antenna height was noted for each frequency found.

Final measurements were made in the semi-anechoic chamber using calibrated, linearly polarized broadband and horn antennas. The test setup was configured to the setup that produced the worst case emissions. The spectrum analyzer was set to investigate all frequencies required for testing to compare the highest radiated disturbances with respect to the specified limits. The turntable containing the EUT was rotated through 360 degrees and the height of the receive antenna was varied 1 to 4 meters and stopped at the azimuth and height producing the maximum emission. Each emission was maximized by changing the orientation of the EUT through three orthogonal planes and changing the polarity of the receive antenna, which produced the worst-case emissions. According to 3dB Beam-Width of horn antenna, the horn antenna should be always directed to the EUT when rising height.

Radiated emissions test results are shown in Section 7.6 & 7.7 .

4. ANTENNA REQUIREMENTS

Excerpt from §15.203 of the FCC Rules/Regulations:

“An intentional radiator antenna shall be designed to ensure that no antenna other than that furnished by the responsible party can be used with the device. The use of a permanently attached antenna or of an antenna that uses a unique coupling to the intentional radiator shall be considered sufficient to comply with the provisions of this section.”

- The antenna is permanently attached.
- There are no provisions for connection to an external antenna.

Conclusion:

This device unit complies with the requirement of §15.203.

Antenna List

No.	Manufacturer	Part No.	Antenna Type	Peak Gain
1	AsiaRF	A-2408	Dipole	1.8dBi

5. TEST EQUIPMENT CALIBRATION DATE

Conducted Emissions – SR2

Instrument	Manufacturer	Type No.	Asset No.	Cali. Interval	Cali. Due Date
Two-Line V-Network	R&S	ENV216	MRTTWA00019	1 year	2018.03.15
Cable	Rosnol	N1C50-RG400-B 1C50-500CM	MRTTWE00013	1 year	2018.05.19
EMI Test Receiver	R&S	ESR3	MRTTWA00009	1 year	2018.03.16

Radiated Emissions – AC1

Instrument	Manufacturer	Type No.	Asset No.	Cali. Interval	Cali. Due Date
Broadband TRILOG Antenna	SCHWARZBECK	VULB 9162	MRTTWA00001	1 year	2018.05.14
EMI Test Receiver	R&S	ESR3	MRTTWA00009	1 year	2018.03.16
Active Loop Antenna	Schwarzbeck	FMZB 1519B	MRTTWA00002	1 year	2018.04.13
Broadband Horn antenna	SCHWARZBECK	BBHA 9120D	MRTTWA00003	1 year	2018.04.17
Breitband Hornantenna	Schwarzbeck	BBHA 9170	MRTTWA00004	1 year	2018.04.24
Broadband Amplifier	Schwarzbeck	BBV 9721	MRTTWA00006	1 year	2018.04.24
Broadband Preamplifier	SCHWARZBECK	BBV 9718	MRTTWA00005	1 year	2018.04.19
Cable	HUBERSUHNER	SF106	MRTTWA00010	1 year	2018.05.19
Cable	Rosnol	K1K50-UP0264- K1K50-4M	MRTTWA00012	1 year	2018.05.19

Conducted Test Equipment – SR2

Instrument	Manufacturer	Type No.	Asset No.	Cali. Interval	Cali. Due Date
Spectrum Analyzer	KEYSIGHT	N9010A	MRTTWA00012	1 year	2018.07.24
USB Wideband Power Sensor	KEYSIGHT	U2021XA	MRTTWA00015	1 year	2018.03.19

Test Software

Software	Version	Function
e3	9.160520a	EMI Test Software
EMI	V3	EMI Test Software

6. MEASUREMENT UNCERTAINTY

Where relevant, the following test uncertainty levels have been estimated for tests performed on the EUT as specified in CISPR 16-4-2. This uncertainty represents an expanded uncertainty expressed at approximately the 95% confidence level using a coverage factor of $k = 2$.

AC Conducted Emission Measurement – SR2	
Measuring Uncertainty for a Level of Confidence of 95% ($U=2Uc(y)$):	
150kHz~30MHz: 2.42dB	
Conducted Measurement– SR1	
Measuring Uncertainty for a Level of Confidence of 95% ($U=2Uc(y)$): 1.3dB	
Radiated Emission Measurement – AC1	
Measuring Uncertainty for a Level of Confidence of 95% ($U=2Uc(y)$):	
Horizontal:	9K~30MHz: 4.14dB
	30MHz~1GHz: 4.22dB
	1GHz~40GHz: 4.05dB
Vertical:	9K~30MHz: 4.14dB
	30MHz~1GHz: 3.37dB
	1GHz~40GHz: 4.08dB

7. TEST RESULT

7.1. Summary

Product Name: WiFi AP Router Module
FCC Classification: (DTS) Digital Transmission System
Data Rate(s) Tested: 1Mbps ~ 11Mbps (b); 6Mbps ~ 54Mbps (g);
6.5/7.2Mbps ~ 65/72.2Mbps (n-20M);
13.5/15.0Mbps ~ 135/150Mbps (n-40M)

FCC Part Section(s)	Test Description	Test Limit	Test Condition	Test Result	Reference
15.247(a)(2)	6dB Bandwidth	$\geq 500\text{kHz}$	Conducted	Pass	Section 7.2
15.247(b)(3)	Output Power	$\leq 30.00\text{dBm}$		Pass	Section 7.3
15.247(e)	Power Spectral Density	$\leq 8.00\text{dBm}/3\text{kHz}$		Pass	Section 7.4
15.247(d)	Out-of-Band Emissions	Conducted $\geq 20\text{dBc}$		Pass	Section 7.5
15.205 15.209	Spurious Emission	< FCC 15.209 limits	Radiated	Pass	Section 7.6
15.205 15.209	Band Edge Measurement	$\leq 74\text{dBuV}/\text{m}(\text{Peak})$ $\leq 54\text{dBuV}/\text{m}(\text{Average})$		Pass	Section 7.7
15.207	AC Conducted Emissions 150kHz - 30MHz	< FCC 15.207 limits	Line Conducted	Pass	Section 7.8

Notes:

- 1) All modes of operation and data rates were investigated. The test results shown in the following sections represent the worst case emissions.
- 2) The analyzer plots shown in this section were all taken with a correction table loaded into the analyzer. The correction table was used to account for the losses of the cables and attenuators used as part of the system to connect the EUT to the analyzer at all frequencies of interest.
- 3) All antenna port conducted emissions testing was performed on a test bench with the antenna port of the EUT connected to the spectrum analyzer through calibrated cables and attenuators.

7.2. 6dB Bandwidth Measurement

7.2.1. Test Limit

The minimum 6dB bandwidth shall be at least 500 kHz.

7.2.2. Test Procedure used

KDB 558074 D01v04- Section 8.2 Option 2

7.2.3. Test Setting

1. The Spectrum's automatic bandwidth measurement capability was used to perform the 6dB bandwidth measurement. The "X" dB bandwidth parameter was set to $X = 6$. The bandwidth measurement was not influenced by any intermediate power nulls in the fundamental emission.
2. Set RBW = 100 kHz
3. $VBW \geq 3 \times RBW$
4. Detector = Peak
5. Trace mode = max hold
6. Sweep = auto couple
7. Allow the trace was allowed to stabilize

7.2.4. Test Setup

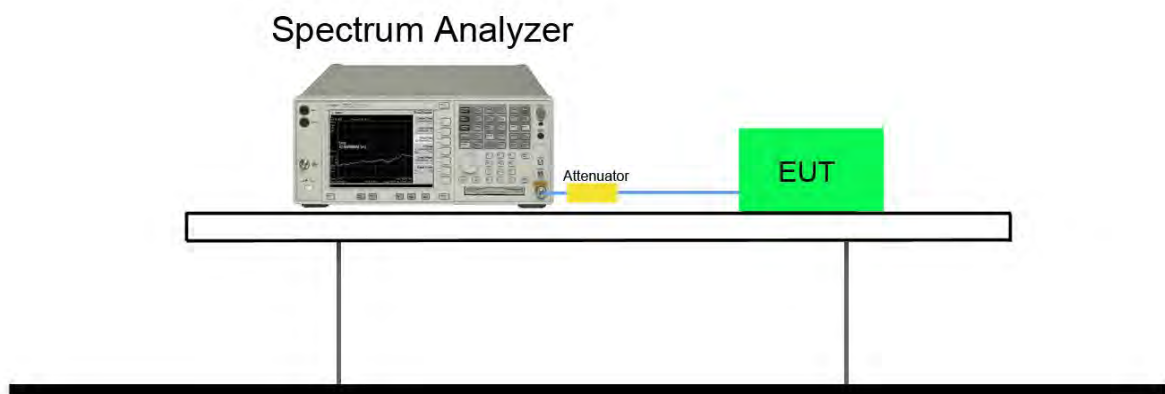

7.2.5. Test Result

Test Mode	Channel No.	Frequency (MHz)	6dB Bandwidth (MHz)	99% Bandwidth (MHz)	Limit (MHz)	Result
802.11b	01	2412	12.14	15.053	≥ 0.5	Pass
802.11b	06	2437	12.14	15.053	≥ 0.5	Pass
802.11b	11	2462	12.14	15.064	≥ 0.5	Pass
802.11g	01	2412	16.58	16.449	≥ 0.5	Pass
802.11g	06	2437	16.59	16.463	≥ 0.5	Pass
802.11g	11	2462	16.61	16.513	≥ 0.5	Pass
802.11n-20M	01	2412	17.74	17.611	≥ 0.5	Pass
802.11n-20M	06	2437	17.74	17.606	≥ 0.5	Pass
802.11n-20M	11	2462	17.73	17.616	≥ 0.5	Pass
802.11n-40M	03	2422	36.50	36.057	≥ 0.5	Pass
802.11n-40M	06	2437	36.48	36.062	≥ 0.5	Pass
802.11n-40M	09	2452	36.49	36.091	≥ 0.5	Pass

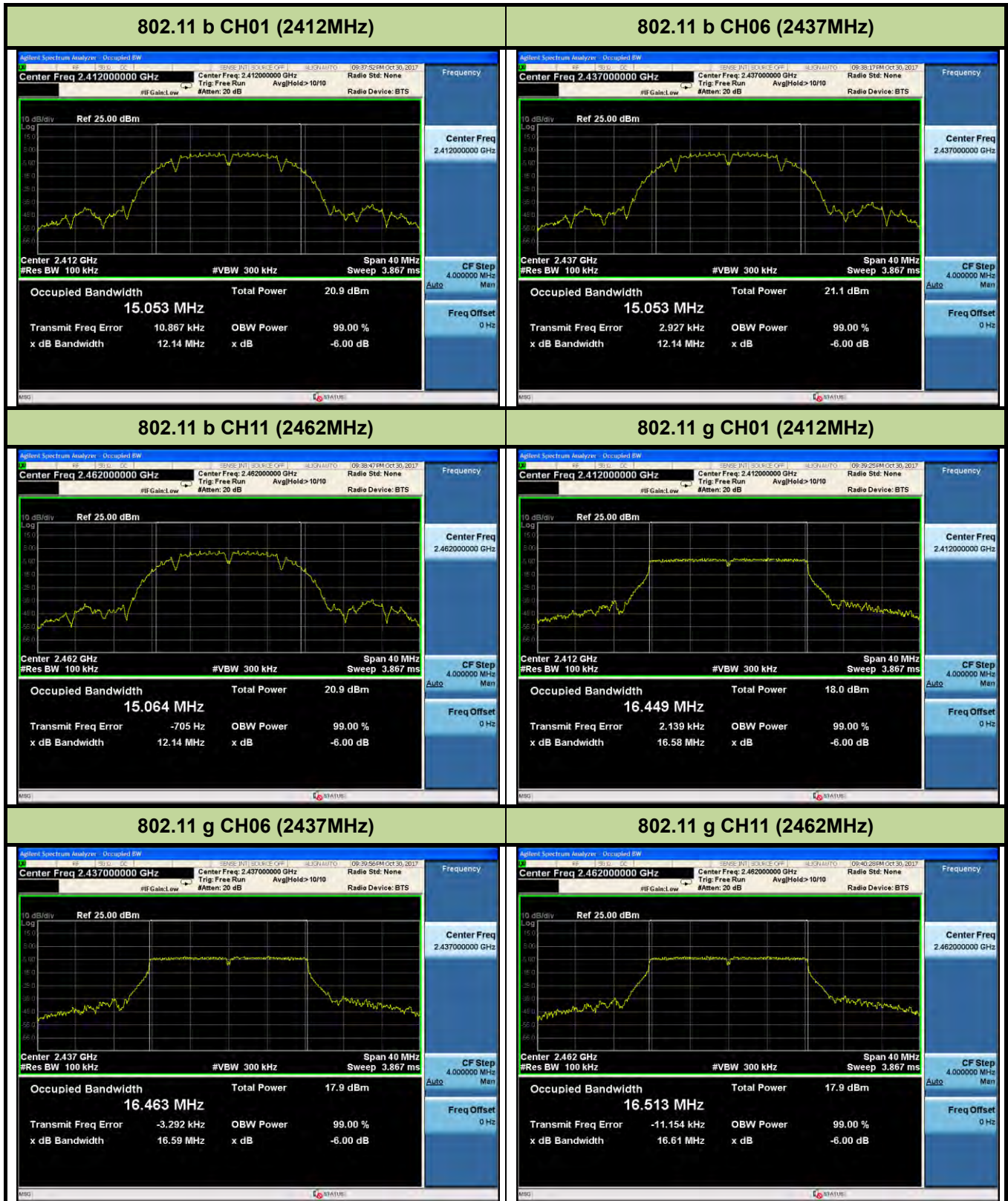

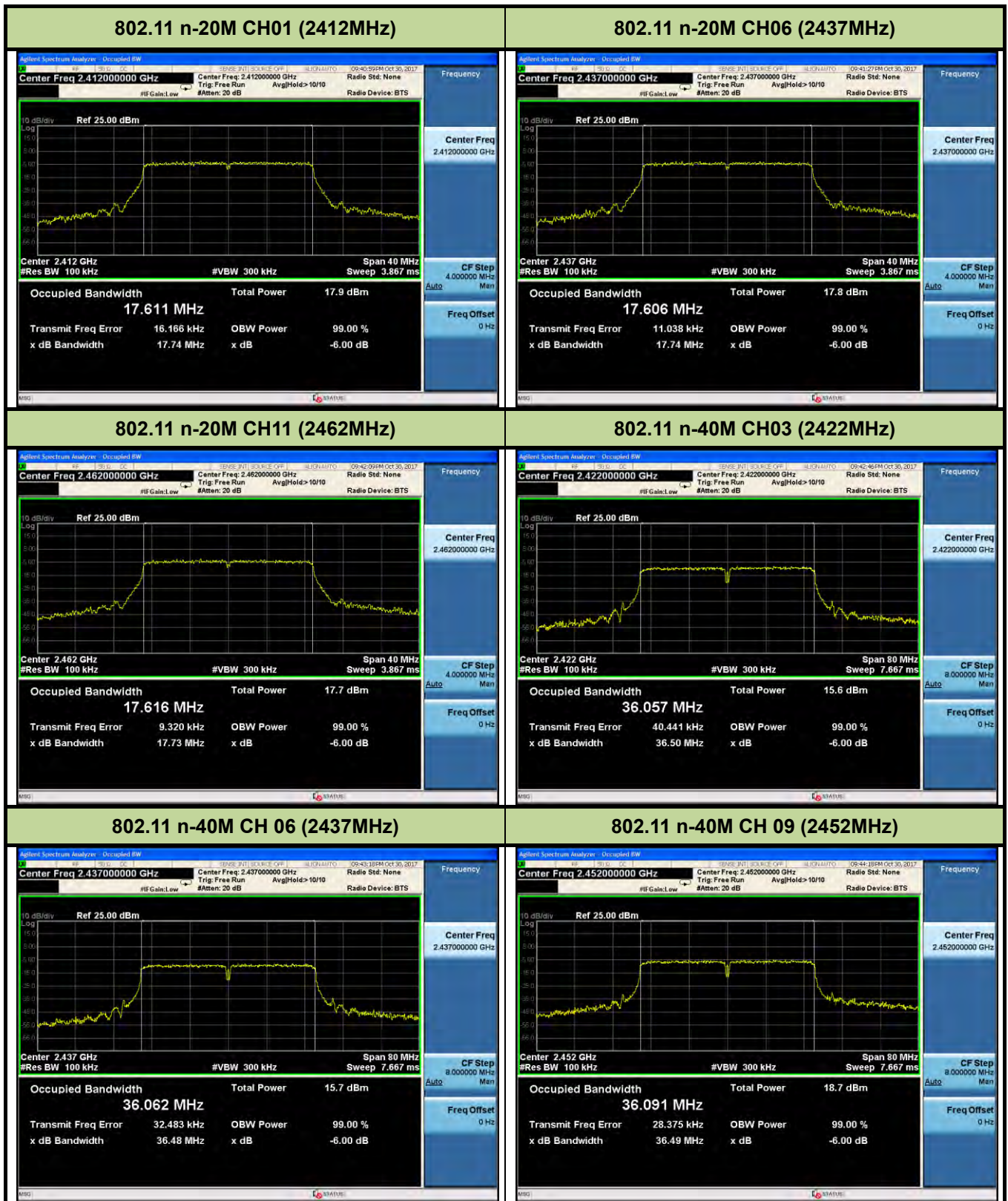

7.3. Output Power Measurement

7.3.1. Test Limit

The maximum out power shall be less 1 Watt (30dBm).

7.3.2. Test Procedure Used

KDB 558074 D01v04 - Section 9.1.2 & 9.2.3.2

7.3.3. Test Setting

Peak Power Measurement

The maximum peak conducted output power may be measured using a broadband peak RF power meter. The power meter shall have a video bandwidth that is greater than or equal to the DTS bandwidth and shall utilize a fast-responding diode detector.

Average Power Measurement

Average power measurements were performed only when the EUT was transmitting at its maximum power control level using a broadband power meter with a pulse sensor. The power meter implemented triggering and gating capabilities which were set up such that power measurements were recorded only during the ON time of the transmitter. The trace was averaged over 100 traces to obtain the final measured average power.

7.3.4. Test Setup

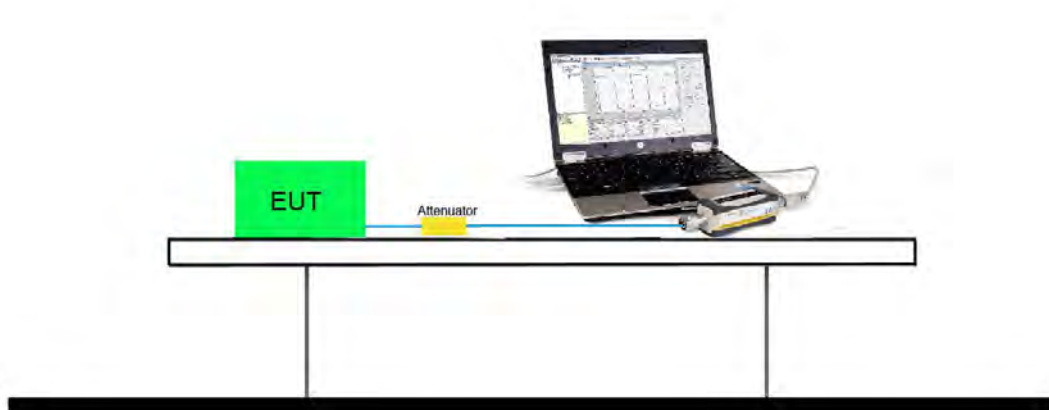

7.3.5. Test Result of Output Power

2.4GHz 802.11b RF Output Power (dBm)											
Channel No.	Frequency (MHz)	Average Power For different Data Rate (Mbps)				Peak Power	Required Limit				
		1	2	5.5	11						
01	2412	16.03	--	--	--	18.75	1Watt= 30 dBm				
06	2437	16.08	16.01	16.03	16.04	18.79	1Watt= 30 dBm				
11	2462	16.02	--	--	--	18.75	1Watt= 30 dBm				
2.4GHz 802.11g RF Output Power (dBm)											
Channel No.	Frequency (MHz)	Average Power For different Data Rate (Mbps)								Peak Power	Required Limit
		6	9	12	18	24	36	48	54		
01	2412	13.31	--	--	--	--	--	--	--	22.86	1Watt= 30 dBm
06	2437	13.18	13.17	13.17	13.16	13.16	13.14	13.12	13.1	22.97	1Watt= 30 dBm
11	2462	13.26	--	--	--	--	--	--	--	22.98	1Watt= 30 dBm
2.4GHz 802.11n-20M RF Output Power (dBm)											
Channel No.	Frequency (MHz)	Average Power For different Data Rate (Mbps)								Peak Power	Required Limit
		MCS0	MCS1	MCS2	MCS3	MCS4	MCS5	MCS6	MCS7		
01	2412	13.15	--	--	--	--	--	--	--	22.77	1Watt= 30 dBm
06	2437	13.19	13.18	13.17	13.16	13.16	13.15	13.14	13.13	21.76	1Watt= 30 dBm
11	2462	13.21	--	--	--	--	--	--	--	22.16	1Watt= 30 dBm
2.4GHz 802.11n-40M RF Output Power (dBm)											
Channel No.	Frequency (MHz)	Average Power For different Data Rate (Mbps)								Peak Power	Required Limit
		MCS0	MCS1	MCS2	MCS3	MCS4	MCS5	MCS6	MCS7		
03	2422	10.74	--	--	--	--	--	--	--	19.99	1Watt= 30 dBm
06	2437	11.21	11.17	11.18	11.19	11.2	11.17	11.15	11.13	19.65	1Watt= 30 dBm
09	2452	11.15	--	--	--	--	--	--	--	19.77	1Watt= 30 dBm

Note: Output power = Reading value on power meter + cable loss ◦

7.4. Power Spectral Density Measurement

7.4.1. Test Limit

The maximum permissible power spectral density is 8dBm in any 3 kHz band.

7.4.2. Test Procedure Used

KDB 558074 D01v04 - Section 10.2 Method PKPSD

7.4.3. Test Setting

This procedure shall be used if maximum peak conducted output power was used to demonstrate compliance, and is optional if the maximum conducted (average) output power was used to demonstrate compliance.

- a) Set analyzer center frequency to DTS channel center frequency.
- b) Set the span to 1.5 times the DTS bandwidth.
- c) Set the RBW to: 3 kHz.
- d) Set the VBW $\geq 3^*$ RBW.
- e) Detector = peak.
- f) Sweep time = auto couple.
- g) Trace mode = max hold.
- h) Allow trace to fully stabilize.
- i) Use the peak marker function to determine the maximum amplitude level within the RBW.

7.4.4. Test Setup

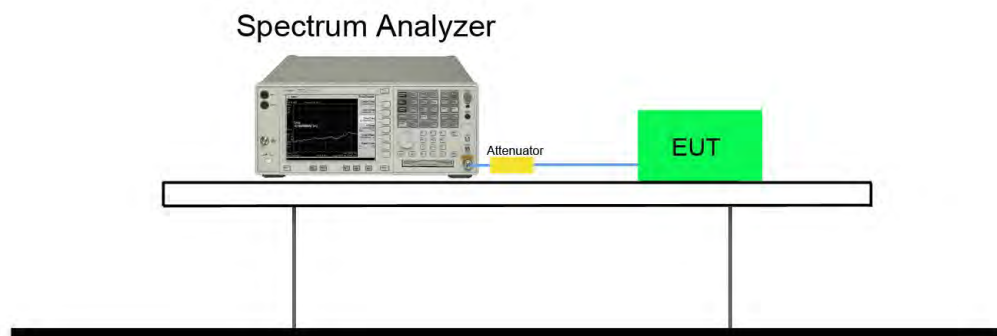

7.4.5. Test Result

Test Mode	Channel No.	Freq. (MHz)	PSD (dBm)	Limit (dBm)	Result
11b	1	2412	-12.020	≤ 8	Pass
11b	6	2437	-12.260	≤ 8	Pass
11b	11	2462	-12.370	≤ 8	Pass
11g	1	2412	-10.630	≤ 8	Pass
11g	6	2437	-12.180	≤ 8	Pass
11g	11	2462	-12.080	≤ 8	Pass
11n-20M	1	2412	-10.410	≤ 8	Pass
11n-20M	6	2437	-11.920	≤ 8	Pass
11n-20M	11	2462	-12.760	≤ 8	Pass
11n-40M	3	2422	-15.070	≤ 8	Pass
11n-40M	6	2437	-14.990	≤ 8	Pass
11n-40M	9	2452	-14.788	≤ 8	Pass

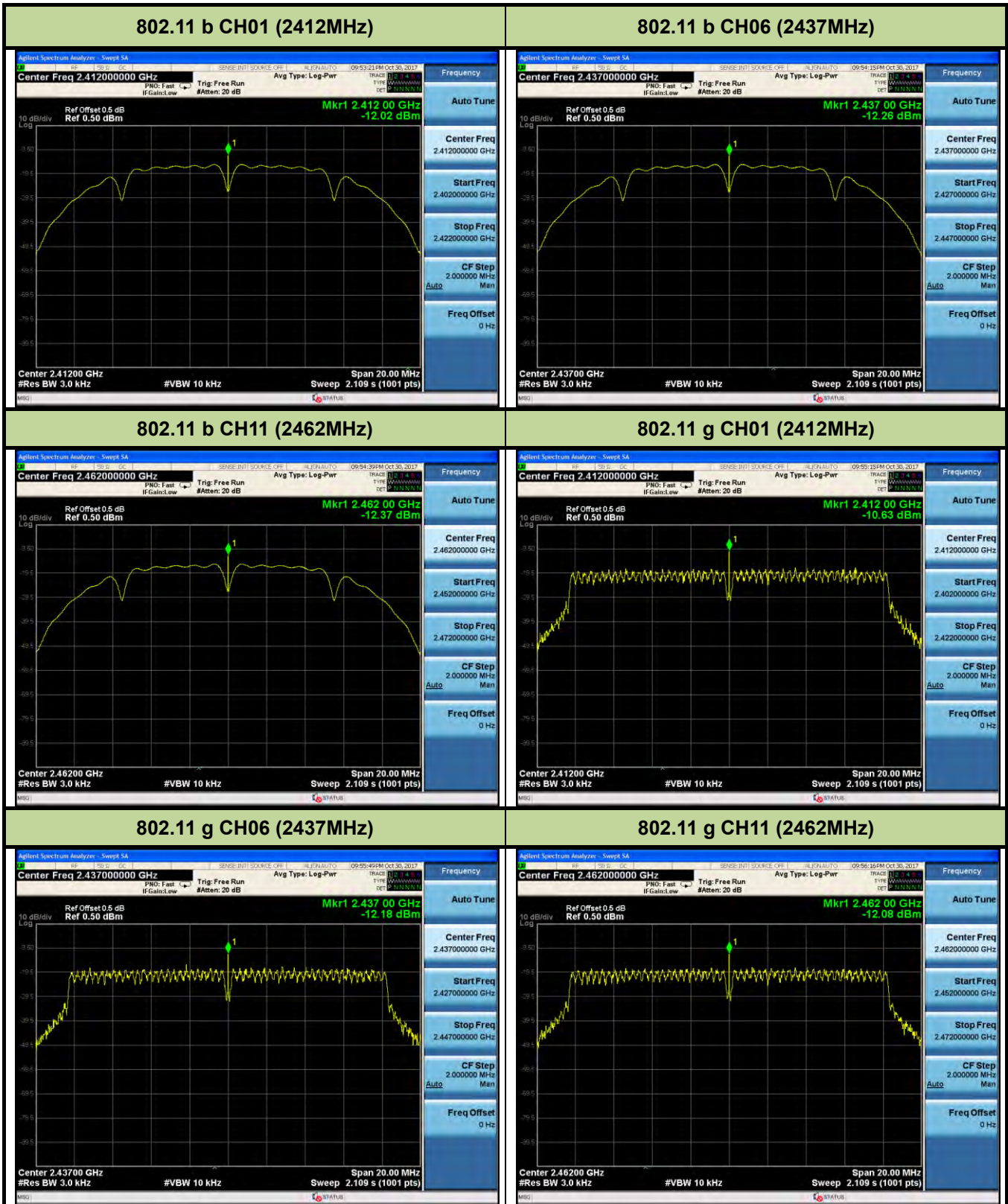

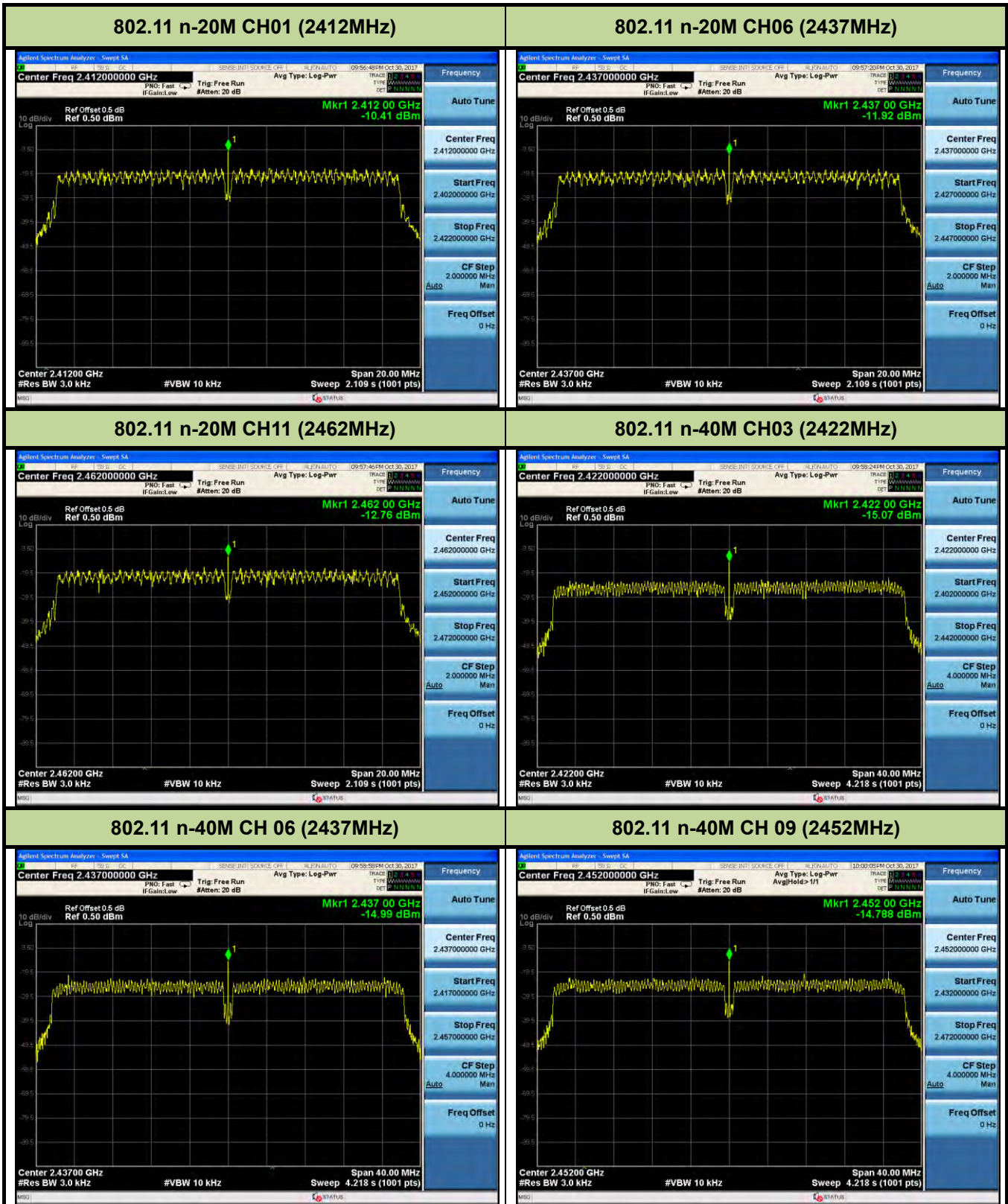

7.5. Out-of-Band Spurious Emissions Emissions Measurement

7.5.1. Test Limit

In any 100 kHz bandwidth outside the frequency band in which the spread spectrum or digitally modulated intentional radiator is operating, the radio frequency power that is produced by the intentional radiator shall be at least 20 dB below that in the 100 kHz bandwidth within the band that contains the highest level of the desired power, based on RF conducted measurement, provided the transmitter demonstrates compliance with the peak conducted power limits.

7.5.2. Test Procedure Used

KDB 558074 D01v04- Section 11.1 & 11.2

7.5.3. Test Settling

- (a) Set instrument center frequency to DTS channel center frequency
- (b) Set the span to ≥ 1.5 times the DTS bandwidth
- (c) Set the RBW = 100 kHz
- (d) Set the VBW $\geq 3 \times$ RBW
- (e) Detector = peak
- (f) Sweep time = auto couple
- (g) Trace mode = max hold
- (h) Allow trace to fully stabilize

7.5.4. Test Setup

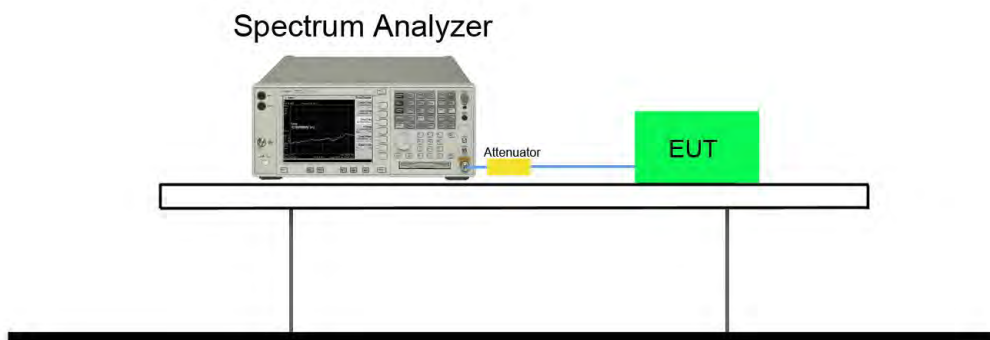

7.5.5. Test Result

Test Mode	Channel No.	Frequency (MHz)	Limit	Result
802.11b	01	2412	20dBc	Pass
802.11b	06	2437	20dBc	Pass
802.11b	11	2462	20dBc	Pass
802.11g	01	2412	20dBc	Pass
802.11g	06	2437	20dBc	Pass
802.11g	11	2462	20dBc	Pass
802.11n-20M	01	2412	20dBc	Pass
802.11n-20M	06	2437	20dBc	Pass
802.11n-20M	11	2462	20dBc	Pass
802.11n-40M	03	2422	20dBc	Pass
802.11n-40M	06	2437	20dBc	Pass
802.11n-40M	09	2452	20dBc	Pass

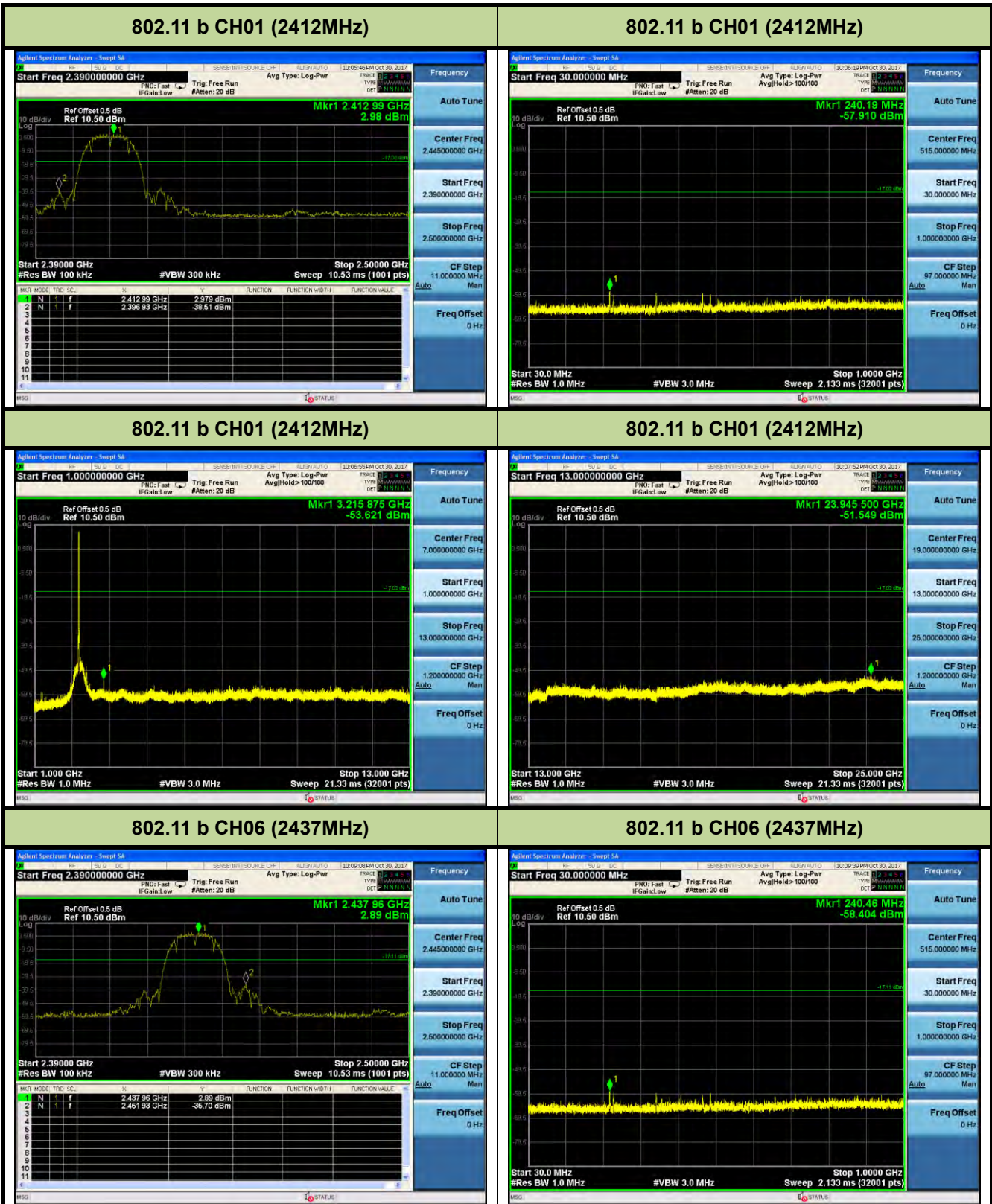

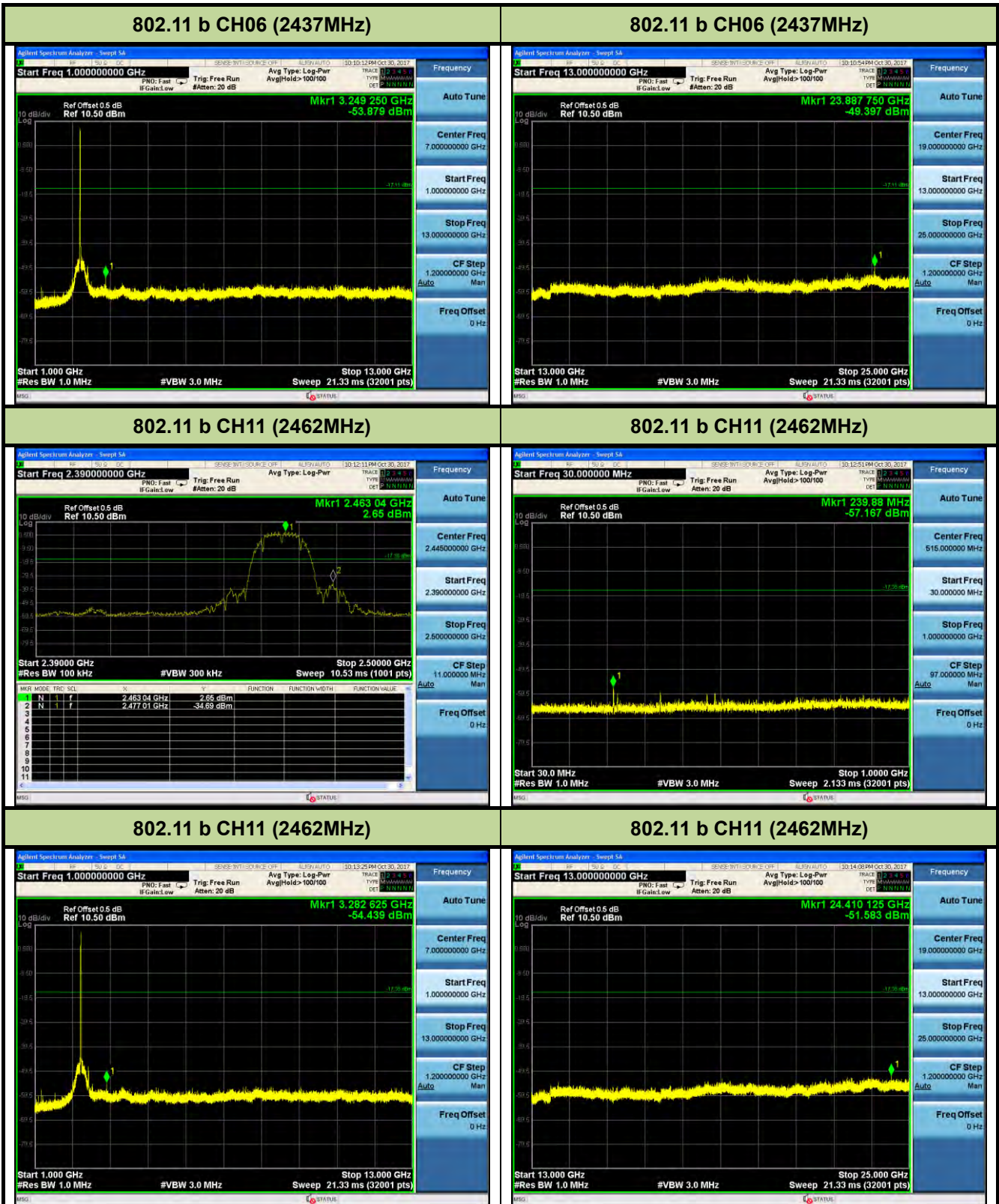

802.11 g CH01 (2412MHz)

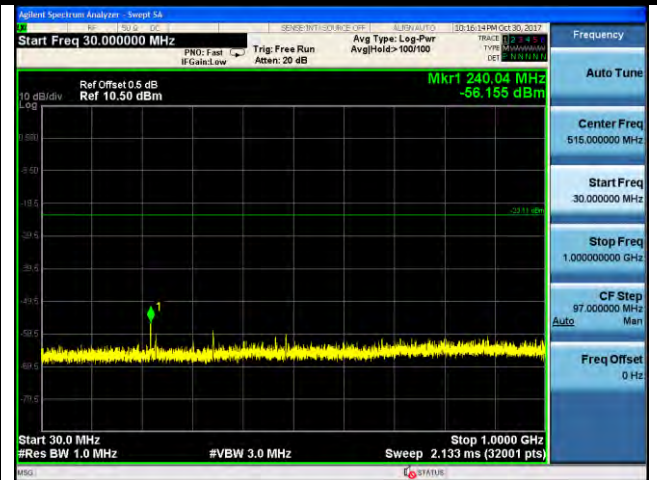
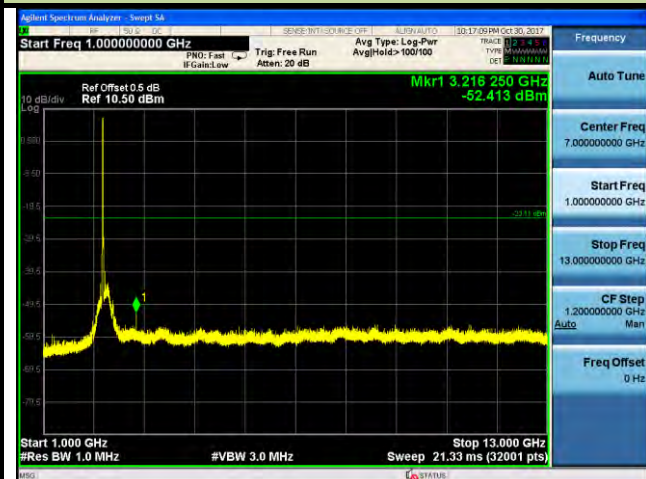
802.11 g CH01 (2412MHz)

802.11 g CH01 (2412MHz)

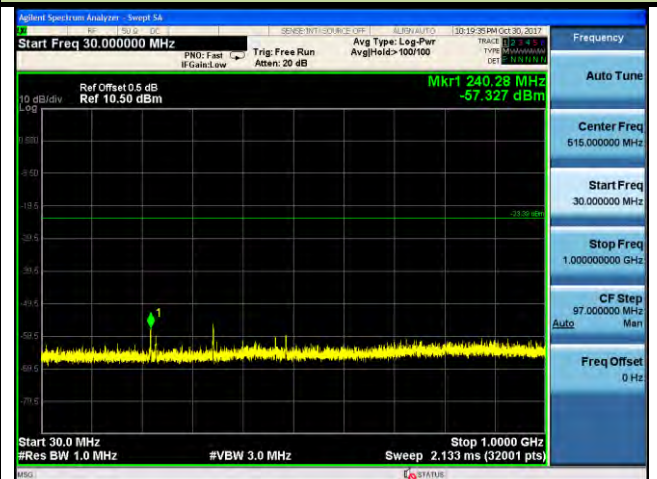
802.11 g CH01 (2412MHz)

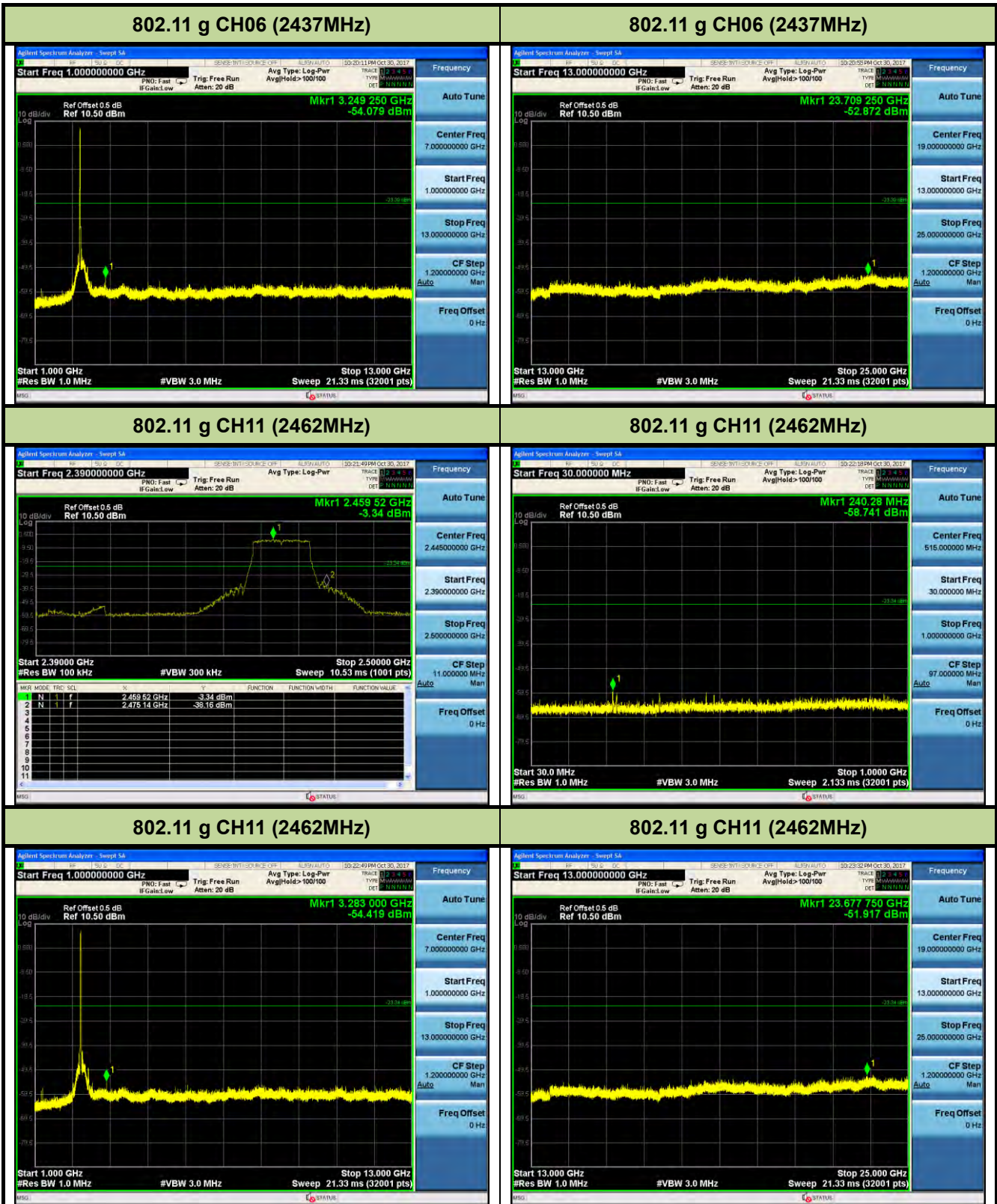
802.11 g CH06 (2437MHz)

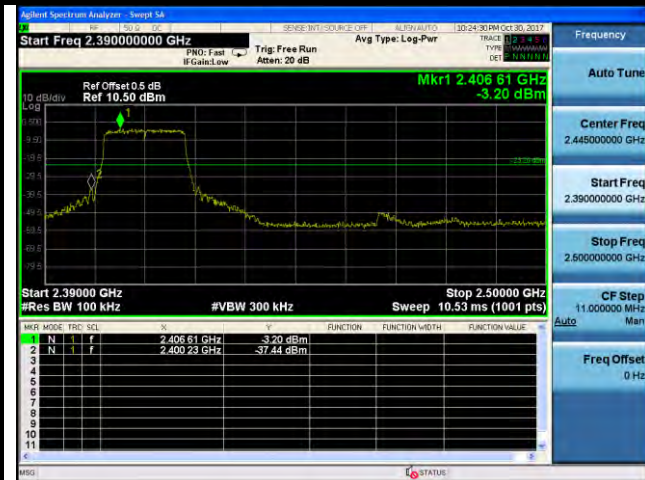
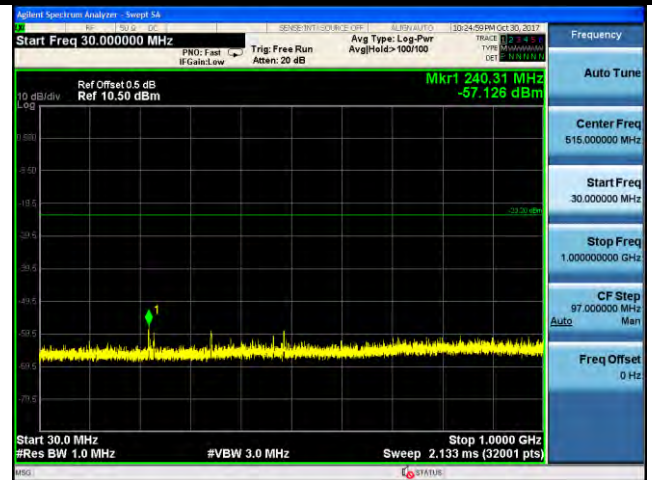
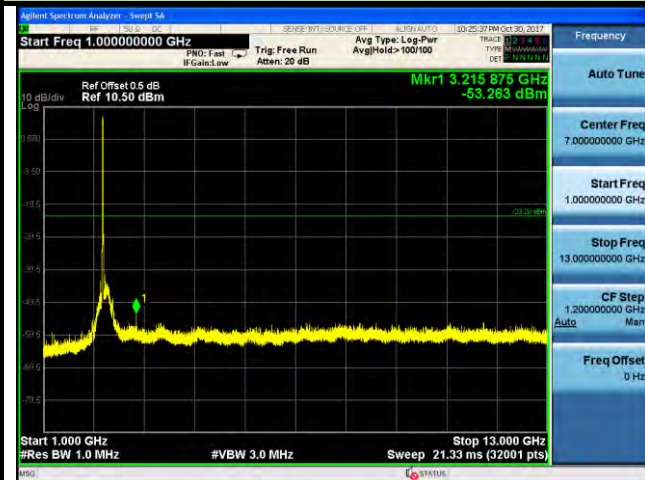
802.11 g CH06 (2437MHz)

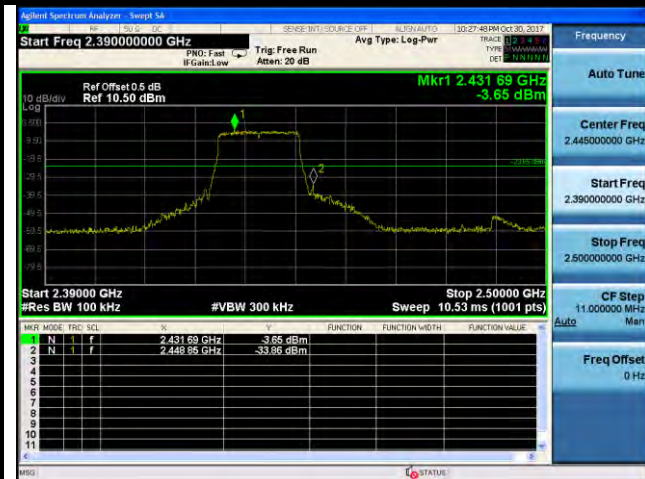
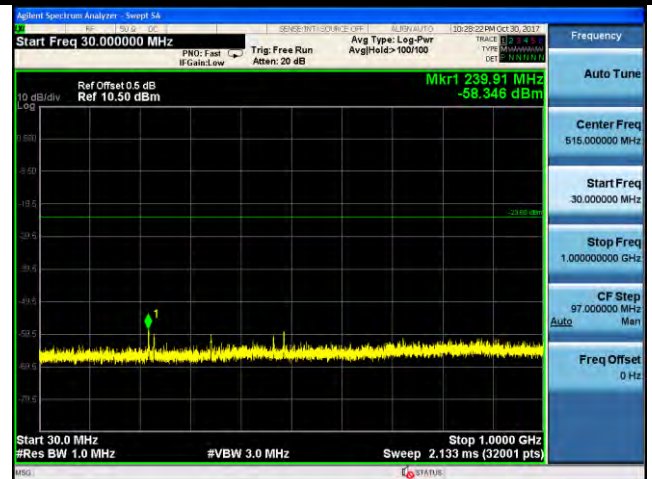

802.11 n-20 CH01 (2412MHz)

802.11 n-20 CH01 (2412MHz)

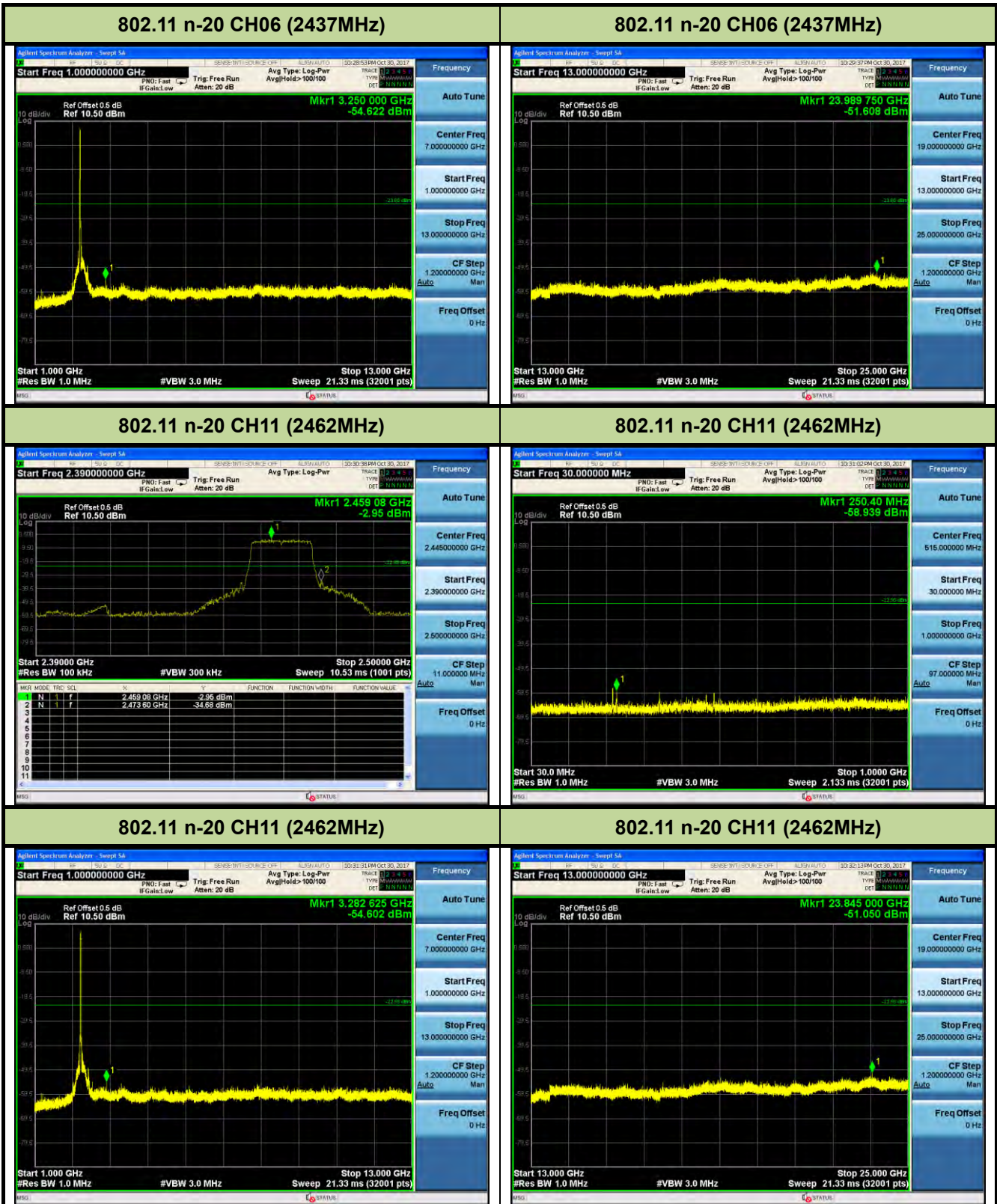
802.11 n-20 CH01 (2412MHz)

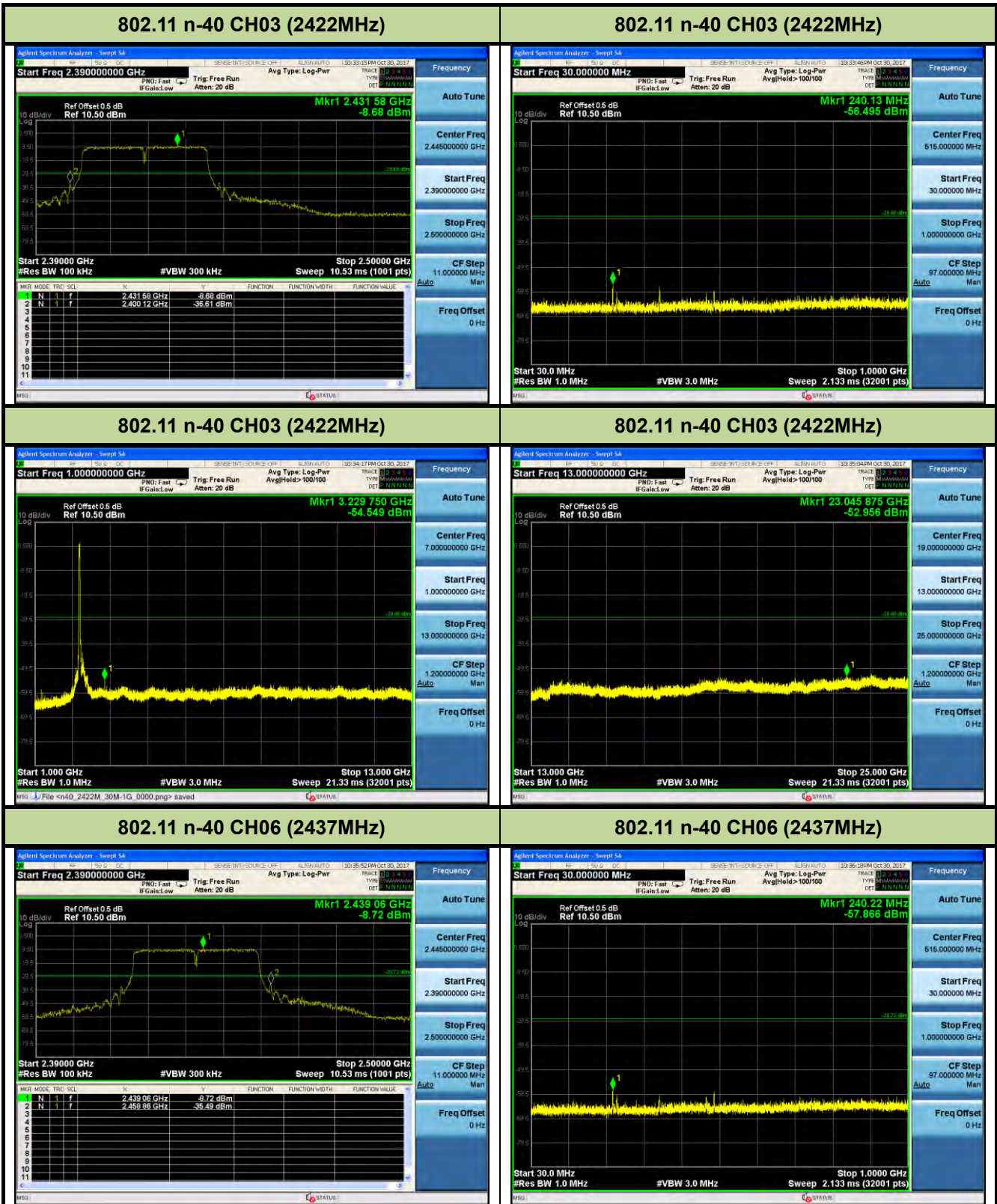
802.11 n-20 CH01 (2412MHz)

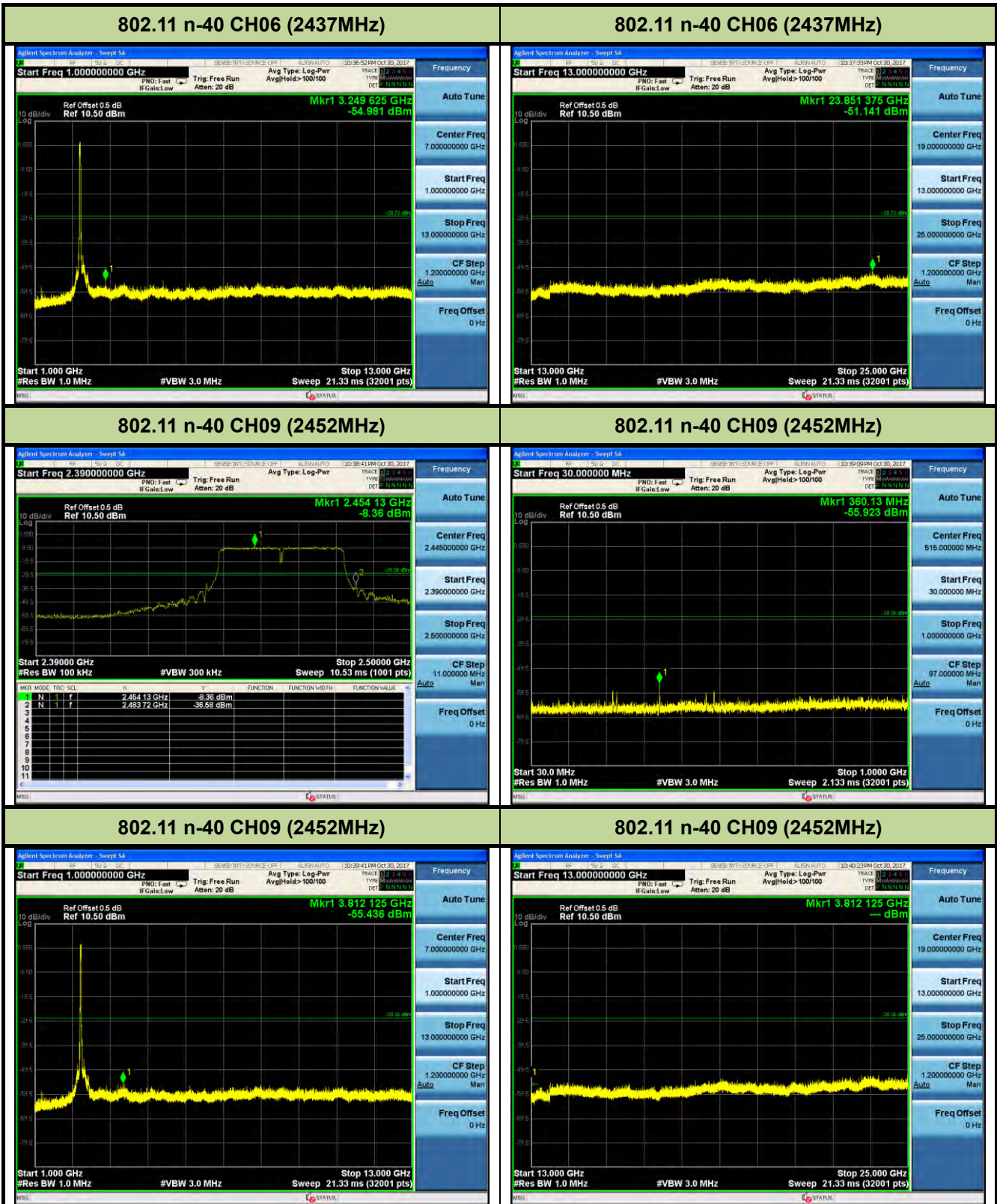
802.11 n-20 CH06 (2437MHz)

802.11 n-20 CH06 (2437MHz)







7.6. Radiated Spurious Emission Measurement

7.6.1. Test Limit

All out of band emissions appearing in a restricted band as specified in Section 15.205 of the Title 47 CFR must not exceed the limits shown in Table per Section 15.209.

FCC Part 15 Subpart C Paragraph 15.209		
Frequency [MHz]	Field Strength [V/m]	Measured Distance [Meters]
0.009 - 0.490	2400/F (kHz)	300
0.490 - 1.705	24000/F (kHz)	30
1.705 - 30	30	30
30 - 88	100	3
88 - 216	150	3
216 - 960	200	3
Above 960	500	3

7.6.2. Test Procedure Used

KDB 558074 D01v04- Section 12.2.3 (quasi-peak measurements)

KDB 558074 D01v04- Section 12.2.4 (peak power measurements)

KDB 558074 D01v04- Section 12.2.5 (average power measurements)

7.6.3. Test Setting

Peak Field Strength Measurements

1. Analyzer center frequency was set to the frequency of the radiated spurious emission of interest
2. RBW = as specified in Table 1
3. VBW = 3MHz
4. Detector = peak
5. Sweep time = auto couple

6. Trace mode = max hold

7. Trace was allowed to stabilize

Table 1 - RBW as a function of frequency

Frequency	RBW
9 ~ 150 kHz	200 ~ 300 Hz
0.15 ~ 30 MHz	9 ~ 10 kHz
30 ~ 1000 MHz	100 ~ 120 kHz
> 1000 MHz	1 MHz

Average Field Strength Measurements

1. Analyzer center frequency was set to the frequency of the radiated spurious emission of interest

2. RBW = 1MHz

3. VBW \geq 1/T

4. De As an alternative, the instrument may be set to linear detector mode. Ensure that video filtering is applied in linear voltage domain (rather than in a log or dB domain). Some instruments require linear display mode in order to accomplish this. Others have a setting for Average-VBW Type, which can be set to "Voltage" regardless of the display mode

5. Detector = Peak

6. Sweep time = auto

7. Trace mode = max hold

8. Allow max hold to run for at least 50 times (1/duty cycle) traces

7.6.4. Test Setup

9kHz ~ 30MHz Test Setup:

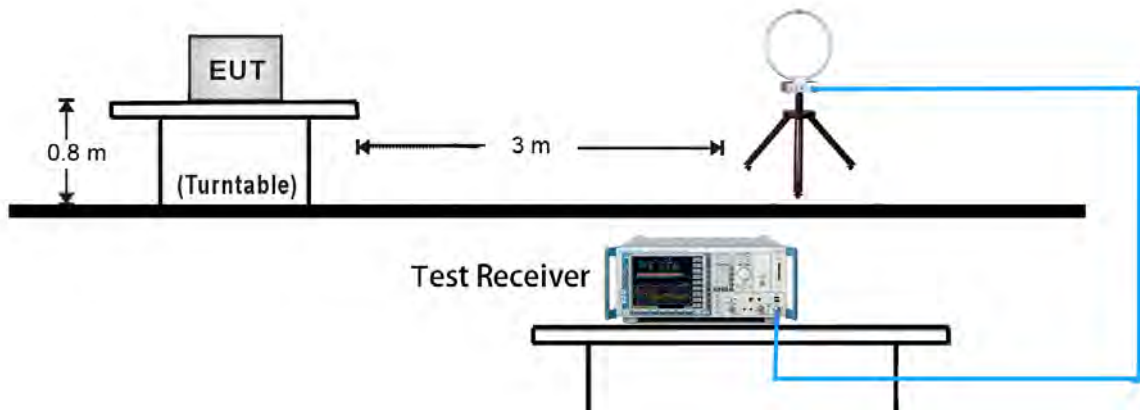

30MHz ~ 1GHz Test Setup:

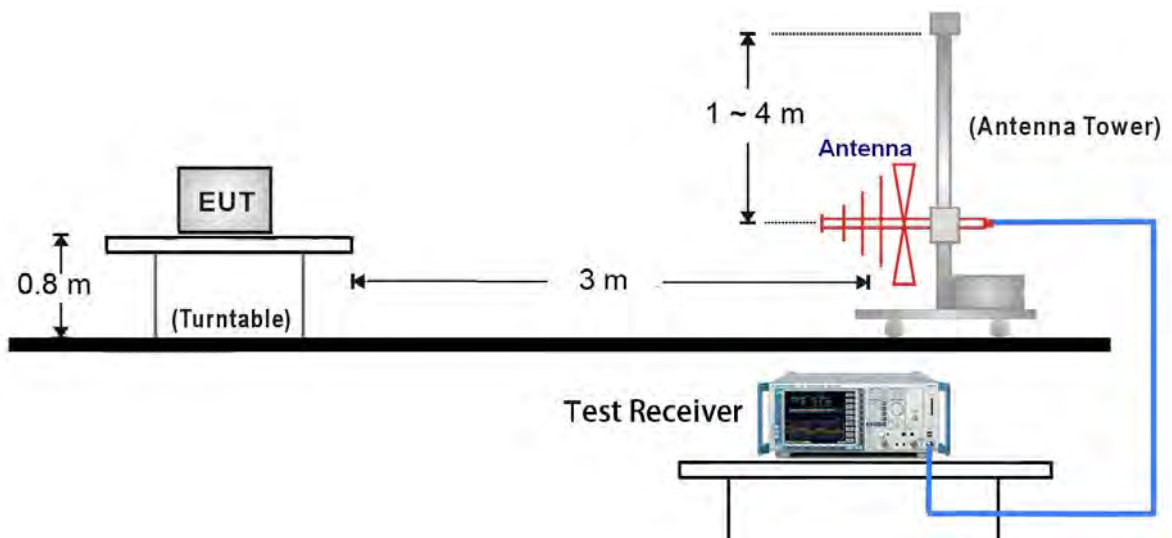

1GHz ~ 18GHz Test Setup:

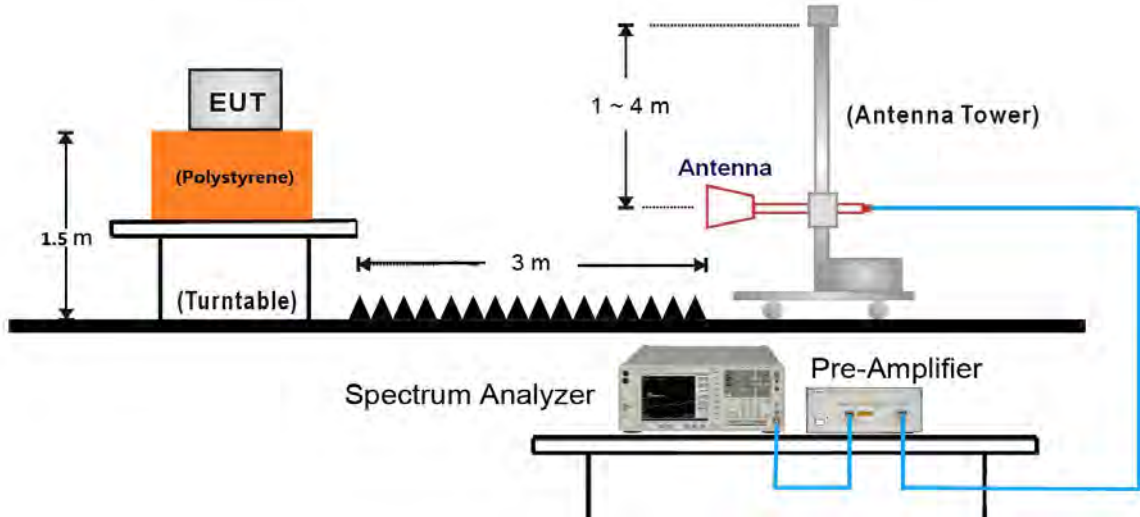

18GHz ~25GHz Test Setup:

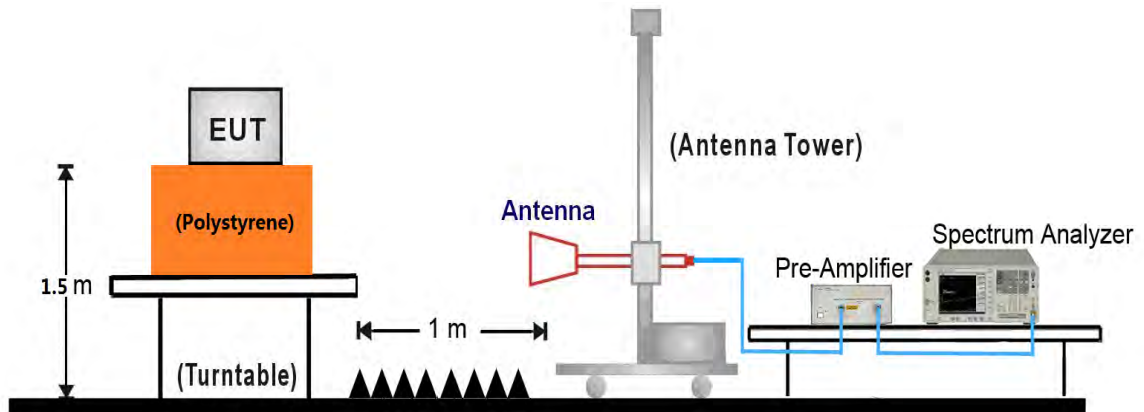

7.6.5. Test Result

EUT	WIFI CONTROL BOX	Test Date	2017/11/06
Factor	VULB 9162 (30MHz~8GHz)	Temp. / Humidity	20°C / 58%
Polarity	Horizontal	Site / Engineer	AC1 / Peter
Test Mode	MODE3-CH06	Test Voltage	AC 120V/60Hz

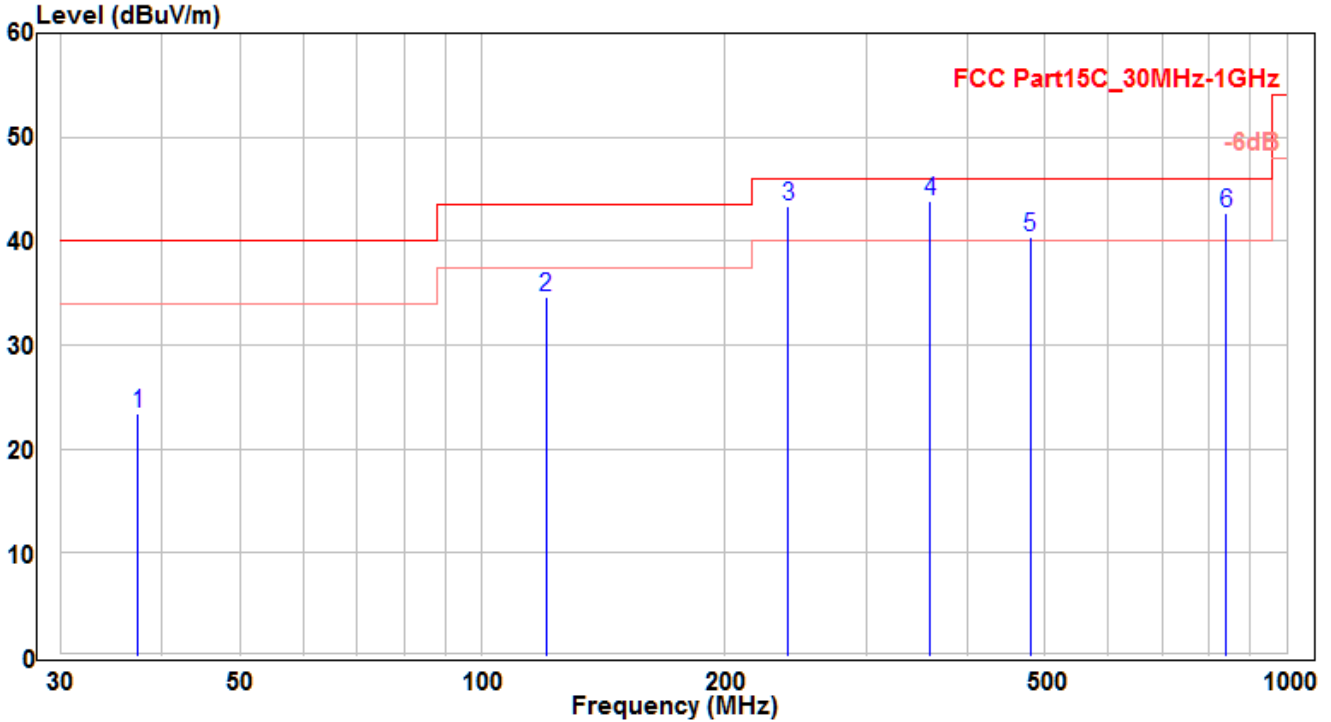

No	Frequency (MHz)	Reading (dBUV/m)	C.F (dB)	Measurement (dBUV/m)	Margin (dB)	Limit (dBUV/m)	Height (cm)	Angle (deg)	Remark (QP/PK/AV)
1	37.336	3.72	19.69	23.41	-16.59	40	175	400	QP
2	119.998	17.54	17.14	34.68	-8.82	43.5	190	320	QP
3	239.975	23.1	20.2	43.3	-2.7	46	150	345	QP
4	* 359.982	20.2	23.66	43.86	-2.14	46	150	185	QP
5	479.989	14.59	25.77	40.36	-5.64	46	175	145	QP
6	840.011	11.22	31.47	42.69	-3.31	46	125	100	QP

Note :

- "*" means the worst value in this measurement data ◦
- Measure Level (dBUV/m) = Reading Level (dBUV) + Factor (dB) ◦
- Factor (dB) = Cable Loss (dB) + Antenna Factor (dB/m) ◦
- The emission levels of other frequencies are very lower than the limit and not show in test report ◦
- Other channel/mode was also verified. The test results shown represent the worst case emissions ◦
- No emission found between lowest internal used/generated frequency to 30MHz ◦

EUT	WIFI CONTROL BOX	Test Date	2017/11/06
Factor	VULB 9162 (30MHz~8GHz)	Temp. / Humidity	20°C / 58%
Polarity	Vertical	Site / Engineer	AC1 / Peter
Test Mode	MODE3-CH06	Test Voltage	AC 120V/60Hz

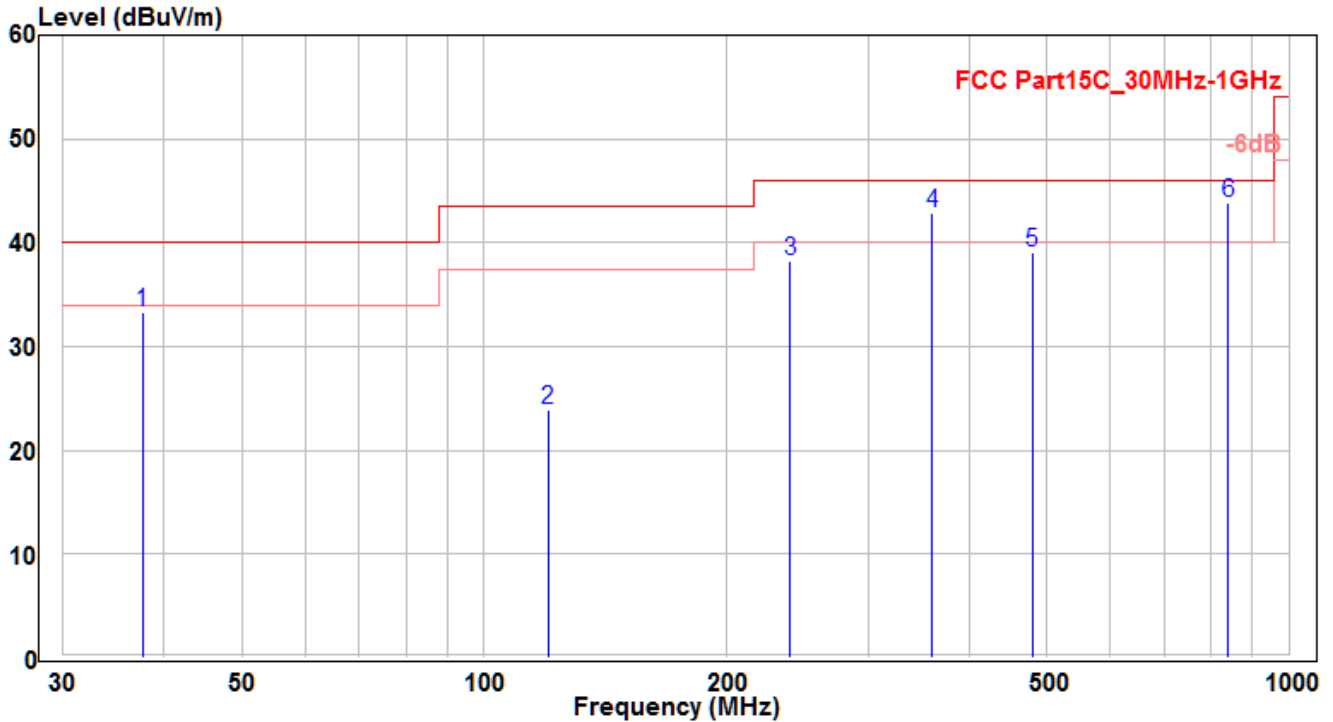

No	Frequency (MHz)	Reading (dBuV/m)	C.F (dB)	Measurement (dBuV/m)	Margin (dB)	Limit (dBuV/m)	Height (cm)	Angle (deg)	Remark (QP/PK/AV)
1	37.608	13.46	19.77	33.23	-6.77	40	145	150	QP
2	119.998	6.76	17.14	23.9	-19.6	43.5	100	400	QP
3	240.005	18.08	20.2	38.28	-7.72	46	195	360	QP
4	359.982	19.15	23.66	42.81	-3.19	46	120	225	QP
5	479.989	13.36	25.77	39.13	-6.87	46	135	80	QP
6	* 840.011	12.41	31.47	43.88	-2.12	46	155	380	QP

Note :

- "*" means the worst value in this measurement data °
- Measure Level (dBuV/m) = Reading Level (dBuV) + Factor (dB) °
- Factor (dB) = Cable Loss (dB) + Antenna Factor (dB/m) °
- The emission levels of other frequencies are very lower than the limit and not show in test report °
- Other channel/mode was also verified. The test results shown represent the worst case emissions °
- No emission found between lowest internal used/generated frequency to 30MHz °

EUT	WIFI CONTROL BOX	Test Date	2017/11/01
Factor	BBHA 9120D (1GHz~18GHz)	Temp. / Humidity	20°C / 58%
Polarity	Horizontal	Site / Engineer	AC1 / Peter
Test Mode	MODE1-CH01	Test Voltage	AC 120V/60Hz

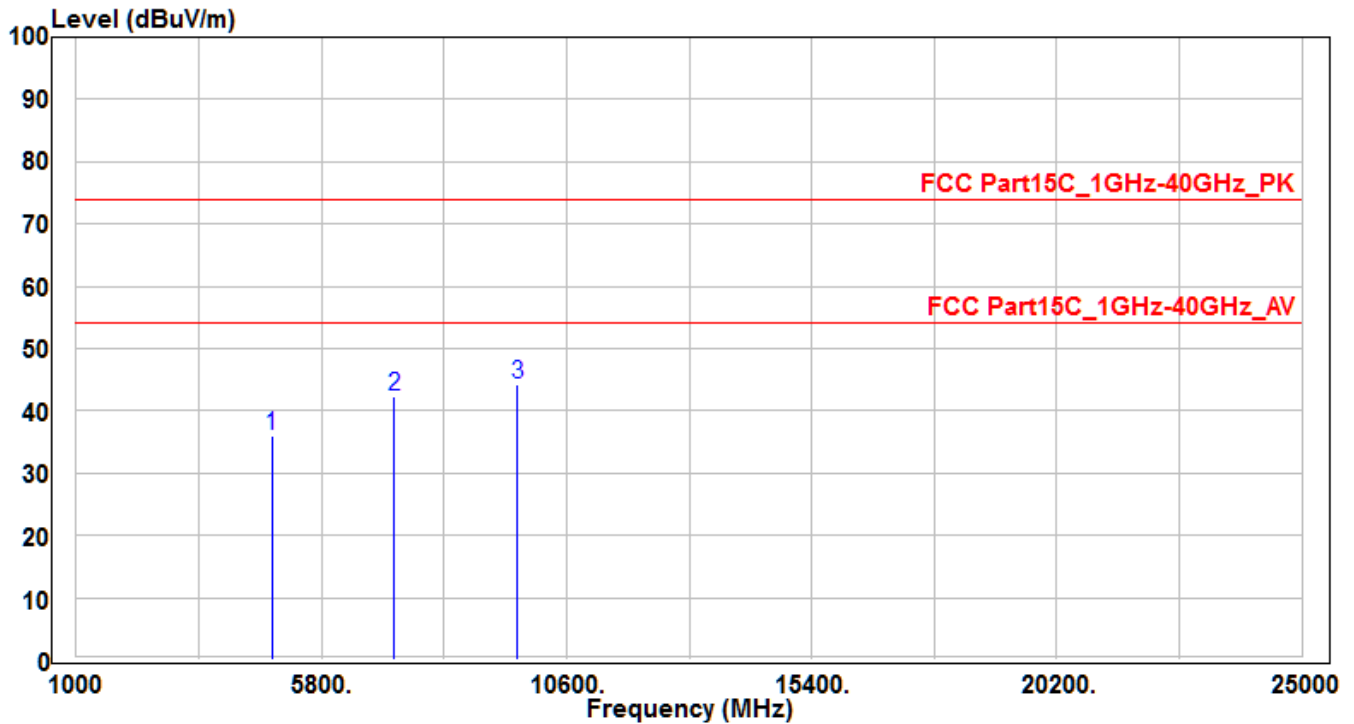

No	Frequency (MHz)	Reading (dBuV/m)	C.F (dB)	Measurement (dBuV/m)	Margin (dB)	Limit (dBuV/m)	Height (cm)	Angle (deg)	Remark (QP/PK/AV)
1	4824	33.34	2.73	36.07	-37.93	74	150	400	Peak
2	7236	30.96	11.4	42.36	-31.64	74	150	400	Peak
3	* 9648	29.78	14.56	44.34	-29.66	74	150	400	Peak

Note :

- " * " means the worst value in this measurement data ◦
- Measure Level (dBμV/m) = Reading Level (dBμV) + Factor (dB) ◦
- Factor (dB) = Cable Loss (dB) + Antenna Factor (dB/m) ◦
- The emission levels of other frequencies are very lower than the limit and not show in test report ◦

EUT	WIFI CONTROL BOX	Test Date	2017/11/01
Factor	BBHA 9120D (1GHz~18GHz)	Temp. / Humidity	20°C / 58%
Polarity	Vertical	Site / Engineer	AC1 / Peter
Test Mode	MODE1-CH01	Test Voltage	AC 120V/60Hz

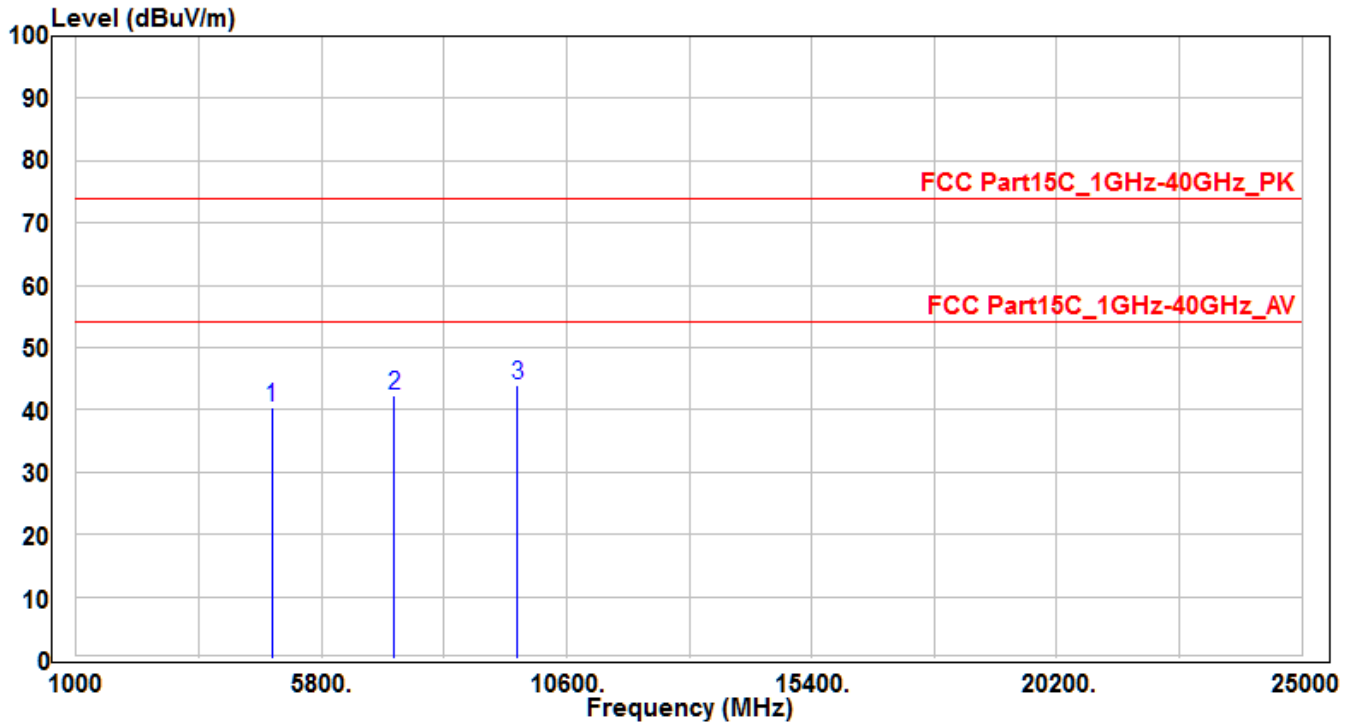

No	Frequency (MHz)	Reading (dBuV/m)	C.F (dB)	Measurement (dBuV/m)	Margin (dB)	Limit (dBuV/m)	Height (cm)	Angle (deg)	Remark (QP/PK/AV)
1	4824	37.75	2.73	40.48	-33.52	74	150	400	Peak
2	7236	30.96	11.4	42.36	-31.64	74	150	400	Peak
3	* 9648	29.39	14.56	43.95	-30.05	74	150	400	Peak

Note :

- " * " means the worst value in this measurement data ◦
- Measure Level (dBμV/m) = Reading Level (dBμV) + Factor (dB) ◦
- Factor (dB) = Cable Loss (dB) + Antenna Factor (dB/m) ◦
- The emission levels of other frequencies are very lower than the limit and not show in test report ◦

EUT	WIFI CONTROL BOX	Test Date	2017/11/01
Factor	BBHA 9120D (1GHz~18GHz)	Temp. / Humidity	20°C / 58%
Polarity	Horizontal	Site / Engineer	AC1 / Peter
Test Mode	MODE1-CH06	Test Voltage	AC 120V/60Hz

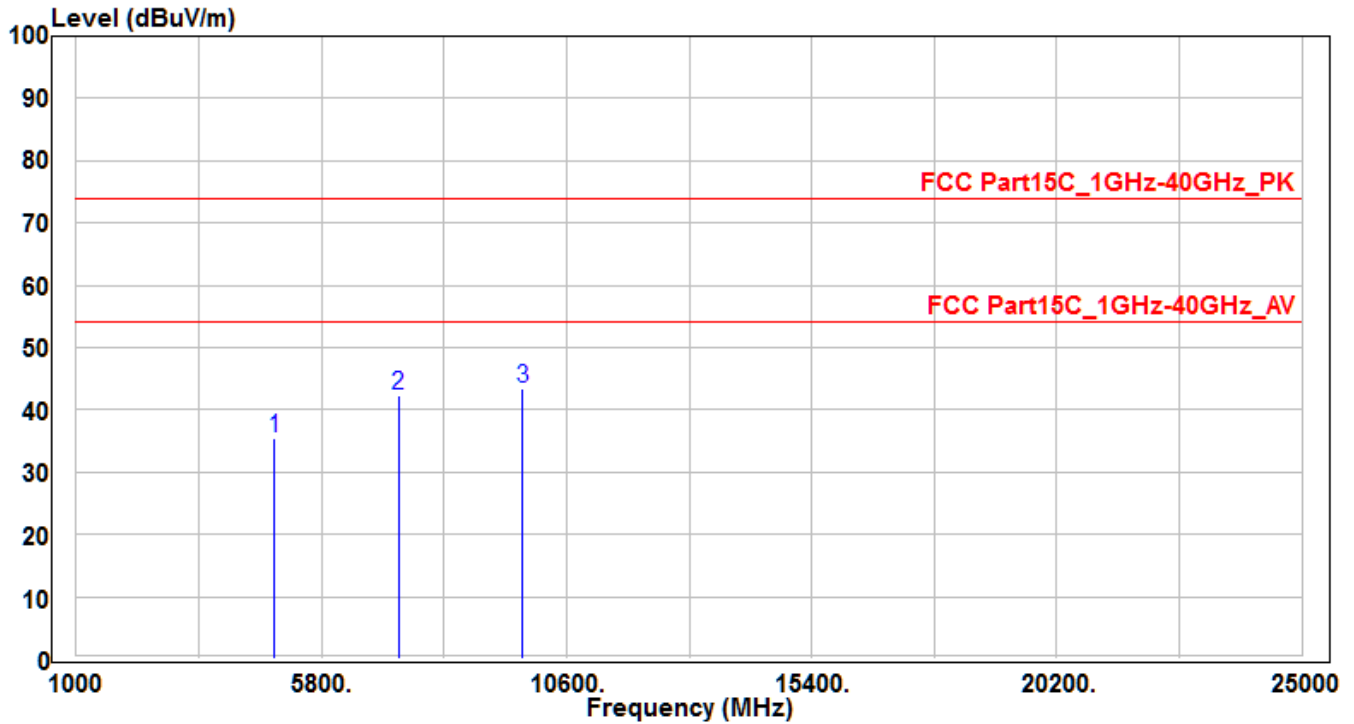

No	Frequency (MHz)	Reading (dBuV/m)	C.F (dB)	Measurement (dBuV/m)	Margin (dB)	Limit (dBuV/m)	Height (cm)	Angle (deg)	Remark (QP/PK/AV)
1	4874	32.54	2.82	35.36	-38.64	74	150	400	Peak
2	7311	30.7	11.74	42.44	-31.56	74	150	400	Peak
3	* 9748	28.72	14.79	43.51	-30.49	74	150	400	Peak

Note :

- " * " means the worst value in this measurement data ◦
- Measure Level (dBuV/m) = Reading Level (dBuV) + Factor (dB) ◦
- Factor (dB) = Cable Loss (dB) + Antenna Factor (dB/m) ◦
- The emission levels of other frequencies are very lower than the limit and not show in test report ◦

EUT	WIFI CONTROL BOX	Test Date	2017/11/01
Factor	BBHA 9120D (1GHz~18GHz)	Temp. / Humidity	20°C / 58%
Polarity	Vertical	Site / Engineer	AC1 / Peter
Test Mode	MODE1-CH06	Test Voltage	AC 120V/60Hz

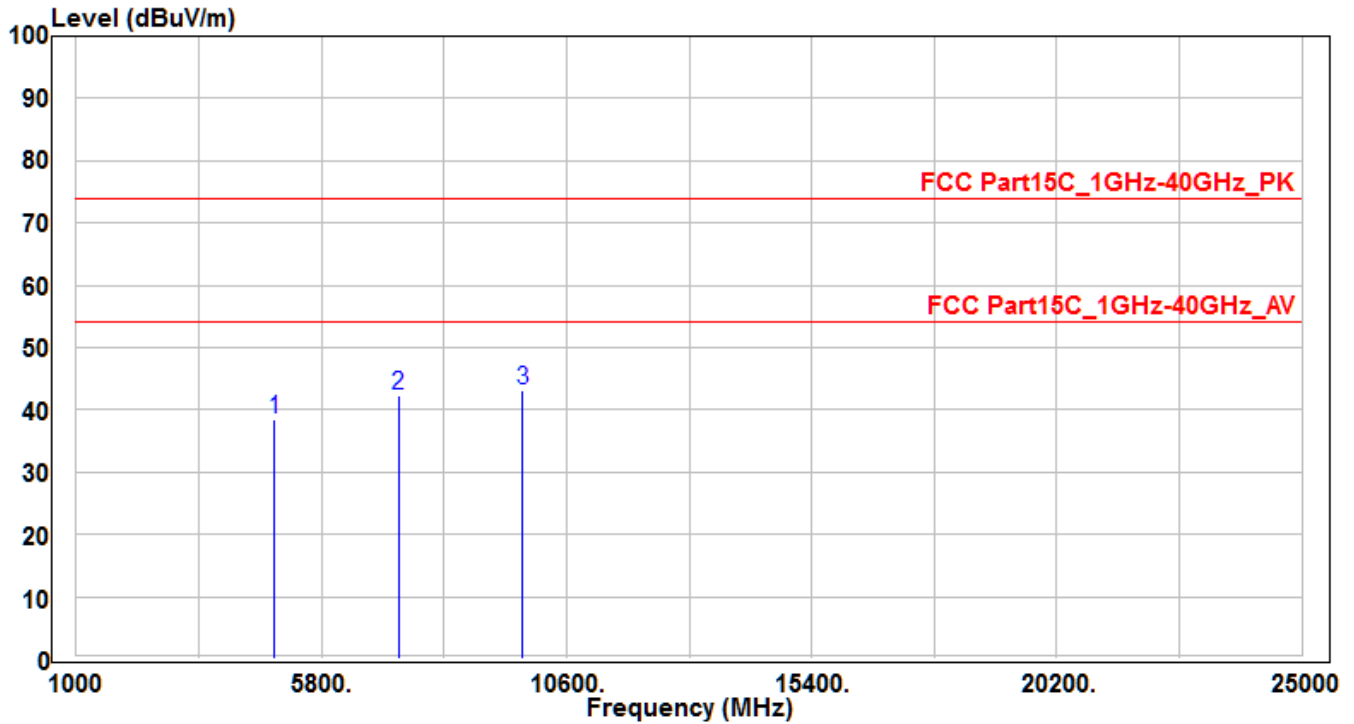

No	Frequency (MHz)	Reading (dBuV/m)	C.F (dB)	Measurement (dBuV/m)	Margin (dB)	Limit (dBuV/m)	Height (cm)	Angle (deg)	Remark (QP/PK/AV)
1	4874	35.7	2.82	38.52	-35.48	74	150	400	Peak
2	7311	30.62	11.74	42.36	-31.64	74	150	400	Peak
3	* 9748	28.33	14.79	43.12	-30.88	74	150	400	Peak

Note :

- "*" means the worst value in this measurement data °
- Measure Level (dBuV/m) = Reading Level (dBuV) + Factor (dB) °
- Factor (dB) = Cable Loss (dB) + Antenna Factor (dB/m) °
- The emission levels of other frequencies are very lower than the limit and not show in test report °

EUT	WIFI CONTROL BOX	Test Date	2017/11/01
Factor	BBHA 9120D (1GHz~18GHz)	Temp. / Humidity	20°C / 58%
Polarity	Horizontal	Site / Engineer	AC1 / Peter
Test Mode	MODE1-CH11	Test Voltage	AC 120V/60Hz

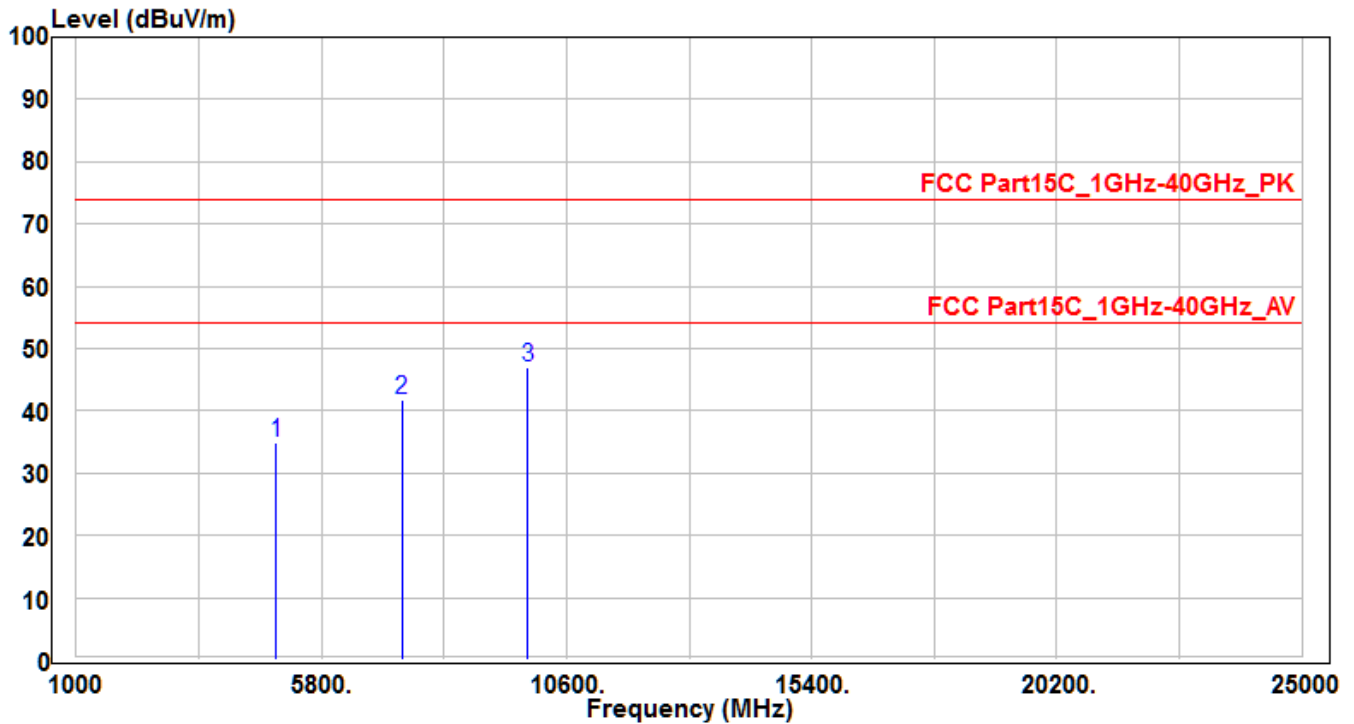

No	Frequency (MHz)	Reading (dBuV/m)	C.F (dB)	Measurement (dBuV/m)	Margin (dB)	Limit (dBuV/m)	Height (cm)	Angle (deg)	Remark (QP/PK/AV)
1	4924	32.08	2.91	34.99	-39.01	74	150	400	Peak
2	7386	29.81	12.09	41.9	-32.1	74	150	400	Peak
3	* 9848	31.83	15.02	46.85	-27.15	74	150	400	Peak

Note :

- " * " means the worst value in this measurement data °
- Measure Level (dBμV/m) = Reading Level (dBμV) + Factor (dB) °
- Factor (dB) = Cable Loss (dB) + Antenna Factor (dB/m) °
- The emission levels of other frequencies are very lower than the limit and not show in test report °

EUT	WIFI CONTROL BOX	Test Date	2017/11/01
Factor	BBHA 9120D (1GHz~18GHz)	Temp. / Humidity	20°C / 58%
Polarity	Vertical	Site / Engineer	AC1 / Peter
Test Mode	MODE1-CH11	Test Voltage	AC 120V/60Hz

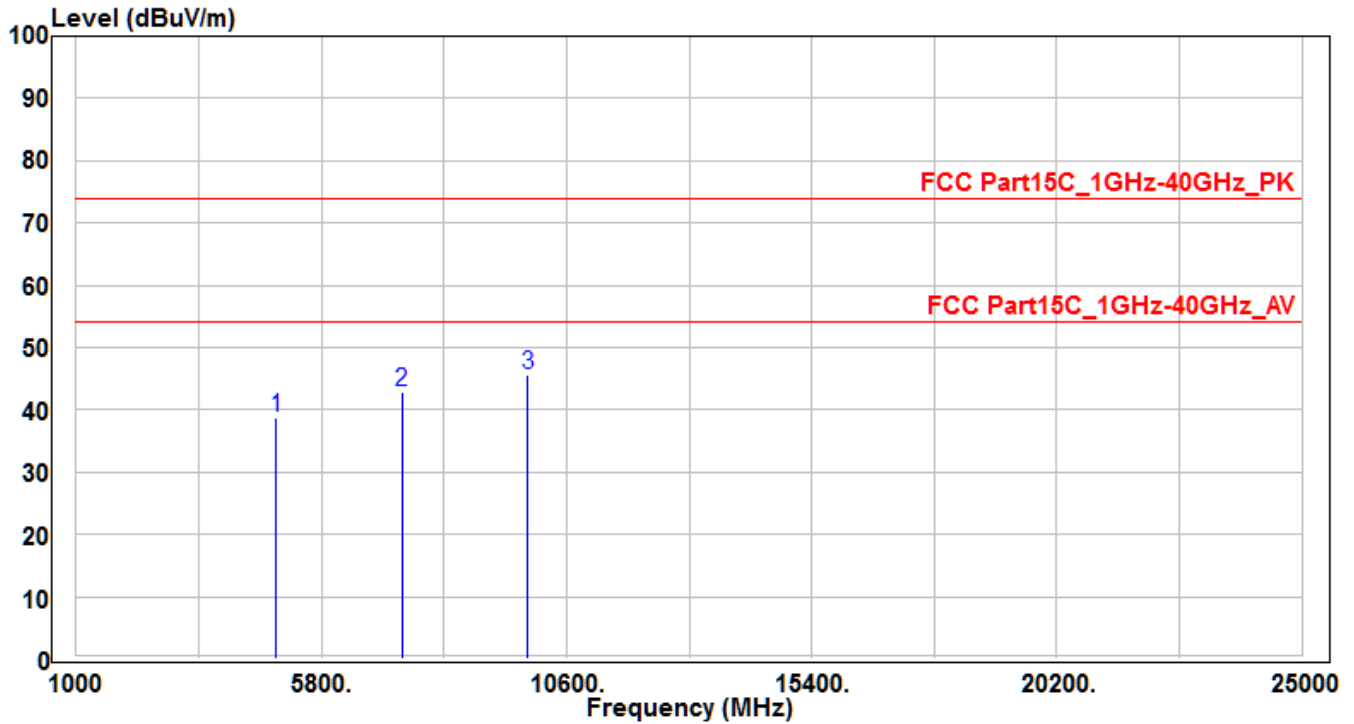

No	Frequency (MHz)	Reading (dBuV/m)	C.F (dB)	Measurement (dBuV/m)	Margin (dB)	Limit (dBuV/m)	Height (cm)	Angle (deg)	Remark (QP/PK/AV)
1	4924	35.87	2.91	38.78	-35.22	74	150	400	Peak
2	7386	30.82	12.09	42.91	-31.09	74	150	400	Peak
3	* 9848	30.69	15.02	45.71	-28.29	74	150	400	Peak

Note :

- "*" means the worst value in this measurement data ◦
- Measure Level (dBμV/m) = Reading Level (dBμV) + Factor (dB) ◦
- Factor (dB) = Cable Loss (dB) + Antenna Factor (dB/m) ◦
- The emission levels of other frequencies are very lower than the limit and not show in test report ◦

EUT	WIFI CONTROL BOX	Test Date	2017/11/01
Factor	BBHA 9120D (1GHz~18GHz)	Temp. / Humidity	20°C / 58%
Polarity	Horizontal	Site / Engineer	AC1 / Peter
Test Mode	MODE2-CH01	Test Voltage	AC 120V/60Hz

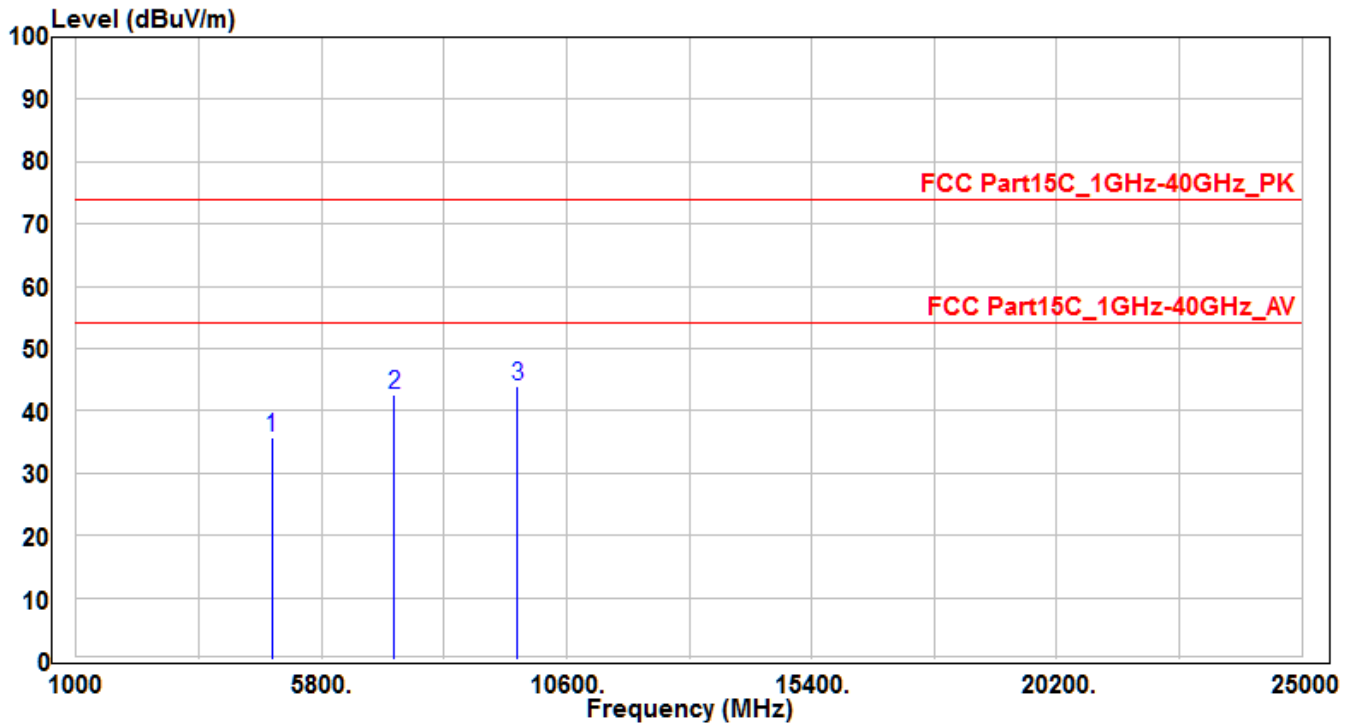

No	Frequency (MHz)	Reading (dBuV/m)	C.F (dB)	Measurement (dBuV/m)	Margin (dB)	Limit (dBuV/m)	Height (cm)	Angle (deg)	Remark (QP/PK/AV)
1	4824	33.11	2.73	35.84	-38.16	74	150	400	Peak
2	7236	31.17	11.4	42.57	-31.43	74	150	400	Peak
3	* 9648	29.47	14.56	44.03	-29.97	74	150	400	Peak

Note :

- " * " means the worst value in this measurement data ◦
- Measure Level (dBμV/m) = Reading Level (dBμV) + Factor (dB) ◦
- Factor (dB) = Cable Loss (dB) + Antenna Factor (dB/m) ◦
- The emission levels of other frequencies are very lower than the limit and not show in test report ◦

EUT	WIFI CONTROL BOX	Test Date	2017/11/01
Factor	BBHA 9120D (1GHz~18GHz)	Temp. / Humidity	20°C / 58%
Polarity	Vertical	Site / Engineer	AC1 / Peter
Test Mode	MODE2-CH01	Test Voltage	AC 120V/60Hz

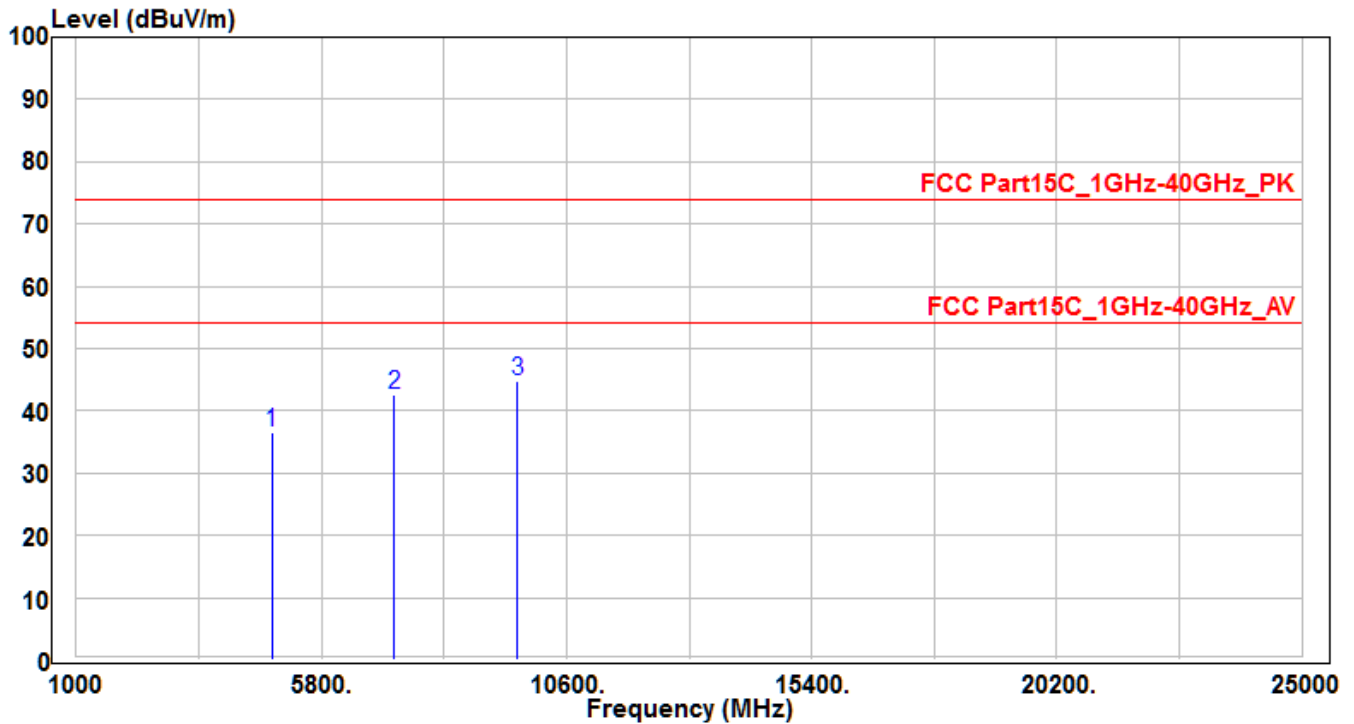

No	Frequency (MHz)	Reading (dBuV/m)	C.F (dB)	Measurement (dBuV/m)	Margin (dB)	Limit (dBuV/m)	Height (cm)	Angle (deg)	Remark (QP/PK/AV)
1	4824	33.79	2.73	36.52	-37.48	74	150	400	Peak
2	7236	31.12	11.4	42.52	-31.48	74	150	400	Peak
3	* 9648	30.23	14.56	44.79	-29.21	74	150	400	Peak

Note :

- " * " means the worst value in this measurement data ◦
- Measure Level (dBμV/m) = Reading Level (dBμV) + Factor (dB) ◦
- Factor (dB) = Cable Loss (dB) + Antenna Factor (dB/m) ◦
- The emission levels of other frequencies are very lower than the limit and not show in test report ◦

EUT	WIFI CONTROL BOX	Test Date	2017/11/01
Factor	BBHA 9120D (1GHz~18GHz)	Temp. / Humidity	20°C / 58%
Polarity	Horizontal	Site / Engineer	AC1 / Peter
Test Mode	MODE2-CH06	Test Voltage	AC 120V/60Hz

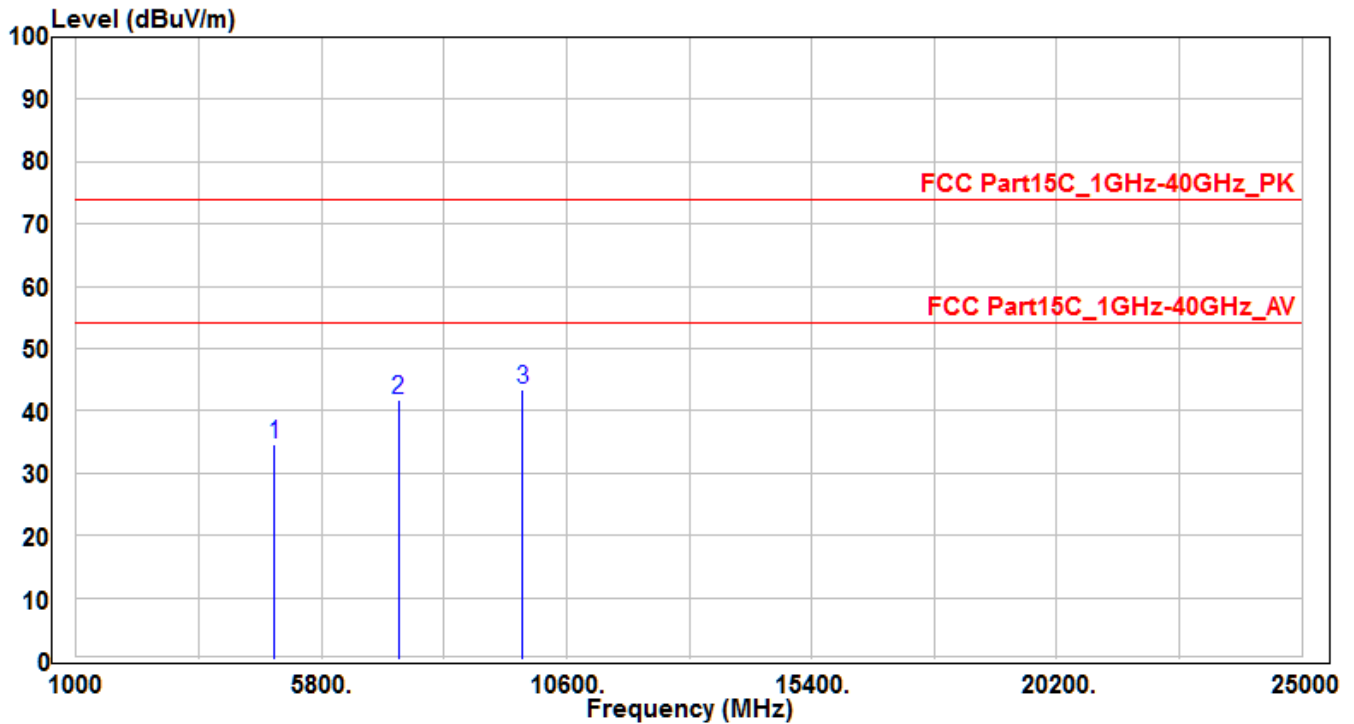

No	Frequency (MHz)	Reading (dBuV/m)	C.F (dB)	Measurement (dBuV/m)	Margin (dB)	Limit (dBuV/m)	Height (cm)	Angle (deg)	Remark (QP/PK/AV)
1	4874	31.75	2.82	34.57	-39.43	74	150	400	Peak
2	7311	29.92	11.74	41.66	-32.34	74	150	400	Peak
3	* 9748	28.71	14.79	43.5	-30.5	74	150	400	Peak

Note :

- " * " means the worst value in this measurement data °
- Measure Level (dBμV/m) = Reading Level (dBμV) + Factor (dB) °
- Factor (dB) = Cable Loss (dB) + Antenna Factor (dB/m) °
- The emission levels of other frequencies are very lower than the limit and not show in test report °

EUT	WIFI CONTROL BOX	Test Date	2017/11/01
Factor	BBHA 9120D (1GHz~18GHz)	Temp. / Humidity	20°C / 58%
Polarity	Vertical	Site / Engineer	AC1 / Peter
Test Mode	MODE2-CH06	Test Voltage	AC 120V/60Hz

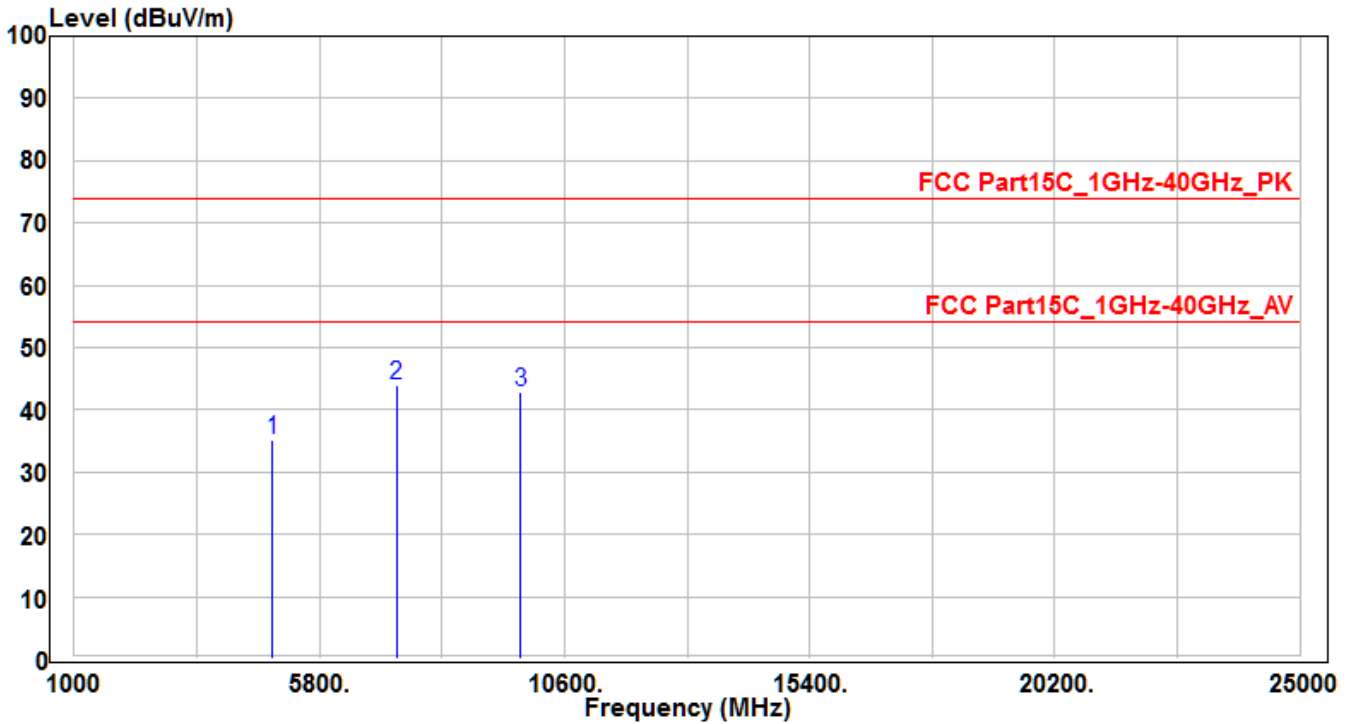

No	Frequency (MHz)	Reading (dBUV/m)	C.F (dB)	Measurement (dBUV/m)	Margin (dB)	Limit (dBUV/m)	Height (cm)	Angle (deg)	Remark (QP/PK/AV)
1	4874	32.37	2.82	35.19	-38.81	74	150	400	Peak
2	* 7311	32.35	11.74	44.09	-29.91	74	150	400	Peak
3	9748	28.13	14.79	42.92	-31.08	74	150	400	Peak

Note :

- " * " means the worst value in this measurement data °
- Measure Level (dBUV/m) = Reading Level (dBUV) + Factor (dB) °
- Factor (dB) = Cable Loss (dB) + Antenna Factor (dB/m) °
- The emission levels of other frequencies are very lower than the limit and not show in test report °

EUT	WIFI CONTROL BOX	Test Date	2017/11/01
Factor	BBHA 9120D (1GHz~18GHz)	Temp. / Humidity	20°C / 58%
Polarity	Horizontal	Site / Engineer	AC1 / Peter
Test Mode	MODE2-CH11	Test Voltage	AC 120V/60Hz

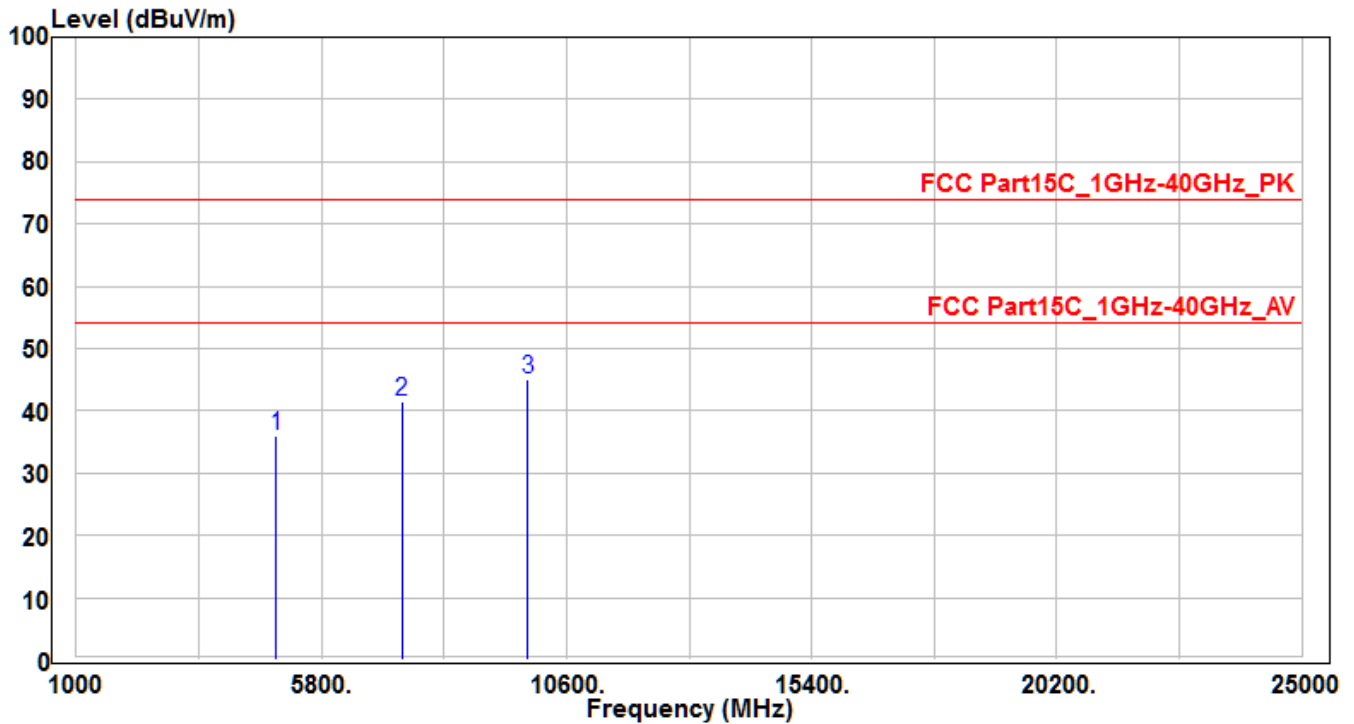

No	Frequency (MHz)	Reading (dBuV/m)	C.F (dB)	Measurement (dBuV/m)	Margin (dB)	Limit (dBuV/m)	Height (cm)	Angle (deg)	Remark (QP/PK/AV)
1	4924	33.16	2.91	36.07	-37.93	74	150	400	Peak
2	7386	29.48	12.09	41.57	-32.43	74	150	400	Peak
3	* 9848	30.1	15.02	45.12	-28.88	74	150	400	Peak

Note :

1. " * " means the worst value in this measurement data ◦
2. Measure Level (dBμV/m) = Reading Level (dBμV) + Factor (dB) ◦
3. Factor (dB) = Cable Loss (dB) + Antenna Factor (dB/m) ◦
4. The emission levels of other frequencies are very lower than the limit and not show in test report ◦

EUT	WIFI CONTROL BOX	Test Date	2017/11/01
Factor	BBHA 9120D (1GHz~18GHz)	Temp. / Humidity	20°C / 58%
Polarity	Vertical	Site / Engineer	AC1 / Peter
Test Mode	MODE2-CH11	Test Voltage	AC 120V/60Hz

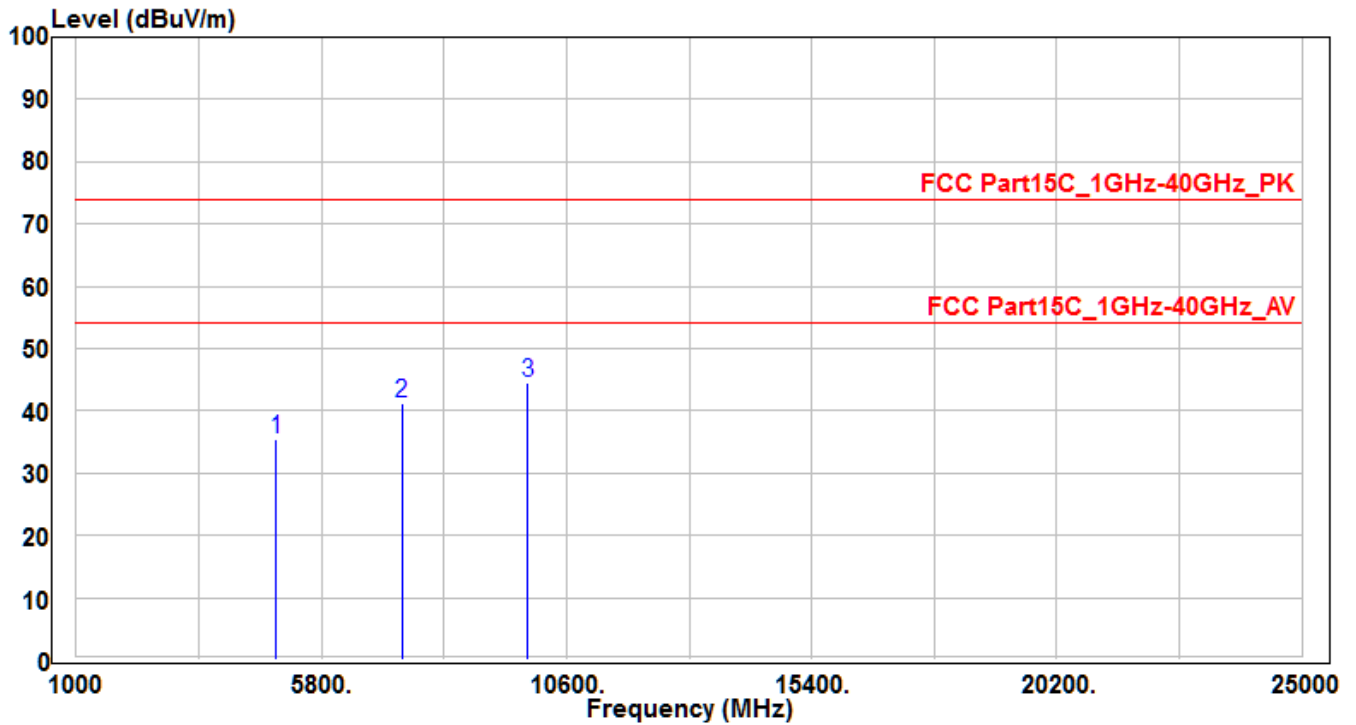

No	Frequency (MHz)	Reading (dBuV/m)	C.F (dB)	Measurement (dBuV/m)	Margin (dB)	Limit (dBuV/m)	Height (cm)	Angle (deg)	Remark (QP/PK/AV)
1	4924	32.46	2.91	35.37	-38.63	74	150	400	Peak
2	7386	29.15	12.09	41.24	-32.76	74	150	400	Peak
3	* 9848	29.55	15.02	44.57	-29.43	74	150	400	Peak

Note :

- "*" means the worst value in this measurement data °
- Measure Level (dBuV/m) = Reading Level (dBuV) + Factor (dB) °
- Factor (dB) = Cable Loss (dB) + Antenna Factor (dB/m) °
- The emission levels of other frequencies are very lower than the limit and not show in test report °

EUT	WIFI CONTROL BOX	Test Date	2017/11/01
Factor	BBHA 9120D (1GHz~18GHz)	Temp. / Humidity	20°C / 58%
Polarity	Horizontal	Site / Engineer	AC1 / Peter
Test Mode	MODE3-CH01	Test Voltage	AC 120V/60Hz

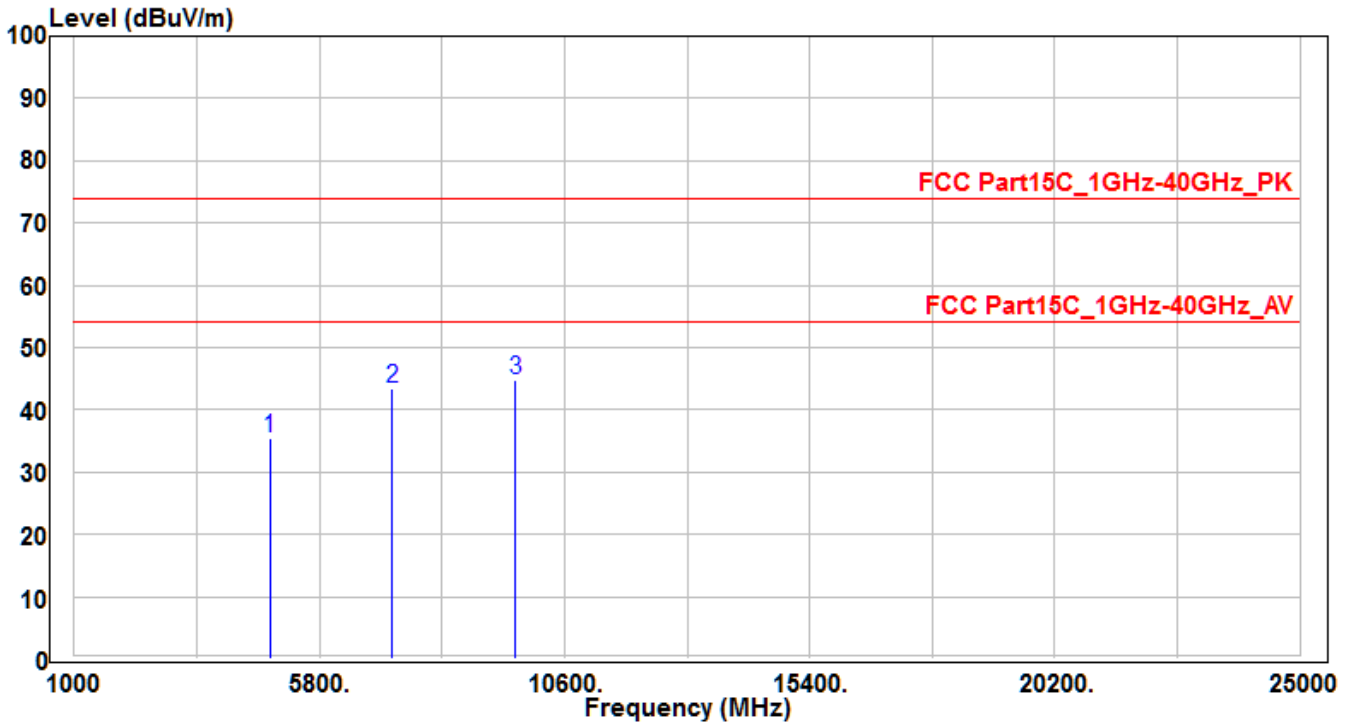

No	Frequency (MHz)	Reading (dBuV/m)	C.F (dB)	Measurement (dBuV/m)	Margin (dB)	Limit (dBuV/m)	Height (cm)	Angle (deg)	Remark (QP/PK/AV)
1	4824	32.83	2.73	35.56	-38.44	74	150	400	Peak
2	7236	32.02	11.4	43.42	-30.58	74	150	400	Peak
3	* 9648	30.28	14.56	44.84	-29.16	74	150	400	Peak

Note :

1. " * " means the worst value in this measurement data °
2. Measure Level (dBuV/m) = Reading Level (dBuV) + Factor (dB) °
3. Factor (dB) = Cable Loss (dB) + Antenna Factor (dB/m) °
4. The emission levels of other frequencies are very lower than the limit and not show in test report °

EUT	WIFI CONTROL BOX	Test Date	2017/11/01
Factor	BBHA 9120D (1GHz~18GHz)	Temp. / Humidity	20°C / 58%
Polarity	Vertical	Site / Engineer	AC1 / Peter
Test Mode	MODE3-CH01	Test Voltage	AC 120V/60Hz

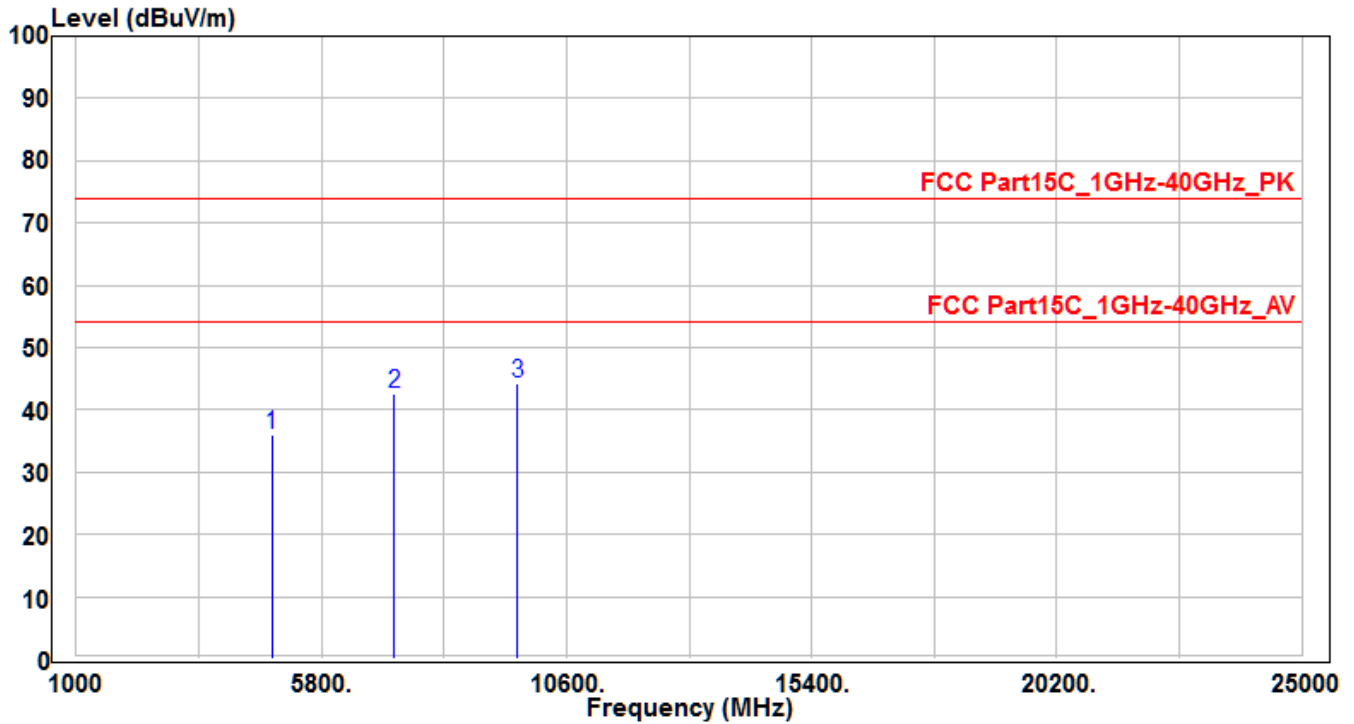

No	Frequency (MHz)	Reading (dBuV/m)	C.F (dB)	Measurement (dBuV/m)	Margin (dB)	Limit (dBuV/m)	Height (cm)	Angle (deg)	Remark (QP/PK/AV)
1	4824	33.27	2.73	36	-38	74	150	400	Peak
2	7236	31.31	11.4	42.71	-31.29	74	150	400	Peak
3	* 9648	29.63	14.56	44.19	-29.81	74	150	400	Peak

Note :

- " * " means the worst value in this measurement data °
- Measure Level (dB μ V/m) = Reading Level (dB μ V) + Factor (dB) °
- Factor (dB) = Cable Loss (dB) + Antenna Factor (dB/m) °
- The emission levels of other frequencies are very lower than the limit and not show in test report °

EUT	WIFI CONTROL BOX	Test Date	2017/11/01
Factor	BBHA 9120D (1GHz~18GHz)	Temp. / Humidity	20°C / 58%
Polarity	Horizontal	Site / Engineer	AC1 / Peter
Test Mode	MODE3-CH06	Test Voltage	AC 120V/60Hz

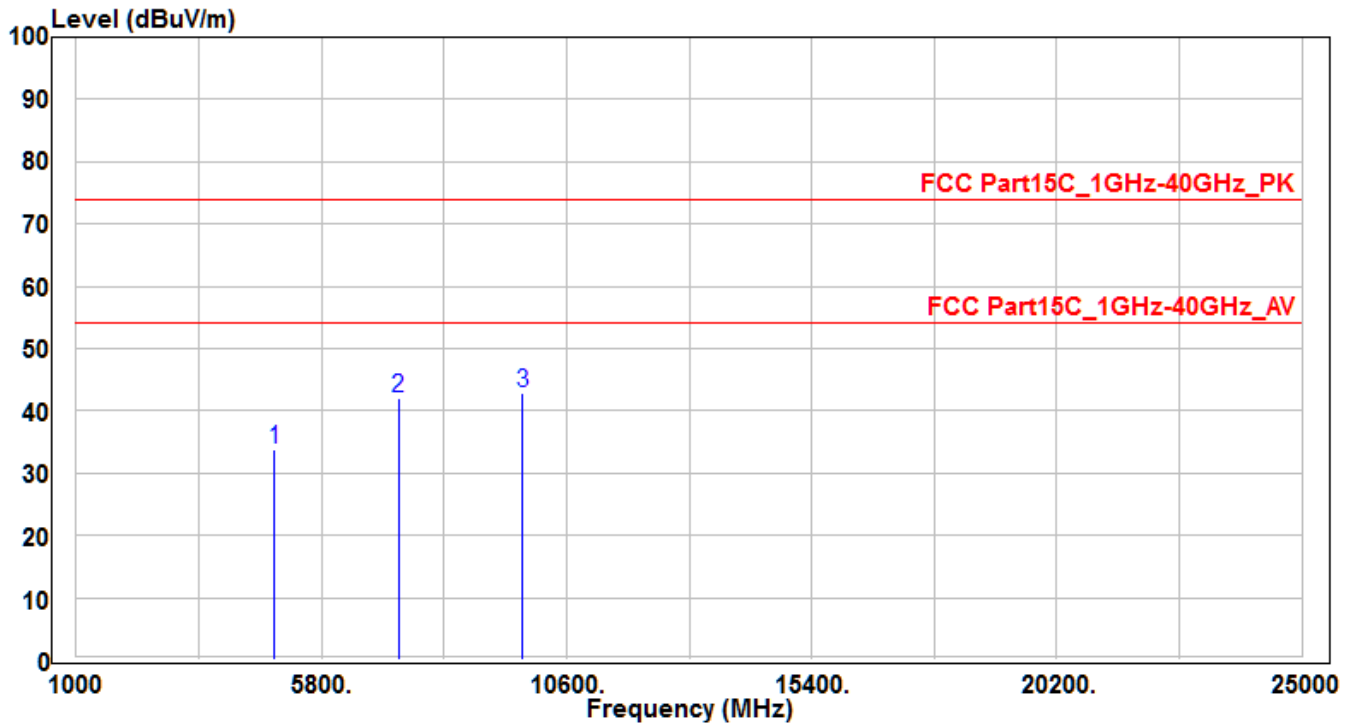

No	Frequency (MHz)	Reading (dBuV/m)	C.F (dB)	Measurement (dBuV/m)	Margin (dB)	Limit (dBuV/m)	Height (cm)	Angle (deg)	Remark (QP/PK/AV)
1	4874	31.1	2.82	33.92	-40.08	74	150	400	Peak
2	7311	30.3	11.74	42.04	-31.96	74	150	400	Peak
3	* 9748	28.14	14.79	42.93	-31.07	74	150	400	Peak

Note :

- " * " means the worst value in this measurement data ◦
- Measure Level (dBuV/m) = Reading Level (dBuV) + Factor (dB) ◦
- Factor (dB) = Cable Loss (dB) + Antenna Factor (dB/m) ◦
- The emission levels of other frequencies are very lower than the limit and not show in test report ◦

EUT	WIFI CONTROL BOX	Test Date	2017/11/01
Factor	BBHA 9120D (1GHz~18GHz)	Temp. / Humidity	20°C / 58%
Polarity	Vertical	Site / Engineer	AC1 / Peter
Test Mode	MODE3-CH06	Test Voltage	AC 120V/60Hz

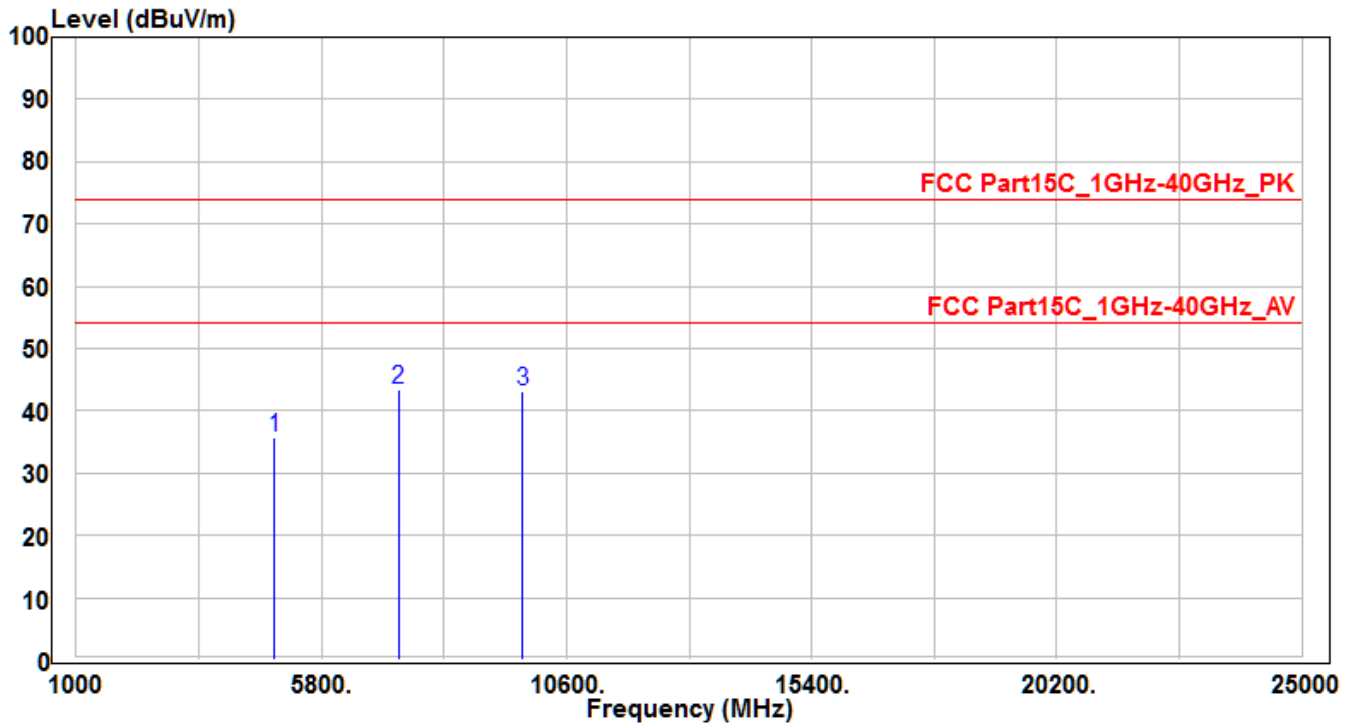

No	Frequency (MHz)	Reading (dBuV/m)	C.F (dB)	Measurement (dBuV/m)	Margin (dB)	Limit (dBuV/m)	Height (cm)	Angle (deg)	Remark (QP/PK/AV)
1	4874	32.88	2.82	35.7	-38.3	74	150	400	Peak
2	* 7311	31.81	11.74	43.55	-30.45	74	150	400	Peak
3	9748	28.33	14.79	43.12	-30.88	74	150	400	Peak

Note :

- " * " means the worst value in this measurement data ◦
- Measure Level (dBμV/m) = Reading Level (dBμV) + Factor (dB) ◦
- Factor (dB) = Cable Loss (dB) + Antenna Factor (dB/m) ◦
- The emission levels of other frequencies are very lower than the limit and not show in test report ◦

EUT	WIFI CONTROL BOX	Test Date	2017/11/01
Factor	BBHA 9120D (1GHz~18GHz)	Temp. / Humidity	20°C / 58%
Polarity	Horizontal	Site / Engineer	AC1 / Peter
Test Mode	MODE3-CH11	Test Voltage	AC 120V/60Hz

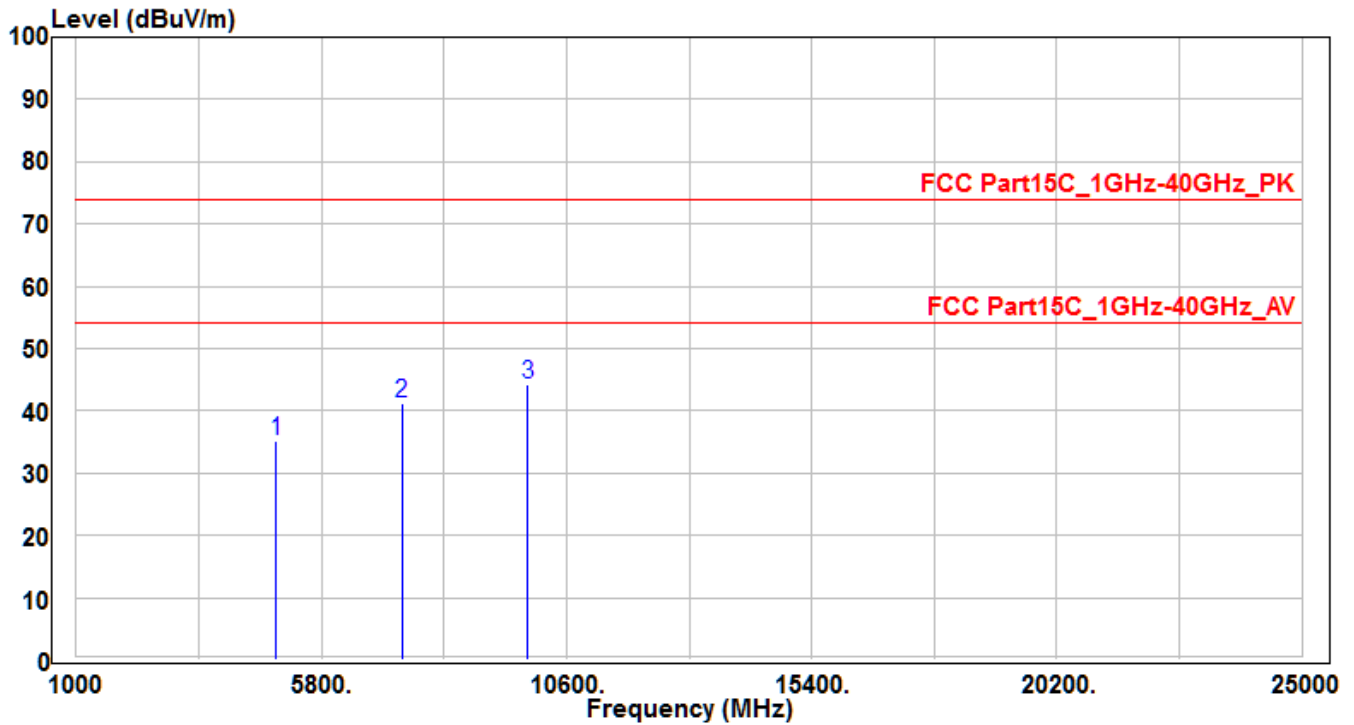

No	Frequency (MHz)	Reading (dBuV/m)	C.F (dB)	Measurement (dBuV/m)	Margin (dB)	Limit (dBuV/m)	Height (cm)	Angle (deg)	Remark (QP/PK/AV)
1	4924	32.28	2.91	35.19	-38.81	74	150	400	Peak
2	7386	29.04	12.09	41.13	-32.87	74	150	400	Peak
3	* 9848	29.23	15.02	44.25	-29.75	74	150	400	Peak

Note :

- "*" means the worst value in this measurement data °
- Measure Level (dBμV/m) = Reading Level (dBμV) + Factor (dB) °
- Factor (dB) = Cable Loss (dB) + Antenna Factor (dB/m) °
- The emission levels of other frequencies are very lower than the limit and not show in test report °

EUT	WIFI CONTROL BOX	Test Date	2017/11/01
Factor	BBHA 9120D (1GHz~18GHz)	Temp. / Humidity	20°C / 58%
Polarity	Vertical	Site / Engineer	AC1 / Peter
Test Mode	MODE3-CH11	Test Voltage	AC 120V/60Hz

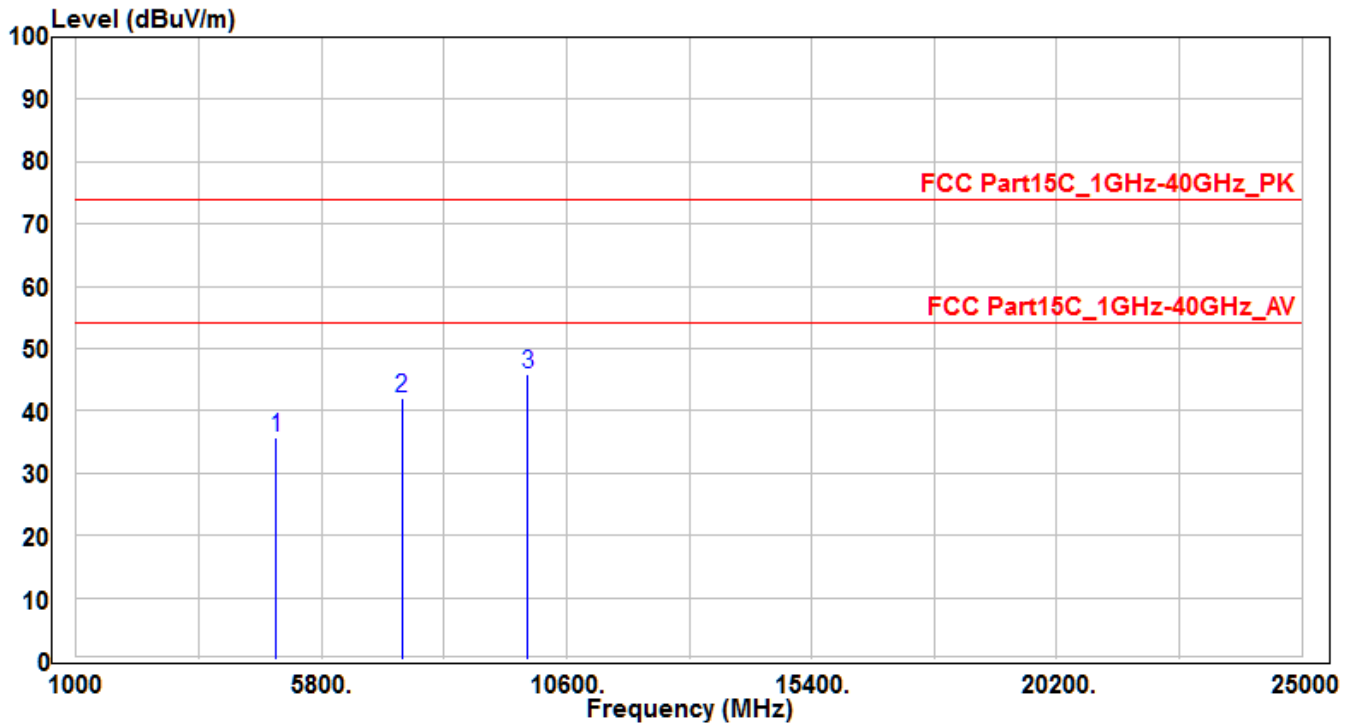

No	Frequency (MHz)	Reading (dBuV/m)	C.F (dB)	Measurement (dBuV/m)	Margin (dB)	Limit (dBuV/m)	Height (cm)	Angle (deg)	Remark (QP/PK/AV)
1	4924	32.94	2.91	35.85	-38.15	74	150	400	Peak
2	7386	29.87	12.09	41.96	-32.04	74	150	400	Peak
3	* 9848	30.77	15.02	45.79	-28.21	74	150	400	Peak

Note :

- " * " means the worst value in this measurement data ◦
- Measure Level (dBμV/m) = Reading Level (dBμV) + Factor (dB) ◦
- Factor (dB) = Cable Loss (dB) + Antenna Factor (dB/m) ◦
- The emission levels of other frequencies are very lower than the limit and not show in test report ◦

EUT	WIFI CONTROL BOX	Test Date	2017/11/01
Factor	BBHA 9120D (1GHz~18GHz)	Temp. / Humidity	20°C / 58%
Polarity	Horizontal	Site / Engineer	AC1 / Peter
Test Mode	MODE4-CH03	Test Voltage	AC 120V/60Hz

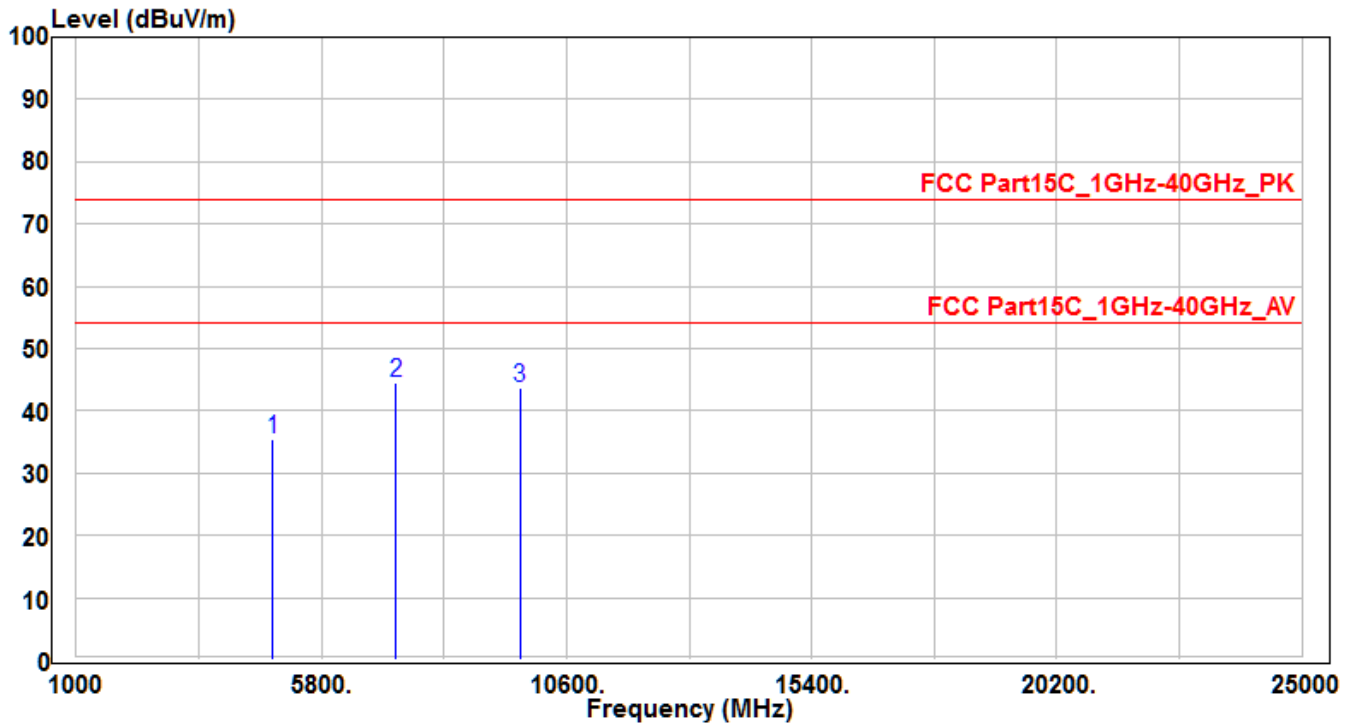

No	Frequency (MHz)	Reading (dBuV/m)	C.F (dB)	Measurement (dBuV/m)	Margin (dB)	Limit (dBuV/m)	Height (cm)	Angle (deg)	Remark (QP/PK/AV)
1	4844	32.57	2.77	35.34	-38.66	74	150	400	Peak
2	* 7266	33.06	11.53	44.59	-29.41	74	150	400	Peak
3	9688	29.06	14.65	43.71	-30.29	74	150	400	Peak

Note :

- " * " means the worst value in this measurement data ◦
- Measure Level (dBμV/m) = Reading Level (dBμV) + Factor (dB) ◦
- Factor (dB) = Cable Loss (dB) + Antenna Factor (dB/m) ◦
- The emission levels of other frequencies are very lower than the limit and not show in test report ◦

EUT	WIFI CONTROL BOX	Test Date	2017/11/01
Factor	BBHA 9120D (1GHz~18GHz)	Temp. / Humidity	20°C / 58%
Polarity	Vertical	Site / Engineer	AC1 / Peter
Test Mode	MODE4-CH03	Test Voltage	AC 120V/60Hz

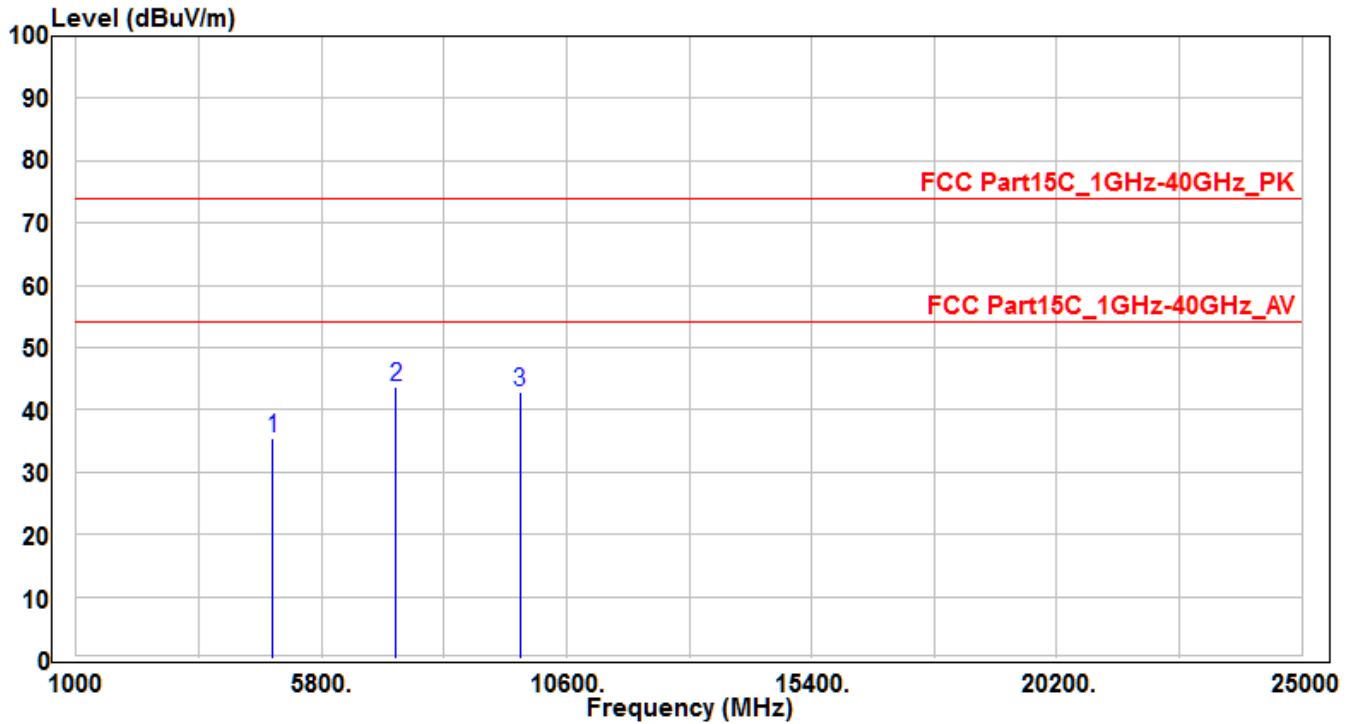

No	Frequency (MHz)	Reading (dBuV/m)	C.F (dB)	Measurement (dBuV/m)	Margin (dB)	Limit (dBuV/m)	Height (cm)	Angle (deg)	Remark (QP/PK/AV)
1	4844	32.81	2.77	35.58	-38.42	74	150	400	Peak
2	* 7266	32.1	11.53	43.63	-30.37	74	150	400	Peak
3	9688	28.26	14.65	42.91	-31.09	74	150	400	Peak

Note :

- "*" means the worst value in this measurement data °
- Measure Level (dBuV/m) = Reading Level (dBuV) + Factor (dB) °
- Factor (dB) = Cable Loss (dB) + Antenna Factor (dB/m) °
- The emission levels of other frequencies are very lower than the limit and not show in test report °

EUT	WIFI CONTROL BOX	Test Date	2017/11/01
Factor	BBHA 9120D (1GHz~18GHz)	Temp. / Humidity	20°C / 58%
Polarity	Horizontal	Site / Engineer	AC1 / Peter
Test Mode	MODE2-CH06	Test Voltage	AC 120V/60Hz

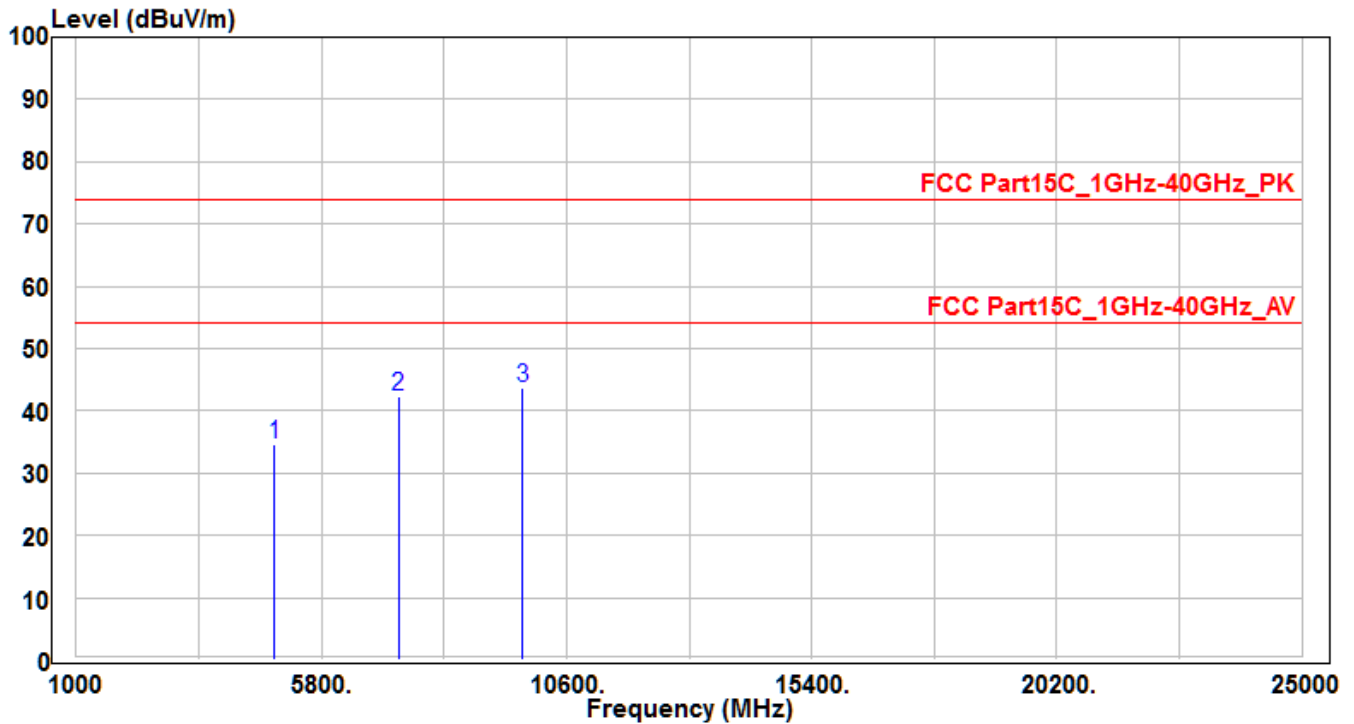

No	Frequency (MHz)	Reading (dBuV/m)	C.F (dB)	Measurement (dBuV/m)	Margin (dB)	Limit (dBuV/m)	Height (cm)	Angle (deg)	Remark (QP/PK/AV)
1	4874	31.68	2.82	34.5	-39.5	74	150	400	Peak
2	7311	30.5	11.74	42.24	-31.76	74	150	400	Peak
3	* 9748	28.9	14.79	43.69	-30.31	74	150	400	Peak

Note :

- " * " means the worst value in this measurement data ◦
- Measure Level (dBμV/m) = Reading Level (dBμV) + Factor (dB) ◦
- Factor (dB) = Cable Loss (dB) + Antenna Factor (dB/m) ◦
- The emission levels of other frequencies are very lower than the limit and not show in test report ◦

EUT	WIFI CONTROL BOX	Test Date	2017/11/01
Factor	BBHA 9120D (1GHz~18GHz)	Temp. / Humidity	20°C / 58%
Polarity	Vertical	Site / Engineer	AC1 / Peter
Test Mode	MODE2-CH06	Test Voltage	AC 120V/60Hz

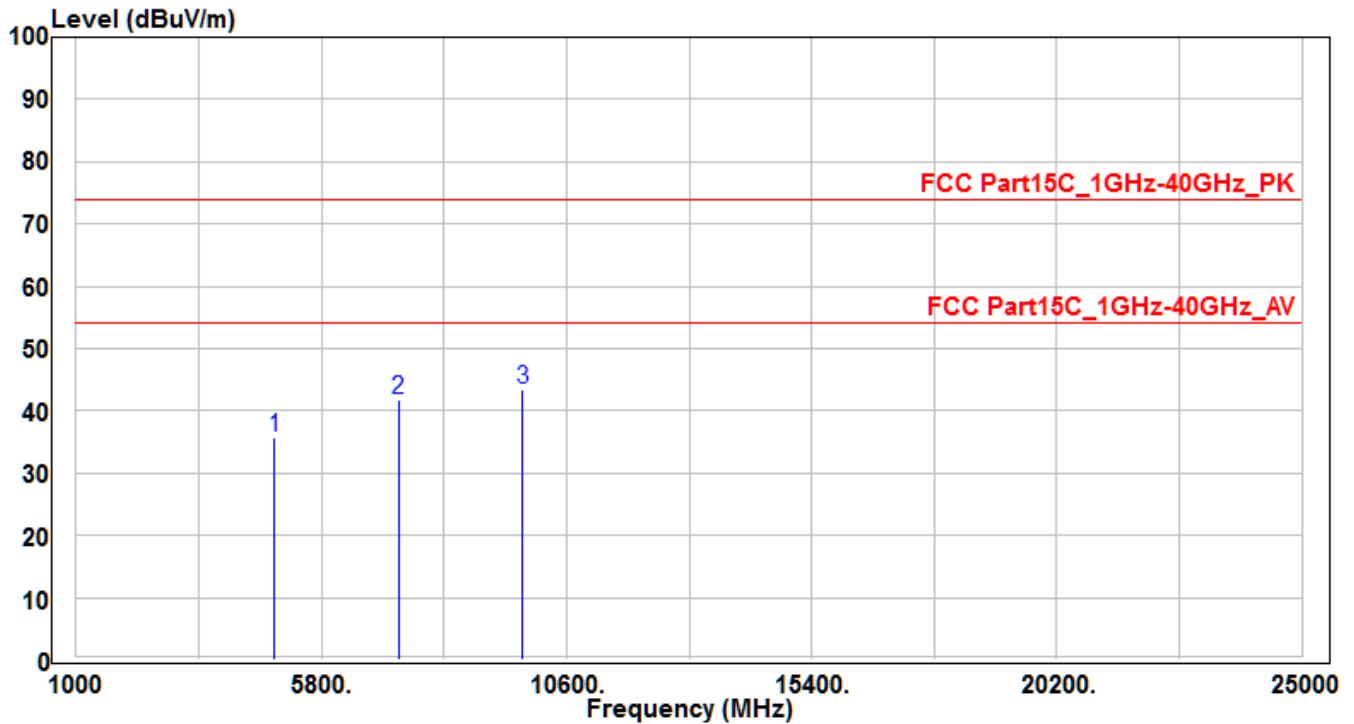

No	Frequency (MHz)	Reading (dBuV/m)	C.F (dB)	Measurement (dBuV/m)	Margin (dB)	Limit (dBuV/m)	Height (cm)	Angle (deg)	Remark (QP/PK/AV)
1	4874	32.92	2.82	35.74	-38.26	74	150	400	Peak
2	7311	29.95	11.74	41.69	-32.31	74	150	400	Peak
3	* 9748	28.59	14.79	43.38	-30.62	74	150	400	Peak

Note :

- " * " means the worst value in this measurement data ◦
- Measure Level (dBμV/m) = Reading Level (dBμV) + Factor (dB) ◦
- Factor (dB) = Cable Loss (dB) + Antenna Factor (dB/m) ◦
- The emission levels of other frequencies are very lower than the limit and not show in test report ◦

EUT	WIFI CONTROL BOX	Test Date	2017/11/01
Factor	BBHA 9120D (1GHz~18GHz)	Temp. / Humidity	20°C / 58%
Polarity	Horizontal	Site / Engineer	AC1 / Peter
Test Mode	MODE2-CH09	Test Voltage	AC 120V/60Hz

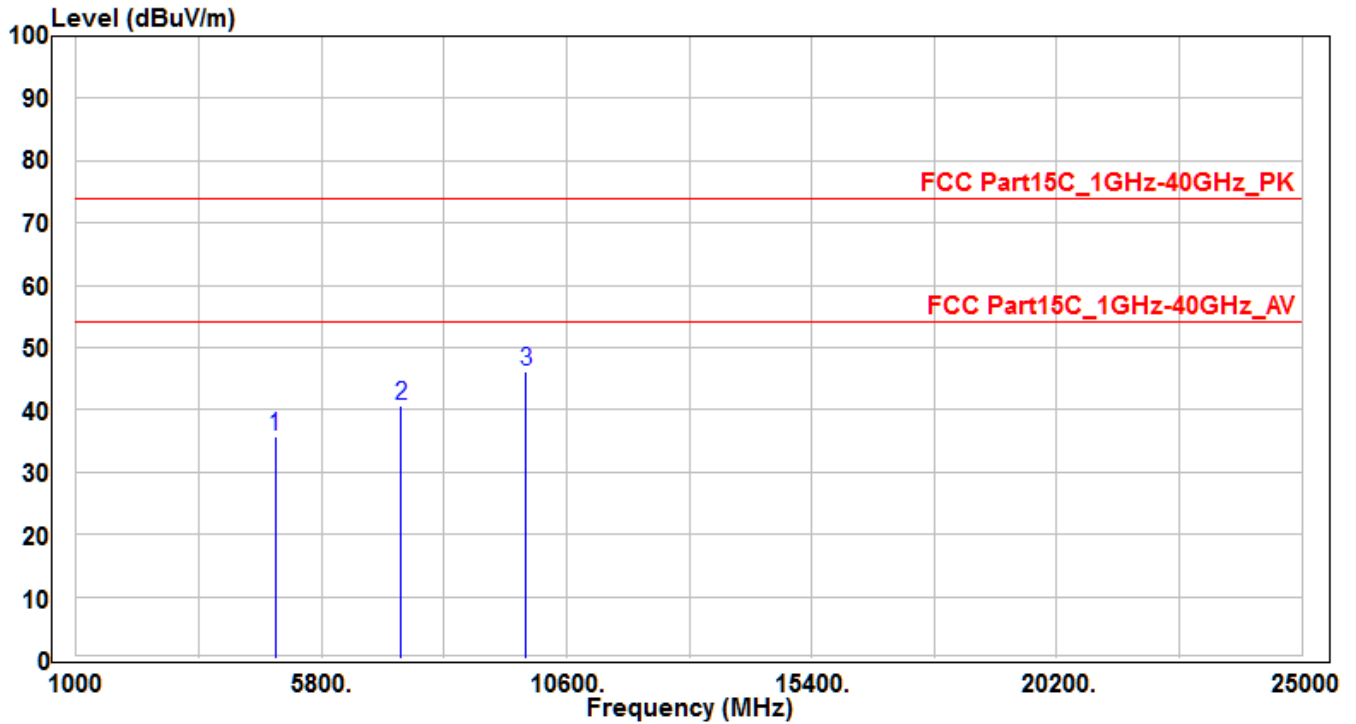

No	Frequency (MHz)	Reading (dBuV/m)	C.F (dB)	Measurement (dBuV/m)	Margin (dB)	Limit (dBuV/m)	Height (cm)	Angle (deg)	Remark (QP/PK/AV)
1	4904	32.73	2.88	35.61	-38.39	74	150	400	Peak
2	7356	28.59	11.96	40.55	-33.45	74	150	400	Peak
3	* 9808	31.2	14.93	46.13	-27.87	74	150	400	Peak

Note :

1. " * " means the worst value in this measurement data ◦
2. Measure Level (dBμV/m) = Reading Level (dBμV) + Factor (dB) ◦
3. Factor (dB) = Cable Loss (dB) + Antenna Factor (dB/m) ◦
4. The emission levels of other frequencies are very lower than the limit and not show in test report ◦

EUT	WIFI CONTROL BOX	Test Date	2017/11/01
Factor	BBHA 9120D (1GHz~18GHz)	Temp. / Humidity	20°C / 58%
Polarity	Vertical	Site / Engineer	AC1 / Peter
Test Mode	MODE4-CH09	Test Voltage	AC 120V/60Hz

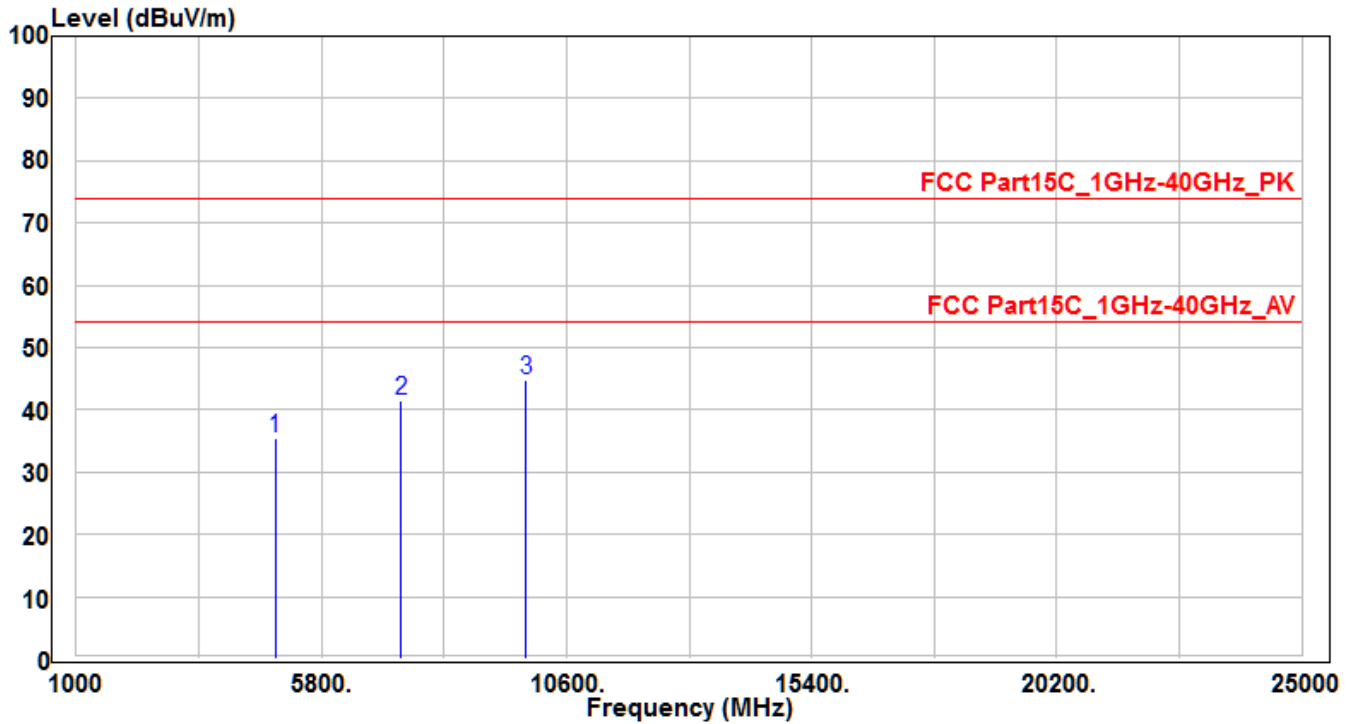

No	Frequency (MHz)	Reading (dBuV/m)	C.F (dB)	Measurement (dBuV/m)	Margin (dB)	Limit (dBuV/m)	Height (cm)	Angle (deg)	Remark (QP/PK/AV)
1	4904	32.55	2.88	35.43	-38.57	74	150	400	Peak
2	7356	29.57	11.96	41.53	-32.47	74	150	400	Peak
3	* 9808	29.88	14.93	44.81	-29.19	74	150	400	Peak

Note :

- "*" means the worst value in this measurement data °
- Measure Level (dBuV/m) = Reading Level (dBuV) + Factor (dB) °
- Factor (dB) = Cable Loss (dB) + Antenna Factor (dB/m) °
- The emission levels of other frequencies are very lower than the limit and not show in test report °

7.7. Radiated Restricted Band Edge Measurement

7.7.1. Test Limit

All out of band emissions appearing in a restricted band as specified in Section 15.205 of the Title 47 CFR must not exceed the limits shown in Table per Section 15.209.

FCC Part 15 Subpart C Paragraph 15.209		
Frequency [MHz]	Field Strength [V/m]	Measured Distance [Meters]
0.009 - 0.490	2400/F (kHz)	300
0.490 - 1.705	24000/F (kHz)	30
1.705 – 30	30	30
30 – 88	100	3
88 – 216	150	3
216 – 960	200	3
Above 960	500	3

7.7.2. Test Procedure Used

ANSI C63.10-2013 - Section 11.12.1

7.7.3. Test Setting

Peak Field Strength Measurements

8. Analyzer center frequency was set to the frequency of the radiated spurious emission of interest
9. RBW = as specified in Table 1
10. VBW = 3 * RBW
11. Detector = peak
12. Sweep time = auto couple
13. Trace mode = max hold
14. Trace was allowed to stabilize

Table 1 - RBW as a function of frequency

Frequency	RBW
9 ~ 150 kHz	200 ~ 300 Hz
0.15 ~ 30 MHz	9 ~ 10 kHz
30 ~ 1000 MHz	100 ~ 120 kHz
> 1000 MHz	1 MHz

Average Field Strength Measurements

9. Analyzer center frequency was set to the frequency of the radiated spurious emission of interest
10. RBW = 1MHz
11. VBW $\geq 1/T$
12. De As an alternative, the instrument may be set to linear detector mode. Ensure that video filtering is applied in linear voltage domain (rather than in a log or dB domain). Some instruments require linear display mode in order to accomplish this. Others have a setting for Average-VBW Type, which can be set to "Voltage" regardless of the display mode
13. Detector = Peak
14. Sweep time = auto
15. Trace mode = max hold
16. Allow max hold to run for at least 50 times (1/duty cycle) traces

7.7.4. Test Setup

1GHz ~ 18GHz Test Setup:

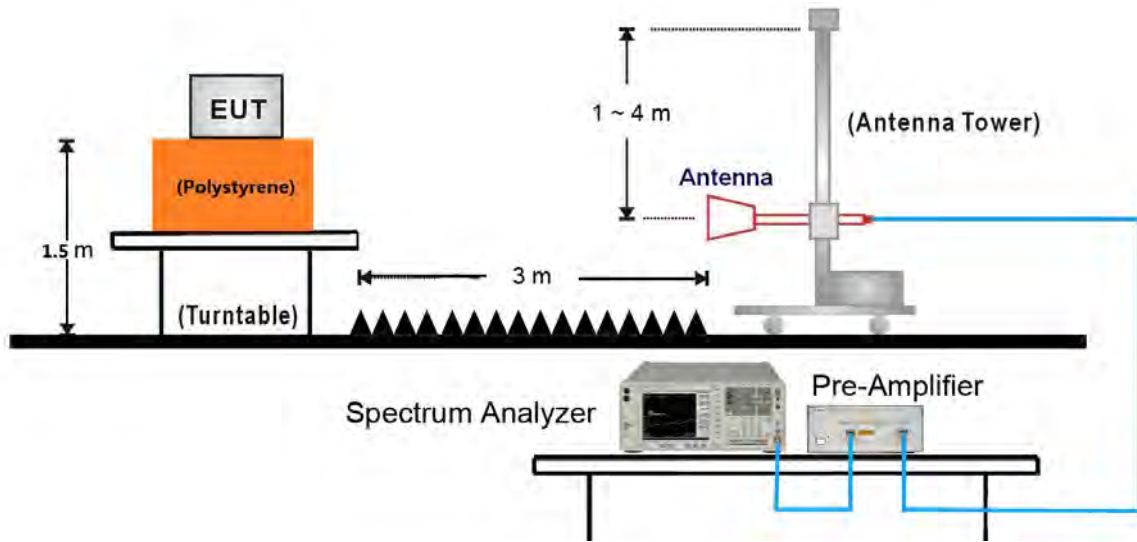

18GHz ~40GHz Test Setup:

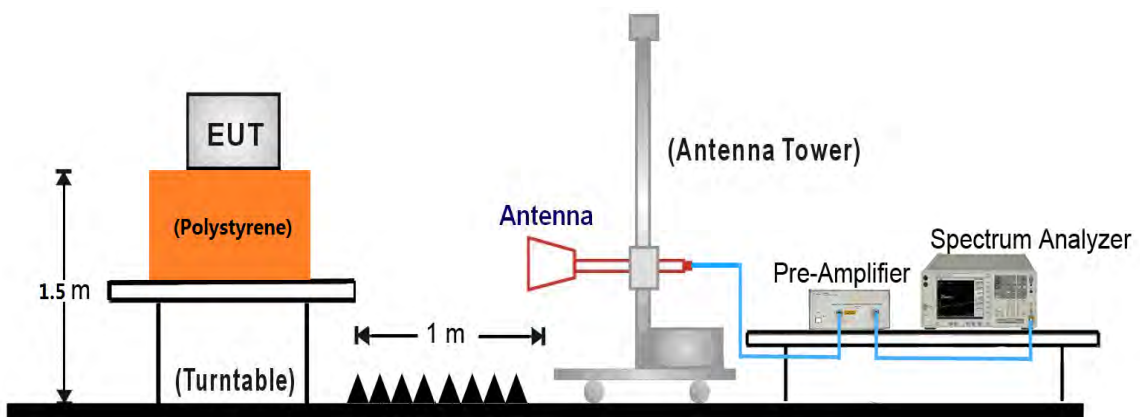

7.7.5. Test Result

EUT	WIFI CONTROL BOX	Test Date	2017/11/01
Factor	BBHA 9120D (1GHz~18GHz)	Temp. / Humidity	21°C / 57%
Polarity	Horizontal	Site / Engineer	AC1 / Peter
Test Mode	MODE1-CH01	Test Voltage	AC 120V/60Hz

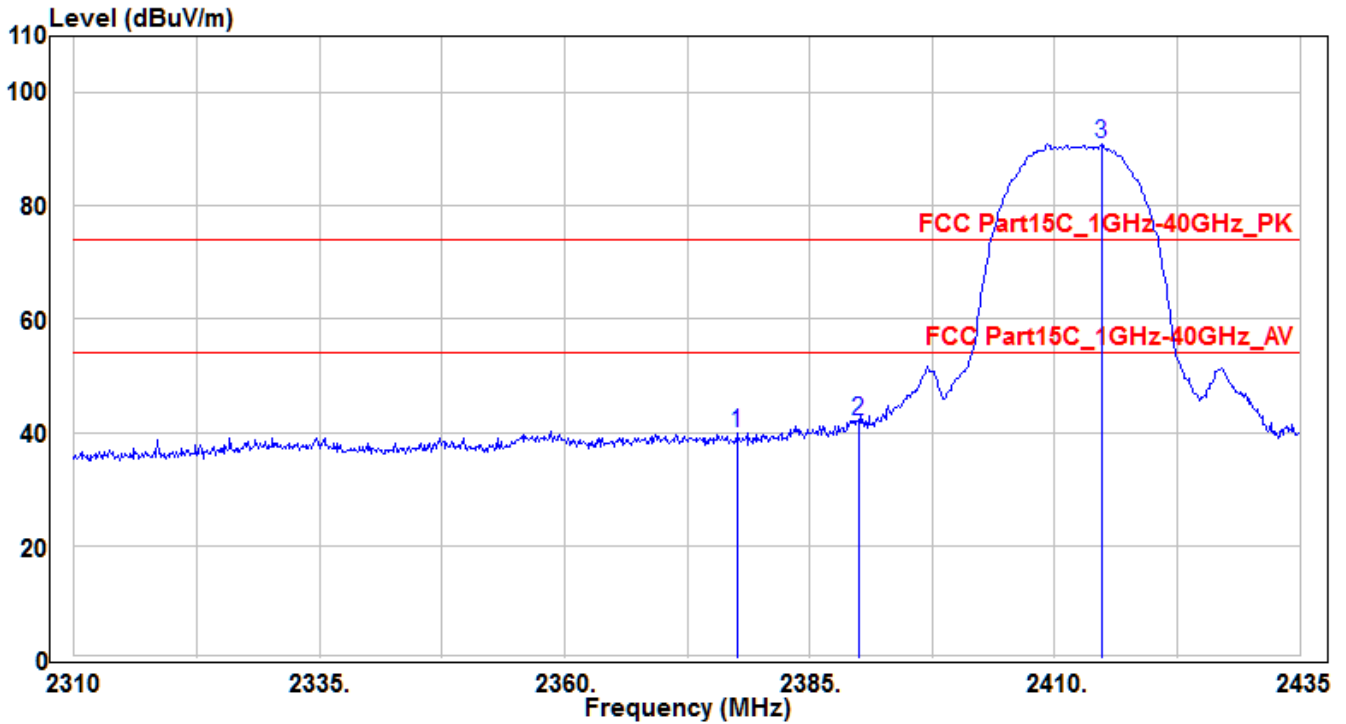

No	Frequency (MHz)	Reading (dBuV/m)	C.F (dB)	Measurement (dBuV/m)	Margin (dB)	Limit (dBuV/m)	Height (cm)	Angle (deg)	Remark (QP/PK/AV)
1	2377.625	42.49	-2.66	39.83	-34.17	74	150	45	Peak
2	* 2390	44.61	-2.59	42.02	-31.98	74	150	45	Peak
3	2414.75	93.3	-2.46	90.84	16.84	74	150	45	Peak

Note :

- "*" means the worst value in this measurement data °
- C.F (Correction Factor) = Antenna Factor (dB)+ Cable Loss (dB) – Preamplifier(dB) °
- Measurement (dBuV/m) = Reading(dBuV/m) + C.F (Correction Factor) °

EUT	WIFI CONTROL BOX	Test Date	2017/11/01
Factor	BBHA 9120D (1GHz~18GHz)	Temp. / Humidity	21°C / 57%
Polarity	Vertical	Site / Engineer	AC1 / Peter
Test Mode	MODE1-CH01	Test Voltage	AC 120V/60Hz

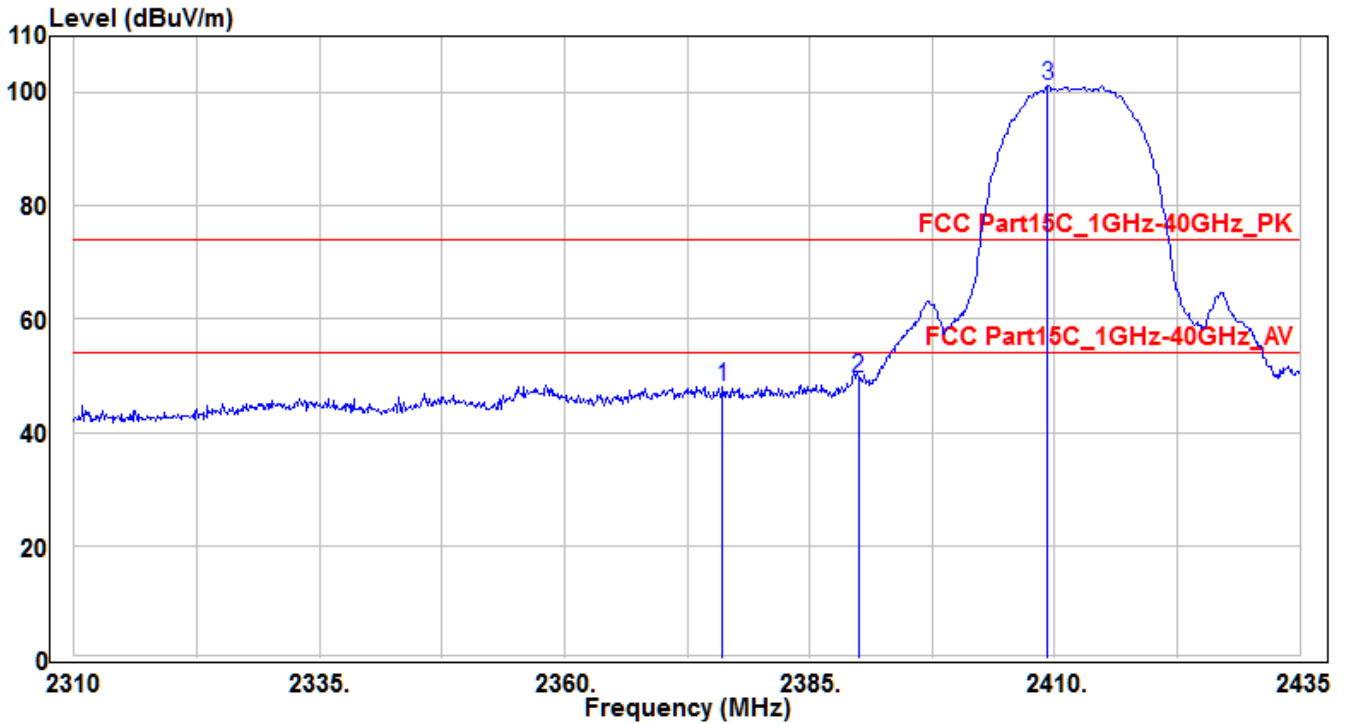

No	Frequency (MHz)	Reading (dBuV/m)	C.F (dB)	Measurement (dBuV/m)	Margin (dB)	Limit (dBuV/m)	Height (cm)	Angle (deg)	Remark (QP/PK/AV)
1	2376.125	50.74	-2.67	48.07	-25.93	74	245	305	Peak
2	* 2390	52.26	-2.59	49.67	-24.33	74	245	305	Peak
3	2409.25	103.68	-2.49	101.19	27.19	74	245	305	Peak

Note :

- "*" means the worst value in this measurement data °
- C.F (Correction Factor) = Antenna Factor (dB)+ Cable Loss (dB) – Preamplifier(dB) °
- Measurement (dBuV/m) = Reading(dBuV/m) + C.F (Correction Factor) °

EUT	WIFI CONTROL BOX	Test Date	2017/11/01
Factor	BBHA 9120D (1GHz~18GHz)	Temp. / Humidity	21°C / 57%
Polarity	Horizontal	Site / Engineer	AC1 / Peter
Test Mode	MODE1-CH11	Test Voltage	AC 120V/60Hz

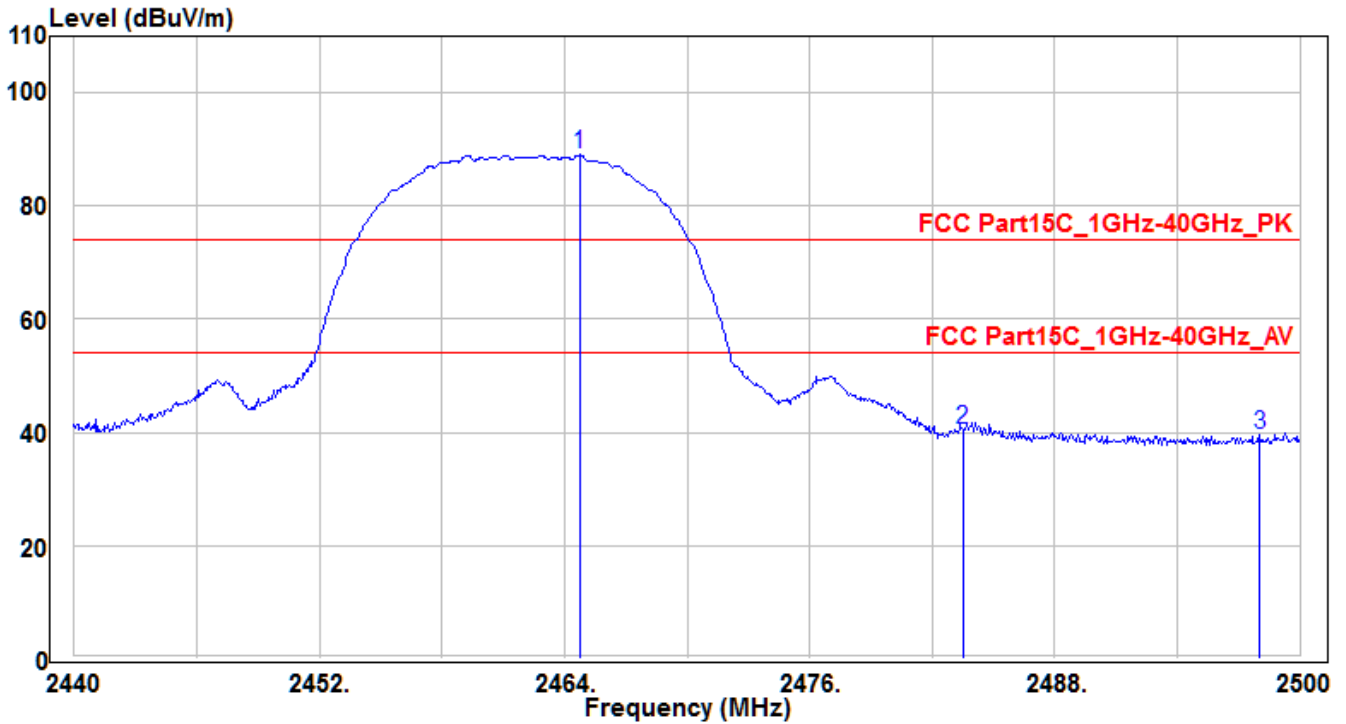

No	Frequency (MHz)	Reading (dBuV/m)	C.F (dB)	Measurement (dBuV/m)	Margin (dB)	Limit (dBuV/m)	Height (cm)	Angle (deg)	Remark (QP/PK/AV)
1	2464.72	91.22	-2.2	89.02	15.02	74	150	380	Peak
2	* 2483.5	42.66	-2.11	40.55	-33.45	74	150	380	Peak
3	2498.02	41.74	-2.03	39.71	-34.29	74	150	380	Peak

Note :

- "*" means the worst value in this measurement data °
- C.F (Correction Factor) = Antenna Factor (dB)+ Cable Loss (dB) – Preamplifier(dB) °
- Measurement (dBuV/m) = Reading(dBuV/m) + C.F (Correction Factor) °

EUT	WIFI CONTROL BOX	Test Date	2017/11/01
Factor	BBHA 9120D (1GHz~18GHz)	Temp. / Humidity	21°C / 57%
Polarity	Vertical	Site / Engineer	AC1 / Peter
Test Mode	MODE1-CH11	Test Voltage	AC 120V/60Hz

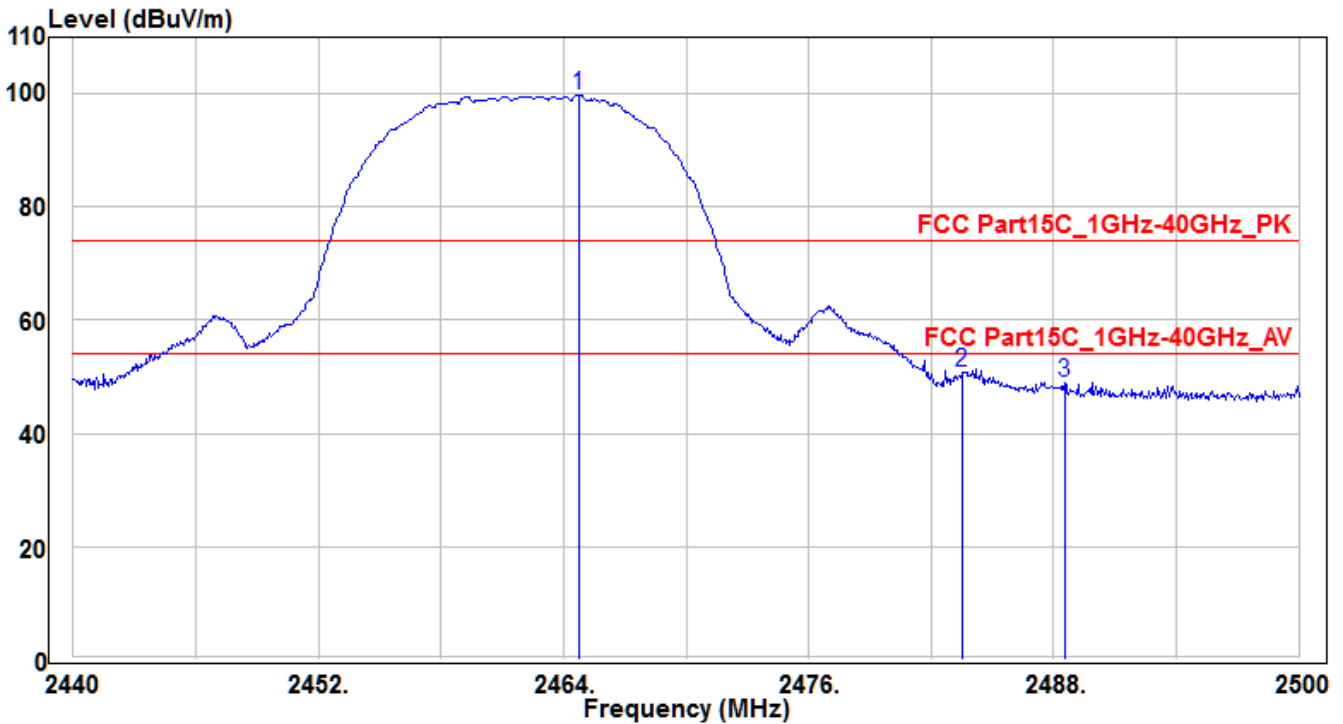

No	Frequency (MHz)	Reading (dBuV/m)	C.F (dB)	Measurement (dBuV/m)	Margin (dB)	Limit (dBuV/m)	Height (cm)	Angle (deg)	Remark (QP/PK/AV)
1	2464.72	102.08	-2.2	99.88	25.88	74	170	240	Peak
2	* 2483.5	52.9	-2.11	50.79	-23.21	74	170	240	Peak
3	2488.54	51.07	-2.07	49	-25	74	170	240	Peak

Note :

1. " * " means the worst value in this measurement data °
2. C.F (Correction Factor) = Antenna Factor (dB)+ Cable Loss (dB) – Preamplifier(dB) °
3. Measurement (dBuV/m) = Reading(dBuV/m) + C.F (Correction Factor) °

EUT	WIFI CONTROL BOX	Test Date	2017/11/01
Factor	BBHA 9120D (1GHz~18GHz)	Temp. / Humidity	21°C / 57%
Polarity	Horizontal	Site / Engineer	AC1 / Peter
Test Mode	MODE2-CH01	Test Voltage	AC 120V/60Hz

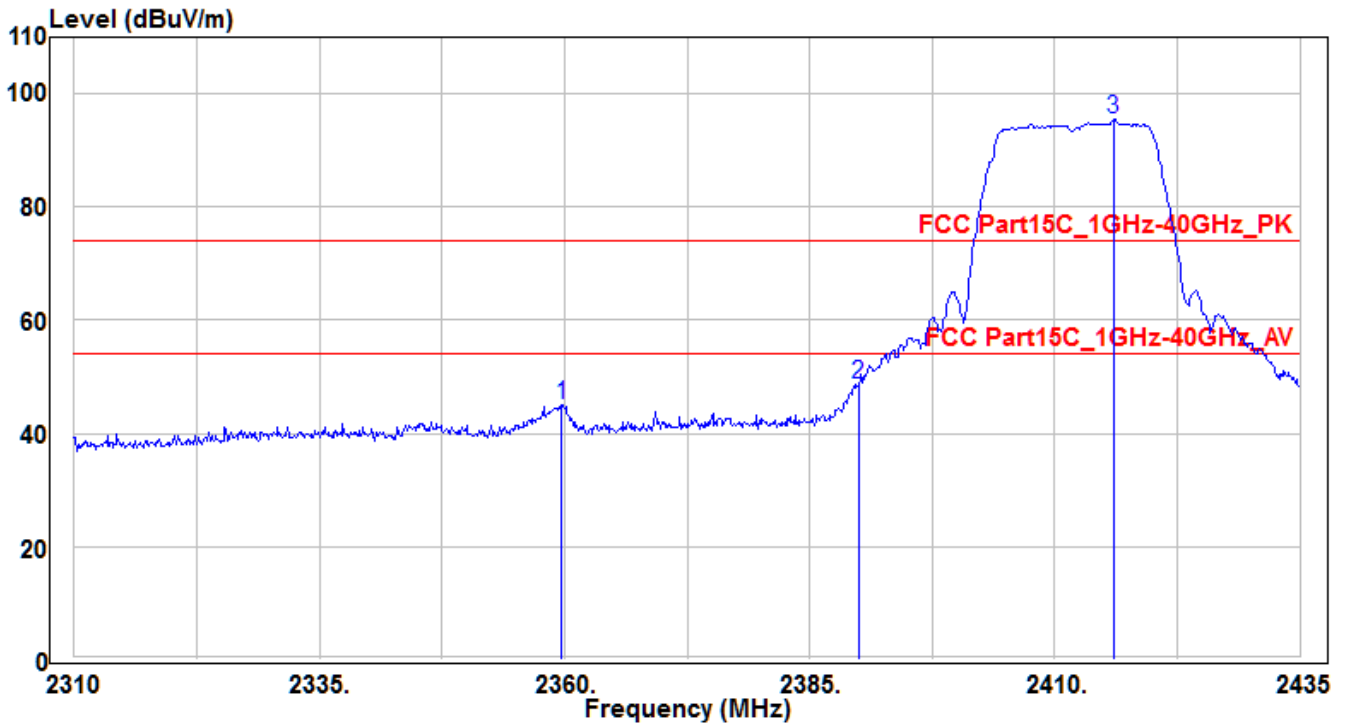

No	Frequency (MHz)	Reading (dBuV/m)	C.F (dB)	Measurement (dBuV/m)	Margin (dB)	Limit (dBuV/m)	Height (cm)	Angle (deg)	Remark (QP/PK/AV)
1	2359.75	47.87	-2.75	45.12	-28.88	74	150	45	Peak
2	* 2390	51.28	-2.59	48.69	-25.31	74	150	45	Peak
3	2416	98.02	-2.46	95.56	21.56	74	150	45	Peak

Note :

- "*" means the worst value in this measurement data °
- C.F (Correction Factor) = Antenna Factor (dB)+ Cable Loss (dB) – Preamplifier(dB) °
- Measurement (dBuV/m) = Reading(dBuV/m) + C.F (Correction Factor) °

EUT	WIFI CONTROL BOX	Test Date	2017/11/01
Factor	BBHA 9120D (1GHz~18GHz)	Temp. / Humidity	21°C / 57%
Polarity	Vertical	Site / Engineer	AC1 / Peter
Test Mode	MODE2-CH01	Test Voltage	AC 120V/60Hz

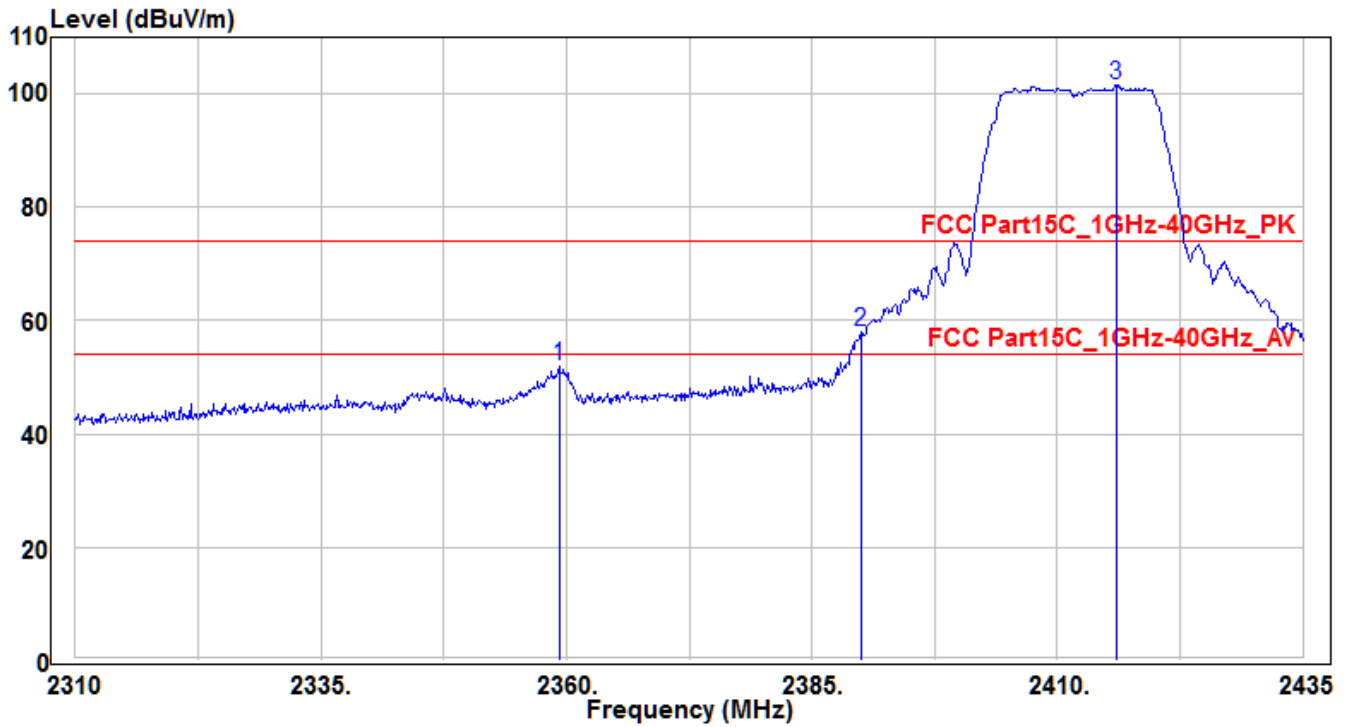

No	Frequency (MHz)	Reading (dBuV/m)	C.F (dB)	Measurement (dBuV/m)	Margin (dB)	Limit (dBuV/m)	Height (cm)	Angle (deg)	Remark (QP/PK/AV)
1	2359.25	54.88	-2.75	52.13	-21.87	74	210	135	Peak
2	* 2390	60.53	-2.59	57.94	-16.06	74	210	135	Peak
3	2416	104.14	-2.46	101.68	27.68	74	210	135	Peak

Note :

- "*" means the worst value in this measurement data °
- C.F (Correction Factor) = Antenna Factor (dB)+ Cable Loss (dB) – Preamplifier(dB) °
- Measurement (dBuV/m) = Reading(dBuV/m) + C.F (Correction Factor) °

EUT	WIFI CONTROL BOX	Test Date	2017/11/01
Factor	BBHA 9120D (1GHz~18GHz)	Temp. / Humidity	21°C / 57%
Polarity	Vertical	Site / Engineer	AC1 / Peter
Test Mode	MODE2-CH01	Test Voltage	AC 120V/60Hz

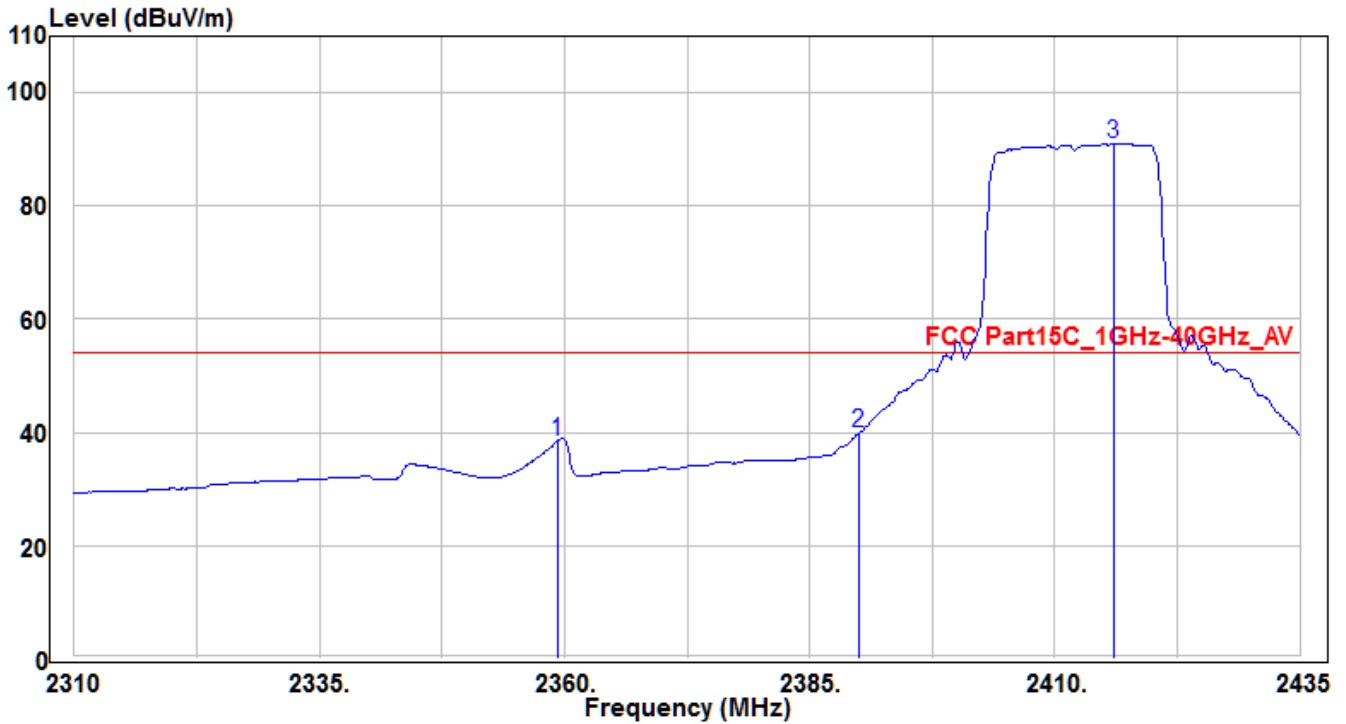

No	Frequency (MHz)	Reading (dBuV/m)	C.F (dB)	Measurement (dBuV/m)	Margin (dB)	Limit (dBuV/m)	Height (cm)	Angle (deg)	Remark (QP/PK/AV)
1	2359.25	41.14	-2.75	38.39	-15.61	54	210	135	Average
2	* 2390	42.49	-2.59	39.9	-14.1	54	210	135	Average
3	2416	93.38	-2.46	90.92	36.92	54	210	135	Average

Note :

- "*" means the worst value in this measurement data °
- C.F (Correction Factor) = Antenna Factor (dB)+ Cable Loss (dB) – Preamplifier(dB) °
- Measurement (dBuV/m) = Reading(dBuV/m) + C.F (Correction Factor) °

EUT	WIFI CONTROL BOX	Test Date	2017/11/01
Factor	BBHA 9120D (1GHz~18GHz)	Temp. / Humidity	21°C / 57%
Polarity	Horizontal	Site / Engineer	AC1 / Peter
Test Mode	MODE2-CH11	Test Voltage	AC 120V/60Hz

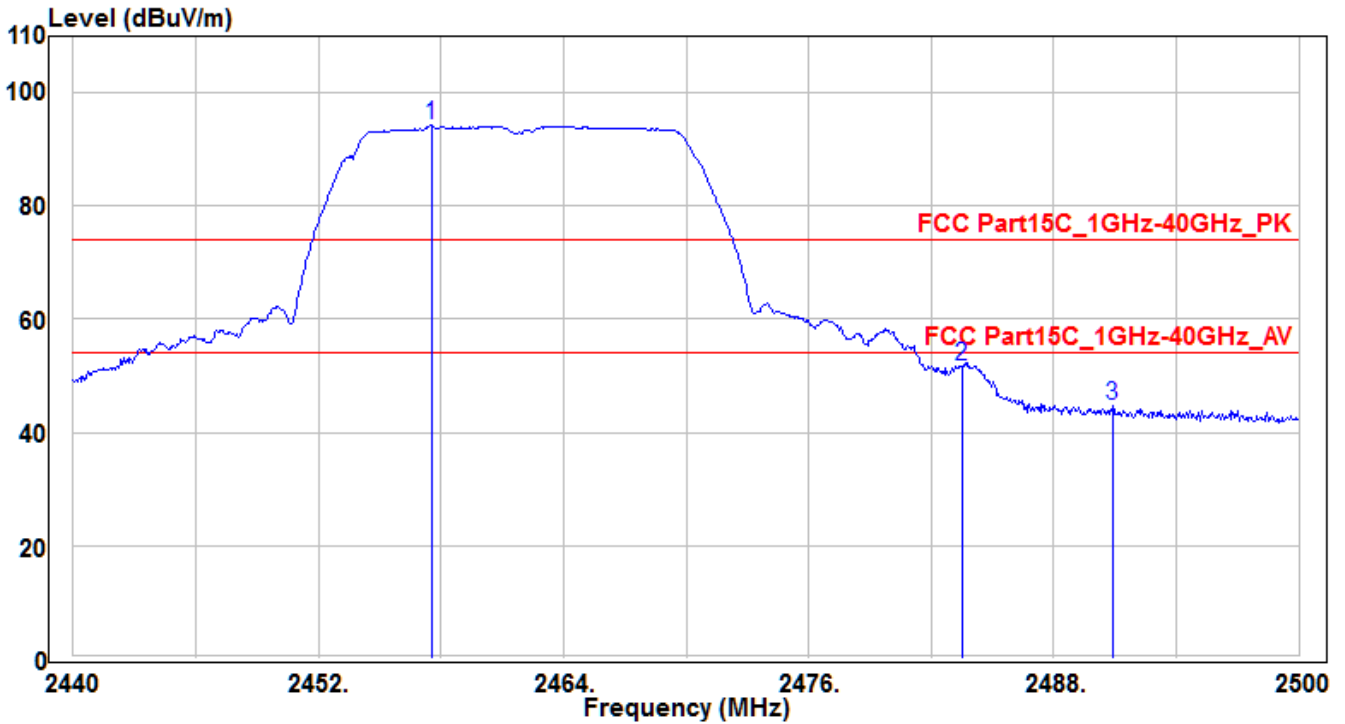

No	Frequency (MHz)	Reading (dBuV/m)	C.F (dB)	Measurement (dBuV/m)	Margin (dB)	Limit (dBuV/m)	Height (cm)	Angle (deg)	Remark (QP/PK/AV)
1	2457.52	96.58	-2.24	94.34	20.34	74	150	400	Peak
2	* 2483.5	53.69	-2.11	51.58	-22.42	74	150	400	Peak
3	2490.88	46.74	-2.07	44.67	-29.33	74	150	400	Peak

Note :

- "*" means the worst value in this measurement data °
- C.F (Correction Factor) = Antenna Factor (dB)+ Cable Loss (dB) – Preamplifier(dB) °
- Measurement (dBuV/m) = Reading(dBuV/m) + C.F (Correction Factor) °

EUT	WIFI CONTROL BOX	Test Date	2017/11/01
Factor	BBHA 9120D (1GHz~18GHz)	Temp. / Humidity	21°C / 57%
Polarity	Vertical	Site / Engineer	AC1 / Peter
Test Mode	MODE2-CH11	Test Voltage	AC 120V/60Hz

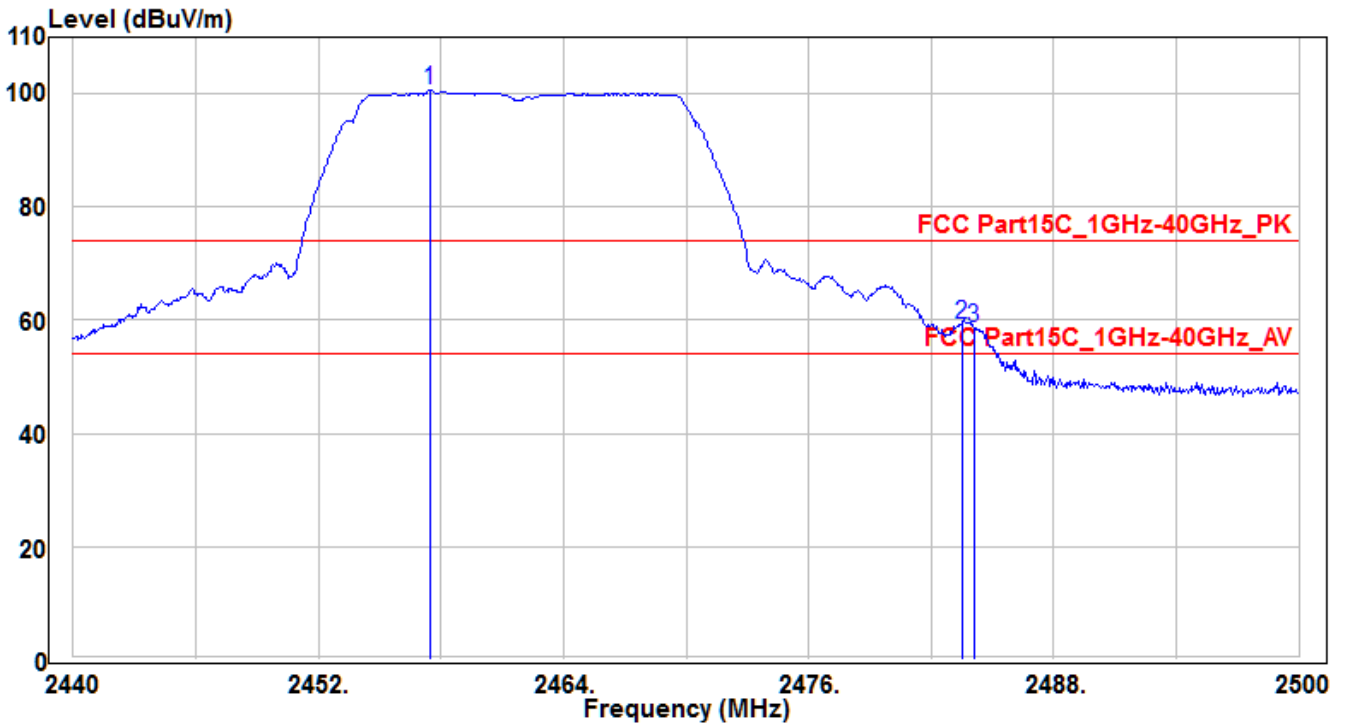

No	Frequency (MHz)	Reading (dBuV/m)	C.F (dB)	Measurement (dBuV/m)	Margin (dB)	Limit (dBuV/m)	Height (cm)	Angle (deg)	Remark (QP/PK/AV)
1	2457.46	102.88	-2.24	100.64	26.64	74	200	230	Peak
2	* 2483.5	61.35	-2.11	59.24	-14.76	74	200	230	Peak
3	2484.1	60.81	-2.1	58.71	-15.29	74	200	230	Peak

Note :

- "*" means the worst value in this measurement data °
- C.F (Correction Factor) = Antenna Factor (dB)+ Cable Loss (dB) – Preamplifier(dB) °
- Measurement (dBuV/m) = Reading(dBuV/m) + C.F (Correction Factor) °

EUT	WIFI CONTROL BOX	Test Date	2017/11/01
Factor	BBHA 9120D (1GHz~18GHz)	Temp. / Humidity	21°C / 57%
Polarity	Vertical	Site / Engineer	AC1 / Peter
Test Mode	MODE2-CH11	Test Voltage	AC 120V/60Hz

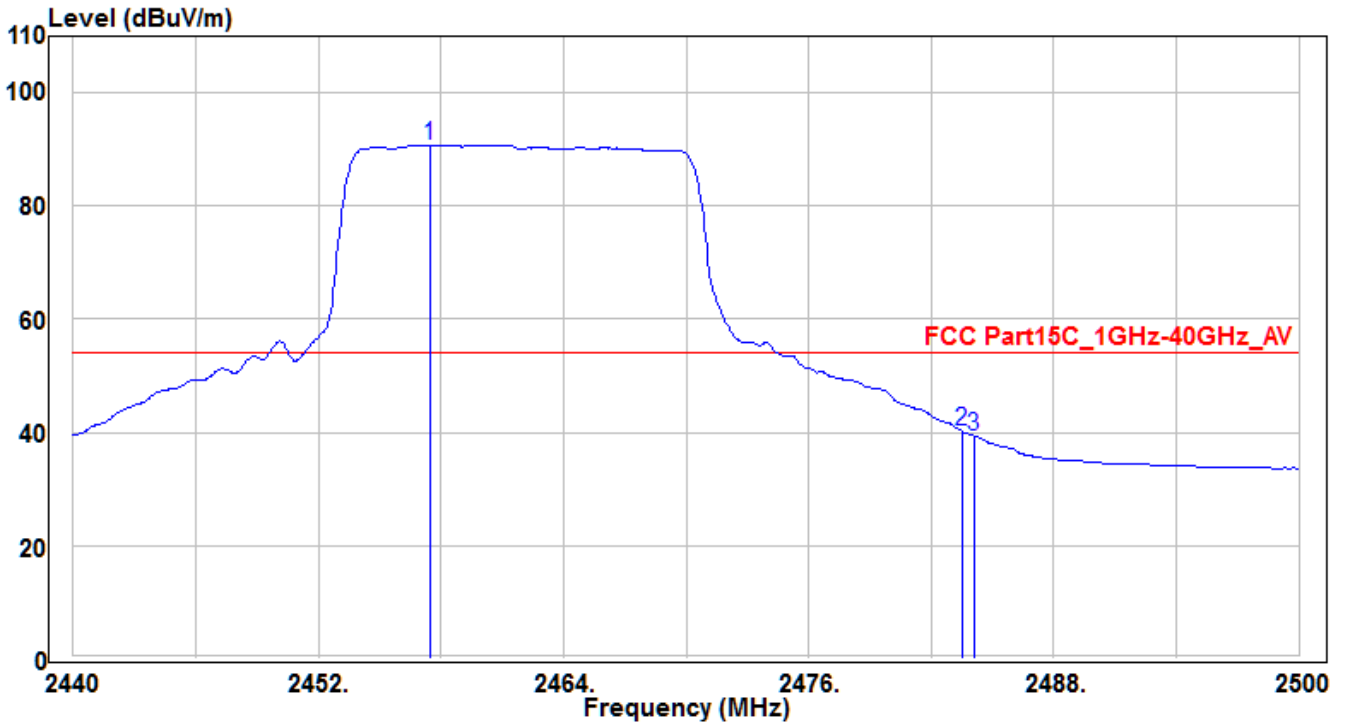

No	Frequency (MHz)	Reading (dBuV/m)	C.F (dB)	Measurement (dBuV/m)	Margin (dB)	Limit (dBuV/m)	Height (cm)	Angle (deg)	Remark (QP/PK/AV)
1	2457.46	92.93	-2.24	90.69	36.69	54	200	230	Average
2	* 2483.5	42.32	-2.11	40.21	-13.79	54	200	230	Average
3	2484.1	41.48	-2.1	39.38	-14.62	54	200	230	Average

Note :

- "*" means the worst value in this measurement data °
- C.F (Correction Factor) = Antenna Factor (dB)+ Cable Loss (dB) – Preamplifier(dB) °
- Measurement (dBuV/m) = Reading(dBuV/m) + C.F (Correction Factor) °

EUT	WIFI CONTROL BOX	Test Date	2017/11/01
Factor	BBHA 9120D (1GHz~18GHz)	Temp. / Humidity	21°C / 57%
Polarity	Horizontal	Site / Engineer	AC1 / Peter
Test Mode	MODE3-CH01	Test Voltage	AC 120V/60Hz

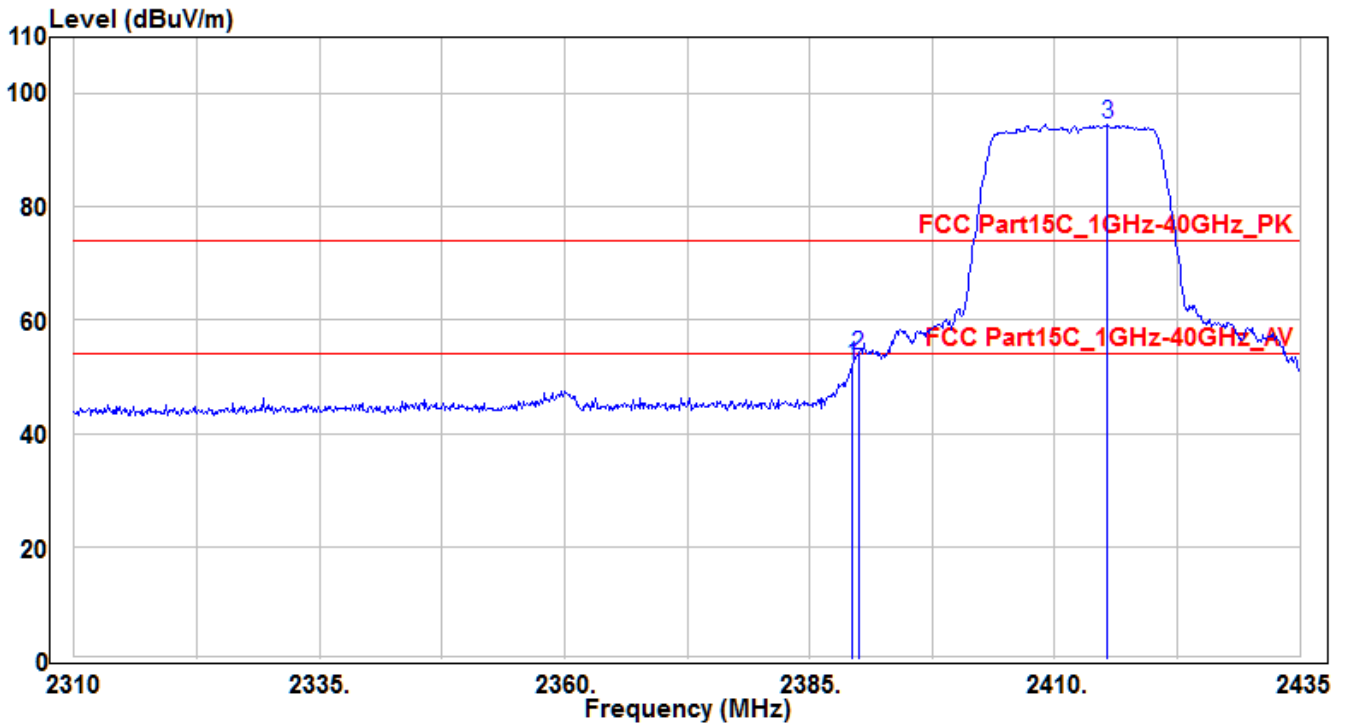

No	Frequency (MHz)	Reading (dBuV/m)	C.F (dB)	Measurement (dBuV/m)	Margin (dB)	Limit (dBuV/m)	Height (cm)	Angle (deg)	Remark (QP/PK/AV)	
1	*	2389.375	54.53	-2.59	51.94	-22.06	74	150	45	Peak
2		2390	56.37	-2.59	53.78	-20.22	74	150	45	Peak
3		2415.375	97.05	-2.46	94.59	20.59	74	150	45	Peak

Note :

- "*" means the worst value in this measurement data °
- C.F (Correction Factor) = Antenna Factor (dB)+ Cable Loss (dB) – Preamplifier(dB) °
- Measurement (dBuV/m) = Reading(dBuV/m) + C.F (Correction Factor) °

EUT	WIFI CONTROL BOX	Test Date	2017/11/01
Factor	BBHA 9120D (1GHz~18GHz)	Temp. / Humidity	21°C / 57%
Polarity	Vertical	Site / Engineer	AC1 / Peter
Test Mode	MODE3-CH01	Test Voltage	AC 120V/60Hz

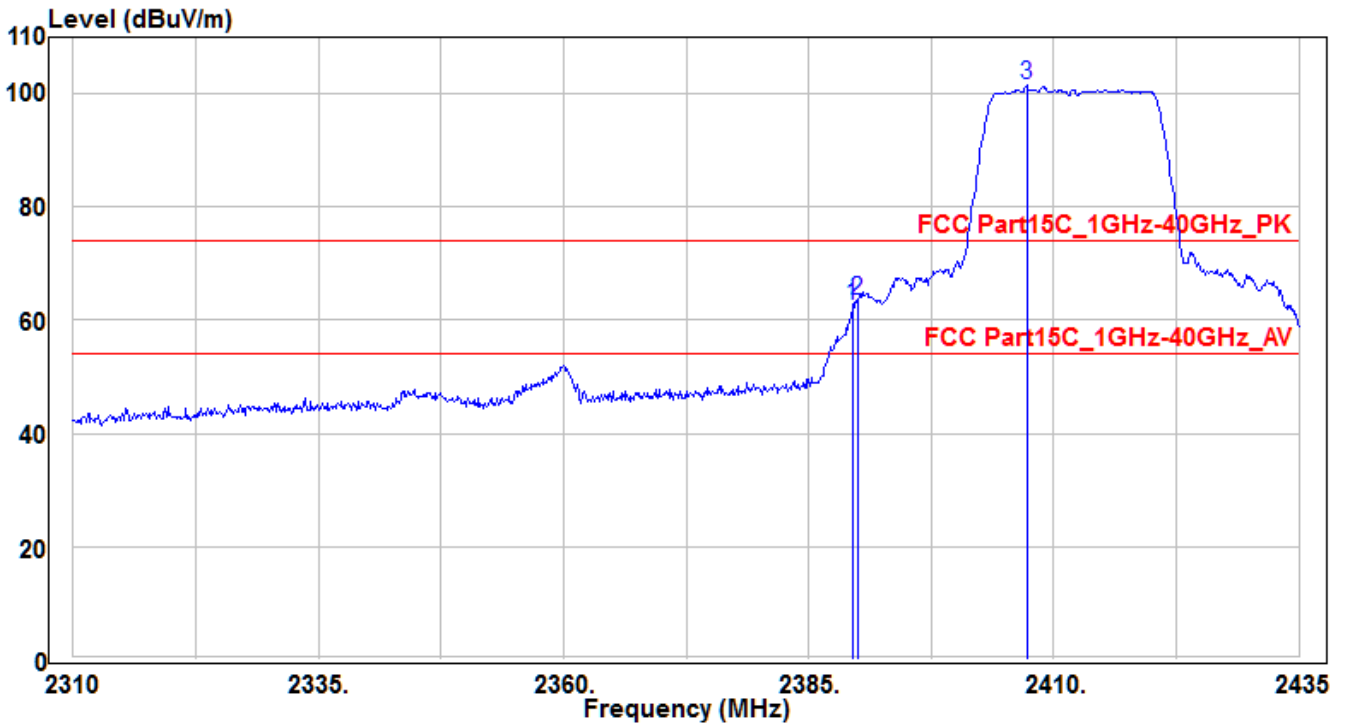

No	Frequency (MHz)	Reading (dBuV/m)	C.F (dB)	Measurement (dBuV/m)	Margin (dB)	Limit (dBuV/m)	Height (cm)	Angle (deg)	Remark (QP/PK/AV)
1	2389.5	65.14	-2.59	62.55	-11.45	74	230	135	Peak
2	* 2390	66.08	-2.59	63.49	-10.51	74	230	135	Peak
3	2407.25	103.9	-2.5	101.4	27.4	74	230	135	Peak

Note :

- " * " means the worst value in this measurement data °
- C.F (Correction Factor) = Antenna Factor (dB)+ Cable Loss (dB) – Preamplifier(dB) °
- Measurement (dBuV/m) = Reading(dBuV/m) + C.F (Correction Factor) °

EUT	WIFI CONTROL BOX	Test Date	2017/11/01
Factor	BBHA 9120D (1GHz~18GHz)	Temp. / Humidity	21°C / 57%
Polarity	Vertical	Site / Engineer	AC1 / Peter
Test Mode	MODE3-CH01	Test Voltage	AC 120V/60Hz

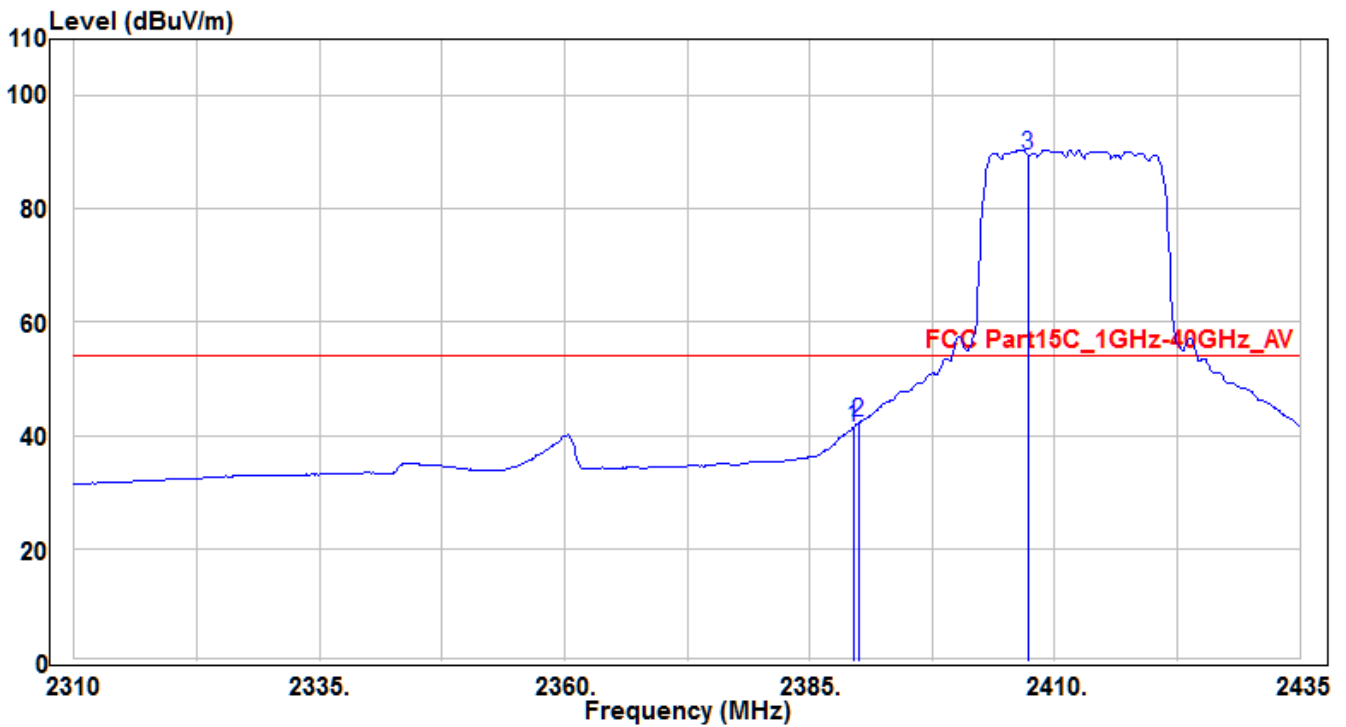

No	Frequency (MHz)	Reading (dBuV/m)	C.F (dB)	Measurement (dBuV/m)	Margin (dB)	Limit (dBuV/m)	Height (cm)	Angle (deg)	Remark (QP/PK/AV)
1	2389.5	44.09	-2.59	41.5	-12.5	54	230	135	Average
2	* 2390	44.93	-2.59	42.34	-11.66	54	230	135	Average
3	2407.25	91.87	-2.5	89.37	35.37	54	230	135	Average

Note :

- "*" means the worst value in this measurement data °
- C.F (Correction Factor) = Antenna Factor (dB)+ Cable Loss (dB) – Preamplifier(dB) °
- Measurement (dBuV/m) = Reading(dBuV/m) + C.F (Correction Factor) °

EUT	WIFI CONTROL BOX	Test Date	2017/11/01
Factor	BBHA 9120D (1GHz~18GHz)	Temp. / Humidity	21°C / 57%
Polarity	Horizontal	Site / Engineer	AC1 / Peter
Test Mode	MODE3-CH11	Test Voltage	AC 120V/60Hz

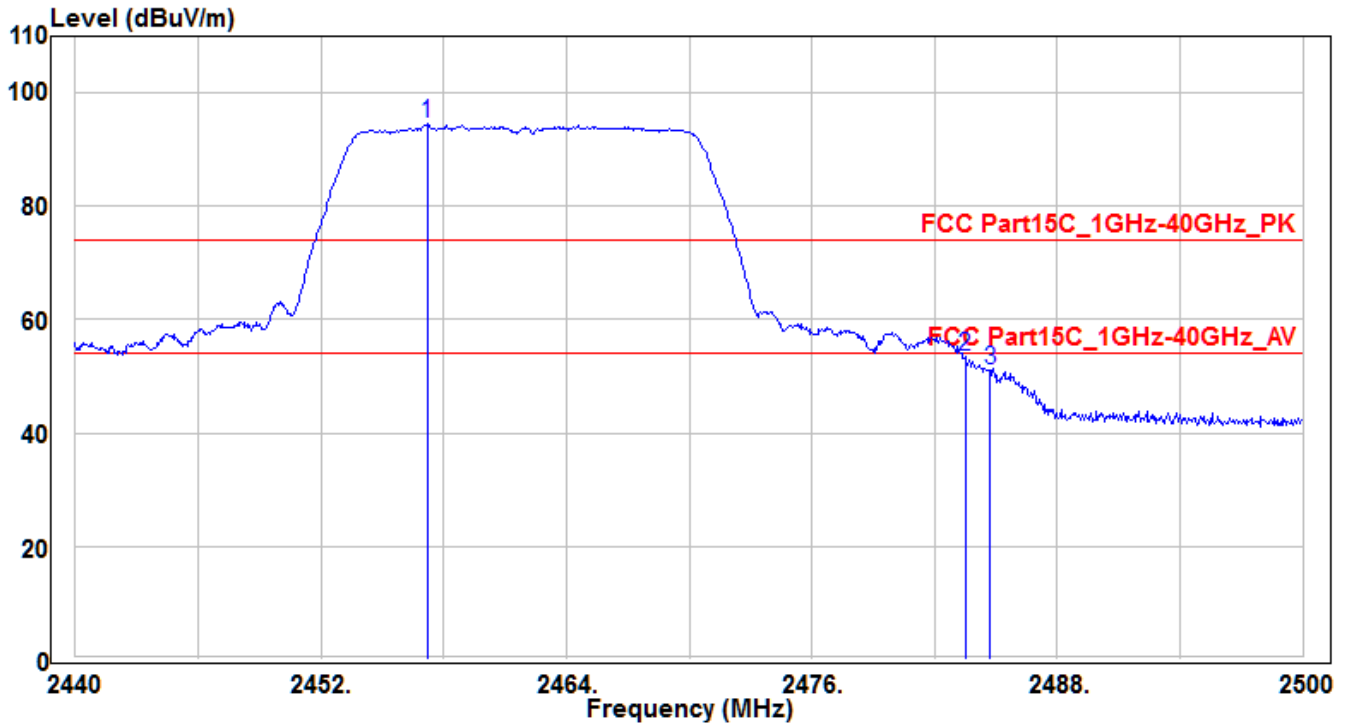

No	Frequency (MHz)	Reading (dBuV/m)	C.F (dB)	Measurement (dBuV/m)	Margin (dB)	Limit (dBuV/m)	Height (cm)	Angle (deg)	Remark (QP/PK/AV)
1	2457.22	96.7	-2.24	94.46	20.46	74	150	400	Peak
2	* 2483.5	55.48	-2.11	53.37	-20.63	74	150	400	Peak
3	2484.7	53.17	-2.1	51.07	-22.93	74	150	400	Peak

Note :

- "*" means the worst value in this measurement data °
- C.F (Correction Factor) = Antenna Factor (dB)+ Cable Loss (dB) – Preamplifier(dB) °
- Measurement (dBuV/m) = Reading(dBuV/m) + C.F (Correction Factor) °

EUT	WIFI CONTROL BOX	Test Date	2017/11/01
Factor	BBHA 9120D (1GHz~18GHz)	Temp. / Humidity	21°C / 57%
Polarity	Vertical	Site / Engineer	AC1 / Peter
Test Mode	MODE3-CH11	Test Voltage	AC 120V/60Hz

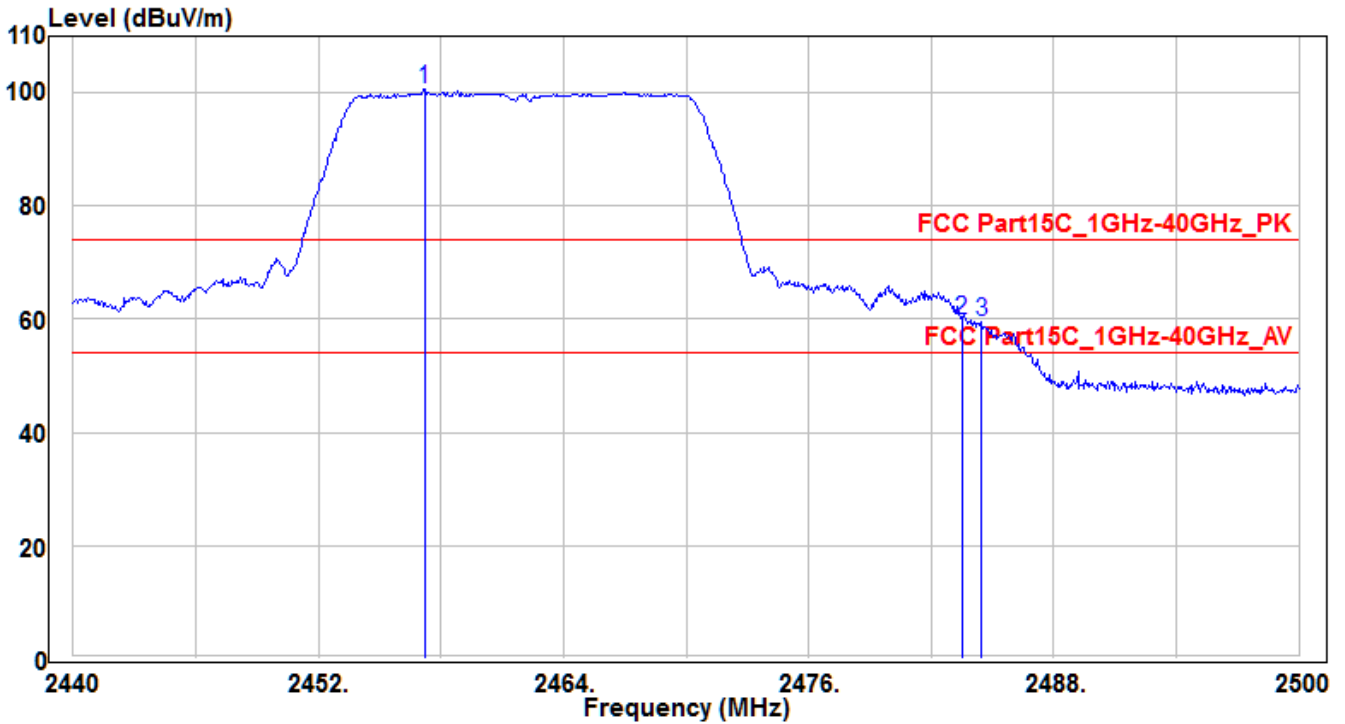

No	Frequency (MHz)	Reading (dBuV/m)	C.F (dB)	Measurement (dBuV/m)	Margin (dB)	Limit (dBuV/m)	Height (cm)	Angle (deg)	Remark (QP/PK/AV)
1	2457.22	102.9	-2.24	100.66	26.66	74	205	235	Peak
2	* 2483.5	62.01	-2.11	59.9	-14.10	74	205	235	Peak
3	2484.46	61.66	-2.1	59.56	-14.44	74	205	235	Peak

Note :

- "*" means the worst value in this measurement data °
- C.F (Correction Factor) = Antenna Factor (dB)+ Cable Loss (dB) – Preamplifier(dB) °
- Measurement (dBuV/m) = Reading(dBuV/m) + C.F (Correction Factor) °

EUT	WIFI CONTROL BOX	Test Date	2017/11/01
Factor	BBHA 9120D (1GHz~18GHz)	Temp. / Humidity	21°C / 57%
Polarity	Vertical	Site / Engineer	AC1 / Peter
Test Mode	MODE3-CH11	Test Voltage	AC 120V/60Hz

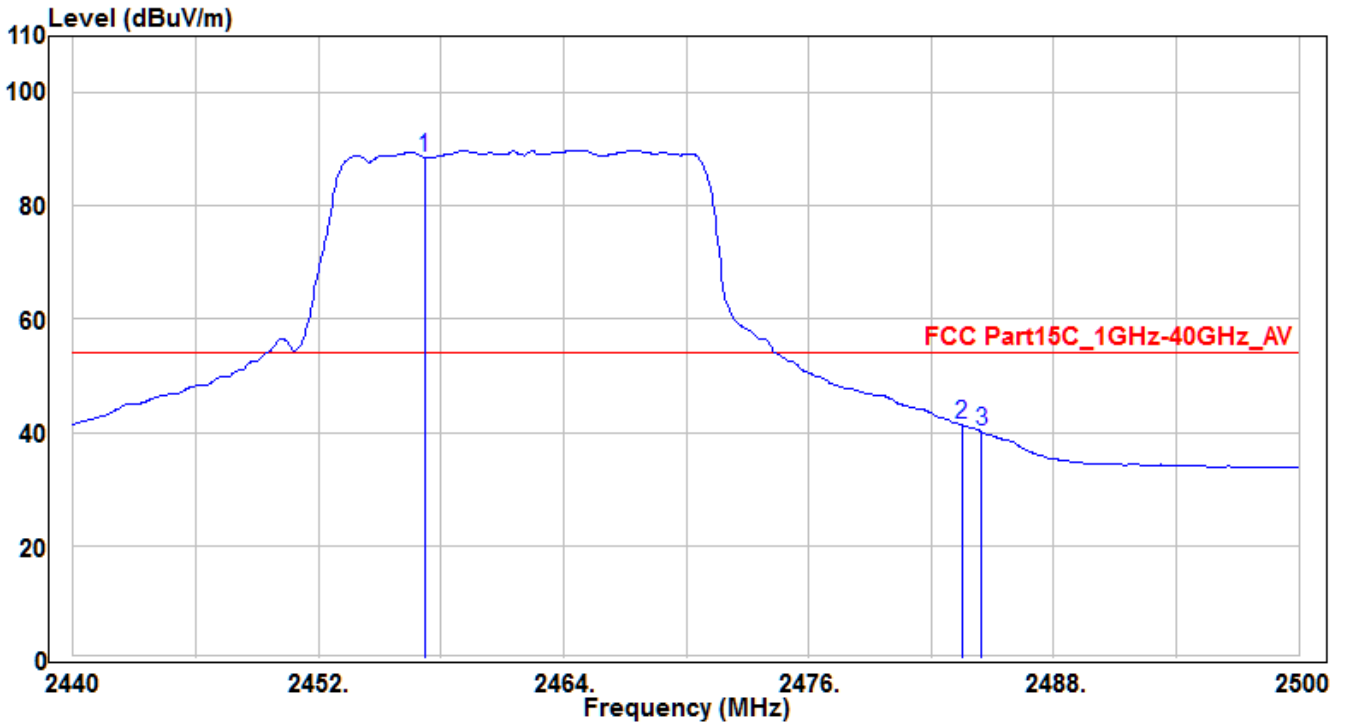

No	Frequency (MHz)	Reading (dBuV/m)	C.F (dB)	Measurement (dBuV/m)	Margin (dB)	Limit (dBuV/m)	Height (cm)	Angle (deg)	Remark (QP/PK/AV)
1	2457.22	90.84	-2.24	88.6	34.6	54	205	235	Average
2	* 2483.5	43.38	-2.11	41.27	-12.73	54	205	235	Average
3	2484.46	42.26	-2.1	40.16	-13.84	54	205	235	Average

Note :

- "*" means the worst value in this measurement data °
- C.F (Correction Factor) = Antenna Factor (dB)+ Cable Loss (dB) – Preamplifier(dB) °
- Measurement (dBuV/m) = Reading(dBuV/m) + C.F (Correction Factor) °

EUT	WIFI CONTROL BOX	Test Date	2017/11/01
Factor	BBHA 9120D (1GHz~18GHz)	Temp. / Humidity	21°C / 57%
Polarity	Horizontal	Site / Engineer	AC1 / Peter
Test Mode	MODE4-CH03	Test Voltage	AC 120V/60Hz

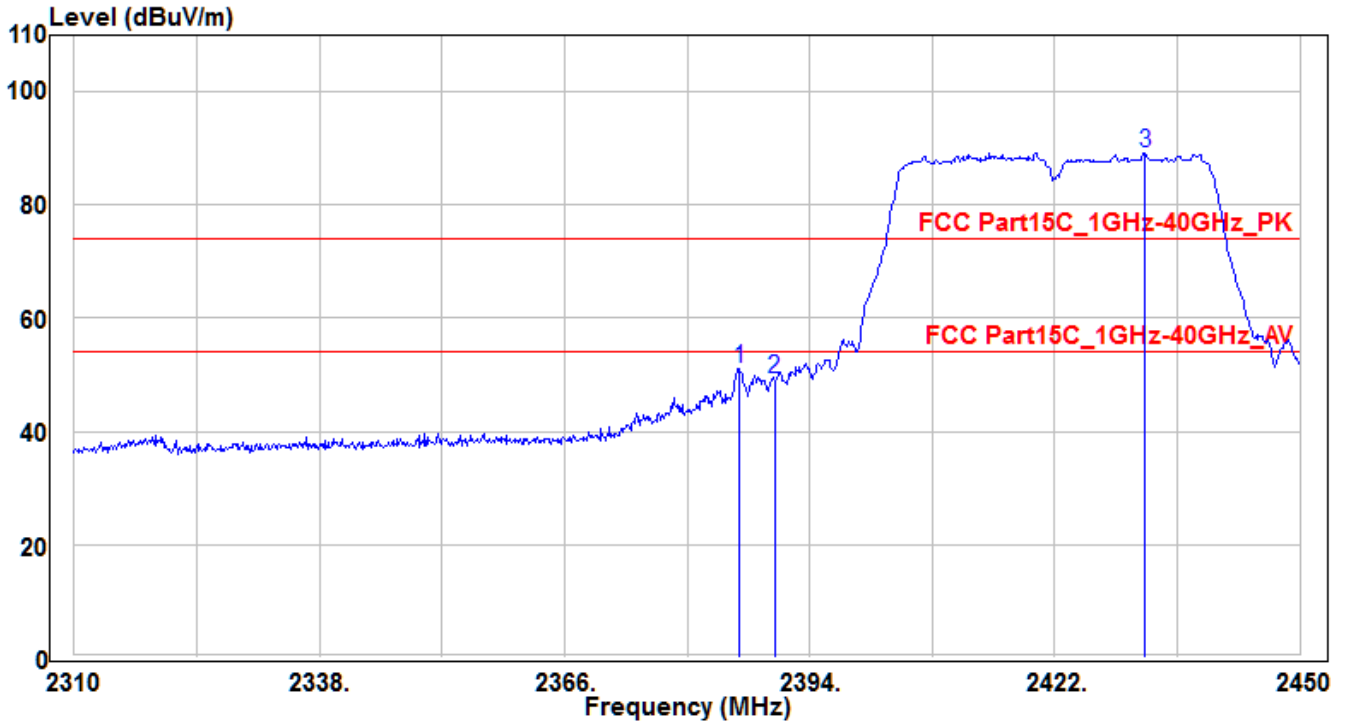

No	Frequency (MHz)	Reading (dBuV/m)	C.F (dB)	Measurement (dBuV/m)	Margin (dB)	Limit (dBuV/m)	Height (cm)	Angle (deg)	Remark (QP/PK/AV)	
1	*	2386.02	53.84	-2.62	51.22	-22.78	74	170	400	Peak
2		2390	51.74	-2.59	49.15	-24.85	74	170	400	Peak
3		2432.36	91.62	-2.37	89.25	15.25	74	170	400	Peak

Note :

1. " * " means the worst value in this measurement data .
2. C.F (Correction Factor) = Antenna Factor (dB)+ Cable Loss (dB) – Preamplifier(dB) .
3. Measurement (dBuV/m) = Reading(dBuV/m) + C.F (Correction Factor) .

EUT	WIFI CONTROL BOX	Test Date	2017/11/01
Factor	BBHA 9120D (1GHz~18GHz)	Temp. / Humidity	21°C / 57%
Polarity	Vertical	Site / Engineer	AC1 / Peter
Test Mode	MODE4-CH03	Test Voltage	AC 120V/60Hz

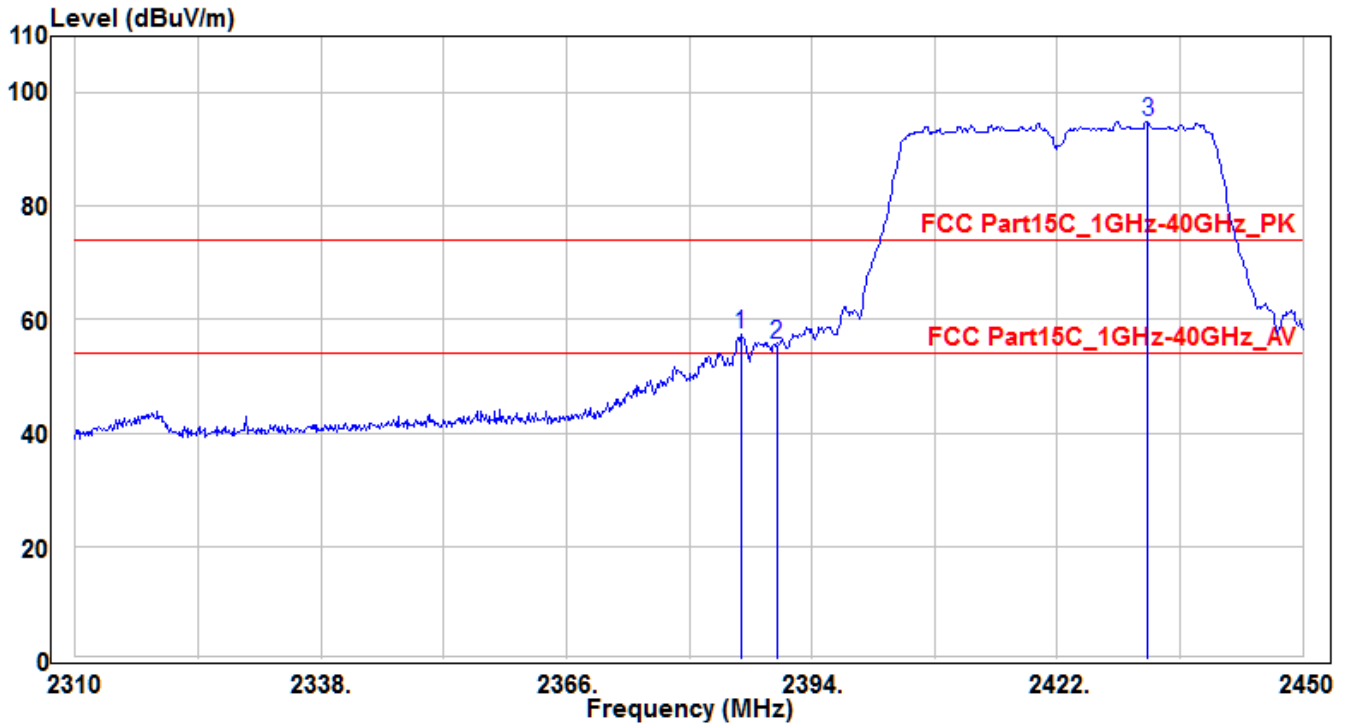

No	Frequency (MHz)	Reading (dBUV/m)	C.F (dB)	Measurement (dBUV/m)	Margin (dB)	Limit (dBUV/m)	Height (cm)	Angle (deg)	Remark (QP/PK/AV)
1	* 2385.88	60.2	-2.62	57.58	-16.42	74	230	-10	Peak
2	2390	58.27	-2.59	55.68	-18.32	74	230	-10	Peak
3	2432.36	97.39	-2.37	95.02	21.02	74	230	-10	Peak

Note :

1. " * " means the worst value in this measurement data °
2. C.F (Correction Factor) = Antenna Factor (dB)+ Cable Loss (dB) – Preamplifier(dB) °
3. Measurement (dBUV/m) = Reading(dBUV/m) + C.F (Correction Factor) °

EUT	WIFI CONTROL BOX	Test Date	2017/11/01
Factor	BBHA 9120D (1GHz~18GHz)	Temp. / Humidity	21°C / 57%
Polarity	Vertical	Site / Engineer	AC1 / Peter
Test Mode	MODE4-CH03	Test Voltage	AC 120V/60Hz

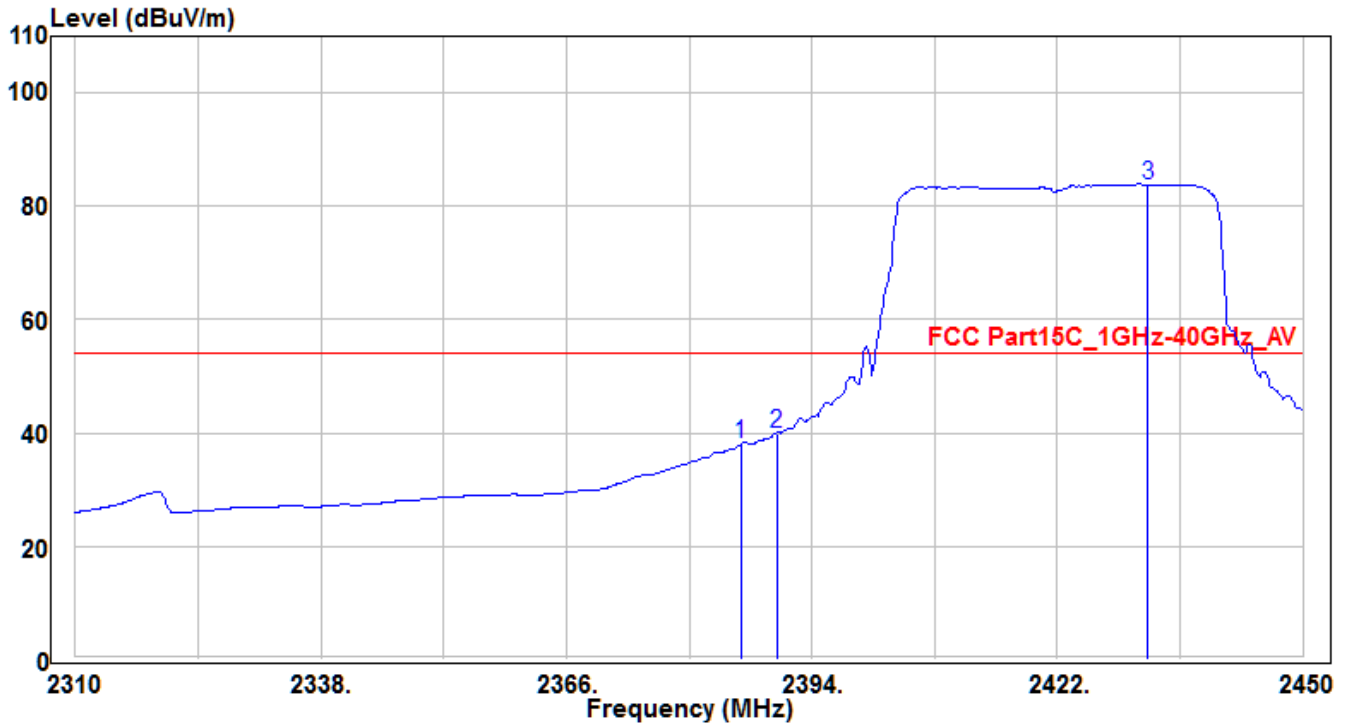

No	Frequency (MHz)	Reading (dBuV/m)	C.F (dB)	Measurement (dBuV/m)	Margin (dB)	Limit (dBuV/m)	Height (cm)	Angle (deg)	Remark (QP/PK/AV)
1	2385.88	40.67	-2.62	38.05	-15.95	54	230	-10	Average
2	* 2390	42.62	-2.59	40.03	-13.97	54	230	-10	Average
3	2432.36	86.14	-2.37	83.77	29.77	54	230	-10	Average

Note :

1. " * " means the worst value in this measurement data °
2. C.F (Correction Factor) = Antenna Factor (dB)+ Cable Loss (dB) – Preamplifier(dB) °
3. Measurement (dBuV/m) = Reading(dBuV/m) + C.F (Correction Factor) °

EUT	WIFI CONTROL BOX	Test Date	2017/11/01
Factor	BBHA 9120D (1GHz~18GHz)	Temp. / Humidity	21°C / 57%
Polarity	Horizontal	Site / Engineer	AC1 / Peter
Test Mode	MODE4-CH09	Test Voltage	AC 120V/60Hz

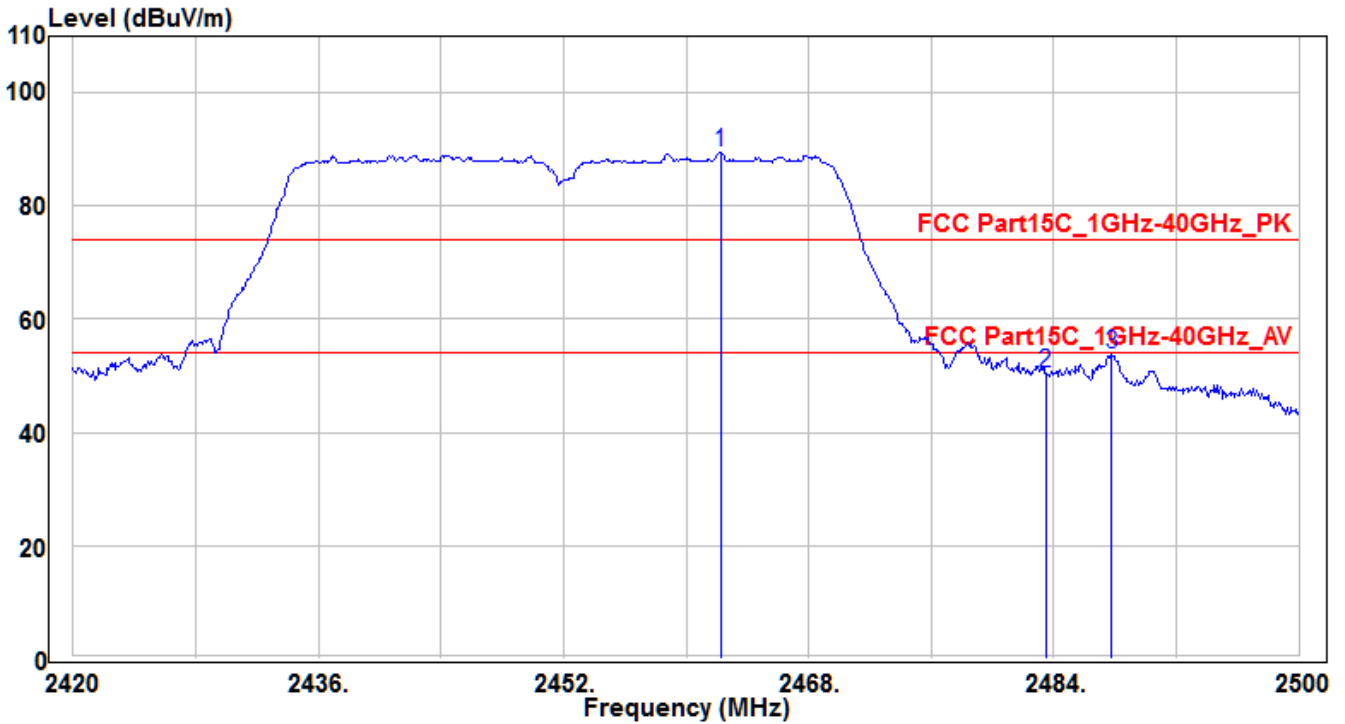

No	Frequency (MHz)	Reading (dBuV/m)	C.F (dB)	Measurement (dBuV/m)	Margin (dB)	Limit (dBuV/m)	Height (cm)	Angle (deg)	Remark (QP/PK/AV)
1	2462.24	91.66	-2.23	89.43	15.43	74	150	40	Peak
2	2483.5	52.45	-2.11	50.34	-23.66	74	150	40	Peak
3	* 2487.76	55.79	-2.07	53.72	-20.28	74	150	40	Peak

Note :

- "*" means the worst value in this measurement data °
- C.F (Correction Factor) = Antenna Factor (dB)+ Cable Loss (dB) – Preamplifier(dB) °
- Measurement (dBuV/m) = Reading(dBuV/m) + C.F (Correction Factor) °

EUT	WIFI CONTROL BOX	Test Date	2017/11/01
Factor	BBHA 9120D (1GHz~18GHz)	Temp. / Humidity	21°C / 57%
Polarity	Vertical	Site / Engineer	AC1 / Peter
Test Mode	MODE4-CH09	Test Voltage	AC 120V/60Hz

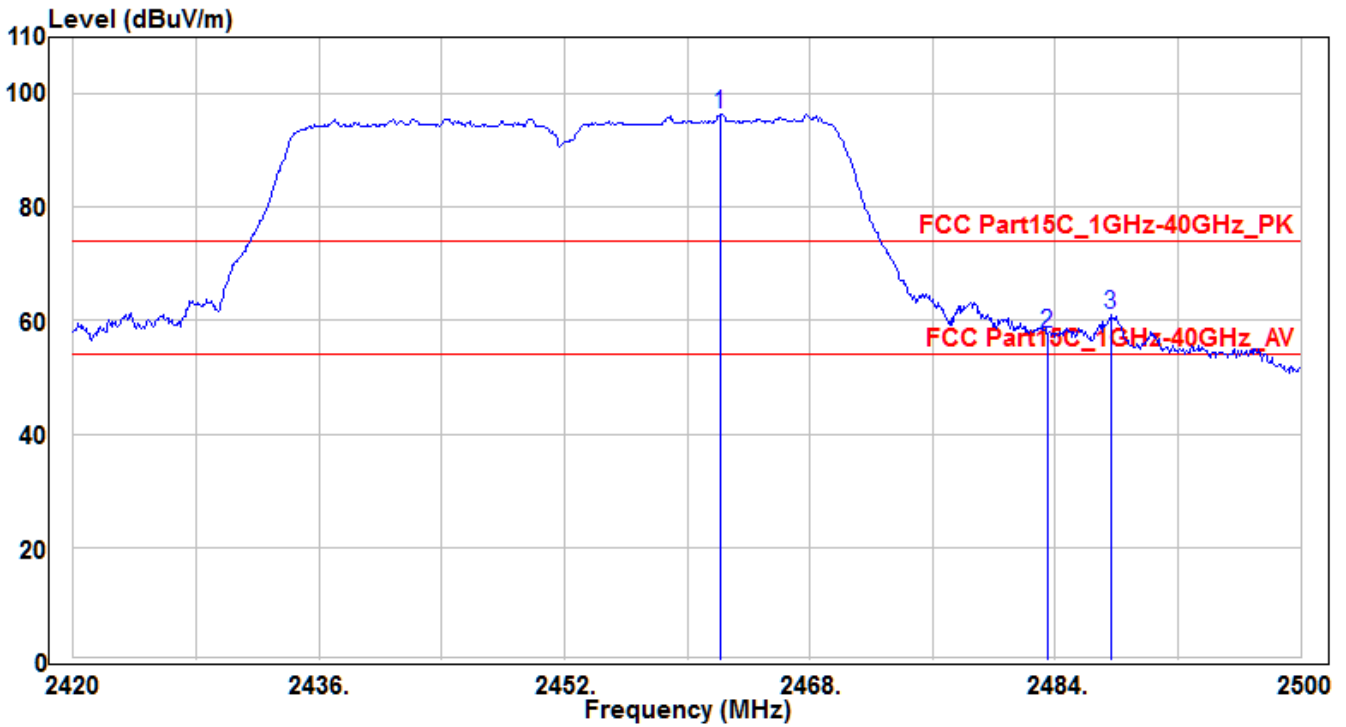

No	Frequency (MHz)	Reading (dBuV/m)	C.F (dB)	Measurement (dBuV/m)	Margin (dB)	Limit (dBuV/m)	Height (cm)	Angle (deg)	Remark (QP/PK/AV)
1	2462.16	98.73	-2.23	96.5	22.5	74	240	310	Peak
2	2483.5	59.91	-2.11	57.8	-16.2	74	240	310	Peak
3	* 2487.6	63.23	-2.07	61.16	-12.84	74	240	310	Peak

Note :

- "*" means the worst value in this measurement data °
- C.F (Correction Factor) = Antenna Factor (dB)+ Cable Loss (dB) – Preamplifier(dB) °
- Measurement (dBuV/m) = Reading(dBuV/m) + C.F (Correction Factor) °

EUT	WIFI CONTROL BOX	Test Date	2017/11/01
Factor	BBHA 9120D (1GHz~18GHz)	Temp. / Humidity	21°C / 57%
Polarity	Vertical	Site / Engineer	AC1 / Peter
Test Mode	MODE4-CH09	Test Voltage	AC 120V/60Hz

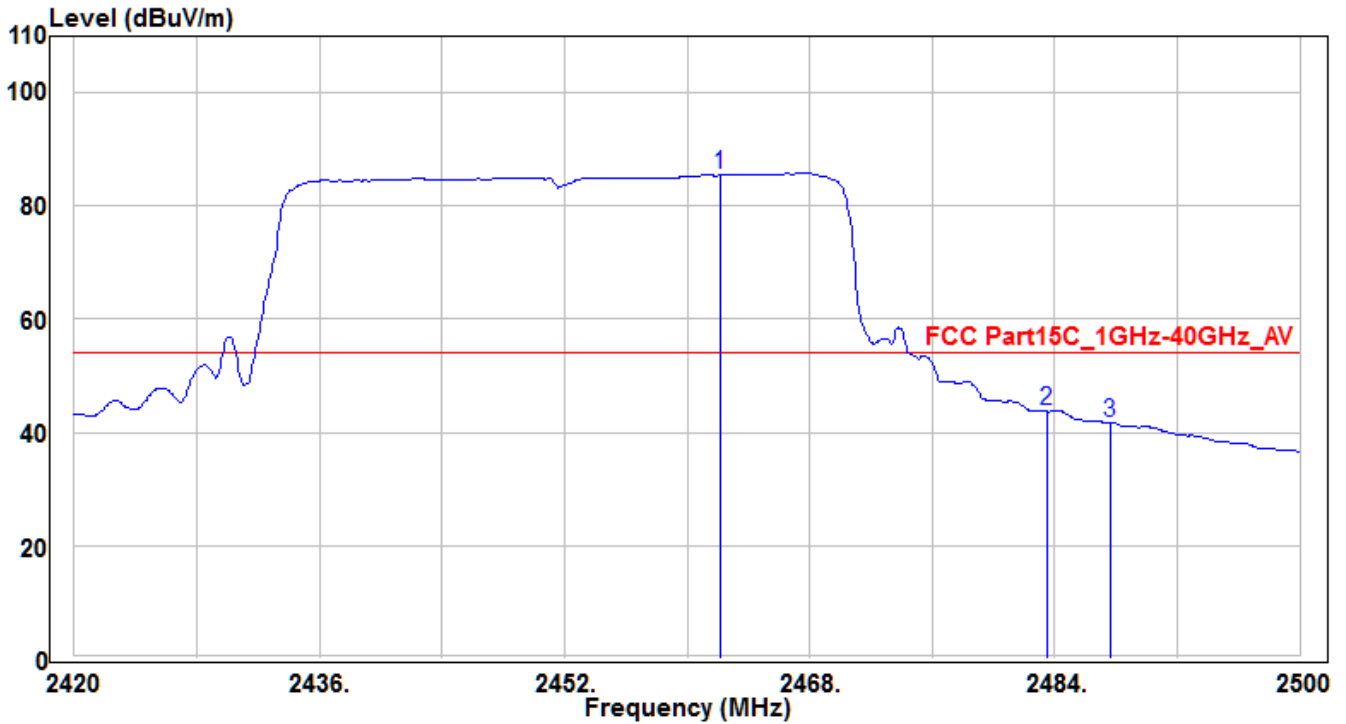

No	Frequency (MHz)	Reading (dBuV/m)	C.F (dB)	Measurement (dBuV/m)	Margin (dB)	Limit (dBuV/m)	Height (cm)	Angle (deg)	Remark (QP/PK/AV)
1	2462.16	87.67	-2.23	85.44	31.44	54	240	310	Average
2	* 2483.5	45.82	-2.11	43.71	-10.29	54	240	310	Average
3	2487.6	43.84	-2.07	41.77	-12.23	54	240	310	Average

Note :

- "*" means the worst value in this measurement data °
- C.F (Correction Factor) = Antenna Factor (dB)+ Cable Loss (dB) – Preamplifier(dB) °
- Measurement (dBuV/m) = Reading(dBuV/m) + C.F (Correction Factor) °

7.8. AC Conducted Emissions Measurement

7.8.1. Test Limit

FCC Part 15 Subpart C Paragraph 15.207 / RSS-Gen Limits		
Frequency (MHz)	QP (dB μ V)	Average (dB μ V)
0.15 - 0.50	66 - 56	56 - 46
0.50 - 5.0	56	46
5.0 - 30	60	50

Note 1: The lower limit shall apply at the transition frequencies.

Note 2: The limit decreases linearly with the logarithm of the frequency in the range 0.15MHz to 0.5MHz.

7.8.2. Test Setup

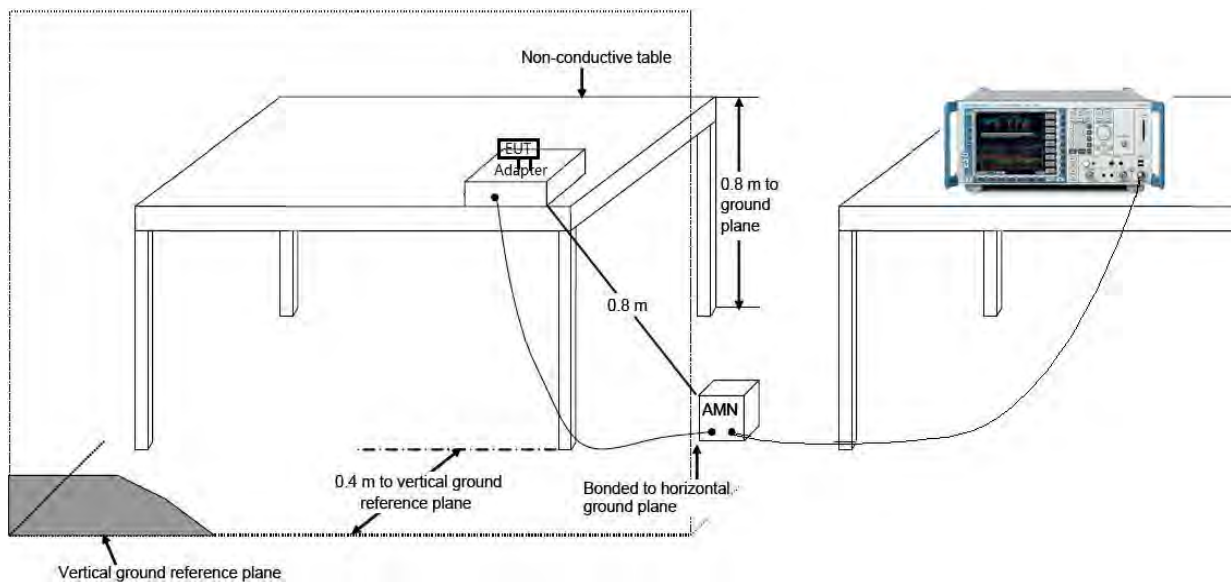

7.8.3. Test Result

EUT	WIFI CONTROL BOX	Test Date	2017/10/31
Factor	CE_ENV216-L1 (Filter ON)	Temp. / Humidity	24°C / 55%
Polarity	Line1	Site / Engineer	SR2 / Peter
Test Mode	MODE1	Test Voltage	AC120V/60Hz

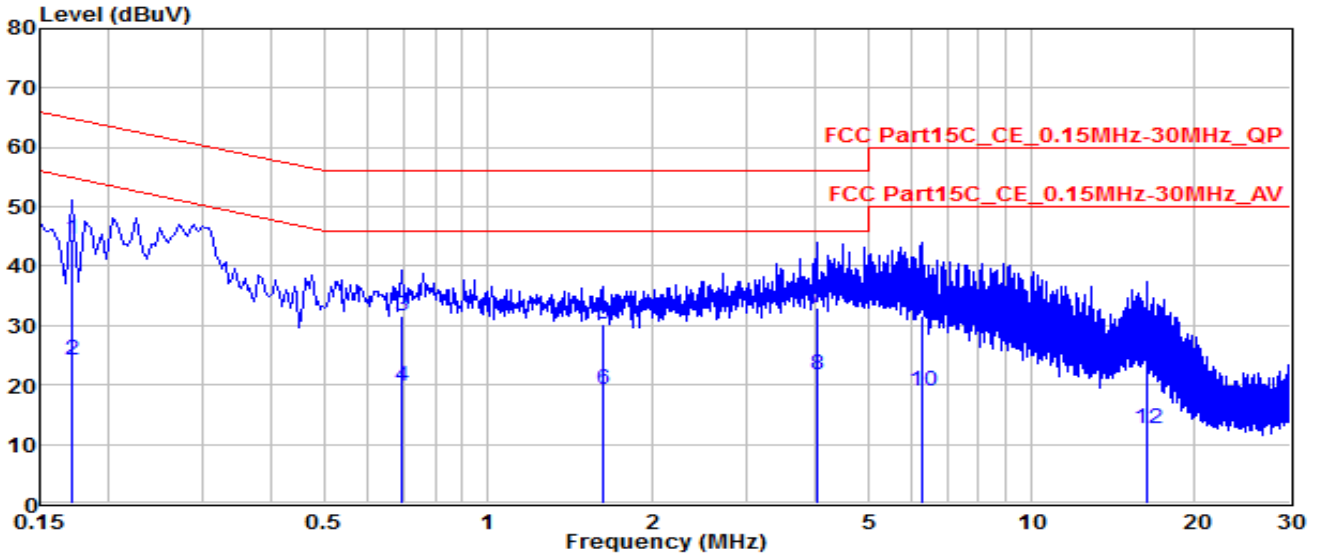

No		Frequency (MHz)	Reading (dBuV/m)	C.F (dB)	Measurement (dBuV/m)	Margin (dB)	Limit (dBuV/m)	Remark (QP/PK/AV)
1	*	0.1725	34.4	10.13	44.53	-20.31	64.84	QP
2		0.1725	14.08	10.13	24.21	-30.63	54.84	Average
3		0.69445	21.61	10.01	31.62	-24.38	56	QP
4		0.69445	9.87	10.01	19.88	-26.12	46	Average
5		1.63	20.39	9.87	30.26	-25.74	56	QP
6		1.63	9.42	9.87	19.29	-26.71	46	Average
7		4.024	23.07	9.79	32.86	-23.14	56	QP
8	*	4.024	11.8	9.79	21.59	-24.41	46	Average
9		6.278	21.82	9.77	31.59	-28.41	60	QP
10		6.278	9.32	9.77	19.09	-30.91	50	Average
11		16.321	14.81	9.97	24.78	-35.22	60	QP
12		16.321	2.63	9.97	12.6	-37.4	50	Average

Note :

1. "*" means the worst value in this measurement data .
2. C.F (Correction Factor) = Factor (dB)+ Cable Loss (dB) .
3. Measurement (dBuV/m) = Reading(dBuV/m)+ C.F (Correction Factor) .
4. Other mode was also verified. The test results shown represent the worst case emissions .

EUT	WIFI CONTROL BOX	Test Date	2017/10/31
Factor	CE_ENV216-N (Filter ON)	Temp. / Humidity	24°C / 55%
Polarity	Neutral	Site / Engineer	SR2 / Peter
Test Mode	MODE1	Test Voltage	AC120V/60Hz

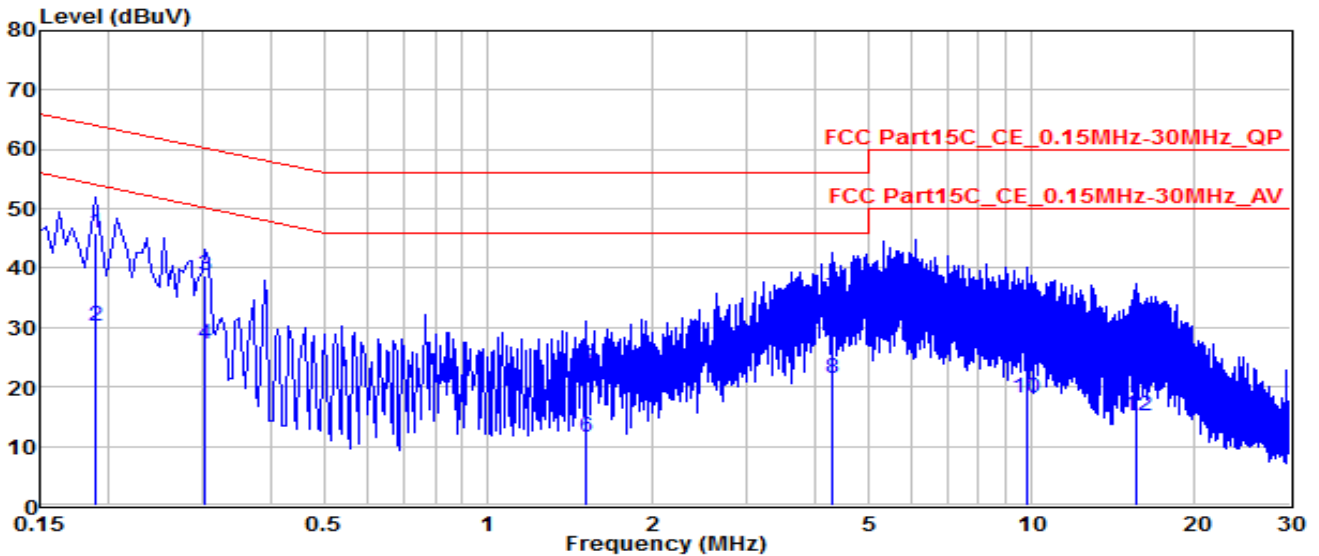

No	Frequency (MHz)	Reading (dBuV/m)	C.F (dB)	Measurement (dBuV/m)	Margin (dB)	Limit (dBuV/m)	Remark (QP/PK/AV)
1	0.1905	35.86	10.02	45.88	-18.13	64.01	QP
2	0.1905	20.34	10.02	30.36	-23.65	54.01	Average
3	* 0.30298	28.65	10	38.65	-21.51	60.16	QP
4	* 0.30298	17.35	10	27.35	-22.81	50.16	Average
5	1.513	13.25	9.87	23.12	-32.88	56	QP
6	1.513	1.62	9.87	11.49	-34.51	46	Average
7	4.303	25.16	9.79	34.95	-21.05	56	QP
8	4.303	11.75	9.79	21.54	-24.46	46	Average
9	9.788	21.65	9.86	31.51	-28.49	60	QP
10	9.788	8.21	9.86	18.07	-31.93	50	Average
11	15.574	18.44	10	28.44	-31.56	60	QP
12	15.574	5.23	10	15.23	-34.77	50	Average

Note :

- "*" means the worst value in this measurement data .
- C.F (Correction Factor) = Factor (dB)+ Cable Loss (dB) .
- Measurement (dBuV/m) = Reading(dBuV/m)+ C.F (Correction Factor) .
- Other channel was also verified. The test results shown represent the worst case emissions.

8. CONCLUSION

The data collected relate only the item(s) tested and show that the WiFi AP Router Module, FCC ID: TKZAWM003 is in compliance with Part 15C of the FCC Rules.

————— The End —————