



Test Report for FCC

FCC ID : TKWXS2-QAPB2

| | | | | |
|--|---|---|-------------------|-------------|
| Report Number | | ESTRFC2210-004 | | |
| Applicant | Company name | Suprema Inc | | |
| | Address | 17F-5, Parkview officetower, 248, Jeongjail-ro Bundang-gu, Seongnam-si, Gyeonggi-do South Korea | | |
| | Telephone | +82-31-710-4922 | | |
| Product | Product name | X-Station 2 | | |
| | Model No. | XS2-QAPB | Manufacturer | Suprema Inc |
| | Serial No. | NONE | Country of origin | KOREA |
| Test date | 15-Sep-22 ~ 18-Sep-22 | | Date of issue | 27-Oct-22 |
| Testing location | 140-16, Eongmalli-ro, Majang-myeon, Icheon-si, Gyeonggi-do, Rep. of Korea | | | |
| Standard | FCC PART 15 Subpart C(15.225), ANSI C 63.10(2013) | | | |
| Result | | Complied | | |
| Measurement facility registration number | | 659627 | | |
| MRA Registration number | | KR0019 | | |
| Tested by | Engineer H.G. Lee | | (Signature) | |
| Reviewed by | Engineering Manager I.k. Hong | | (Signature) | |
| Abbreviation | OK, Pass = Complied, Fail = Failed, N/A = not applicable | | | |
| <p>* Note</p> <ul style="list-style-type: none"> - This test report is not permitted to copy partly without our permission - This test result is dependent on only equipment to be used - This test report is not related to KOLAS accreditation - Add specific supported RFID card licensing circuit parts : XS2-APB, XS2-OAPB - Add QR module, add decoder : XS2-QDPB - Add fingerprint : XS2-OAPB, XS2-ODPB | | | | |



Contents

| | |
|--|----|
| 1. Laboratory Information | 3 |
| 2. Description of EUT | 4 |
| 3. Test Standards | 6 |
| 4. Measurement condition | 7 |
| 5.20 dB Bandwidth | 9 |
| 5.1 Procedure | 9 |
| 5.2 Test instruments and measurement setup | 9 |
| 5.3 Test data..... | 9 |
| 6. Frequency Tolerance | 10 |
| 6.1 Procedure | 10 |
| 6.2 Equipments lists | 10 |
| 6.3 Frequency stability Data | 11 |
| 7. Measurement of radiated disturbance | 12 |
| 7.1 Radiated emission limits, general requirements | 12 |
| 7.2 Measurement equipment | 12 |
| 7.3 Environmental conditions | 12 |
| 7.4 Test data(9 kHz ~30 MHz) | 13 |
| 7.5 Test data(30 MHz ~ 1 GHz) | 14 |
| 7.6 Test data(Above 1 GHz) | 15 |
| 8. Measurement of conducted disturbance | 16 |
| 8.1 Measurement equipment | 16 |
| 8.2 Environmental conditions | 16 |
| 8.3 Test data | 17 |
| Appendix 1. Special diagram | |
| Appendix 2. Special diagram | |
| Appendix 3. Special diagram | |
| Appendix 4. Antenna Requirement | |



1. Laboratory Information

1.1 General

This EUT (Equipment Under Test) has been shown to be capable of compliance with the applicable technical standards and is tested in accordance with the measurement procedures as indicated in this report. ESTECH Lab attests to accuracy of test data. All measurement reported herein were performed by ESTECH Co., Ltd.

ESTECH Lab assume full responsibility for the completeness of these measurements and vouch for the qualifications of all persons taking them.

1.2 Test Lab.

Corporation Name : ESTECH Co., Ltd.

Head Office : Suite 1015 World Meridian II, 123 Gasan Digital 2-ro, Geumcheon-gu,
Seoul 153-759, R. O. Korea

EMC/Telecom/Safety Test Lab : 140-16, Eongmalli-ro, Majang-myeon, Icheon-si, Gyeonggi-do,
Rep. of Korea

1.3 Official Qualification(s)

MSIP : Granted Accreditation from Ministry of Information & Communication for EMC, Safety and Telecommunication

KOLAS : Accredited Lab By Korea Laboratory Accreditation Schema base on CENELEC requirements

FCC : Conformity Assessment Body(CAB) with registration number 659627 under APEC TEL MRA between the RRA and the FCC

VCCI : Granted Accreditation from Voluntary Control Council for Interference from ITE



2. Description of EUT

2.1 Summary of Equipment Under Test

| | |
|--|--|
| Product | : X-Station 2 |
| Model Number | : XS2-QAPB |
| Serial Number | : NONE |
| Manufacturer | : Suprema Inc |
| Country of origin | : KOREA |
| Operating Frequency | : 13.56 MHz |
| Antenna Type | : PCB Patten Antenna |
| Modulation Type | : ASK |
| Channel | : 1 ch |
| Power Rating | : INPUT: AC(100 – 240) V, (50–60)Hz, 1.2 A : OUTPUT: DC 12 V, 2.5 A |
| Receipt Date | : 1-Aug-22 |
| X-tal list(s) or Frequencies generated | : The highest operating frequency is 13.56 MHz |

2.2 General descriptions of EUT

| Category | Feature | Description |
|------------|-----------------------|---|
| Credential | RF Option | <ul style="list-style-type: none"> • XS2-DPB, XS2-QDPB: 125kHz EM & 13.56MHz MIFARE, MIFARE Plus, DESFire EV1/EV2, FeliCa • XS2-APB, XS2-QAPB: 125kHz EM, HID Prox & 13.56 MHz MIFARE, MIFARE Plus, DESFire EV1/EV2*, FeliCa, iCLASS SE/SR/Seos |
| | RF read range** | MIFARE, DESFire, iCLASS, HID Prox, EM: 50 mm / FeliCa: 30 mm |
| | Mobile | NFC, BLE |
| | Barcode and QR code | Supported (XS2-QDPB, XS2-QAPB) |
| General | CPU | 1.5 GHz Quad Core |
| | Memory | 16 GB Flash + 1 GB RAM |
| | Crypto chip | Supported |
| | LCD type | 4"IPS color LCD |
| | LCD resolution | 480 x 800 |
| | Sound | 24bit |
| | Operating temperature | -20°C to 50°C |
| | Storage Temperature | -40°C to 70°C |
| | Operating humidity | 0%–80%, non-condensing |
| | Storage humidity | 0%–90%, non-condensing |
| | Camera type | CMOS 2M pixels |
| | Camera resolution | 1600 x 1200 |

| Category | Feature | Description |
|------------|-----------------------------------|---|
| General | Dimension (W x H x D) | <ul style="list-style-type: none"> • XS2-DPB, XS2-APB: 82 mm x 159 mm x 27.2 mm • XS2-QDPB, XS2-QAPB: 82 mm x 203 mm x 35.2 mm |
| | Weight | Device <ul style="list-style-type: none"> • XS2-DPB, XS2-APB: 280 g • XS2-QDPB, XS2-QAPB: 343 g Bracket <ul style="list-style-type: none"> • XS2-DPB, XS2-APB: 67 g(Including washer and bolt) • XS2-QDPB, XS2-QAPB: 88g(Including washer and bolt) |
| | IP rating | IP65 |
| | Certificates | KC, CE FCC(Compliance: RoHS, REACH, WEEE) |
| Capacity | Max. User | 500,000 |
| | Max. Card | 500,000 |
| | Max. Text Log | 5,000,000 |
| | Max. Image Log | 50,000 |
| Interface | Ethernet | Supported (10/100 Mbps, auto MDI/MDI-X) |
| | RS-485 | 1ch Host or Slave (Selectable) |
| | Wiegand | 1 ch Input or Output (Selectable) |
| | TTL input | 2 ch Inputs |
| | Relay | 1 Relay |
| | USB | USB 2.0(Host) |
| | PoE | Supported(IEEE 802.3af compliant) |
| | Tamper | Supported |
| Electrical | Power | <ul style="list-style-type: none"> • Power: DC 12 V(Max. 0.8 A) or DC 24 V(Max. 0.45 A) • Adapter recommended specifications: DC 12 V($\pm 10\%$)with a minimum of 1,500 mA or DC 24 V($\pm 10\%$)with a minimum of 800 mA*** |
| | Switch input V_{IH} | Min.: 3 V, Max.: 5 V |
| | Switch input V_{IL} | Max.: 1 V |
| | Switch Pull-up resistance | 4.7 k Ω (The input pots are pulled up with 4.7 k Ω .) |
| | Wiegand output V_{OH} | More than 4.8 V |
| | Wiegand output V_{OL} | Less than 0.2 V |
| | Wiegand output Pull-up resistance | Internally pulled up with 1 k Ω |
| | Relay | Voltage: MAX 30 VDC Current: 1A, MAX 2A |

* DESFire EV2 cards are supported by having backward compatibility of DESFire EV1 cards. CSN and smart card functions are compatible with X-station 2.

** RF read range will vary depending on the installation environment.

*** Adapter is sold separately. Refer to the recommended specifications.

3. Test Standards

Test Standard : FCC PART 15 Subpart C(15.225)

This Standard sets out the regulations under which an intentional, unintentional, or incidental radiator may be operated without an individual license. It also contains the technical specifications, administrative requirements and other conditions relating to the marketing of Part 15 devices.

Test Method : ANSI C 63.10 (2013)

This standard sets forth uniform methods of measurement of radio-frequency (RF) signals and noise emitted from both unintentional and intentional emitters of RF energy in the frequency range 9 kHz to 40 GHz. Methods for the measurement of radiated and AC power-line conducted radio noise are covered and may be applied to any such equipment unless otherwise specified by individual equipment requirements. These methods cover measurement of certain devices that deliberately radiate energy, such as intentional emitters, but does not cover licensed transmitters. This standard is not intended for certification/approval of avionic equipment or for industrial, scientific, and medical (ISM) equipment. These methods apply to the measurement of individual units or systems comprised of multiple units.

Summary of Test Results

| Applied Standard : 47 CFR Part 15, Subpart C | | | | |
|--|--|--------|----------------------|------------------------|
| Standard | Test Type | Result | Remark | Limit |
| 15.203 | Antenna Requirement | Pass | Meet the requirement | |
| 15.207 | AC Power Conducted Emission | Pass | Meet the requirement | |
| 15.225(a) | Radiated Emission (13.553 ~13.567) MHz | Pass | Meet the requirement | 15,848 uV/m at 30 m |
| 15.225(b) | Radiated Emission (13.410 ~13.553 , 13.567 ~ 13.710) MHz | N/A | - | 334 uV/m at 30 m |
| 15.225(c) | Radiated Emission (13.110 ~13.410 , 13.710 ~ 14.010) MHz | N/A | - | 106 uV/m at 30 m |
| 15.225(d) | Apply section 15.209 (out side band of the 13.110 ~14.010) MHz | Pass | Meet the requirement | |
| 15.225(e) | Frequency stability | Pass | Meet the requirement | |
| 15.215(c) | 20dB Bandwidth | Pass | Meet the requirement | |

4. Measurement Condition

4.1 EUT Operation.

-The EUT was tested, under transmission / receiving

1. Normal communication with RF OUT Frequency(13.56 MHz).
2. Monitoring the operation status of frequency by using RF CARD.

4.2 Configuration and Peripherals

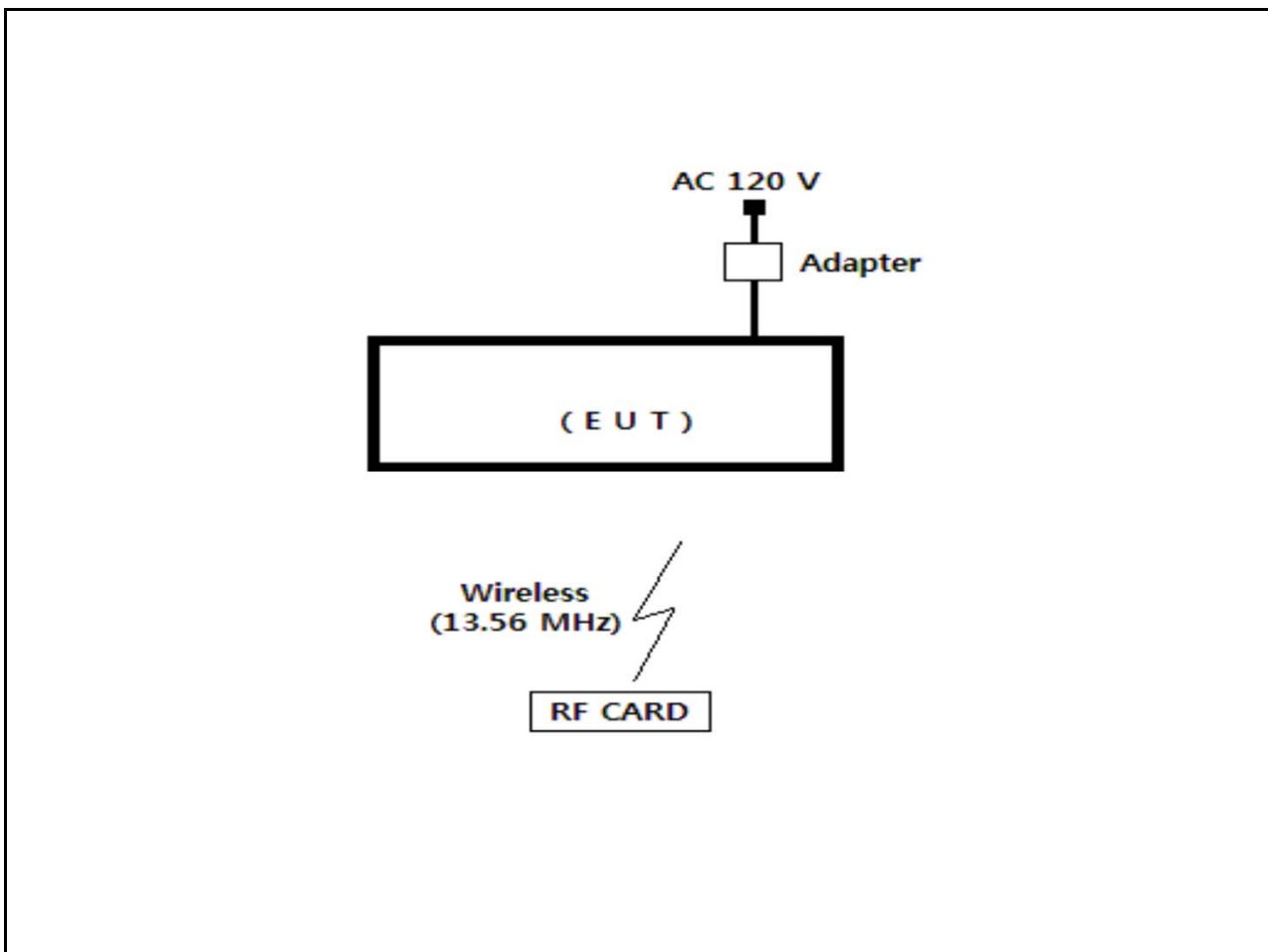



4.3 EUT and Support equipment

| Equipment Name | Model Name | S/N | Manufacturer | Remark (FCC ID) |
|----------------|----------------|------|--------------|-----------------|
| X-Station 2 | XS2-QAPB | NONE | KOREA | EUT |
| Adapter | DZ036DL120250F | NONE | KEERDA | |
| | | | | |
| | | | | |
| | | | | |
| | | | | |
| | | | | |
| | | | | |
| | | | | |

4.4 Cable Connecting

| Start Equipment | | End Equipment | | Cable Standard | | Remark |
|-----------------|----------------------|---------------|----------------------|----------------|------------|--------|
| Name | I/O port | Name | I/O port | Length | Shielded | |
| X-Station 2 | Power | Adapter | - | 2.0 | Unshielded | |
| X-Station 2 | Wireless (13.56 MHz) | RF CARD | Wireless (13.56 MHz) | - | - | |
| | | | | | | |
| | | | | | | |
| | | | | | | |
| | | | | | | |
| | | | | | | |
| | | | | | | |

5. 20 dB Bandwidth

5.1 Procedure

The transmitter output was connected to the spectrum analyzer. The bandwidth of the fundamental frequency was measured by spectrum analyzer. The 20 dB bandwidth is defined as the bandwidth at 20 dB below from peak power point.

5.2 20dB Bandwidth setup

The spectrum analyzer is set to as following

RBW: 30 Hz

VBW: 300 Hz

Span: 5 kHz

Sweep:suitable duration based on the EUT specification

20dB Bandwidth Test Instruments

| Decription | Model | Serial Number | Cal. Due Data |
|-----------------|-------|---------------|---------------|
| Signal Analyzer | FSV40 | 100939 | 28-Nov-22 |

5.3 Test Data

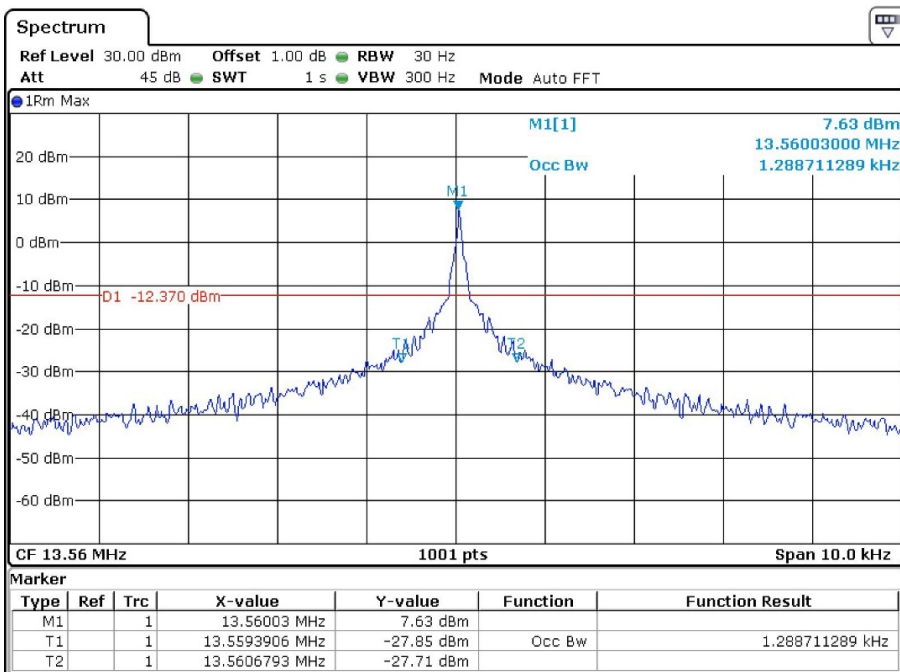

6. Frequency Tolerance

6.1 Procedure

The frequency stability of the transmitter is measured by:

- a) Temperature: The temperature is varied from $-20\text{ }^{\circ}\text{C}$ to $+50\text{ }^{\circ}\text{C}$ using an environmental chamber.
- b) Primary Supply Voltage: The primary supply voltage is varied from 85 % to 115 % of the voltage normally at the input to the device or at the power supply terminals if cables are not normally supplied.

The frequency tolerance of the carrier shall be maintained within $\pm 0.01\%$ of the operating frequency.

6.2 Equipment lists

The following test equipments are used during test

| Decription | Model | Serial Number | Cal. Due Data |
|------------------------|--------|---------------|---------------|
| Signal Analyzer | FSV40 | 100939 | 29-Nov-22 |
| Temp./Humidity Chamber | SH-642 | 93014501 | 29-Nov-22 |



6.3 Frequency stability Data (Adapter)

Operting Frequency : 13,560,000 Hz
 Reference Voltage : 12.00 Vd.c.
 Deviatin Limit : ± 0.01 %

| Voltage (%) | Power (Vdc) | Temperature (°C) | Frequency (Hz) | Deviation (%) |
|-------------|-------------|------------------|----------------|---------------|
| 100 | 12.00 | +20 °C(Ref) | 13,560,018 | 0.000133 |
| 100 | | -20 | 13,560,026 | 0.000192 |
| 100 | | -10 | 13,560,044 | 0.000324 |
| 100 | | 0 | 13,560,130 | 0.000959 |
| 100 | | 10 | 13,559,956 | -0.000324 |
| 100 | | 20 | 13,559,869 | -0.000966 |
| 100 | | 30 | 13,559,819 | -0.001335 |
| 100 | | 40 | 13,559,966 | -0.000251 |
| 100 | | 50 | 13,559,783 | -0.001600 |
| 85 | | 10.20 | 20 | 13,560,029 |
| 115 | 13.80 | 20 | 13,560,077 | 0.000568 |

7. Measurement of radiated disturbance

The EUT was placed on the top of a rotating table 0.8 m above the ground at a 10 m semi-anechoic chamber . The table was rotated 360° to determine the position of the highest radiation. Then antenna is a loop antenna is fixed at 1 m above the ground to determine the maximum value of the field strength. Both parallel and perpendicular of the antenna are set to make the measurement. For each suspected emission, the EUT was arranged to its worst case and then the table was turned from 0° to 360° to find the maximum reading. The test receiver system was set to Peak Detect Function and Specified Bandwidth with Maximum Hold Mode.

7.1 Radiated emission limits, general requirements

Except as provided elsewhere in this Subpart, the emissions from an intentional radiator shall not exceed the field strength levels specified in the following table:

| Frequency (MHz) | Distance(Meters) | Field strength @3m (dBuV/m) |
|-----------------|------------------|-----------------------------|
| 0.009 to 0.490 | 3 | 2400/F(kHz) |
| 0.490 to 1.705 | 3 | 24000/F(kHz) |
| 1.705 to 30 | 3 | 30 |
| 30 to 88 | 3 | 100** |
| 88 to 216 | 3 | 150** |
| 216 to 960 | 3 | 200** |
| > 960 | 3 | 500 |

* dBuV/m=20*log(uV/m) * Distance factor=40dB / decade(15.31(f))

7.2 Measurement equipments

| Equipment Name | Type | Manufacturer | Serial No. | Next Calibration date |
|--|-----------|-------------------|-------------|-----------------------|
| TEST Receiver | ESCI7 | ROHDE & SCHWARZ | 100916 | 29-Jun-23 |
| Logbicon Antenna | VULB 9168 | SCHWARZBECK | 193 | 9-Dec-23 |
| Turn Table | DT3000-2t | Innco System GmbH | N/A | - |
| Antenna Mast | MA4000-EP | Innco System GmbH | N/A | - |
| Antenna Master & Turn table controller | CO 3000 | Innco System GmbH | CO3000/1138 | - |
| Loop Antenna | HFH2-Z2 | ROHDE & SCHWARZ | 100188 | 29-Aug-24 |

7.3 Environmental Condition

Test Place : 10 m Semi-anechoic chamber

Below 1 GHz

Temperature (°C) : 23.2 °C

Humidity (% R.H.) : 45.4 % R.H.

Test Place : 3 m Semi-anechoic chamber(3 m)

Above 1 GHz-N/A

Temperature (°C) :

Humidity (% R.H.) :

7.4 Test data(9 kHz ~ 30 MHz)

Test Date : 16-Sep-22

Measurement Distance : 3 m

| Frequency (MHz) | Reading (dB μ V) | Vertical Position [Angle] | EUT Position | Height (m) | Correction Factor | | Result Value(Quasi-Peak) | | |
|--------------------------|--|---------------------------|--------------|------------|-------------------|------------|--------------------------|-----------------------|-------------|
| | | | | | Ant Factor (dB) | Cable (dB) | Limit (dB μ V/m) | Result (dB μ V/m) | Margin (dB) |
| Below 13.110 MHz | | | | | | | | | |
| Noise Floor | - | - | - | - | 19.48 | 0.5 | 69.5 | - | - |
| 13.110 MHz to 13.410 MHz | | | | | | | | | |
| Noise Floor | - | - | - | - | 19.46 | 0.5 | 80.5 | - | - |
| 13.410 MHz to 13.552 MHz | | | | | | | | | |
| Noise Floor | - | - | - | - | 19.46 | 0.5 | 90.5 | - | - |
| 13.553 MHz to 13.567 MHz | | | | | | | | | |
| 13.5600 | 52.00 | 0.0 | X | 0.8 | 19.55 | 0.5 | 124.0 | 72.08 | 51.92 |
| 13.567 MHz to 13.710 MHz | | | | | | | | | |
| Noise Floor | - | - | - | - | 19.45 | 0.5 | 90.5 | - | - |
| 13.710 MHz to 14.010 MHz | | | | | | | | | |
| Noise Floor | - | - | - | - | 19.44 | 0.6 | 80.5 | - | - |
| 14.010 MHz to 30 MHz | | | | | | | | | |
| Noise Floor | - | - | - | - | 19.44 | 0.6 | 69.5 | - | - |
| | | | | | | | | | |
| | | | | | | | | | |
| Remark | <p>*The 30 m limit was converted to 3 m Limit using square factor(x) as it was found by measurements as follows: *3 m Limit(dBuV/m) = 20log(X)+40log(30/3)= 20log(15848)+40log(30/3) = 124 dBuV *3 m Limit(dBuV/m) = 20log(X)+40log(30/3)= 20log(30)+40log(30/3) = 69.5 dBuV</p> <p>* The EUT was measured for the worst case by rotating of antenna angle. * The EUT performed at X,Y,Z and recorded the worst data in the report.</p> | | | | | | | | |

7.5 Test data(30 MHz ~ 1 000 MHz)

Test Date : 16-Sep-22

Measurement Distance : 3 m

| Frequency (MHz) | Reading (dB μ V) | Position (V/H) | Height (m) | Correction Factor | | Result Value(Quasi-peak) | | |
|-----------------|--|----------------|------------|-------------------|------------|--------------------------|-----------------------|-------------|
| | | | | Ant Factor (dB) | Cable (dB) | Limit (dB μ V/m) | Result (dB μ V/m) | Margin (dB) |
| 32.70 | 25.90 | V | 1.4 | 12.16 | 0.79 | 40.00 | 38.85 | 1.15 |
| 41.50 | 19.01 | V | 1.3 | 12.98 | 0.90 | 40.00 | 32.89 | 7.11 |
| 95.20 | 29.39 | V | 1.2 | 7.83 | 1.35 | 43.50 | 38.57 | 4.93 |
| 119.20 | 20.61 | V | 1.3 | 10.32 | 1.50 | 43.50 | 32.43 | 11.07 |
| 250.00 | 23.00 | V | 1.3 | 11.70 | 2.28 | 46.00 | 36.98 | 9.02 |
| 912.90 | 5.43 | H | 1.3 | 23.82 | 4.64 | 46.00 | 33.89 | 12.11 |
| | | | | | | | | |
| | | | | | | | | |
| | | | | | | | | |
| | | | | | | | | |
| | | | | | | | | |
| | | | | | | | | |
| | | | | | | | | |
| | | | | | | | | |
| | | | | | | | | |
| | | | | | | | | |
| | | | | | | | | |
| Remark | <p>H : Horizontal, V : Vertical *Result Value = Reading + Antenna + Cable loss *Correction Factor = Ant Factor + Cable *The resolution bandwidth and video bandwidth of test receiver/spectrum analyzer is 120 kHz for Quasi-peak detection</p> | | | | | | | |



7.6 Test data (Above 1 GHz) – N / A

Test Date :

Measurement Distance : 3 m

| Frequency (MHz) | Reading (dB μ V) | Position (V/H) | Height (m) | Correction Factor | | Result Value | | |
|------------------------------|---|----------------|------------|-------------------|------------|----------------------|-----------------------|-------------|
| | | | | Ant Factor (dB) | Cable (dB) | Limit (dB μ V/m) | Result (dB μ V/m) | Margin (dB) |
| Peak(RBW:1 MHz VBW:1 MHz) | | | | | | | | |
| | | | | | | | | |
| | | | | | | | | |
| | | | | | | | | |
| | | | | | | | | |
| | | | | | | | | |
| | | | | | | | | |
| | | | | | | | | |
| | | | | | | | | |
| | | | | | | | | |
| | | | | | | | | |
| | | | | | | | | |
| | | | | | | | | |
| | | | | | | | | |
| | | | | | | | | |
| | | | | | | | | |
| Average(RBW:1 MHz VBW:10 Hz) | | | | | | | | |
| | | | | | | | | |
| | | | | | | | | |
| | | | | | | | | |
| | | | | | | | | |
| | | | | | | | | |
| | | | | | | | | |
| | | | | | | | | |
| | | | | | | | | |
| | | | | | | | | |
| | | | | | | | | |
| | | | | | | | | |
| | | | | | | | | |
| | | | | | | | | |
| | | | | | | | | |
| Remark | <p>H : Horizontal, V : Vertical *Reading = receiver reading + Amplifier Gain *CL = Cable Loss–Amplifier Gain *The resolution bandwidth and video bandwidth of spectrum analyzer is 1 MHz and 10 Hz for average detection at frequency above 1 GHz. *This test does not require because the highest operating frequency of the EUT is less than 108 MHz. *Application method of the highest frequency is in the following *Highest frequency of the EUT is less than 108 MHz, the measurement shall only be made up to 1 GHz. *Highest frequency of the EUT is between 108 MHz and 500 MHz, the measurement shall only be made up to 2 GHz. *Highest frequency of the EUT is between 500 MHz and 1 GHz, the measurement shall only be made up to 5 GHz. *Highest frequency of the EUT is above 1 GHz, the measurement shall be made up to 10 times the highest frequency or 40 GHz,</p> | | | | | | | |

8. Measurement of conducted disturbance

The continuous disturbance voltage of AC Mains in the frequency from 0.15 MHz to 30 MHz was measured in accordance to FCC Part 15 & ANSI C 63.10 (2013) The test setup was made according to FCC Part 15 & ANSI C 63.10 (2013) in a shielded Room. The EUT was placed on a non-conductive table at least 0.8 m above the ground plan. A grounded vertical reference plane was positioned in a distance of 0.4 m from the EUT. The distance from the EUT to other metal surfaces was at least 0.8 m. The EUT was only earthen by its power cord through the line impedance stabilizing network. The power cord has been bundled to a length of 1.0 m. The test receiver with Quasi Peak detector complies with CISPR 16.

8.1 Measurement equipments

| Equipment Name | Type | Manufacturer | Serial No. | Next Calibration date |
|----------------|---------|-----------------|------------|-----------------------|
| TEST Receiver | ESHS 30 | Rohde & Schwarz | 828765/002 | 29-Jun-23 |
| LISN | ESH2-Z5 | Rohde & Schwarz | 836679/025 | 29-Jun-23 |
| Pulse Limiter | ESH3-Z2 | Rohde & Schwarz | NONE | 29-Jun-23 |

8.2 Environmental Condition

Test Place : Shielded Room
 Temperature (°C) : 23.1 °C
 Humidity (% R.H.) : 44.1 % R.H.



8.3 Test data

Test Date : 17-Sep-22

| Frequency (MHz) | Correction Factor | | Line (H/N) | Quasi-peak Value | | | Average Value | | |
|-----------------|--|------------|------------|--------------------|----------------------|---------------------|--------------------|----------------------|-------------|
| | Lisn (dB) | Cable (dB) | | Limit (dB μ V) | Reading (dB μ V) | Result (dB μ V) | Limit (dB μ V) | Reading (dB μ V) | Result (dB) |
| 0.32 | 0.04 | 0.15 | N | 59.83 | 32.03 | 32.22 | 49.83 | 22.91 | 23.10 |
| 0.35 | 0.04 | 0.15 | N | 58.93 | 32.66 | 32.85 | 48.93 | 22.54 | 22.73 |
| 0.39 | 0.04 | 0.15 | N | 58.00 | 32.86 | 33.05 | 48.00 | 23.41 | 23.60 |
| 0.40 | 0.04 | 0.15 | H | 57.93 | 31.79 | 31.98 | 47.93 | 22.05 | 22.24 |
| 0.45 | 0.04 | 0.15 | N | 56.81 | 41.31 | 41.50 | 46.81 | 32.38 | 32.57 |
| 0.46 | 0.04 | 0.15 | H | 56.76 | 40.16 | 40.35 | 46.76 | 31.20 | 31.39 |
| | | | | | | | | | |
| | | | | | | | | | |
| | | | | | | | | | |
| | | | | | | | | | |
| | | | | | | | | | |
| | | | | | | | | | |
| | | | | | | | | | |
| | | | | | | | | | |
| | | | | | | | | | |
| | | | | | | | | | |
| | | | | | | | | | |
| | | | | | | | | | |
| | | | | | | | | | |
| Remark | H : Hot Line, N : Neutral Line *Correction Factor = Lisn + Cable *Result = Correction Factor + Reading | | | | | | | | |

Appendix 1. Special diagram

* Horizontal

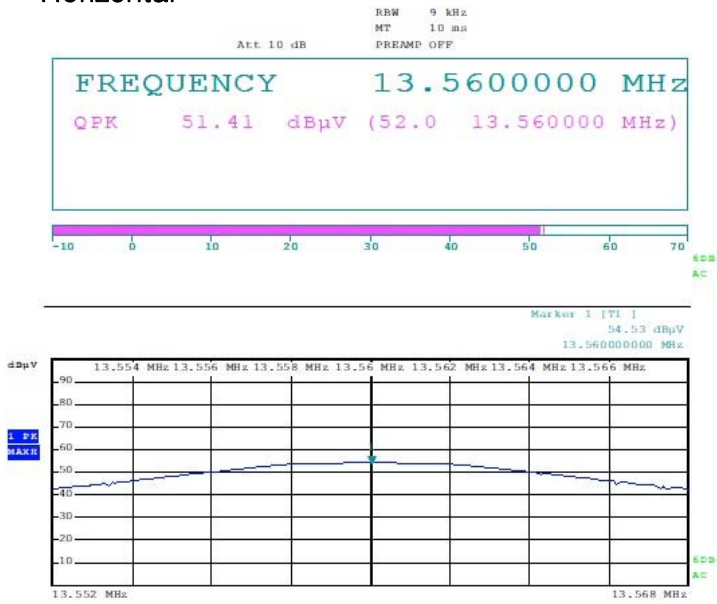

ESTR-22-00248

* Horizontal

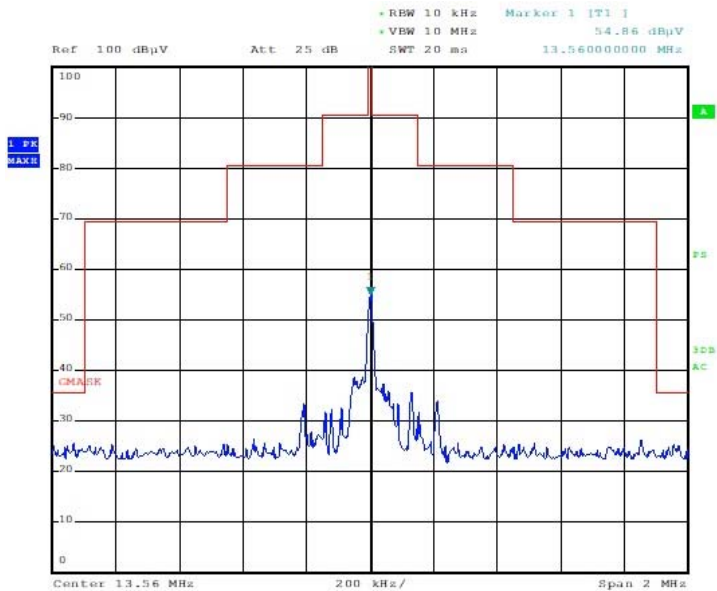

ESTR-22-00248

* Vertical

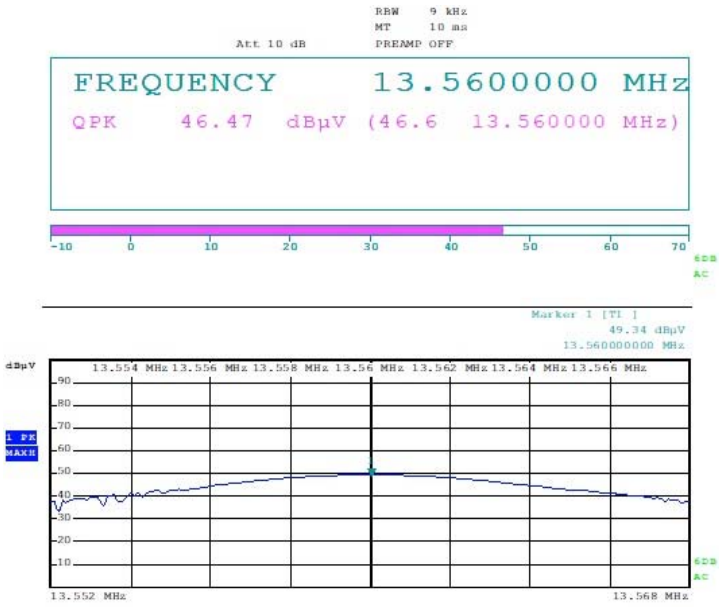

ESTR-22-00248

* Vertical

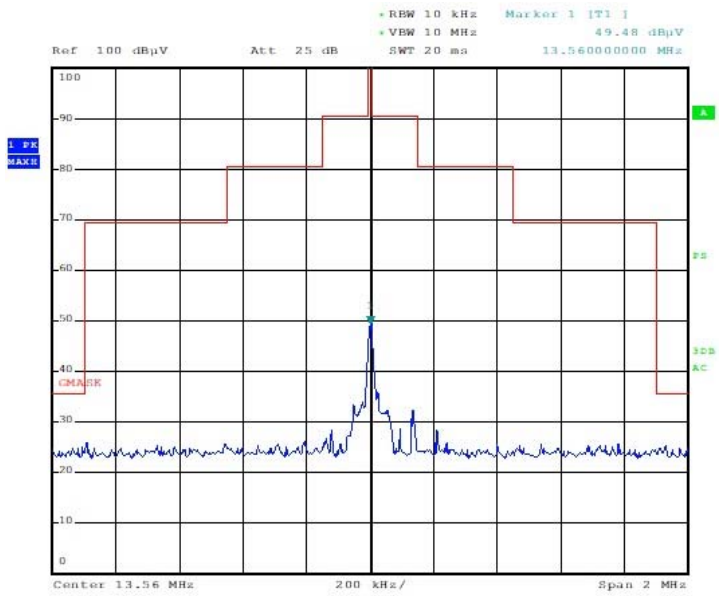

ESTR-22-00248

Appendix 2. Special diagram

* Horizontal

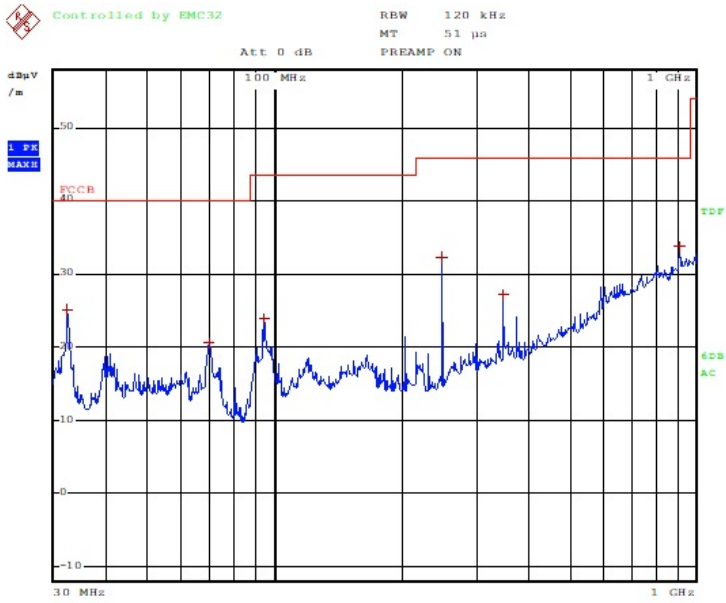

ESTR-22-00248

* Vertical

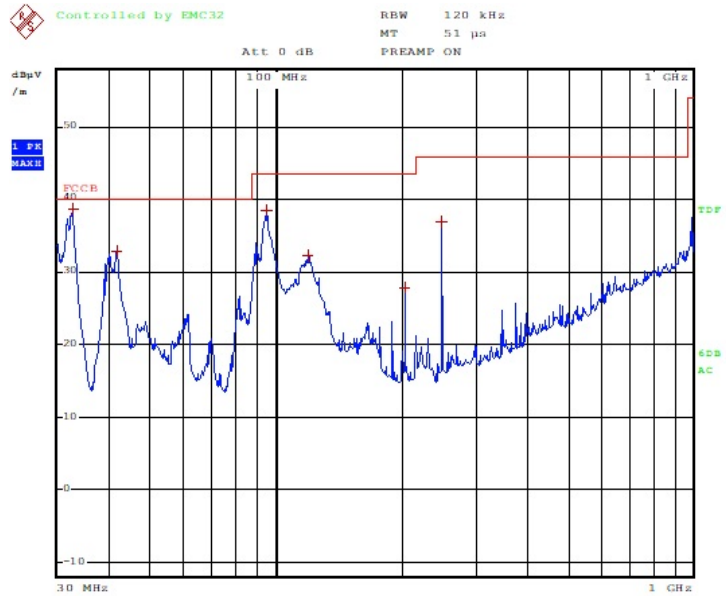

ESTR-22-00248

Appendix 3. Special diagram

* HOT LINE

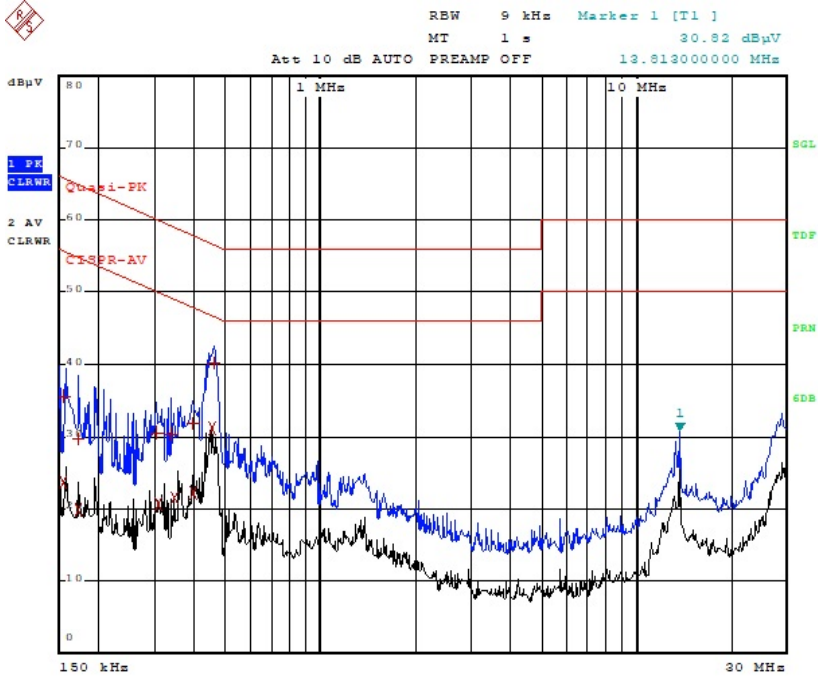

Comment: ESTR-22-00248

* NEUTRAL LINE

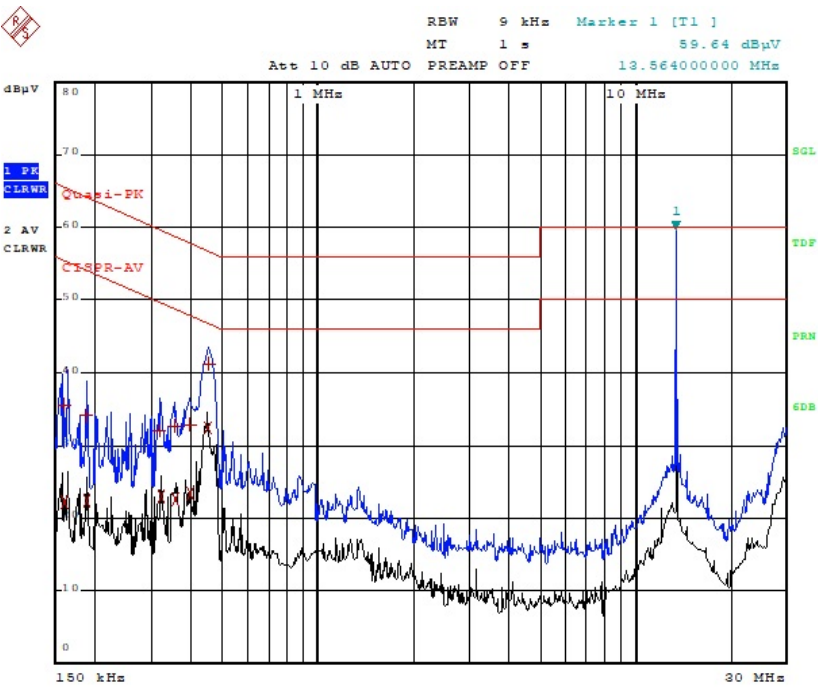

Comment: ESTR-22-00248

Appendix 4. Antenna Requirement

Regulation

According to §15.203, an intentional radiator shall be designed to ensure that no antenna other than that furnished by the responsible party shall be used with the device. The use of a permanently attached antenna or of an antenna that uses a unique coupling to the intentional radiator shall be considered sufficient to comply with the provisions of this Section. The manufacturer may design the unit so that a broken antenna can be replaced by the user, but the use of a standard antenna jack or electrical connector is prohibited.

Result

–Complied

The transmitter has an PCB Antenna.