

Test Report for FCC &ISED

FCC ID : TKWXS2-QAPB2
IC : 23080-XS2QAPB

Report Number		ESTRIC2210-010		
Applicant	Company name	Suprema Inc		
	Address	17F-5, Parkview officetower, 248, Jeongjail-ro Bundang-gu, Seongnam-si, Gyeonggi-do South Korea		
	Telephone	+82-31-710-4922		
	Contact person	Jae-Won Lee, Han-Chul Kim		
Product	Product name	X-Station 2		
	Factory address	17F-5, Parkview Office Tower, 248, Jeongjail-ro, Bundang-gu, Seongnam-si, Gyeonggi-do, South Korea		
	Model No.	XS2-QAPB	Manufacturer	Jae-Won Lee, Han-Chul Kim
	Serial No.	NONE	Country of origin	KOREA
Test date	19-Sep-22 ~ 26-Sep-22		Date of issue	26-Oct-22
Testing location	140-16, Eongmalli-ro, Majang-myeon, Icheon-si, Gyeonggi-do, Rep. of Korea			
Standard	FCC PART 15 Subpart C (15.247), ANSI C 63.10(2013), KDB 558074 D01v05r02, RSS-247(2017)			
Measurement facility registration number		FCC : 659627, ISED : 4475A		
MRA Registration number		KR0019		
Tested by	Senior Engineer H.G. Lee		(Signature)	
Reviewed by	Engineering Manager I.K Hong		(Signature)	
Abbreviation	OK, Pass = Passed, Fail = Failed, N/A = not applicable			
<p>* Note</p> <ul style="list-style-type: none"> - This test report is not permitted to copy partly without our permission - This test result is dependent on only equipment to be used - This test report is not related to KOLAS accreditation - Add specific supported RFID card licensing circuit parts : XS2-APB, XS2-OAPB - Add QR module, add decoder : XS2-QDPB - Add fingerprint : XS2-OAPB, XS2-ODPB 				

Contents

1. Laboratory Information	3
2. Description of EUT	4
3. Test Standards	6
4. Measurement condition	7
5. DTS bandwidth & 99 % Occupied Bandwidth	11
5.1 Test procedure	11
5.2 Test instruments and measurement setup	11
5.3 Measurement results	11
5.4 Trace data	12
6. Maximum Peak Output Power	14
6.1 Test procedure	14
6.2 Measurement results	14
7. Maximum conducted (average) output power	15
7.1 Test procedure	15
7.2 Measurement results	15
8. Maximum power spectral density level in the fundamental emission	16
8.1 Test procedure	16
8.2 Test instruments and measurement setup	16
8.3 Measurement results	16
8.4 Trace data	17
9. Emissions in non-restricted frequency bands	19
9.1 Test procedure	19
9.2 Test instruments and measurement setup	19
9.3 Measurement results of band-edge & out of emission	19
9.4 Trace data of band-edge & Out of Emission.....	20
10. Measurement of radiated disturbance	23
10.1 Measurement equipment	23
10.2 Environmental conditions	23
10.3 Measurement Instrument setting for Radiated Emission	24
10.4 Test Data.....	25
11. Measurement of conducted disturbance	37
11.1 Measurement equipment	37
11.2 Environmental conditions	37
11.3 Test Data.....	38

Appendix 1. Special diagram

Appendix 2. Antenna Information



1. Laboratory Information

1.1 General

This EUT (Equipment Under Test) has been shown to be capable of compliance with the applicable technical standards and is tested in accordance with the measurement procedures as indicated in this report.

ESTECH Lab attests to accuracy of test data. All measurement reported herein were performed by ESTECH Co., Ltd.

ESTECH Lab assume full responsibility for the completeness of these measurements and vouch for the qualifications of all persons taking them.

1.2 Test Lab.

Corporation Name : ESTECH Co., Ltd.

Head Office : Suite 1015 World Meridian II, 123 Gasan Digital 2-ro, Geumcheon-gu, Seoul 153-759, R. O. Korea

EMC/Telecom/Safety Test Lab : 140-16, Eongmalli-ro, Majang-myeon, Icheon-si,
Gyeonggi-do 467-811, R. O. Korea

1.3 Official Qualification(s)

MSIP : Granted Accreditation from Ministry of Information & Communication for EMC, Safety and Telecommunication

KOLAS : Accredited Lab By Korea Laboratory Accreditation Schema base on CENELEC requirements

FCC : Conformity Assessment Body(CAB) with registration number 659627 under APEC TEL MRA between the RRA and the FCC

VCCI : Granted Accreditation from Voluntary Control Council for Interference from ITE

ISED : Accredited Lab By Canada Laboratory Accreditation



2. Description of EUT

2.1 Summary of Equipment Under Test

Modulation Type	: Bluetooth (GFSK)
Transfer Rate	: 1 Mbps
Number of Channel	: 40 ch
PEAK Output Power	: GFSK : 2.82 mW
Rating	: INPUT: AC(100 – 240) V, (50–60)Hz, 1.2 A : OUTPUT: DC 12 V, 2.5 A
Receipt Date	: 1–Aug–22
X-tal list(s) or Frequencies generated	: The highest operating frequency is 2480 MHz(Bluetooth) : Bluetooth : 2.4 GHz

2.2 General descriptions of EUT

Category	Feature	Description
Credential	RF Option	<ul style="list-style-type: none"> • XS2-DPB, XS2-QDPB: 125kHz EM & 13.56MHz MIFARE, MIFARE Plus, DESFire EV1/EV2, FeliCa • XS2-APB, XS2-QAPB: 125kHz EM, HID Prox & 13.56 MHz MIFARE, MIFARE Plus, DESFire EV1/EV2*, FeliCa, iCLASS SE/SR/Seos
	RF read range**	MIFARE, DESFire, iCLASS, HID Prox, EM: 50 mm / FeliCa: 30 mm
	Mobile	NFC, BLE
	Barcode and QR code	Supported (XS2-QDPB, XS2-QAPB)
General	CPU	1.5 GHz Quad Core
	Memory	16 GB Flash + 1 GB RAM
	Crypto chip	Supported
	LCD type	4"IPS color LCD
	LCD resolution	480 x 800
	Sound	24bit
	Operating temperature	-20°C to 50°C
	Storage Temperature	-40°C to 70°C
	Operating humidity	0%–80%, non-condensing
	Storage humidity	0%–90%, non-condensing
	Camera type	CMOS 2M pixels
	Camera resolution	1600 x 1200



Category	Feature	Description
General	Dimension (W x H x D)	<ul style="list-style-type: none"> • XS2-DPB, XS2-APB: 82 mm x 159 mm x 27.2 mm • XS2-QDPB, XS2-QAPB: 82 mm x 203 mm x 35.2 mm
	Weight	Device <ul style="list-style-type: none"> • XS2-DPB, XS2-APB: 280 g • XS2-QDPB, XS2-QAPB: 343 g Bracket <ul style="list-style-type: none"> • XS2-DPB, XS2-APB: 67 g(Including washer and bolt) • XS2-QDPB, XS2-QAPB: 88g(Including washer and bolt)
	IP rating	IP65
	Certificates	KC, CE FCC(Compliance: RoHS, REACH, WEEE)
Capacity	Max. User	500,000
	Max. Card	500,000
	Max. Text Log	5,000,000
	Max. Image Log	50,000
Interface	Ethernet	Supported (10/100 Mbps, auto MDI/MDI-X)
	RS-485	1ch Host or Slave (Selectable)
	Wiegand	1 ch Input or Output (Selectable)
	TTL input	2 ch Inputs
	Relay	1 Relay
	USB	USB 2.0(Host)
	PoE	Supported(IEEE 802.3af compliant)
	Tamper	Supported
Electrical	Power	<ul style="list-style-type: none"> • Power: DC 12 V(Max. 0.8 A) or DC 24 V(Max. 0.45 A) • Adapter recommended specifications: DC 12 V($\pm 10\%$)with a minimum of 1,500 mA or DC 24 V($\pm 10\%$)with a minimum of 800 mA***
	Switch input V_{IH}	Min.: 3 V, Max.: 5 V
	Switch input V_{IL}	Max.: 1 V
	Switch Pull-up resistance	4.7 k Ω (The input pots are pulled up with 4.7 k Ω .)
	Wiegand output V_{OH}	More than 4.8 V
	Wiegand output V_{OL}	Less than 0.2 V
	Wiegand output Pull-up resistance	Internally pulled up with 1 k Ω
	Relay	Voltage: MAX 30 VDC Current: 1A, MAX 2A
Firmware Version ID Number		V1.0.0
Product Marketing Name		XS2-QAPB

3. Test Standards

Test Standard : FCC PART 15 Subpart C (15.247) & RSS-247

This Standard sets out the regulations under which an intentional, unintentional, or incidental radiator may be operated without an individual license. It also contains the technical specifications, administrative requirements and other conditions relating to the marketing of Part 15 devices.

Test Method : ANSI C 63.10 (2013) & KDB558074 D01v05r02

This standard sets forth uniform methods of measurement of radio-frequency (RF) signals and noise emitted from both unintentional and intentional emitters of RF energy in the frequency range 9 kHz to 40 GHz. Methods for the measurement of radiated and AC power-line conducted radio noise are covered and may be applied to any such equipment unless otherwise specified by individual equipment requirements. These methods cover measurement of certain devices that deliberately radiate energy, such as intentional emitters, but does not cover licensed transmitters. This standard is not intended for certification/approval of avionic equipment or for industrial, scientific, and medical (ISM) equipment. These methods apply to the measurement of individual units or systems comprised of multiple units.

Summary of Test Results

Applied Standard : 47 CFR Part 15 Subpart C & RSS 247				remark
Standard	Test Item	Result	Remark	Limit
15.207 & RSS-GEN	AC Power Conducted Emission	Pass	Meet the requirement	
15.205 & 15.209 & RSS-247	Restricted band / Intentional Radiated Emission	Pass	Meet the requirement	
15.247(a)(2) & RSS-247 & RSS-GEN	6 dB Bandwidth	Pass	Meet the requirement	Min. 500 kHz
	99 % Occupied Bandwidth			
15.247(b)(3) & RSS-247	Maximum Peak /Average output power	Pass	Meet the requirement	Max. 30 dBm
15.209 & RSS-247	Transmitter Radiated Emission	Pass	Meet the requirement	Table 15.209
15.247(e) & RSS-247	Power Spectral Density	Pass	Meet the requirement	Max. 8 dBm
15.247(d) & RSS-247	Band Edge Measurement	Pass	Meet the requirement	20 dB less

4. Measurement Condition

4.1 EUT Operation

a. Channel

Ch.	Frequency	Ch.	Frequency
0	2402 MHz	20	2442 MHz
1	2404 MHz	21	2444 MHz
2	2406 MHz	22	2446 MHz
3	2408 MHz	23	2448 MHz
4	2410 MHz	24	2450 MHz
5	2412 MHz	25	2452 MHz
6	2414 MHz
...	...	39	2480 MHz
19	2440 MHz		

b. Measurement Channel : Bluetooth : Low(2402 MHz), Middle(2440 MHz), High(2480 MHz)

c. Test Mode : Continuous Output, GFSK

d. Test rate : 1 Mbps

4.2 EUT Operation.

- The EUT was in the following operation mode during all testing
 - * Bluetooth operation check
 - * Transmit mode were measured each channels(Low, Middle, High)
 - * The EUT was measured up to tenth harmonic or 40 GHz of the highest operating frequencies.

4.3 Configuration and Peripherals

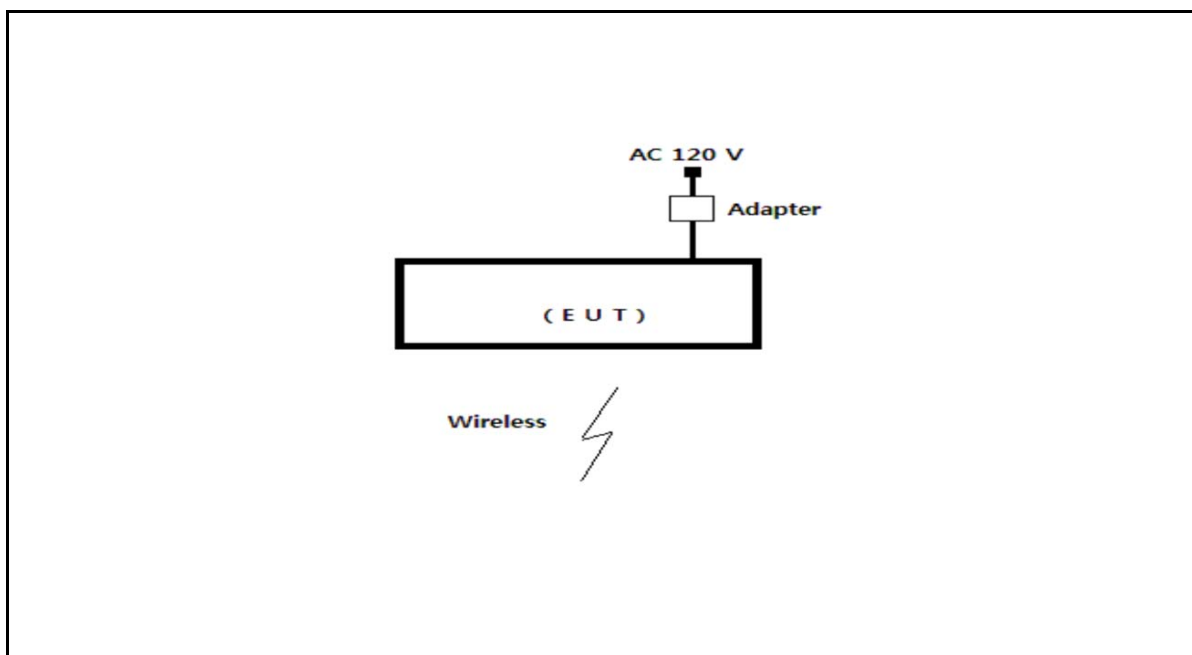

4.4 EUT and Support equipment

Equipment Name	Model Name	S/N	Manufacturer	Remark (FCC ID)
X-Station 2	XS2-QAPB	NONE	Jae-Won Lee, Han-Chul Kim	EUT
Adapter	DZ036DL120250F	NONE	KEERDA	

4.5 Cable Connecting

Start Equipment		End Equipment		Cable Standard		Remark
Name	I/O port	Name	I/O port	Length	Shielded	
X-Station 2	Power	Adapter	-	2.0	Unshielded	

4.6 DUTY CYCLE OF TEST SIGNAL

Duty cycle is < 98%, duty factor shall be considered.

duty cycle = $2.16/2.5=0.864$, duty factor = $10*\log(1/0.864)=0.635$

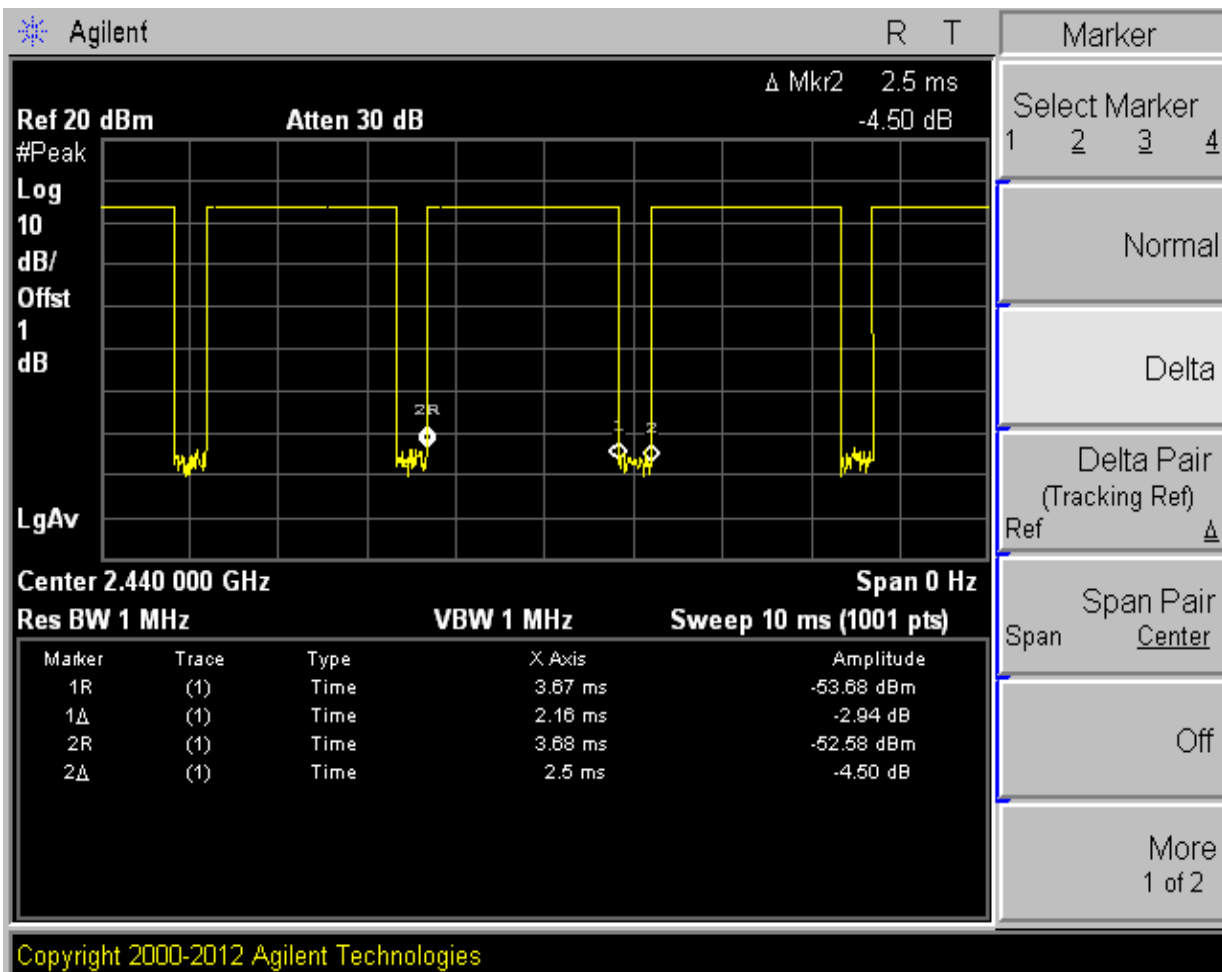



5. DTS bandwidth & 99 % Occupied Bandwidth

5.1 Test procedure

§ 15.247 (a)(2), RSS-247 §5.2, RSS-Gen §6.7

Systems using digital modulation techniques may operate in the 902–928MHz, 2400–2483.5MHz, and 5725–5850MHz bands. The minimum 6 dB bandwidth shall be at least 500 KHz.

5.2 Test instruments and measurement setup

The automatic bandwidth measurement capability of an instrument may be employed using the X dB bandwidth mode with X set to 6 dB, if the functionality described above (i.e., RBW = 100 kHz, VBW ≥ 3 X RBW, peak detector with maximum hold) is implemented by the instrumentation function. When using this capability, care shall be taken so that the bandwidth measurement is not influenced by any intermediate power nulls in the fundamental emission that might be ≥ 6 dB.

6dB Bandwidth Test Instruments

Description	Model	Serial Number	Cal. Due Date
Spectrum Analyzer	E4440A	US42041291	29-Nov-22
RF Cable	Length: 30 cm	–	
–Spectrum Analyzer <=> EUT	Loss: 1 dB	–	

5.3 Measurement results

EUT	X-Station 2	MODEL	XS2-QAPB
MODE	GFSK	ENVIRONMENTAL CONDITION	23.3 °C, 45.3 % R.H.
INPUT POWER	DC 12.0 V		

Channel Frequency (MHz)	99 % Occupied Bandwidth(MHz)	Bandwidth at 6dB below(MHz)	Minimum Limit (kHz)	PASS/FAIL
2402	1.05	0.71	0.5	PASS
2440	1.05	0.69	0.5	PASS
2480	1.05	0.68	0.5	PASS

5.4 Trace data (ch_0)

99% OBW

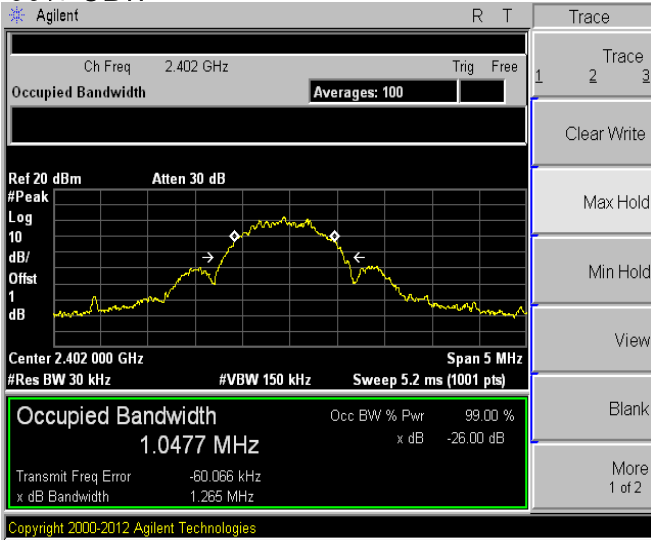

6dB below

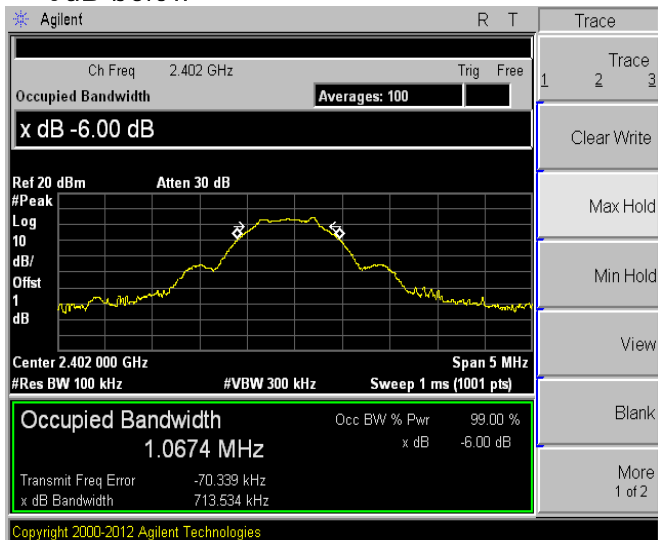

(ch_19)

99% OBW

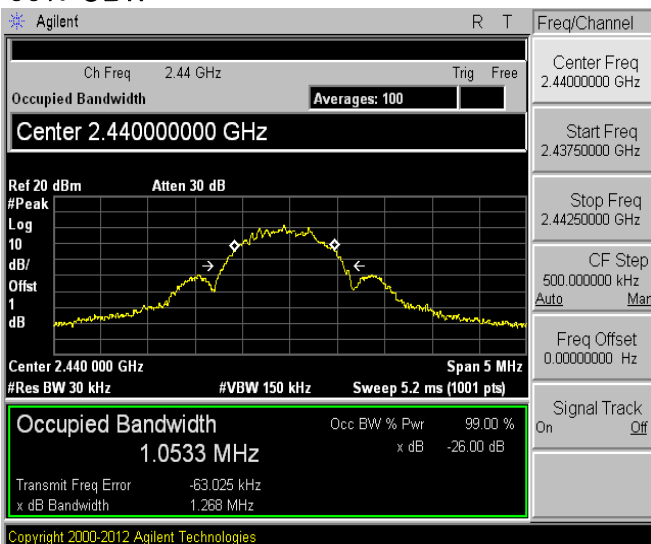

6dB below

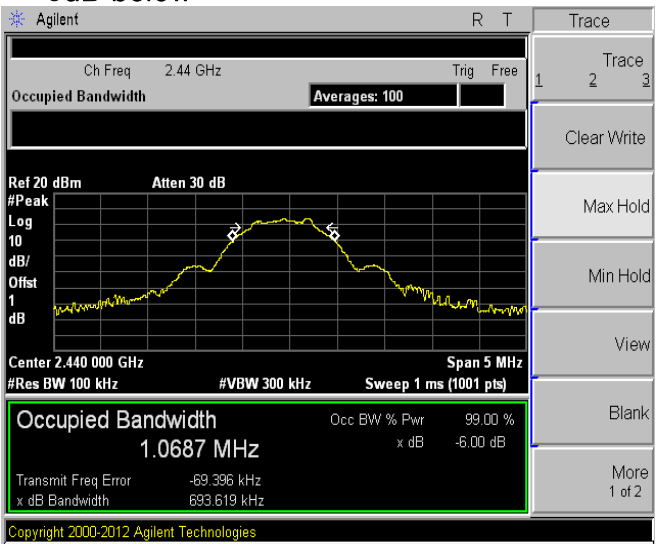



Estech
your best partner

(ch_39)

99% OBW

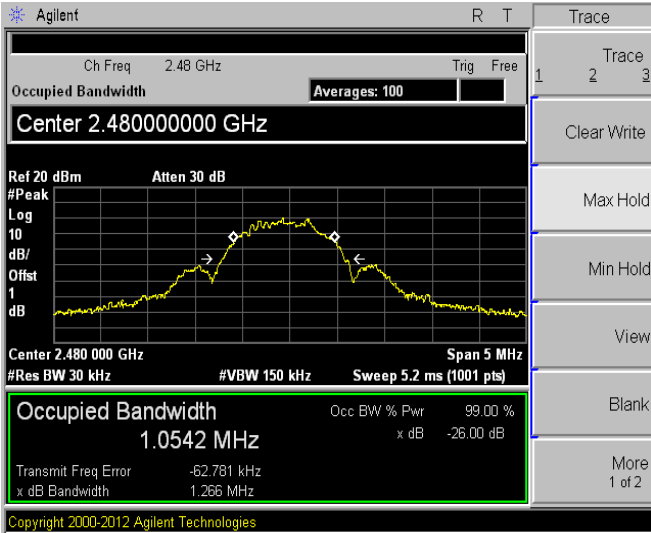

6dB below

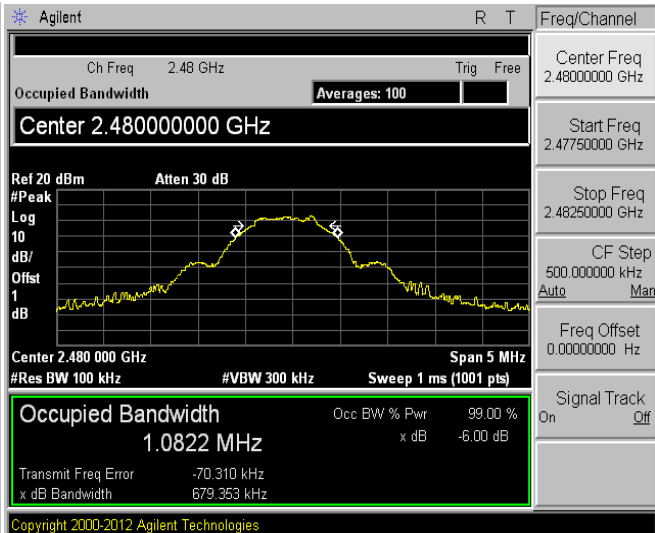

6. Maximum peak conducted output power

6.1 Test procedure

The transmitter antenna terminal is connected to the input of a Power Sensor. Measurement is made while EUT is operating in transmission mode at the appropriate center frequency. The maximum peak output power measurement is 30 dBm.

Limits : FCC § 15.247 RSS 247 section 5.4 d

Maximum Peak Output Power Test Instruments

Description	Model	Serial Number	Cal. Due Date
Power Meter	N1921A	MY45100570	29-Nov-22
Power Sensor	N1921A	MY45240427	29-Nov-22
Power Meter <=> EUT	Loss: 1 dB	-	

6.2 Measurement results

EUT	X-Station 2	MODEL	XS2-QAPB
MODE	GFSK	ENVIRONMENTAL CONDITION	23.4°C, 44.5 % R.H.
INPUT POWER	DC 12.0 V		

CHANNEL	Channel Requency (MHz)	Conducted Power Output(dBm)			Limit[1W] (dBm)	PASS/FAIL
		Detector	(dBm)	(mW)		
0	2 402	PEAK	4.51	2.82	30.0	PASS
19	2 440	PEAK	3.80	2.40	30.0	PASS
39	2 480	PEAK	2.97	1.98	30.0	PASS



7. Maximum conducted (average) output power

7.1 Test procedure

The transmitter antenna terminal is connected to the input of a Power Sensor. Measurement is made while EUT is operating in transmission mode at the appropriate center frequency. The maximum Average output power measurement is 30 dBm.

Limits : FCC § 15.247 & RSS 247 section 5.4 d

Maximum conducted (average) output power Test Instruments

Description	Model	Serial Number	Cal. Due Date
Power Meter	N1921A	MY45100570	29-Nov-22
Power Sensor	N1921A	MY45240427	29-Nov-22
Power Meter <=> EUT	Loss: 1 dB	-	

7.2 Measurement results

EUT	X-Station 2	MODEL	XS2-QAPB
MODE	GFSK	ENVIRONMENTAL CONDITION	23.4 °C, 45.3 % R.H.
INPUT POWER	DC 12.0 V		

CHANNEL	Channel Requency (MHz)	Conducted Power Output(dBm)			Measured + Duty Cycle(dBm)	Measured + Duty Cycle(W)
		Detector	(dBm)	Duty Cycle		
0	2 402	AVG	4.00	0.63	4.63	2.91
19	2 440	AVG	3.26	0.63	3.89	2.45
39	2 480	AVG	2.42	0.63	3.05	2.02

8. Maximum power spectral density level in the fundamental emission

8.1 Test procedure

KDB 558074 D01 DTS Meas Guidance V05r02 10.2 Method PKPSD (peak PSD) & RSS 247 section 5.2

8.2 Test instruments and measurement setup

This procedure shall be used if maximum peak conducted output power was used to demonstrate compliance, and is optional if the maximum conducted (average) output power was used to demonstrate compliance.

- a) Set analyzer center frequency to DTS channel center frequency.
- b) Set the span to 1.5 times the DTS bandwidth.
- c) Set the RBW to: $3 \text{ kHz} \leq \text{RBW} \leq 100 \text{ kHz}$.
- d) Set the VBW $\geq 3 \times \text{RBW}$
- e) Detector = peak.
- f) Sweep time = auto couple.
- g) Trace mode = max hold.
- h) Allow trace to fully stabilize.
- i) Use the peak marker function to determine the maximum amplitude level within the RBW.
- j) If measured value exceeds limit, reduce RBW (no less than 3 kHz) and repeat.

The peak power density Test Instruments

Description	Model	Serial Number	Cal. Due Date
Spectrum Analyzer	E440A	US42041291	29-Nov-22
RF Cable	Length: 30 cm	–	
–Spectrum Analyzer <=> EUT	Loss: 1 dB	–	

8.3 Measurement results

EUT	X-Station 2	MODEL	XS2-QAPB	
MODE	GFSK	ENVIRONMENTAL CONDITION	23.5 °C, 45.0 % R.H.	
INPUT POWER	DC 12.0 V			
CHANNEL	Channel Frequency (MHz)	Measured Power Spectral Density (dBm)	Maximum Permissible Power Density (dBm/3kHz)	Margin
0	2 402	-11.35	8.0	19.35
19	2 440	-12.81	8.0	20.81
39	2 480	-13.79	8.0	21.79

8.4 Trace data (ch_0)

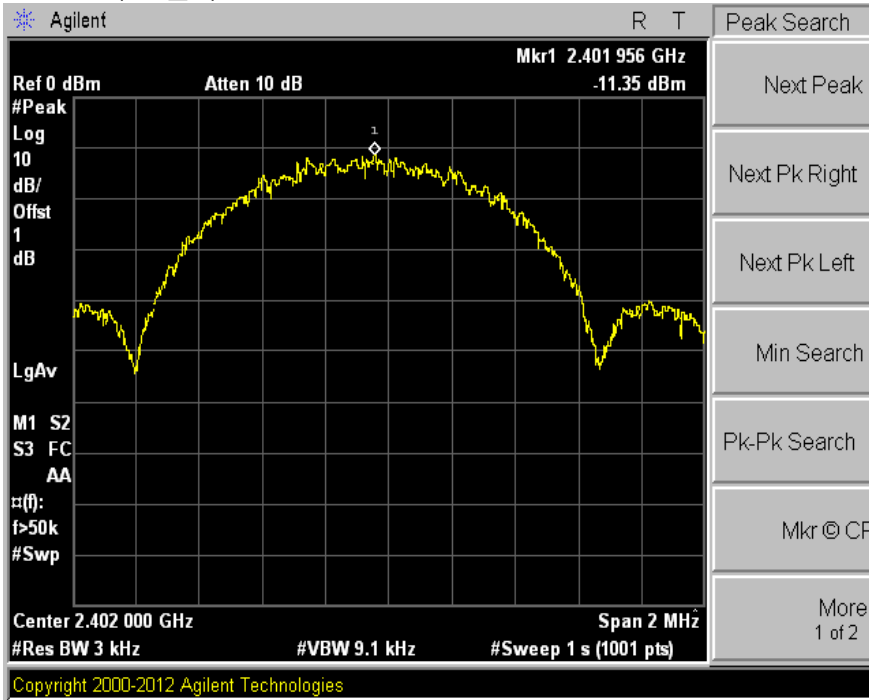

(ch_19)

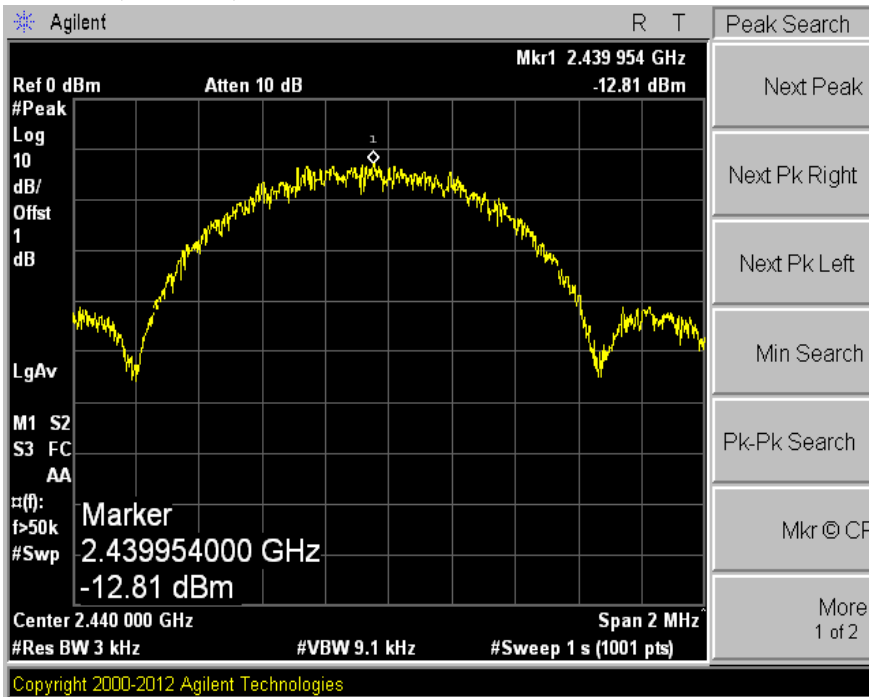



Estech
your best partner

(ch_39)

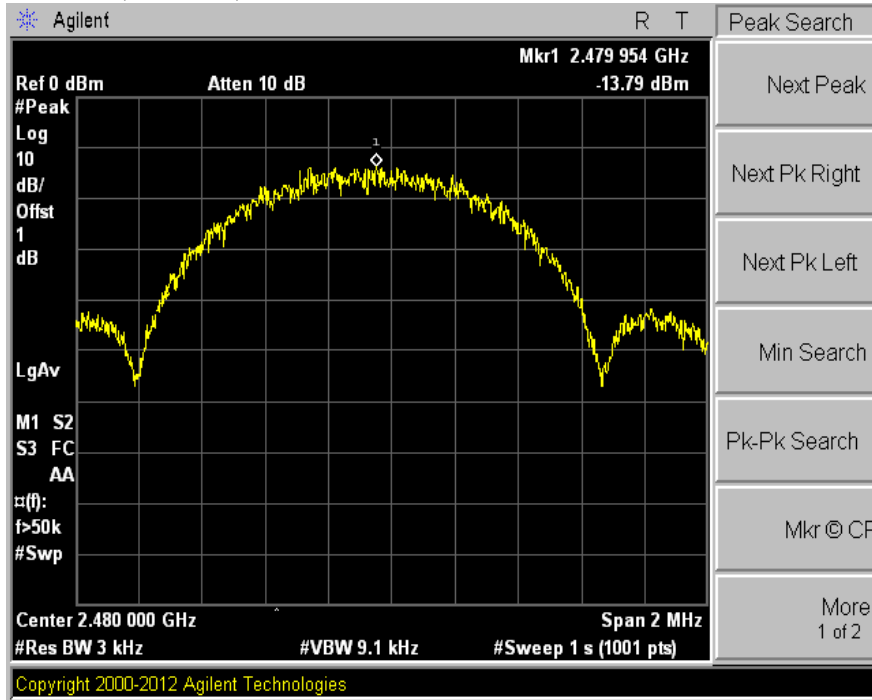



9. Emissions in non-restricted frequency bands

9.1 Test procedure

KDB 558074 D01 DTS Meas Guidance V05r02 & RSS-247 section 5.5

9.2 Test instruments and measurement setup

The DTS rules specify that in any 100 kHz bandwidth outside of the authorized frequency band, the power shall be attenuated according to the following conditions(15.247(d))

- a) Set the center frequency and span to encompass frequency range to be measured.
- b) Set the RBW = 100 kHz.
- c) Set the VBW $\geq 3 \times$ RBW.
- d) Detector = peak.
- e) Sweep time = auto couple.
- f) Trace mode = max hold.
- g) Allow trace to fully stabilize.
- h) Use the peak marker function to determine the maximum amplitude level.

Limits FCC § 15.247

Band Edge&Out of Emission Test Instruments

Description	Model	Serial Number	Cal. Due Date
Spectrum Analyzer	E4440A	US42041291	29-Nov-22
RF Cable	Length: 30 cm		-
-Spectrum Analyzer <=> EUT	Loss: 1 dB		-

9.3 Measurement results of band-edge & out of emission

EUT	X-Station 2	MODEL	XS2-QAPB
MODE	GFSK	ENVIRONMENTAL CONDITION	23.1 °C, 45.0 % R.H.
INPUT POWER	DC 12.0 V		

CHANNEL	Channel Frequency (MHz)	limit	PASS/FAIL
0	2 402	20dBc	PASS
39	2 480	20dBc	PASS

9.4 Trace data of band-edge & Out of Emission (ch_0)

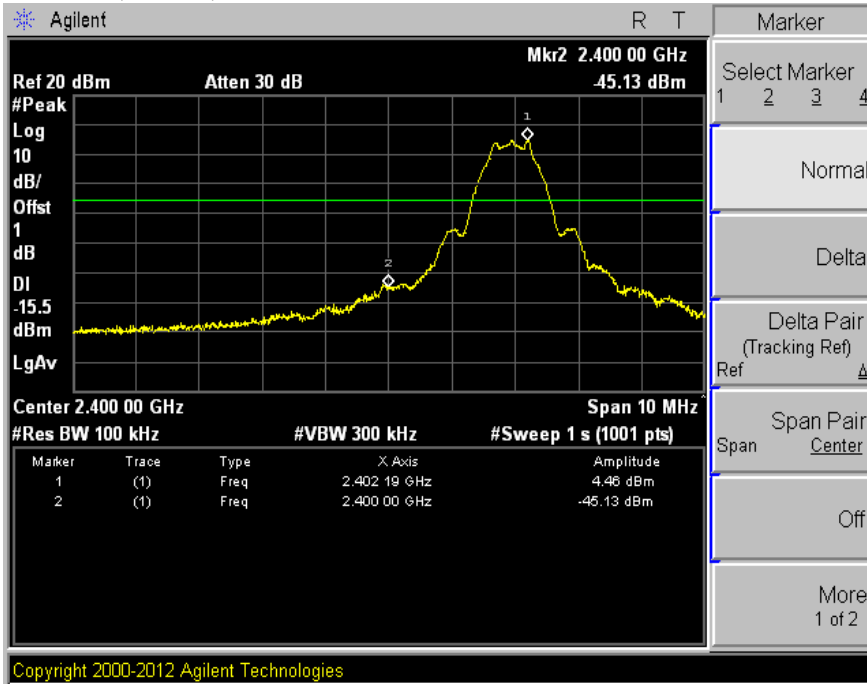

(ch_39)

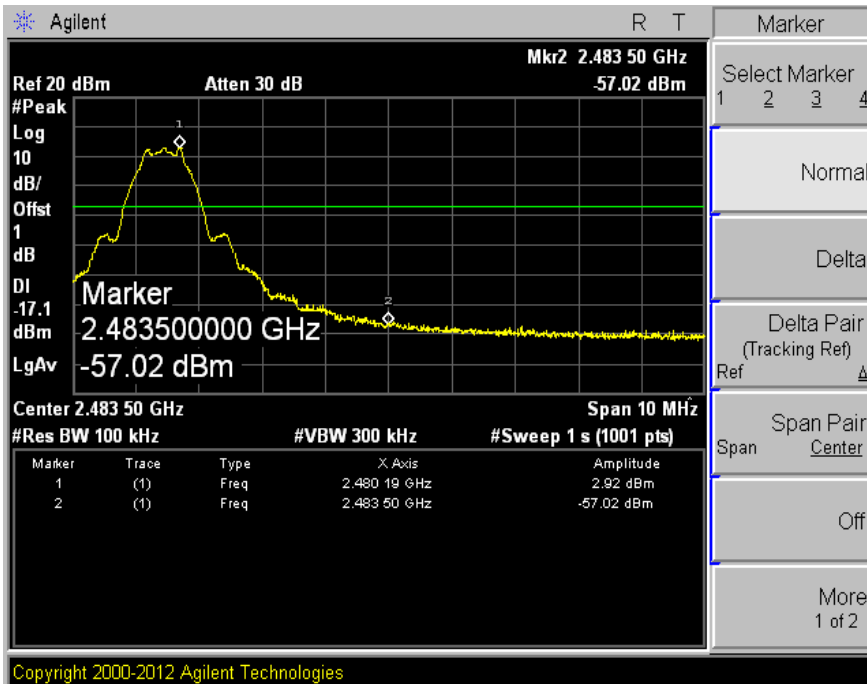



Estech
your best partner

(ch_0)

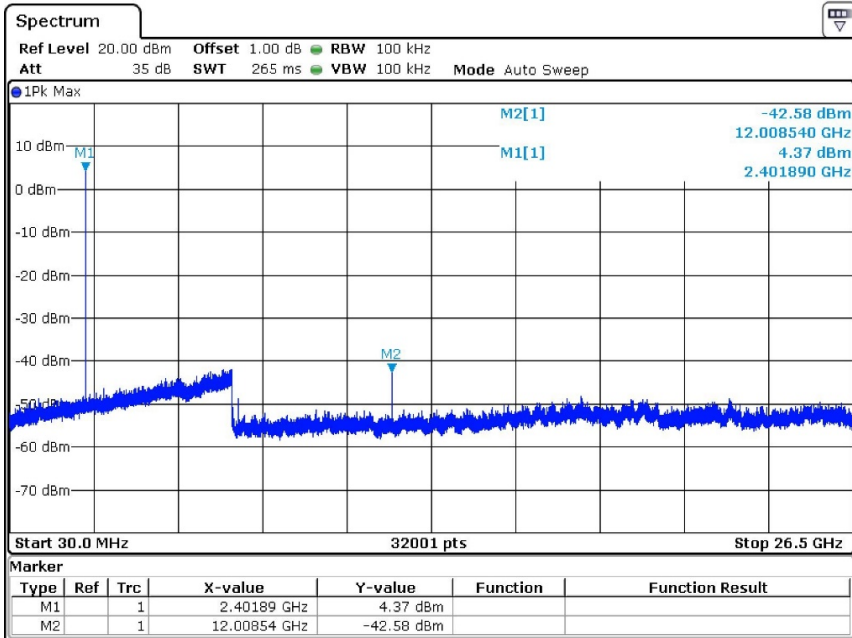

(ch_19)

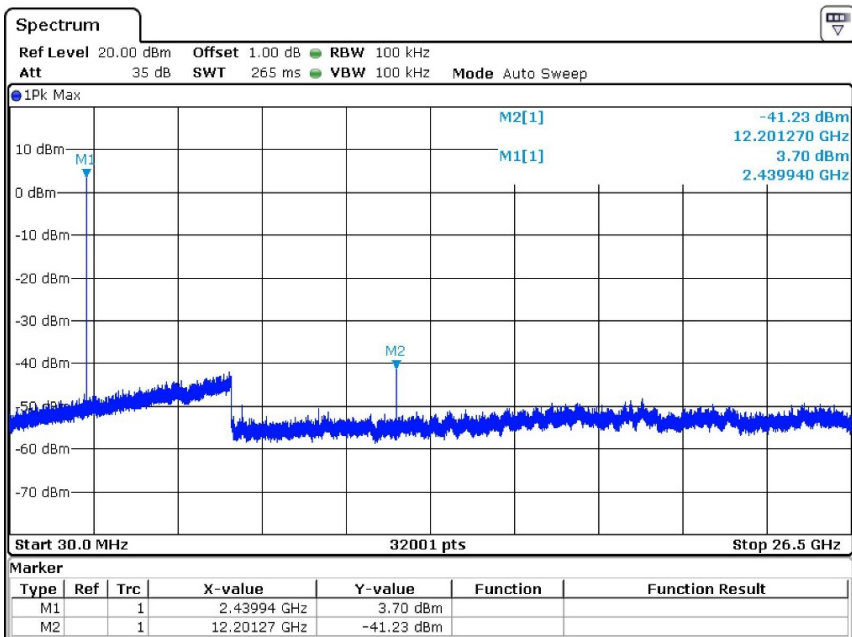



Estech
your best partner

(ch_39)

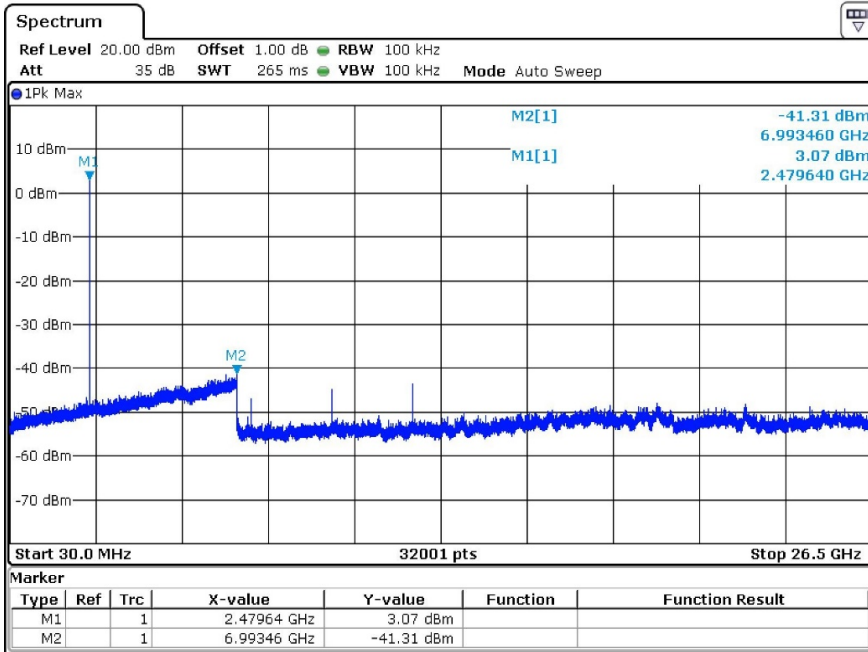

10. Measurement of radiated disturbance

Above 30 MHz Electric Field strength was measured in accordance with FCC PART 15.205, 15.209 . The test setup was made according to ANSI C 63.10 (2013) & KDB 558074 D01v05r02 Semi-anechoic chamber, which allows a 3 m distance measurement. The EUT was placed in the center of styrofoam. turntable. The height of this table was 0.8 m. The measurement was conducted with both horizontal and vertical antenna polarization. The turntable has fully rotated. For further description of the configuration refer to the picture of the test setup.

10.1 Measurement equipments

Equipment Name	Type	Manufacturer	Serial No.	Next Calibration date
TEST Receiver	ESCI7	ROHDE & SCHWARZ	100916	29-Jun-23
Logbicon Antenna	VULB 9168	SCHWARZBECK	193	9-Dec-23
Turn Table	DT3000-2t	Innco System GmbH	N/A	-
Antenna Mast	MA4000-EP	Innco System GmbH	N/A	-
PREAMPLIFIER	8449B	HP	3008A00581	29-Jun-23
Horn Antenna	BBHA9120D	SCHWARZBECK	469	3-Dec-22
TEST Receiver	ESU	ROHDE & SCHWARZ	100529	29-Jun-23
Turn Table	DT1500-S	Innco System GmbH	N/A	-
Antenna Mast	MA4000-EP	Innco System GmbH	N/A	-
Antenna Master & Turn table controller	C02000-P	Innco System GmbH	CO2000/642 /28051111/L	-

10.2 Environmental Condition

Below 1 GHz –Test Place : 10 m Semi-anechoic chamber

BT(BLE) MODE

Temperature (°C) : 22.9 °C

Humidity (% R.H.) : 45.1 % R.H.

Above 1 GHz–Test Place : 3 m Semi-anechoic chamber

BT(BLE) MODE

Temperature (°C) : 23.0 °C

Humidity (% R.H.) : 44.9 % R.H.

10.3 Measurement Instrument setting for Radiated Emission

10.3.1 Frequency range below 1 GHz

Detector : Quasi-Peak

10.3.2 Frequency range above 1 GHz

Peak Power Measurement Procedure (KDB 558074 section 12.2.4)

- a. RBW : 1 MHz , VBW : 3 MHz
- b. Trace mode = max hold
- c. Detector : Peak
- d. Sweep time = auto

Average Power Measurement Procedures (KDB 558074 section 12.2.5.2)

- a. Set analyzer center frequency to the frequency associated with the emission
- b. RBW : 1 MHz , VBW : 3 MHz
- c. Detector : RMS
- d. Sweep time = auto

Note

Band	Duty cycle(%)	Ton (ms)	Ton + Toff (ms)	DCF=10*log(1/Duty) (dB)
BT(BLE)	0.86	2.160	2.500	0.635

* This was applied of duty cycle factor for average value because of measured with the EUT transmitting continuously less than 98 % duty cycle at its maximum power control level.

10.4 Test data(30 MHz ~ 1 000 MHz)

Test Date : 22-Sep-22

Measurement Distance : 3 m

Frequency (MHz)	Reading (dB μ V)	Position (V/H)	Height (m)	Correction Factor		Result Value(Quasi-peak)		
				Ant Factor (dB)	Cable (dB)	Limit (dB μ V/m)	Result (dB μ V/m)	Margin (dB)
32.00	22.78	V	1.2	12.12	0.78	40.00	35.68	4.32
39.30	18.57	V	1.2	12.73	0.89	40.00	32.19	7.81
88.30	25.67	V	1.3	7.90	1.29	43.50	34.86	8.64
111.40	25.38	V	1.2	9.90	1.45	43.50	36.73	6.77
122.00	24.69	V	1.4	10.60	1.52	43.50	36.81	6.69
250.00	22.21	H	1.2	11.70	2.28	46.00	36.19	9.81
Remark	<p>H : Horizontal, V : Vertical TEST MODE : BT BLE (CH : 19 - 2 440 MHz)</p> <p>*Checked in all 3 axis and the maximum measured data were reported.(Worst data is X axis of position)</p> <p>*CL = Cable Loss(In case of below 1 000 MHz)</p> <p>*Result Value = Reading + Ant Factor + Cable loss</p> <p>*The resolution bandwidth and video bandwidth of test receiver/spectrum analyzer is 120 kHz for Quasi-peak detection at frequency below 1 GHz.</p>							

10.4-1 Restricted Band Edges

Polarity:Horizontal

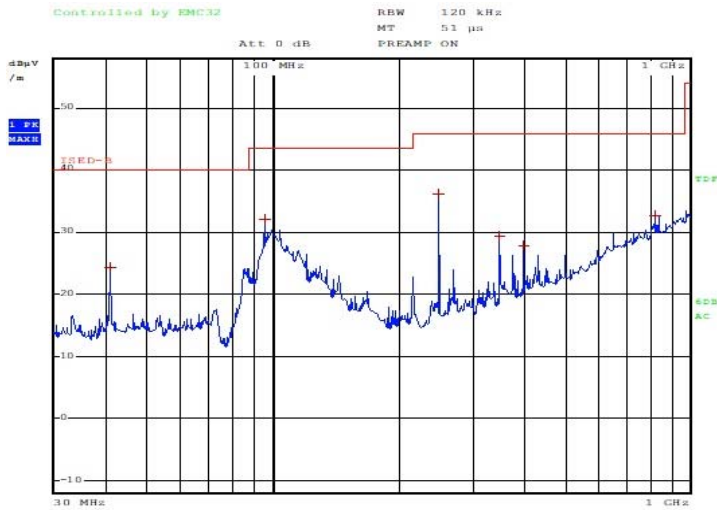

ESTR-22-00248

Polarity:Vertical

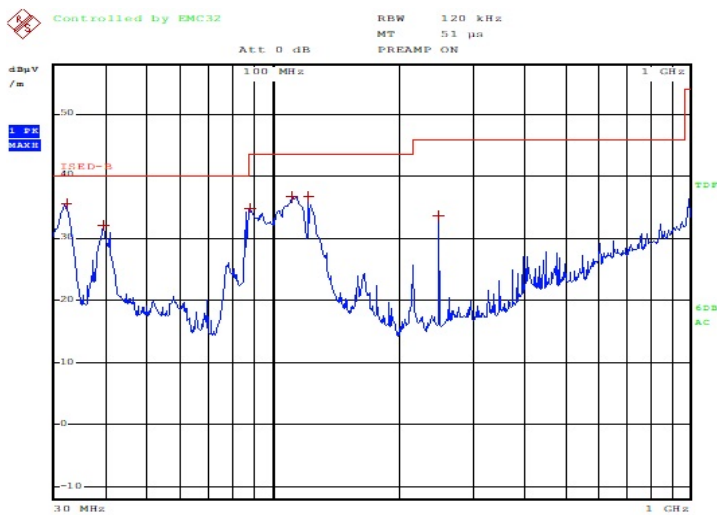

ESTR-22-00248

10.4-2 Test Data(Low)

Test Date : 23-Sep-22

Measurement Distance : 3 m

Frequency (MHz)	Reading (dB μ V)	Position (V/H)	Height (m)	Correction Factor		Duty Cycle Correction (dB)	Result Value		
				Ant Factor (dB)	AMP & Cable (dB)		Limit (dB μ V/m)	Result (dB μ V/m)	Margin (dB)
PEAK(RBW: 1 MHz VBW: 3 MHz)									
2390.00	48.64	H	1.4	27.54	-29.43		74.00	46.75	27.25
2390.00	47.41	V	1.4	27.54	-29.43		74.00	45.52	28.48
4804.00	45.57	H	1.5	31.30	-26.89		74.00	49.98	24.02
4804.00	45.41	V	1.5	31.30	-26.89		74.00	49.82	24.18
AV(RBW: 1 MHz VBW: 3 MHz)									
2390.00	36.60	H	1.4	27.54	-29.43	0.63	54.00	35.34	18.66
2390.00	36.66	V	1.6	27.54	-29.43	0.63	54.00	35.40	18.60
4804.00	33.82	H	1.5	31.30	-26.89	0.63	54.00	38.86	15.14
4804.00	33.74	V	1.5	31.30	-26.89	0.63	54.00	38.78	15.22
Remark	<p>H : Horizontal, V : Vertical TEST MODE : CH : 0 - 2 402 MHz (x postion)</p> <p>*The TX signal wasn't detected from 3th harmonics.</p> <p>*Checked in all 3 axis and the maximum measured data were reported.(Worst data is X axis of position)</p> <p>*Total = Reading Value + Antenna Factor + Cable Loss - Amp Gain + Duty Cycle Correction</p> <p>*This test was radiated up to 26.5 GHz but no noise was measured.</p>								



10.4-3 Test Data(Middle)

Test Date : 23-Sep-22

Measurement Distance : 3 m

Frequency (MHz)	Reading (dB μ W)	Position (V/H)	Height (m)	Correction Factor		Duty Cycle Correction(dB)	Result Value		
				Ant Factor (dB)	AMP & Cable (dB)		Limit (dB μ W/m)	Result (dB μ W/m)	Margin (dB)
PEAK(RBW: 1 MHz VBW: 3 MHz)									
4880.00	46.13	H	1.5	31.30	-26.74		74.00	50.69	23.31
4880.00	46.36	V	1.6	31.30	-26.74		74.00	50.92	23.08
AV(RBW: 1 MHz VBW: 3 MHz)									
4880.00	33.68	H	1.5	31.30	-26.74	0.63	54.00	38.87	15.13
4880.00	33.61	V	1.6	31.30	-26.74	0.63	54.00	38.80	15.20
Remark	<p>H : Horizontal, V : Vertical TEST MODE : CH : 19 - 2 440 MHz (x postion)</p> <p>*The TX signal wasn't detected from 3th harmonics. *Checked in all 3 axis and the maximum measured data were reported.(Worst data is X axis of position) *Total = Reading Value + Antenna Factor + Cable Loss - Amp Gain + Duty Cycle Correction *This test was radiated up to 26.5 GHz but no noise was measured.</p>								

10.4-4 Test Data(High)

Test Date : 23-Sep-22

Measurement Distance : 3 m

Frequency (MHz)	Reading (dB μ V)	Position (V/H)	Height (m)	Correction Factor		Duty Cycle Correction (dB)	Result Value		
				Ant Factor (dB)	AMP & Cable (dB)		Limit (dB μ V/m)	Result (dB μ V/m)	Margin (dB)
PEAK(RBW: 1 MHz VBW: 3 MHz)									
2483.50	51.39	H	1.4	27.41	-29.37		74.00	49.43	24.57
2483.50	50.34	V	1.4	27.41	-29.37		74.00	48.38	25.62
4960.00	46.72	H	1.5	31.48	-26.58		74.00	51.62	22.38
4960.00	46.37	V	1.5	31.48	-26.58		74.00	51.27	22.73
AV(RBW: 1 MHz VBW: 3 MHz)									
2483.50	37.52	H	1.5	27.41	-29.37	0.63	54.00	36.19	17.81
2483.50	36.77	V	1.4	27.41	-29.37	0.63	54.00	35.44	18.56
4960.00	33.26	H	1.4	31.48	-26.58	0.63	54.00	38.79	15.21
4960.00	33.11	V	1.5	31.48	-26.58	0.63	54.00	38.64	15.36
Remark	<p>H : Horizontal, V : Vertical TEST MODE : CH : 39 - 2 480 MHz (x postion)</p> <p>*The TX signal wasn't detected from 3th harmonics. *Checked in all 3 axis and the maximum measured data were reported.(Worst data is X axis of position) *Total = Reading Value + Antenna Factor + Cable Loss - Amp Gain + Duty Cycle Correction *This test was radiated up to 26.5 GHz but no noise was measured.</p>								

10.4-5 Restricted Band Edges

Band Edges(CH Low)

Detector mode:Peak

Polarity:Horizontal

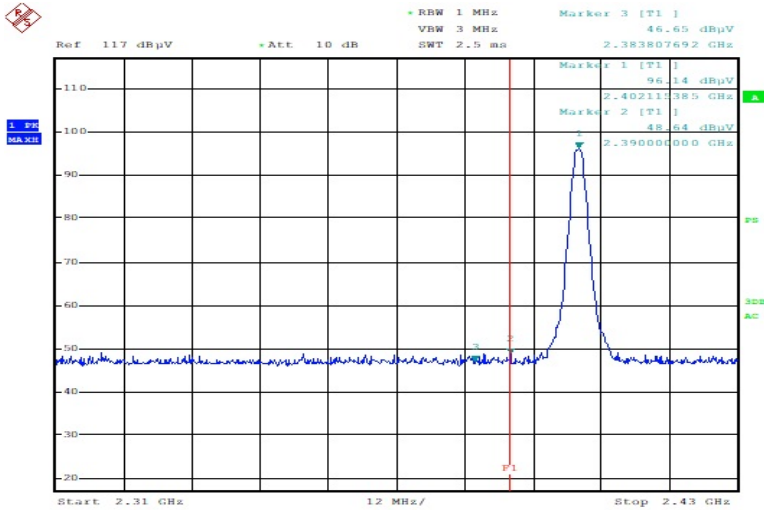

ESTR-22-00248

Detector mode:Average

Polarity:Horizontal

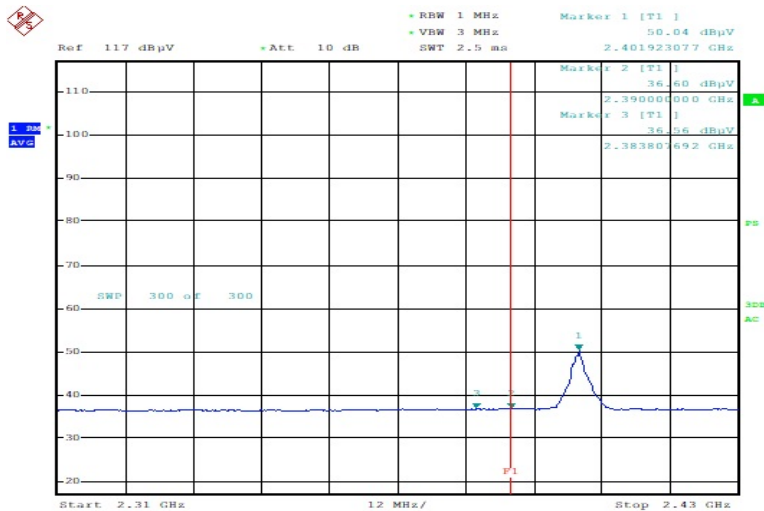

ESTR-22-00248

Band Edges(CH Low)

Detector mode:Peak

Polarity:Vertical

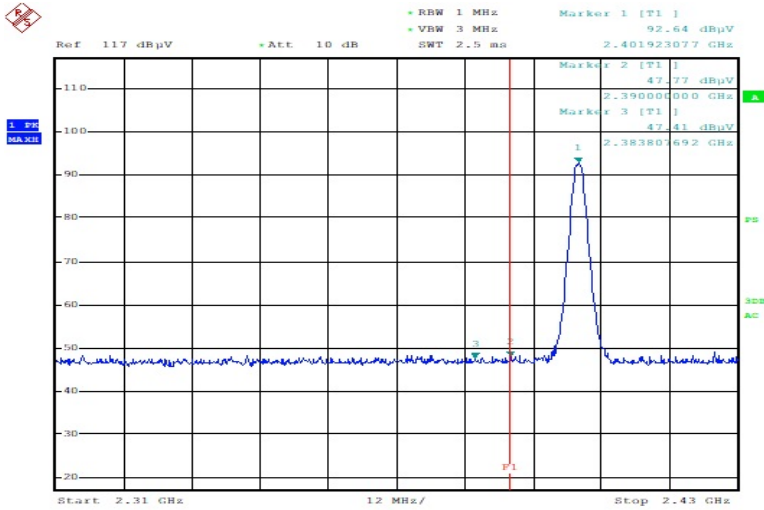

ESTR-22-00248

Detector mode:Average

Polarity:Vertical

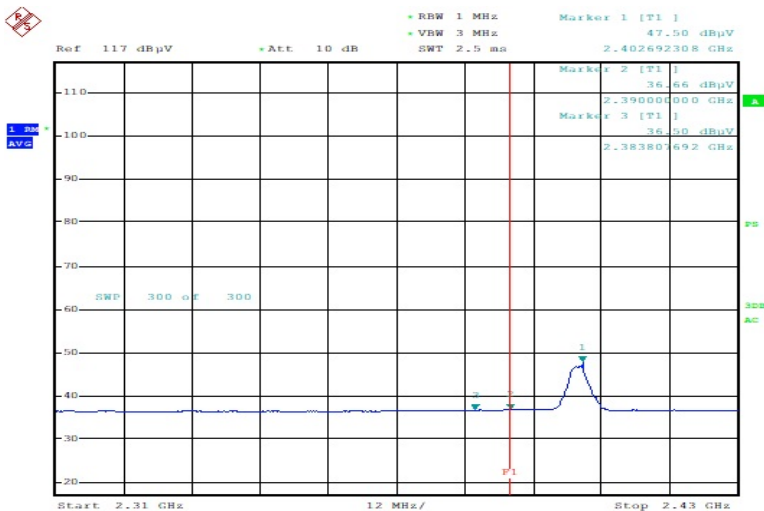

ESTR-22-00248

Band Edges(CH High)

Detector mode:Peak

Polarity:Horizontal

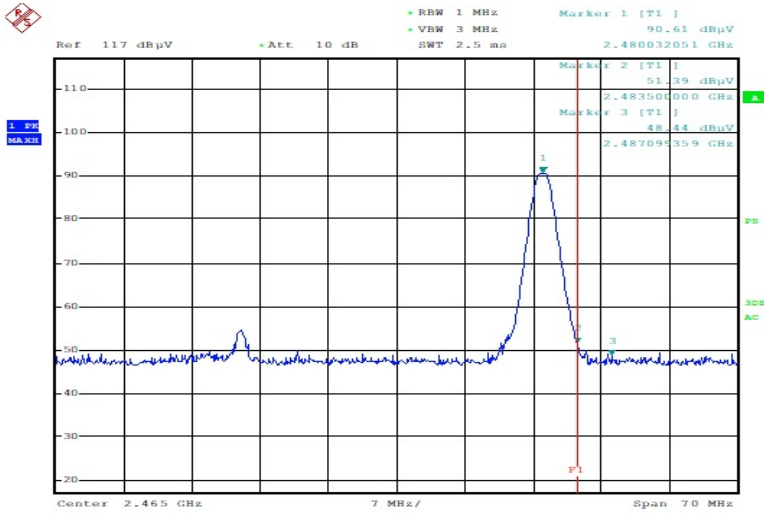

ESTR-22-00248

Detector mode:Average

Polarity:Horizontal

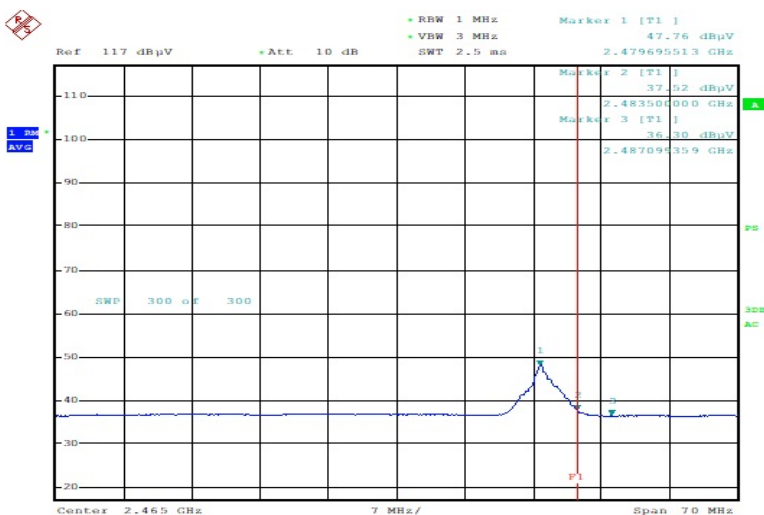

ESTR-22-00248

Band Edges(CH High)

Detector mode:Peak

Polarity:Vertical

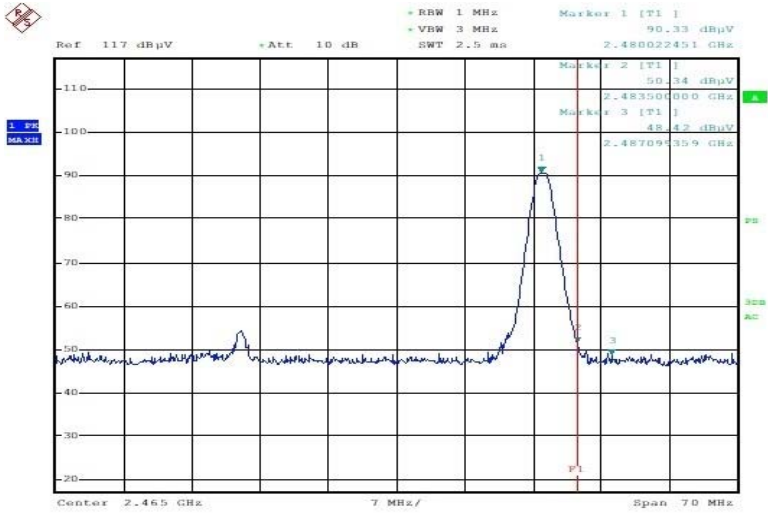

ESTR-22-00248

Detector mode:Average

Polarity:Vertical

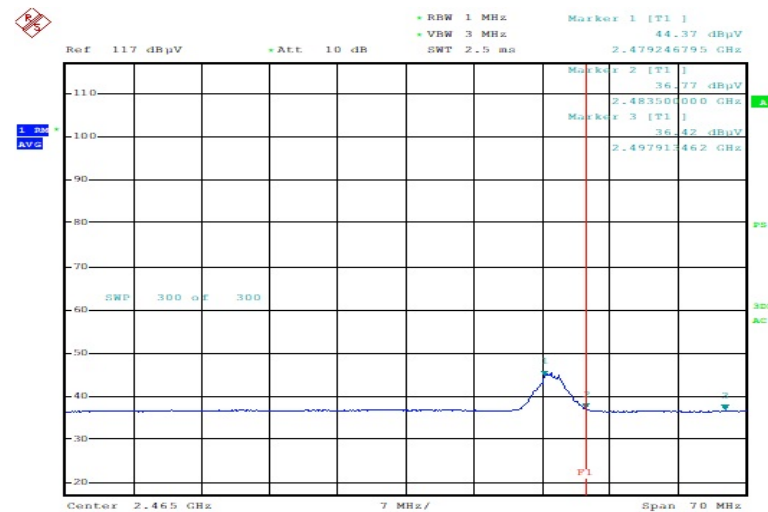

ESTR-22-00248

10.4-6 Restricted Band Edges

Band Edges(CH Low)

Polarity:Horizontal

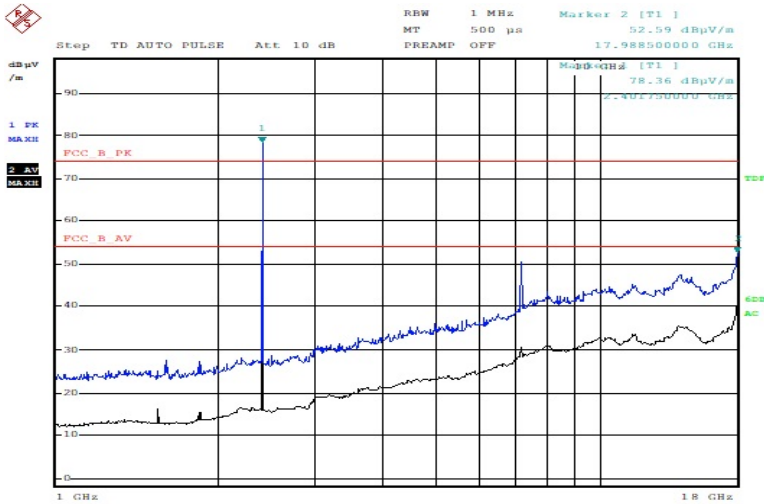

ESTR-22-00248

Polarity:Vertical

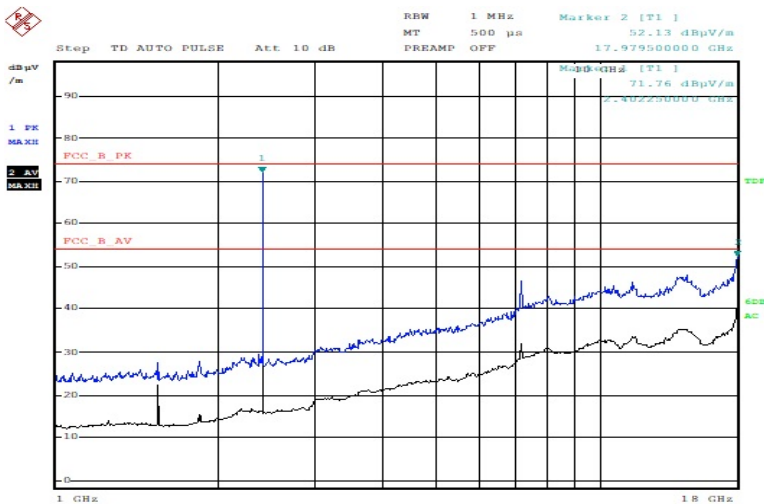

ESTR-22-00248

Band Edges(CH Middle)

Polarity:Horizontal

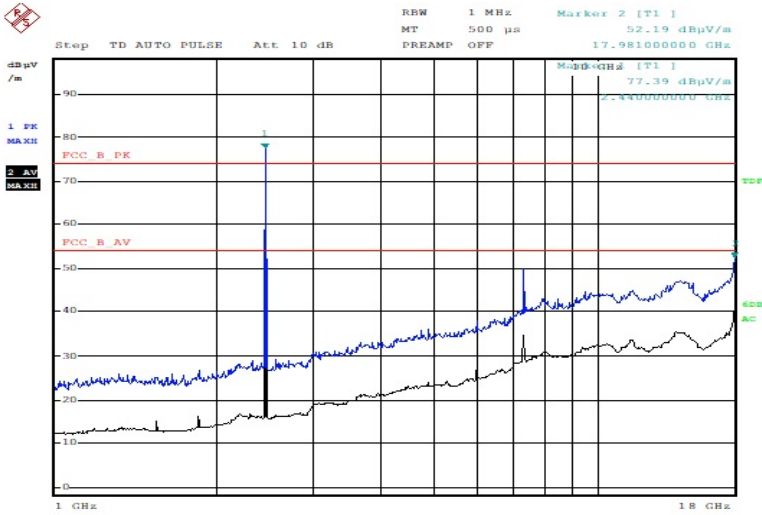

ESTR-22-00248

Polarity:Vertical

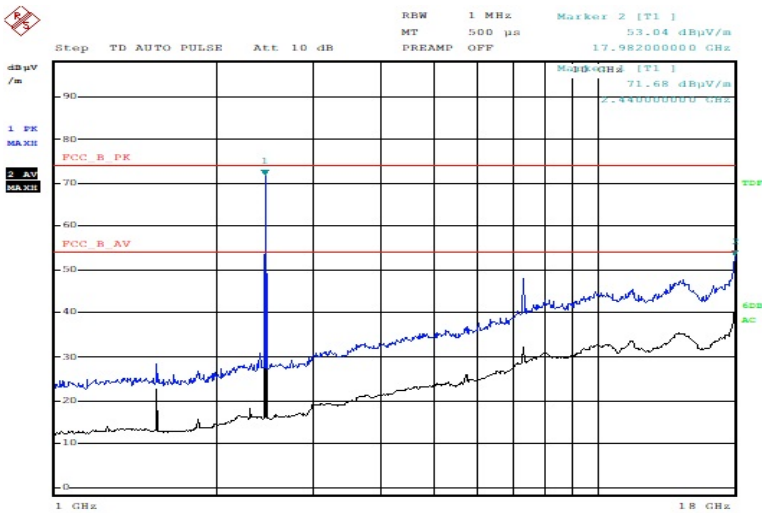

ESTR-22-00248

Band Edges(CH High)

Polarity:Horizontal

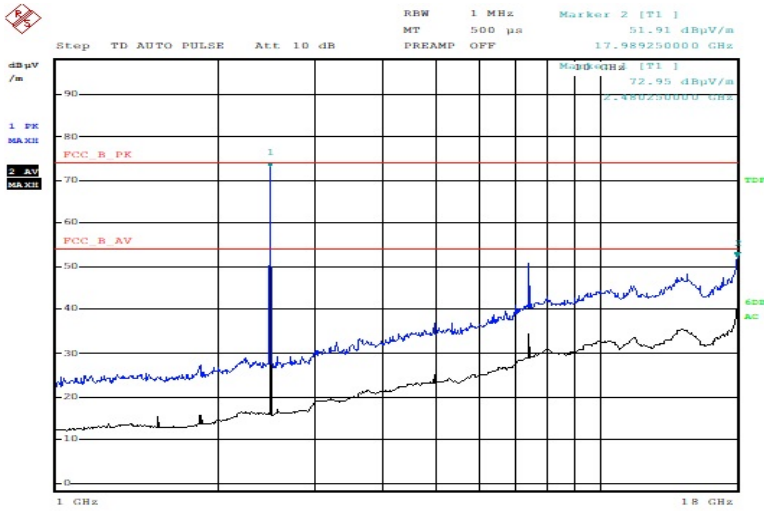

ESTR-22-00248

Polarity:Vertical

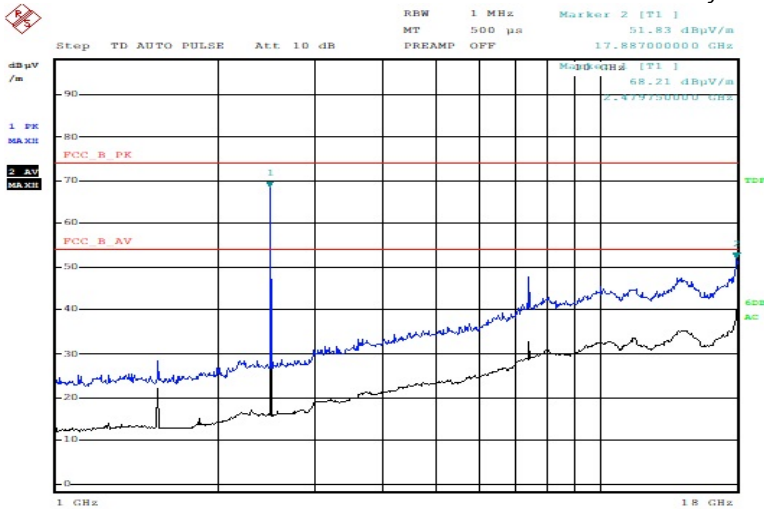

ESTR-22-00248

11. Measurement of conducted disturbance

The continuous disturbance voltage of AC Mains in the frequency from 0.15 MHz to 30 MHz was measured in accordance to FCC PART 15.207. The test setup was made according to ANSI C 63.10 (2009) in a shielded room. The EUT was placed on a non-conductive table at least 0.8 m above the ground plan. A grounded vertical reference plane was positioned in a distance of 0.4 m from the EUT. The distance from the EUT to other metal surfaces was at least 0.8 m. The EUT was only earthen by its power cord through the line impedance stabilizing network. The power cord has been bundled to a length of 1.0 m. The test receiver with Quasi Peak detector complies with CISPR 16.

11.1 Measurement equipments

Equipment Name	Type	Manufacturer	Serial No.	Next Calibration date
TEST RECEIVER	ESPI	Rohde & Schwarz	100005	29-Jun-23
LISN	ESH3-Z5	Rohde & Schwarz	836679/025	29-Jun-23
Pulse Limiter	ESH3Z2	Rohde & Schwarz	NONE	29-Jun-23

11.2 Environmental Condition

Test Place : Shielded Room

Temperature (°C) : 23.1 °C

Humidity (% R.H.) : 44.8 % R.H.

11.3 Test Data

Test Date : 24-Sep-22

Frequency (MHz)	Correction Factor		Line (H/N)	Quasi-peak Value			Average Value		
	Lisn (dB)	Cable (dB)		Limit (dB μ V)	Reading (dB μ V)	Result (dB μ V)	Limit (dB μ V)	Reading (dB μ V)	Result (dB)
0.32	0.04	0.15	H	59.68	31.35	31.54	49.68	21.44	21.63
0.35	0.04	0.15	N	59.01	32.52	32.71	49.01	22.08	22.27
0.36	0.04	0.15	H	58.79	30.96	31.15	48.79	21.45	21.64
0.40	0.04	0.15	H	57.93	31.51	31.70	47.93	22.22	22.41
0.45	0.04	0.15	N	56.87	41.18	41.37	46.87	32.38	32.57
0.46	0.04	0.15	H	56.65	39.35	39.54	46.65	28.96	29.15
Remark	H : Hot Line, N : Neutral Line *Correction Factor = Lisn + Cable *Result = Correction Factor + Reading								

Appendix 1. Special diagram

*CONDUCTED EMISSION

* HOT LINE

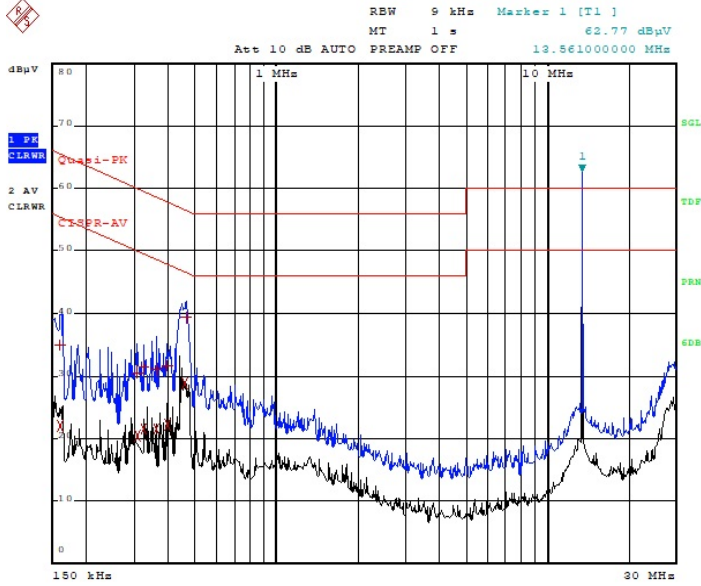

Comment: ESTR-22-00248

* NEUTRAL LINE

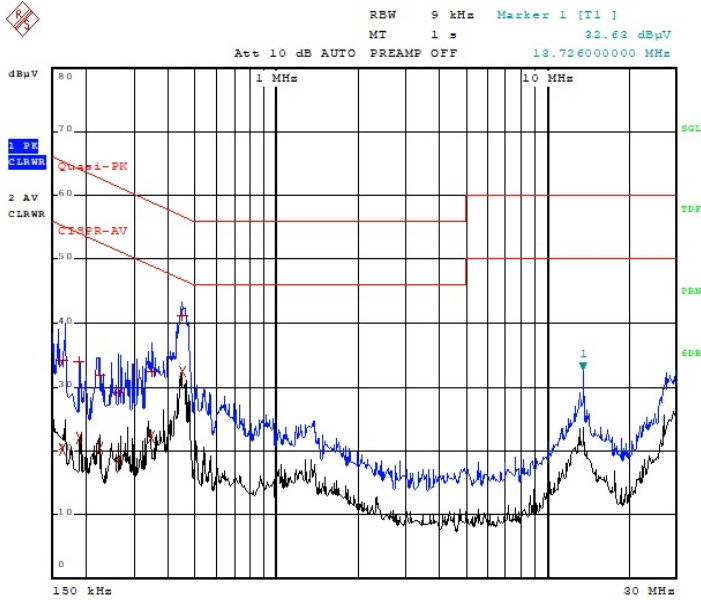

Comment: ESTR-22-00248

Appendix 2. Antenna information

1. Antenna information

antenna type : PCB pattern Antenna.
antenna location : Integral
antenna gain : 2.0 dBi
No temporary RF connector provided