

XPass D2

INSTALLATION GUIDE

Version 1.07

English

EN 101.00.XPD2-MDB, XPD2-GDB, XPD2-GKDB V1.07A

CONTENTS

Safety instructions	2	FCC compliance information	13
Instructional icons	2		
		EU Declaration of Conformity (CE)	13
Introduction	4		
Components	4	Appendices	14
Name and function of each part	5	Disclaimers	14
		Copyright notice	14
Installation	7	Open Source License	15
Fixing the bracket and the product	7		
Power supply connection	9		
RS-485 connection	9		
Wiegand and other cable connections	10		
Restoring the Factory Defaults	10		
Resetting the baud rate of RS-485	10		
Product specifications	11		
Dimensions	12		
XPD2-MDB	12		
XPD2-GDB, XPD2-GKDB	12		

Safety instructions

Please read this safety instructions before you use the product to prevent injury to yourself and others and to prevent property damage. The term 'product' in this manual refers to the product and any items provided with the product.

Instructional icons



Warning: This symbol indicates situations that could result in death or severe injury.



Caution: This symbol indicates situations that may result in moderate injury or property damage.



Note: This symbol indicates notes or additional information.



Warning

Installation

Do not install or repair the product arbitrarily.

- This may result in electric shock, fire, or product damage.
- Damages caused by any modifications or failure to follow installation instructions can void your manufacturer's warranty.

Do not install the product in a place with direct sunlight, moisture, dust, soot, or a gas leak.

- This may result in electric shock or fire.

Install the product in a well-ventilated and cool place away from direct sunlight to prevent overheating when installing it outside.

Do not place the product inside the sealed enclosure when installing it outside.

- It increases the internal temperature of the enclosure and this may result in electric shock, fire, or malfunction.

Do not install the product in a location with heat from an electric heater.

- This may result in fire due to overheating.

Install the product in a dry location.

- Humidity and liquids may result in electric shock or product damage.

Do not install the product in a location where it will be affected by radio frequencies.

- This may result in fire or product damage.

Operation

Keep the product dry.

- Humidity and liquids may result in electric shock, fire, or product damage.

Do not use damaged power supply adaptors, plugs, or loose electrical sockets.

- Unsecured connections may cause electric shock or fire.

Do not bend or damage the power cord.

- This may result in electric shock or fire.



Caution

Installation

Do not install the product under direct sunlight or UV light.

- This may result in product damage, malfunction, discoloration, or deformation.

Do not install the power supply cable in a location where people pass by.

- This may result in injury or product damage.

Do not install the product near magnetic objects, such as a magnet, TV, monitor (especially CRT), or speaker.

- The product may malfunction.

Do not seal around the product with silicone, etc. when installing it on the wall.

- The product may malfunction.

Keep the minimum distance between products when installing multiple products.

- The product may be affected by radio frequencies emitted by other products and the product may malfunction.

Use the IEC/EN 62368-1 approved power adaptor that supports higher power consumption than the product. It is highly recommended to use the power adaptor sold by Suprema.

- If the right power supply is not used, the product may malfunction.

It is recommended to use the enclosure if the product is installed outside.

- The product may malfunction if the water-resistant and dust-resistant features are damaged.

Operation

Do not drop the product or cause impacts to the product.

- The product may malfunction.

Do not disconnect the power supply while upgrading the firmware of the product.

- The product may malfunction.

Do not disclose the password to others and change it regularly.

- This may result in illegal intrusion.

Do not store your product in very hot or very cold places. It is recommended to use your product at temperatures from -35 °C to 65 °C.

- The product may malfunction.

When cleaning the product, mind the following.

- Wipe the product with a clean and dry towel.
- If you need to sanitize the product, moisten the cloth or the wipe with a proper amount of rubbing alcohol and gently clean all exposed surfaces including fingerprint sensor. Use rubbing alcohol (containing 70% Isopropyl alcohol) and a clean, non-abrasive cloth like lens wipe.
- Do not apply liquid directly to the surface of the product.

Do not use the product for anything other than its intended use.









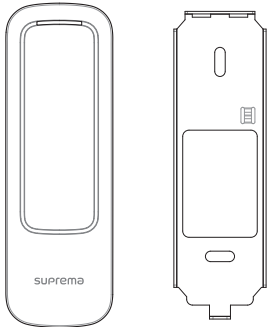
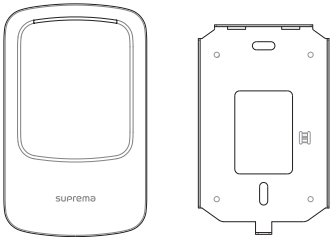
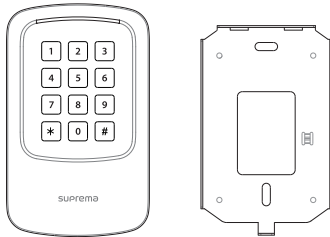

- The product may malfunction.

RTC battery

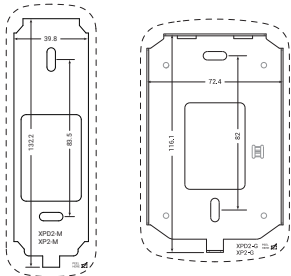
Discard the battery according to the appropriate regional or international waste regulations. Discard the battery according to the appropriate regional or international waste regulations.

Introduction

Components

			
<p>Device and Wall Bracket (XPD2-MDB)</p>	<p>Device and Wall Bracket (XPD2-GDB)</p>	<p>Device and Wall Bracket (XPD2-GKDB)</p>	
			
<p>PVC Anchor x2</p>	<p>Fixing Screw x2</p>	<p>Bracket Fixing Screw (Star Shaped)</p>	
			
<p>Drilling Template</p>	<p>Shrink Tube</p>	<p>120 Ω resistor</p>	
			
<p>Quick Guide (XPD2-MDB)</p>	<p>Quick Guide (XPD2-GDB)</p>	<p>Quick Guide (XPD2-GKDB)</p>	<p>Open Source Software Guide</p>



- Components may vary according to the installation environment.
- When assembling the product with the bracket, you can use the included bracket fixing screw (Star Shaped) instead of the product fixing screw for enhanced security.

Name and function of each part

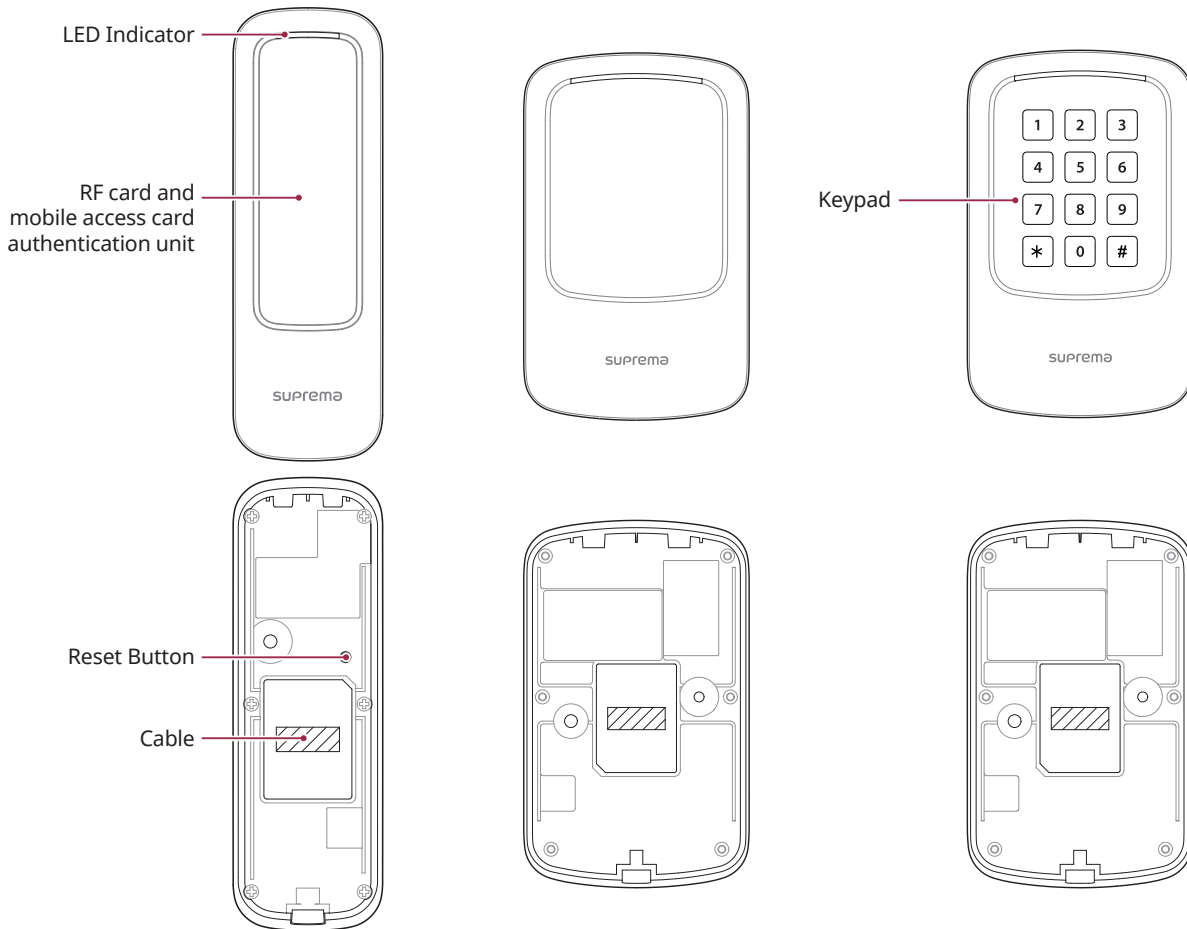

Name	Description
LED Indicator	Indicates the operational status of the device with the color of the LED. <ul style="list-style-type: none"> • Green solid: Authentication success • Red solid: Authentication failure • Blue/Sky blue blinking: Normal operation • Blue/Green blinking: When initializing network settings • Green blinking: Waiting for an input • Green/White blinking: Connecting with the Airfob Pass (BLE) application of Suprema • White blinking: Connecting with the Device Manager application of Suprema
RF card and mobile access card authentication unit	Reads RF cards for entering and exiting.
Reset button	Initialize the device.
Cable	<ul style="list-style-type: none"> • Power cable • RS-485 cable • Wiegand output cable • LED input cable • Beep Input cable • Tamper cable

Keypad

Used to authenticate by entering the card ID directly. If you want to enter the ID directly, change the authentication method settings in BioStar 2.

- 0 ~ 9: Enters number.
- *: Separates the FC code from the ID when entering the Wiegand card ID.
- #: Used to finish entering.



Only the XPD2-GKDB model supports the keypad.

Cables

This document describes cable information based on the shape of the XPD2-MDB model. The same cable configuration is also used for XPD2-GDB and XPD2-GKDB models.

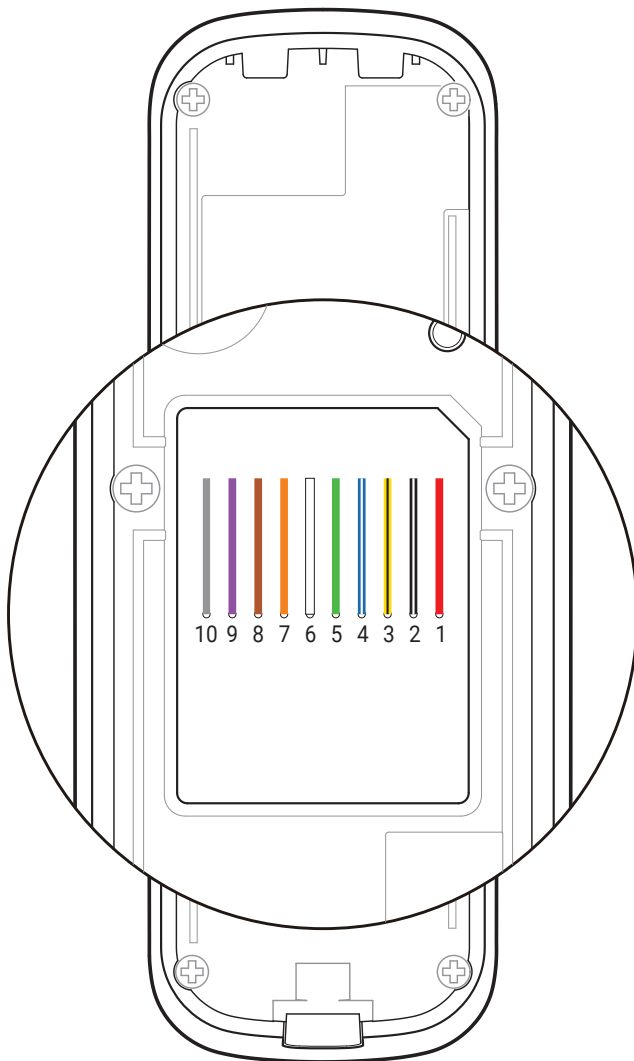

Pin	Name	Color
1	PWR +VDC	Red
2	GND	Black (White stripe)
3	485 TRXN	Yellow (Black stripe)
4	485 TRXP	Blue (White stripe)
5	WG D0	Green
6	WG D1	White
7	LED RED	Orange
8	LED GRN	Brown
9	BEEP	Purple
10	TMPR	Gray

Installation

Fixing the bracket and the product



This document describes the installation method using XPD2-MDB model. Install XPD2-GDB and XPD2-GKDB models in the same way.

- 1 Determine the correct position to install the bracket using the provided drilling template. Fix the bracket firmly using fixing screws through the bracket to the position where XPass D2 will be installed.

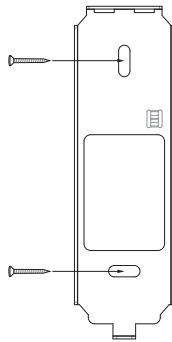

- If installing XPass D2 on a concrete wall, drill holes, insert PVC anchors, and fix them with fixing screws.
- To avoid RF interference, a minimum separation distance must be maintained.

XPD2-MDB

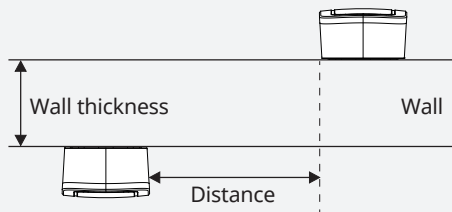

Wall thickness	Distance
100 mm	360 mm
120 mm	360 mm
150 mm	300 mm

Wall

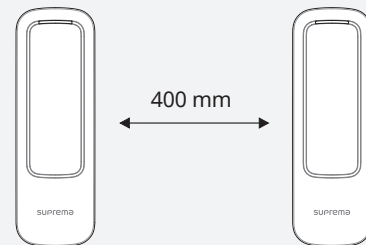

XPD2-GDB, XPD2-GKDB

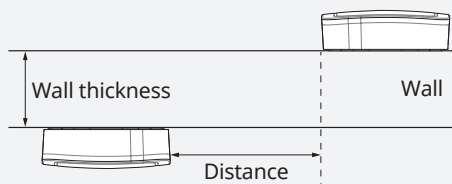

Wall thickness	Distance
100 mm	400 mm
120 mm	380 mm
150 mm	380 mm

Wall

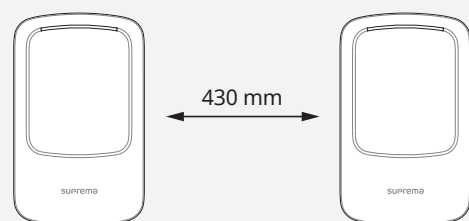

- When using Suprema Mobile Access, install a minimum distance of 1 m between devices to avoid BLE interference.

2 Install XPass D2 onto the fixed bracket.

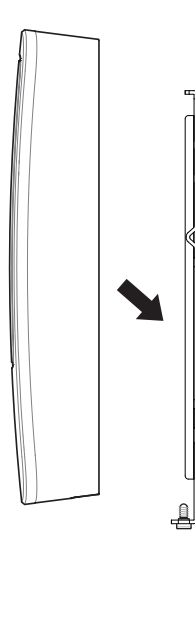

3 Assemble XPass D2 with the bracket by rotating the product fixing screw.

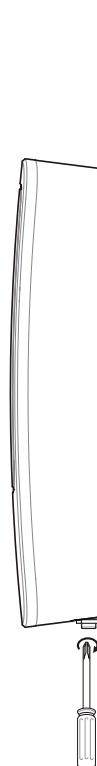

- When assembling the product with the bracket, you can use the included bracket fixing screw(Star Shaped) instead of the product fixing screw for enhanced security.

Power supply connection

XPass D2 can be used as an RFID card reader by connecting to a master device or a CoreStation.

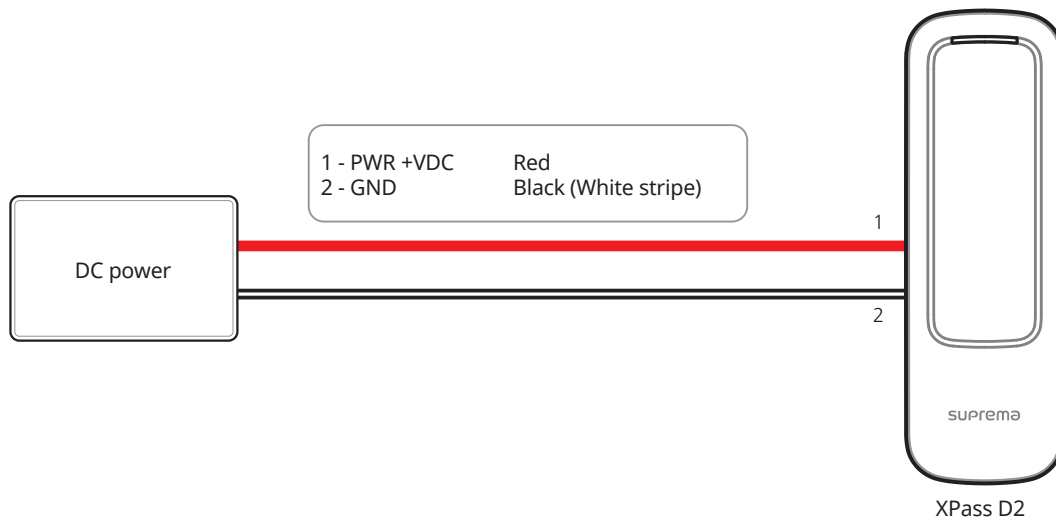

- Use the IEC/EN 62368-1 approved power adaptor that supports higher power consumption than the product. If you wish to connect and use another device to the power supply adaptor, you should use an adaptor with a current capacity which is the same or larger than the total power consumption required for the terminal and another device.

RS-485 connection

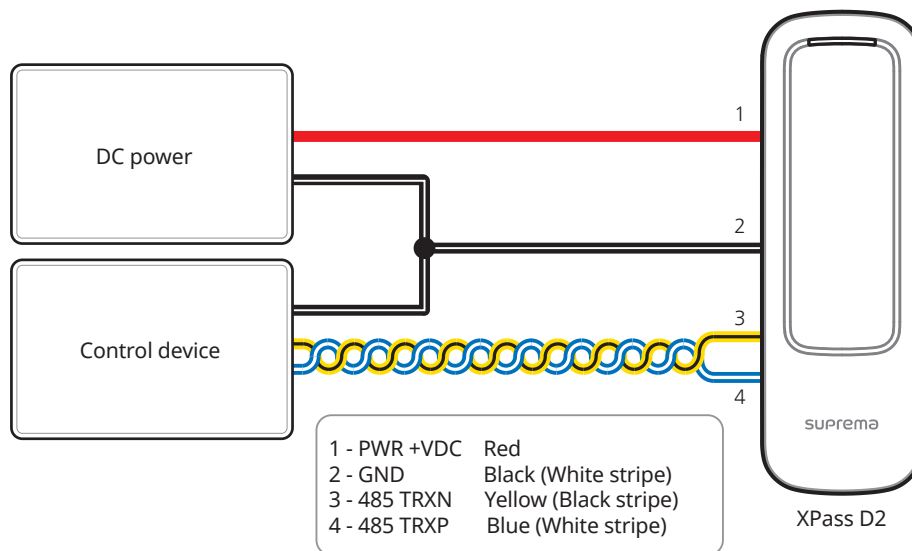

- Use an AWG24 twisted pair with a maximum length of 1.2 km for the RS-485 cable.
- If connecting with a RS-485 daisy chain, connect the termination resistor (120 Ω) to both ends of the daisy chain connection. If connected to the middle line, the signal level becomes smaller and the communication performance will deteriorate. Make sure to connect it to both ends of the daisy chain connection.

Wiegand and other cable connections

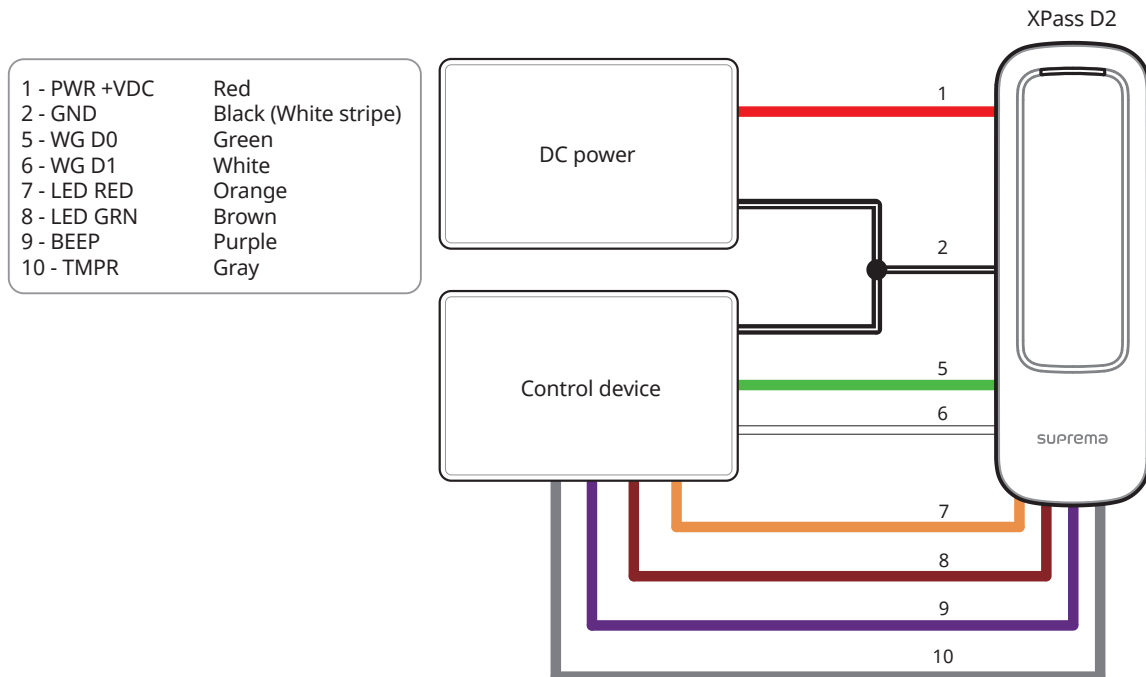

Restoring the Factory Defaults

This will reset all settings stored on the device.

- 1 Turn the power on.
- 2 Press the reset button three times quickly.
- 3 When the green LED is blinking, press the reset button again.

Resetting the baud rate of RS-485

- 1 Turn the power on.
- 2 Press and hold the reset button for more than 2 seconds. When the device change to setup mode, the green LED is blinking.
- 3 Depending on the number of times the reset button was pressed, the baud rate changes. You can recognize the baud rate according to the LED color.

The number of times	Baud Rate	LED Color
1	9600	Cyan
2	19200	Blue
3	38400	Magenta
4	57600	White
5	115200	Red

- 4 The LED blinks for 5 seconds with the color set as the above. The baud rate is set once you hear a beep sound.



- If you do not press the reset button after changing to the setup mode, the baud rate is set to 115200.

Product specifications

Category	Feature	Specifications		
		XPD2-MDB	XPD2-GDB	XPD2-GKDB
Credential	RF Option	125 kHz EM & 13.56 MHz MIFARE, MIFARE Plus, DESFire EV1/EV2*, FeliCa		
	RF read range**	MIFARE/DESFire/EM: 50 mm, FeliCa: 30 mm		
	Mobile	NFC, BLE		
General	CPU	80 MHz		
	Memory	512 KB Flash + 160 KB RAM		
	Crypto chip	Supported		
	LED	Multi-color		
	Sound	Multi-tone Buzzer		
	Operating temperature	-20°C to 50°C		
	Storage temperature	-40°C to 70°C		
	Operating humidity	0 % to 95 %, non-condensing		
	Storage humidity	0 % to 95 %, non-condensing		
	Dimension (W x H x D)	48 x 145 x 27	80 x 130 x 25	80 x 130 x 25
	Weight	<ul style="list-style-type: none"> • Device: 117 g • Bracket: 30 g (Including washer and bolt) 	<ul style="list-style-type: none"> • Device: 140 g • Bracket: 52 g (Including washer and bolt) 	<ul style="list-style-type: none"> • Device: 145 g • Bracket: 52 g (Including washer and bolt)
	IP rating	IP65, IP67		
	IK rating	IK08		
	Certificates	CE, FCC, KC, RoHS, REACH, WEEE, SIG, SIA OSDP Verified		
Interface	RS-485	1ch		
	Wiegand	1ch		
	LED	2ch		
	Beep	1ch		
	Tamper	Supported		
Electrical	Power	Voltage: DC 12 V, Current: Max. 300 mA		
	LED, Beep input VIH	Min. 3 V, Max. 5 V		
	LED, Beep input VIL	Max. 1 V		
	LED, Beep Pull-up resistance	4.7kΩ (The input ports are pulled up with 4.7kΩ.)		
	Wiegand output VOH	Min. 4.8 V		
	Wiegand output VOL	Max. 0.2 V		
	Wiegand output Pull-up resistance	Internally pulled up with 1 kΩ		

* DESFire EV2 cards are supported by having backward compatibility of DESFire EV1 cards. CSN and smart card functions are compatible with XPass D2.

** RF read range will vary depending on the installation environment.
SAM slot (Management slot)

Dimensions

(Unit: mm)

* The tolerance is $\pm 0.3\text{mm}$.

XPD2-MDB

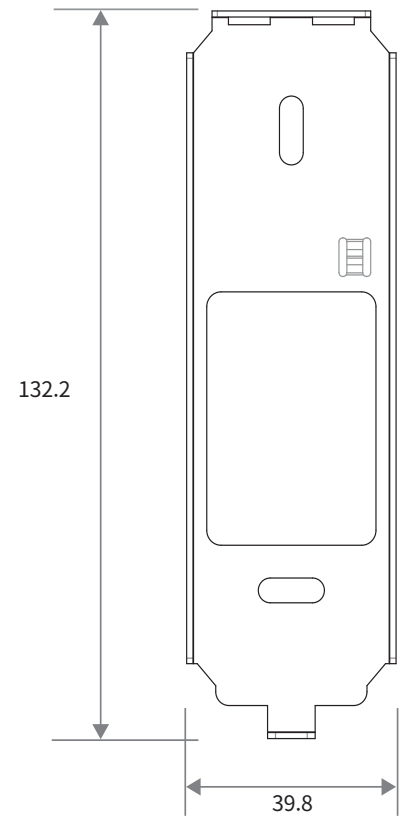
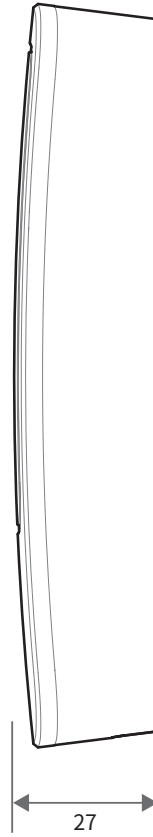
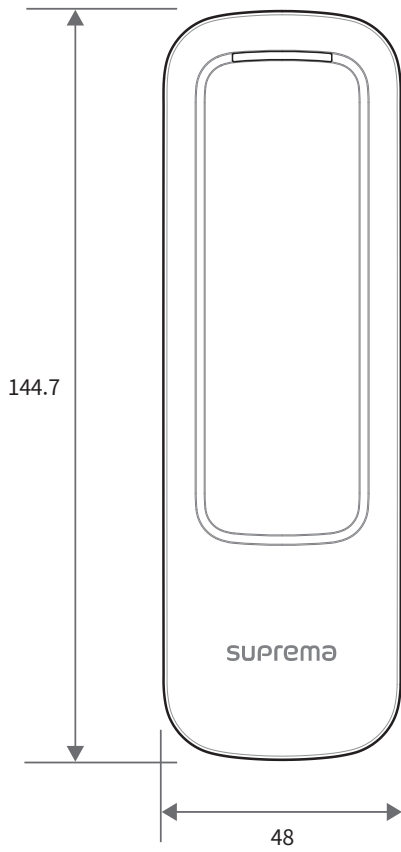

XPD2-GDB, XPD2-GKDB

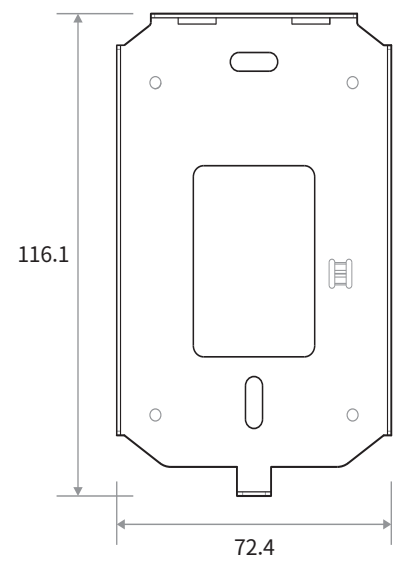
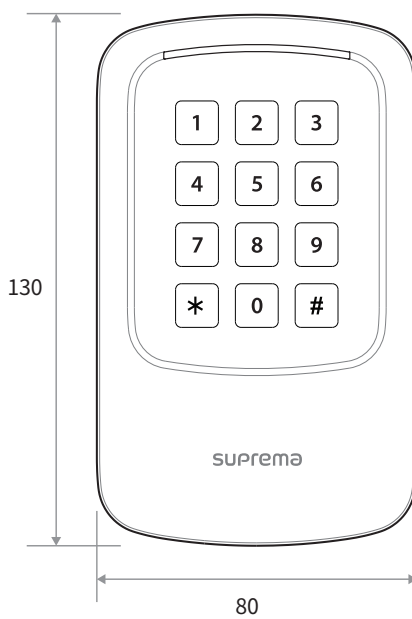

FCC compliance information

THIS DEVICE COMPLIES WITH PART 15 OF THE FCC RULES.

Operation is subject to the following two conditions:

- (1) This device may not cause harmful interference, and
- (2) This device must accept any interference received, including interference that may cause undesired operation.



This equipment has been tested and found to comply with the limits for a Class A digital device, pursuant to part 15 of the FCC Rules. These limits are designed to provide reasonable protection against harmful interference when the equipment is operated in a commercial environment. This equipment generates, uses, and can radiate radio frequency energy and, if not installed and used in accordance with the instruction manual, may cause harmful interference to radio communications. Operation of this equipment in a residential area is likely to cause harmful interference in which case the user will be required to correct the interference at his own expense.

FCC Caution

Any changes or modifications not expressly approved by the party responsible for compliance could void the user's authority to operate this equipment. This transmitter must not be co-located or operating in conjunction with any other antenna or transmitter.

FCC Radiation Exposure Statement (Part 2.1091)

This equipment complies with FCC radiation exposure limits set forth for an uncontrolled environment. This equipment should be installed and operated with minimum distance 20 cm between the radiator and your body. This transmitter must not be co-located or operating in conjunction with any other antenna or transmitter.

EU Declaration of Conformity (CE)

This product is CE marked according to the provisions of the Radio Equipment Directive (RED) 2014/53/EU. Hereby, Suprema Inc. declares that this product is in compliance with the essential requirements and other relevant provisions of Radio Equipment Directive (RED) 2014/53/EU.

- Bluetooth Transmit Power: -5.96dBm
- Bluetooth Frequency: 2402~2480 MHz
- NFC Frequency: 13.56 MHz
- RFID Frequency: 13.56 MHz + 125 kHz

For more information, contact us at the following contact information.

Suprema Inc.

Website: <https://www.supremainc.com>

Address: 17F Parkview Tower, 248, Jeongjail-ro, Bundang-gu, Seongnam-si, Gyeonggi-do, 13554, Rep. of KOREA

Tel: +82-31-783-4502 / Fax: +82-31-783-4503



Appendices

Disclaimers

- Information in this document is provided in connection with Suprema products.
- The right to use is acknowledged only for Suprema products included in the terms and conditions of use or sale for such products guaranteed by Suprema. No license, express or implied, by estoppel or otherwise, to any intellectual property is granted by this document.
- Except as expressly stated in an agreement between you and Suprema, Suprema assumes no liability whatsoever, and Suprema disclaims all warranties, express or implied including, without limitation, relating to fitness for a particular purpose, merchantability, or noninfringement.
- All warranties are VOID if Suprema products have been: 1) improperly installed or where the serial numbers, warranty date or quality assurance decals on the hardware are altered or removed; 2) used in a manner other than as authorized by Suprema; 3) modified, altered or repaired by a party other than Suprema or a party authorized by Suprema; or 4) operated or maintained in unsuitable environmental conditions.
- Suprema products are not intended for use in medical, lifesaving, life-sustaining applications, or other applications in which the failure of the Suprema product could create a situation where personal injury or death may occur. Should you purchase or use Suprema products for any such unintended or unauthorized application, you shall indemnify and hold Suprema and its officers, employees, subsidiaries, affiliates, and distributors harmless against all claims, costs, damages, and expenses, and reasonable attorney fees arising out of, directly or indirectly, any claim of personal injury or death associated with such unintended or unauthorized use, even if such claim alleges that Suprema was negligent regarding the design or manufacture of the part.
- Suprema reserves the right to make changes to specifications and product descriptions at any time without notice to improve reliability, function, or design.
- Personal information, in the form of authentication messages and other relative information, may be stored within Suprema products during usage. Suprema does not take responsibility for any information, including personal information, stored within Suprema's products that are not within Suprema's direct control or as stated by the relevant terms and conditions. When any stored information, including personal information, is used, it is the responsibility of the product users to comply with national legislation (such as GDPR) and to ensure proper handling and processing.
- You must not rely on the absence or characteristics of any features or instructions marked "reserved" or "undefined." Suprema reserves these for future definition and shall have no responsibility whatsoever for conflicts or incompatibilities arising from future changes to them.
- Except as expressly set forth herein, to the maximum extent permitted by law, the Suprema products are sold "as is".
- Contact your local Suprema sales office or your distributor to obtain the latest specifications and before placing your product order.

Copyright notice

The copyright of this document is vested in Suprema. The rights of other product names, trademarks and registered trademarks are vested in each individual or organization that owns such rights.

Open Source License

MIT License

Permission is hereby granted, free of charge, to any person obtaining a copy of this software and associated documentation files (the "Software"), to deal in the Software without restriction, including without limitation the rights to use, copy, modify, merge, publish, distribute, sublicense, and/or sell copies of the Software, and to permit persons to whom the Software is furnished to do so, subject to the following conditions:

The above copyright notice and this permission notice shall be included in all copies or substantial portions of the Software.

THE SOFTWARE IS PROVIDED "AS IS", WITHOUT WARRANTY OF ANY KIND, EXPRESS OR IMPLIED, INCLUDING BUT NOT LIMITED TO THE WARRANTIES OF MERCHANTABILITY, FITNESS FOR A PARTICULAR PURPOSE AND NONINFRINGEMENT. IN NO EVENT SHALL THE AUTHORS OR COPYRIGHT HOLDERS BE LIABLE FOR ANY CLAIM, DAMAGES OR OTHER LIABILITY, WHETHER IN AN ACTION OF CONTRACT, TORT OR OTHERWISE, ARISING FROM, OUT OF OR IN CONNECTION WITH THE SOFTWARE OR THE USE OR OTHER DEALINGS IN THE SOFTWARE.

IC compliance information

Industry Canada Statement

This device complies with RSS-247 of the Industry Canada Rules. Operation is subject to the following two conditions: (1) This device may not cause harmful interference, and (2) this device must accept any interference received, including interference that may cause undesired operation. Ce dispositif est conforme à la norme CNR-247 d'Industrie Canada applicable aux appareils radio exempts de licence. Son fonctionnement est sujet aux deux conditions suivantes: (1) le dispositif ne doit pas produire de brouillage préjudiciable, et (2) ce dispositif doit accepter tout brouillage reçu, y compris un brouillage susceptible de provoquer un fonctionnement indésirable.

Industry Canada Radiation Exposure Statement

This equipment complies with IC radiation exposure limits set forth for an uncontrolled environment. This equipment should be installed and operated with minimum distance 20 cm between the radiator & your body.

Déclaration d'exposition aux radiations

Cet équipement est conforme aux limites d'exposition aux rayonnements IC établies pour un environnement non contrôlé. Cet équipement doit être installé et utilisé avec un minimum de 20 cm de distance entre la source de rayonnement et votre corps.



Suprema Inc.

17F Parkview Tower, 248, Jeongjail-ro, Bundang-gu, Seongnam-si, Gyeonggi-do, 13554, Rep. of KOREA

Tel: +82 31 783 4502 | Fax: +82 31 783 4503 | Inquiry: sales_sys@supremainc.com



For more information about Suprema's global branch offices,
visit the webpage below by scanning the QR code.
<https://supremainc.com/en/about/global-office.asp>