



Estech Co., Ltd.

347-69, Jungbu-daero 147beon-gil, Majang-myeon,
Icheon-si, Gyeonggi-do 467-811, R. O. Korea
TEL : +82 31 6318037 FAX : +82 31 6318039 www.estech.co.kr

Test Report for FCC

FCC ID :TKWBSA2-OMPW

Report Number		ESTF151512-001			
Applicant	Company name	Suprema Inc.			
	Address	16F Parkview Tower, Jeongja-dong, Bundang-gu, Seongnam, Gyeonggi, 463-863 Korea			
	Telephone	82-31-783-4505			
	Contact Person	Dongmok Shin			
	Factory address	16F Parkview Tower, Jeongja-dong, Bundang-gu, Seongnam, Gyeonggi, 463-863 Korea			
Product	Product name	Biostation A2			
	Model No.	BSA2-OMPW	Manufacturer	Suprema Inc.	
	Serial No.	NONE	Country of origin	KOREA	
Test date	13/Oct/15 ~ 16/Oct/15		Date of issued	8-Dec-15	
Test location	347-69, Jungbu-daero 147beon-gil, Majang-myeon, Icheon-si, Gyeonggi-do 467-811, R. O. Korea				
Standard	FCC PART 15 Subpart B, ANSI C 63.4 2009				
Test item	<input checked="" type="checkbox"/> Conducted Emission	<input type="checkbox"/> Class A	<input checked="" type="checkbox"/> Class B	Test result	OK
	<input checked="" type="checkbox"/> Radiated Emission	<input type="checkbox"/> Class A	<input checked="" type="checkbox"/> Class B	Test result	OK
Measurement facility registration number		659627			
Tested by	Senior Engineer K.H. Chung		(Signature)		
Reviewed by	Engineering Manager J.M. Yang		(Signature)		
Abbreviation	OK, Pass = Complied, Fail = Failed, N/A = not applicable				
<p>* Note</p> <ul style="list-style-type: none"> - This test report is not permitted to copy partly without our permission - This test result is dependent on only equipment to be used - This test result based on a single evaluation of one sample of the above mentioned 					



Estech Co., Ltd.

347-69, Jungbu-daero 147beon-gil, Majang-myeon,
Icheon-si, Gyeonggi-do 467-811, R. O. Korea
TEL : +82 31 6318037 FAX : +82 31 6318039 www.estech.co.kr

Contents

1. Laboratory Information	3
2. Description of EUT	4
3. Test Standards	5
4. Measurement condition	6
5. Measurement of radiated emission	8
5.1 Measurement equipment	8
5.2 Environmental conditions	8
5.3 Test data(below 1 GHz)	9-1
5.4 Test data(above 1 GHz)	9-2
6. Measurement of conducted emission	10
6.1 Measurement equipment	10
6.2 Environmental conditions	10
6.3 Test data	11
7. Photographs of test setup	12
8. Photographs of EUT	14

Appendix 1. Special diagram



Estech Co., Ltd.

347-69, Jungbu-daero 147beon-gil, Majang-myeon,
Icheon-si, Gyeonggi-do 467-811, R. O. Korea
TEL : +82 31 6318037 FAX : +82 31 6318039 www.estech.co.kr

1. Laboratory Information

1.1 General

This EUT (Equipment Under Test) has been shown to be capable of compliance with the applicable technical standards and is tested in accordance with the measurement procedures as indicated in this report. ESTECH Lab attests to accuracy of test data. All measurement reported herein were performed by ESTECH Co., Ltd.

ESTECH Lab assume full responsibility for the completeness of these measurements and vouch for the qualifications of all persons taking them.

1.2 Test Lab.

Corporation Name : ESTECH Co., Ltd.

Head Office : Suite 1015 World Meridian II, 123 Gasan Digital 2-ro, Geumcheon-gu, Seoul 153-759, R. O. Korea

EMC Test Lab : 347-69, Jungbu-daero 147beon-gil, Majang-myeon, Icheon-si, Gyeonggi-do 467-811, R. O. Korea

1.3 Official Qualification(s)

MSIP : Granted Accreditation from Ministry of Information & Communication for EMC, Safety and Telecommunication

KOLAS : Accredited Lab By Korea Laboratory Accreditation Schema base on CENELEC requirements

FCC : Conformity Assessment Body(CAB) with registration number 659627 under APEC TEL MRA between the RRA and the FCC.

VCCI : Granted Accreditation from Voluntary Control Council for Interference from ITE



Estech Co., Ltd.

347-69, Jungbu-daero 147beon-gil, Majang-myeon,
Icheon-si, Gyeonggi-do 467-811, R. O. Korea
TEL : +82 31 6318037 FAX : +82 31 6318039 www.estech.co.kr

2. Description of EUT

2.1 Summary of Equipment Under Test

Product : Biostation A2
 Model Number : BSA2-OMPW
 Serial Number : NONE
 Manufacturer : Suprema Inc.
 Country of origin : Korea
 Sample Receipt Date : 14-Sep-15
 Rating : Max. 24 V DC, 0.5 A, Max. 1 A
 " X-tallist(s) or
 Frequencies : The highest operating frequency is 2 462 MHz
 generated

2.2 General descriptions of EUT

Category	Feature	Specification
General	Biometric	Fingerprint
	1 FD	Supported
Storage capacity	Rf-Option	2.4 GHz, 13.56 MHz Mifare/Desfire/Desfire EV1/Felica/NFC, 13.56 MHz iClass SE
	Max. User (1:1)	500,000
	Max. User (1:N)	100,000
	Max. Template (1:1)	1,000,000
	Max. Template (1:N)	200,000
	Max. Text Log	5,000,000
Interface	Max. Image Log	50,000
	Wi-Fi	Supported
	TCP/IP	Supported
	RS-485	1ch Host or Slave (Selectable)
	RS-232	Supported
	Wiegand	1ch Input, 1ch Output
	TTL Input	1ch Input
Relay	Relay	2 Relay
	USB	USB 2.0 (Host)
	Voltage	Max. 24 V DC
Hardware	Current	0.5 A, Max. 1 A
	CPU	1.0 GHz
	Memory	8 GB Flash + 1 GB RAM
	LCD	5" color touch LCD
	LED	Multiple colors
	Sound	24 bit/Voice DSP (echo cancel)
	Operating temperature	-20°C ~ 50°C
	Temper	Supported
	Power	9 V ~ 18 V
	PoE	Supported
	Dimension (W x H x D mm)	155 x 155 x 40
	Certificates	CE, FCC, KC, RoHS, REACH, WEEE



Estech Co., Ltd.

347-69, Jungbu-daero 147beon-gil, Majang-myeon,
Icheon-si, Gyeonggi-do 467-811, R. O. Korea
TEL : +82 31 6318037 FAX : +82 31 6318039 www.estech.co.kr

3. Test Standards

Test Standard : FCC PART 15 Subpart B

This Standard sets out the regulations under which an intentional, unintentional, or incidental radiator may be operated without an individual license. It also contains the technical specifications, administrative requirements and other conditions relating to the marketing of Part 15 devices.

Test Method : ANSI C 63.4 (2009)

This standard sets forth uniform methods of measurement of radio-frequency (RF) signals and noise emitted from both unintentional and intentional emitters of RF energy in the frequency range 9 kHz to 40 GHz. Methods for the measurement of radiated and AC power-line conducted radio noise are covered and may be applied to any such equipment unless otherwise specified by individual equipment requirements. These methods cover measurement of certain devices that deliberately radiate energy, such as intentional emitters, but does not cover licensed transmitters. This standard is not intended for certification/approval of avionic equipment or for industrial, scientific, and medical (ISM) equipment. These methods apply to the measurement of individual units or systems comprised of multiple units.



Estech Co., Ltd.

347-69, Jungbu-daero 147beon-gil, Majang-myeon,
Icheon-si, Gyeonggi-do 467-811, R. O. Korea
TEL : +82 31 6318037 FAX : +82 31 6318039 www.estech.co.kr

4. Measurement Condition

4.1 EUT Operation.

- The EUT was in the following operation mode during all testing.

1. Connect the EUT to External Network / LAN port of the Note PC.
2. Install the provided test program by the manufacturer.
3. Execute the test program and check the operating status of the EUT.
(Check fingerprint detection and RFID Card display on the note pc continuously.)
4. Configuration 1(Adapter - Mode1) / Configuration 2(PoE - Mode2)

4.2 Configuration and Peripherals

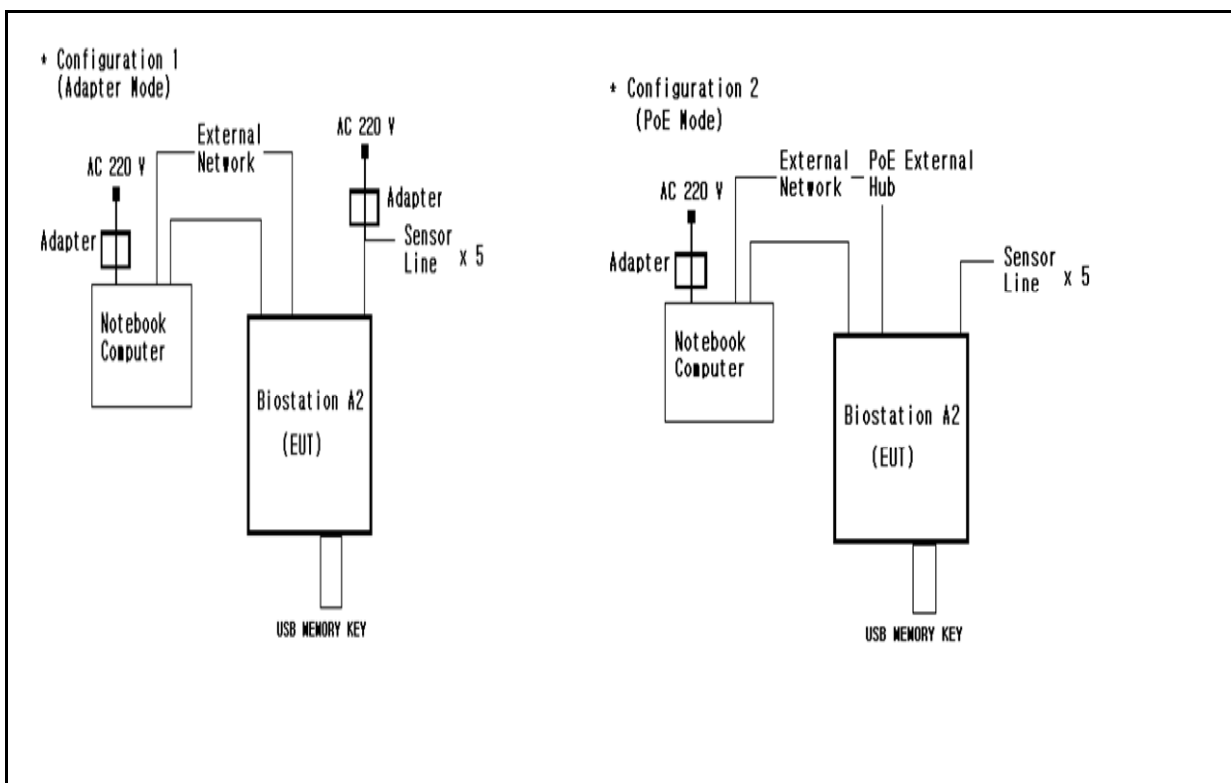



4.3 EUT and Support equipment

(Mode 1)

Equipment Name	Model Name	S/N	Manufacturer	Remark (FCC ID)
Biostation A2	BSA2-OMPW	NONE	Suprema Inc.	EUT
USB Memory Key	NONE	NONE	NONE	
Adapter	JPW128KA1200N05	NONE	BridgePower Corp.	
Notebook Computer	LG15N54	412NZZA305189	LG Electronics	
Adapter	PA-1900-14	NONE	LITE-ON	
Printer	K10229	NONE	CANON VIETNAM CO.,LTD.	

(Mode 2)

Equipment Name	Model Name	S/N	Manufacturer	Remark (FCC ID)
Biostation A2	BSA2-OMPW	NONE	Suprema Inc.	EUT
USB Memory Key	NONE	NONE	NONE	
Notebook Computer	LG15N54	412NZZA305189	LG Electronics	
Adapter	PA-1900-14	NONE	LITE-ON	
Printer	K10229	NONE	CANON VIETNAM CO.,LTD.	

4.4 Cable Connecting

(Mode 1)

Start Equipment		End Equipment		Cable Standard		Remark
Name	I/O port	Name	I/O port	Length	Shielded	
Biostation A2	USB	USB MEMORY KEY	USB	-	-	
Biostation A2	Power	Adapter	-	1.8	Unshielded	
Biostation A2	LAN	External Network Hub (With PoE Port)	LAN	20.0	Unshielded	
Biostation A2	Jack Line	Sensor Line x 5	-	3.0	Shielded	
Notebook Computer	Power	Adapter	-	2.0	Shielded	
Notebook Computer	LAN	External Network Hub	LAN	20.0	Unshielded	
Notebook Computer	USB	Printer	USB	2.0	Shielded	

(Mode 2)

Start Equipment		End Equipment		Cable Standard		Remark
Name	I/O port	Name	I/O port	Length	Shielded	
Biostation A2	USB	USB MEMORY KEY	USB	-	-	
Biostation A2	LAN	External Network Hub (With PoE Port)	LAN	20.0	Unshielded	
Biostation A2	Jack Line	Sensor Line x 5	-	3.0	Shielded	
Notebook Computer	Power	Adapter	-	2.0	Shielded	
Notebook Computer	LAN	External Network Hub	LAN	20.0	Unshielded	
Notebook Computer	USB	Printer	USB	2.0	Shielded	

**Estech Co., Ltd.**

347-69, Jungbu-daero 147beon-gil, Majang-myeon,
Icheon-si, Gyeonggi-do 467-811, R. O. Korea
TEL : +82 31 6318037 FAX : +82 31 6318039 www.estech.co.kr

5. Measurement of radiated disturbance

Above 30 MHz Electric Field strength was measured in accordance with FCC PART 15 Subpart B. The test setup was made according to ANSI C 63.4 (2009) on an 10 m semi-anechoic chamber, which allows a 3 m distance measurement. The EUT was placed in the center of Plastic table. The height of this table was 0.8 m. The measurement was conducted with both horizontal and vertical antenna polarization. The turntable has fully rotated. For further description of the configuration refer to the picture of the test setup.

5.1 Measurement equipments

Equipment Name	Type	Manufacturer	Serial No.	Next Calibration date
TEST Receiver	ESCI7	ROHDE & SCHWARZ	100916	13-Jan-16
Logbicon Antenna	VULB 9168	SCHWARZBECK	237	4-Mar-16
Turn Table	DT3000-2t	Innco System GmbH	N/A	-
Antenna Mast	MA4000-EP	Innco System GmbH	N/A	-
PREAMPLIFIER	8449B	AGILENT	3008A00595	13-Jan-16
Test Receiver	ESPI7	ROHDE & SCHWARZ	100185	13-Jan-16
Horn Antenna	BBHA 9120D	SCHWARZBECK	352	7-May-16
Turn Table	DT1500-S	Innco System GmbH	N/A	-
Antenna Mast	MA4000-EP	Innco System GmbH	N/A	-
Antenna Master & Turn table controller	CO2000-P	Innco System GmbH	CO2000/642 /28051111/L	-

5.2 Environmental Condition

Below 1 GHz –Test Place : 10 m Semi-anechoic chamber

(Mode 1)

Temperature (°C) : 21.8 °C
Humidity (% R.H.) : 51.4 % R.H.

(Mode 2)

Temperature (°C) : 21.7 °C
Humidity (% R.H.) : 51.5 % R.H.

Above 1 GHz–Test Place : 3 m Semi-anechoic chamber

(Mode 1)

Temperature (°C) : 21.7 °C
Humidity (% R.H.) : 49.8 % R.H.

(Mode 2)

Temperature (°C) : 20.9 °C
Humidity (% R.H.) : 52.7 % R.H.



Estech Co., Ltd.

347-69, Jungbu-daero 147beon-gil, Majang-myeon,
Icheon-si, Gyeonggi-do 467-811, R. O. Korea
TEL : +82 31 6318037 FAX : +82 31 6318039 www.estech.co.kr

5.3 Test data (Below 1 GHz) (Mode 1)

Test Date : 15-Oct-15

Measurement Distance : 3 m

Frequency (MHz)	Reading (dB μ W)	Position (V/H)	Height (m)	Correction Factor		Result Value(Quasi-peak)		
				Ant Factor (dB)	Cable (dB)	Limit (dB μ W/m)	Result (dB μ W/m)	Margin (dB)
250.00	21.27	H	2.2	11.70	2.70	46.00	35.67	10.33
311.90	18.88	V	1.2	13.73	3.00	46.00	35.62	10.38
450.00	15.84	H	1.8	16.93	3.65	46.00	36.41	9.59
576.00	14.47	H	1.9	19.54	4.10	46.00	38.10	7.90
700.00	15.77	V	1.8	21.10	4.53	46.00	41.40	4.60
800.00	14.14	V	2.2	22.80	4.85	46.00	41.79	4.21
950.00	7.04	H	2.1	24.33	5.37	46.00	36.74	9.26
960.00	7.33	V	1.2	24.40	5.39	46.00	37.12	8.88
Remark	H : Horizontal, V : Vertical *Result Value = Reading + Ant Factor + Cable loss *Margin= Limit - Result *The resolution bandwidth and video bandwidth of test receiver/spectrum analyzer is 120 kHz for Quasi-peak detection							



Estech Co., Ltd.

347-69, Jungbu-daero 147beon-gil, Majang-myeon,
Icheon-si, Gyeonggi-do 467-811, R. O. Korea
TEL : +82 31 6318037 FAX : +82 31 6318039 www.estech.co.kr

(Mode 2)

Test Date : 15-Oct-15

Measurement Distance : 3 m

Frequency (MHz)	Reading (dB μ V)	Position (V/H)	Height (m)	Correction Factor		Result Value(Quasi-peak)		
				Ant Factor (dB)	Cable (dB)	Limit (dB μ V/m)	Result (dB μ V/m)	Margin (dB)
250.00	23.39	V	1.4	11.70	2.70	46.00	37.79	8.21
311.90	20.92	V	2.0	13.73	3.00	46.00	37.66	8.34
450.00	16.14	V	1.7	16.93	3.65	46.00	36.71	9.29
700.00	15.23	H	1.5	21.10	4.53	46.00	40.86	5.14
800.00	12.84	H	1.2	22.80	4.85	46.00	40.49	5.51
Remark	H : Horizontal, V : Vertical *Result Value = Reading + Ant Factor + Cable loss *Margin= Limit - Result *The resolution bandwidth and video bandwidth of test receiver/spectrum analyzer is 120 kHz for Quasi-peak detection							



Estech Co., Ltd.

347-69, Jungbu-daero 147beon-gil, Majang-myeon,
Icheon-si, Gyeonggi-do 467-811, R. O. Korea
TEL : +82 31 6318037 FAX : +82 31 6318039 www.estech.co.kr

5.4 Test data (Above 1 GHz) (Mode 1)

Test Date : 16-Oct-15

Measurement Distance : 3 m

Frequency (MHz)	Reading (dB μ V)	Position (V/H)	Height (m)	Correction Factor		Result Value		
				Ant Factor (dB)	Cable (dB)	Limit (dB μ V/m)	Result (dB μ V/m)	Margin (dB)
Peak(RBW:1 MHz VBW:1 MHz)								
1056.00	52.00	H	1.0	25.21	-31.78	74.00	45.43	28.57
1056.00	51.21	V	1.1	25.21	-31.78	74.00	44.64	29.36
1104.00	52.04	H	1.0	25.26	-31.59	74.00	45.71	28.29
1104.00	50.52	V	1.1	25.26	-31.59	74.00	44.19	29.81
1128.00	51.71	H	1.1	25.28	-31.49	74.00	45.50	28.50
1128.00	51.35	V	1.0	25.28	-31.49	74.00	45.14	28.86
Average(RBW:1 MHz VBW:10 Hz)								
1056.00	45.75	H	1.0	25.21	-31.78	54.00	39.18	14.82
1056.00	43.11	V	1.1	25.21	-31.78	54.00	36.54	17.46
1104.00	47.86	H	1.0	25.26	-31.59	54.00	41.53	12.47
1104.00	46.51	V	1.1	25.26	-31.59	54.00	40.18	13.82
1128.00	47.11	H	1.1	25.28	-31.49	54.00	40.90	13.10
1128.00	46.40	V	1.0	25.28	-31.49	54.00	40.19	13.81
Remark	<p>H : Horizontal, V : Vertical * Result Value = Reading + Ant Factor + Cable loss - Amplifier Gain * Margin= Limit - Result * The resolution bandwidth and video bandwidth of spectrum analyzer is 1 MHz and 10 Hz for average detection at frequency above 1 GHz.</p> <p>*Application method of the highest frequency is in the following *Highest frequency of the EUT is less than 108 MHz, the measurement shall only be made up to 1 GHz. *Highest frequency of the EUT is between 108 MHz and 500 MHz, the measurement shall only be made up to 2 GHz. *Highest frequency of the EUT is between 500 MHz and 1 GHz, the measurement shall only be made up to 5 GHz. *Highest frequency of the EUT is above 1 GHz, the measurement shall be made up to 5 times the highest frequency or 40 GHz.</p>							



Estech Co., Ltd.

347-69, Jungbu-daero 147beon-gil, Majang-myeon,
Icheon-si, Gyeonggi-do 467-811, R. O. Korea
TEL : +82 31 6318037 FAX : +82 31 6318039 www.estech.co.kr

(Mode 2)

Test Date : 16-Oct-15

Measurement Distance : 3 m

Frequency (MHz)	Reading (dB μ V)	Position (V/H)	Height (m)	Correction Factor		Result Value		
				Ant Factor (dB)	Cable (dB)	Limit (dB μ V/m)	Result (dB μ V/m)	Margin (dB)
Peak(RBW:1 MHz VBW:1 MHz)								
1056.00	51.76	H	1.1	25.21	-31.78	74.00	45.19	28.81
1056.00	52.22	V	1.1	25.21	-31.78	74.00	45.65	28.35
1080.00	51.99	H	1.0	25.24	-31.68	74.00	45.54	28.46
1080.00	52.74	V	1.1	25.24	-31.68	74.00	46.29	27.71
1104.00	51.31	H	1.0	25.26	-31.59	74.00	44.98	29.02
1104.00	51.95	V	1.0	25.26	-31.59	74.00	45.62	28.38
Average(RBW:1 MHz VBW:10 Hz)								
1056.00	47.75	H	1.1	25.21	-31.78	54.00	41.18	12.82
1056.00	48.25	V	1.1	25.21	-31.78	54.00	41.68	12.32
1080.00	48.56	H	1.0	25.24	-31.68	54.00	42.11	11.89
1080.00	48.96	V	1.1	25.24	-31.68	54.00	42.51	11.49
1104.00	48.34	H	1.0	25.26	-31.59	54.00	42.01	11.99
1104.00	48.24	V	1.0	25.26	-31.59	54.00	41.91	12.09
Remark	<p>H : Horizontal, V : Vertical * Result Value = Reading + Ant Factor + Cable loss - Amplifier Gain * Margin= Limit - Result * The resolution bandwidth and video bandwidth of spectrum analyzer is 1 MHz and 10 Hz for average detection at frequency above 1 GHz.</p> <p>*Application method of the highest frequency is in the following *Highest frequency of the EUT is less than 108 MHz, the measurement shall only be made up to 1 GHz. *Highest frequency of the EUT is between 108 MHz and 500 MHz, the measurement shall only be made up to 2 GHz. *Highest frequency of the EUT is between 500 MHz and 1 GHz, the measurement shall only be made up to 5 GHz. *Highest frequency of the EUT is above 1 GHz, the measurement shall be made up to 5 times the highest frequency or 40 GHz,</p>							



Estech Co., Ltd.

347-69, Jungbu-daero 147beon-gil, Majang-myeon,
Icheon-si, Gyeonggi-do 467-811, R. O. Korea
TEL : +82 31 6318037 FAX : +82 31 6318039 www.estech.co.kr

6. Measurement of conducted disturbance

The continuous disturbance voltage of AC Mains in the frequency from 0.15 MHz to 30 MHz was measured in accordance to FCC PART 15 Subpart B . The test setup was made according to ANSI C 63.4 (2009) in a shielded room. The EUT was placed on a non-conductive table at least 0.8 m above the ground plan. A grounded vertical reference plane was positioned in a distance of 0.4 m from the EUT. The distance from the EUT to other metal surfaces was at least 0.8 m. The EUT was only earthen by its power cord through the line impedance stabilizing network. The power cord has been bundled to a length of 1.0 m. The test receiver with Quasi Peak detector complies with CISPR 16.

6.1 Measurement equipments

Equipment Name	Type	Manufacturer	Serial No.	Next Calibration date
Test Receiver	ESPI	Rohde & Schwarz	100005	13-Jan-16
LISN	ENV 216	ROHDE & SCHWARZ	101231	20-Aug-16
LISN	ESH3-Z5	Rohde & Schwarz	836679/025	13-Jan-16
Pulse Limiter	ESH3-Z2	Rohde & Schwarz	NONE	13-Jan-16

6.2 Environmental Condition

Test Place : Shielded Room
Temperature (°C) : 22.2 °C
Humidity (% R.H.) : 46.7 % R.H.



Estech Co., Ltd.

347-69, Jungbu-daero 147beon-gil, Majang-myeon,
Icheon-si, Gyeonggi-do 467-811, R. O. Korea
TEL : +82 31 6318037 FAX : +82 31 6318039 www.estech.co.kr

6.3 Test data

Test Date : 13-Oct-15

Frequency (MHz)	Correction Factor		Line (H/N)	Quasi-peak Value			Cispr Average Value		
	Lisn (dB)	Cable (dB)		Limit (dB μ V)	Reading (dB μ V)	Result (dB μ V)	Limit (dB μ V)	Reading (dB μ V)	Result (dB)
0.19	0.10	0.13	N	64.04	37.77	38.00	54.04		
0.20	0.11	0.13	H	63.61	36.65	36.89	53.61		
0.26	0.10	0.13	N	61.43	31.78	32.02	51.43		
8.38	0.34	0.31	H	60.00	35.03	35.68	50.00		
8.99	0.35	0.32	H	60.00	40.30	40.96	50.00		
11.18	0.41	0.35	H	60.00	27.97	28.73	50.00		
Remark	H : Hot Line, N : Neutral Line *Correction Factor = Lisn + Cable *Result = Correction Factor + Reading								



Estech Co., Ltd.

347-69, Jungbu-daero 147beon-gil, Majang-myeon,
Icheon-si, Gyeonggi-do 467-811, R. O. Korea
TEL : +82 31 6318037 FAX : +82 31 6318039 www.estech.co.kr

7. Photographs of test setup

7.1 Setup for Radiated Test : (30 ~ 1 000) MHz (Mode 1)

[Front]

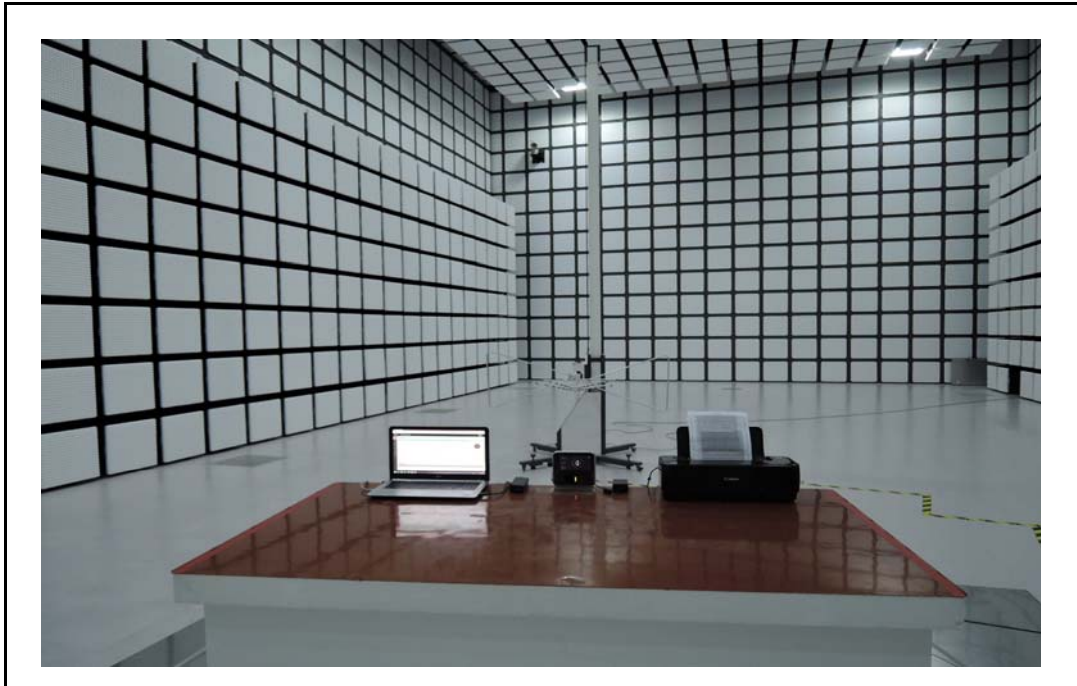

[Rear]

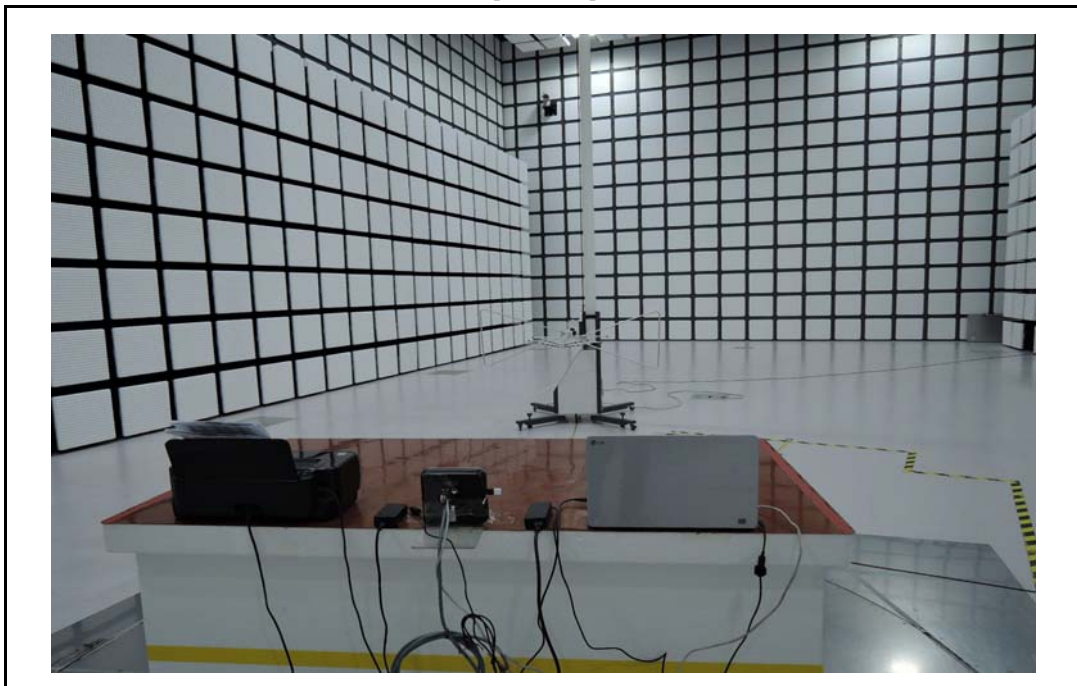



Estech Co., Ltd.

347-69, Jungbu-daero 147beon-gil, Majang-myeon,
Icheon-si, Gyeonggi-do 467-811, R. O. Korea
TEL : +82 31 6318037 FAX : +82 31 6318039 www.estech.co.kr

7. Photographs of test setup

(Mode 2)

[Front]

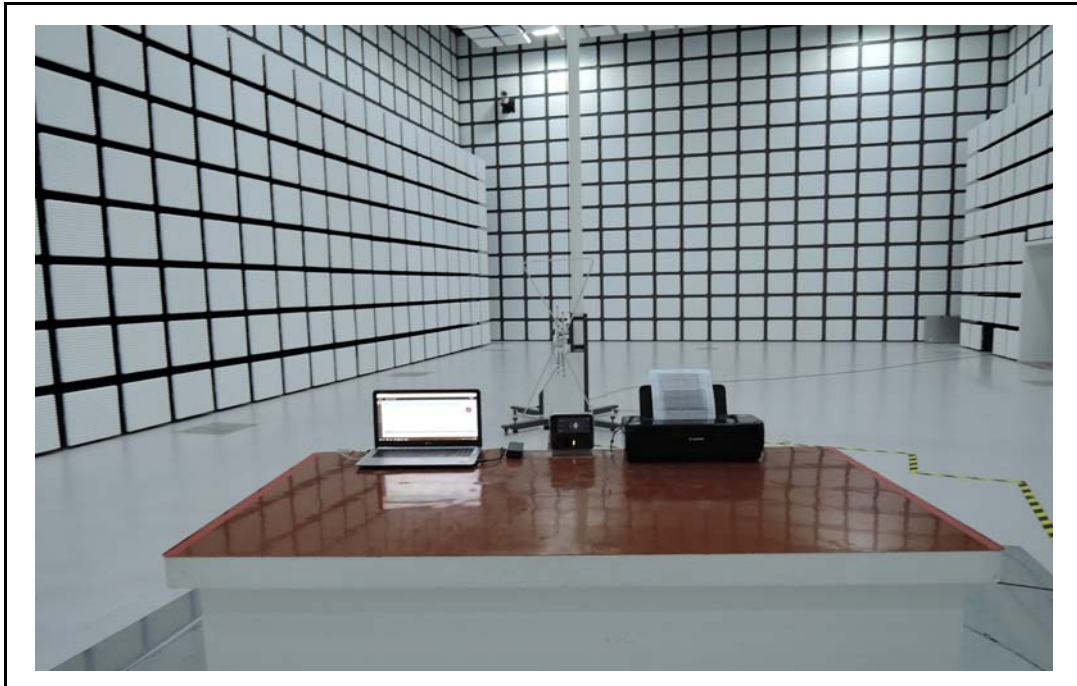

[Rear]

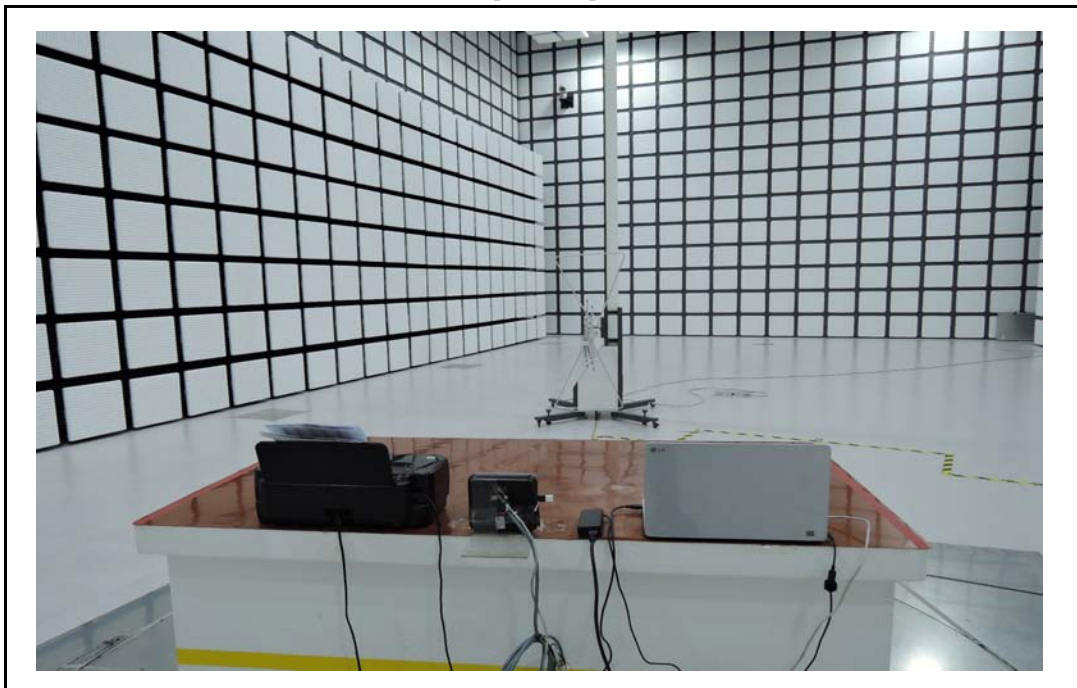



Estech Co., Ltd.

347-69, Jungbu-daero 147beon-gil, Majang-myeon,
Icheon-si, Gyeonggi-do 467-811, R. O. Korea
TEL : +82 31 6318037 FAX : +82 31 6318039 www.estech.co.kr

7.2 Setup for Radiated Test : above 1 GHz (Mode 1)

[Front]



[Rear]

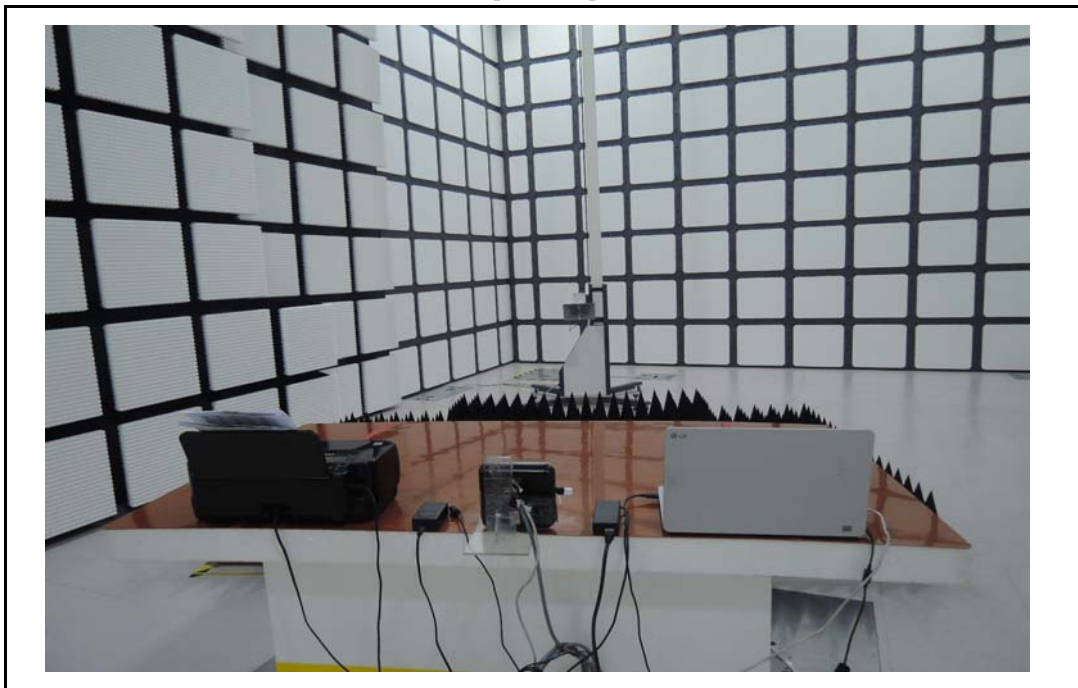



Estech Co., Ltd.

347-69, Jungbu-daero 147beon-gil, Majang-myeon,
Icheon-si, Gyeonggi-do 467-811, R. O. Korea
TEL : +82 31 6318037 FAX : +82 31 6318039 www.estech.co.kr

(Mode 2)

[Front]

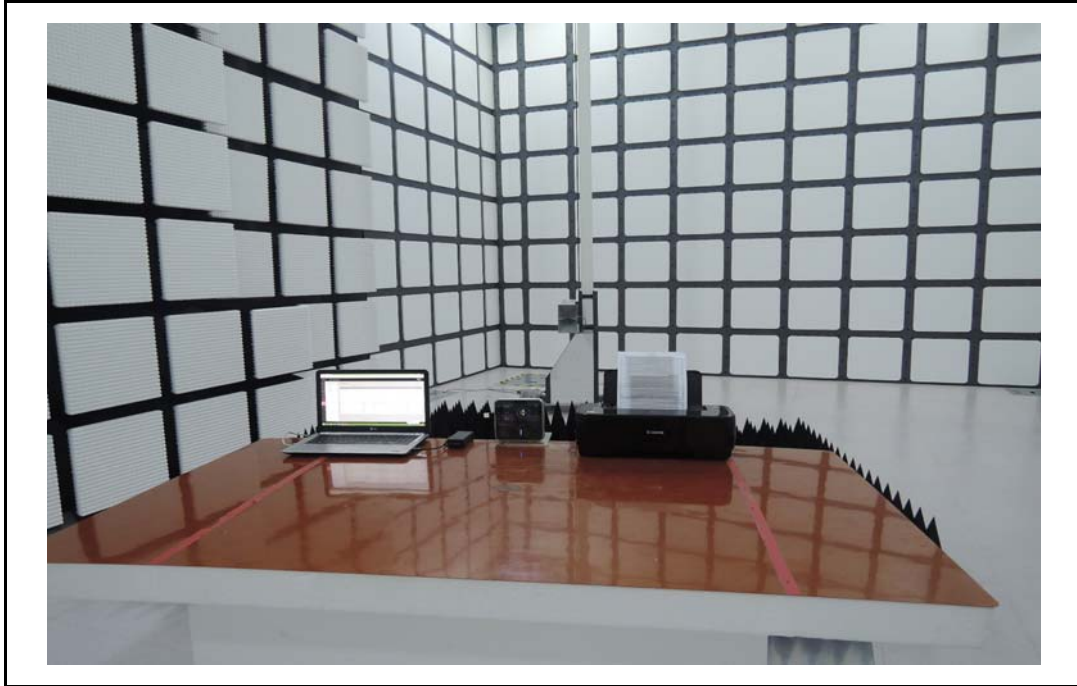

[Rear]

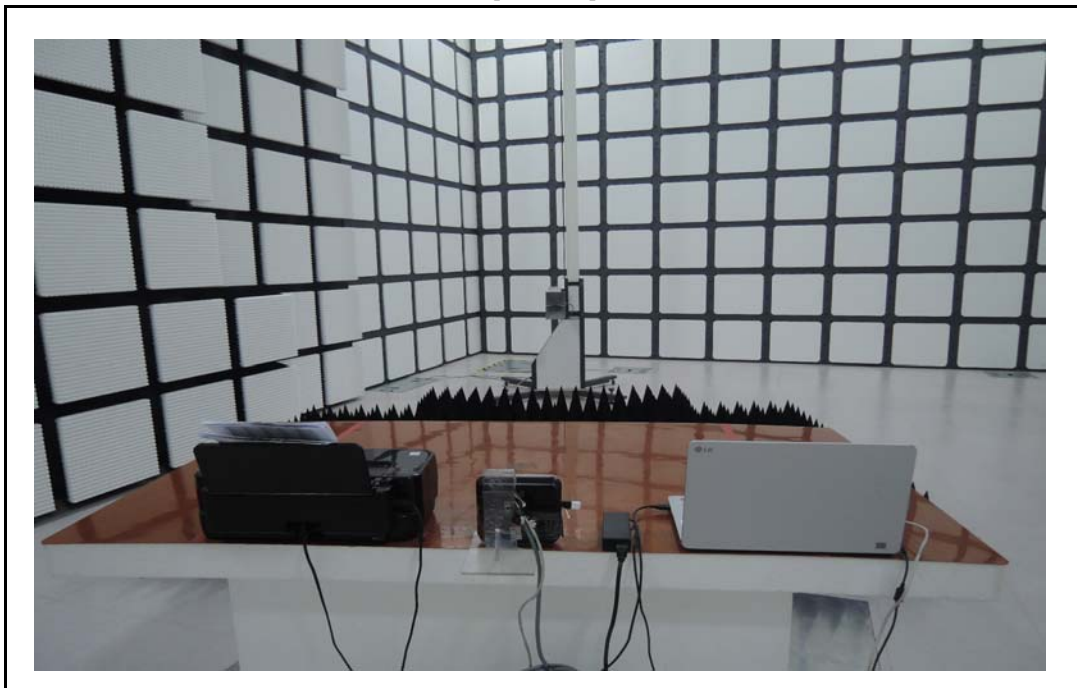



Estech Co., Ltd.

347-69, Jungbu-daero 147beon-gil, Majang-myeon,
Icheon-si, Gyeonggi-do 467-811, R. O. Korea
TEL : +82 31 6318037 FAX : +82 31 6318039 www.estech.co.kr

7.3 Setup for Conducted Test : (0.15 ~ 30) MHz

[Front]



[Rear]





Estech Co., Ltd.

347-69, Jungbu-daero 147beon-gil, Majang-myeon,
Icheon-si, Gyeonggi-do 467-811, R. O. Korea
TEL : +82 31 6318037 FAX : +82 31 6318039 www.estech.co.kr

8. Photographs of EUT

[Front]



[Rear]



Appendix 1. Special diagram

*HOT

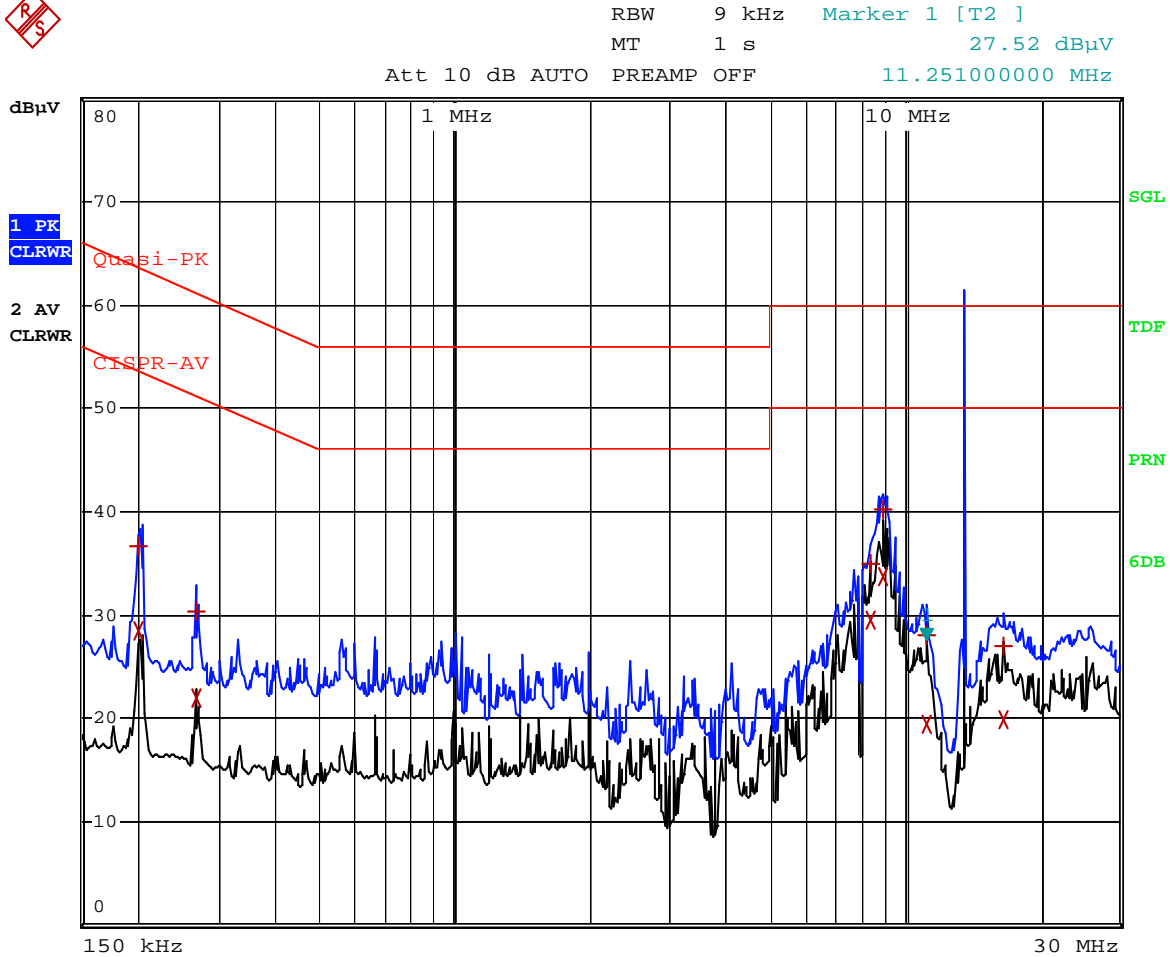

Comment: 15-01897_HOT
Date: 13.OCT.2015 11:16:17

*NEUTRAL

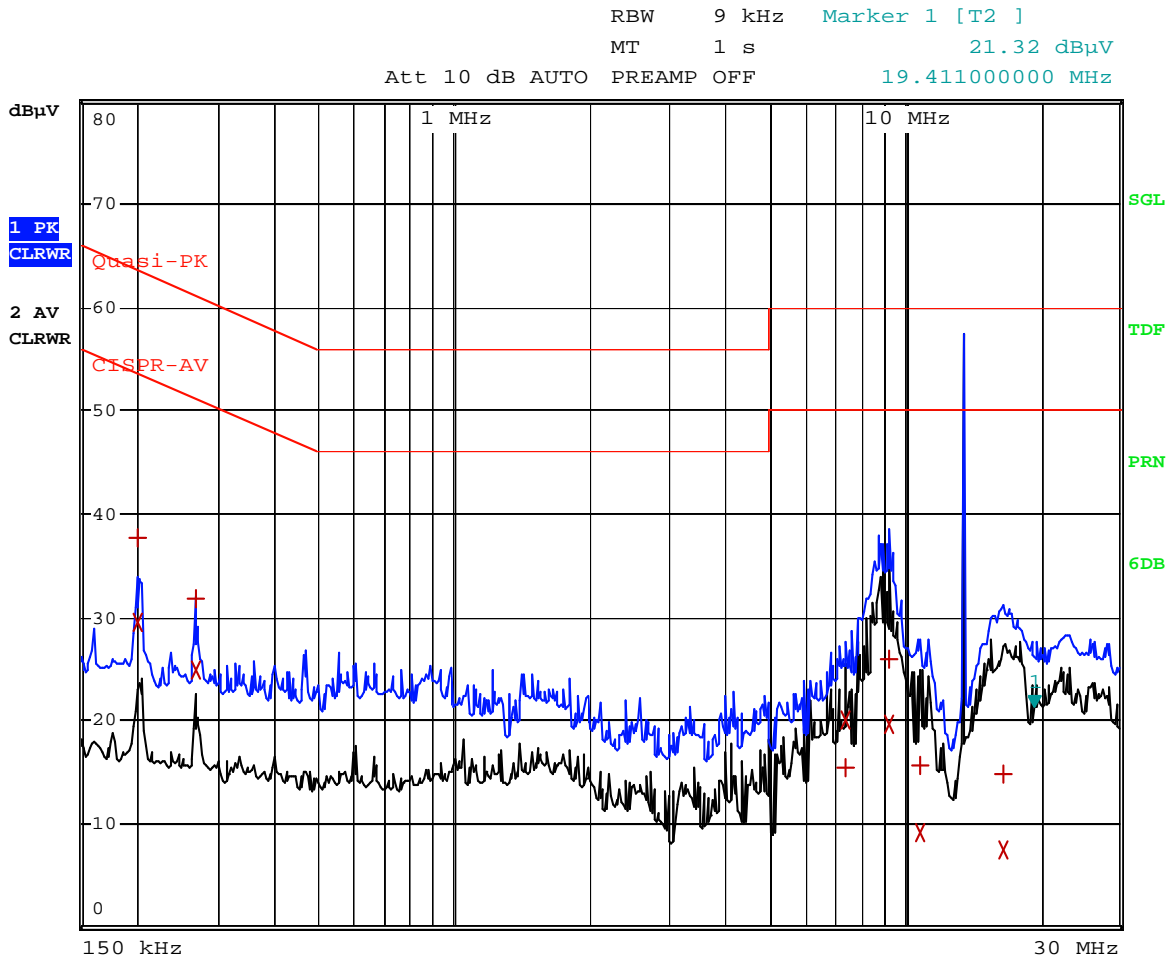

Comment: 15-01897_NEUTRAL
Date: 13.OCT.2015 11:14:01