



Estech
your best partner

Test Report for FCC

FCC ID :TKWB LN2-OAB2

Report Number		ESTRFC2209-006		
Applicant	Company name	Suprema Inc		
	Address	17F-5, Parkview Office Tower, 248, Jeongjail-ro, Bundang-gu, Seongnam-si, Gyeonggi-do, South Korea		
	Telephone	+82-31-710-5633		
Product	Product name	BioLite N2		
	Model No.	BLN2-OAB	Manufacturer	Suprema Inc
	Serial No.	NONE	Country of origin	KOREA
Test date	11-Jul-22 ~ 14-Jul-22		Date of issue	21-Sep-22
Testing location	140-16, Eongmalli-ro, Majang-myeon, Icheon-si, Gyeonggi-do, Rep. of Korea			
Standard	FCC PART 15 Subpart C(15.225), ANSI C 63.10(2013)			
Result		Complied		
Measurement facility registration number		659627		
Tested by	Engineer H.G. Lee		(Signature)	
Reviewed by	Engineering Manager I.k. Hong		(Signature)	
Abbreviation	OK, Pass = Complied, Fail = Failed, N/A = not applicable			
<p>* Note</p> <ul style="list-style-type: none"> - This test report is not permitted to copy partly without our permission - This test result is dependent on only equipment to be used - This test report is not related to KOLAS accreditation - Additional models name:BLN2-PAB, BLN2-ODB - Basic and additional mode are same products, only model name are different 				



Contents

1. Laboratory Information	3
2. Description of EUT	4
3. Test Standards	6
4. Measurement condition	7
5.20 dB Bandwidth	9
5.1 Procedure	9
5.2 Test instruments and measurement setup	9
5.3 Test data.....	9
6. Frequency Tolerance	10
6.1 Procedure	10
6.2 Equipments lists	10
6.3 Frequency stability Data	11
7. Measurement of radiated disturbance	12
7.1 Radiated emission limits, general requirements	12
7.2 Measurement equipment	12
7.3 Environmental conditions	12
7.4 Test data(9 kHz ~30 MHz)	13
7.5 Test data(30 MHz ~ 1 GHz)	14
7.6 Test data(Above 1 GHz)	15
8. Measurement of conducted disturbance	16
8.1 Measurement equipment	16
8.2 Environmental conditions	16
8.3 Test data	17
Appendix 1. Special diagram	
Appendix 2. Special diagram	
Appendix 3. Special diagram	
Appendix 4. Antenna Requirement	



1. Laboratory Information

1.1 General

This EUT (Equipment Under Test) has been shown to be capable of compliance with the applicable technical standards and is tested in accordance with the measurement procedures as indicated in this report. ESTECH Lab attests to accuracy of test data. All measurement reported herein were performed by ESTECH Co., Ltd.

ESTECH Lab assume full responsibility for the completeness of these measurements and vouch for the qualifications of all persons taking them.

1.2 Test Lab.

Corporation Name : ESTECH Co., Ltd.

Head Office : Suite 1015 World Meridian II, 123 Gasan Digital 2-ro, Geumcheon-gu,
Seoul 153-759, R. O. Korea

EMC/Telecom/Safety Test Lab : 140-16, Eongmalli-ro, Majang-myeon, Icheon-si, Gyeonggi-do,
Rep. of Korea

1.3 Official Qualification(s)

MSIP : Granted Accreditation from Ministry of Information & Communication for EMC, Safety and Telecommunication

KOLAS : Accredited Lab By Korea Laboratory Accreditation Schema base on CENELEC requirements

FCC : Conformity Assessment Body(CAB) with registration number 659627 under APEC TEL MRA between the RRA and the FCC

VCCI : Granted Accreditation from Voluntary Control Council for Interference from ITE



2. Description of EUT

2.1 Summary of Equipment Under Test

Product : BioLite N2
 Model Number : BLN2-OAB
 Serial Number : NONE
 Manufacturer : Suprema Inc
 Country of origin : KOREA
 Operating Frequency : 13.56 MHz
 Antenna Type : PCB Patten Antenna
 Modulation Type : ASK
 Channel : 1 ch
 Power Rating : INPUT: AC(100 – 240) V, (50–60)Hz, 400 mA
 : OUTPUT: DC 12 V,
 Receipt Date : 17-Jun-22
 X-tal list(s) or : The highest operating frequency is 13.56 MHz
 Frequencies generated

2.2 General descriptions of EUT

Category	Feature	Description
Credential	Biometric	Fingerprint
	RF Option	<ul style="list-style-type: none"> • BLN2-ODB: 125kHz EM & 13.56MHz MIFARE, MIFARE Plus, DESFire/EV1, NFC & 2.4GHz BLE • BLN2-OAB: 125kHz EM, HID Prox & 13.56Mhz MIFARE, MIFARE Plus, DESFire/EV1, FeliCa, iCLASS SE/SR, NFC & 2.4GHz BLE
	RF read range**	MIFARE/DESFire: 50 mm, EM/FeliCa: 30 mm
	Mobile	NFC, BLE
General	CPU	1.2 GHz
	Memory	4 GB Flash + 64 Mb RAM
	Crypto chip	Supported
	LCD type	1.77" color TFT LCD
	LCD resolution	160 x 128 pixels
	Sound	6-bit
	Operating temperature	<ul style="list-style-type: none"> • BLN2-ODB, BLN2-OAB, BLN2-OD, BLN2-OA: -20°C to 50°C • BLN2-PAB: -10°C to 50°C
	Dimension (W x H x D)	58 mm x 190 mm x 44 mm (Bottom) / 34 mm (Top)
	Weight	<ul style="list-style-type: none"> • Device: 255 g • Bracket (Including washer and bolt): 57 g
	IP rating	IP67

Category	Feature	Description
Fingerprint	Image Dimension	272 x 320 pixels
	Image bit depth	8 bits, 256 gray scale
	Resolution	500 dpi
	Template	SUPREMA / ISO19794-2 / ANSI-378
	Extractor/Matcher	MINEX certified and compliant
Capacity	Max. User	10,000
	Max. Credential (1:N)	10,000
	Max. Credential (1:1)	20,000 (Two templates per finger)
	Max. Text Log	20,000 (Two templates per finger)
Interface	Ethernet	Supported (10/100 Mbps, auto MDI/MDI-X)
	RS-485	1 ch Master / Slave (Selectable)
	Wiegand	1 ch Input / Output (Selectable)
	TTL input	2 ch Inputs
	Relay	1 Relay
	Tamper	Supported
Electrical	Power	Voltage: DC 12 V, Current: Max. 400 mA
	Switch input VIH	Min.: 3 V / Max.: 5 V
	Switch input VIL	Max.: 1 V
	Switch Pull-up resistance	4.7 k Ω (The input pots are pulled up with 4.7 k Ω .)
	Wiegand output VOH	More than 4.8 V
	Wiegand output VOL	Less than 0.2 V
	Wiegand output Pull-up resistance	Internally pulled up with 1 k Ω
	Relay	2 A @ 30 VDC Resistive load 1 A @ 30 VDC Inductive load

* RF read range will vary depending on the installation environment.

3. Test Standards

Test Standard : FCC PART 15 Subpart C(15.225)

This Standard sets out the regulations under which an intentional, unintentional, or incidental radiator may be operated without an individual license. It also contains the technical specifications, administrative requirements and other conditions relating to the marketing of Part 15 devices.

Test Method : ANSI C 63.10 (2013)

This standard sets forth uniform methods of measurement of radio-frequency (RF) signals and noise emitted from both unintentional and intentional emitters of RF energy in the frequency range 9 kHz to 40 GHz. Methods for the measurement of radiated and AC power-line conducted radio noise are covered and may be applied to any such equipment unless otherwise specified by individual equipment requirements. These methods cover measurement of certain devices that deliberately radiate energy, such as intentional emitters, but does not cover licensed transmitters. This standard is not intended for certification/approval of avionic equipment or for industrial, scientific, and medical (ISM) equipment. These methods apply to the measurement of individual units or systems comprised of multiple units.

Summary of Test Results

Applied Standard : 47 CFR Part 15, Subpart C				
Standard	Test Type	Result	Remark	Limit
15.203	Antenna Requirement	Pass	Meet the requirement	
15.207	AC Power Conducted Emission	Pass	Meet the requirement	
15.225(a)	Radiated Emission (13.553 ~13.567) MHz	Pass	Meet the requirement	15,848 uV/m at 30 m
15.225(b)	Radiated Emission (13.410 ~13.553 , 13.567 ~ 13.710) MHz	N/A	-	334 uV/m at 30 m
15.225(c)	Radiated Emission (13.110 ~13.410 , 13.710 ~ 14.010) MHz	N/A	-	106 uV/m at 30 m
15.225(d)	Apply section 15.209 (out side band of the 13.110 ~14.010) MHz	Pass	Meet the requirement	
15.225(e)	Frequency stability	Pass	Meet the requirement	
15.215(c)	20dB Bandwidth	Pass	Meet the requirement	

4. Measurement Condition

4.1 EUT Operation.

-The EUT was tested, under transmission / receiving

1. Normal communication with RF OUT Frequency(13.56 MHz).
2. Monitoring the operation status of frequency by using RF CARD.

4.2 Configuration and Peripherals

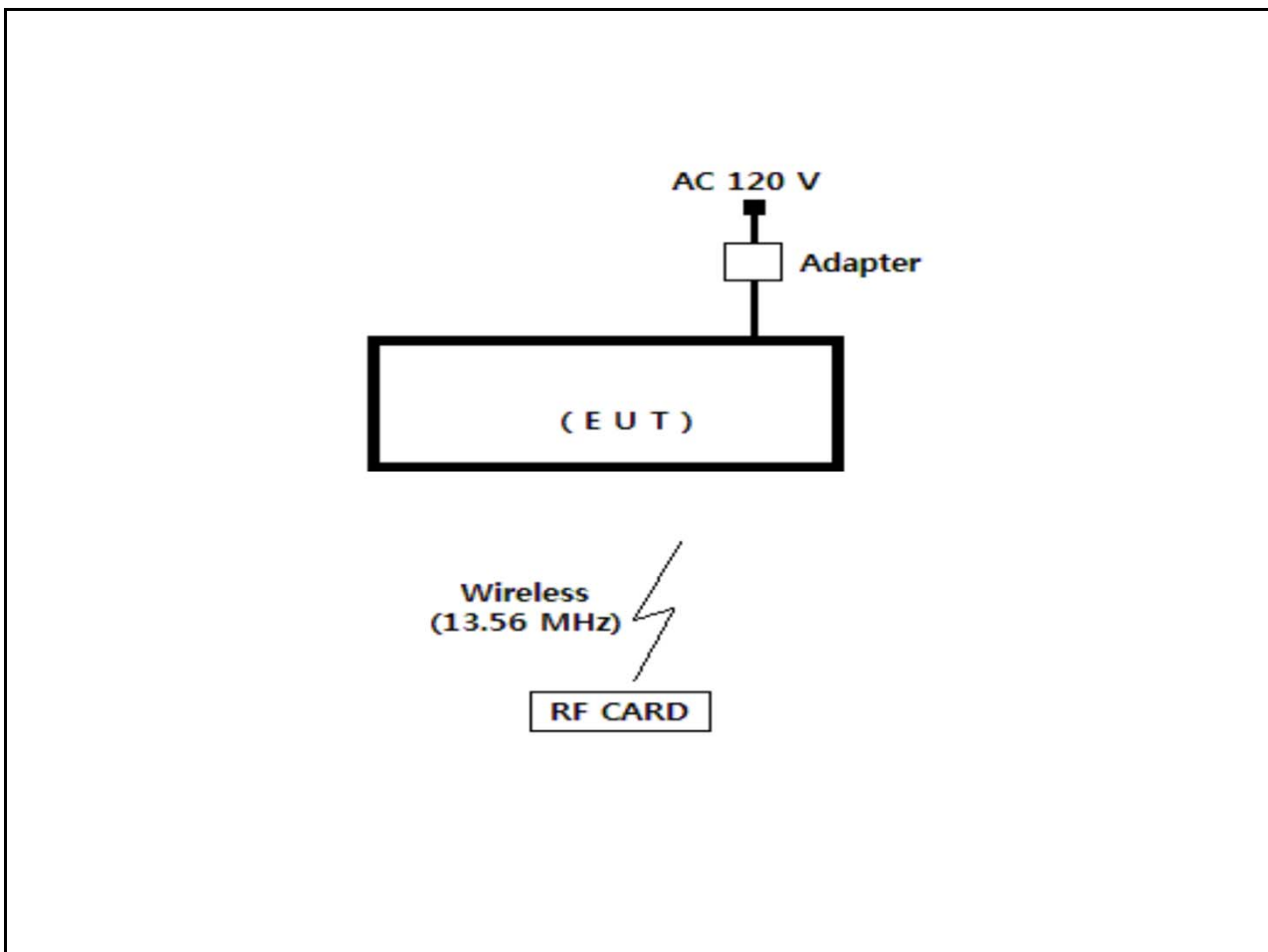



4.3 EUT and Support equipment

Equipment Name	Model Name	S/N	Manufacturer	Remark (FCC ID)
BioLite N2	BLN2-OAB	NONE	KOREA	EUT
Adapter	KPL-060M-VI	NONE	Channel Well Technology (Guangzhou) Co.,Ltd.	

4.4 Cable Connecting

Start Equipment		End Equipment		Cable Standard		Remark
Name	I/O port	Name	I/O port	Length	Shielded	
BioLite N2	Power	Adapter	-	2.0	Unshielded	
BioLite N2	Wireless (13.56 MHz)	RF CARD	Wireless (13.56 MHz)	-	-	

5. 20 dB Bandwidth

5.1 Procedure

The transmitter output was connected to the spectrum analyzer. The bandwidth of the fundamental frequency was measured by spectrum analyzer. The 20 dB bandwidth is defined as the bandwidth at 20 dB below from peak power point.

5.2 20dB Bandwidth setup

The spectrum analyzer is set to as following

RBW: 30 Hz

VBW: 300 Hz

Span: 5 kHz

Sweep:suitable duration based on the EUT specification

20dB Bandwidth Test Instruments

Decription	Model	Serial Number	Cal. Due Data
Signal Analyzer	FSV40	100939	28-Nov-22

5.3 Test Data

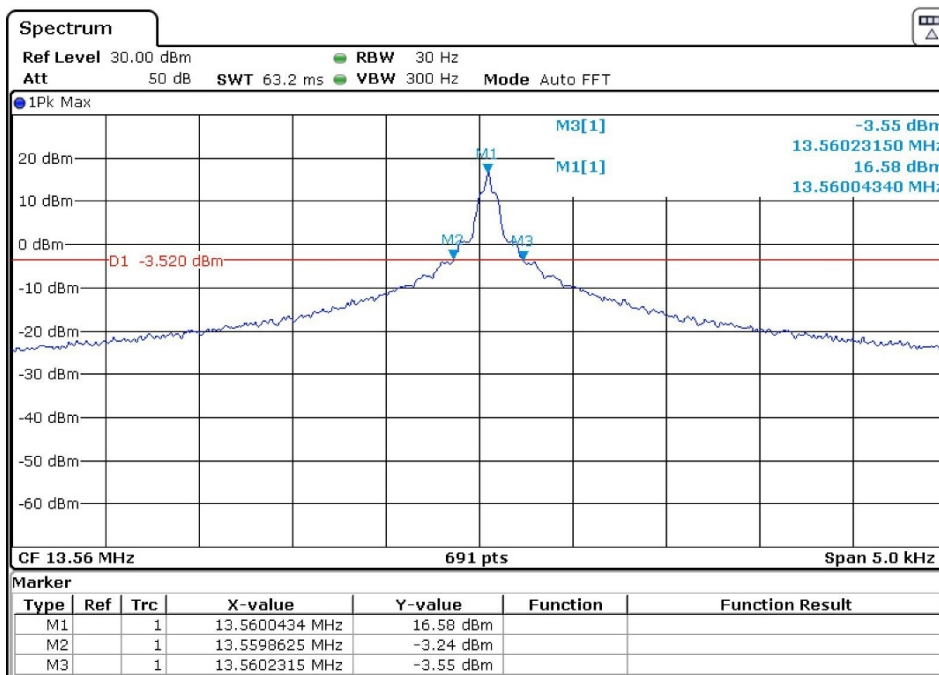



6. Frequency Tolerance

6.1 Procedure

The frequency stability of the transmitter is measured by:

- a) Temperature: The temperature is varied from $-20\text{ }^{\circ}\text{C}$ to $+50\text{ }^{\circ}\text{C}$ using an environmental chamber.
- b) Primary Supply Voltage: The primary supply voltage is varied from 85 % to 115 % of the voltage normally at the input to the device or at the power supply terminals if cables are not normally supplied.

The frequency tolerance of the carrier shall be maintained within $\pm 0.01\%$ of the operating frequency.

6.2 Equipment lists

The following test equipments are used during test

Decription	Model	Serial Number	Cal. Due Data
Signal Analyzer	FSV40	100939	29-Nov-22
Temp./Humidity Chamber	SH-642	93014501	29-Nov-22



6.3 Frequency stability Data (Adapter)

Operating Frequency : 13,560,050 Hz
Reference Voltage : 12.00 Vd.c.
Deviation Limit : ± 0.01 %

Voltage (%)	Power (Vdc)	Temperature (°C)	Frequency (Hz)	Deviation (%)
100	12.00	+20 °C(Ref)	13,560,043	-0.000052
100		-20	13,560,029	-0.000155
100		-10	13,560,056	0.000044
100		0	13,560,126	0.000560
100		10	13,559,991	-0.000435
100		20	13,559,625	-0.003134
100		30	13,559,973	-0.000568
100		40	13,560,034	-0.000118
100		50	13,560,027	-0.000170
85		10.20	20	13,560,007
115	13.80	20	13,560,024	-0.000192

7. Measurement of radiated disturbance

The EUT was placed on the top of a rotating table 0.8 m above the ground at a 10 m semi-anechoic chamber. The table was rotated 360° to determine the position of the highest radiation. Then antenna is a loop antenna is fixed at 1 m above the ground to determine the maximum value of the field strength. Both parallel and perpendicular of the antenna are set to make the measurement. For each suspected emission, the EUT was arranged to its worst case and then the table was turned from 0° to 360° to find the maximum reading. The test receiver system was set to Peak Detect Function and Specified Bandwidth with Maximum Hold Mode.

7.1 Radiated emission limits, general requirements

Except as provided elsewhere in this Subpart, the emissions from an intentional radiator shall not exceed the field strength levels specified in the following table:

Frequency (MHz)	Distance(Meters)	Field strength @3m (dBuV/m)
0.009 to 0.490	3	2400/F(kHz)
0.490 to 1.705	3	24000/F(kHz)
1.705 to 30	3	30
30 to 88	3	100**
88 to 216	3	150**
216 to 960	3	200**
> 960	3	500

* dBuV/m=20*log(uV/m) * Distance factor=40dB / decade(15.31(f))

7.2 Measurement equipments

Equipment Name	Type	Manufacturer	Serial No.	Next Calibration date
TEST Receiver	ESC17	ROHDE & SCHWARZ	100916	19-Jul-22
Logbicon Antenna	VULB 9168	SCHWARZBECK	193	9-Dec-23
Turn Table	DT3000-2t	Innco System GmbH	N/A	-
Antenna Mast	MA4000-EP	Innco System GmbH	N/A	-
Antenna Master & Turn table controller	CO 3000	Innco System GmbH	CO3000/1138	-
Loop Antenna	HFH2-Z2	ROHDE & SCHWARZ	100188	26-Aug-22

7.3 Environmental Condition

Test Place : 10 m Semi-anechoic chamber

Below 1 GHz

Temperature (°C) : 22.6 °C

Humidity (% R.H.) : 44.1 % R.H.

Test Place : 3 m Semi-anechoic chamber(3 m)

Above 1 GHz-N/A

Temperature (°C) :

Humidity (% R.H.) :



7.4 Test data(9 kHz ~ 30 MHz)

Test Date : 13-Jul-22

Measurement Distance : 3 m

Frequency (MHz)	Reading (dB μ V)	Vertical Position [Angle]	EUT Position	Height (m)	Correction Factor		Result Value(Quasi-Peak)		
					Ant Factor (dB)	Cable (dB)	Limit (dB μ V/m)	Result (dB μ V/m)	Margin (dB)
Below 13.110 MHz									
Noise Floor	-	-	-	-	19.48	0.5	69.5	-	-
13.110 MHz to 13.410 MHz									
Noise Floor	-	-	-	-	19.46	0.5	80.5	-	-
13.410 MHz to 13.552 MHz									
Noise Floor	-	-	-	-	19.46	0.5	90.5	-	-
13.553 MHz to 13.567 MHz									
13.5600	55.50	90.0	X	0.8	19.43	0.6	124.0	75.48	48.52
13.567 MHz to 13.710 MHz									
Noise Floor	-	-	-	-	19.45	0.5	90.5	-	-
13.710 MHz to 14.010 MHz									
Noise Floor	-	-	-	-	19.44	0.6	80.5	-	-
14.010 MHz to 30 MHz									
Noise Floor	-	-	-	-	19.44	0.6	69.5	-	-
Remark	<p>*The 30 m limit was converted to 3 m Limit using square factor(x) as it was found by measurements as follows: *3 m Limit(dBuV/m) = 20log(X)+40log(30/3)= 20log(15848)+40log(30/3) = 124 dBuV *3 m Limit(dBuV/m) = 20log(X)+40log(30/3)= 20log(30)+40log(30/3) = 69.5 dBuV</p> <p>* The EUT was measured for the worst case by rotating of antenna angle. * The EUT performed at X,Y,Z and recorded the worst data in the report.</p>								

7.5 Test data(30 MHz ~ 1 000 MHz)

Test Date : 14-Jul-22

Measurement Distance : 3 m

Frequency (MHz)	Reading (dB μ V)	Position (V/H)	Height (m)	Correction Factor		Result Value(Quasi-peak)		
				Ant Factor (dB)	Cable (dB)	Limit (dB μ V/m)	Result (dB μ V/m)	Margin (dB)
264.00	29.17	V	1.0	12.09	2.34	46.00	43.60	2.40
360.00	24.56	V	1.0	14.70	2.64	46.00	41.90	4.10
408.00	19.68	V	1.0	15.75	2.76	46.00	38.20	7.80
435.00	21.60	V	1.3	16.77	2.93	46.00	41.30	4.70
465.00	19.22	V	1.4	17.18	3.11	46.00	39.50	6.50
630.00	16.63	H	1.0	20.30	3.77	46.00	40.70	5.30
Remark	<p>H : Horizontal, V : Vertical *Result Value = Reading + Antenna + Cable loss *Correction Factor = Ant Factor + Cable *The resolution bandwidth and video bandwidth of test receiver/spectrum analyzer is 120 kHz for Quasi-peak detection</p>							

7.6 Test data (Above 1 GHz) – N / A

Test Date :

Measurement Distance : 3 m

Frequency (MHz)	Reading (dB μ V)	Position (V/H)	Height (m)	Correction Factor		Result Value		
				Ant Factor (dB)	Cable (dB)	Limit (dB μ V/m)	Result (dB μ V/m)	Margin (dB)
Peak(RBW:1 MHz VBW:1 MHz)								
Average(RBW:1 MHz VBW:10 Hz)								
Remark	<p>H : Horizontal, V : Vertical *Reading = receiver reading + Amplifier Gain *CL = Cable Loss–Amplifier Gain *The resolution bandwidth and video bandwidth of spectrum analyzer is 1 MHz and 10 Hz for average detection at frequency above 1 GHz. *This test does not require because the highest operating frequency of the EUT is less than 108 MHz. *Application method of the highest frequency is in the following *Highest frequency of the EUT is less than 108 MHz, the measurement shall only be made up to 1 GHz. *Highest frequency of the EUT is between 108 MHz and 500 MHz, the measurement shall only be made up to 2 GHz. *Highest frequency of the EUT is between 500 MHz and 1 GHz, the measurement shall only be made up to 5 GHz. *Highest frequency of the EUT is above 1 GHz, the measurement shall be made up to 10 times the highest frequency or 40 GHz,</p>							

8. Measurement of conducted disturbance

The continuous disturbance voltage of AC Mains in the frequency from 0.15 MHz to 30 MHz was measured in accordance to FCC Part 15 & ANSI C 63.10 (2013) The test setup was made according to FCC Part 15 & ANSI C 63.10 (2013) in a shielded Room. The EUT was placed on a non-conductive table at least 0.8 m above the ground plan. A grounded vertical reference plane was positioned in a distance of 0.4 m from the EUT. The distance from the EUT to other metal surfaces was at least 0.8 m. The EUT was only earthen by its power cord through the line impedance stabilizing network. The power cord has been bundled to a length of 1.0 m. The test receiver with Quasi Peak detector complies with CISPR 16.

8.1 Measurement equipments

Equipment Name	Type	Manufacturer	Serial No.	Next Calibration date
TEST Receiver	ESHS 30	Rohde & Schwarz	828765/002	29-Jun-23
LISN	ESH2-Z5	Rohde & Schwarz	836679/025	29-Jun-23
Pulse Limiter	ESH3-Z2	Rohde & Schwarz	NONE	29-Jun-23

8.2 Environmental Condition

Test Place : Shielded Room
 Temperature (°C) : 23.6 °C
 Humidity (% R.H.) : 44.8 % R.H.



8.3 Test data

Test Date : 14-Jul-22

Frequency (MHz)	Correction Factor		Line (H/N)	Quasi-peak Value			Average Value		
	Lisn (dB)	Cable (dB)		Limit (dB μ V)	Reading (dB μ V)	Result (dB μ V)	Limit (dB μ V)	Reading (dB μ V)	Result (dB)
0.15	0.11	0.16	H	66.00	29.93	30.20	56.00	19.58	19.85
0.18	0.10	0.17	N	64.35	32.09	32.36	54.35	21.19	21.46
0.45	0.11	0.18	N	56.88	37.01	37.30	46.88	28.84	29.13
2.98	0.16	0.27	N	56.00	30.05	30.48	46.00	28.94	29.37
24.00	0.64	0.42	N	60.00	32.25	33.31	50.00	30.23	31.29
27.12	0.66	0.45	H	60.00	35.35	36.46	50.00	21.08	22.19
Remark	H : Hot Line, N : Neutral Line *Correction Factor = Lisn + Cable *Result = Correction Factor + Reading								

Appendix 1. Special diagram

* Horizontal

RBW 9 kHz
 MT 100 ms
 PREAMP OFF

Att 10 dB

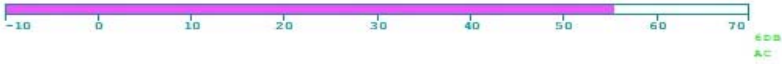
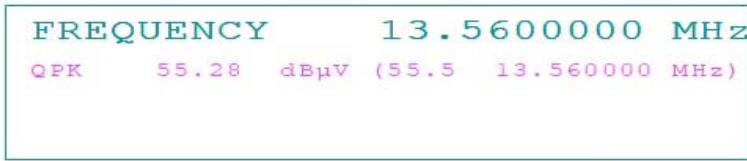

Marker 1 [T1] 1
 56.66 dBμV
 13.560000000 MHz

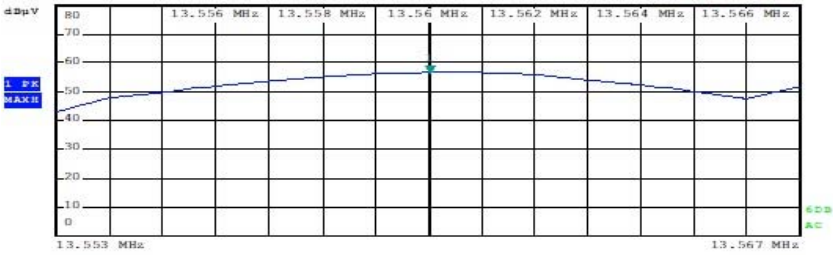

00202

* Horizontal

RBW 10 kHz Marker 1 [T1] 1
 VBW 10 MHz 58.45 dBμV
 SWT 10 ms 13.560000000 MHz

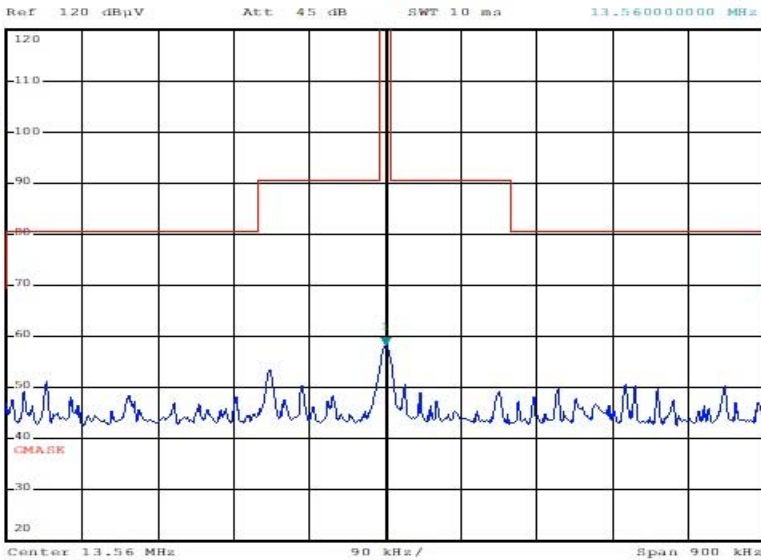

ESTR-22-00202

* Vertical

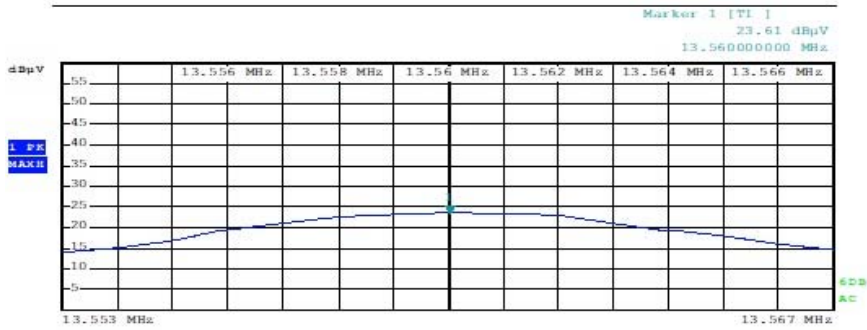

00202

* Vertical

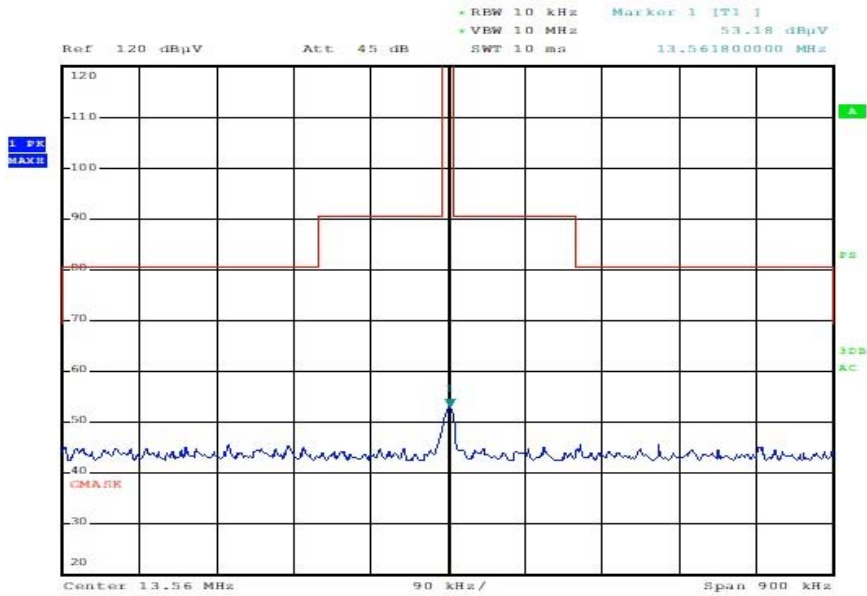

ESTR-22-00202

Appendix 2. Special diagram

* Horizontal

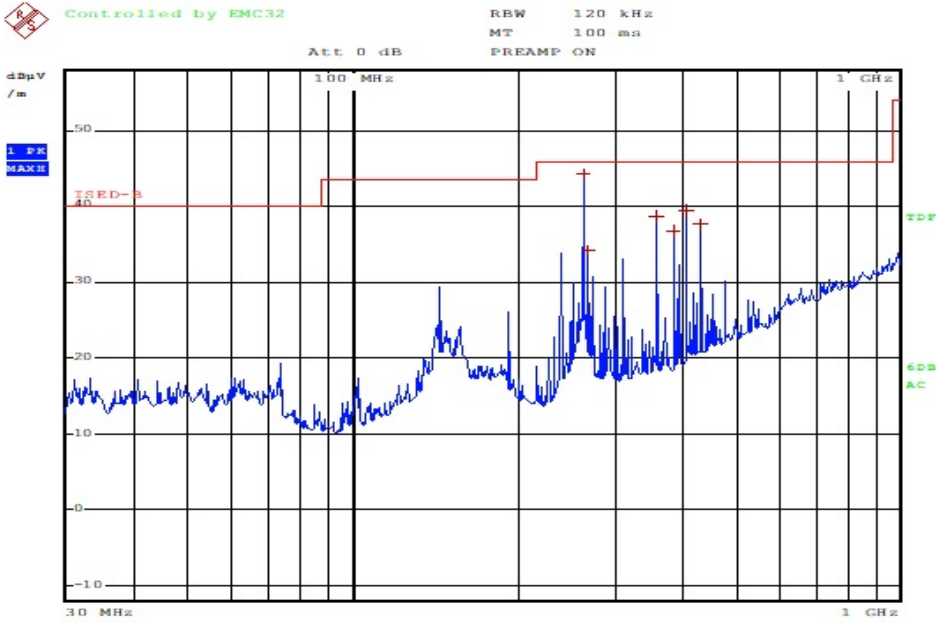

ESTR-22-00202

* Vertical

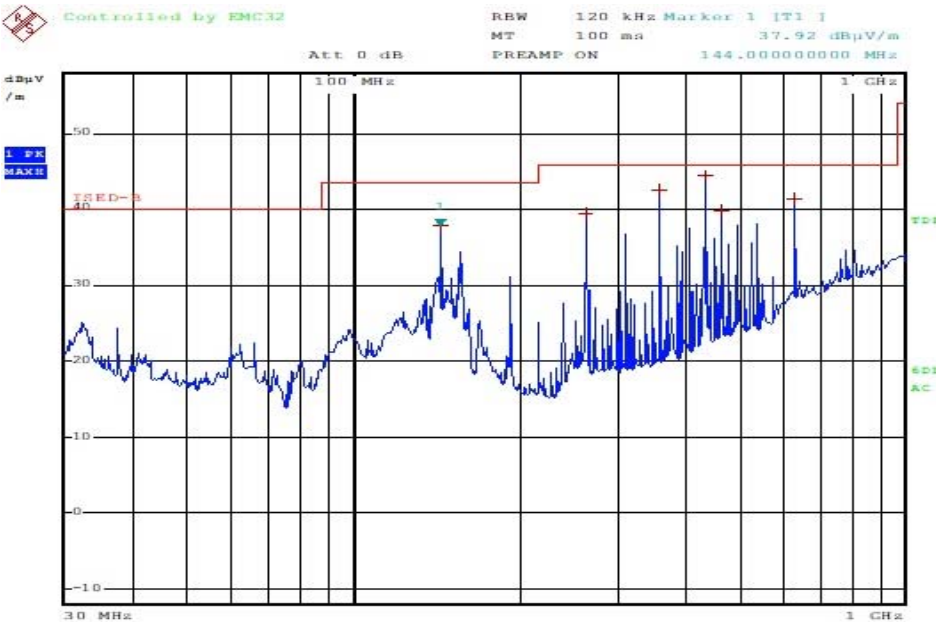

ESTR-22-00202

Appendix 3. Special diagram

* HOT LINE

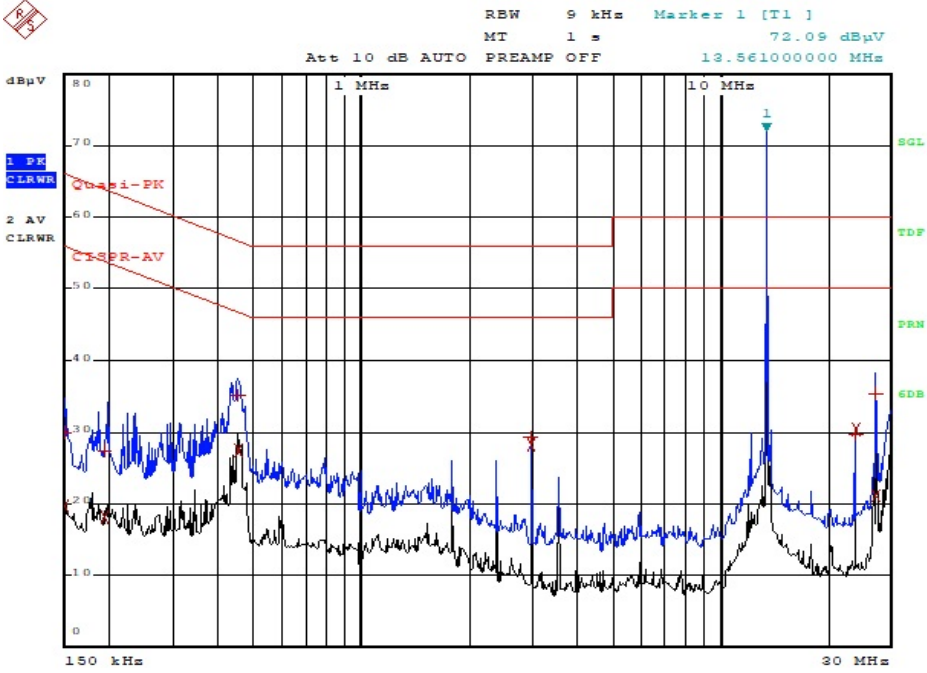

Comment: ESTR-22-00202

* NEUTRAL LINE

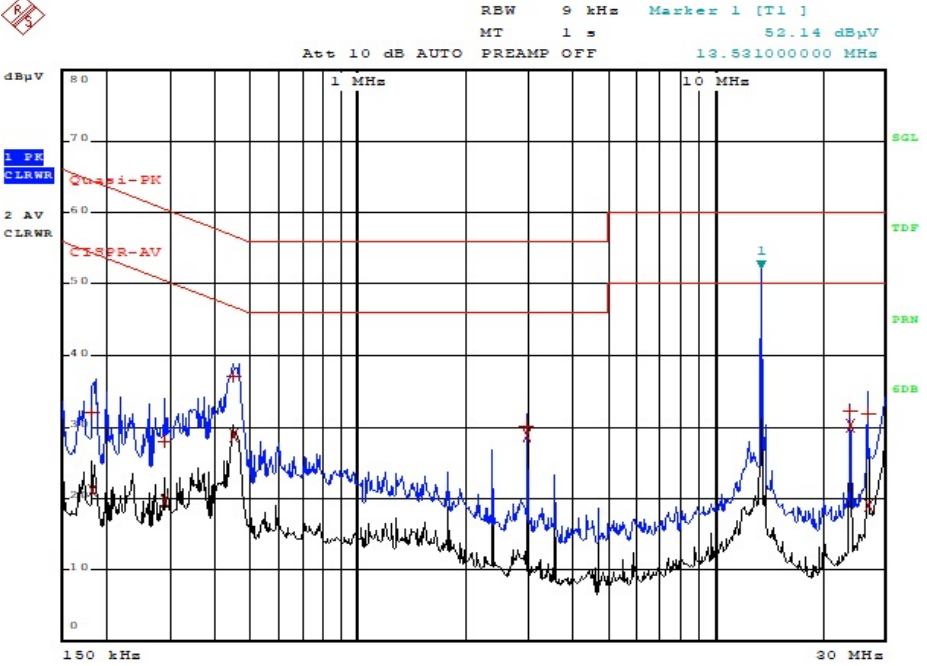

Comment: ESTR-22-00203

Appendix 4. Antenna Requirement

Regulation

According to §15.203, an intentional radiator shall be designed to ensure that no antenna other than that furnished by the responsible party shall be used with the device. The use of a permanently attached antenna or of an antenna that uses a unique coupling to the intentional radiator shall be considered sufficient to comply with the provisions of this Section. The manufacturer may design the unit so that a broken antenna can be replaced by the user, but the use of a standard antenna jack or electrical connector is prohibited.

Result

–Complied

The transmitter has an PCB Antenna.