



RF Test Report

Issued Date: Nov. 14, 2019

Applicant : Maverick Industries, Inc.

Product Type : Intelligent Digital TRULY Wireless FOOD THERMOMETER

Trade Name : MAVERICK

Model Number : BT-30

FCC ID : TKCBT-30

EUT Rated Voltage : DC 3 V, 300 mA (for Intelligent Digital TRULY Wireless FOOD THERMOMETER)
DC 5 V, 500 mA (for Charger)

Test Voltage : 120 Vac / 60 Hz

Receive Date : Nov. 05 , 2019

Test Period : Nov. 06 ~ Nov. 08, 2019

Applicable Standard : FCC 47 CFR PART 15 SUBPART C
ANSI C63.10:2013

Test Result : Complied

Testing Laboratory

A Test Lab Techno Corp.

101-104, 1F, A building, Safflower ridge industrial area,
Taoyuan street, Nanshan district, Shenzhen

Tel : +86-755-23987770 / Fax : +86-755-26637771

<http://www.atl-lab.com.tw/e-index.htm>



American Association for Laboratory Accreditation number: 3464.02

Test Firm MRA designation number: CN1168

Note: This report shall not be reproduced except in full, without the written approval of A Test Lab Techno Corp. This document may be altered or revised by A Test Lab Techno Corp. personnel only and shall be noted in the revision section of the document. The client should not use it to claim product endorsement by A2LA, or any government agencies. The test results in the report only apply to the tested sample.

Approved By : Jet Lu Reviewed By : Louis Shen
 (Manager) (Jet Lu) (Testing Engineer) (Louis Shen)



Revision History

Rev.	Issue Date	Revisions
00	Nov. 14, 2019	Initial Issue

TABLE OF CONTENTS

1	General Information	4
2	EUT Description.....	6
3	Test Methodology.....	7
	3.1. Mode of Operation.....	7
	3.2. EUT Exercise Software	7
	3.3. Configuration of Test System Details.....	8
	3.4. Test Instruments	9
	3.5. Test Site Environment.....	10
4	Measurement Procedure.....	11
	4.1. AC Power Line Conducted Emission Measurement.....	11
	4.2. Radiated Emission Measurement.....	13
	4.3. Maximum Conducted Output Power Measurement.....	17
	4.4. 6dB RF Bandwidth Measurement.....	18
	4.5. Maximum Power Density Measurement	19
	4.6. Out of Band Conducted Emissions Measurement.....	20
	4.7. Antenna Measurement	20
5	Test Results	21
	Annex A. Conducted Emission	21
	Annex B. Conducted Test Results	23
	Annex C. Radiated Emission Measurement	30



1 General Information

1.1 Summary of Test Result

Standard	Item	Result	Remark
15.207	AC Power Conducted Emission	PASS	-----
15.247(d)	Transmitter Radiated Emissions	PASS	-----
15.247(b)(3)	Max. Output Power	PASS	-----
15.247(a)(2)	6dB RF Bandwidth	PASS	-----
15.247(e)	Maximum Power Spectral Density	PASS	-----
15.247(d)	Out of Band Conducted Spurious Emission	PASS	-----
15.203	Antenna Requirement	PASS	-----

Standard	Description
CFR47, Part 15, Subpart C §15.247	Intentional Radiators
ANSI C63. 10: 2013	American National Standard of Procedures for Compliance Testing of Unlicensed Wireless Devices
ANSI C63. 4: 2014	American National Standard for methods of measurement of radio – noise emissions from low-voltage electrical and electronic equipment in the range of 9 kHz to 40 GHz
KDB558074 D01 v05	GUIDANCE FOR COMPLIANCE MEASUREMENTS ON DIGITAL TRANSMISSION SYSTEM, FREQUENCY HOPPING SPREAD SPECTRUM SYSTEM, AND HYBRID SYSTEM DEVICES OPERATING UNDER SECTION 15.247 OF THE FCC RULES

The test results of this report relate only to the tested sample(s) identified in this report. Manufacturer or whom it may concern should recognize the pass or fail of the test result.



A Test Lab Techno Corp. tested the above equipment under the requirements outlined in the above standards. All indications of Pass/Fail in this report are opinions expressed by A Test Lab Techno Corp. Based on interpretations and/or observations of test results. Measurement Uncertainties were not taken into account and are published for informational purposes only. The test results show that the equipment tested is capable of demonstrating compliance with the requirements as documented in this report.

A Test Lab Techno Corp. will not be liable for any loss or damage resulting from false, inaccurate, inappropriate or incomplete product information provided by the customer.

This test report is electronically signed and valid without handwriting signature. For verification of the electronic signatures, the public keys can be requested at the testing laboratory.

1.2 Measurement Uncertainty

Test Item	Frequency Range	Uncertainty (dB)
Conducted Emission	9 kHz ~ 150 kHz	2.7
	150 kHz ~ 30 MHz	2.7
Radiated Emission	9 kHz ~ 30 MHz	1.7
	30 MHz ~ 1000 MHz	5.7
	1000 MHz ~ 18000 MHz	5.5
	18000 MHz ~ 26500 MHz	4.8
	26500 MHz ~ 40000 MHz	4.8
Conducted Output Power	+0.27 dB / -0.28 dB	
RF Bandwidth	4.96%	
Power Spectral Density	+0.71 dB / -0.77 dB	



2 EUT Description

Applicant	Maverick Industries, Inc. 94 Mayfield Avenue Edison NJ United States	
Manufacturer	Manford Development Limited Unit 535B, 5/F, Core Building 2, No.1 Science Park West Avenue, HKSTP, Shatin, N.T., Hong Kong	
Factory	ATR (DONG GUAN) ELECTRONICS MANUFACTORY CO., LTD. 38, XIAN FENG ROAD, PING SHAN, TANGXIA TOWN, DONGGUAN CITY, GUANG DONG PROVINCE	
Product Type	Intelligent Digital TRULY Wireless FOOD THERMOMETER	
Trade Name	MAVERICK	
Model No.	BT-30	
FCC ID	TKCBT-30	
Frequency Range	2402 ~ 2480 MHz	
Modulation Type	GFSK	
Operate Temp. Range	0 ~ +80 °C	
Antenna information	Type	Max. Gain (dBi)
	Chip antenna	0.5
RF Output Power	0.00268 W	

3 Test Methodology

3.1. Mode of Operation

Decision of Test ATL has verified the construction and function in typical operation. All the test modes were carried out with the EUT in normal operation, which was shown in this test report and defined as:

Test Mode
Mode 1: Transmit mode
Mode 2: Continuous TX mode

Software used to control the EUT for staying in continuous transmitting mode was programmed.

After verification, all tests were carried out with the worst case test modes as shown below except radiated spurious emission below 1GHz and power line conducted emissions below 30MHz, which worst case was in TX mode only.

By preliminary testing and verifying three axis (X, Y and Z) position of EUT transmitted status, it was found that "X axis" position was the worst, then the final test was executed the worst condition and test data were recorded in this report.

Note: The EUT was programmed to be in continuously transmitting mode and the transmit duty cycle is not less than 98%.

3.2. EUT Exercise Software

1	Setup the EUT shown on "Configuration of Test System Details".
2	Turn on the power of all equipment.
3	Turn on TX function
4	EUT run test program.

Measurement Software	
1	EZ-EMC Ver. ATL-03A1-1
2	EZ-EMC Ver ATL-ITC-3A1-1 (for Conducted Emission)

3.3. Configuration of Test System Details

Conducted Emission

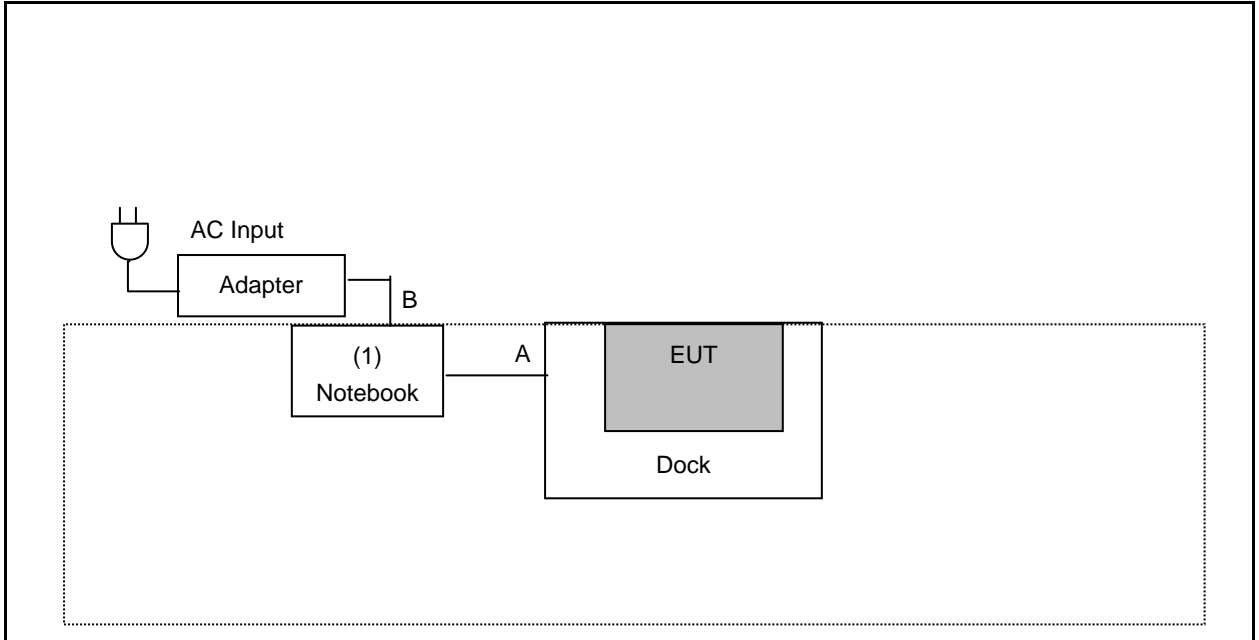

Radiated Emissions

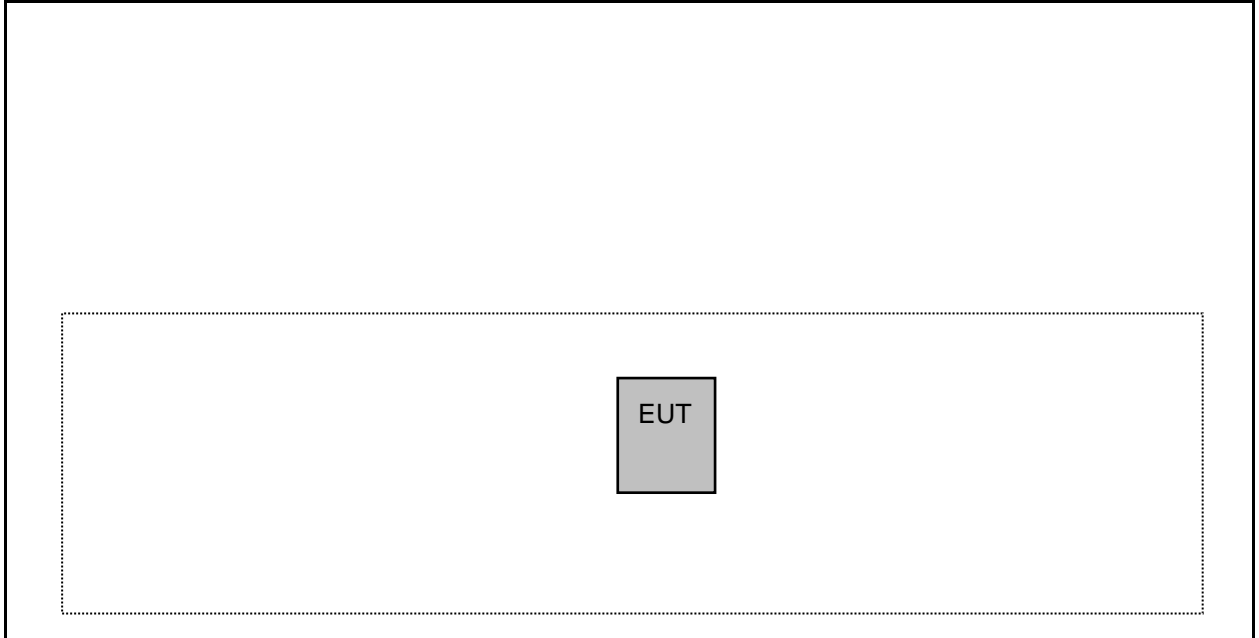

Devices Description					
	Product	Manufacturer	Model Number	Serial Number	Power Cord
(1)	Notebook	Lenovo	LENOVO B490	WB12542618	Non-Shielded, 0.8m



3.4. Test Instruments

For Conducted Emission

Test Period: Nov. 06, 2019

Equipment	Manufacturer	Model Number	Serial Number	Cal. Date	Cal. Period
Test Receiver	R&S	ESR3	101923	09/02/2019	1 year
LISN	R&S	ENV216	101942	09/02/2019	1 year
LISN	R&S	ENV216	101943	09/02/2019	1 year
RF Cable	EMCI	EMCCFD400	433LFC	09/02/2019	1 year
Test Site	ATL	CE	CE	N.C.R.	-----

For Radiated Emissions

Test Period: Nov. 08, 2019

Equipment	Manufacturer	Model Number	Serial Number	Cal. Date	Cal. Period
Preamplifier (10 kHz~3 GHz)	EMCI	EMC001330	980300	09/02/2019	1 year
Preamplifier (0.1 GHz~26.5 GHz)	EMCI	EMC012645SE	980318	09/02/2019	1 year
Preamplifier (26.5 GHz~40 GHz)	EMCI	EMC2654045	980028	08/23/2019	1 year
Bilog Antenna (30 MHz~1.4 GHz)	Schwarzbeck	VULB 9168	672	11/21/2018	1 year
Horn Antenna (1 GHz~18 GHz)	ETS	3117	00204949	11/21/2018	1 year
Horn Antenna (18 GHz~26.5 GHz)	ETS	3160-09	00202549	11/05/2018	1 year
Horn Antenna (18 GHz~40 GHz)	ETS	3116	00086467	11/04/2019	1 year
Receiver (3 Hz~26.5 GHz)	Keysight	N9038A	MY51210179	09/02/2019	1 year
Spectrum Analyzer (3 Hz~43 GHz)	Keysight	N9030A	MY55410268	09/02/2019	1 year
Cable (30 MHz~1 GHz)	EMCI	N/A	1066LFC	09/02/2019	1 year
Cable (1 GHz~18 GHz)	EMCI	N/A	160719	09/02/2019	1 year
Cable (1 GHz~18 GHz)	EMCI	N/A	160324	09/02/2019	1 year
Cable (1 GHz~18 GHz)	EMCI	N/A	160322	09/02/2019	1 year
Loop Antenna	EMCI	LPA600	272	02/20/2019	1 year
Test Site	OuHeng	MFAC3M	RE-026	02/14/2019	1 year

Note: N.C.R. = No Calibration Request.



For Conducted

Test Period: Nov. 07, 2019

Equipment	Manufacturer	Model Number	Serial Number	Cal. Date	Cal. Period
Power Sensor	Anritsu	U2021XA	SG54130003	09/02/2019	1 year
Spectrum Analyzer (10 Hz~26.5 GHz)	Agilent	N9020A	MY53420615	09/02/2019	1 year
Spectrum Analyzer (9 KHz~26.5 GHz)	Agilent	E4445A	MY46181814	09/02/2019	1 year
Programmable temp &humi chamber	ETAI	9712A	647	09/02/2019	1 year
Test Site	ATL	RF	RF	N.C.R.	-----

Note: N.C.R. = No Calibration Request.

3.5. Test Site Environment

Items	Required (IEC 60068-1)	Actual
Temperature (°C)	15-35	26
Humidity (%RH)	25-75	60
Barometric pressure (mbar)	860-1060	950

4 Measurement Procedure

4.1. AC Power Line Conducted Emission Measurement

■ Limit

Frequency (MHz)	Quasi-peak	Average
0.15 - 0.5	66 to 56	56 to 46
0.50 - 5.0	56	46
5.0 - 30.0	60	50

■ Test Setup

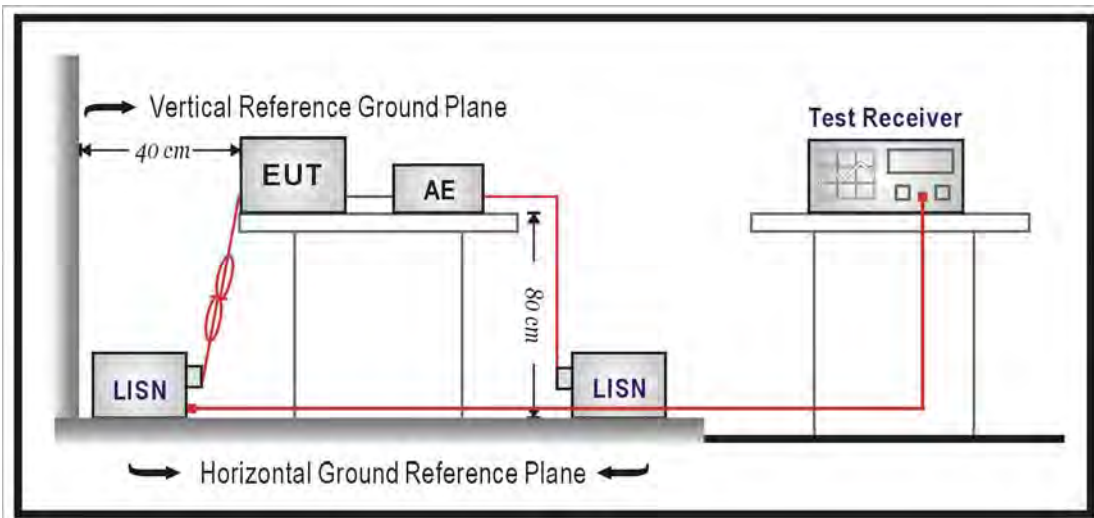

■ Test Procedure

The EUT and simulators are connected to the main power through a line impedance stabilization network (L.I.S.N.). This provides a $50\Omega// 50\text{ uH}$ coupling impedance for the measuring equipment. The peripheral devices are also connected to the main power through a LISN that provides a $50\ \Omega// 50\text{ uH}$ coupling impedance with 50ohm termination.

Tabletop device shall be placed on a non-conducting platform, of nominal size 1 m by 1.5 m, raised 80 cm above the reference ground plane. The wall of screened room shall be located 40cm to the rear of the EUT. Other surfaces of tabletop or floor standing EUT shall be at least 80cm from any other ground conducting surface including one or more LISNs. For floor-standing device shall be placed under the EUT with a 12 mm insulating material.

Conducted emissions were investigated over the frequency range from 0.15 MHz to 30 MHz using a resolution bandwidth of 9 kHz. The equipment under test (EUT) shall be meet the limits in section 4.1, as applicable, including the average limit and the quasi-peak limit when using respectively, an average detector and quasi-peak detector measured in accordance with the methods described of related standard. When all of peak value were complied with quasi-peak and average limit from 150 kHz to 30 MHz then quasi-peak and average measurement was unnecessary.

The AMN shall be placed 0.8 m from the boundary of the unit under test and bonded to a ground reference plane for AMNs mounted on top of the ground reference plane. This distance is between the closest points of the AMN and the EUT. All other units of the EUT and associated equipment shall be at least 0.8 m from the AMN. If the mains power cable is longer than 1m then the cable shall be folded back and forth at the centre of the lead to form a bundle no longer than 0.4 m. All of interconnecting cables that hang closer than 40cm to the ground plane shall be folded back and forth in the center forming a bundle 30 cm to 40 cm long. All of EUT and AE shall be separate place more than 0.1 m. All 50 Ω ports of the LISN shall be resistively terminated into 50 Ω loads when not connected to the measuring instrument.

If the reading of the measuring receiver shows fluctuations close to the limit, the reading shall be observed for at least 15 s at each measurement frequency; the higher reading shall be recorded with the exception of any brief isolated high reading which shall be ignored.

4.2. Radiated Emission Measurement

■ Limit

According to §15.209(a), except as provided elsewhere in this subpart, the emissions from an intentional radiator shall not exceed the field strength levels specified in the following table:

Frequency (MHz)	Field Strength ($\mu\text{V}/\text{m}$ at meter)	Measurement Distance (meters)
0.009 – 0.490	$2400 / F$ (kHz)	300
0.490 – 1.705	$24000 / F$ (kHz)	30
1.705 – 30.0	30	30
30 - 88	100**	3
88-216	150**	3
216-960	200**	3
Above 960	500	3

** Except as provided in paragraph (g), fundamental emissions from intentional radiators operating under this Section shall not be located in the frequency bands 54-72 MHz, 76-88 MHz, 174-216 MHz or 470-806 MHz. However, operation within these frequency bands is permitted under other sections of this Part, e.g., Sections 15.231 and 15.241.

■ Setup

9 kHz ~ 30 MHz

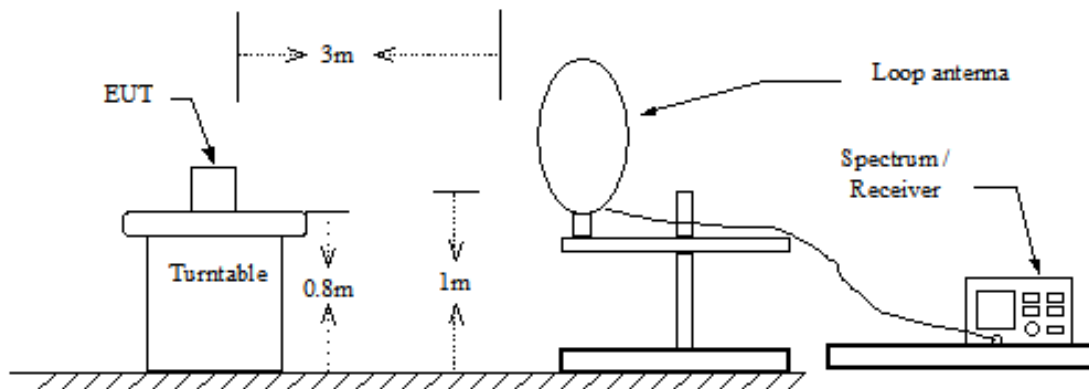

Below 1 GHz

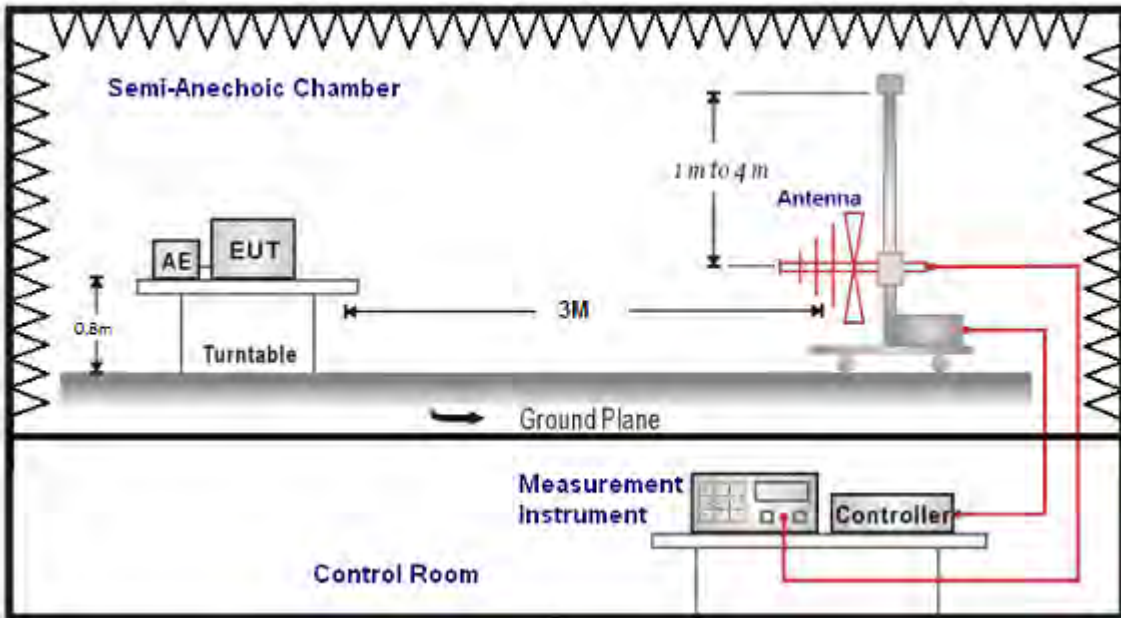

Above 1 GHz

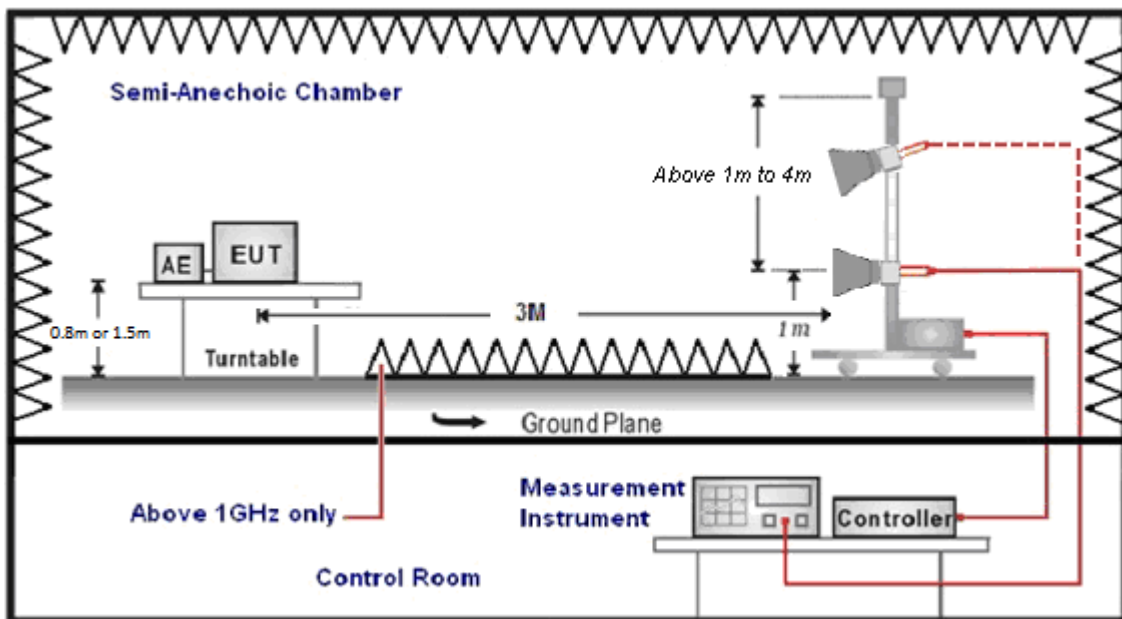

■ Test Procedure

Final radiation measurements were made on a three-meter, Semi Anechoic Chamber. The EUT system was placed on a nonconductive turntable which is 0.8 or 1.5 meters height, top surface 1.0 x 1.5 meter. The spectrum was examined from 250 MHz to 2.5 GHz in order to cover the whole spectrum below 10th harmonic which could generate from the EUT. During the test, EUT was set to transmit continuously & Measurements spectrum range from 9 kHz to 26.5 GHz is investigated.

For measurements below 1 GHz the resolution bandwidth is set to 100 kHz for peak detection measurements or 120 kHz for quasi-peak detection measurements. Peak detection is used unless otherwise noted as quasi-peak.

For measurements above 1 GHz the resolution bandwidth is set to 1 MHz, and then the video bandwidth is set to 1 MHz for peak measurements and 10 Hz for average measurements when Duty cycle >98% / 1/T for average measurements when Duty cycle <98%. A nonconductive material surrounded the EUT to supporting the EUT for standing on three orthogonal planes. At each condition, the EUT was rotated 360 degrees, and the antenna was raised and lowered from one to four meters to find the maximum emission levels. Measurements were taken using both horizontal and vertical antenna polarization.

SCHWARZBECK MESS-ELEKTRONIK Biconilog Antenna at 3 Meter and the SCHWARZBECK Double Ridged Guide Antenna was used in frequencies 1 – 26.5 GHz at a distance of 1 meter. All test results were extrapolated to equivalent signal at 3 meters utilizing an inverse linear distance extrapolation Factor (20 dB/decade).

For testing above 1 GHz, the emission level of the EUT in peak mode was 20 dB lower than average limit (that means the emission level in peak mode also complies with the limit in average mode), then testing will be stopped and peak values of EUT will be reported, otherwise, the emissions will be measured in average mode again and reported.

Appropriate preamplifiers were used for improving sensitivity and precautions were taken to avoid overloading or desensitizing the spectrum analyzer. No post – detector video filters were used in the test.

The spectrum analyzer's 6 dB bandwidth was set to 1 MHz, and the analyzer was operated in the peak detection mode, for frequencies both below and up 1 GHz. The average levels were obtained by subtracting the duty cycle correction factor from the peak readings.

The following procedures were used to convert the emission levels measured in decibels referenced to 1 microvolt (dBuV) into field intensity in micro volts pre meter (uV/m).

The actual field intensity in decibels referenced to 1 microvolt in to field intensity in micro volts per meter (dBuV/m).



The actual field intensity in referenced to 1 microvolt per meter (dBuV/m) is determined by algebraically adding the measured reading in dBuV, the antenna factor (dB), and cable loss (dB) and Subtracting the gain of preamplifier (dB) is auto calculate in spectrum analyzer.

(1) $\text{Amplitude (dBuV/m)} = \text{FI (dBuV)} + \text{AF (dBuV)} + \text{CL (dBuV)} - \text{Gain (dB)}$

FI= Reading of the field intensity.

AF= Antenna factor.

CL= Cable loss.

P.S Amplitude is auto calculate in spectrum analyzer.

(2) $\text{Actual Amplitude (dBuV/m)} = \text{Amplitude (dBuV)} - \text{Dis(dB)}$

The FCC specified emission limits were calculated according the EUT operating frequency and by following linear interpolation equations:

(a) For fundamental frequency : Transmitter Output < +30dBm

(b) For spurious frequency : Spurious emission limits = fundamental emission limit /10

Data of measurement within this frequency range without mark in the table above means the reading of emissions are attenuated more than 20 dB below the permissible limits or the field strength is too small to be measured.

4.3. Maximum Conducted Output Power Measurement

■ Limit

For systems using digital modulation in the 2400-2483.5 MHz, the limit for peak output power is 30 dBm.

■ Test Setup

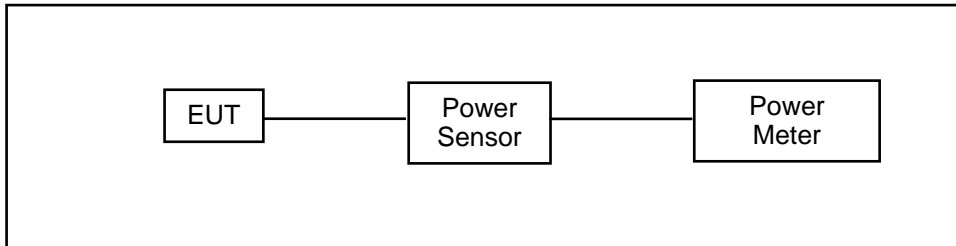

■ Test Procedure

The testing follows the Measurement Procedure of ANSI C63.10-2013 section 11.9.2.3 Method AVGPM.

The tests below are run with the EUT's transmitter set at high power in TX mode. The EUT is needed to force selection of output power level and channel number. While testing, EUT was set to transmit continuously. Remove the Subjective device's antenna and connect the RF output port to power sensor..

4.4. 6 dB RF Bandwidth Measurement

■ Limit

6 dB RF Bandwidth: Systems using digital modulation techniques may operate in the 2400–2483.5 MHz bands. The minimum 6 dB band-width shall be at least 500 kHz.

99 % Occupied Bandwidth: N/A

■ Test Setup

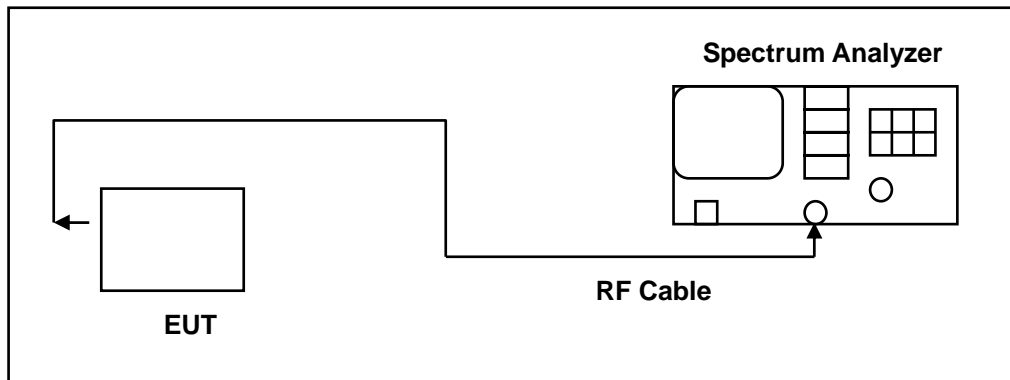

■ Test Procedure

The EUT tested to DTS test procedure of KDB558074D01 for compliance to FCC 47CFR 15.247 requirements.

6 dB RF Bandwidth: The antenna port of the EUT was connected to the input of a spectrum analyzer. Analyzer RBW was set to 100 kHz. For each RF output channel investigated, the spectrum analyzer center frequency was set to the channel carrier. A peak output reading was taken, a DISPLAY line was drawn 6 dB lower than peak level. The 6 dB bandwidth was determined from where the channel output spectrum intersected the display line.

The test was performed at 3 channels (Channel low, middle, high)

4.5. Maximum Power Density Measurement

■ Limit

For digitally modulated systems, the power spectral density conducted from the intentional radiator to the antenna shall not be greater than 8 dBm in any 3 kHz band during any time interval of continuous transmission.

■ Test Setup

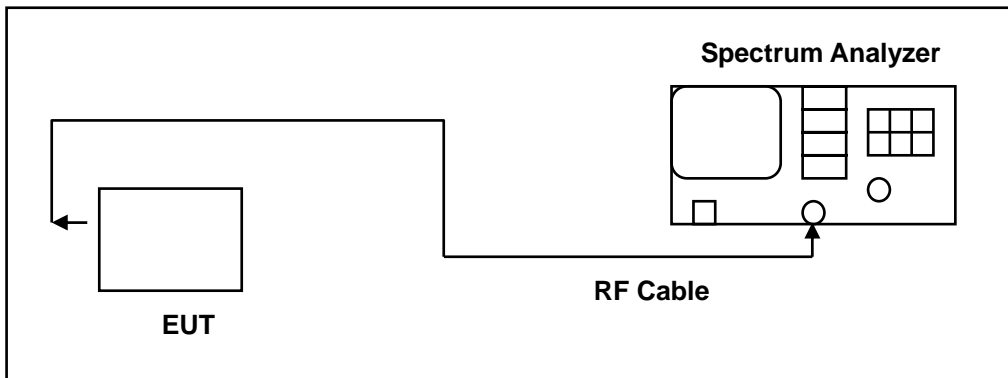

■ Test Procedure

The EUT tested to DTS test procedure of KDB558074D01 section 10.2 Method PKPSD for compliance to FCC 47CFR 15.247 requirements.

1. Set analyzer center frequency to DTS channel center frequency.
2. Set the span to 1.5 times the DTS bandwidth.
3. Set the RBW to: $3 \text{ kHz} \leq \text{RBW} \leq 100 \text{ kHz}$.
4. Set the VBW $\geq 3 \times \text{RBW}$.
5. Detector = peak.
6. Sweep time = auto couple.
7. Trace mode = max hold.
8. Allow trace to fully stabilize.
9. Use the peak marker function to determine the maximum amplitude level within the RBW.
10. If measured value exceeds limit, reduce RBW (no less than 3 kHz) and repeat.

4.6. Out of Band Conducted Emissions Measurement

■ **Limit**

In any 100 kHz bandwidth outside the frequency band in which the spread spectrum or digitally modulated intentional radiator is operating, the radio frequency power that is produced by the intentional radiator shall be at least 20 dB below that in the 100 kHz bandwidth within the band that contains the highest level of the desired power

■ **Test Setup**

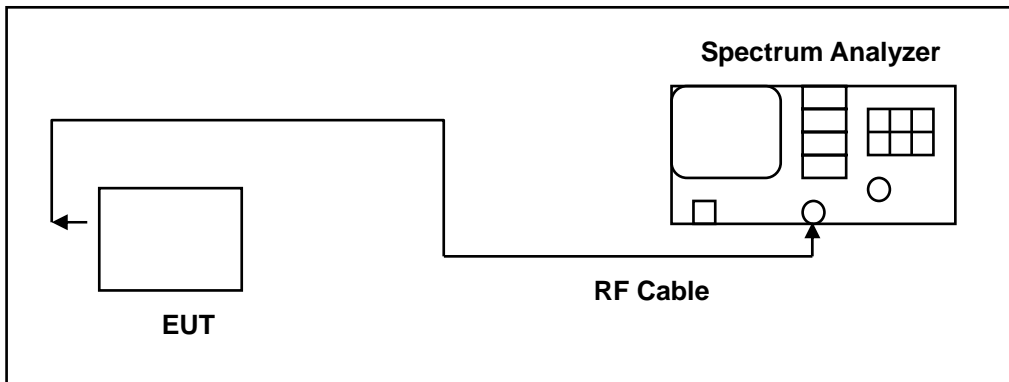

■ **Test Procedure**

In any 100 kHz bandwidth outside the EUT pass band, the RF power produced by the modulation products of the spreading sequence, the information sequence, and the carrier frequency shall be at least 20 dB below that of the maximum in-band 100 kHz emission, antenna output of the EUT was coupled directly to spectrum analyzer; if an external attenuator and/or cable was used, these losses are compensated for with the analyzer OFFSET function. All other types of emissions from the EUT shall meet the general limits for radiated frequencies outside the pass band. The test was performed at 3 channels.

4.7. Antenna Measurement

■ **Limit**

For intentional device, according to 15.203, an intentional radiator shall be designed to ensure that no antenna other than that furnished by the responsible party shall be used with the device.

And According to 15.247 (b), if transmitting antennas of directional gain greater than 6 dBi are used, the power shall be reduced by the amount in dB that the directional gain of the antenna exceeds 6dBi.



5 Test Results

Annex A. Conducted Emission

Standard:	FCC Part 15.247	Line:	L1
Test Mode:	Mode 1	Power:	AC 120 V/60 Hz
		Temp.(°C)/Hum.(%RH):	26(°C)/60 %RH
Description:			

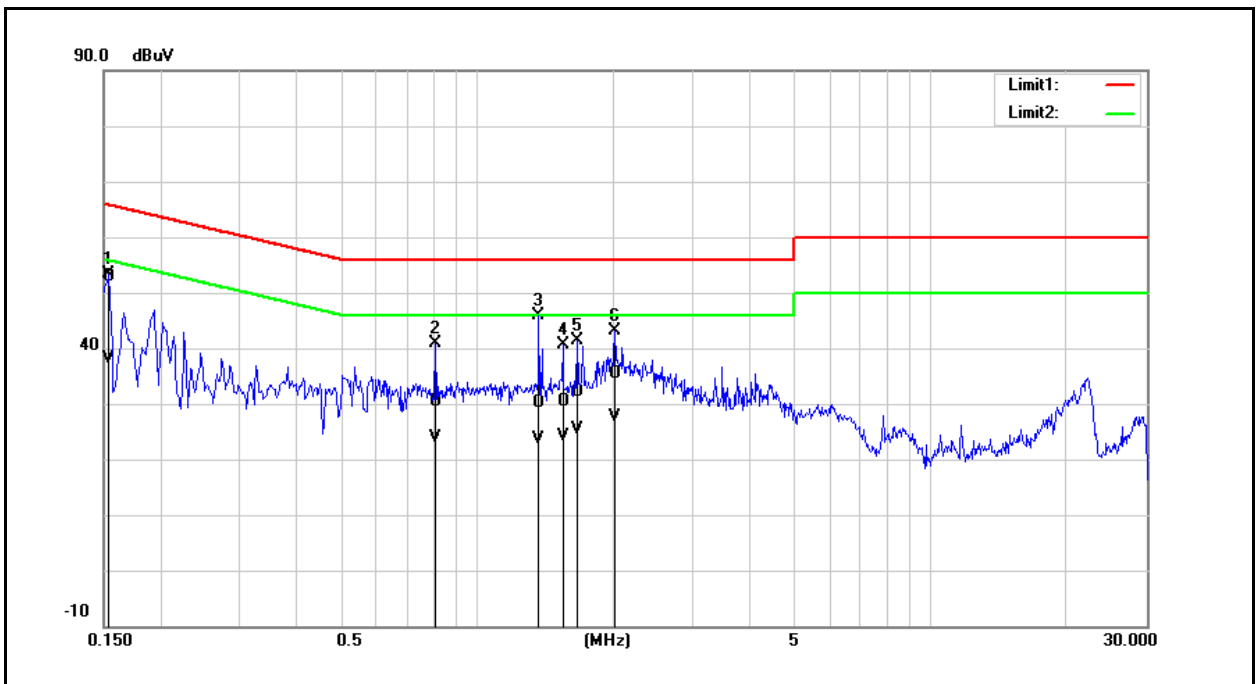

No.	Frequency (MHz)	QP reading (dBuV)	AVG reading (dBuV)	Correction factor (dB)	QP result (dBuV)	AVG result (dBuV)	QP limit (dBuV)	AVG limit (dBuV)	QP margin (dB)	AVG margin (dB)	Remark
1	0.1540	42.53	27.74	10.37	52.90	38.11	65.78	55.78	-12.88	-17.67	Pass
2	0.8100	20.52	14.15	9.79	30.31	23.94	56.00	46.00	-25.69	-22.06	Pass
3	1.3700	20.09	13.78	9.92	30.01	23.70	56.00	46.00	-25.99	-22.30	Pass
4	1.5500	20.31	14.26	9.95	30.26	24.21	56.00	46.00	-25.74	-21.79	Pass
5	1.6660	22.14	15.33	9.97	32.11	25.30	56.00	46.00	-23.89	-20.70	Pass
6	2.0220	25.27	17.60	10.02	35.29	27.62	56.00	46.00	-20.71	-18.38	Pass

Note: 1. Result (dBuV) = Correction factor (dB) + Reading(dBuV).

2. Correction factor (dB) = Cable loss (dB) + L.I.S.N. factor (dB).



Standard:	FCC Part 15.247	Line:	N
Test Mode:	Mode 1	Power:	AC 120 V/60 Hz
		Temp.(°C)/Hum.(%RH):	26(°C)/60 %RH
Description:			

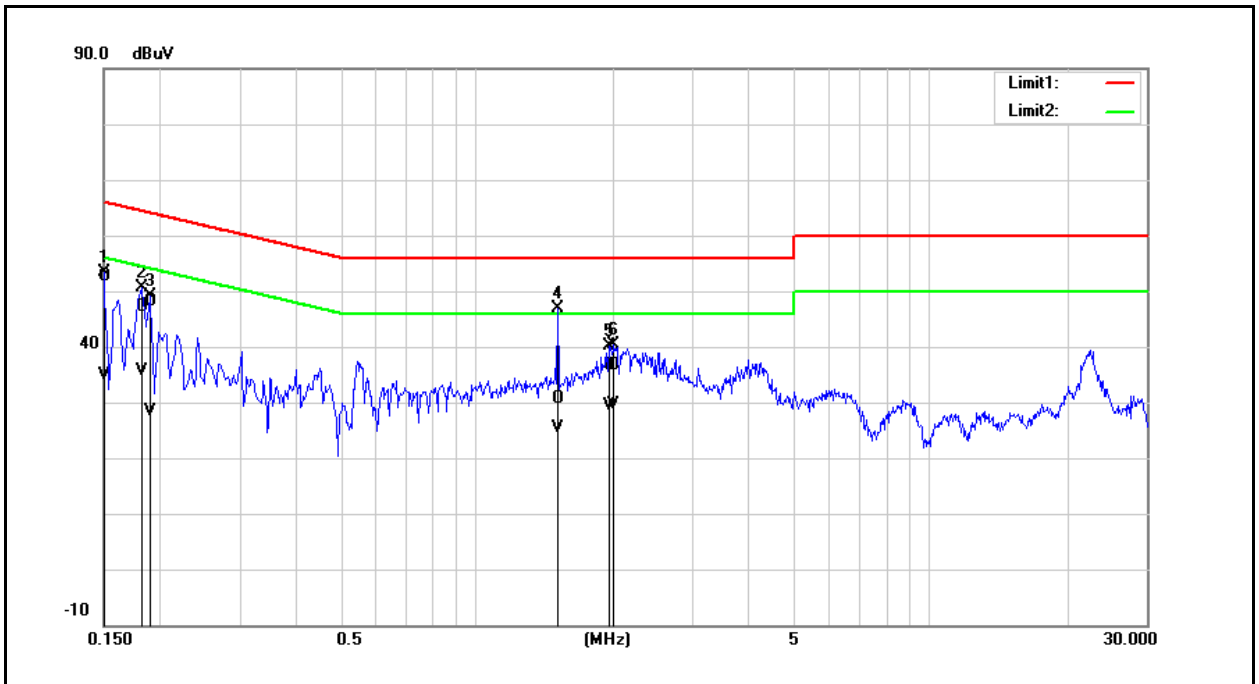

No.	Frequency (MHz)	QP reading (dBuV)	AVG reading (dBuV)	Correction factor (dB)	QP result (dBuV)	AVG result (dBuV)	QP limit (dBuV)	AVG limit (dBuV)	QP margin (dB)	AVG margin (dB)	Remark
1	0.1500	42.24	24.54	10.28	52.52	34.82	66.00	56.00	-13.48	-21.18	Pass
2	0.1820	36.76	25.38	10.29	47.05	35.67	64.39	54.39	-17.34	-18.72	Pass
3	0.1900	37.77	18.16	10.29	48.06	28.45	64.04	54.04	-15.98	-25.59	Pass
4	1.5060	20.73	15.48	9.91	30.64	25.39	56.00	46.00	-25.36	-20.61	Pass
5	1.9660	26.62	19.32	10.08	36.70	29.40	56.00	46.00	-19.30	-16.60	Pass
6	2.0060	26.63	19.66	10.09	36.72	29.75	56.00	46.00	-19.28	-16.25	Pass

Note: 1. Result (dBuV) = Correction factor (dB) + Reading(dBuV).
 2. Correction factor (dB) = Cable loss (dB) + L.I.S.N. factor (dB).

Annex B. Conducted Test Results

Maximum Conducted Output Power Measurement

Test Mode	Mode 2				
Frequency (MHz)	Average Power		Peak Power		Limit (dBm)
	(dBm)	(W)	(dBm)	(W)	
2402	3.15	0.00207	4.28	0.00268	< 30
2440	2.81	0.00191	3.95	0.00248	< 30
2480	2.58	0.00181	3.71	0.00235	< 30

Note: The relevant measured result has the offset with cable loss already.

6dB RF Bandwidth Measurement

Test Mode	Mode 2	
Frequency (MHz)	Measurement Results (kHz)	Limit (kHz)
2402	517.300	> 500
2440	517.300	> 500
2480	516.800	> 500

■ Test Graphs

Mode 2	
2402 MHz	<p>Center Freq: 2.402000000 GHz Trig: Free Run #Gain: Low #Atten: 10 dB AvgHold: >10/10 Radio Std: None Radio Device: BTS</p> <p>10 dB/div Ref 10.00 dBm Log</p> <p>Center 2.402 GHz #Res BW 100 kHz #VBW 300 kHz Span 3 MHz Sweep 1 ms</p> <p>Occupied Bandwidth 970.11 kHz Total Power -0.92 dBm</p> <p>Transmit Freq Error 24.300 kHz % of OBW Power 99.00 % x dB Bandwidth 517.3 kHz x dB -6.00 dB</p> <p>Frequency: 2.402000000 GHz CF Step: 300.000 kHz Freq Offset: 0 Hz</p>
2440 MHz	<p>Center Freq: 2.440000000 GHz Trig: Free Run #Gain: Low #Atten: 10 dB AvgHold: >10/10 Radio Std: None Radio Device: BTS</p> <p>10 dB/div Ref 10.00 dBm Log</p> <p>Center 2.44 GHz #Res BW 100 kHz #VBW 300 kHz Span 3 MHz Sweep 1 ms</p> <p>Occupied Bandwidth 984.56 kHz Total Power -1.31 dBm</p> <p>Transmit Freq Error 25.134 kHz % of OBW Power 99.00 % x dB Bandwidth 517.3 kHz x dB -6.00 dB</p> <p>Frequency: 2.440000000 GHz CF Step: 300.000 kHz Freq Offset: 0 Hz</p>
2480 MHz	<p>Center Freq: 2.480000000 GHz Trig: Free Run #Gain: Low #Atten: 10 dB AvgHold: >10/10 Radio Std: None Radio Device: BTS</p> <p>10 dB/div Ref 10.00 dBm Log</p> <p>Center 2.48 GHz #Res BW 100 kHz #VBW 300 kHz Span 3 MHz Sweep 1 ms</p> <p>Occupied Bandwidth 974.79 kHz Total Power -1.34 dBm</p> <p>Transmit Freq Error 21.926 kHz % of OBW Power 99.00 % x dB Bandwidth 516.8 kHz x dB -6.00 dB</p> <p>Frequency: 2.480000000 GHz CF Step: 300.000 kHz Freq Offset: 0 Hz</p>





Maximum Power Density Measurement

Test Mode	Mode 2	
Frequency (MHz)	Measurement Results (dBm/3KHz)	Limit (dBm/3KHz)
2402	-16.564	< 8
2440	-17.613	< 8
2480	-17.224	< 8





■ Test Graphs

Mode 2	
2402 MHz	
2440 MHz	
2480 MHz	

Out of Band Conducted Emissions Measurement

■ Test Graphs

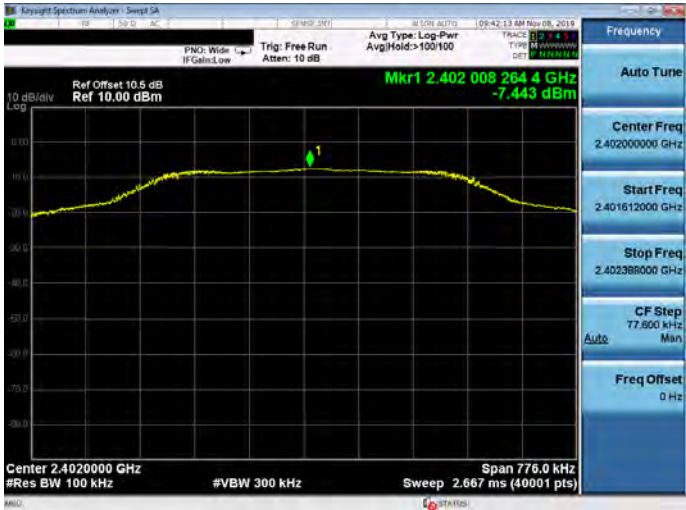
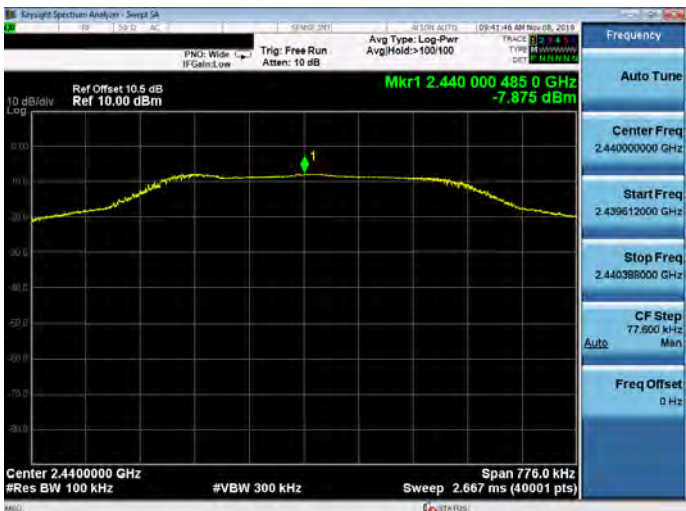
Reference level

Mode 2	
2402 MHz	 <p>Key parameters from screenshot:</p> <ul style="list-style-type: none"> Center Freq: 2.4020000 GHz Start Freq: 2.401612000 GHz Stop Freq: 2.402388000 GHz CF Step: 77.600 kHz Marker: Mkr1 2.402 008 264 GHz, -7.443 dBm Span: 776.0 kHz #Res BW: 100 kHz #VBW: 300 kHz Sweep: 2.667 ms (40001 pts)
2440 MHz	 <p>Key parameters from screenshot:</p> <ul style="list-style-type: none"> Center Freq: 2.4400000 GHz Start Freq: 2.439612000 GHz Stop Freq: 2.440388000 GHz CF Step: 77.600 kHz Marker: Mkr1 2.440 000 485 GHz, -7.875 dBm Span: 776.0 kHz #Res BW: 100 kHz #VBW: 300 kHz Sweep: 2.667 ms (40001 pts)
2480 MHz	 <p>Key parameters from screenshot:</p> <ul style="list-style-type: none"> Center Freq: 2.4800000 GHz Start Freq: 2.479612400 GHz Stop Freq: 2.480387600 GHz CF Step: 77.520 kHz Marker: Mkr1 2.480 007 171 GHz, -8.125 dBm Span: 775.2 kHz #Res BW: 100 kHz #VBW: 300 kHz Sweep: 2.667 ms (40001 pts)



Out of Band Conducted Emissions

Mode 2																												
2402 MHz	<table border="1"> <thead> <tr> <th>MKR</th> <th>MODE</th> <th>TRIG</th> <th>SC1</th> <th>X</th> <th>Y</th> <th>FUNCTION</th> <th>FUNCTION WIDTH</th> <th>FUNCTION VALUE</th> </tr> </thead> <tbody> <tr> <td>1</td> <td>N</td> <td>1</td> <td>f</td> <td>2402.4 GHz</td> <td>-7.421 dBm</td> <td></td> <td></td> <td></td> </tr> <tr> <td>2</td> <td>N</td> <td>1</td> <td>f</td> <td>24527.3 GHz</td> <td>-54.985 dBm</td> <td></td> <td></td> <td></td> </tr> </tbody> </table>	MKR	MODE	TRIG	SC1	X	Y	FUNCTION	FUNCTION WIDTH	FUNCTION VALUE	1	N	1	f	2402.4 GHz	-7.421 dBm				2	N	1	f	24527.3 GHz	-54.985 dBm			
MKR	MODE	TRIG	SC1	X	Y	FUNCTION	FUNCTION WIDTH	FUNCTION VALUE																				
1	N	1	f	2402.4 GHz	-7.421 dBm																							
2	N	1	f	24527.3 GHz	-54.985 dBm																							
2440 MHz	<table border="1"> <thead> <tr> <th>MKR</th> <th>MODE</th> <th>TRIG</th> <th>SC1</th> <th>X</th> <th>Y</th> <th>FUNCTION</th> <th>FUNCTION WIDTH</th> <th>FUNCTION VALUE</th> </tr> </thead> <tbody> <tr> <td>1</td> <td>N</td> <td>1</td> <td>f</td> <td>2440.1 GHz</td> <td>-8.449 dBm</td> <td></td> <td></td> <td></td> </tr> <tr> <td>2</td> <td>N</td> <td>1</td> <td>f</td> <td>25770.8 GHz</td> <td>-54.291 dBm</td> <td></td> <td></td> <td></td> </tr> </tbody> </table>	MKR	MODE	TRIG	SC1	X	Y	FUNCTION	FUNCTION WIDTH	FUNCTION VALUE	1	N	1	f	2440.1 GHz	-8.449 dBm				2	N	1	f	25770.8 GHz	-54.291 dBm			
MKR	MODE	TRIG	SC1	X	Y	FUNCTION	FUNCTION WIDTH	FUNCTION VALUE																				
1	N	1	f	2440.1 GHz	-8.449 dBm																							
2	N	1	f	25770.8 GHz	-54.291 dBm																							
2480 MHz	<table border="1"> <thead> <tr> <th>MKR</th> <th>MODE</th> <th>TRIG</th> <th>SC1</th> <th>X</th> <th>Y</th> <th>FUNCTION</th> <th>FUNCTION WIDTH</th> <th>FUNCTION VALUE</th> </tr> </thead> <tbody> <tr> <td>1</td> <td>N</td> <td>1</td> <td>f</td> <td>2480.5 GHz</td> <td>-8.371 dBm</td> <td></td> <td></td> <td></td> </tr> <tr> <td>2</td> <td>N</td> <td>1</td> <td>f</td> <td>25748.9 GHz</td> <td>-53.971 dBm</td> <td></td> <td></td> <td></td> </tr> </tbody> </table>	MKR	MODE	TRIG	SC1	X	Y	FUNCTION	FUNCTION WIDTH	FUNCTION VALUE	1	N	1	f	2480.5 GHz	-8.371 dBm				2	N	1	f	25748.9 GHz	-53.971 dBm			
MKR	MODE	TRIG	SC1	X	Y	FUNCTION	FUNCTION WIDTH	FUNCTION VALUE																				
1	N	1	f	2480.5 GHz	-8.371 dBm																							
2	N	1	f	25748.9 GHz	-53.971 dBm																							

Conducted Band Edge

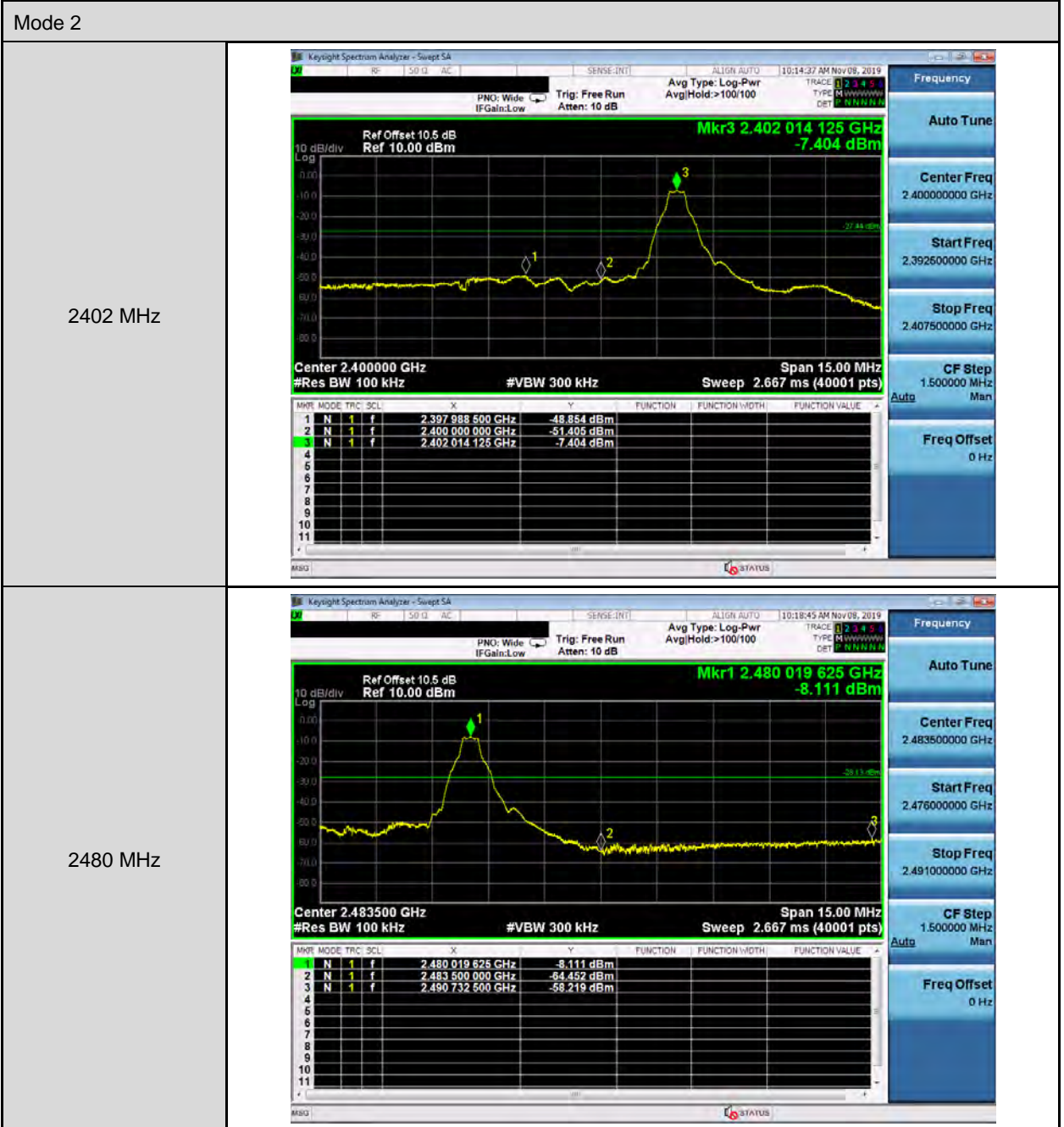



Annex C. Radiated Emission Measurement

Harmonic

Below 1GHz

Standard:		FCC Part 15.247		Test Distance:		3 m	
Test Mode:		Mode 1		Power:		AC 120 V/60 Hz	
				Temp.(°C)/Hum.(%RH):		26(°C)/60 %RH	
Frequency (MHz)	Reading (dBuV)	Correct Factor (dB/m)	Result (dBuV/m)	Limit (dBuV/m)	Margin (dB)	Remark	Ant.Polar. H / V
194.9000	43.19	-14.06	29.13	43.50	-14.37	QP	H
345.2500	44.98	-9.29	35.69	46.00	-10.31	QP	H
799.2100	30.43	0.31	30.74	46.00	-15.26	QP	H
838.0100	29.86	0.59	30.45	46.00	-15.55	QP	H
919.4900	29.61	1.21	30.82	46.00	-15.18	QP	H
940.8300	30.54	1.40	31.94	46.00	-14.06	QP	H
30.0000	45.39	-13.04	32.35	40.00	-7.65	QP	V
44.5500	37.59	-11.36	26.23	40.00	-13.77	QP	V
599.3900	34.63	-2.85	31.78	46.00	-14.22	QP	V
796.3000	29.80	0.25	30.05	46.00	-15.95	QP	V
861.2900	29.28	0.75	30.03	46.00	-15.97	QP	V
921.4300	28.88	1.22	30.10	46.00	-15.90	QP	V

Note:1.Result (dBuV/m) = Correct Factor (dB/m) + Reading(dBuV).

2.Correction factor (dB/m) = Antenna Factor (dB/m) + Cable loss (dB) – Pre-Amplifier gain (dB).

3.When the peak results are less than average limit, so not need to evaluate the average.



Above 1GHz

Standard:	FCC Part 15.247	Test Distance:	3 m
Test Mode:	Mode 2	Power:	AC 120 V/60 Hz
Frequency:	2402 MHz	Temp.(°C)/Hum.(%RH):	26(°C)/60 %RH
Ant.Polar.:	Horizontal		

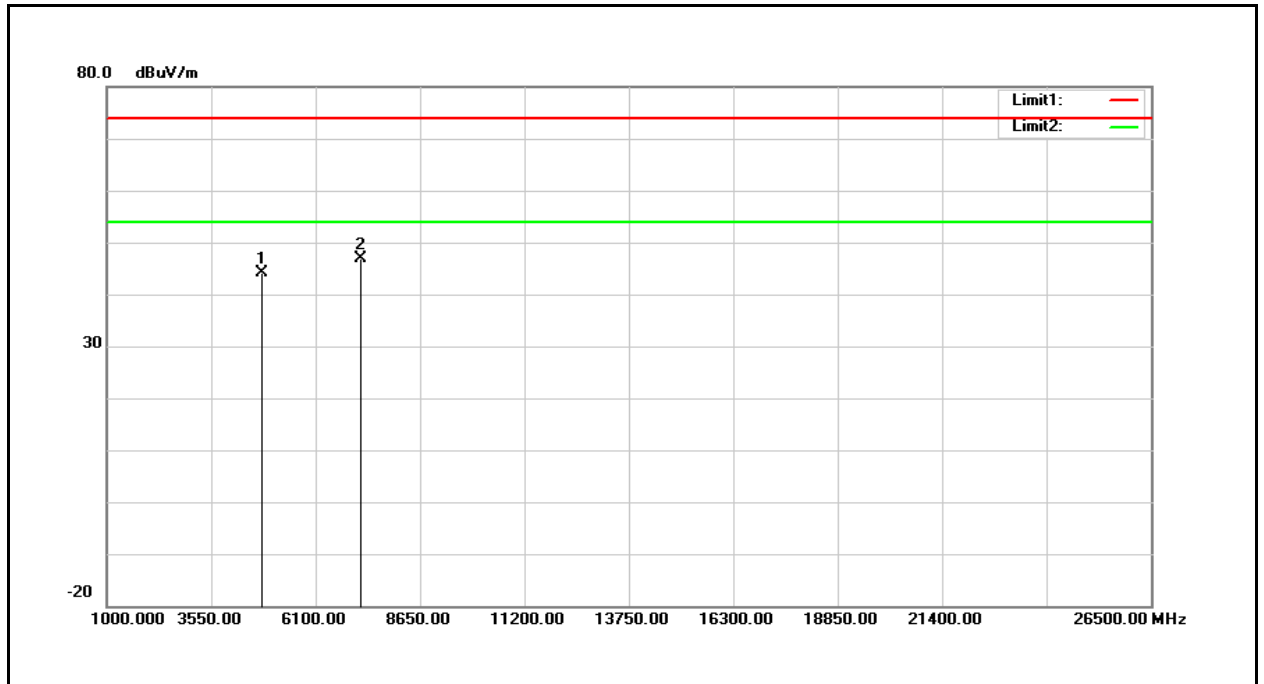

No.	Frequency (MHz)	Reading (dBuV)	Correct Factor (dB/m)	Result (dBuV/m)	Limit (dBuV/m)	Margin (dB)	Remark
1	4804.000	49.69	-5.57	44.12	74.00	-29.88	peak
2	7206.000	48.19	-1.37	46.82	74.00	-27.18	peak

Note: 1. Result (dBuV) = Correction factor (dB) + Reading(dBuV).

2. Correction factor (dB/m) = Antenna Factor (dB/m) + Cable loss (dB) – Pre-Amplifier gain (dB).

3. When peak results are less than average limit, so not need to evaluate the average.



Standard:	FCC Part 15.247	Test Distance:	3 m
Test Mode:	Mode 2	Power:	AC 120 V/60 Hz
Frequency:	2402 MHz	Temp.(°C)/Hum.(%RH):	26(°C)/60 %RH
Ant.Polar.:	Vertical		

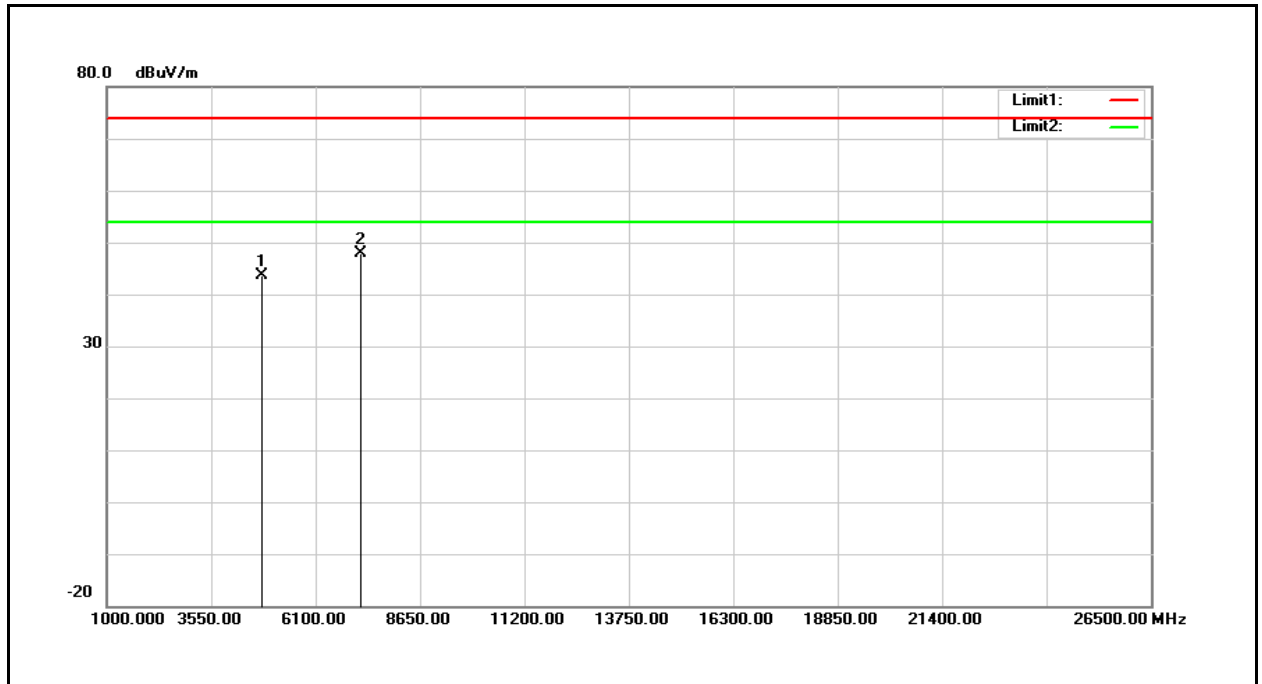

No.	Frequency (MHz)	Reading (dBuV)	Correct Factor (dB/m)	Result (dBuV/m)	Limit (dBuV/m)	Margin (dB)	Remark
1	4804.000	49.16	-5.57	43.59	74.00	-30.41	peak
2	7206.000	49.18	-1.37	47.81	74.00	-26.19	peak

Note: 1. Result (dBuV) = Correction factor (dB) + Reading(dBuV).

2. Correction factor (dB/m) = Antenna Factor (dB/m) + Cable loss (dB) – Pre-Amplifier gain (dB).

3. When peak results are less than average limit, so not need to evaluate the average.



Standard:	FCC Part 15.247	Test Distance:	3 m
Test Mode:	Mode 2	Power:	AC 120 V/60 Hz
Frequency:	2440 MHz	Temp.(°C)/Hum.(%RH):	26(°C)/60 %RH
Ant.Polar.:	Horizontal		

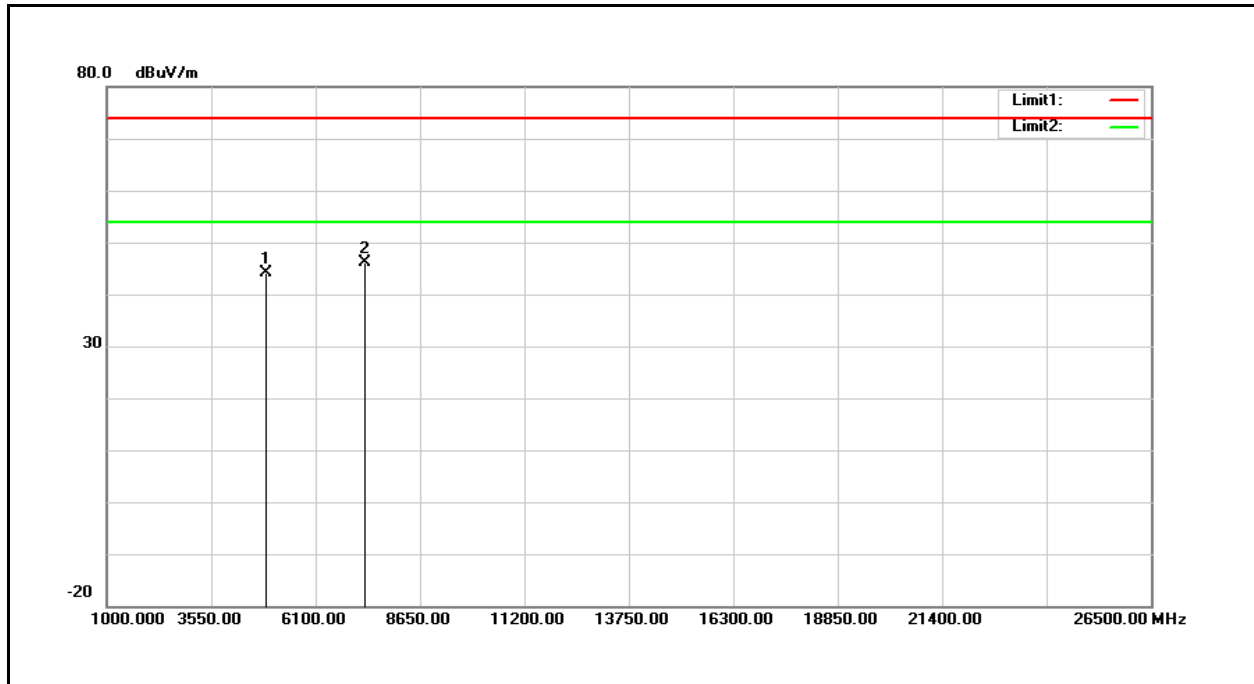

No.	Frequency (MHz)	Reading (dBuV)	Correct Factor (dB/m)	Result (dBuV/m)	Limit (dBuV/m)	Margin (dB)	Remark
1	4880.000	49.60	-5.45	44.15	74.00	-29.85	peak
2	7320.000	47.40	-1.19	46.21	74.00	-27.79	peak

Note: 1. Result (dBuV) = Correction factor (dB) + Reading(dBuV).

2. Correction factor (dB/m) = Antenna Factor (dB/m) + Cable loss (dB) – Pre-Amplifier gain (dB).

3. When peak results are less than average limit, so not need to evaluate the average.



Standard:	FCC Part 15.247	Test Distance:	3 m
Test Mode:	Mode 2	Power:	AC 120 V/60 Hz
Frequency:	2440 MHz	Temp.(°C)/Hum.(%RH):	26(°C)/60 %RH
Ant.Polar.:	Vertical		

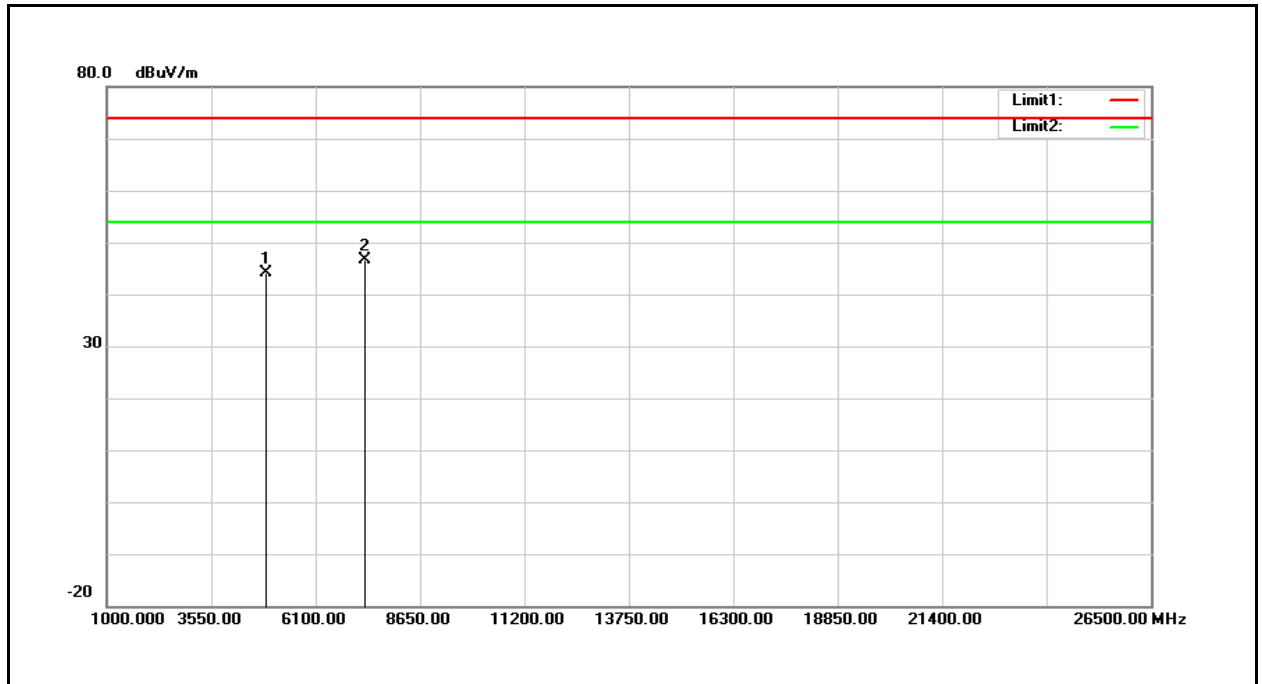

No.	Frequency (MHz)	Reading (dBuV)	Correct Factor (dB/m)	Result (dBuV/m)	Limit (dBuV/m)	Margin (dB)	Remark
1	4880.000	49.58	-5.45	44.13	74.00	-29.87	peak
2	7320.000	47.73	-1.19	46.54	74.00	-27.46	peak

Note: 1. Result (dBuV) = Correction factor (dB) + Reading(dBuV).

2. Correction factor (dB/m) = Antenna Factor (dB/m) + Cable loss (dB) – Pre-Amplifier gain (dB).

3. When peak results are less than average limit, so not need to evaluate the average.



Standard:	FCC Part 15.247	Test Distance:	3 m
Test Mode:	Mode 2	Power:	AC 120 V/60 Hz
Frequency:	2480 MHz	Temp.(°C)/Hum.(%RH):	26(°C)/60 %RH
Ant.Polar.:	Horizontal		

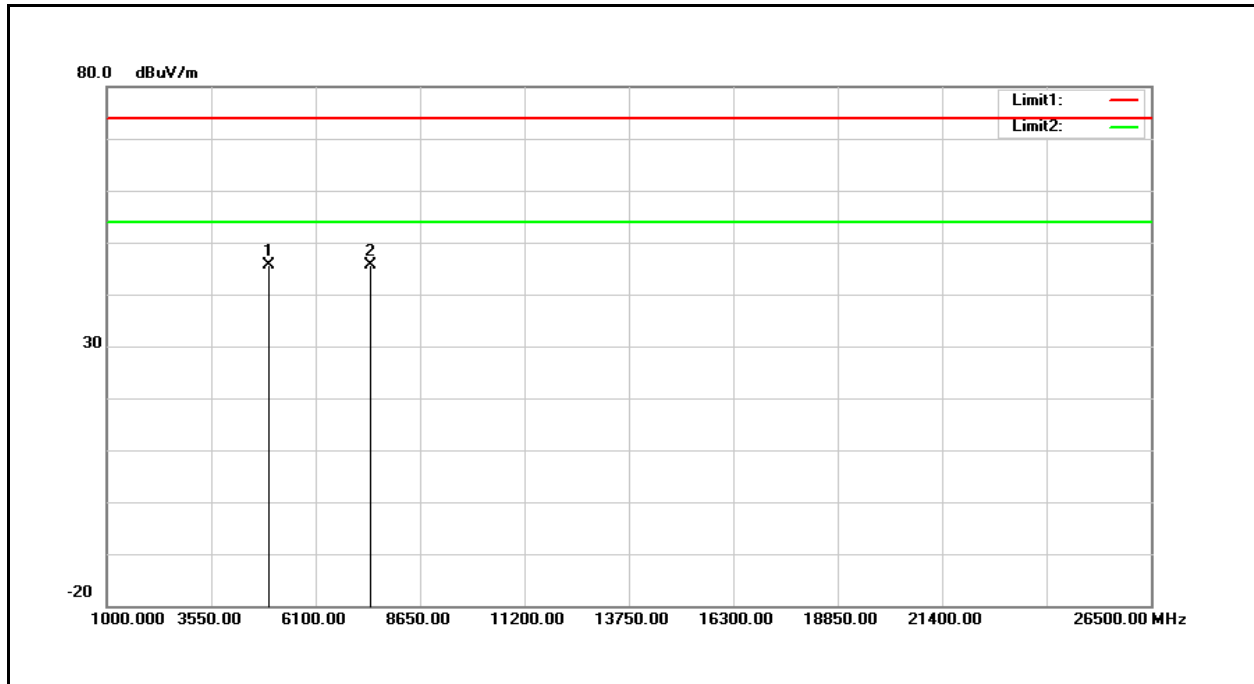

No.	Frequency (MHz)	Reading (dBuV)	Correct Factor (dB/m)	Result (dBuV/m)	Limit (dBuV/m)	Margin (dB)	Remark
1	4960.000	50.88	-5.33	45.55	74.00	-28.45	peak
2	7440.000	46.67	-1.00	45.67	74.00	-28.33	peak

Note: 1. Result (dBuV) = Correction factor (dB) + Reading(dBuV).

2. Correction factor (dB/m) = Antenna Factor (dB/m) + Cable loss (dB) – Pre-Amplifier gain (dB).

3. When peak results are less than average limit, so not need to evaluate the average.



Standard:	FCC Part 15.247	Test Distance:	3 m
Test Mode:	Mode 2	Power:	AC 120 V/60 Hz
Frequency:	2480 MHz	Temp.(°C)/Hum.(%RH):	26(°C)/60 %RH
Ant.Polar.:	Vertical		

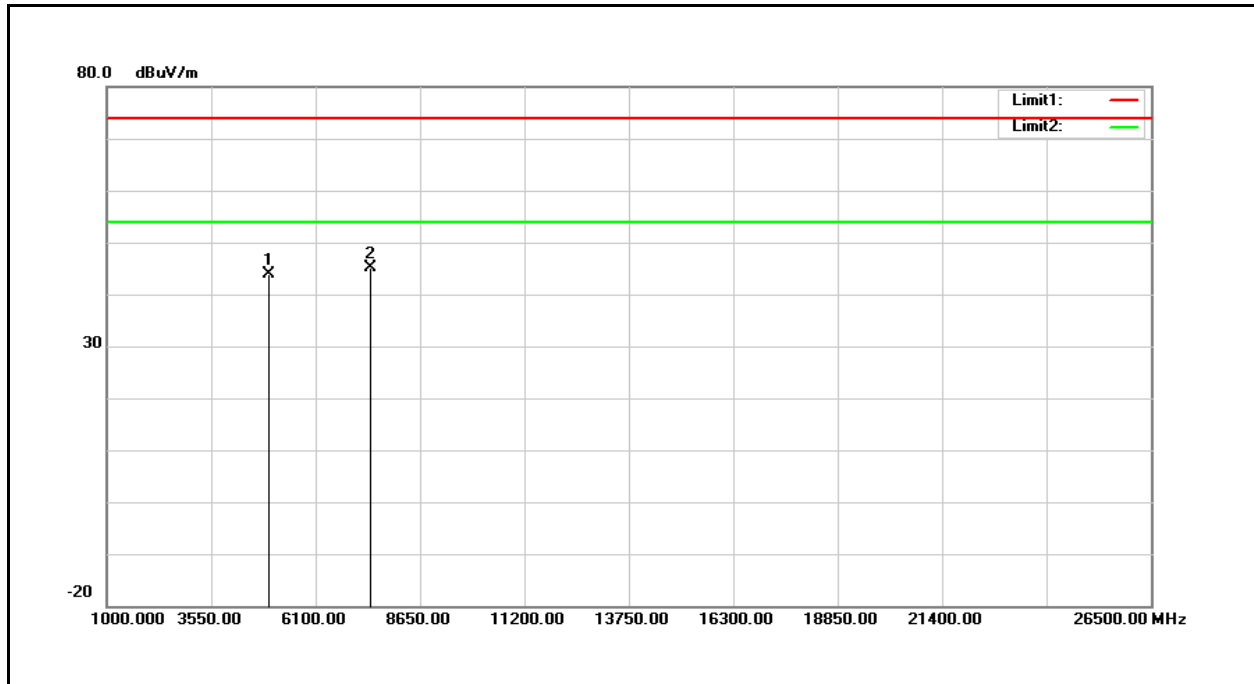

No.	Frequency (MHz)	Reading (dBuV)	Correct Factor (dB/m)	Result (dBuV/m)	Limit (dBuV/m)	Margin (dB)	Remark
1	4960.000	49.27	-5.33	43.94	74.00	-30.06	peak
2	7440.000	46.21	-1.00	45.21	74.00	-28.79	peak

Note: 1. Result (dBuV) = Correction factor (dB) + Reading(dBuV).

2. Correction factor (dB/m) = Antenna Factor (dB/m) + Cable loss (dB) – Pre-Amplifier gain (dB).

3. When peak results are less than average limit, so not need to evaluate the average.



Band Edge

Standard:	FCC Part 15.247	Test Distance:	3 m
Test Mode:	Mode 2	Power:	AC 120 V/60 Hz
Frequency:	2402 MHz	Temp.(°C)/Hum.(%RH):	26(°C)/60 %RH
Ant.Polar.:	Horizontal		

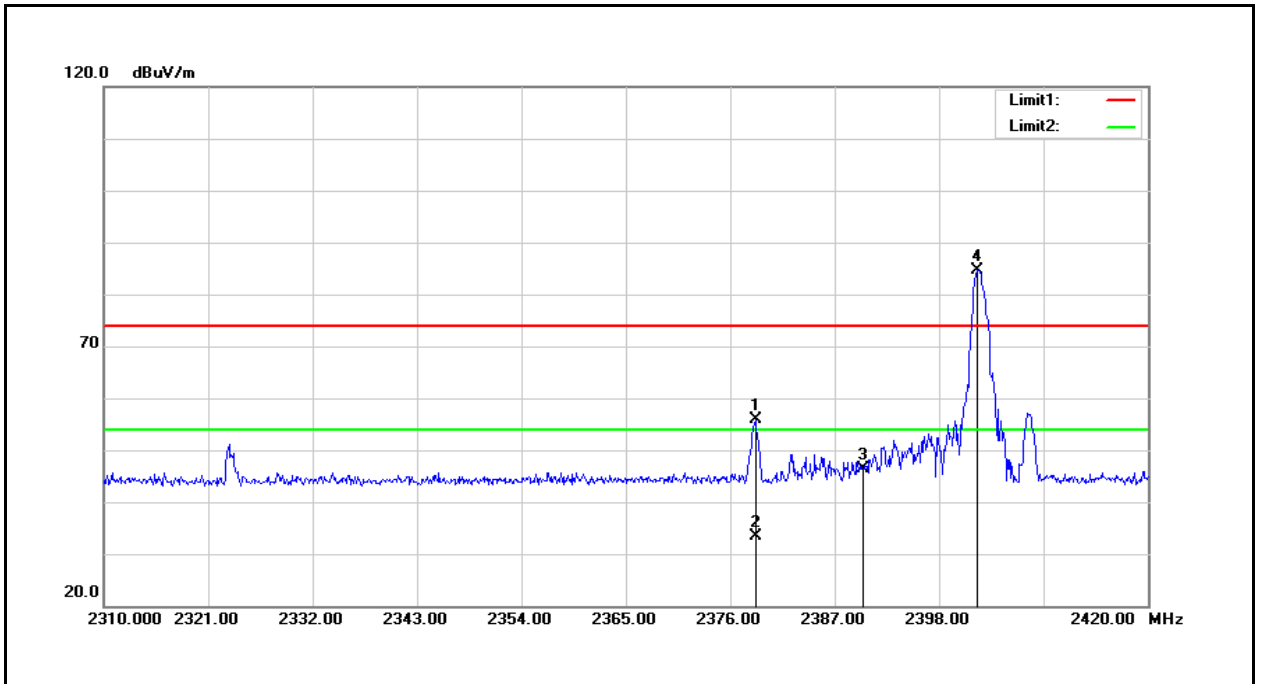

No.	Frequency (MHz)	Reading (dBuV)	Correct Factor (dB/m)	Result (dBuV/m)	Limit (dBuV/m)	Margin (dB)	Remark
1	2378.640	66.67	-10.87	55.80	74.00	-18.20	peak
2	2378.640	44.33	-10.87	33.46	54.00	-20.54	AVG
3	2390.000	57.14	-10.85	46.29	74.00	-27.71	peak
4	2402.070	95.51	-10.82	84.69	---	---	peak

Note: 1. Result (dBuV/m) = Correction factor (dB/m) + Reading(dBuV).

2. Correction factor (dB/m) = Antenna Factor (dB/m) + Cable loss (dB) – Pre-Amplifier gain (dB).

3. When peak results are less than average limit, so not need to evaluate the average.



Standard:	FCC Part 15.247	Test Distance:	3 m
Test Mode:	Mode 2	Power:	AC 120 V/60 Hz
Frequency:	2402 MHz	Temp.(°C)/Hum.(%RH):	26(°C)/60 %RH
Ant.Polar.:	Vertical		

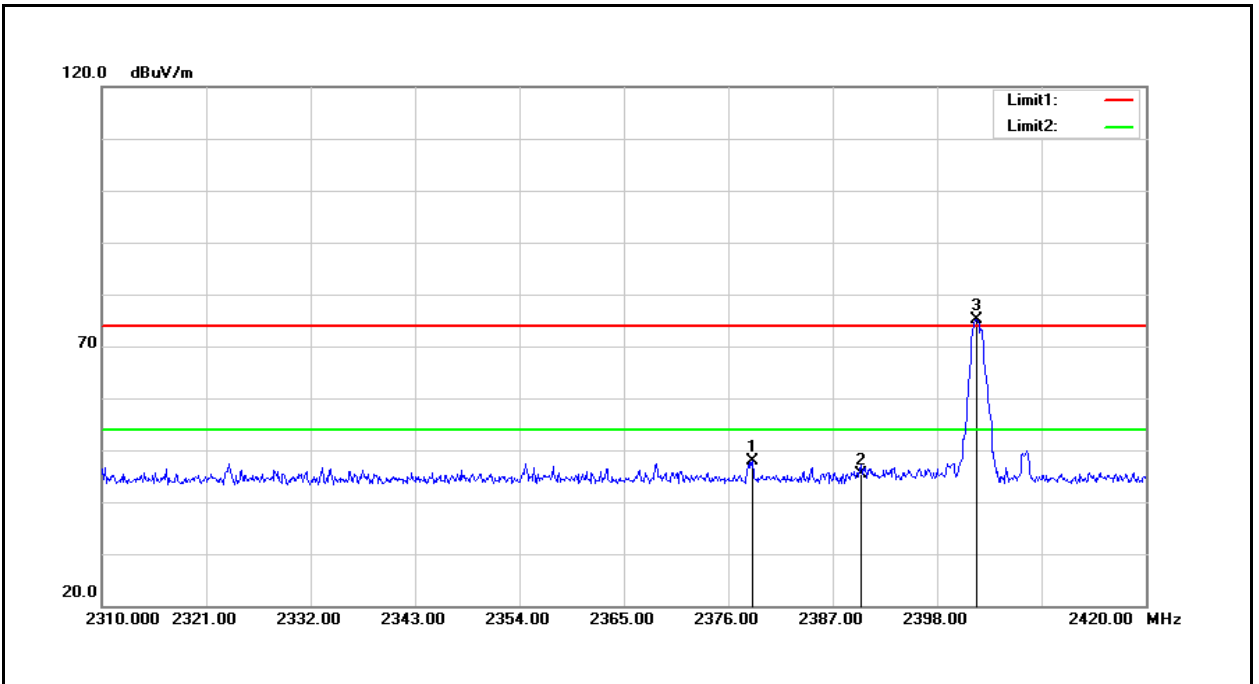

No.	Frequency (MHz)	Reading (dBuV)	Correct Factor (dB/m)	Result (dBuV/m)	Limit (dBuV/m)	Margin (dB)	Remark
1	2378.530	58.77	-10.87	47.90	74.00	-26.10	peak
2	2390.000	56.31	-10.85	45.46	74.00	-28.54	peak
3	2402.180	86.01	-10.82	75.19	---	---	peak

- Note: 1. Result (dBuV/m) = Correction factor (dB/m) + Reading(dBuV).
 2. Correction factor (dB/m) = Antenna Factor (dB/m) + Cable loss (dB) – Pre-Amplifier gain (dB).
 3. When peak results are less than average limit, so not need to evaluate the average.



Standard:	FCC Part 15.247	Test Distance:	3 m
Test Mode:	Mode 2	Power:	AC 120 V/60 Hz
Frequency:	2480 MHz	Temp.(°C)/Hum.(%RH):	26(°C)/60 %RH
Ant.Polar.:	Horizontal		

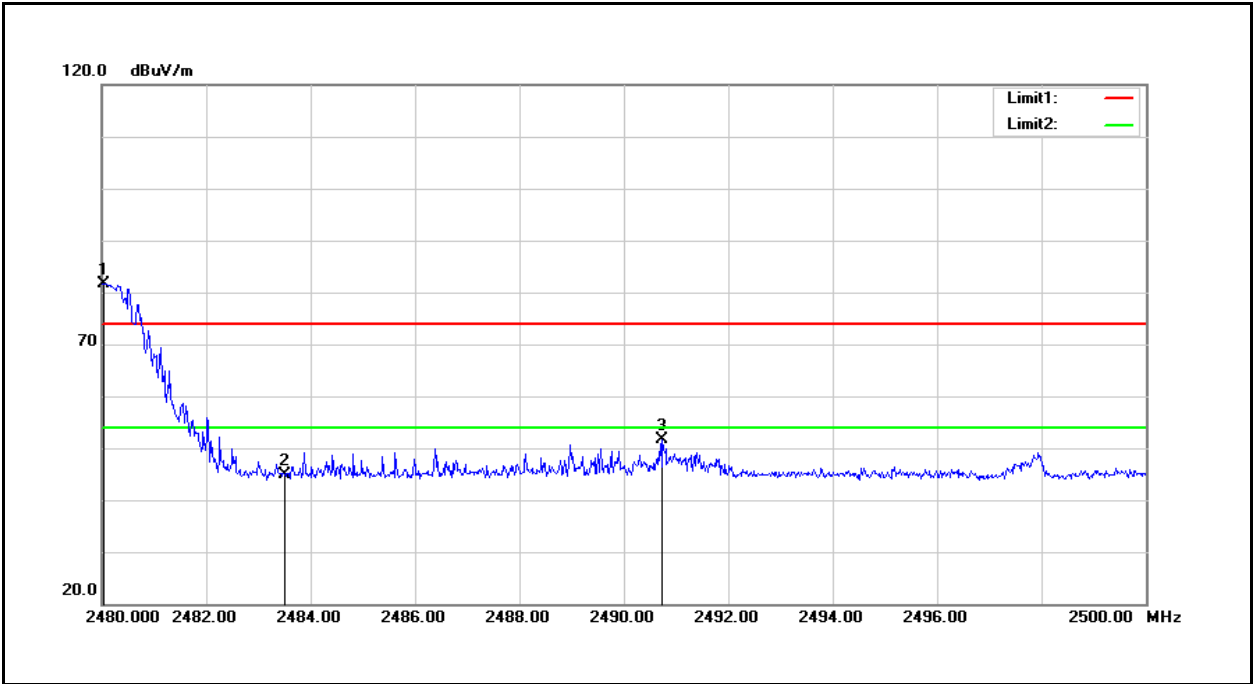

No.	Frequency (MHz)	Reading (dBuV)	Correct Factor (dB/m)	Result (dBuV/m)	Limit (dBuV/m)	Margin (dB)	Remark
1	2480.040	92.28	-10.66	81.62	---	---	peak
2	2483.500	55.43	-10.65	44.78	74.00	-29.22	peak
3	2490.740	62.32	-10.64	51.68	74.00	-22.32	peak

- Note: 1. Result (dBuV/m) = Correction factor (dB/m) + Reading(dBuV).
 2. Correction factor (dB/m) = Antenna Factor (dB/m) + Cable loss (dB) – Pre-Amplifier gain (dB).
 3. When peak results are less than average limit, so not need to evaluate the average.



Standard:	FCC Part 15.247	Test Distance:	3 m
Test Mode:	Mode 2	Power:	AC 120 V/60 Hz
Frequency:	2480 MHz	Temp.(°C)/Hum.(%RH):	26(°C)/60 %RH
Ant.Polar.:	Vertical		

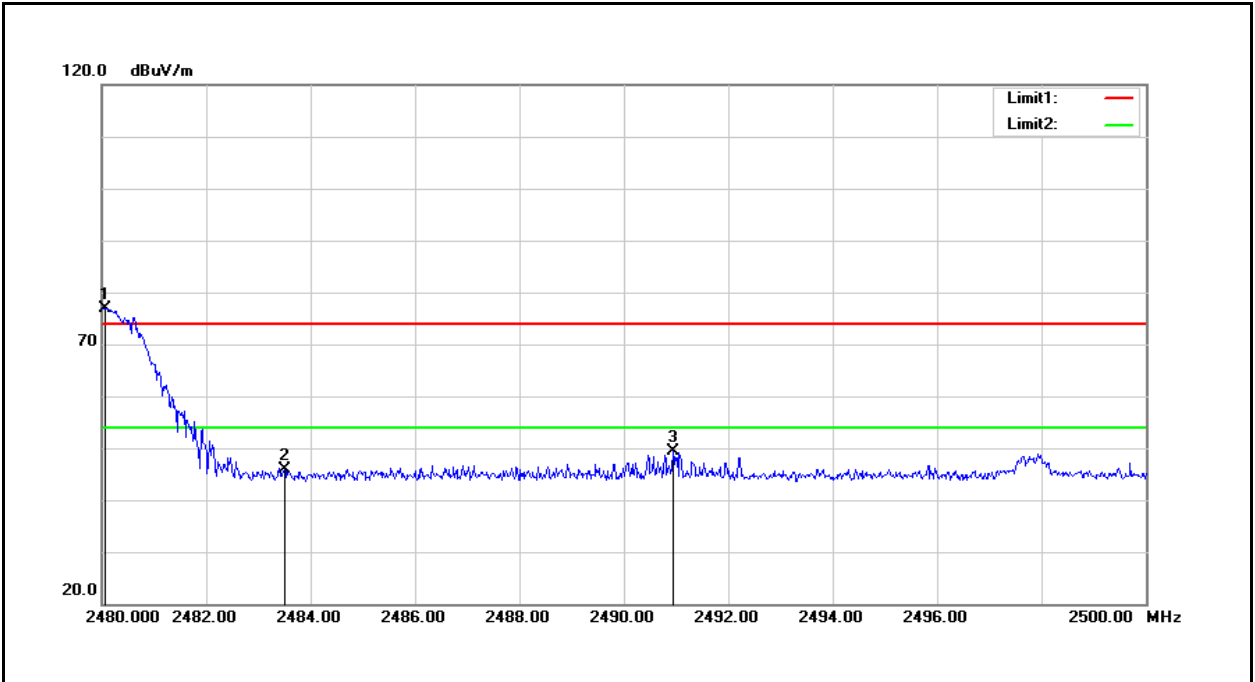

No.	Frequency (MHz)	Reading (dBuV)	Correct Factor (dB/m)	Result (dBuV/m)	Limit (dBuV/m)	Margin (dB)	Remark
1	2480.060	87.61	-10.66	76.95	---	---	peak
2	2483.500	56.61	-10.65	45.96	74.00	-28.04	peak
3	2490.940	59.96	-10.64	49.32	74.00	-24.68	peak

Note: 1. Result (dBuV/m) = Correction factor (dB/m) + Reading(dBuV).

2. Correction factor (dB/m) = Antenna Factor (dB/m) + Cable loss (dB) – Pre-Amplifier gain (dB).

3. When peak results are less than average limit, so not need to evaluate the average.