

# MEASUREMENT REPORT

## FCC PART 15.407/ WLAN 802.11a/n/ac/ax

---

**FCC ID:** TK4WPQ618  
**Applicant:** Compex Systems Pte Ltd  
**Application Type:** Certification  
**Product:** Wireless Access Point  
**Model No.:** WPQ618  
**Brand Name:** COMPEX  
**FCC Classification:** Unlicensed National Information Infrastructure (NII)  
**FCC Rule Part(s):** Part15 Subpart E (Section 15.407)  
**Test Procedure(s):** ANSI C63.10-2013, KDB 789033 D02v02r01  
KDB 662911 D01v02r01  
**Test Date:** July 17 ~ August 07, 2021

**Reviewed By:**

\_\_\_\_\_  
Kevin Guo

**Approved By:**

\_\_\_\_\_  
Robin Wu



The test results relate only to the samples tested.

This equipment has been shown to be capable of compliance with the applicable technical standards as indicated in the measurement report and was tested in accordance with the measurement procedures specified in KDB 789033 D02v02r01. Test results reported here in relate only to the item(s) tested.

The test report shall not be reproduced except in full without the written approval of MRT Technology (Suzhou) Co., Ltd.

---

### Revision History

Report No.	Version	Description	Issue Date	Note
2106RSU040-U2	Rev. 01	Initial Report	09-30-2021	Valid

---

# CONTENTS

Description	Page
<b>1. General Information.....</b>	<b>5</b>
1.1. Applicant.....	5
1.2. Manufacturer .....	5
1.3. Testing Facility .....	5
1.4. Product Information .....	6
1.5. Radio Specification .....	6
1.6. Working Frequencies .....	7
1.7. Antenna Details .....	8
1.8. Test Mode.....	8
1.9. Test System Connection Diagram.....	9
1.10. Test System Details .....	9
1.11. Test Software.....	9
1.12. Duty Cycle .....	10
1.13. Test Environment Condition .....	11
<b>2. Antenna Requirements.....</b>	<b>12</b>
<b>3. Test Equipment Calibration Date .....</b>	<b>13</b>
<b>4. Measurement Uncertainty .....</b>	<b>15</b>
<b>5. Test Result.....</b>	<b>16</b>
5.1. Summary .....	16
5.2. 26dB Bandwidth Measurement.....	17
5.2.1. Test Limit .....	17
5.2.2. Test ProcedureUsed .....	17
5.2.3. Test Setting.....	17
5.2.4. Test Setup .....	17
5.2.5. Test Result.....	18
5.3. 6dB Bandwidth Measurement.....	36
5.3.1. Test Limit .....	36
5.3.2. Test Procedure Used .....	36
5.3.3. Test Setting.....	36
5.3.4. Test Setup .....	36
5.3.5. Test Result.....	37
5.4. Output Power Measurement .....	42
5.4.1. Test Limit .....	42
5.4.2. Test Procedure Used .....	42
5.4.3. Test Setting.....	42

---

5.4.4. Test Setup .....	42
5.4.5. Test Result.....	43
5.5. Transmit Power Control .....	46
5.5.1. Test Limit .....	46
5.5.2. Test Procedure Used .....	46
5.5.3. Test Setting.....	46
5.5.4. Test Setup .....	46
5.5.5. Test Result.....	46
5.6. Power Spectral Density Measurement .....	47
5.6.1. Test Limit .....	47
5.6.2. Test Procedure Used .....	47
5.6.3. Test Setting.....	47
5.6.4. Test Setup .....	48
5.6.5. Test Result.....	49
5.7. Radiated Spurious Emission Measurement .....	82
5.7.1. Test Limit .....	82
5.7.2. Test Procedure Used .....	82
5.7.3. Test Setting.....	82
5.7.4. Test Setup .....	84
5.7.5. Test Result.....	85
5.8. Radiated Restricted Band Edge Measurement .....	158
5.8.1. Test Limit .....	158
5.8.2. Test Procedure Used .....	159
5.8.3. Test Setting.....	160
5.8.4. Test Setup .....	161
5.8.5. Test Result.....	162
5.9. AC Conducted Emissions Measurement.....	284
5.9.1. Test Limit .....	284
5.9.2. Test Setup .....	284
5.9.3. Test Result.....	285
<b>6. Conclusion .....</b>	<b>287</b>
<b>Appendix A - Test Setup Photograph .....</b>	<b>288</b>
<b>Appendix B - EUT Photograph.....</b>	<b>289</b>



#### 1.4. Product Information

Product Name	Wireless Access Point
Model No.	WPQ618
Brand Name	COMPEX
Wi-Fi Specification	802.11a/b/g/n/ac/ax
Antenna Specification	Refer to section 1.7
Power Supply	AC/DC Adapter or POE Adapter
Accessory	
Adapter	Model No.: DA-50F19 Input: 100-240V, 50/60Hz, 1.2A Output: 19.0V, 2.63A, 49.97W
Remark: The information of EUT was provided by the manufacturer, and the accuracy of the information shall be the responsibility of the manufacturer.	

#### 1.5. Radio Specification

Frequency Range	For 802.11a/n-HT20/ac-VHT20/ax-HE20: 5180~5240MHz, 5260~5320MHz, 5500~5720MHz, 5745~5825MHz For 802.11n-HT40/ac-VHT40/ax-HE40: 5190~5230MHz, 5270~5310MHz, 5510~5710MHz, 5755~5795MHz For 802.11ac-VHT80/ax-HE80: 5210MHz, 5290MHz, 5530MHz, 5610 MHz, 5690MHz, 5775MHz
Type of Modulation	802.11a/n/ac: OFDM 802.11ax: OFDMA
Data Rate	802.11a: 6/9/12/18/24/36/48/54Mbps 802.11n: up to 300Mbps 802.11ac: up to 866.6Mbps 802.11ax: up to 1201Mbps

Note: For other features of this EUT, test report will be issued separately.

## 1.6. Working Frequencies

### 802.11a/n-HT20/ac-VHT20/ax-HE20

Channel	Frequency	Channel	Frequency	Channel	Frequency
36	5180 MHz	40	5200 MHz	44	5220 MHz
48	5240 MHz	52	5260 MHz	56	5280 MHz
60	5300 MHz	64	5320 MHz	100	5500 MHz
104	5520 MHz	108	5540 MHz	112	5560 MHz
116	5580 MHz	120	5600 MHz	124	5620 MHz
128	5640 MHz	132	5660 MHz	136	5680 MHz
140	5700 MHz	144	5720 MHz	149	5745 MHz
153	5765 MHz	157	5785 MHz	161	5805 MHz
165	5825 MHz	--	--	--	--

### 802.11n-HT40/ac-VHT40/ax-HE40

Channel	Frequency	Channel	Frequency	Channel	Frequency
38	5190 MHz	46	5230 MHz	54	5270 MHz
62	5310 MHz	102	5510 MHz	110	5550MHz
118	5590 MHz	126	5630 MHz	134	5670 MHz
142	5710 MHz	151	5755 MHz	159	5795 MHz

### 802.11ac-VHT80/ax-HE80

Channel	Frequency	Channel	Frequency	Channel	Frequency
42	5210 MHz	58	5290 MHz	106	5530 MHz
122	5610 MHz	138	5690 MHz	155	5775 MHz

### 1.7. Antenna Details

Antenna Type	Frequency Band (MHz)	T <sub>X</sub> Paths	Antenna Gain (dBi)	CDD Directional Gain (dBi)	
				For Power	For PSD
Omni Antenna	2412 ~ 2462	2	8.00	8.00	11.01
	5150 ~ 5850	2	5.00	5.00	8.01

Note: The EUT supports Cyclic Delay Diversity (CDD) mode, and CDD signals are correlated.

If all antennas have the same gain,  $G_{ANT}$ , Directional gain =  $G_{ANT}$  + Array Gain, where Array Gain is as follows.

- For power spectral density (PSD) measurements on all devices,  
 Array Gain =  $10 \log (N_{ANT} / N_{SS})$  dB;
- For power measurements on IEEE 802.11 devices,  
 Array Gain = 0 dB for  $N_{ANT} \leq 4$ ;

### 1.8. Test Mode

Test Mode	Mode 1: Transmit by 802.11a (6Mbps) (CDD mode)
	Mode 2: Transmit by 802.11ac-VHT20 (MCS0) (CDD mode)
	Mode 3: Transmit by 802.11ac-VHT40 (MCS0) (CDD mode)
	Mode 4: Transmit by 802.11ac-VHT80 (MCS0) (CDD mode)
	Mode 6: Transmit by 802.11ax-HE20 (MCS0) (CDD mode)
	Mode 7: Transmit by 802.11ax-HE40 (MCS0) (CDD mode)
	Mode 8: Transmit by 802.11ax-HE80 (MCS0) (CDD mode)

Note: Due to the same modulation between 802.11n and 802.11ac, so 802.11n-HT20 and HT40 are covered by 802.11ac-VHT20 and VHT40 in this report, meanwhile, power setting for 802.11n-HT20 and HT40 will not be greater than 802.11ac-VHT20 and VHT40.



### 1.9. Test System Connection Diagram

The device was tested per the guidance ANSI C63.10: 2013 was used to reference the appropriate EUT setup for radiated emissions testing and AC line conducted testing.

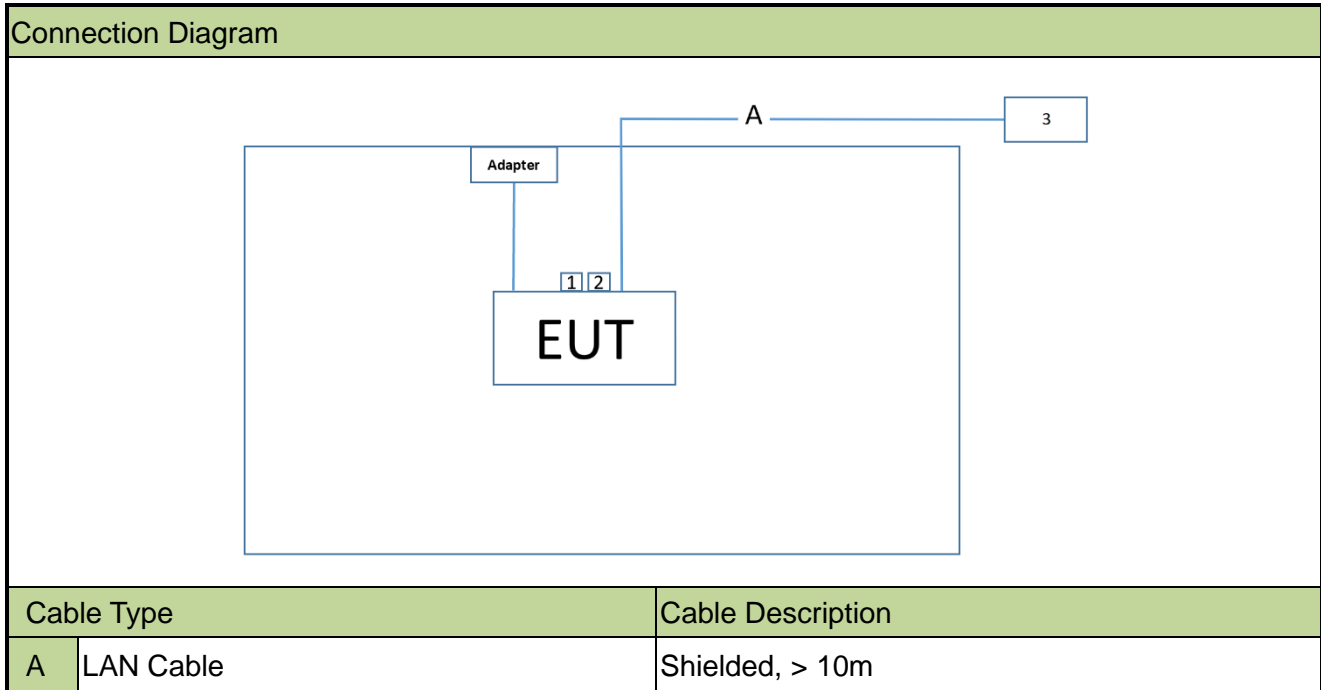

### 1.10. Test System Details

The types for all equipments, plus descriptions of all cables used in the tested system (including inserted cards) are:

Product	Manufacturer	Model No.
1~2 Simulated load	N/A	001
3 Notebook	Lenovo	X230

### 1.11. Test Software

The test utility software used during testing was engineering order provided by manufacturer.

Note: Final power setting please refer to operational description.

### 1.12. Duty Cycle

5GHz (NII) operation is possible in 20MHz, 40MHz and 80MHz channel bandwidths. The maximum achievable duty cycles for all modes were determined based on measurements performed on a spectrum analyzer in zero-span mode with RBW = 8MHz, VBW = 50MHz. The RBW and VBW were both greater than 50/T, where T is the minimum transmission duration, and the number of sweep points across T was greater than 100. The duty cycles are as follows:

Test Mode	Duty Cycle
802.11a	94.66%
802.11ac-VHT20	92.95%
802.11ac-VHT40	93.73%
802.11ac-VHT80	88.67%
802.11ax-HE20	94.26%
802.11ax-HE40	94.99%
802.11ax-HE80	94.97%

#### Duty Cycle (T = Transmission Duration)

802.11a (T = 1.950ms)

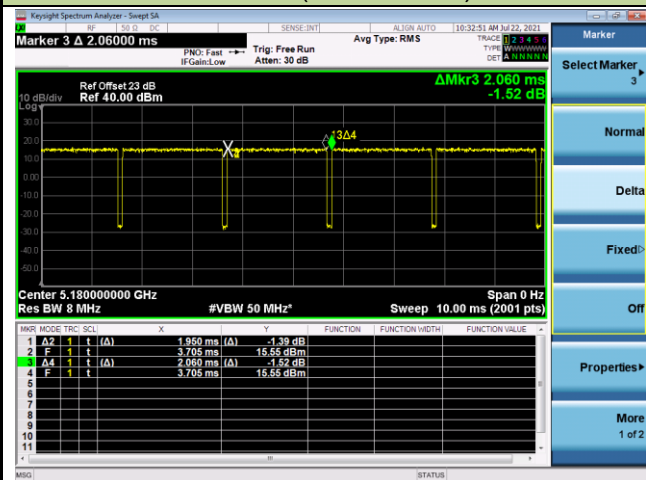

802.11ac-VHT20 (T = 5.340ms)

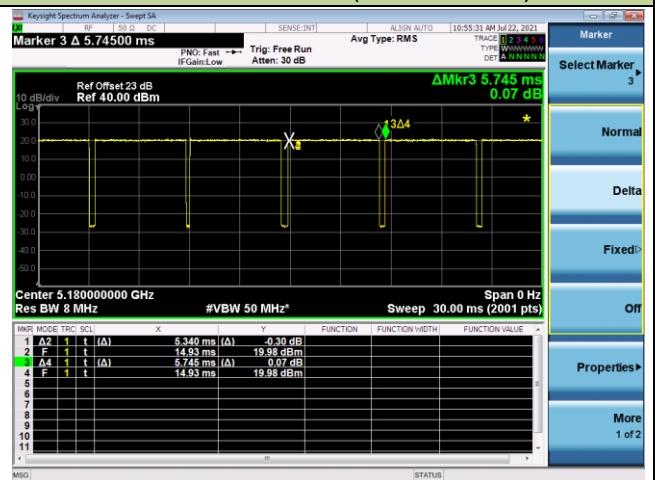

802.11ac-VHT40 (T = 5.385ms)

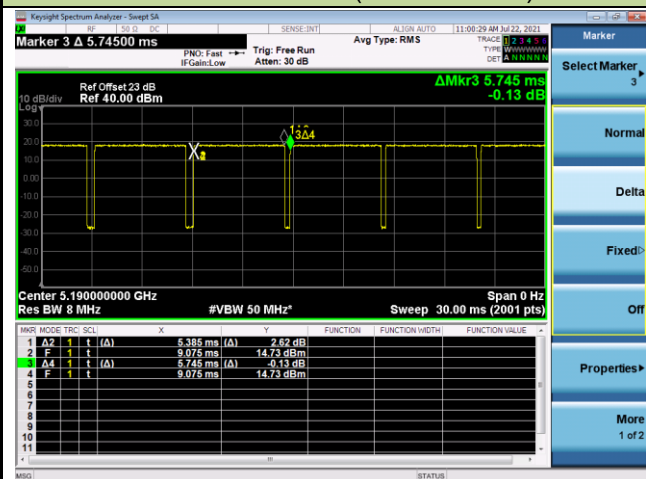

802.11ac-VHT80 (T = 5.400ms)

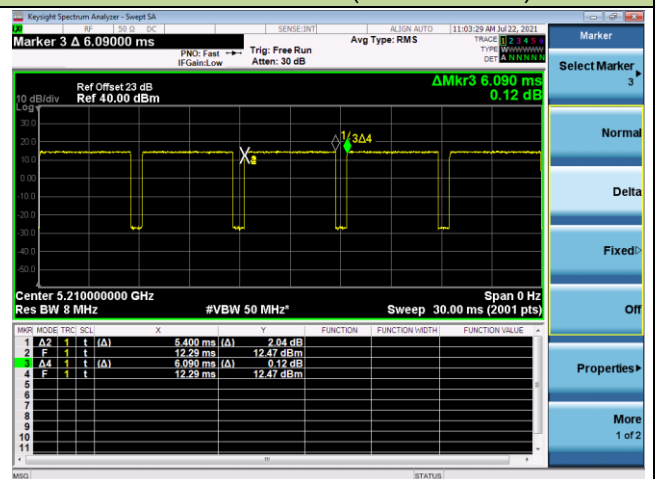

## Duty Cycle (T = Transmission Duration)

802.11ax-HE20(T = 5.415ms)

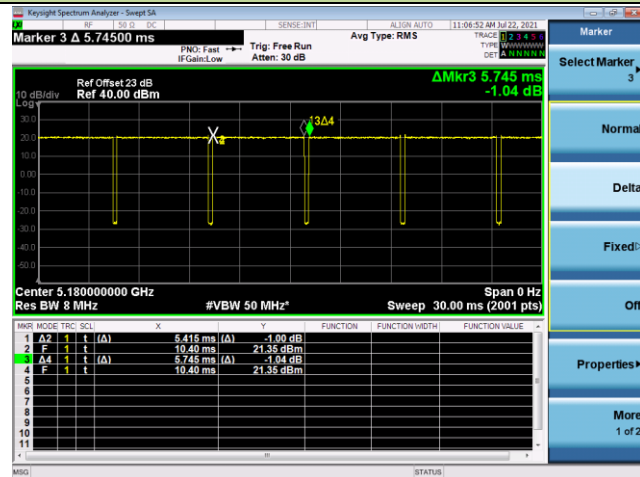

802.11ax-HE40 (T = 5.400ms)

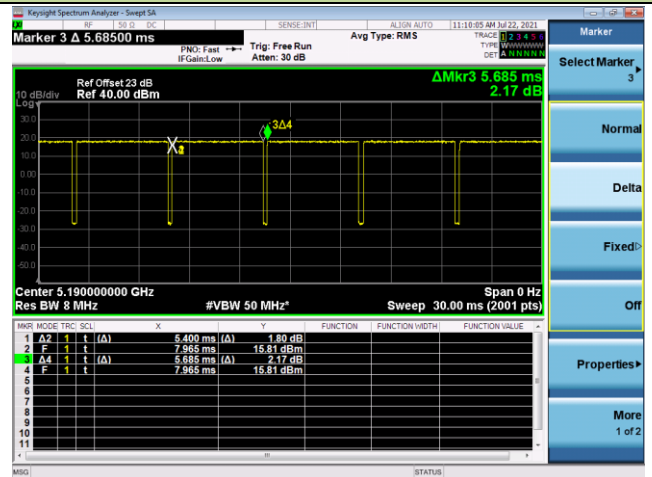

802.11ax-HE80 (T = 5.385ms)

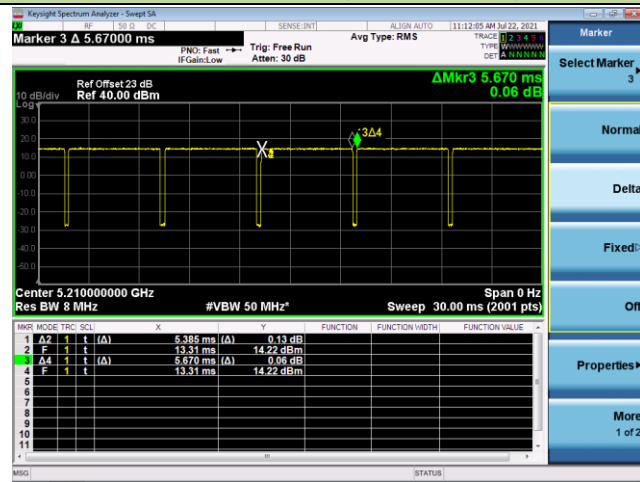

## 1.13. Test Environment Condition

Ambient Temperature	15°C~35°C
Relative Humidity	20%RH ~75%RH

## 2. Antenna Requirements

### **Excerpt from §15.203 of the FCC Rules/Regulations:**

“An intentional radiator antenna shall be designed to ensure that no antenna other than that furnished by the responsible party can be used with the device. The use of a permanently attached antenna or of an antenna that uses a unique coupling to the intentional radiator shall be considered sufficient to comply with the provisions of this section.”

- The antenna of the device uses the unique **I-PEX** connector.

### **Conclusion:**

The unit complies with the requirement of §15.203.

### 3. Test Equipment Calibration Date

#### Conducted Emission (NS-SR2)

Instrument	Manufacturer	Type No.	Asset No.	Cali. Interval	Cali. Due Date
EMI Test Receiver	R&S	ESL3	MRTSUE06576	1 year	2022/06/27
ENV216-LV-NETZNACHB	R&S	ENV216	MRTSUE06577	1 year	2022/07/04
ENV216-LV-NETZNACHB	R&S	ENV216	MRTSUE06578	1 year	2022/07/04
8-WIRE ISN	R&S	ENY81	MRTSUE06579	1 year	2022/07/04
8-WIRE ISN for CAT6	R&S	ENY81-CA6	MRTSUE06580	1 year	2022/06/15
Temperature/Humidity Meter	deli	NO.8813	MRTSUE06587	1 year	2022/06/30
Shielding Anechoic Chamber	BOOMWAVE	SR2	MRTSUE06551	5-year	2024/06/04

#### Radiated Emissions (NS-AC1)

Instrument	Manufacturer	Type No.	Asset No.	Cali. Interval	Cal. Due Date
EXA Signal Analyzer	Keysight	N9010A	MRTSUE06195	1 year	2022/03/17
EXA Signal Analyzer	Keysight	N9020A-526	MRTSUE10065	1 year	2022/06/17
EMI Test Receiver	ROHDE&SCHWARZ	ESR3	MRTSUE06575	1 year	2022/06/27
Horn Antenna	Schwarzbeck	BBHA 9170	MRTSUE06292	1 year	2021/10/24
Broad-Band Horn Antenna	Schwarzbeck	9120D	MRTSUE06572	1 year	2022/03/14
Bilog Period Antenna	Schwarzbeck	VULB 9162	MRTSUE06573	1 year	2022/06/29
Broadband Coaxial Preamplifier	Schwarzbeck	BBV 9718	MRTSUE06574	1 year	2022/07/12
Temperature/Humidity Meter	DELI	NO.8813	MRTSUE06588	1 year	2022/06/30
Anechoic Chamber	BOOMWAVE	AC1	MRTSUE06496	1 year	2022/07/24

#### Conducted Test Equipment (NS-TR2)

Instrument	Manufacturer	Type No.	Asset No.	Cali. Interval	Cali. Due Date
Thermal Hygrometer	DELI	No.8813	MRTSUE06783	1 year	2022/05/09
EXA Signal Analyzer	Keysight	N9010A	MRTSUE06195	1 year	2022/03/17
Attenuator	MVE	3dB	MRTSUE06529	1 year	2021/12/12
Attenuator	MVE	6dB	MRTSUE06534	1 year	2021/12/12
Attenuator	MVE	10dB	MRTSUE06540	1 year	2021/12/12
Attenuator	MVE	20dB	MRTSUE06547	1 year	2021/12/12
Temperature/Humidity Chamber	OK	OUKE INSTRUMENT	MRTSUE06899	1 year	2021/11/27
USB wideband power sensor	Keysight	U2021XA	MRTSUE06581	1 year	2021/08/20

---

Software	Version	Function
EMI Software	V3	EMI Test Software

## 4. Measurement Uncertainty

Where relevant, the following test uncertainty levels have been estimated for tests performed on the EUT as specified in CISPR 16-4-2. This uncertainty represents an expanded uncertainty expressed at approximately the 95% confidence level using a coverage factor of  $k = 2$ .

<b>AC Conducted Emission Measurement</b>
Measurement Uncertainty for a Level of Confidence of 95% ( $U=2Uc(y)$ ): 9kHz~150kHz: 3.74dB 150kHz~30MHz: 3.44dB
<b>Radiated Disturbance</b>
Measurement Uncertainty for a Level of Confidence of 95% ( $U=2Uc(y)$ ): Horizontal: 30MHz~300MHz: 5.04dB 300MHz~1GHz: 4.95dB 1GHz~40GHz: 6.40dB Vertical: 30MHz~300MHz: 5.24dB 300MHz~1GHz: 6.03dB 1GHz~40GHz: 6.40dB
<b>Spurious Emissions, Conducted</b>
Measuring Uncertainty for a Level of Confidence of 95% ( $U=2Uc(y)$ ): 0.78dB
<b>Output Power</b>
Measuring Uncertainty for a Level of Confidence of 95% ( $U=2Uc(y)$ ): 1.13dB
<b>Power Spectrum Density</b>
Measuring Uncertainty for a Level of Confidence of 95% ( $U=2Uc(y)$ ): 1.15dB
<b>Occupied Bandwidth</b>
Measuring Uncertainty for a Level of Confidence of 95% ( $U=2Uc(y)$ ): 0.28%

## 5. Test Result

### 5.1. Summary

FCC Section(s)	Test Description	Test Limit	Test Condition	Test Result	Reference
15.407(a)	26dB Bandwidth	N/A	Conducted	Pass	Section 5.2
15.407(e)	6dB Bandwidth	$\geq 500\text{kHz}$		Pass	Section 5.3
15.407(a)(1)(ii), (2),(3)(i)	Maximum Conducted Output Power	Refer to Section 5.4		Pass	Section 5.4
15.407(h)(1)	Transmit Power Control	$\leq 24\text{dBm}$		Pass	Section 5.5
15.407(a)(1)(ii), (2), (3)	Power Spectral Density	U-NII-1&U-NII-2: $\leq 11\text{dBm/MHz}$ U-NII-3: $\leq 30\text{dBm}/500\text{kHz}$		Pass	Section 5.6
15.407(b)(1), (2), (3), (4)(i)	Undesirable Emissions	Refer to Section 5.8	Radiated	Pass	Section 5.7 Section 5.8
15.205, 15.209 15.407(b)(7), (8), (9)	General Field Strength (Restricted Bands and Radiated Emission)	Emissions in restricted bands must meet the radiated limits detailed in 15.209		Pass	
15.207	AC Conducted Emissions 150kHz-30MHz	< FCC 15.207 limits	Line Conducted	Pass	Section 5.9

Notes:

- 1) The analyzer plots shown in this section were all taken with a correction table loaded into the analyzer. The correction table was used to account for the losses of the cables and attenuators used as part of the system to connect the EUT to the analyzer at all frequencies of interest.
- 2) Output power test was verified over all data rates of each mode (data refers to operational description), and then choose the maximum power output (low data rate) for final test of each channel.
- 3) For radiated emission test, every axis (X, Y, Z) was also verified. The test results shown in the following sections represent the worst-case emissions.
- 4) EUT supports one configuration only in 802.11ax full RU mode, i.e. 242 tone in 11ax-HE20, 484 tone in 11ax-HE40, 996 tone in 11ax-HE80.



## 5.2. 26dB Bandwidth Measurement

### 5.2.1. Test Limit

N/A

### 5.2.2. Test Procedure Used

KDB 789033 D02v02r01 -Section C.1

### 5.2.3. Test Setting

1. The analyzers' automatic bandwidth measurement capability was used to perform the 26dB bandwidth measurement. The "X" dB bandwidth parameter was set to  $X = 26$ . The automatic bandwidth measurement function also has the capability of simultaneously measuring the 99% occupied bandwidth. The bandwidth measurement was not influenced by any intermediated power nulls in the fundamental emission.
2. RBW = approximately 1% of the emission bandwidth.
3. VBW  $\geq 3 \times$  RBW.
4. Detector = Peak.
5. Trace mode = max hold.

### 5.2.4. Test Setup

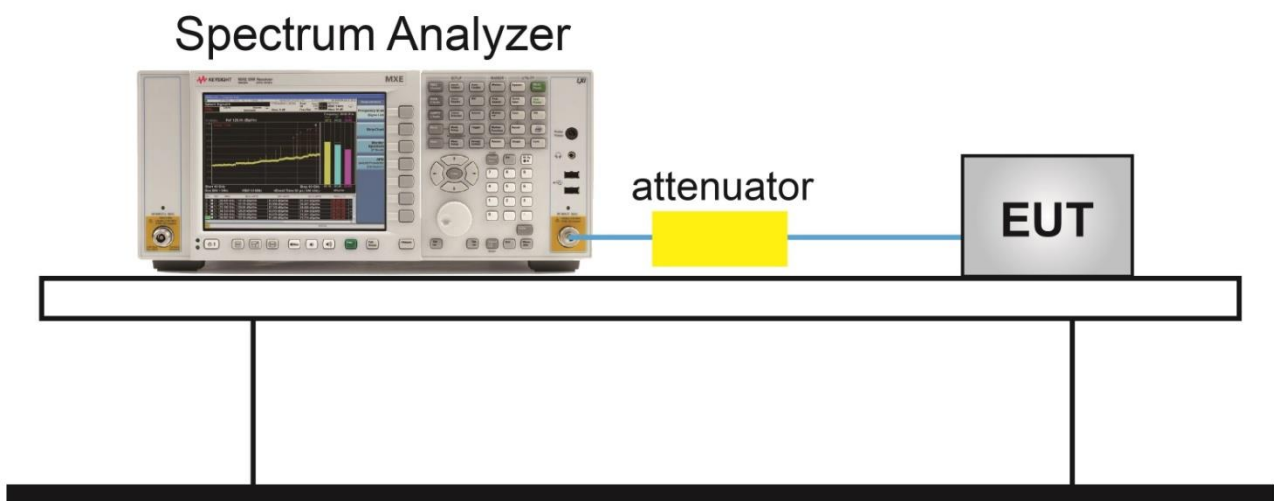

### 5.2.5. Test Result

Test Site	NS-TR2	Test Engineer	Flag Yang
Test Date	2021/08/06		

Test Mode	Data Rate/ MCS	Channel No.	Frequency (MHz)	26dB Bandwidth (MHz)
802.11a	6Mbps	36	5180	20.80
802.11a	6Mbps	44	5220	20.77
802.11a	6Mbps	48	5240	20.75
802.11a	6Mbps	52	5260	20.64
802.11a	6Mbps	60	5300	20.45
802.11a	6Mbps	64	5320	20.63
802.11a	6Mbps	100	5500	20.10
802.11a	6Mbps	116	5580	20.70
802.11a	6Mbps	140	5700	20.18
802.11a	6Mbps	144	5720	20.68
802.11a	6Mbps	149	5745	20.37
802.11a	6Mbps	157	5785	20.55
802.11a	6Mbps	165	5825	20.33
802.11ac-VHT20	MCS0	36	5180	21.65
802.11ac-VHT20	MCS0	44	5220	21.09
802.11ac-VHT20	MCS0	48	5240	21.38
802.11ac-VHT20	MCS0	52	5260	20.85
802.11ac-VHT20	MCS0	60	5300	20.72
802.11ac-VHT20	MCS0	64	5320	21.38
802.11ac-VHT20	MCS0	100	5500	20.66
802.11ac-VHT20	MCS0	116	5580	21.33
802.11ac-VHT20	MCS0	140	5700	21.34
802.11ac-VHT20	MCS0	144	5720	21.24
802.11ac-VHT20	MCS0	149	5745	20.71
802.11ac-VHT20	MCS0	157	5785	21.26
802.11ac-VHT20	MCS0	165	5825	21.26

Test Mode	Data Rate/ MCS	Channel No.	Frequency (MHz)	26dB Bandwidth (MHz)
802.11ac-VHT40	MCS0	38	5190	41.27
802.11ac-VHT40	MCS0	46	5230	40.97
802.11ac-VHT40	MCS0	54	5270	40.62
802.11ac-VHT40	MCS0	62	5310	40.29
802.11ac-VHT40	MCS0	102	5510	40.10
802.11ac-VHT40	MCS0	110	5550	40.80
802.11ac-VHT40	MCS0	134	5670	40.12
802.11ac-VHT40	MCS0	142	5710	40.21
802.11ac-VHT40	MCS0	151	5755	40.20
802.11ac-VHT40	MCS0	159	5795	40.57
802.11ac-VHT80	MCS0	42	5210	81.26
802.11ac-VHT80	MCS0	58	5290	81.39
802.11ac-VHT80	MCS0	106	5530	81.33
802.11ac-VHT80	MCS0	122	5610	80.82
802.11ac-VHT80	MCS0	138	5690	81.61
802.11ac-VHT80	MCS0	155	5775	80.94
802.11ax-HE20	MCS0	36	5180	21.57
802.11ax-HE20	MCS0	44	5220	21.85
802.11ax-HE20	MCS0	48	5240	20.90
802.11ax-HE20	MCS0	52	5260	21.31
802.11ax-HE20	MCS0	60	5300	21.00
802.11ax-HE20	MCS0	64	5320	21.16
802.11ax-HE20	MCS0	100	5500	21.42
802.11ax-HE20	MCS0	116	5580	21.22
802.11ax-HE20	MCS0	140	5700	21.46
802.11ax-HE20	MCS0	144	5720	21.12
802.11ax-HE20	MCS0	149	5745	21.68
802.11ax-HE20	MCS0	157	5785	21.26
802.11ax-HE20	MCS0	165	5825	21.33

Test Mode	Data Rate/ MCS	Channel No.	Frequency (MHz)	26dB Bandwidth (MHz)
802.11ax-HE40	MCS0	38	5190	40.41
802.11ax-HE40	MCS0	46	5230	40.93
802.11ax-HE40	MCS0	54	5270	40.00
802.11ax-HE40	MCS0	62	5310	41.01
802.11ax-HE40	MCS0	102	5510	40.77
802.11ax-HE40	MCS0	110	5550	40.16
802.11ax-HE40	MCS0	134	5670	40.83
802.11ax-HE40	MCS0	142	5710	40.45
802.11ax-HE40	MCS0	151	5755	40.29
802.11ax-HE40	MCS0	159	5795	40.54
802.11ax-HE80	MCS0	42	5210	81.59
802.11ax-HE80	MCS0	58	5290	81.77
802.11ax-HE80	MCS0	106	5530	81.49
802.11ax-HE80	MCS0	122	5610	82.42
802.11ax-HE80	MCS0	138	5690	81.94
802.11ax-HE80	MCS0	155	5775	81.89

## 802.11a 26dB Bandwidth

## Channel 36 (5180MHz)

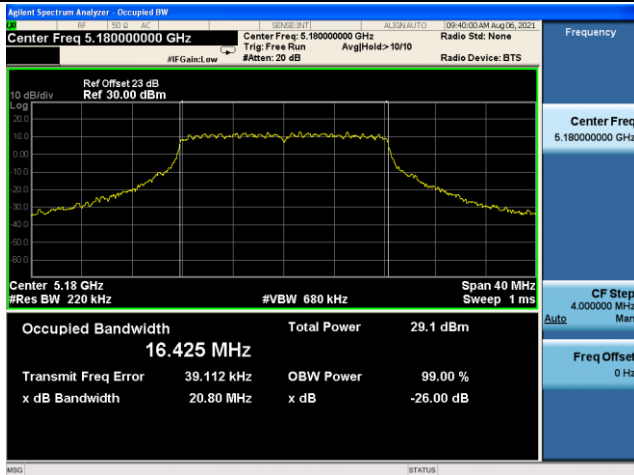

## Channel 44 (5220MHz)

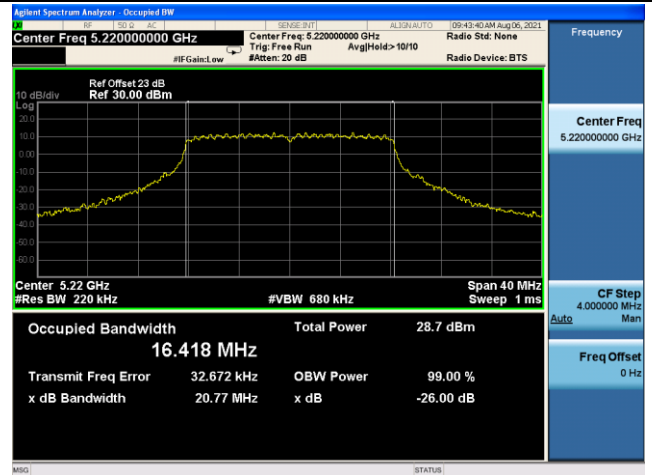

## Channel 48 (5240MHz)

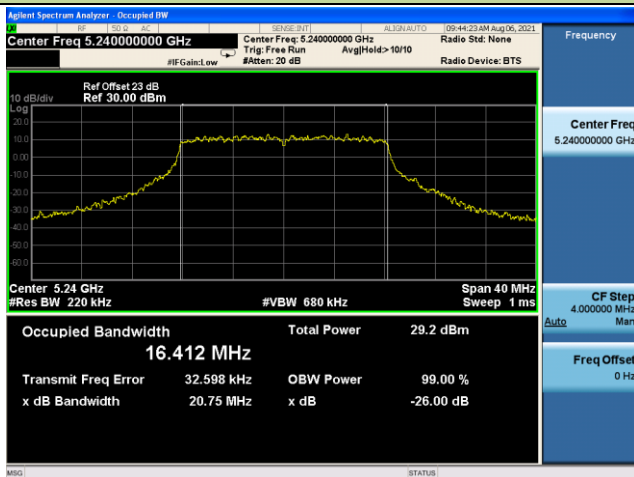

## Channel 52 (5260MHz)

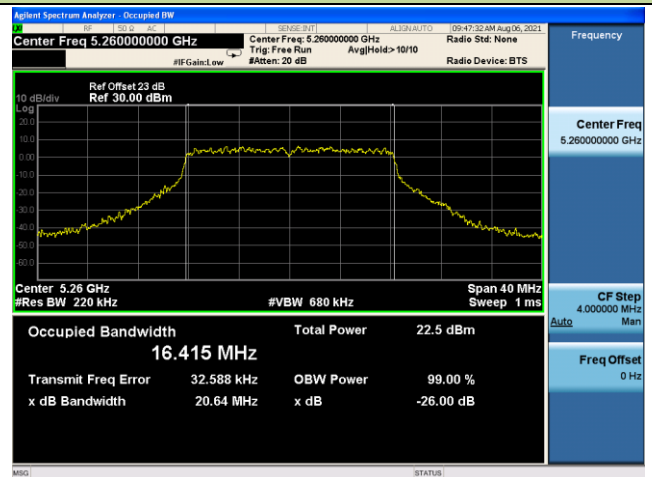

## Channel 60 (5300MHz)

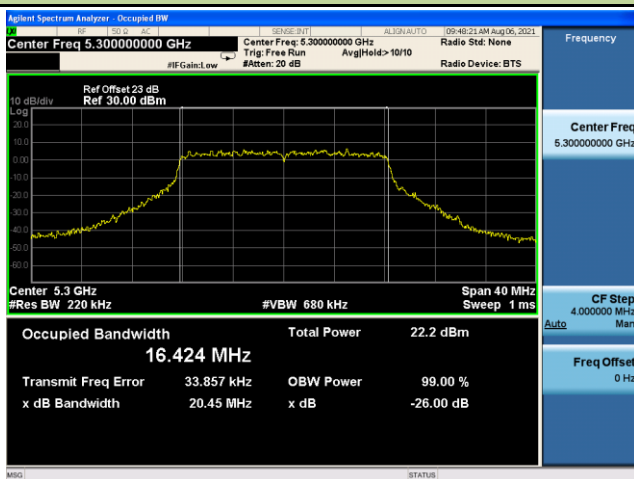

## Channel 64 (5320MHz)

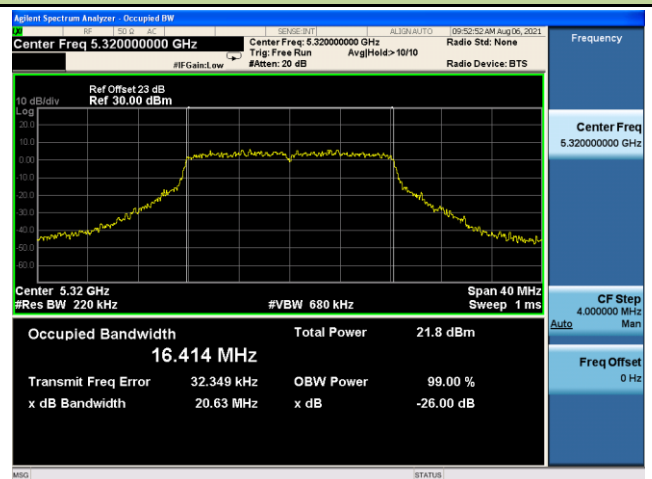

## 802.11a 26dB Bandwidth

## Channel 100 (5500MHz)

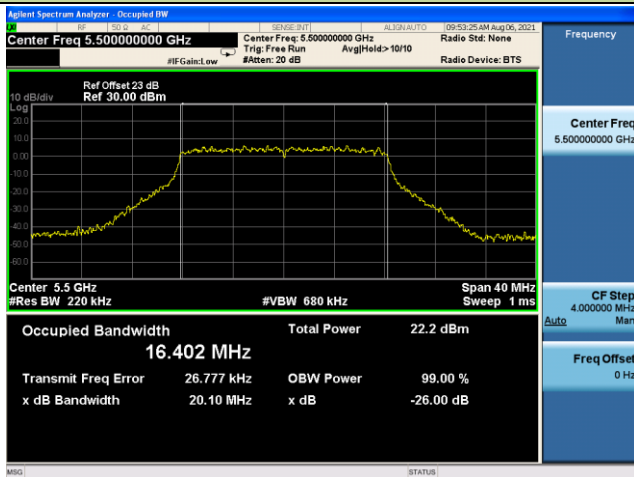

## Channel 116 (5580MHz)

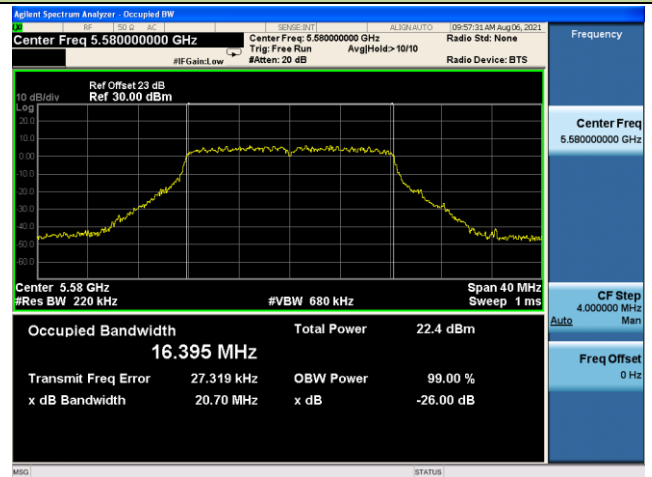

## Channel 140 (5700MHz)

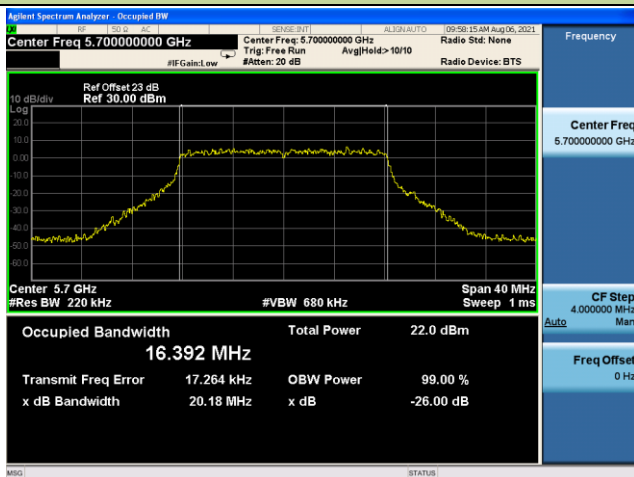

## Channel 144 (5720MHz)

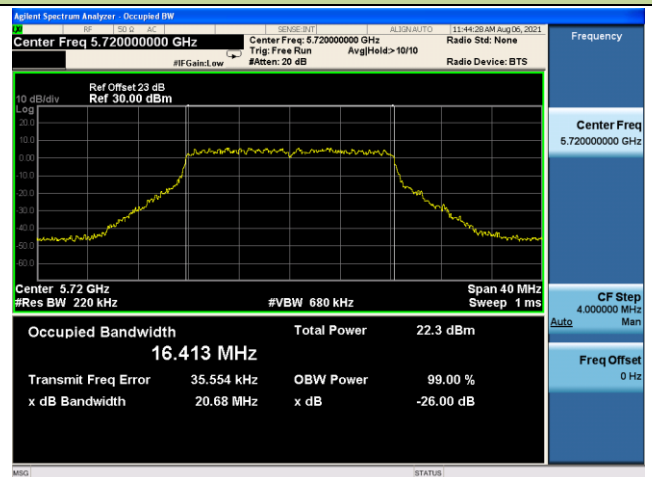

## Channel 149 (5745MHz)

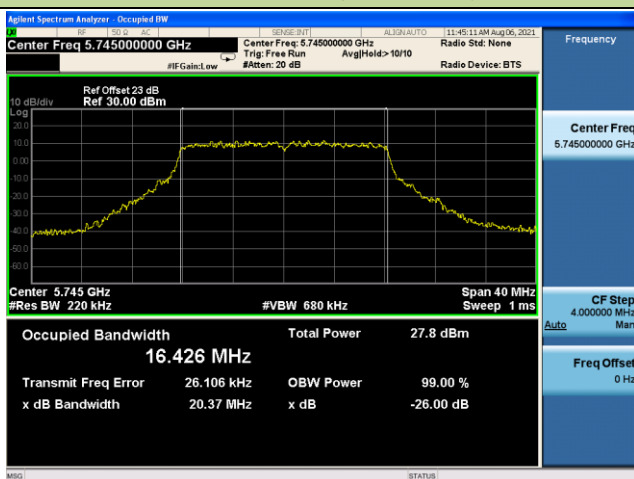

## Channel 157 (5785MHz)

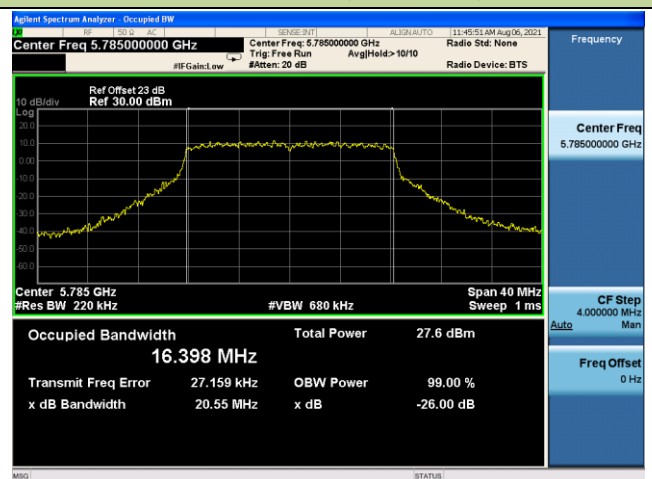

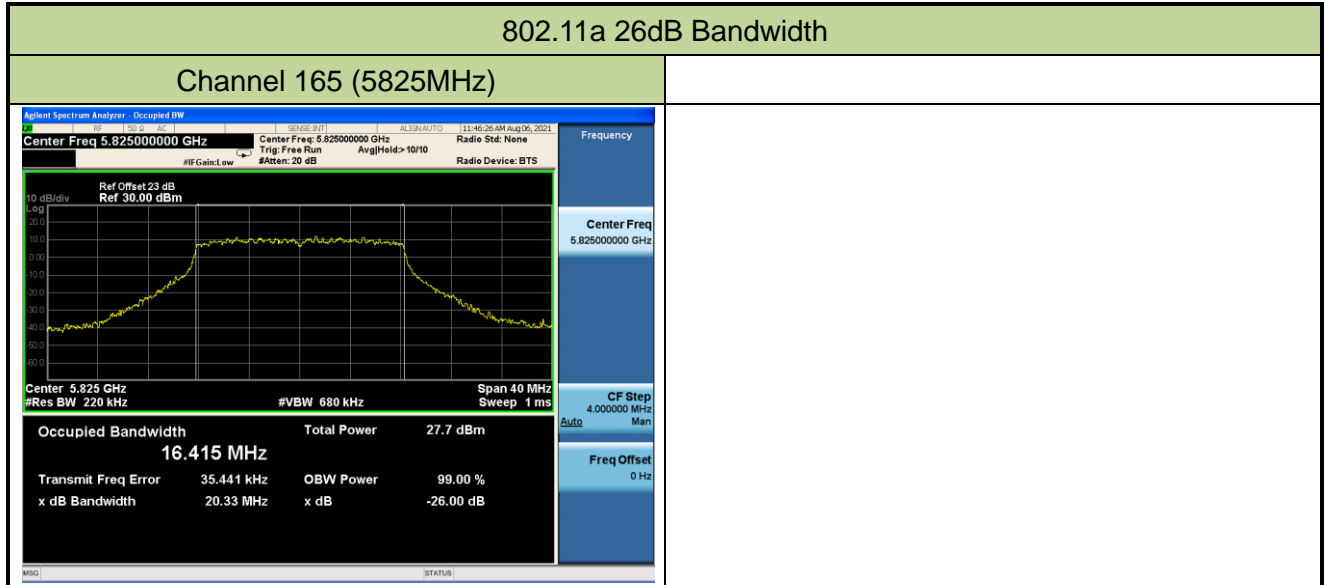

## 802.11ac-VHT20 26dB Bandwidth

## Channel 36 (5180MHz)

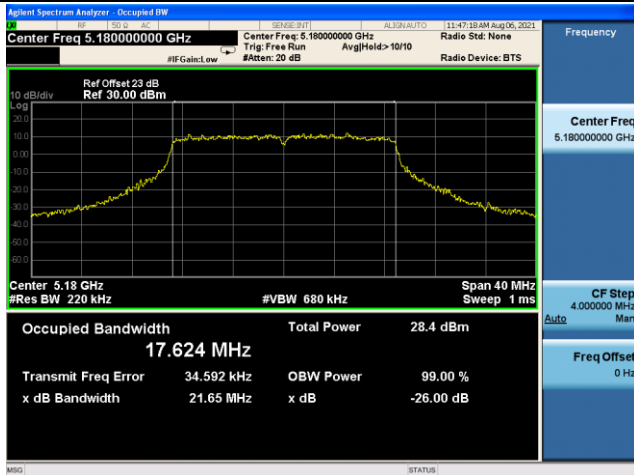

## Channel 44 (5220MHz)

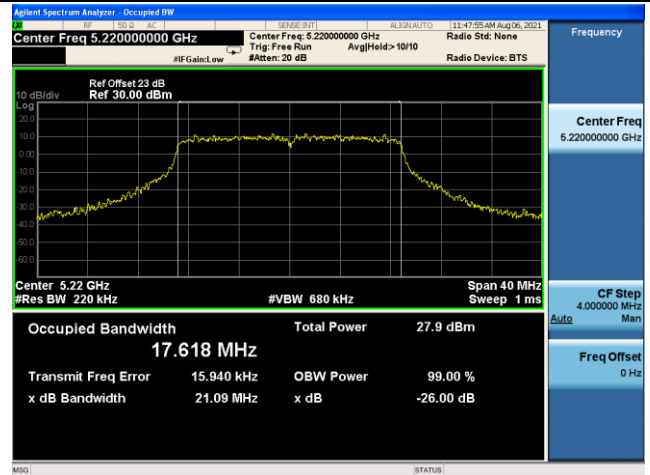

## Channel 48 (5240MHz)



## Channel 52 (5260MHz)

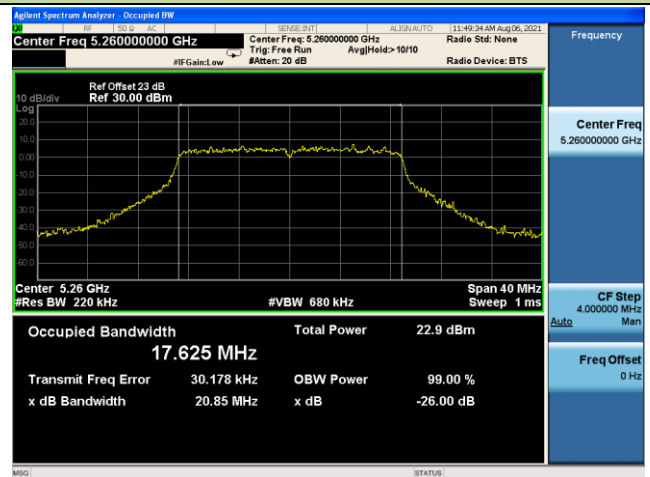

## Channel 60 (5300MHz)

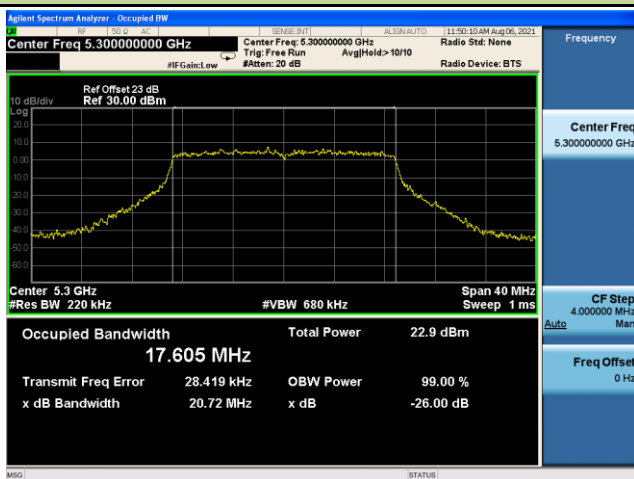

## Channel 64 (5320MHz)

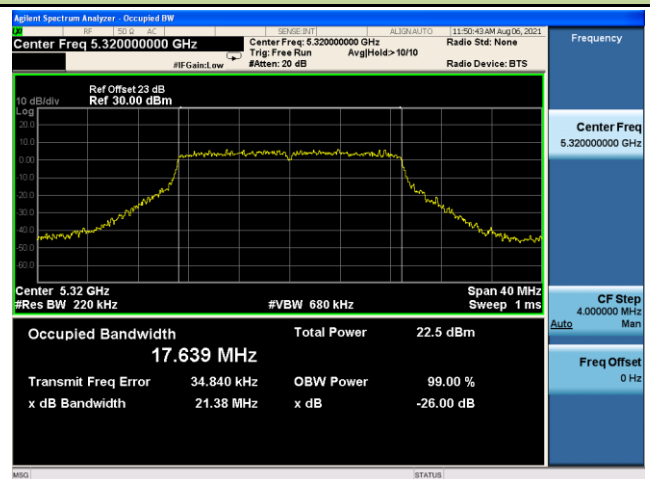



## 802.11ac-VHT20 26dB Bandwidth

## Channel 100 (5500MHz)

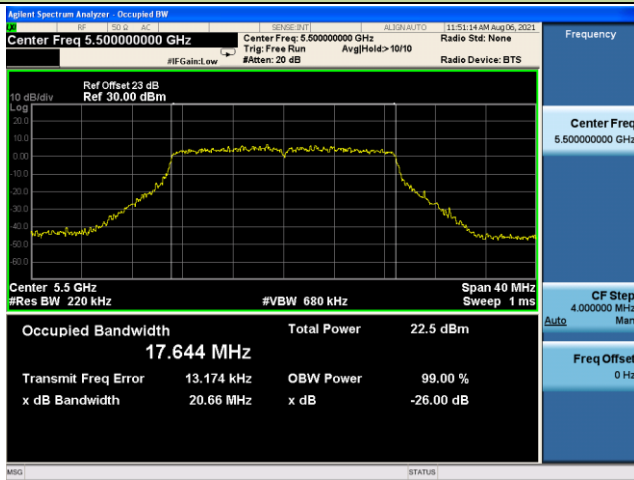

## Channel 116 (5580MHz)

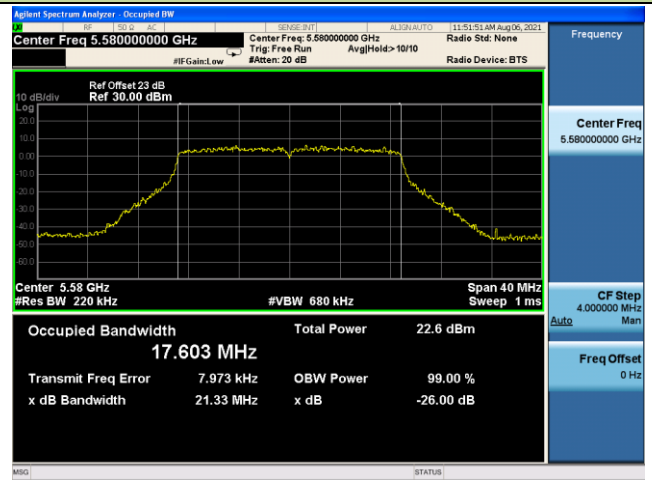

## Channel 140 (5700MHz)

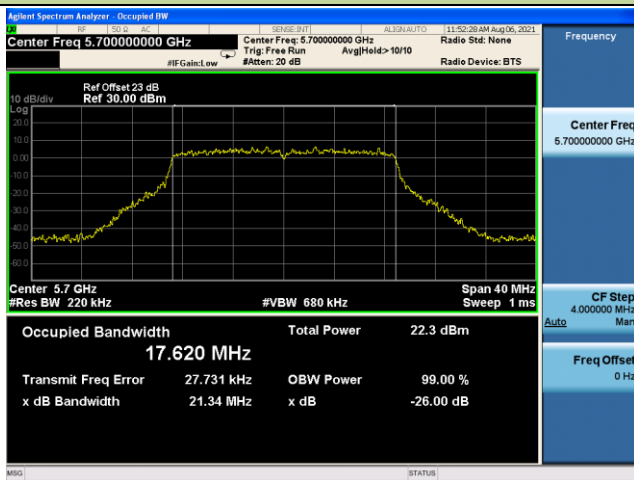

## Channel 144 (5720MHz)

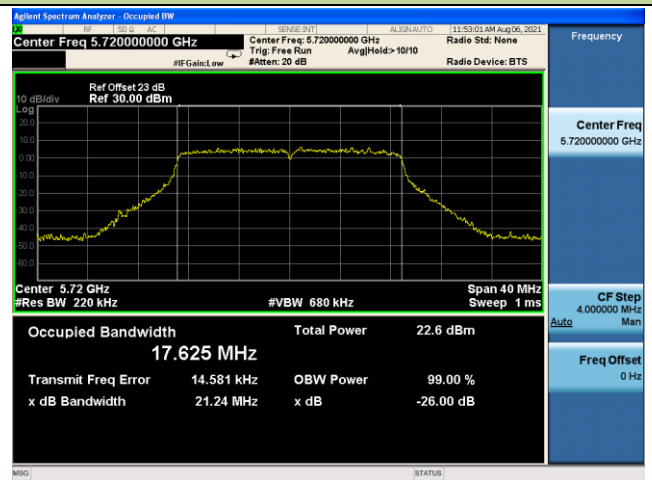

## Channel 149 (5745MHz)

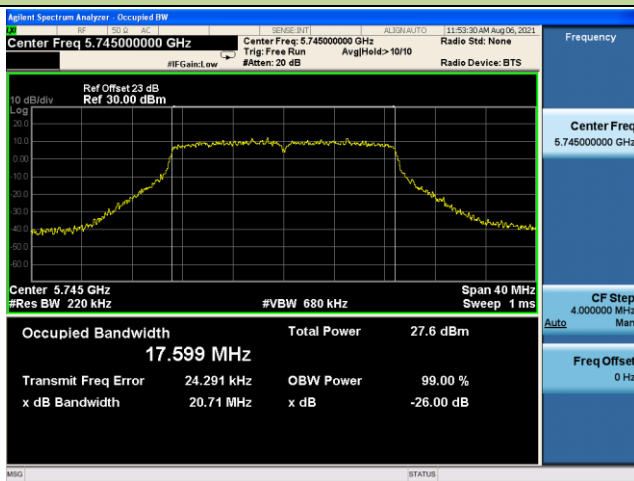

## Channel 157 (5785MHz)



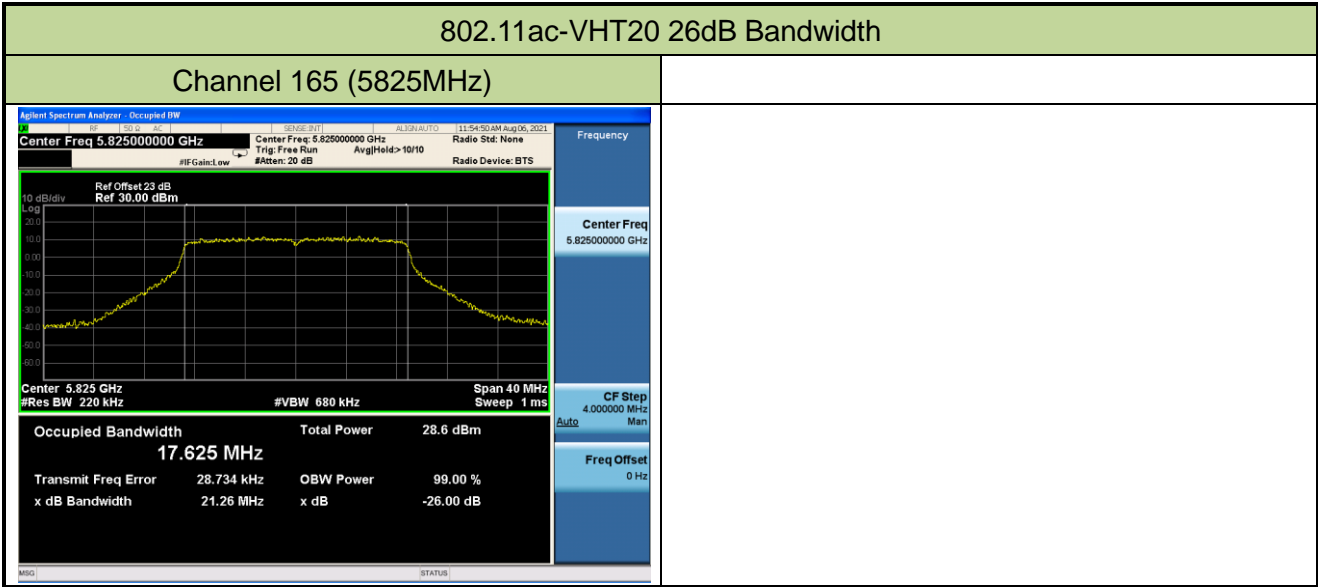

## 802.11ac-VHT40 26dB Bandwidth

## Channel 38 (5190MHz)

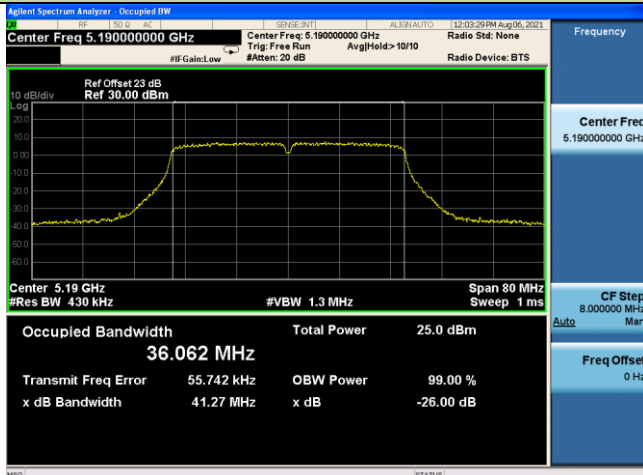

## Channel 46 (5230MHz)

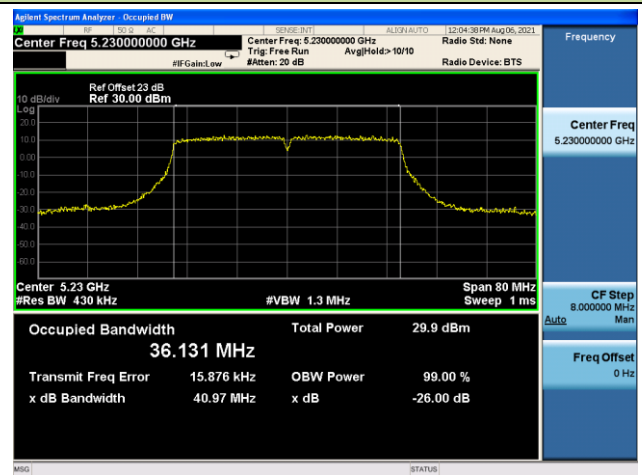

## Channel 54 (5270MHz)

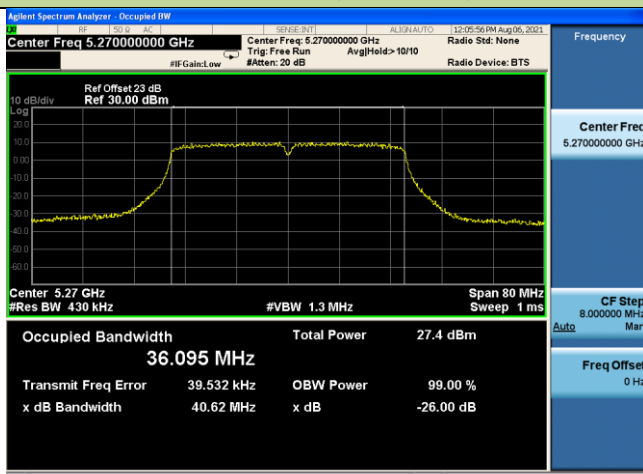

## Channel 62 (5310MHz)

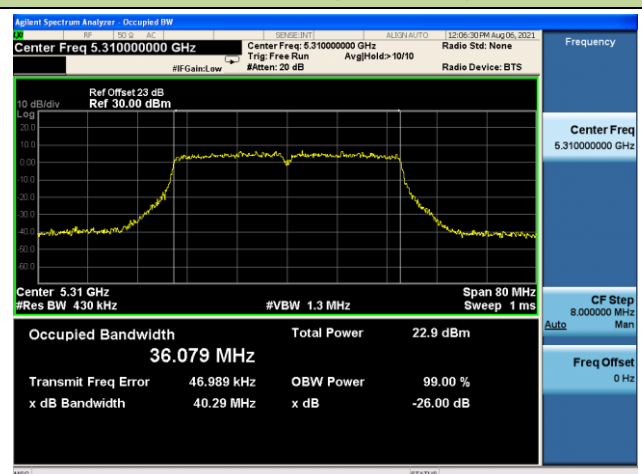

## Channel 102 (5510MHz)

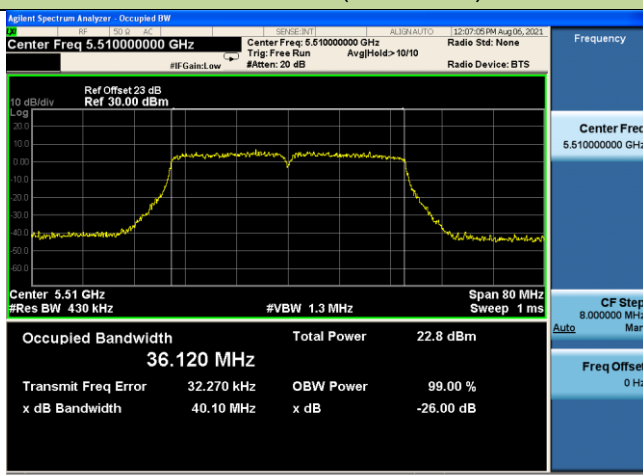

## Channel 110 (5550MHz)

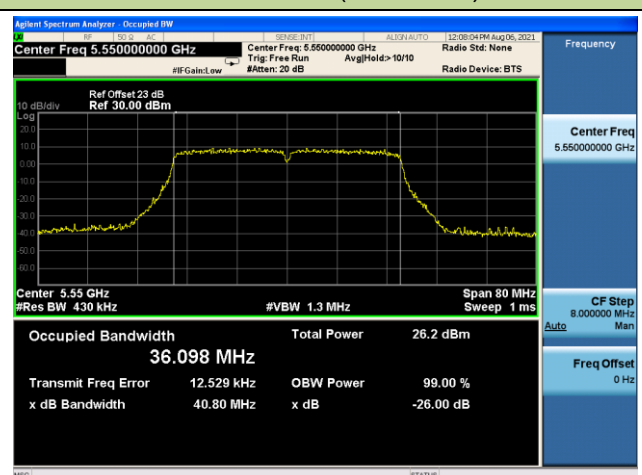

## 802.11ac-VHT40 26dB Bandwidth

## Channel 134 (5670MHz)

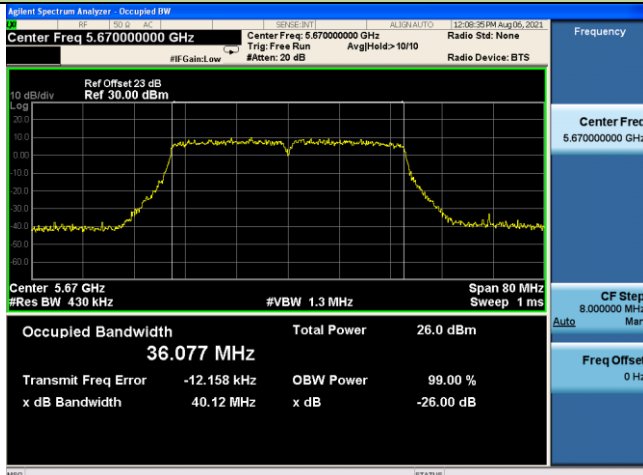

## Channel 142 (5710MHz)

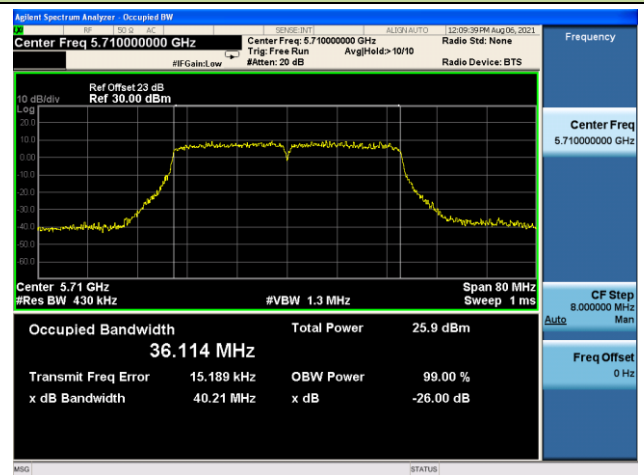

## Channel 151 (5755MHz)

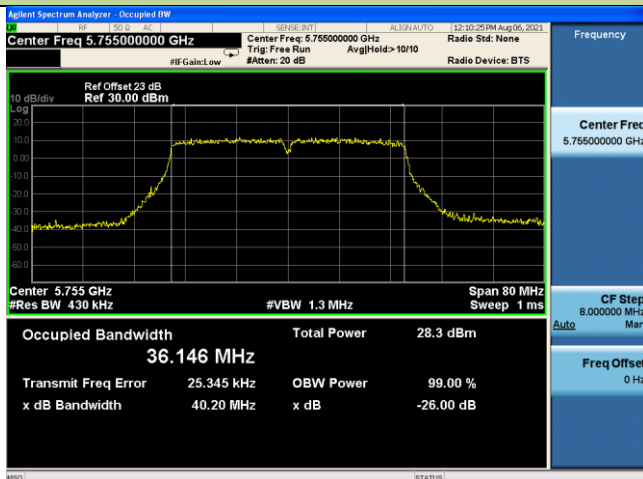

## Channel 159 (5795MHz)

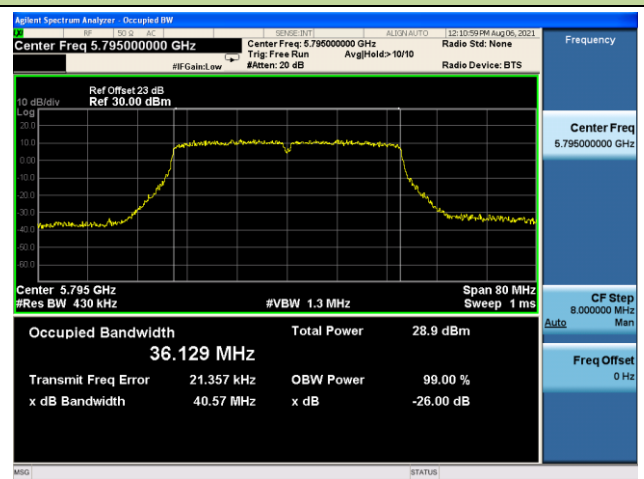

## 802.11ac-VHT80 26dB Bandwidth

## Channel 42 (5210MHz)

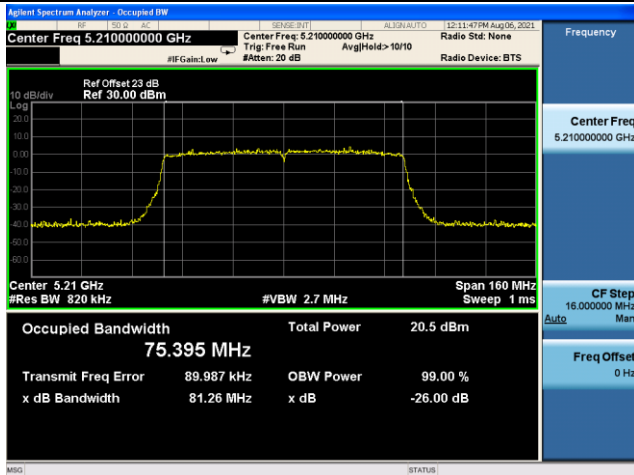

## Channel 58 (5290MHz)

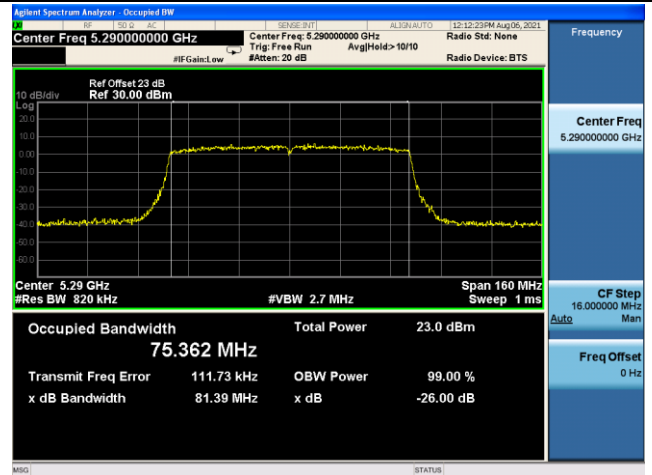

## Channel 106 (5530MHz)

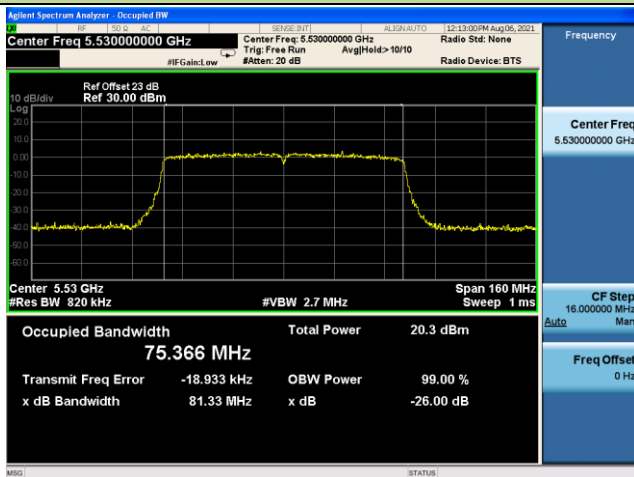

## Channel 122 (5610MHz)

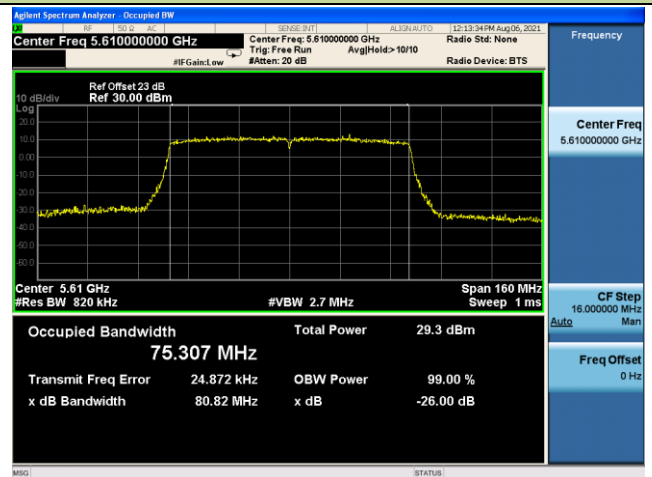

## Channel 138 (5690MHz)

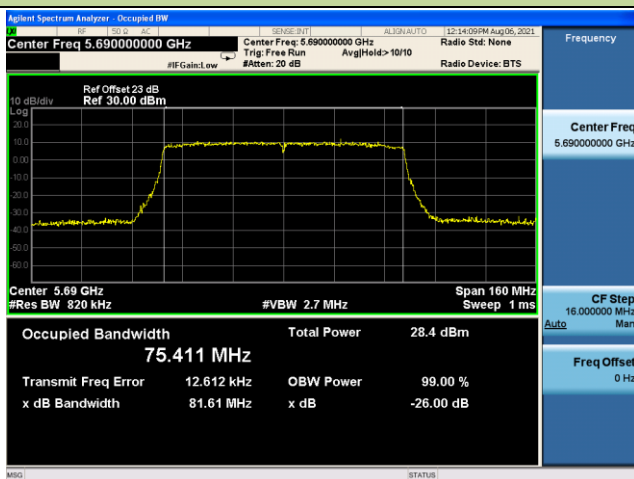

## Channel 155 (5775MHz)

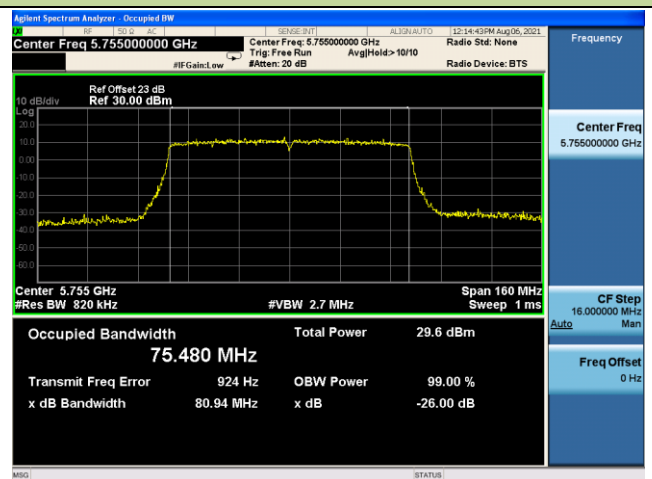

## 802.11ax-HE20 26dB Bandwidth

## Channel 36 (5180MHz)

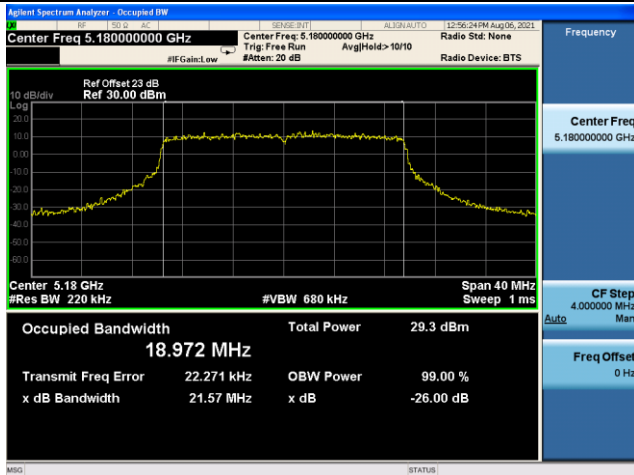

## Channel 44 (5220MHz)

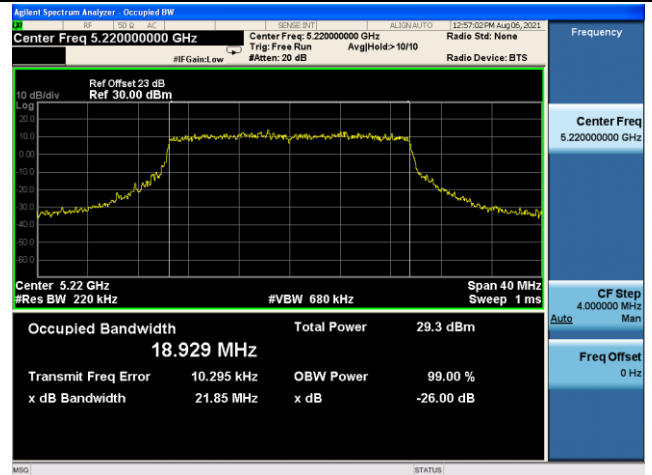

## Channel 48 (5240MHz)

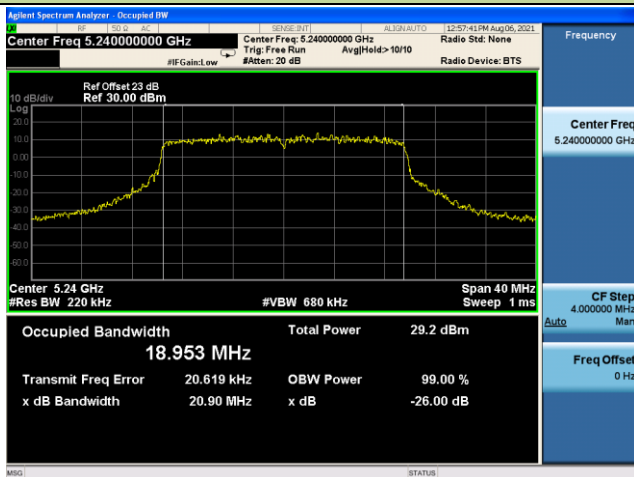

## Channel 52 (5260MHz)

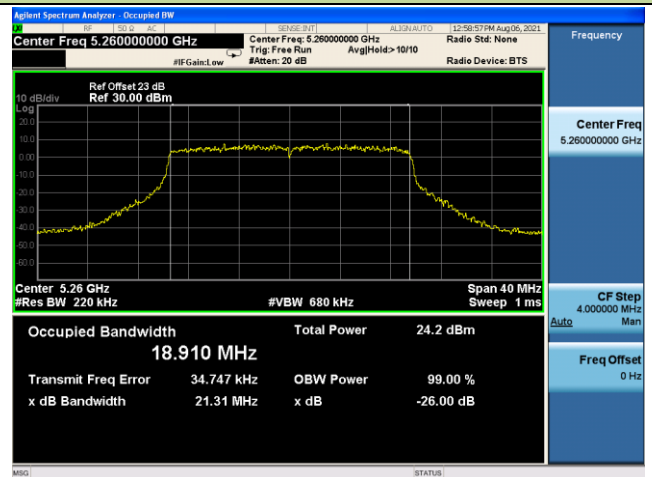

## Channel 60 (5300MHz)

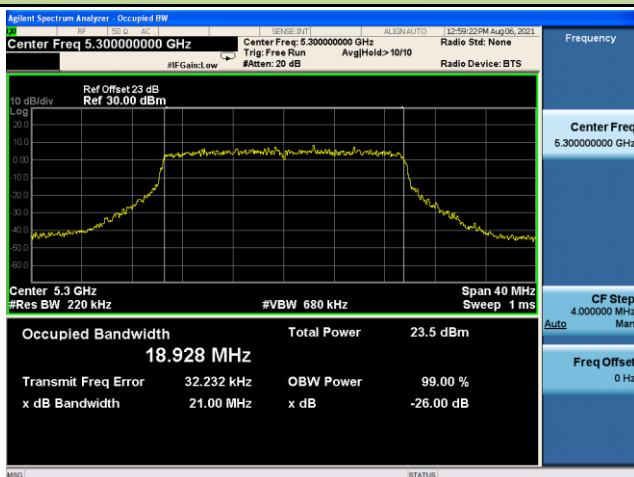

## Channel 64 (5320MHz)

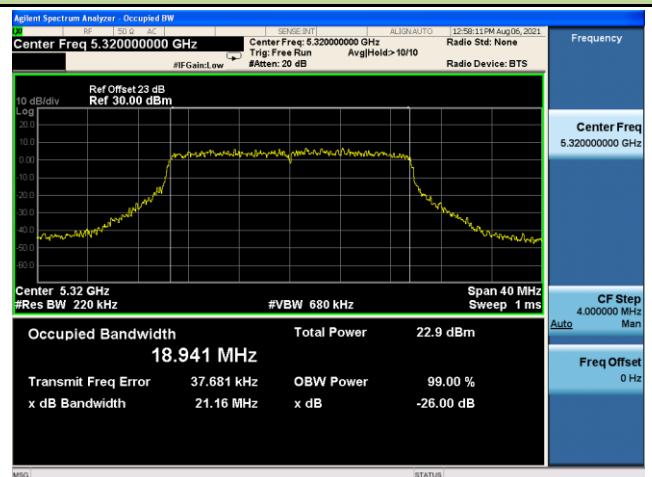

## 802.11ax-HE20 26dB Bandwidth

## Channel 100 (5500MHz)

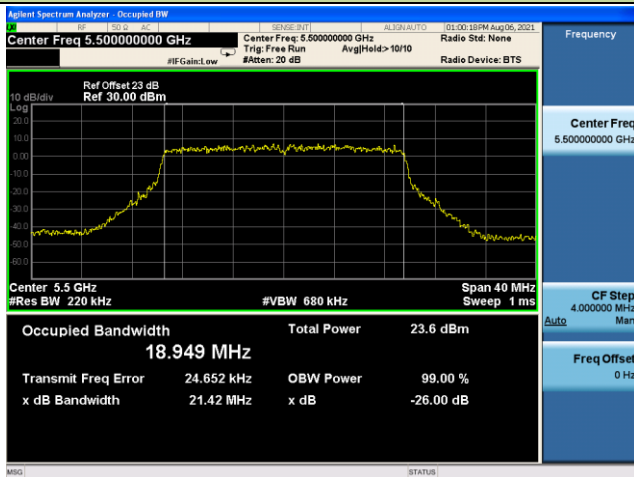

## Channel 116 (5580MHz)

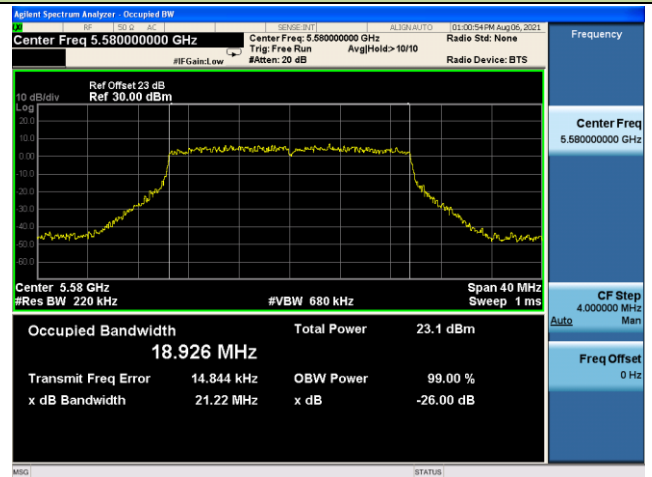

## Channel 140 (5700MHz)

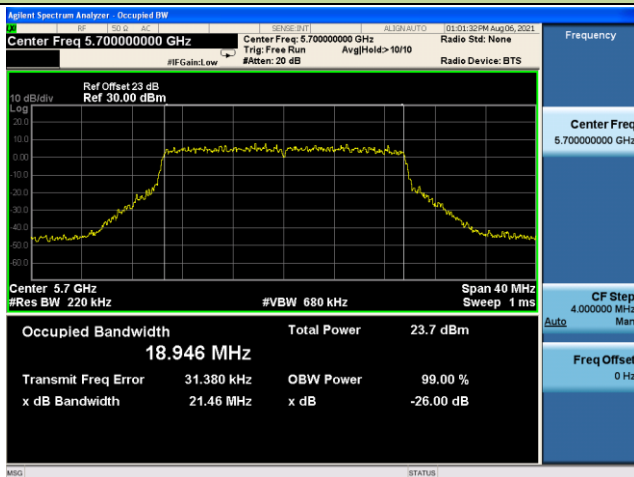

## Channel 144 (5720MHz)

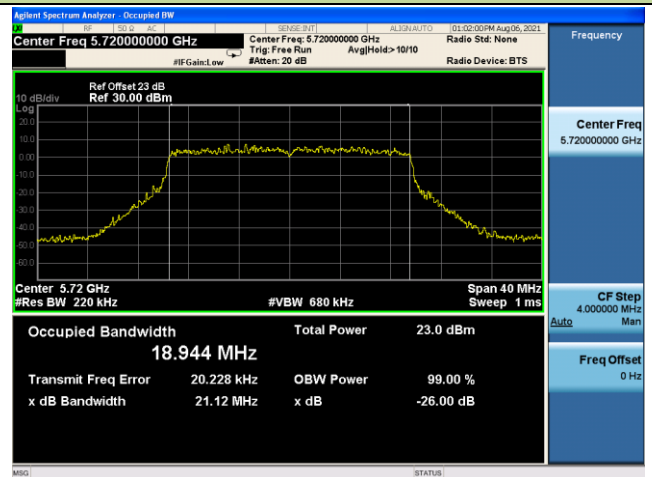

## Channel 149 (5745MHz)



## Channel 157 (5785MHz)

