



MEASUREMENT REPORT

FCC PART 15C / WLAN 802.11b/g/n/ax

FCC ID: TK4WPQ618
Applicant: Compex Systems Pte Ltd
Application Type: Certification
Product: Wireless Access Point
Model No.: WPQ618
Brand Name: COMPEX
FCC Classification: Digital Transmission System (DTS)
FCC Rule Part(s): Part 15 Subpart C (Section 15.247)
Test Procedure(s): ANSI C63.10-2013
Test Date: July 17 ~ August 07, 2021

Reviewed By:

Kevin Guo

Approved By:

Robin Wu



The test results relate only to the samples tested.

This equipment has been shown to be capable of compliance with the applicable technical standards as indicated in the measurement report and was tested in accordance with the measurement procedures specified in ANSI C63.10-2013. Test results reported herein relate only to the item(s) tested.

The test report shall not be reproduced except in full without the written approval of MRT Technology (Suzhou) Co., Ltd.

Revision History

Report No.	Version	Description	Issue Date	Note
2106RSU040-U1	Rev. 01	Initial Report	09-30-2021	Valid

CONTENTS

Description	Page
1. General Information.....	5
1.1. Applicant.....	5
1.2. Manufacturer	5
1.3. Testing Facility	5
1.4. Product Information	6
1.5. Radio Specification	6
1.6. Working Frequencies	7
1.7. Antenna Details	7
1.8. Test Mode.....	8
1.9. Test System Connection Diagram.....	8
1.10. Test System Details	8
1.11. Test Software.....	8
1.12. Duty Cycle	9
1.13. Test Environment Condition	10
2. Antenna Requirements.....	11
3. Test Equipment Calibration Date	12
4. Measurement Uncertainty	14
5. Test Result.....	15
5.1. Summary	15
5.2. 6dB Bandwidth Measurement.....	16
5.2.1. Test Limit	16
5.2.2. Test Procedure used.....	16
5.2.3. Test Setting.....	16
5.2.4. Test Setup.....	16
5.2.5. Test Result.....	17
5.3. Output Power Measurement.....	24
5.3.1. Test Limit	24
5.3.2. Test Procedure Used	24
5.3.3. Test Setting.....	24
5.3.4. Test Setup.....	24
5.3.5. Test Result.....	25
5.4. Power Spectral Density Measurement.....	26
5.4.1. Test Limit	26
5.4.2. Test Procedure Used	26
5.4.3. Test Setting.....	26

5.4.4.	Test Setup.....	27
5.4.5.	Test Result.....	28
5.5.	Conducted Band Edge and Out-of-Band Emissions.....	41
5.5.1.	Test Limit	41
5.5.2.	Test Procedure Used	41
5.5.3.	Test Setting.....	41
5.5.4.	Test Setup.....	42
5.5.5.	Test Result.....	43
5.6.	Radiated Spurious Emission Measurement	68
5.6.1.	Test Limit	68
5.6.2.	Test Procedure Used	68
5.6.3.	Test Setting.....	68
5.6.4.	Test Setup.....	70
5.6.5.	Test Result.....	71
5.7.	Radiated Restricted Band Edge Measurement	79
5.7.1.	Test Limit	79
5.7.2.	Test Procedure Used	80
5.7.3.	Test Setting.....	80
5.7.4.	Test Setup.....	81
5.7.5.	Test Result.....	82
5.8.	AC Conducted Emissions Measurement.....	168
5.8.1.	Test Limit	168
5.8.2.	Test Setup.....	168
5.8.3.	Test Result.....	169
6.	Conclusion.....	171
	Appendix A - Test Setup Photograph	172
	Appendix B - EUT Photograph.....	173

1.4. Product Information

Product Name	Wireless Access Point
Model No.	WPQ618
Brand Name	COMPEX
Wi-Fi Specification	802.11a/b/g/n/ac/ax
Antenna Specification	Refer to section 1.7
EUT Identification No.	20210622Sample#14 (Conducted) 20210622Sample#16 (Radiated & AC conducted emission)
Power Supply	AC/DC Adapter or POE Adapter
Accessory	
Adapter	Model No.: DA-50F19 Input: 100-240V, 50/60Hz, 1.2A Output: 19.0V, 2.63A, 49.97W
Remark: The information of EUT was provided by the manufacturer, and the accuracy of the information shall be the responsibility of the manufacturer.	

1.5. Radio Specification

Frequency Range	802.11b/g/n-HT20/ax-HE20: 2412 ~ 2462MHz 802.11n-HT40/ax-HE40: 2422 ~ 2452MHz
Channel Number	802.11b/g/n-HT20/ax-HE20: 11 802.11n-HT40/ax-HE40: 7
Type of Modulation	802.11b: DSSS 802.11g/n: OFDM 802.11ax: OFDMA
Data Rate	802.11b: 1/2/5.5/11Mbps 802.11g: 6/9/12/18/24/36/48/54Mbps 802.11n: up to 300Mbps 802.11ax: up to 573.6Mbps

Note: For other features of this EUT, test report will be issued separately.

1.6. Working Frequencies

802.11b/g/n-HT20/ax-HE20

Channel	Frequency	Channel	Frequency	Channel	Frequency
01	2412 MHz	02	2417 MHz	03	2422 MHz
04	2427 MHz	05	2432 MHz	06	2437 MHz
07	2442 MHz	08	2447 MHz	09	2452 MHz
10	2457 MHz	11	2462 MHz	--	--

802.11n-HT40/ax-HE40

Channel	Frequency	Channel	Frequency	Channel	Frequency
03	2422 MHz	04	2427 MHz	05	2432 MHz
06	2437 MHz	07	2442 MHz	08	2447 MHz
09	2452 MHz	--	--	--	--

1.7. Antenna Details

Antenna Type	Frequency Band (MHz)	T _x Paths	Antenna Gain (dBi)	CDD Directional Gain (dBi)	
				For Power	For PSD
Omni Antenna	2412 ~ 2462	2	8.00	8.00	11.01
	5150 ~ 5850	2	5.00	5.00	8.01

Note: The EUT supports Cyclic Delay Diversity (CDD) mode, and CDD signals are correlated.

If all antennas have the same gain, G_{ANT} , Directional gain = G_{ANT} + Array Gain, where Array Gain is as follows.

- For power spectral density (PSD) measurements on all devices,
Array Gain = $10 \log (N_{ANT} / N_{SS})$ dB;
- For power measurements on IEEE 802.11 devices,
Array Gain = 0 dB for $N_{ANT} \leq 4$;

1.8. Test Mode

Test Mode	Mode 1: Transmit by 802.11b (1Mbps) (CDD mode)
	Mode 2: Transmit by 802.11g (6Mbps) (CDD mode)
	Mode 3: Transmit by 802.11n-HT20 (MCS0) (CDD mode)
	Mode 4: Transmit by 802.11n-HT40 (MCS0) (CDD mode)
	Mode 5: Transmit by 802.11ax-HE20 (MCS0) (CDD mode)
	Mode 6: Transmit by 802.11ax-HE40 (MCS0) (CDD mode)

1.9. Test System Connection Diagram

The device was tested per the guidance ANSI C63.10: 2013 was used to reference the appropriate EUT setup for radiated emissions testing and AC line conducted testing.

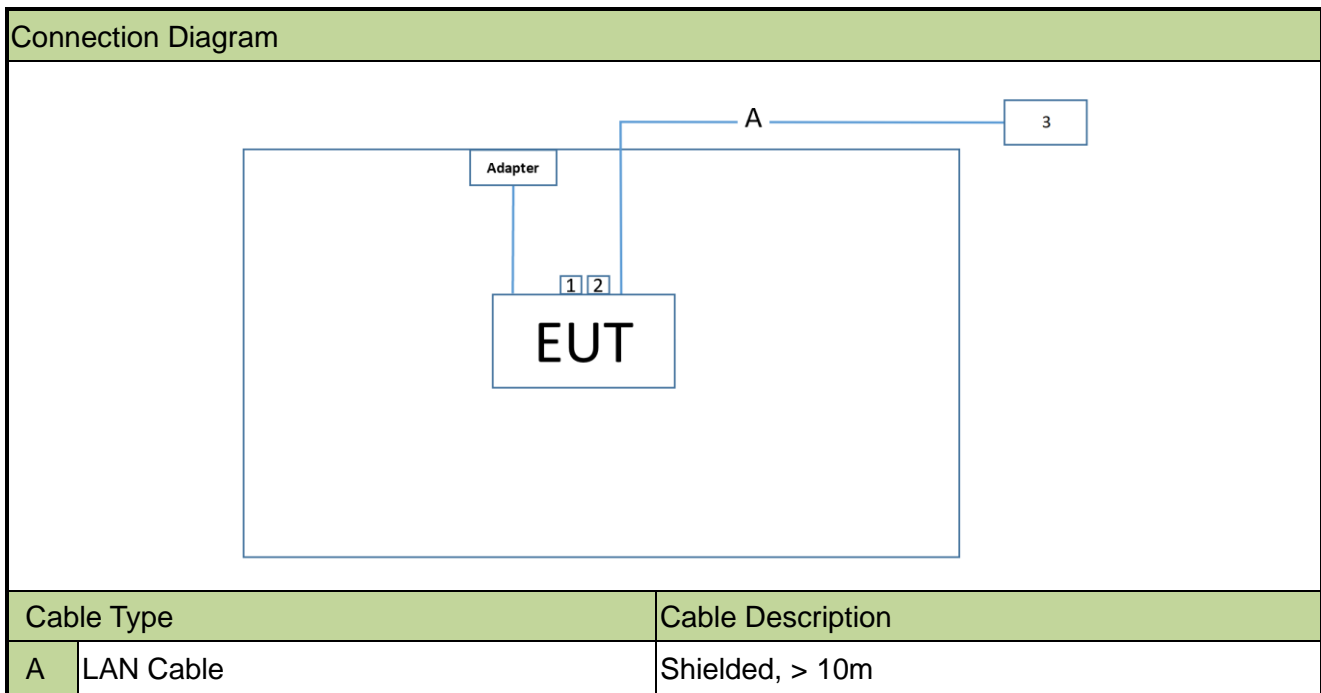

1.10. Test System Details

Product	Manufacturer	Model No.
1~2 Simulated load	N/A	001
3 Notebook	Lenovo	X230

1.11. Test Software

The test utility software used during testing was engineering order provided by manufacturer.

Note: Final power setting please refer to operational description.

1.12. Duty Cycle

The maximum achievable duty cycles for all modes were determined based on measurements performed on a spectrum analyzer in zero-span mode with RBW = 8MHz, VBW = 50MHz. The RBW and VBW were both greater than 50/T, where T is the minimum transmission duration, and the number of sweep points across T was greater than 100. The duty cycles are as follows:

Test Mode	Duty Cycle
802.11b	62.39%
802.11g	94.70%
802.11n-HT20	95.15%
802.11n-HT40	94.47%
802.11ax-HE20	94.70%
802.11ax-HE40	86.86%

Duty Cycle (T = Transmission Duration)

802.11b (T = 1.302ms)

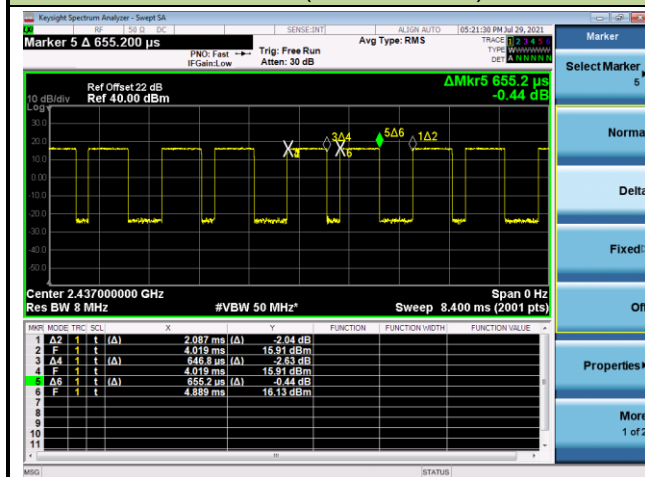

802.11g (T = 1.965ms)

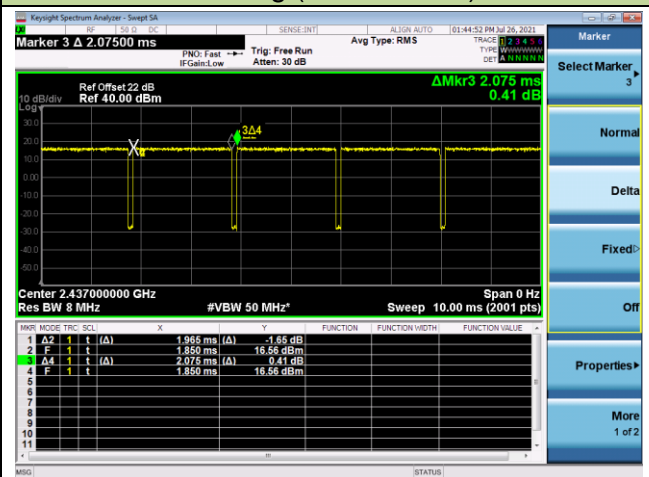

802.11n-HT20 (T = 5.414ms)

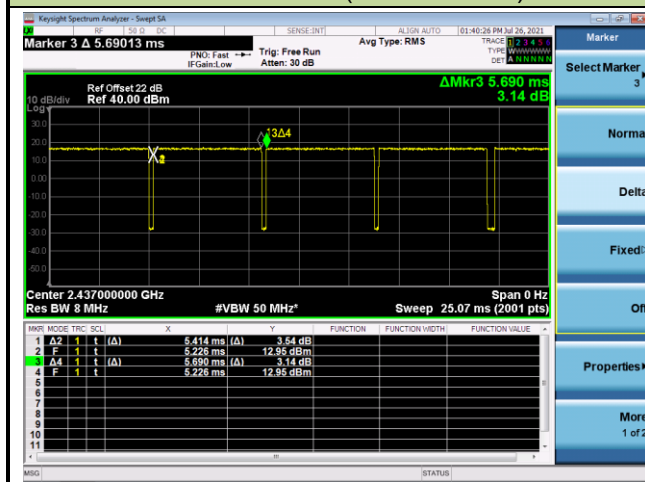

802.11n-HT40 (T = 5.352ms)

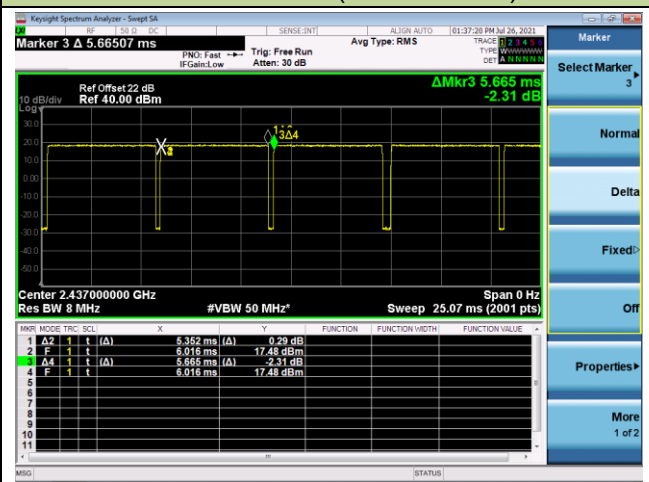

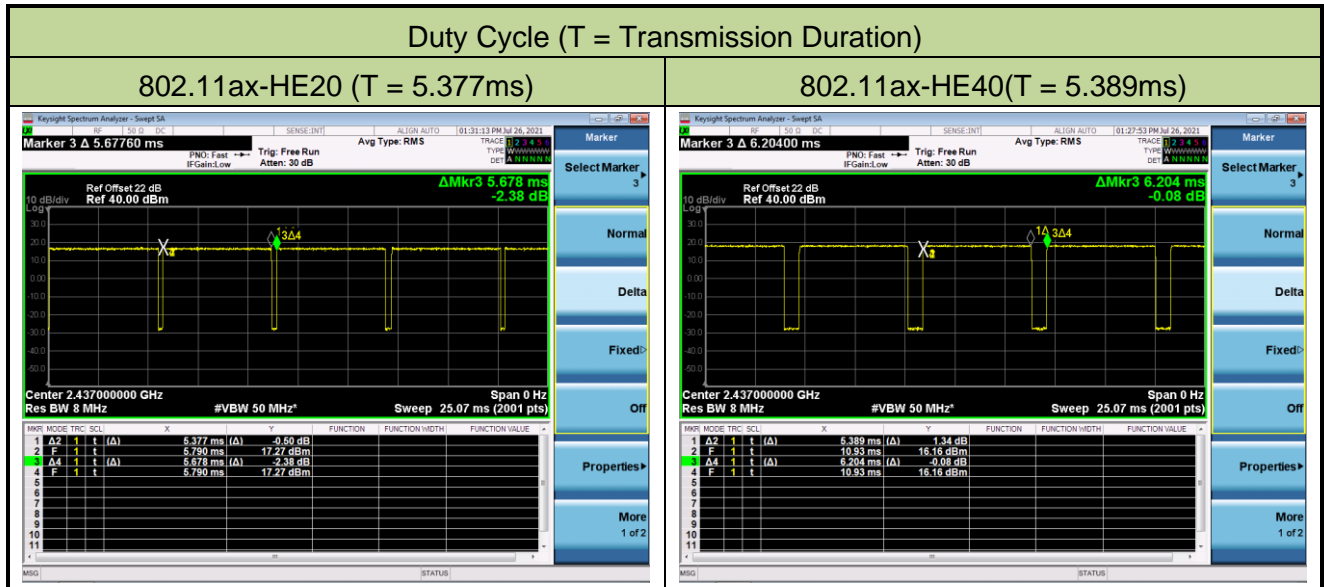

1.13. Test Environment Condition

Ambient Temperature	15°C ~ 35°C
Relative Humidity	20%RH ~ 75%RH

2. Antenna Requirements

Excerpt from §15.203 of the FCC Rules/Regulations:

“An intentional radiator antenna shall be designed to ensure that no antenna other than that furnished by the responsible party can be used with the device. The use of a permanently attached antenna or of an antenna that uses a unique coupling to the intentional radiator shall be considered sufficient to comply with the provisions of this section.”

- The antenna of the device uses the unique **I-PEX** connector.

Conclusion:

The unit complies with the requirement of §15.203.

3. Test Equipment Calibration Date

Conducted Emission (NS-SR2)

Instrument	Manufacturer	Type No.	Asset No.	Cali. Interval	Cali. Due Date
EMI Test Receiver	R&S	ESL3	MRTSUE06576	1 year	2022/06/27
ENV216-LV-NETZNACHB	R&S	ENV216	MRTSUE06577	1 year	2022/07/04
ENV216-LV-NETZNACHB	R&S	ENV216	MRTSUE06578	1 year	2022/07/04
8-WIRE ISN	R&S	ENY81	MRTSUE06579	1 year	2022/07/04
8-WIRE ISN for CAT6	R&S	ENY81-CA6	MRTSUE06580	1 year	2022/06/15
Temperature/Humidity Meter	deli	NO.8813	MRTSUE06587	1 year	2022/06/30
Shielding Anechoic Chamber	BOOMWAVE	SR2	MRTSUE06551	5-year	2024/06/04

Radiated Emissions (NS-AC1)

Instrument	Manufacturer	Type No.	Asset No.	Cali. Interval	Cal. Due Date
EXA Signal Analyzer	Keysight	N9010A	MRTSUE06195	1 year	2022/03/17
EXA Signal Analyzer	Keysight	N9020A-526	MRTSUE10065	1 year	2022/06/17
EMI Test Receiver	ROHDE&SCHWARZ	ESR3	MRTSUE06575	1 year	2022/06/27
Horn Antenna	Schwarzbeck	BBHA 9170	MRTSUE06292	1 year	2021/10/24
Broad-Band Horn Antenna	Schwarzbeck	9120D	MRTSUE06572	1 year	2022/03/14
Bilog Period Antenna	Schwarzbeck	VULB 9162	MRTSUE06573	1 year	2022/06/29
Broadband Coaxial Preamplifier	Schwarzbeck	BBV 9718	MRTSUE06574	1 year	2022/07/12
Temperature/Humidity Meter	DELI	NO.8813	MRTSUE06588	1 year	2022/06/30
Anechoic Chamber	BOOMWAVE	AC1	MRTSUE06496	1 year	2022/07/24

Conducted Test Equipment (NS-TR2)

Instrument	Manufacturer	Type No.	Asset No.	Cali. Interval	Cali. Due Date
Thermal Hygrometer	DELI	No.8813	MRTSUE06783	1 year	2022/05/09
EXA Signal Analyzer	Keysight	N9010A	MRTSUE06195	1 year	2022/03/17
Attenuator	MVE	3dB	MRTSUE06529	1 year	2021/12/12
Attenuator	MVE	6dB	MRTSUE06534	1 year	2021/12/12
Attenuator	MVE	10dB	MRTSUE06540	1 year	2021/12/12
Attenuator	MVE	20dB	MRTSUE06547	1 year	2021/12/12
Temperature/Humidity Chamber	OK	OUKE INSTRUMENT	MRTSUE06899	1 year	2021/11/27
USB wideband power sensor	Keysight	U2021XA	MRTSUE06581	1 year	2021/08/20

Radiated Emission (WZ-AC1)

Instrument	Manufacturer	Type No.	Asset No.	Cali. Interval	Cali. Due Date
EMI Test Receiver	R&S	ESR7	MRTSUE06001	1 year	2022/01/04
Loop Antenna	Schwarzbeck	FMZB 1519	MRTSUE06025	1 year	2021/11/08
Bilog Period Antenna	Schwarzbeck	VULB 9168	MRTSUE06172	1 year	2021/08/08
Horn Antenna	Schwarzbeck	BBHA 9120D	MRTSUE06023	1 year	2021/09/27
Horn Antenna	Schwarzbeck	BBHA9170	MRTSUE06597	1 year	2021/12/14
Microwave System Amplifier	Agilent	83017A	MRTSUE06076	1 year	2021/11/14
Preamplifier	Schwarzbeck	BBV 9721	MRTSUE06121	1 year	2022/06/09
Thermal Hygrometer	testo	608-H1	MRTSUE06403	1 year	2022/06/28
Anechoic Chamber	TDK	Chamber-AC1	MRTSUE06212	1 year	2022/04/29

Software	Version	Function
EMI Software	V3	EMI Test Software

4. Measurement Uncertainty

Where relevant, the following test uncertainty levels have been estimated for tests performed on the EUT as specified in CISPR 16-4-2. This uncertainty represents an expanded uncertainty expressed at approximately the 95% confidence level using a coverage factor of $k = 2$.

AC Conducted Emission Measurement
Measurement Uncertainty for a Level of Confidence of 95% ($U=2Uc(y)$): 9kHz~150kHz: 3.74dB 150kHz~30MHz: 3.44dB
Radiated Disturbance
Measurement Uncertainty for a Level of Confidence of 95% ($U=2Uc(y)$): Horizontal: 30MHz~300MHz: 5.04dB 300MHz~1GHz: 4.95dB 1GHz~40GHz: 6.40dB Vertical: 30MHz~300MHz: 5.24dB 300MHz~1GHz: 6.03dB 1GHz~40GHz: 6.40dB
Spurious Emissions, Conducted
Measuring Uncertainty for a Level of Confidence of 95% ($U=2Uc(y)$): 0.78dB
Output Power
Measuring Uncertainty for a Level of Confidence of 95% ($U=2Uc(y)$): 1.13dB
Power Spectrum Density
Measuring Uncertainty for a Level of Confidence of 95% ($U=2Uc(y)$): 1.15dB
Occupied Bandwidth
Measuring Uncertainty for a Level of Confidence of 95% ($U=2Uc(y)$): 0.28%

5. Test Result

5.1. Summary

FCC Section(s)	Test Description	Test Limit	Test Condition	Test Result	Reference
15.247(a)(2)	6dB Bandwidth	$\geq 500\text{kHz}$	Conducted	Pass	Section 5.2
15.247(b)(3)	Output Power	$\leq 30\text{dBm}$		Pass	Section 5.3
15.247(e)	Power Spectral Density	$\leq 8\text{dBm}/3\text{kHz}$		Pass	Section 5.4
15.247(d)	Band Edge / Out-of-Band Emissions	$\geq 30\text{dBc}$ (Average)		Pass	Section 5.5
15.205 15.209	General Field Strength (Restricted Bands and Radiated Emission)	Emissions in restricted bands must meet the radiated limits detailed in 15.209	Radiated	Pass	Section 5.6 & 5.7
15.207	AC Conducted Emissions 150kHz - 30MHz	< FCC 15.207 limits	Line Conducted	Pass	Section 5.8

Notes:

- 1) The analyzer plots shown in this section were all taken with a correction table loaded into the analyzer. The correction table was used to account for the losses of the cables and attenuators used as part of the system to connect the EUT to the analyzer at all frequencies of interest.
- 2) Output power test was verified over all data rates of each mode (data refers to operational description), and then choose the maximum power output (low data rate) for the final test of each channel.
- 3) For radiated emission tests, every axis (X, Y, Z) was also verified. The test results shown in the following sections represent the worst-case emissions.
- 4) EUT supports one configuration only in 802.11ax full RU mode, i.e. 242 tone in 11ax-HE20, 484 tone in 11ax-HE40.

5.2. 6dB Bandwidth Measurement

5.2.1. Test Limit

The minimum 6dB bandwidth shall be at least 500 kHz.

5.2.2. Test Procedure used

ANSI C63.10 - 2013 - Section 11.8

5.2.3. Test Setting

1. The Spectrum's automatic bandwidth measurement capability was used to perform the 6dB bandwidth measurement. The "X" dB bandwidth parameter was set to $X = 6$. The bandwidth measurement was not influenced by any intermediate power nulls in the fundamental emission.
2. Set RBW = 100 kHz
3. $VBW \geq 3 \times RBW$
4. Detector = Peak
5. Trace mode = Max hold
6. Sweep = Auto couple
7. Allow the trace to stabilize

5.2.4. Test Setup

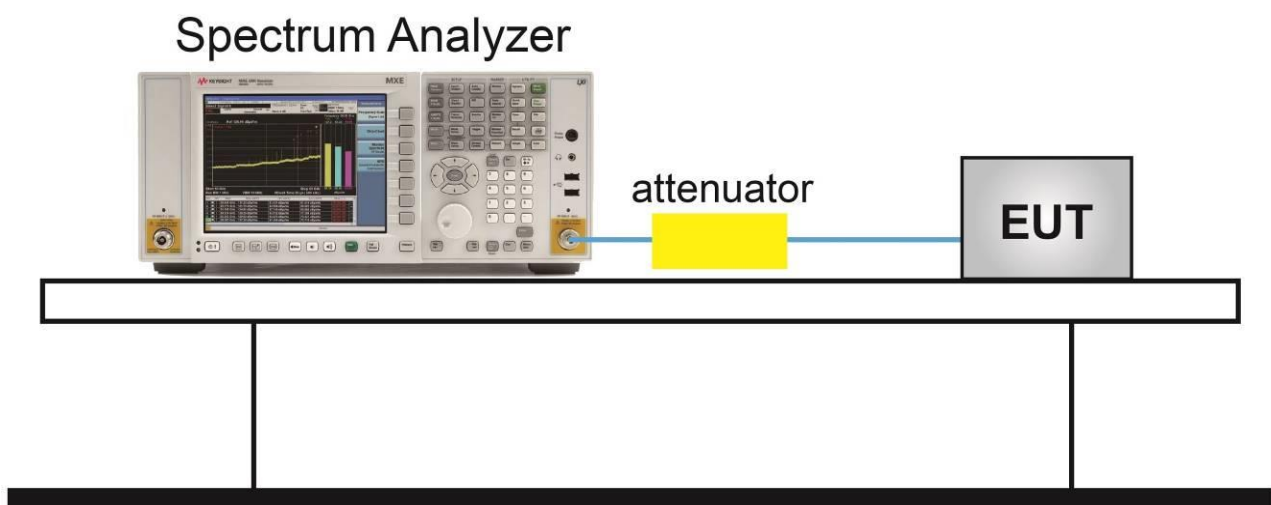

5.2.5. Test Result

Test Site	NS-TR2	Test Engineer	Flag Yang
Test Date	2021/07/26		

Test Mode	Data Rate / MCS	Channel No.	Frequency (MHz)	6dB Bandwidth (MHz)	Limit (MHz)	Result
802.11b	1Mbps	01	2412	8.09	≥ 0.5	Pass
802.11b	1Mbps	06	2437	7.59	≥ 0.5	Pass
802.11b	1Mbps	11	2462	7.12	≥ 0.5	Pass
802.11g	6Mbps	01	2412	15.66	≥ 0.5	Pass
802.11g	6Mbps	06	2437	16.30	≥ 0.5	Pass
802.11g	6Mbps	11	2462	15.66	≥ 0.5	Pass
802.11n-HT20	MCS0	01	2412	16.78	≥ 0.5	Pass
802.11n-HT20	MCS0	06	2437	16.94	≥ 0.5	Pass
802.11n-HT20	MCS0	11	2462	16.51	≥ 0.5	Pass
802.11n-HT40	MCS0	03	2422	35.67	≥ 0.5	Pass
802.11n-HT40	MCS0	06	2437	35.98	≥ 0.5	Pass
802.11n-HT40	MCS0	09	2452	35.95	≥ 0.5	Pass
802.11ax-HE20	MCS0	01	2412	17.16	≥ 0.5	Pass
802.11ax-HE20	MCS0	06	2437	18.35	≥ 0.5	Pass
802.11ax-HE20	MCS0	11	2462	18.57	≥ 0.5	Pass
802.11ax-HE40	MCS0	03	2422	37.68	≥ 0.5	Pass
802.11ax-HE40	MCS0	06	2437	37.78	≥ 0.5	Pass
802.11ax-HE40	MCS0	09	2452	37.82	≥ 0.5	Pass

802.11b 6dB Bandwidth

Channel 01 (2412MHz)

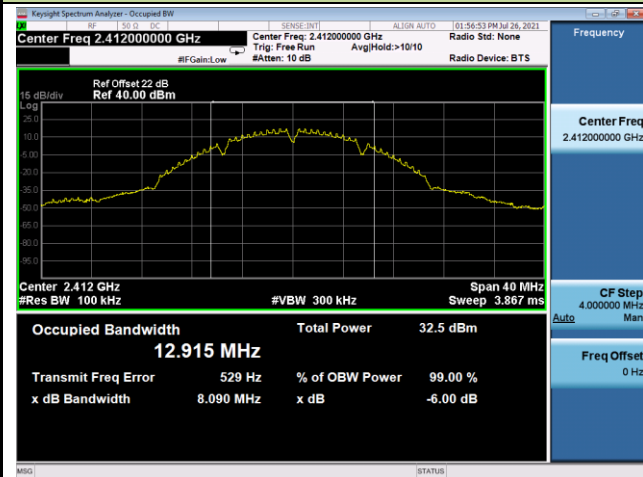

Channel 06 (2437MHz)

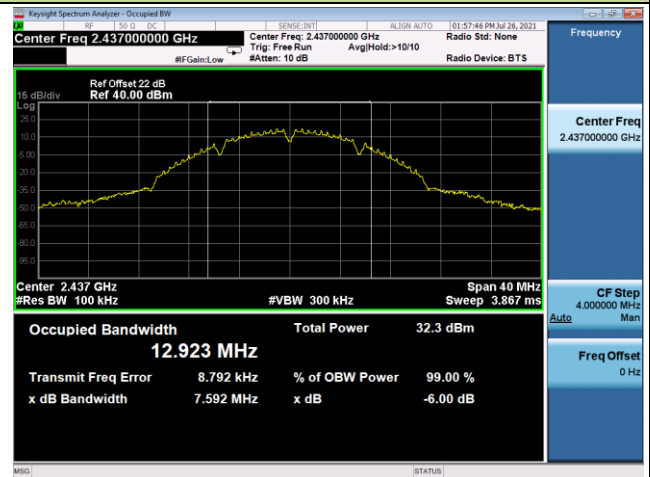

Channel 11 (2462MHz)

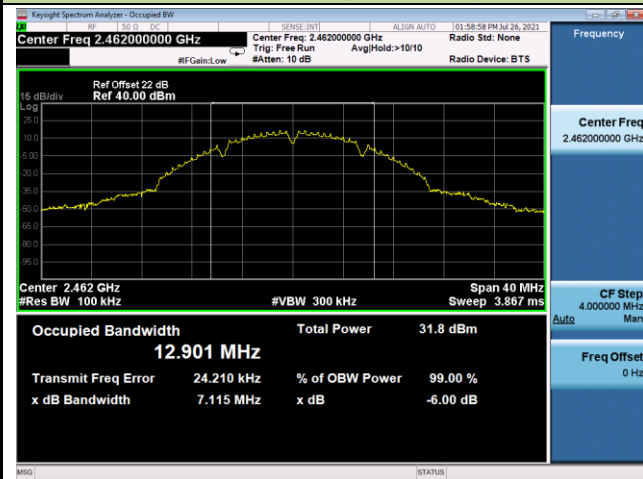

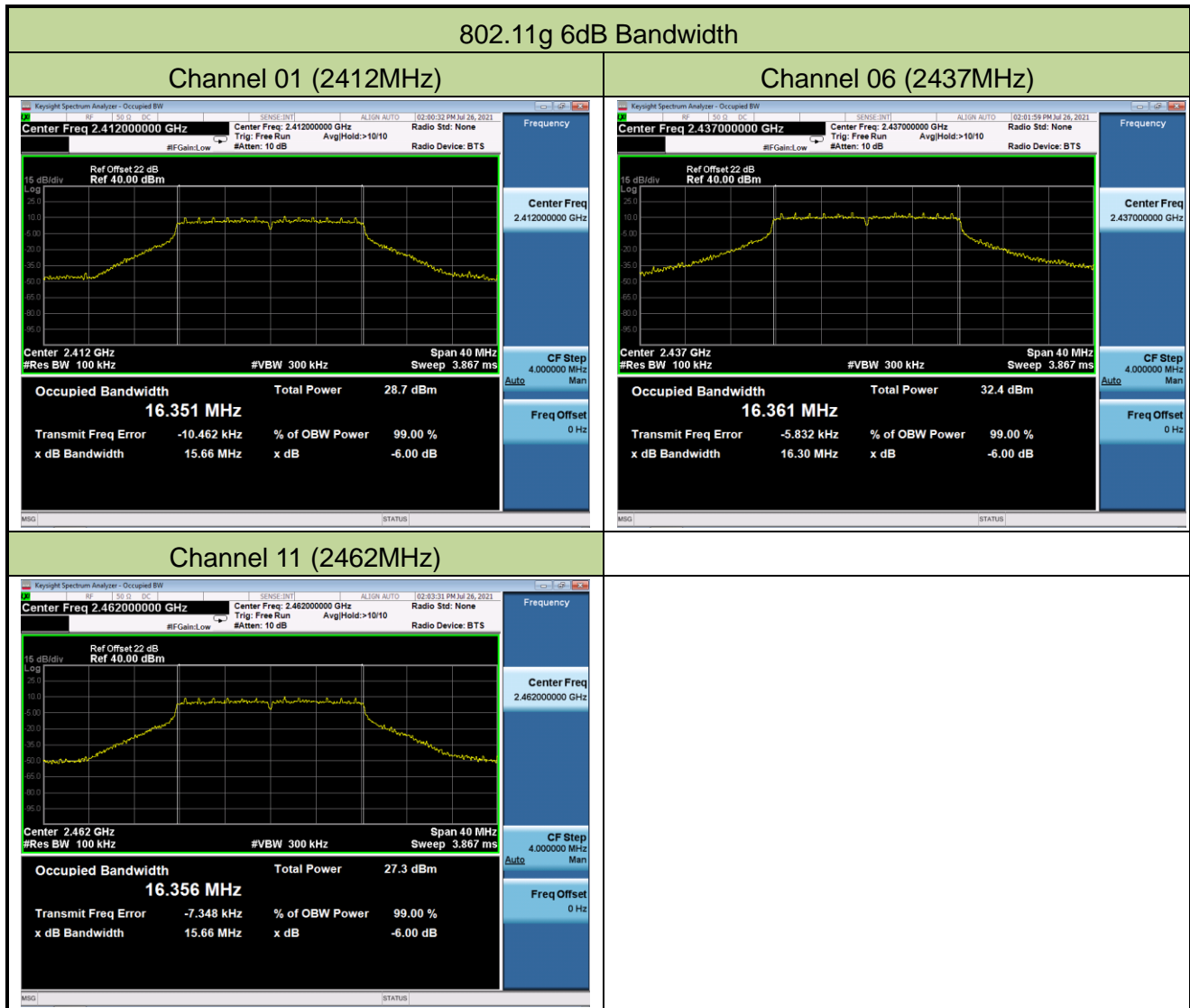

802.11n-HT20 6dB Bandwidth

Channel 01 (2412MHz)



Channel 06 (2437MHz)

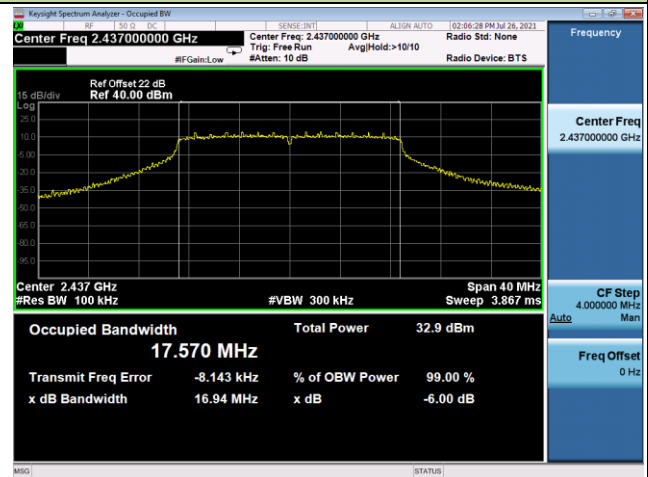

Channel 11 (2462MHz)



802.11n-HT40 6dB Bandwidth

Channel 03 (2422MHz)

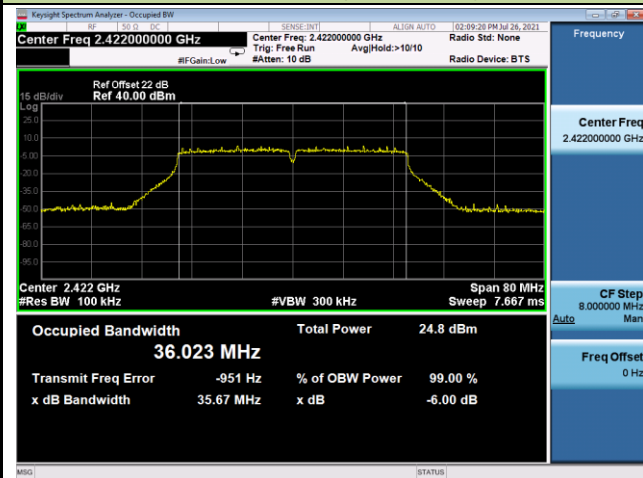

Channel 06 (2437MHz)

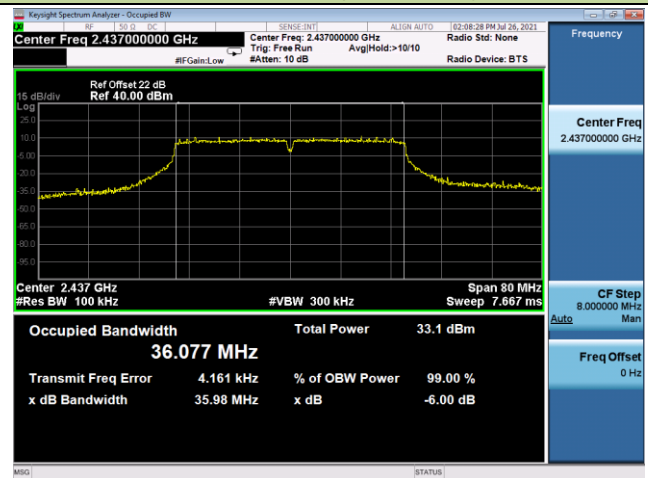

Channel 09 (2452MHz)



802.11ax-HE20 6dB Bandwidth

Channel 01 (2412MHz)

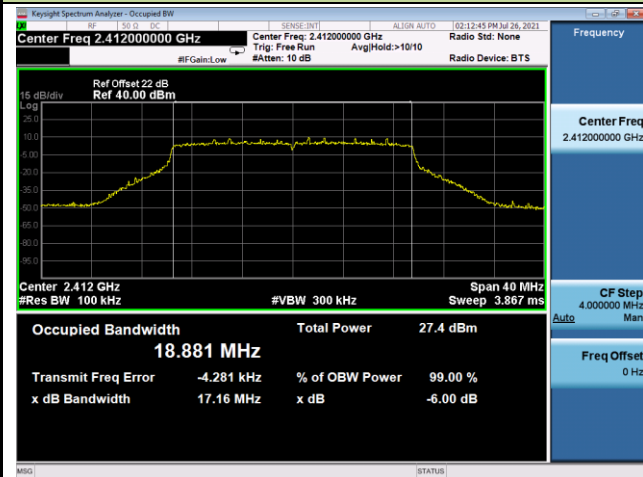

Channel 06 (2437MHz)

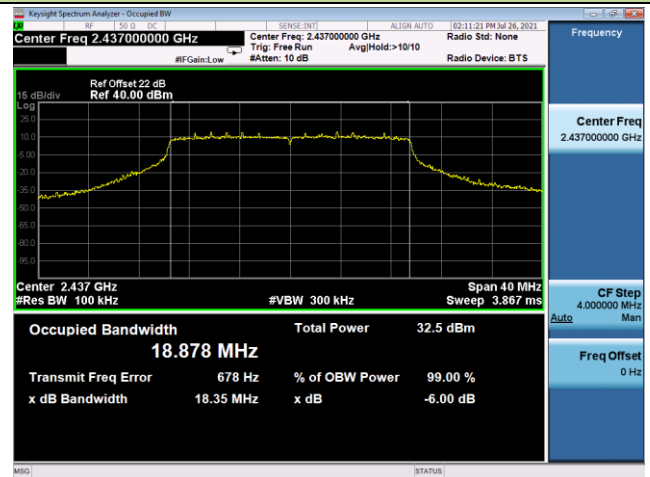

Channel 11 (2462MHz)



802.11ax-HE40 6dB Bandwidth

Channel 03 (2422MHz)

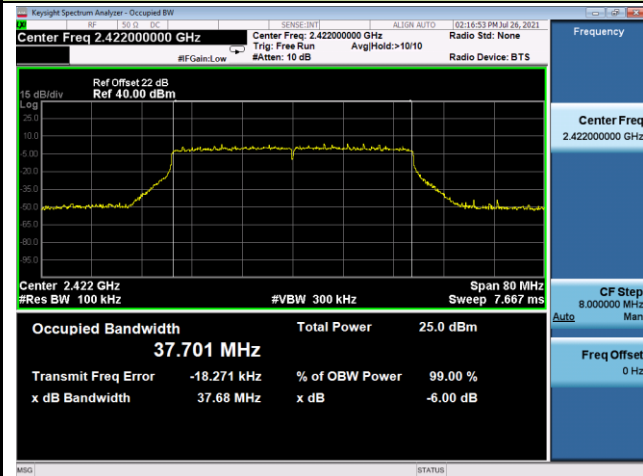

Channel 06 (2437MHz)

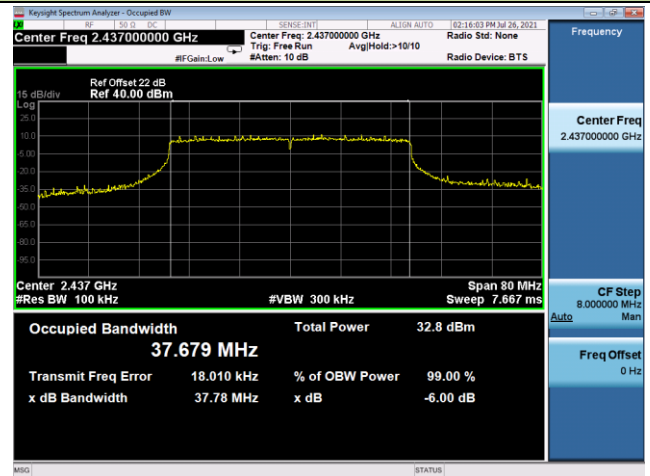

Channel 09 (2452MHz)



5.3. Output Power Measurement

5.3.1. Test Limit

The maximum output power shall be less 1 Watt (30dBm).

The conducted output power limit specified in paragraph FCC Part 15.247(b) of this section is based on the use of antennas with directional gains that do not exceed 6 dBi. If transmitting antennas of directional gain greater than 6 dBi are used, the conducted output power from the intentional radiator shall be reduced below the stated values in paragraphs FCC Part 15.247(b)(3) of this section, as appropriate, by the amount in dB that the directional gain of the antenna exceeds 6 dBi.

5.3.2. Test Procedure Used

ANSI C63.10 - 2013 - Section 11.9.2.3.2

5.3.3. Test Setting

Average Power Measurement

Average power measurements were performed only when the EUT was transmitting at its maximum power control level using a broadband power meter with a pulse sensor. The power meter implemented triggering and gating capabilities which were set up such that power measurements were recorded only during the ON time of the transmitter.

5.3.4. Test Setup

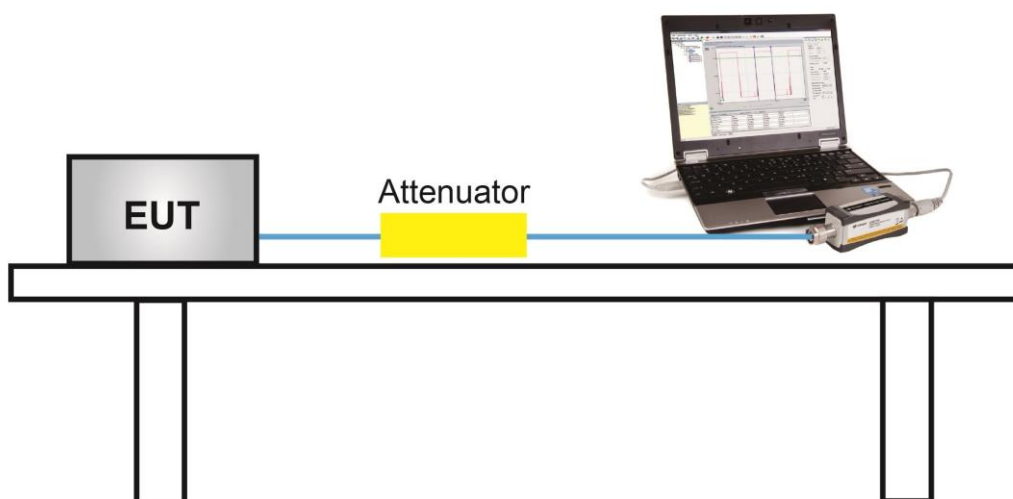

5.3.5. Test Result

Test Site	NS-TR2	Test Engineer	Flag Yang
Test Date	2021/08/06		

Test Mode	Data Rate/ MCS	Channel No.	Freq. (MHz)	Ant 0 Average Power (dBm)	Ant 1 Average Power (dBm)	Total Average Power (dBm)	Limit (dBm)	Result
CDD Mode								
802.11b	1Mbps	01	2412	21.35	21.74	24.56	≤ 28.00	Pass
802.11b	1Mbps	06	2437	21.45	21.92	24.70	≤ 28.00	Pass
802.11b	1Mbps	11	2462	21.49	21.87	24.69	≤ 28.00	Pass
802.11g	6Mbps	01	2412	20.55	20.28	23.43	≤ 28.00	Pass
802.11g	6Mbps	02	2417	21.18	21.54	24.37	≤ 28.00	Pass
802.11g	6Mbps	06	2437	21.44	21.80	24.63	≤ 28.00	Pass
802.11g	6Mbps	10	2457	21.29	21.62	24.47	≤ 28.00	Pass
802.11g	6Mbps	11	2462	19.51	19.66	22.60	≤ 28.00	Pass
802.11n-HT20	MCS0	01	2412	19.34	19.17	22.27	≤ 28.00	Pass
802.11n-HT20	MCS0	02	2417	21.34	21.82	24.60	≤ 28.00	Pass
802.11n-HT20	MCS0	06	2437	21.75	21.92	24.85	≤ 28.00	Pass
802.11n-HT20	MCS0	10	2457	21.51	21.78	24.66	≤ 28.00	Pass
802.11n-HT20	MCS0	11	2462	18.91	18.81	21.87	≤ 28.00	Pass
802.11n-HT40	MCS0	03	2422	16.85	16.63	19.75	≤ 28.00	Pass
802.11n-HT40	MCS0	06	2437	20.19	19.92	23.07	≤ 28.00	Pass
802.11n-HT40	MCS0	08	2447	18.65	18.33	21.50	≤ 28.00	Pass
802.11n-HT40	MCS0	09	2452	15.95	15.65	18.81	≤ 28.00	Pass
802.11ax-HE20	MCS0	01	2412	19.07	19.02	22.06	≤ 28.00	Pass
802.11ax-HE20	MCS0	02	2417	21.26	21.72	24.51	≤ 28.00	Pass
802.11ax-HE20	MCS0	06	2437	21.42	21.72	24.58	≤ 28.00	Pass
802.11ax-HE20	MCS0	10	2457	21.52	21.76	24.65	≤ 28.00	Pass
802.11ax-HE20	MCS0	11	2462	18.14	18.21	21.19	≤ 28.00	Pass
802.11ax-HE40	MCS0	03	2422	16.78	16.71	19.76	≤ 28.00	Pass
802.11ax-HE40	MCS0	06	2437	19.22	18.88	22.06	≤ 28.00	Pass
802.11ax-HE40	MCS0	09	2452	16.99	16.73	19.87	≤ 28.00	Pass

Note 1: Total Average Power (dBm) = $10 \cdot \log \{10^{(\text{Ant 0 Average Power} / 10)} + 10^{(\text{Ant 1 Average Power} / 10)}\}$ (dBm).

Note 2: Limit (dBm) = 30 - (8-6) = 28 dBm.

5.4. Power Spectral Density Measurement

5.4.1. Test Limit

The maximum permissible power spectral density is 8dBm in any 3 kHz band.

The same method of determining the conducted output power shall be used to determine the power spectral density.

5.4.2. Test Procedure Used

ANSI C63.10 - 2013 - Section 11.10.5

5.4.3. Test Setting

1. Measure the duty cycle (x) of the transmitter output signal.
2. Set instrument center frequency to DTS channel center frequency.
3. Set span to at least 1.5 times the OBW.
4. RBW = 10 kHz.
5. VBW = 30 kHz.
6. Detector = RMS.
7. Ensure that the number of measurement points in the sweep $\geq 2 \times \text{span}/\text{RBW}$.
8. Sweep time = auto couple.
9. Don't use sweep triggering. Allow sweep to "free run".
10. Employ trace averaging (RMS) mode over a minimum of 100 traces.
11. Use the peak marker function to determine the maximum amplitude level.
12. Add $10 \log(1/x)$, where x is the duty cycle measured in step (a), to the measured PSD to compute the average PSD during the actual transmission time. If measured value exceeds requirement specified by regulatory agency, then reduce RBW (but no less than 3 kHz) and repeat (note that this may require zooming in on the emission of interest and reducing the span to meet the minimum measurement point requirement as the RBW is reduced).

5.4.4. Test Setup

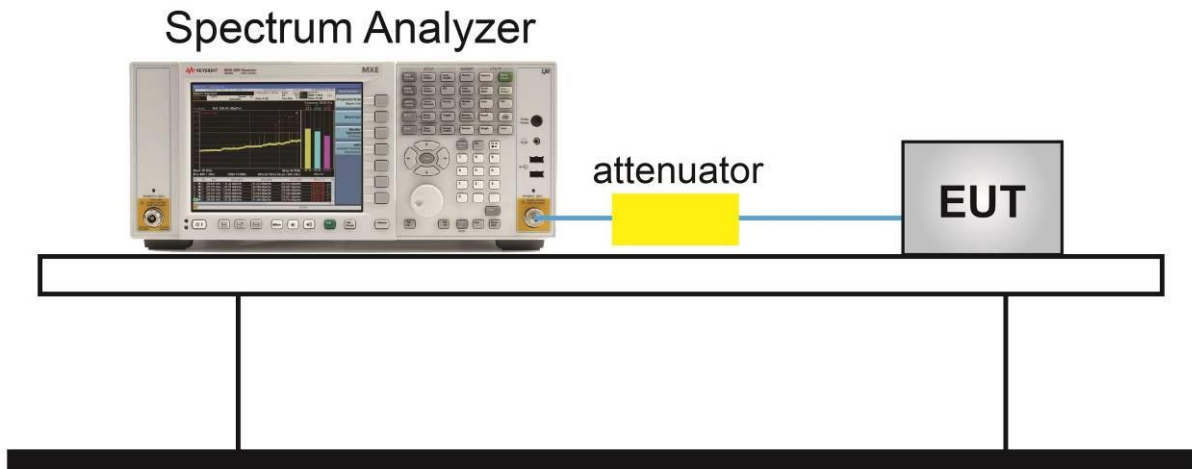

5.4.5. Test Result

Test Site	NS-TR2	Test Engineer	Flag Yang
Test Date	2021/07/26~2021/08/05		

Test Mode	Data Rate/MCS	Channel No.	Freq. (MHz)	Ant 0 PSD (dBm/10kHz)	Ant 1 PSD (dBm/10kHz)	Duty Cycle (%)	Total PSD (dBm/10kHz)	Limit (dBm/3kHz)	Result
802.11b	1Mbps	01	2412	-3.84	-3.55	62.39	1.36	≤ 2.99	Pass
802.11b	1Mbps	06	2437	-5.08	-5.41	62.39	-0.19	≤ 2.99	Pass
802.11b	1Mbps	11	2462	-5.33	-5.31	62.39	-0.26	≤ 2.99	Pass
802.11g	6Mbps	01	2412	-8.43	-8.71	94.70	-5.32	≤ 2.99	Pass
802.11g	6Mbps	06	2437	-7.71	-7.05	94.70	-4.12	≤ 2.99	Pass
802.11g	6Mbps	11	2462	-9.61	-8.93	94.70	-6.01	≤ 2.99	Pass
802.11n-HT20	MCS0	01	2412	-10.16	-10.52	95.15	-7.11	≤ 2.99	Pass
802.11n-HT20	MCS0	06	2437	-8.30	-8.01	95.15	-4.92	≤ 2.99	Pass
802.11n-HT20	MCS0	11	2462	-11.06	-11.28	95.15	-7.94	≤ 2.99	Pass
802.11n-HT40	MCS0	03	2422	-16.01	-16.00	94.47	-12.75	≤ 2.99	Pass
802.11n-HT40	MCS0	06	2437	-11.96	-12.44	94.47	-8.94	≤ 2.99	Pass
802.11n-HT40	MCS0	09	2452	-16.76	-17.16	94.47	-13.70	≤ 2.99	Pass
802.11ax-HE20	MCS0	01	2412	-11.71	-12.00	94.70	-8.61	≤ 2.99	Pass
802.11ax-HE20	MCS0	06	2437	-9.19	-9.47	94.70	-6.08	≤ 2.99	Pass
802.11ax-HE20	MCS0	11	2462	-12.74	-12.96	94.70	-9.60	≤ 2.99	Pass
802.11ax-HE40	MCS0	03	2422	-16.91	-16.84	86.86	-13.25	≤ 2.99	Pass
802.11ax-HE40	MCS0	06	2437	-13.61	-14.05	86.86	-10.20	≤ 2.99	Pass
802.11ax-HE40	MCS0	09	2452	-16.58	-16.87	86.86	-13.10	≤ 2.99	Pass

Note 1:

When EUT duty cycle > 98%, Total AVGPDS = $10 \cdot \log \{10^{(\text{Ant 0 AVGPDS}/10)} + 10^{(\text{Ant 1 AVGPDS}/10)}\}$

When EUT duty cycle ≤ 98%, Total AVGPDS = $10 \cdot \log \{10^{(\text{Ant 0 AVGPDS}/10)} + 10^{(\text{Ant 1 AVGPDS}/10)}\} + 10 \cdot \log (1/\text{Duty Cycle})$.

Note 2: Limit (dBm/3kHz) = 8 - (11.01 - 6) = 2.99 dBm/3kHz.

802.11b - AVGPSD - Ant 0

Channel 01 (2412MHz)

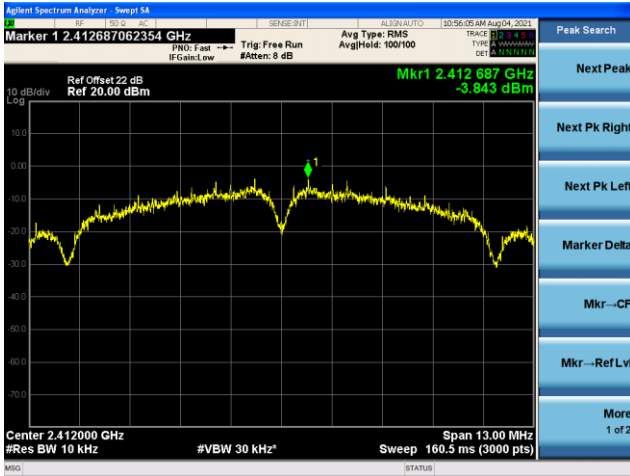

Channel 06 (2437MHz)

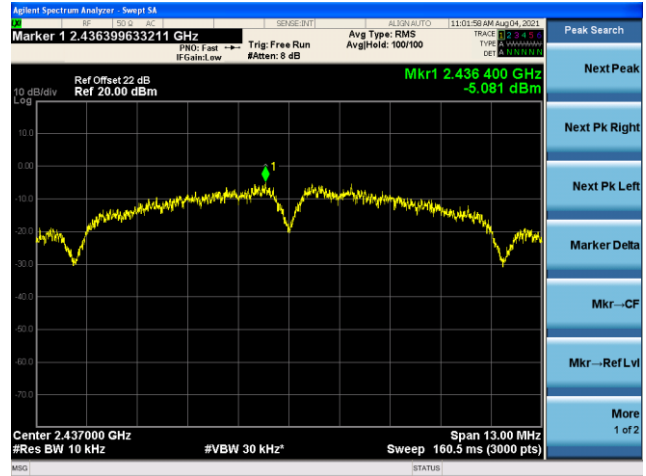

Channel 11 (2462MHz)

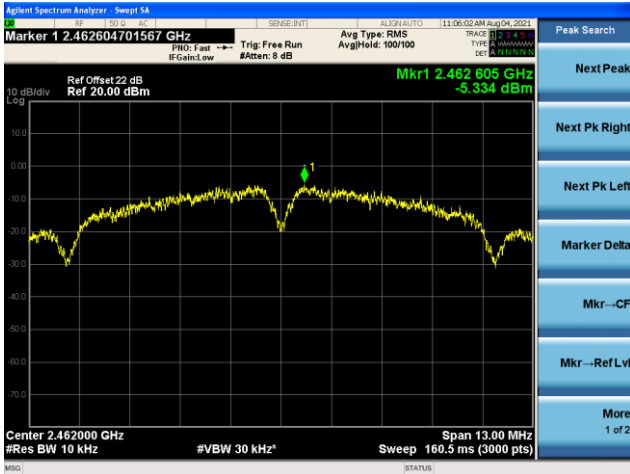

802.11g - AVGPSD - Ant 0

Channel 01 (2412MHz)

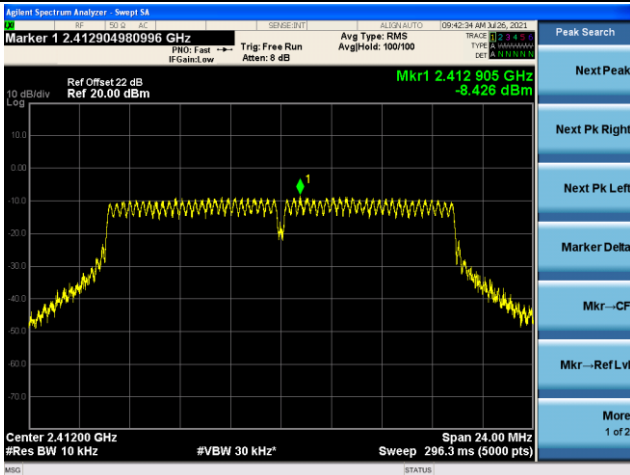

Channel 06 (2437MHz)

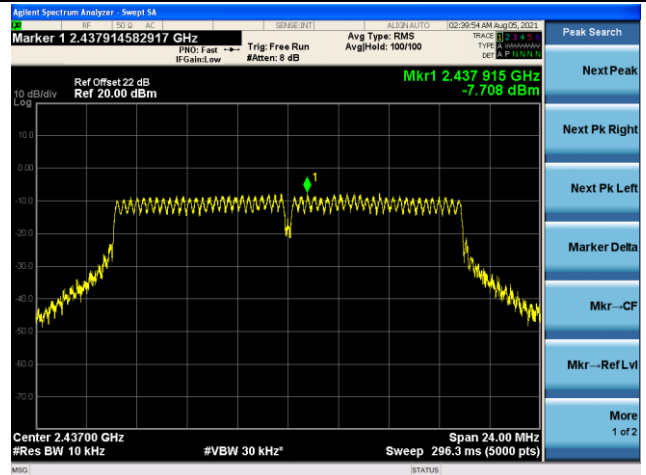

Channel 11 (2462MHz)

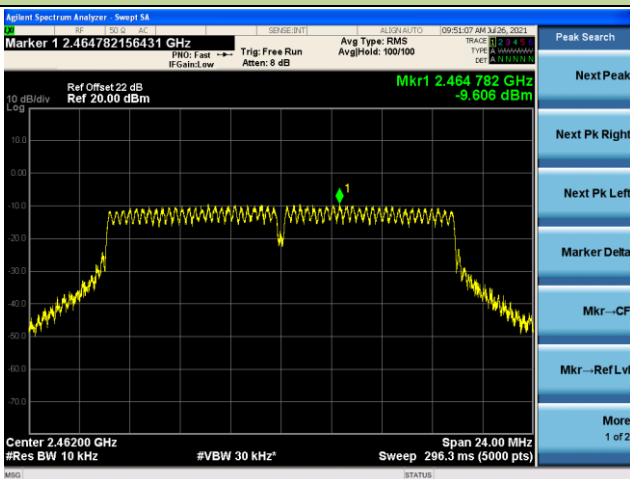

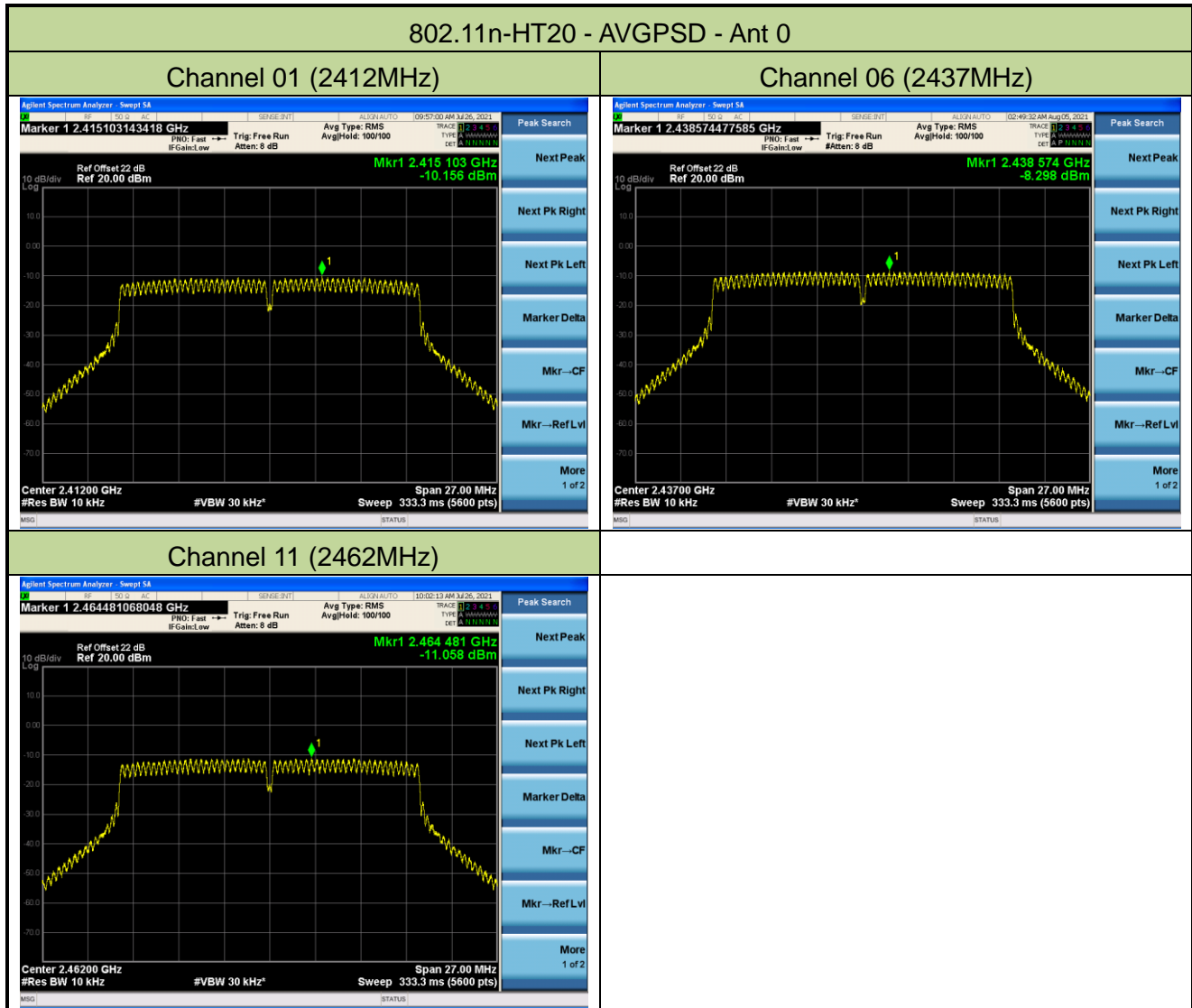

802.11n-HT40 - AVGPSD - Ant 0

Channel 03 (2422MHz)

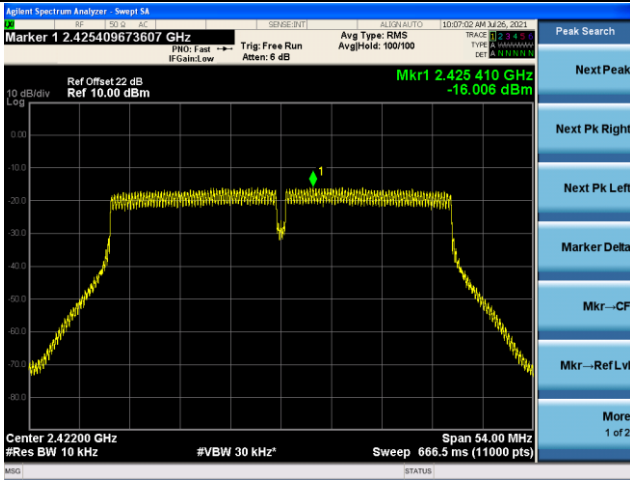

Channel 06 (2437MHz)

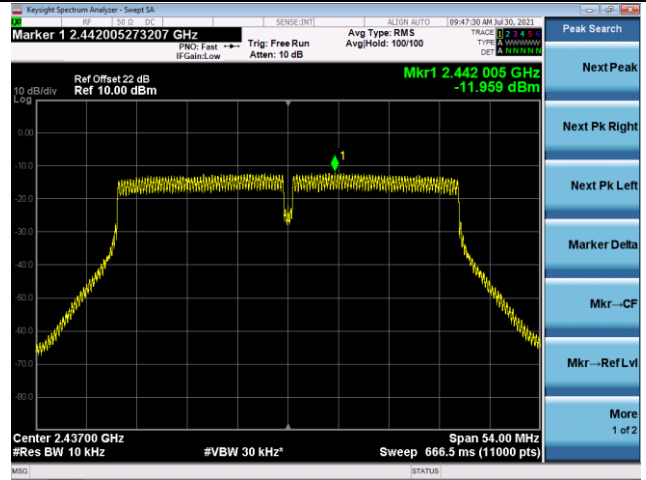

Channel 09 (2452MHz)

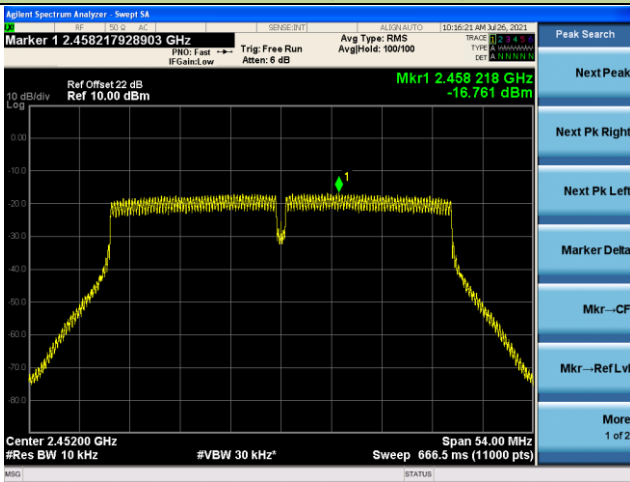

802.11ax-HE20 - AVGPSD - Ant 0

Channel 01 (2412MHz)

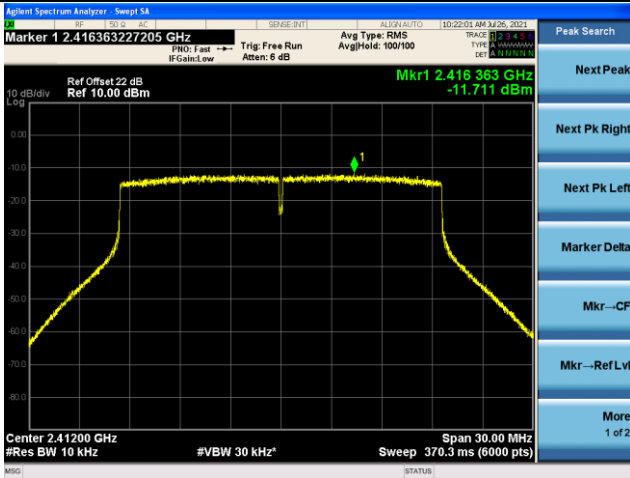

Channel 06 (2437MHz)

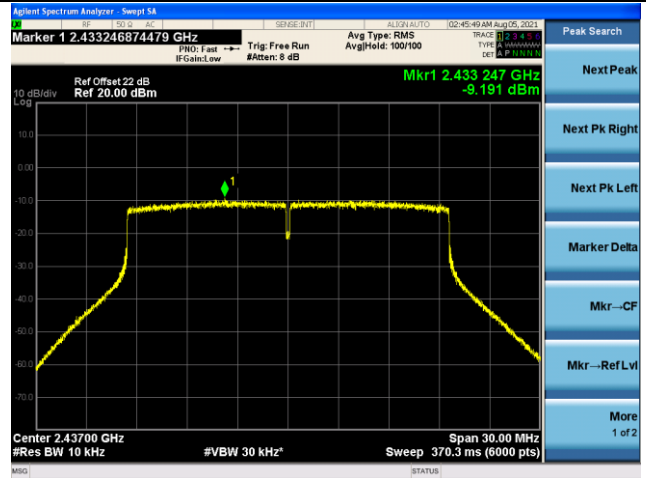

Channel 11 (2462MHz)

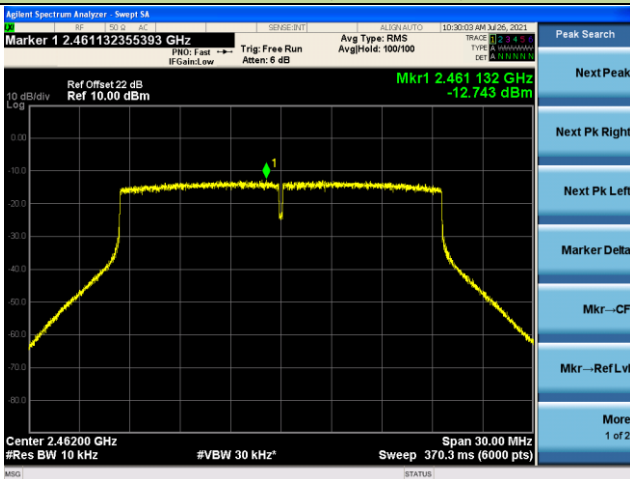

802.11ax-HE40 - AVGPSD - Ant 0

Channel 03 (2422MHz)

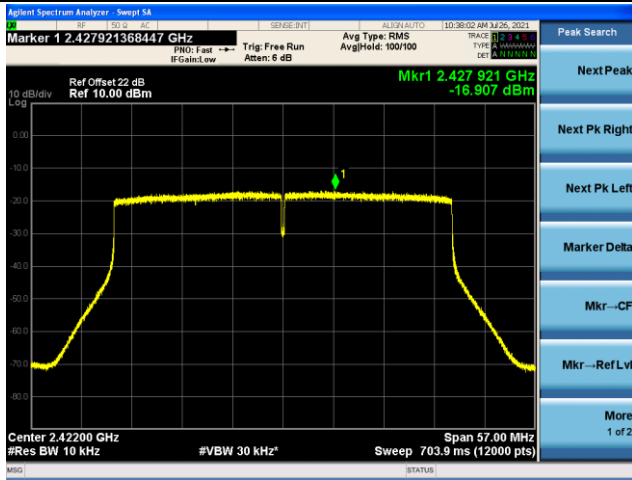

Channel 06 (2437MHz)

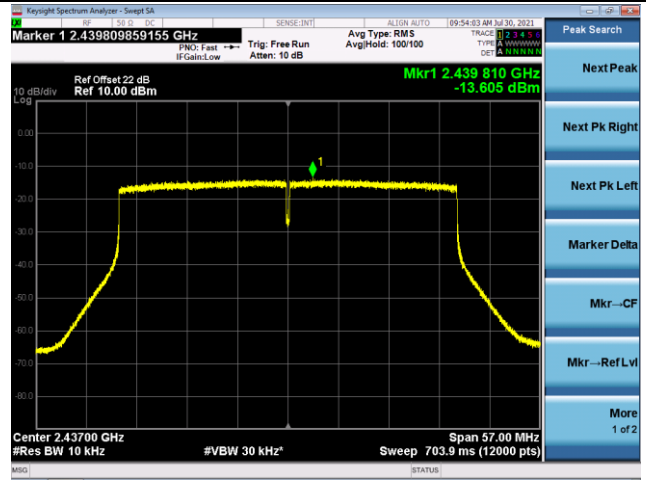

Channel 09 (2452MHz)

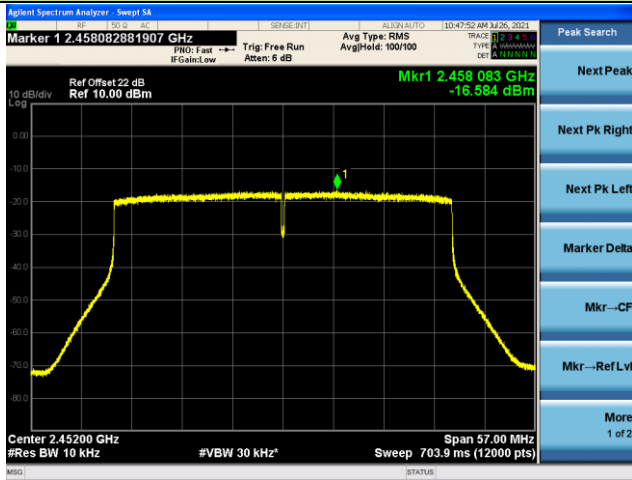

802.11b AVGPDS - Ant 1

Channel 01 (2412MHz)

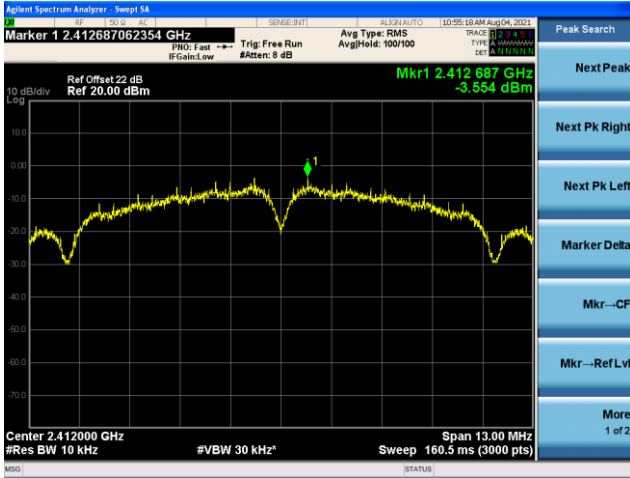

Channel 06 (2437MHz)



Channel 11 (2462MHz)

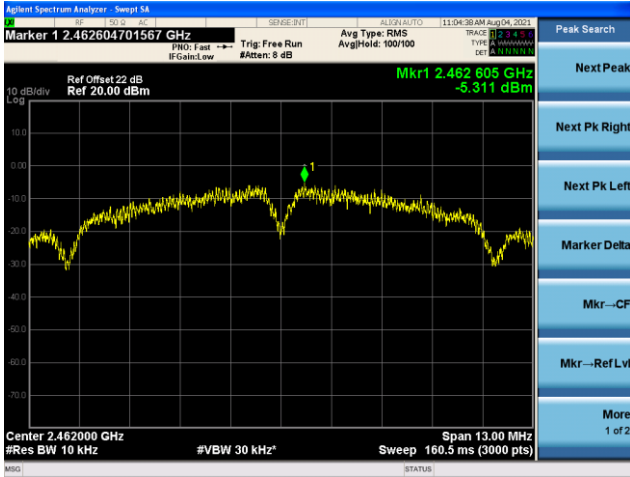

802.11g - AVGPSD - Ant 1

Channel 01 (2412MHz)

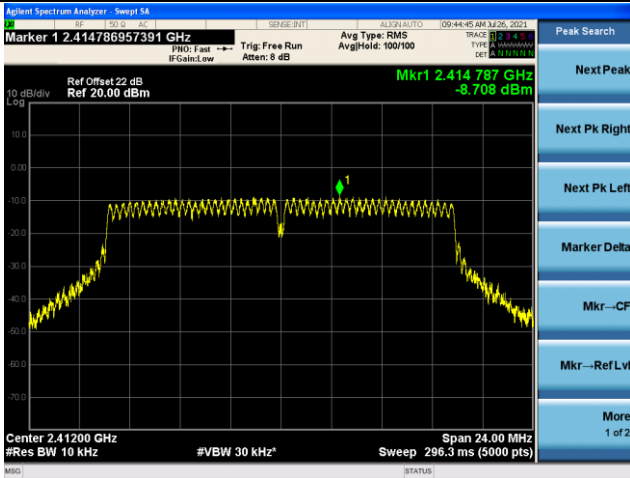

Channel 06 (2437MHz)

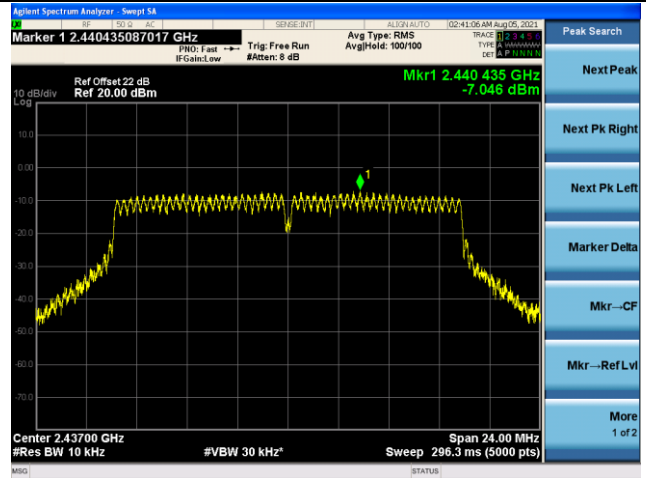

Channel 11 (2462MHz)

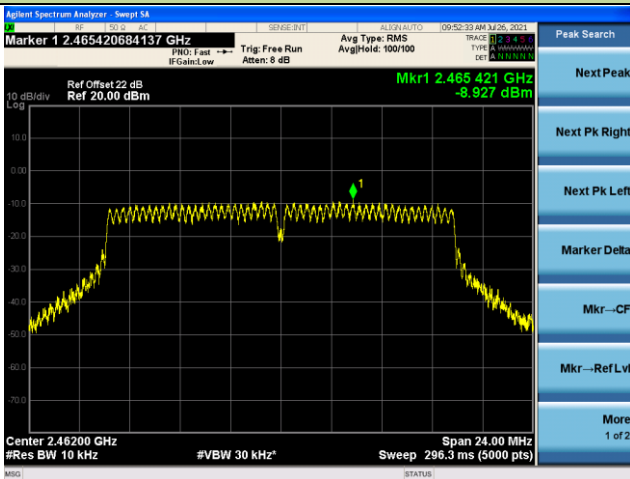

802.11n-HT20 - AVGPSD - Ant 1

Channel 01 (2412MHz)

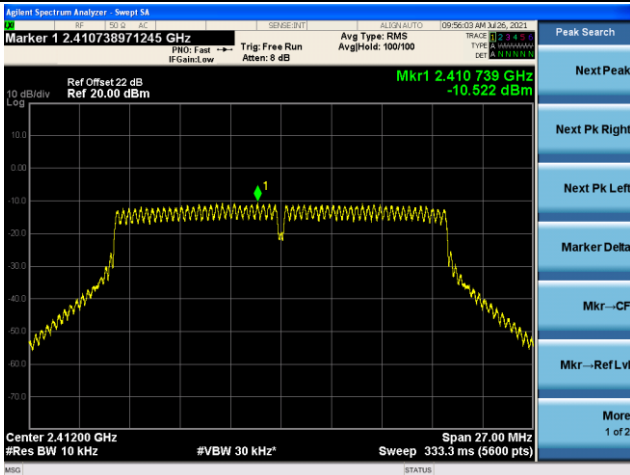

Channel 06 (2437MHz)

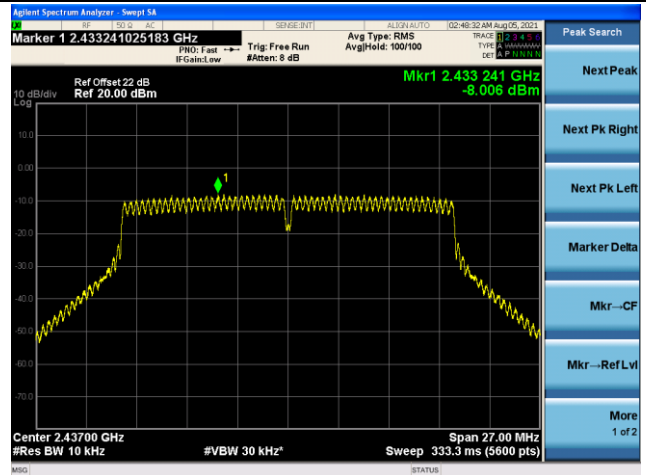

Channel 11 (2462MHz)

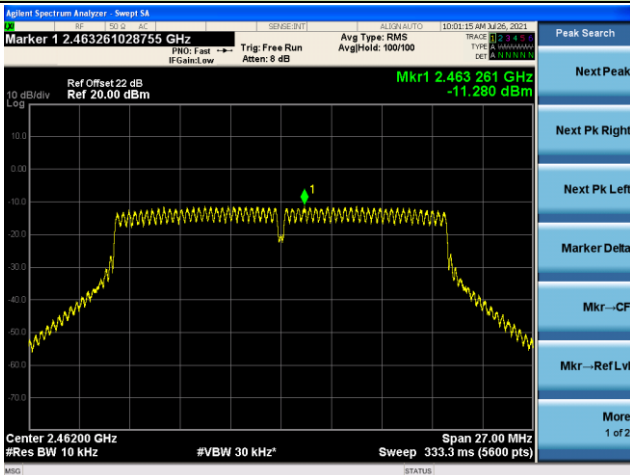

802.11n-HT40 - AVGPSD - Ant 1

Channel 03 (2422MHz)

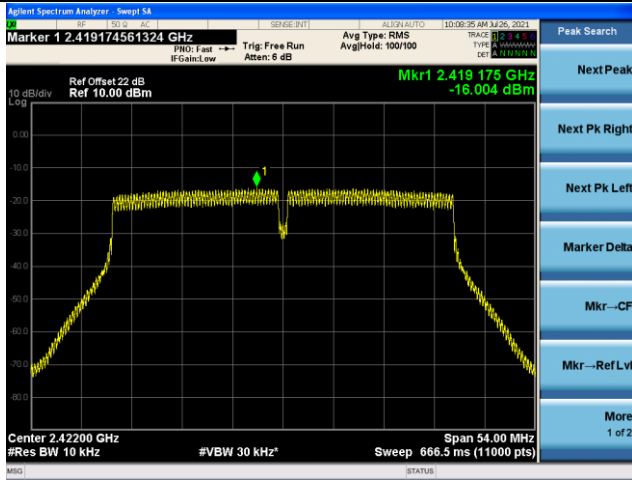

Channel 06 (2437MHz)

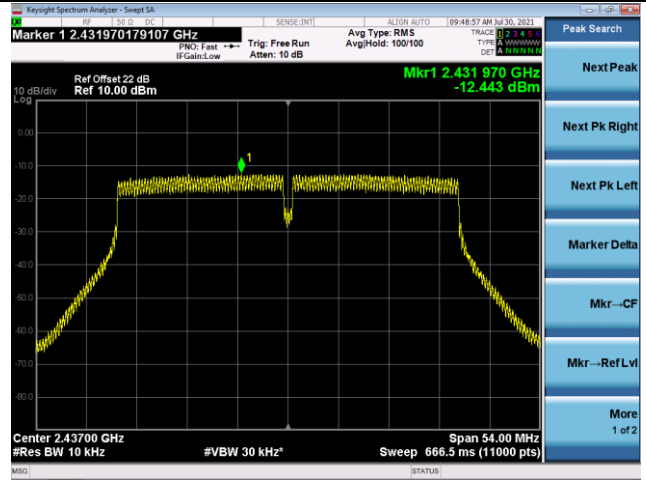

Channel 09 (2452MHz)

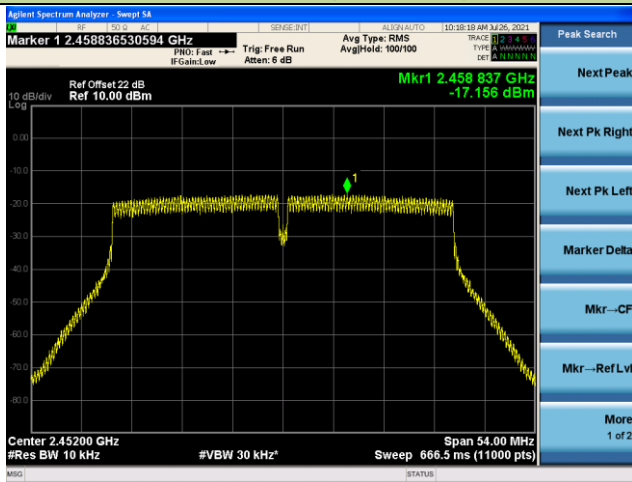

802.11ax-HE20 - AVGPSD - Ant 1

Channel 01 (2412MHz)

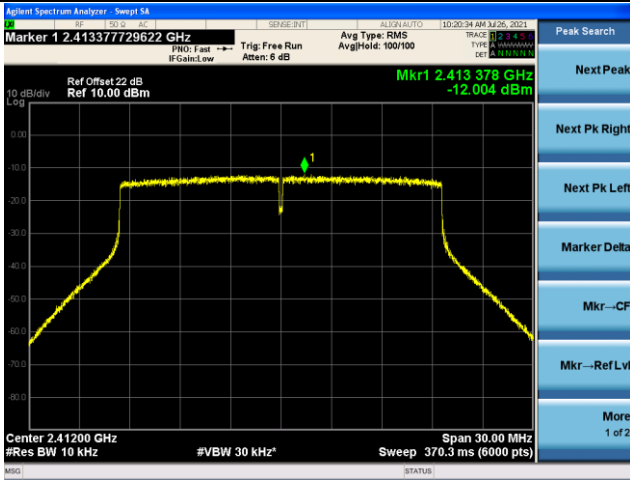

Channel 06 (2437MHz)

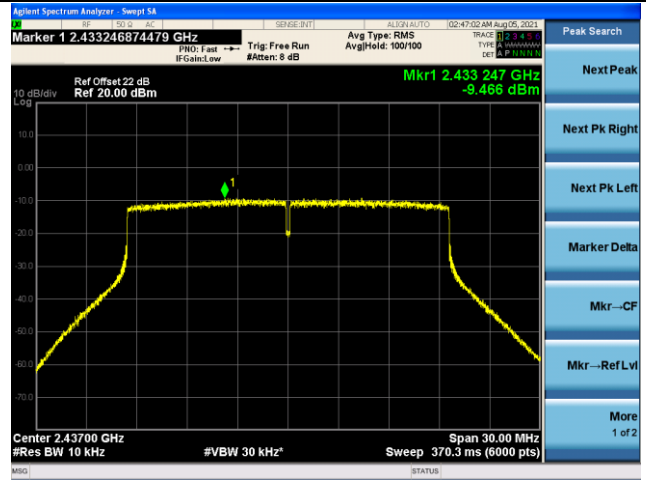

Channel 11 (2462MHz)

