



FCC TEST REPORT

According to

FCC Rules and Regulations Part 15 Subpart C

Applicant	: Compex Systems Pte Ltd
Address	: 135 Joo Seng Road, #08-01 PM Industrial Building, Singapore 368363
Equipment	: WIRELESS-AN 25DBM 3X3 NETWORK MINI PCIE ADAPTER
Model No.	: WLE350N5-25
FCC ID	: TK4WLE350N5-25H
Trade Name	: Compex

- The test result refers exclusively to the test presented test model / sample.,
- Without written approval of **CerpPASS Technology(Suzhou) Corp.** the test report shall not be reproduced except in full.
- The EUT is also considered as a kind of computer peripheral, because the connection to computer is necessary for typical use. It has been verified to comply with the requirements of **FCC Rules and Regulations Part 15.** The test report has been issued separately.
- The test report must not be used by the clients to claim product certification approval by **NVLAP** or any agency of the Government.



Contents

1. Report of Measurements and Examinations	6
1.1 List of Measurements and Examinations	6
2. Test Configuration of Equipment under Test	7
2.1 Manufacturer	7
2.2 Feature of Equipment under Test	7
2.3 Carrier Frequency of Channels	8
2.4 Test Mode and Test Software	9
2.5 Description of Test System	10
2.6 General Information of Test	11
2.7 Measurement Uncertainty	12
3. Antenna Requirements	13
3.1 Standard Applicable	13
3.2 Antenna Construction and Directional Gain	14
4. Test of Conducted Emission	15
4.1 Test Limit	15
4.2 Test Procedures	15
4.3 Typical Test Setup	16
4.4 Measurement equipment	16
4.5 Test Result and Data	17
5. Test of Radiated Emission	19
5.1 Test Limit	19
5.2 Test Procedures	19
5.3 Typical Test Setup	20
5.4 Measurement equipment	21
5.5 Test Result and Data	22
6. 6dB Bandwidth Measurement Data	49
6.1 Test Limit	49
6.2 Test Procedures	49
6.3 Test Setup Layout	49
6.4 Measurement equipment	49
6.5 Test Result and Data	49
7. Maximum Peak Output Power	59
7.1 Test Limit	59
7.2 Test Procedures	59
7.3 Test Setup Layout	59
7.4 Measurement equipment	59
7.5 Test Result and Data	59
8. Power Spectral Density	69
8.1 Test Limit	69
8.2 Test Procedures	69
8.3 Test Setup Layout	69
8.4 Measurement equipment	69



8.5 Test Result and Data 69

9. Spurious Emissions Measurement 79

9.1 Limits Of Conducted Emissions Measurement 79

9.2 Measurement equipment 79

9.3 Test Procedure (please refer to measurement standard) 79

9.4 Test Results 80

10. Restricted Bands of Operation 89

10.1 Labeling Requirement 89



History of this test report

ORIGINAL.

Additional attachment as following record:



CERTIFICATE OF COMPLIANCE

According to

FCC Rules and Regulations Part 15 Subpart C

Applicant : Compex Systems Pte Ltd

Address : 135 Joo Seng Road, #08-01 PM Industrial Building,
Singapore 368363

Equipment : WIRELESS-AN 25DBM 3X3 NETWORK MINI PCIE
ADAPTER

Model No. : WLE350N5-25

FCC ID : TK4WLE350N5-25H

Trade Name : Compex

I **HEREBY** CERTIFY THAT :

The measurements shown in this test report were made in accordance with the procedures given in **ANSI C63.4** The equipment was **passed** the test performed according to **FCC Rules and Regulations Part 15 Subpart C.**

The test was carried out on Apr 03,2013 at **CerpPASS Technology(Suzhou) Corp.**

Signature

Miro Chueh/ Technical director



1. Report of Measurements and Examinations

1.1 List of Measurements and Examinations

FCC Rule	Description of Test	Result
15.203	. Antenna Requirement	Pass
15.207	. Conducted Emission	Pass
15.209 15.247(d)	. Radiated Emission	Pass
15.247(a)(2)	. 6dB Bandwidth	Pass
15.247(b)	. Maximum Peak Output Power	Pass
15.247(d)	. 100kHz Bandwidth of Frequency Band Edges	Pass
15.247(e)	. Power Spectral Density	Pass
1.1307 1.1310 2.1091 2.1093	. RF Exposure Compliance	Pass



2. Test Configuration of Equipment under Test

2.1 Manufacturer

Compex Systems Pte Ltd

135 Joo Seng Road, #08-01 PM Industrial Building, Singapore 368363

2.2 Feature of Equipment under Test

WIRELESS-AN 25DBM 3X3 NETWORK MINI PCIE ADAPTER	Model No :	WLE350N5-25
---	------------	-------------

WLAN module model name	AR9580/AR9590
Modulation techniques	OFDM
Frequency Range	802.11a/n(20MHz): 5745-5825MHz 802.11n(40MHz): 5755-5795MHz
Number of Channels	802.a/n (20MHz):5 802.11n (40MHz):2
Data Rate	IEEE 802.11a: 6/9/12/18/24/36/48/54 Mbps IEEE802.11n: MCS0~MCS15
Antenna Description	Please see 3.2 for details

Note: for more details, please refer to the User's manual of the EUT.



2.3 Carrier Frequency of Channels

802.11a, 11n HT20

Channel	Frequency(MHz)	Channel	Frequency(MHz)
149	5745	---	---
153	5765	---	---
157	5785	---	---
161	5802	---	---
165	5825	---	---
---	---	---	---

802.11n HT40

Channel	Frequency(MHz)	Channel	Frequency(MHz)
151	5755	---	---
159	5795	---	---
---	---	---	---
---	---	---	---
---	---	---	---
---	---	---	---



2.4 Test Mode and Test Software

- a. During testing, the interface cables and equipment positions were varied according to ANSI C63.4.
- b. The complete test system included remote workstation and EUT.
- c. An executive program, "wle350n5_25 art" under WIN XP was executed to transmit and receive data via wireless.
- d. The following test mode and test software was performed for conduction and radiation test:

Test mode:

The EUT transmitting and receiving with one antenna working at 802.11a mode, so one antenna working configuration was used for a mode testing in this report.

The EUT transmitting and receiving with three antennas working at 802.11n mode, so three antennas working configuration were used for an mode testing in this report.

The worst-case data rates are determined to be as follows for each mode based on investigation by measuring the average power, peak power and PPSD across all data rates, bandwidths, and modulations.

The worst-case data rates:

IEEE802.11a mode: Channel 5745MHz, Channel 5785MHz Channel 5825MHz with 54Mbps data rate were chosen for full testing.

IEEE802.11n HT20 mode: Channel 5745MHz, Channel 5785MHz Channel 5825MHz with 130Mbps data rate were chosen for full testing.

IEEE802.11n HT40 mode: Channel 5755MHz, Channel 5795MHz with 270Mbps data rate were chosen for full testing.

Pretest mode:

- 1. 19 dBi antenna for Transmitter and Receiver Spurious Emissions test.
- 2. 17 dBi antenna for Transmitter and Receiver Spurious Emissions test.
- 3. 10 dBi antenna for Transmitter and Receiver Spurious Emissions test.
- 4. 7 dBi antenna for Transmitter and Receiver Spurious Emissions test.
- 5. 5 dBi antenna for Transmitter and Receiver Spurious Emissions test.
- 6. 2 dBi antenna for Transmitter and Receiver Spurious Emissions test.

Final test mode:

- 1. 19 dBi antenna for Transmitter and Receiver Spurious Emissions test.
- 2. 10 dBi antenna for Transmitter and Receiver Spurious Emissions test.
- 3. 5 dBi antenna for Transmitter and Receiver Spurious Emissions test.

Then, the EUT configuration and cable configuration of the above highest emission mode was recorded for all final test items.

Note: we defined the 19,17 dBi antennas as the same type ,the 10,7,2 dBi antennas as the same type,the 5dBi antenna as an other type,We tested the Transmitter and Receiver Spurious Emissions both of the two different types.



2.5 Description of Test System

Device	Manufacturer	Model No.	Description
Remote workstation			
Notebook	HP	Presario CQ45	N/A
AC Adapter	DEKTA	PPP012D-S	N/A
Mini PCI to micro PCI card	HY	08-EP2MPE	N/A

Use Cable:

Cable	Quantity	Description
N/A	N/A	N/A



2.6 General Information of Test

Test Site:	CerpPASS Technology (Suzhou) Co.,Ltd
Test Site Location :	No.66,Tangzhuang Road, Suzhou Industrial Park, Jiangsu 215006, China
NVLAP LAB Code :	200814-0
FCC Registration Number :	916572, 331395
IC Registration Number :	7290A-1, 7290A-2
VCCI Registration Number :	T-1945 for Telecommunication Test C-2919 for Conducted emission test R-2670 for Radiated emission test below 1GHz G-227 for Radiated emission test above 1GHz
Frequency Range Investigated:	Conducted: from 150kHz to 30MHz Radiation: from 9kHz to 40000MHz
Test Distance:	The test distance of radiated emission from antenna to EUT is 3 M.

LABORATORY ACCREDITATION





2.7 Measurement Uncertainty

Measurement Item	Measurement Frequency	Polarization	Uncertainty
Conducted Emission	9 kHz ~ 30 MHz	LINE/NEUTRAL	2.71 dB
Radiated Emission	30 MHz ~ 40GHz	Vertical	4.11 dB
		Horizontal	4.10 dB
6 dB Bandwidth	802.11a/n(20 MHz): 5745~5825MHz 802.11 n(40 MHz): 5755 ~ 5795 MHz	---	7500 Hz
Maximum Peak Output Power	802.11a/n(20 MHz): 5745~5825MHz 802.11 n(40 MHz): 5755 ~ 5795 MHz	---	1.4 dB
100kHz Bandwidth of Frequency Band Edges	802.11a/n(20 MHz): 5745~5825MHz 802.11 n(40 MHz): 5755 ~ 5795 MHz	---	2.2 dB
Power Spectral Density	802.11a/n(20 MHz): 5745~5825MHz 802.11 n(40 MHz): 5755 ~ 5795 MHz	---	1.4 dB



3. Antenna Requirements

3.1 Standard Applicable

For intentional device, according to FCC 47 CFR Section 15.203, an intentional radiator shall be designed to ensure that no antenna other than that furnished by the responsible party shall be used with the device. The use of a permanently attached antenna or of an antenna that uses a unique coupling to the intentional radiator shall be considered sufficient to comply with the provisions of this Section.

And according to FCC 47 CFR Section 15.247 (b), if transmitting antennas of directional gain greater than 6dBi are used, the power shall be reduced by the amount in dB that the directional gain of the antenna exceeds 6dBi.



3.2 Antenna Construction and Directional Gain

No.	Antenna type	Antenna Gain	Manufacturer	Model name	Cable
1	Panel Antenna	19 dBi	Compex	MME-5N19	N/A
2	Panel Antenna	17 dBi	Compex	MJE-5N17	N/A
3	Omni Antenna	10 dBi	Foshan Lanbowan Communications Ltd.	ANT5158Q10V	IPEX MHF
4	Omni Antenna	7 dBi	SmartANT Telecom Co.,Ltd	SAA04-22008A	IPEX MHF
5	Omni Antenna	2 dBi	Kunshan Wavelink Electronic Co., Ltd	WD12020258G	IPEX MHF
6	invented Antenna	5 dBi	A*STAR	A*STAR	N/A

We use the 19dBi,10dBi and 5 dBi as different construction types for test

Antenna	1X1 (Antenna No. 3)	2X2(Antenna No.1)	3X3(Antenna No. 6)
Used port	Chain 0	Chain 0+Chain 1	Chain 0&Chain 1&Chain 2
	Chain 1	Chain 0+Chain 2	
	Chain 2	Chain 1+Chain 2	

1X1 Total gain =10 dBi

2X2 Total gain = $G_{ANT} + 10 \log(N)$ dBi=22.01 dBi

3X3 Total gain = $G_{ANT} + 10 \log(N)$ dBi=9.77 dBi



4. Test of Conducted Emission

4.1 Test Limit

Conducted Emissions were measured from 150 kHz to 30 MHz with a bandwidth of 9 KHz on the 120 VAC power and return leads of the EUT according to the methods defined in ANSI C63.4-2009 Section 3.1. The EUT was placed on a nonmetallic stand in a shielded room 0.8 meters above the ground plane as shown in section 2.2. The interface cables and equipment positioning were varied within limits of reasonable applications to determine the position produced maximum conducted emissions.

Frequency (MHz)	Quasi Peak (dB μ V)	Average (dB μ V)
0.15 – 0.5	66-56*	56-46*
0.5 – 5.0	56	46
5.0 – 30.0	60	50

*Decreases with the logarithm of the frequency.

4.2 Test Procedures

- The EUT was placed 0.4 meter from the conducting wall of the shielding room was kept at least 80 centimeters from any other grounded conducting surface.
- Connect EUT to the power mains through a line impedance stabilization network (LISN).
- All the support units are connecting to the other LISN.
- The LISN provides 50 ohm coupling impedance for the measuring instrument.
- The FCC states that a 50 ohm, 50 micro-Henry LISN should be used.
- Both sides of AC line were checked for maximum conducted interference.
- The frequency range from 150 kHz to 30 MHz was searched.
- Set the test-receiver system to Peak Detect Function and Specified Bandwidth with Maximum Hold Mode.



4.3 Typical Test Setup

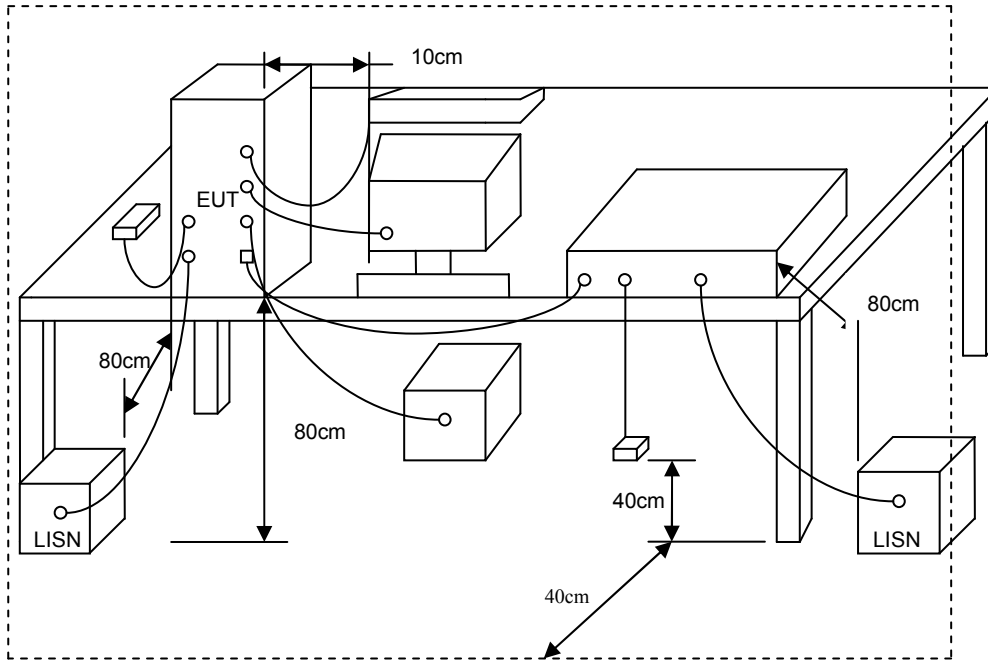

4.4 Measurement equipment

Instrument	Manufacturer	Model No.	Serial No.	Calibration Date	Valid Date.
Test Receiver	R&S	ESCI	100565	2012.11.05	2013.11.04
AMN	R&S	ESH2-Z5	100182	2012.11.05	2013.11.04
Two-Line V-Network	R&S	ENV216	100325	2013.03.10	2014.03.09
ISN	FCC	FCC-TLISN-T 2-02	20379	2012.12.08	2013.12.07
ISN	FCC	FCC-TLISN-T 4-02	20380	2012.12.08	2013.12.07
ISN	FCC	FCC-TLISN-T 8-02	20381	2012.12.08	2013.12.07
ISN	TESEQ	ISN ST08	30175	2012.09.13	2013.09.12
Current Probe	R&S	EZ-17	100303	2013.03.10	2014.03.09
Passive Voltage Probe	R&S	ESH2-Z3	100026	2013.03.10	2014.03.09
Attenuator	R&S	ESH3-Z2	100529	2013.03.10	2014.03.09
Temperature/ Humidity Meter	Zhicheng	ZC1-11	CEP-TH-004	2013.03.10	2014.03.09



4.5 Test Result and Data

Test Mode :	Normal link		
AC Power :	AC 120V/60Hz	Phase :	NEUTRAL
Temperature :	22°C	Humidity :	50%
Pressure(mbar) :	1002	Date:	2013/04/03

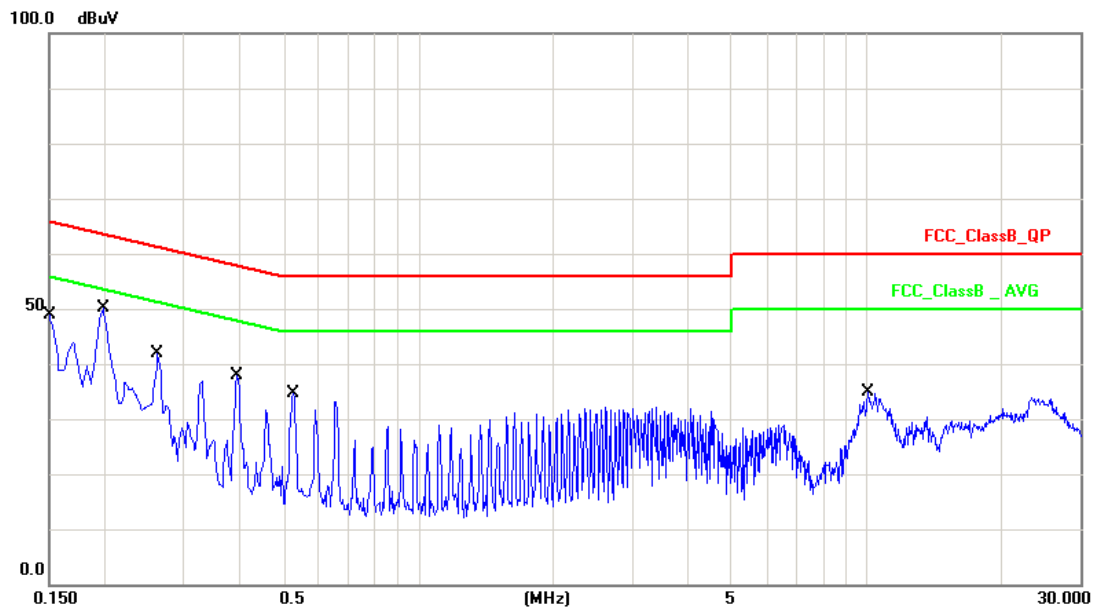

No.	Frequency (MHz)	Factor (dB)	Reading (dBuV)	Level (dBuV)	Limit (dBuV)	Margin (dB)	Detector
1	0.1500	9.50	29.95	39.45	66.00	-26.55	QP
2	0.1500	9.50	6.68	16.18	56.00	-39.82	AVG
3	0.1980	9.50	39.05	48.55	63.69	-15.14	QP
4	0.1980	9.50	33.68	43.18	53.69	-10.51	AVG
5	0.2620	9.50	31.27	40.77	61.37	-20.60	QP
6	0.2620	9.50	26.11	35.61	51.37	-15.76	AVG
7	0.3940	9.50	27.23	36.73	57.98	-21.25	QP
8	0.3940	9.50	24.40	33.90	47.98	-14.08	AVG
9	0.5260	9.50	22.94	32.44	56.00	-23.56	QP
10	0.5260	9.50	22.51	32.01	46.00	-13.99	AVG
11	10.0860	9.84	21.86	31.70	60.00	-28.30	QP
12	10.0860	9.84	17.25	27.09	50.00	-22.91	AVG

Note: Measurement Level = Reading Level + Correct Factor



Test Mode :	Normal link		
AC Power :	AC 120V/60Hz	Phase :	LINE
Temperature :	22°C	Humidity :	50%
Pressure(mbar) :	1002	Date:	2013/04/03

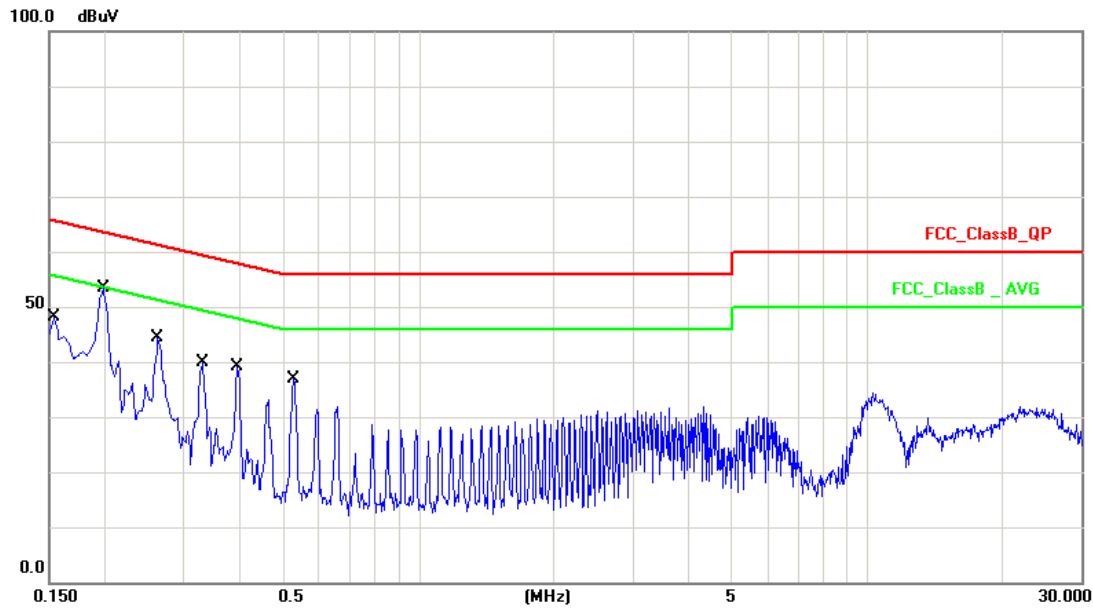

No.	Frequency (MHz)	Factor (dB)	Reading (dBuV)	Level (dBuV)	Limit (dBuV)	Margin (dB)	Detector
1	0.1539	9.87	28.56	38.43	65.79	-27.36	QP
2	0.1539	9.87	6.25	16.12	55.79	-39.67	AVG
3	0.1980	9.87	42.41	52.28	63.69	-11.41	QP
4	0.1980	9.87	35.51	45.38	53.69	-8.31	AVG
5	0.2620	9.86	33.33	43.19	61.37	-18.18	QP
6	0.2620	9.86	27.60	37.46	51.37	-13.91	AVG
7	0.3300	9.87	28.12	37.99	59.45	-21.46	QP
8	0.3300	9.87	22.54	32.41	49.45	-17.04	AVG
9	0.3940	9.86	27.74	37.60	57.98	-20.38	QP
10	0.3940	9.86	24.96	34.82	47.98	-13.16	AVG
11	0.5260	9.85	25.38	35.23	56.00	-20.77	QP
12	0.5260	9.85	24.25	34.10	46.00	-11.90	AVG

Note: Measurement Level = Reading Level + Correct Factor



5. Test of Radiated Emission

5.1 Test Limit

Radiated emissions from 30 MHz to 40 GHz were measured according to the methods defines in ANSI C63.4-2009. The EUT was placed, 0.8 meter above the ground plane, as shown in section 5.6.3. The interface cables and equipment positions were varied within limits of reasonable applications to determine the positions producing maximum radiated emissions

For unintentional device, according to § 15.109(a), except for Class A digital devices, the field strength of radiated emissions from unintentional radiators at a distance of 3 meters shall not exceed the following values:

FREQUENCIES(MHz)	FIELD STRENGTH (microvolts/meter)	MEASUREMENT DISTANCE(meters)
0.009~0.490	2400/F(kHz)	300
0.490~1.705	24000/F(kHz)	30
1.705~30.0	30	30
30~88	100	3
88~216	150	3
216~960	200	3
Above 960	500	3

For unintentional device, according to CISPR PUB.22, for Class B digital devices, the general requirement of field strength of radiated emissions from intentional radiators at a distance of 10 meters shall not exceed the below table.

Frequency (MHz)	Distance Meters	Radiated (dB μ V/ M)
30-230	10	30
230-1000	10	37

5.2 Test Procedures

- The EUT was placed on a rotatable table top 0.8 meter above ground.
- The EUT was set 3 meters from the interference receiving antenna which was mounted on the top of a variable height antenna tower.
- The table was rotated 360 degrees to determine the position of the highest radiation.
- The antenna is a broadband antenna and its height is varied between one meter and four meters above ground to find the maximum value of the field strength both horizontal polarization and vertical polarization of the antenna are set to make the measurement.
- For each suspected emission the EUT was arranged to its worst case and then tune the antenna tower (from 1 M to 4 M) and turn table (from 0 degree to 360 degrees) to find the maximum reading.
- Set the test-receiver system to Peak or CISPR quasi-peak Detect Function and specified bandwidth with Maximum Hold Mode.
- If the emission level of the EUT in peak mode was 3 dB lower than the limit specified, then testing will be stopped and peak values of EUT will be reported, otherwise, the emissions which do not have 3 dB margin will be repeated one by one using the quasi-peak method and reported.
- For testing above 1GHz, the emission level of the EUT in peak mode was 20dB lower than average limit (that means the emission level in peak mode also complies with the limit in average



mode), then testing will be stopped and peak values of EUT will be reported, otherwise, the emissions will be measured in average mode again and reported.

5.3 Typical Test Setup

Below 1GHz Test Setup

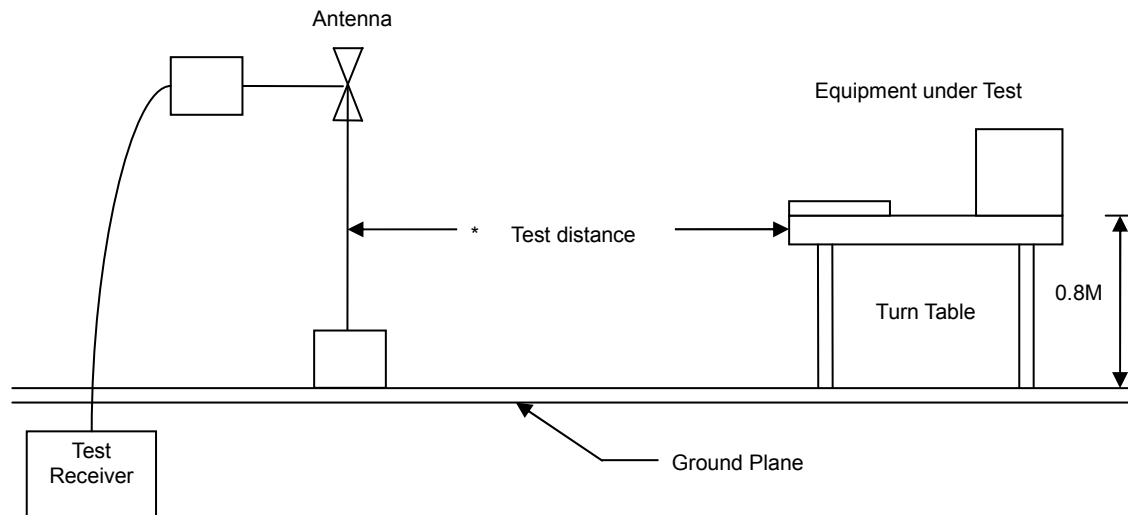

Above 1GHz Test Setup

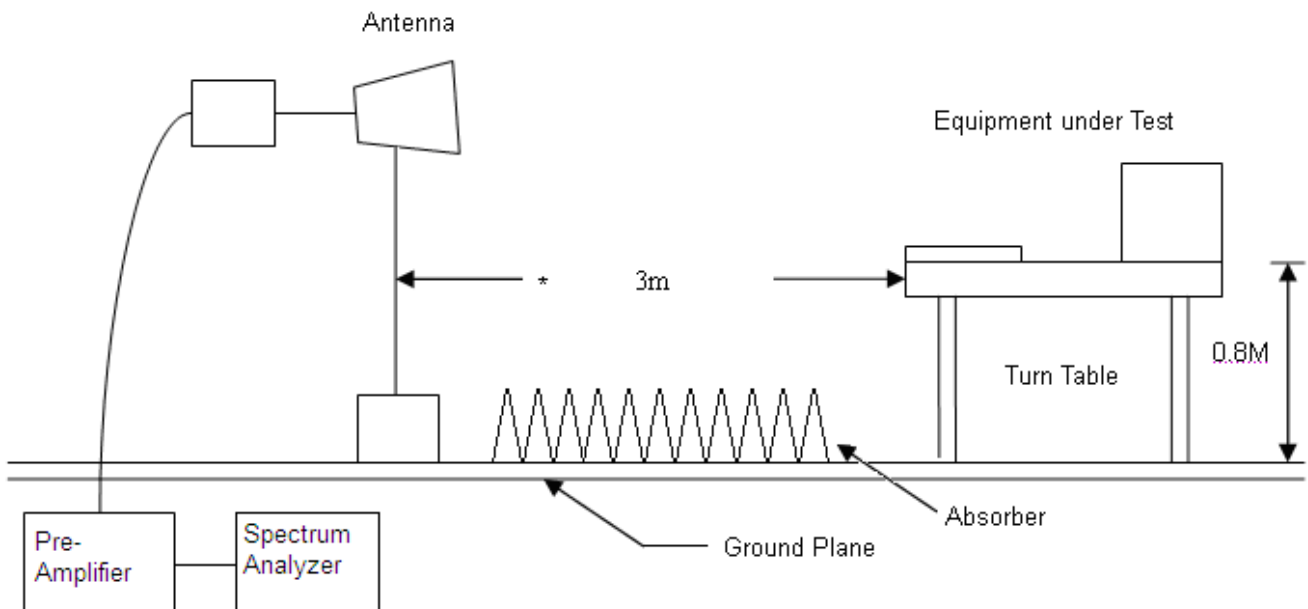



5.4 Measurement equipment

Instrument	Manufacturer	Model No.	Serial No.	Calibration Date	Valid Date
EMI Test Receiver	R&S	ESCI	100563	2013.03.10	2014.03.09
Preamplifier	Agilent	8449B	3008A02342	2013.03.10	2014.03.09
Preamplifier	COM-POWER	PA-840	711885	2013.03.10	2014.03.09
Ultra Broadband Antenna	R&S	HL562	100362	2012.05.03	2013.05.02
Broad-Band Horn Antenna	Schwarzbeck	BBHA9120D	9120D-619	2012.05.03	2013.05.02
Broad-Band Horn Antenna	Schwarzbeck	BBHA9170	9170-347	2012.05.15	2013.05.15
Spectrum Analyzer	R&S	FSP40	100324	2013.03.10	2014.03.09
Temperature/ Humidity Meter	Zhicheng	ZC1-11	CEP-TH-002	2013.03.10	2014.03.09



5.5 Test Result and Data

The 9kHz-30MHz spurious emission is under limit 20dB more.

5.5.1 Test Result and Data of Transmitter

For 19dBi antenna

Under 1G

Site : EMC Lab AC 102	Time : 2013/04/03
Limit : FCC_CLASS_B_03M_QP	Margin : 6
Test mode: normal link	Probe : VERTICAL/ HORIZONTAL
Power : AC 120V/60Hz	

Freq. (MHz)	Ant.Pol. H/V	Reading Level (dBuV)	Correct Factor (dB)	Measure Level (dBuV/m)	Limit 3m (dBuV/m)	Safe Margin (dB)	Detector Mode (PK/QP)
124.0900	V	44.52	-13.95	30.57	43.50	-12.93	QP
151.2500	V	47	-15.45	31.55	43.50	-11.95	QP
293.8400	V	41.72	-11.13	30.59	46.00	-15.41	QP
425.7600	V	38.63	-6.85	31.78	46.00	-14.22	QP
664.3800	V	38.13	-1.29	36.84	46.00	-9.16	QP
798.2400	V	33.25	1.04	34.29	46.00	-11.71	QP
200.7199	H	45.95	-15.37	30.58	43.50	-12.92	QP
292.8700	H	41.34	-11.17	30.17	46.00	-15.83	QP
366.5899	H	39.91	-8.65	31.26	46.00	-14.74	QP
468.4399	H	35.55	-5.68	29.87	46.00	-16.13	QP
665.3500	H	32.52	-1.26	31.26	46.00	-14.74	QP
799.2100	H	31.81	1.06	32.87	46.00	-13.13	QP

Note:

1. All Readings below 1GHz are Quasi-Peak, above are performed with peak and/or average measurements as necessary.
2. Measurement Level = Reading Level + Correct Factor



Above 1G

Site : EMC Lab AC 102	Time : 2013/04/03
Limit : FCC_CLASS_B_03M_QP	Margin : 6
Test mode: Transmit by 802.11a (5745MHz)	Probe : VERTICAL/ HORIZONTAL
Power : AC 120V/60Hz	1TX

Freq. (MHz)	Ant. Pol H/V	Peak Reading (dBuV)	AV Reading (dBuV)	Ant. / CL CF (dB)	Actual Fs		Peak Limit (dBuV/m)	AV Limit (dBuV/m)	Safe Margin (dB)	Detector Mode (PK/QP)
					Peak (dBuV/m)	AV (dBuV/m)				
11490.23	V	43.24	35.98	6.53	49.77	42.51	74.00	54.00	-11.49	average
11491.12	H	43.62	34.57	6.53	50.15	41.10	74.00	54.00	-12.90	average

Note:

1. All Readings below 1GHz are Quasi-Peak, above are performed with peak and/or average measurements as necessary.
2. Measurement Level = Reading Level + Correct Factor



Site : EMC Lab AC 102	Time : 2013/04/03
Limit : FCC_CLASS_B_03M_QP	Margin : 6
Test mode: Transmit by 802.11a (5785MHz)	Probe : VERTICAL/ HORIZONTAL
Power : AC 120V/60Hz	1TX

Freq. (MHz)	Ant. Pol H/V	Peak Reading (dBuV)	AV Reading (dBuV)	Ant. / CL CF (dB)	Actual Fs		Peak Limit (dBuV/m)	AV Limit (dBuV/m)	Safe Margin (dB)	Detector Mode (PK/QP)
					Peak (dBuV/m)	AV (dBuV/m)				
11570.21	V	46.92	36.55	6.99	53.91	43.54	74.00	54.00	-10.46	average
11570.33	H	46.39	35.41	6.99	53.38	42.40	74.00	54.00	-11.60	average

Note:

1. All Readings below 1GHz are Quasi-Peak, above are performed with peak and/or average measurements as necessary.
2. Measurement Level = Reading Level + Correct Factor



Site : EMC Lab AC 102	Time : 2013/04/03
Limit : FCC_CLASS_B_03M_QP	Margin : 6
Test mode: Transmit by 802.11a (5825MHz)	Probe : VERTICAL/ HORIZONTAL
Power : AC 120V/60Hz	1TX

Freq. (MHz)	Ant. Pol H/V	Peak Reading (dBuV)	AV Reading (dBuV)	Ant. / CL CF (dB)	Actual Fs		Peak Limit (dBuV/m)	AV Limit (dBuV/m)	Safe Margin (dB)	Detector Mode (PK/QP)
					Peak (dBuV/m)	AV (dBuV/m)				
11650.00	V	44.89	36.74	6.85	51.74	43.59	74.00	54.00	-10.41	average
11650.22	H	44.62	36.51	6.85	51.47	43.36	74.00	54.00	-10.64	average

Note:

1. All Readings below 1GHz are Quasi-Peak, above are performed with peak and/or average measurements as necessary.
2. Measurement Level = Reading Level + Correct Factor



Site : EMC Lab AC 102	Time : 2013/04/03
Limit : FCC_CLASS_B_03M_QP	Margin : 6
Test mode: Transmit by 802.11n (20MHz) (5745MHz)	Probe : VERTICAL/ HORIZONTAL
Power : AC 120V/60Hz	2TX

Freq. (MHz)	Ant. Pol H/V	Peak Reading (dBuV)	AV Reading (dBuV)	Ant. / CL CF (dB)	Actual Fs		Peak Limit (dBuV/m)	AV Limit (dBuV/m)	Safe Margin (dB)	Detector Mode (PK/QP)
					Peak (dBuV/m)	AV (dBuV/m)				
11490.23	V	45.96	36.44	6.99	52.95	43.43	74.00	54.00	-10.57	average
11490.56	H	45.27	36.04	6.99	52.26	43.03	74.00	54.00	-10.97	average

Note:

1. All Readings below 1GHz are Quasi-Peak, above are performed with peak and/or average measurements as necessary.
2. Measurement Level = Reading Level + Correct Factor



Site : EMC Lab AC 102	Time : 2013/04/03
Limit : FCC_CLASS_B_03M_QP	Margin : 6
Test mode: Transmit by 802.11n (20MHz) (5785MHz)	Probe : VERTICAL/ HORIZONTAL
Power : AC 120V/60Hz	2TX

Freq. (MHz)	Ant. Pol H/V	Peak Reading (dBuV)	AV Reading (dBuV)	Ant. / CL CF (dB)	Actual Fs		Peak Limit (dBuV/m)	AV Limit (dBuV/m)	Safe Margin (dB)	Detector Mode (PK/QP)
					Peak (dBuV/m)	AV (dBuV/m)				
11570.23	V	47.01	36.44	6.85	53.86	43.29	74.00	54.00	-10.71	average
11570.34	H	45.77	35.96	6.85	52.62	42.81	74.00	54.00	-11.19	average

Note:

1. All Readings below 1GHz are Quasi-Peak, above are performed with peak and/or average measurements as necessary.
2. Measurement Level = Reading Level + Correct Factor



Site : EMC Lab AC 102	Time : 2013/04/03
Limit : FCC_CLASS_B_03M_QP	Margin : 6
Test mode: Transmit by 802.11n (20MHz) (5825MHz)	Probe : VERTICAL/ HORIZONTAL
Power : AC 120V/60Hz	2TX

Freq. (MHz)	Ant. Pol H/V	Peak Reading (dBuV)	AV Reading (dBuV)	Ant. / CL CF (dB)	Actual Fs		Peak Limit (dBuV/m)	AV Limit (dBuV/m)	Safe Margin (dB)	Detector Mode (PK/QP)
					Peak (dBuV/m)	AV (dBuV/m)				
11650.33	V	46.33	36.51	6.61	52.94	43.12	74.00	54.00	-10.88	average
11651.23	H	44.63	36.33	6.61	51.24	42.94	74.00	54.00	-11.06	average

Note:

1. All Readings below 1GHz are Quasi-Peak, above are performed with peak and/or average measurements as necessary.
2. Measurement Level = Reading Level + Correct Factor



Site : EMC Lab AC 102	Time : 2013/04/03
Limit : FCC_CLASS_B_03M_QP	Margin : 6
Test mode: Transmit by 802.11n (40MHz) (5755MHz)	Probe : VERTICAL/ HORIZONTAL
Power : AC 120V/60Hz	2TX

Freq. (MHz)	Ant. Pol H/V	Peak Reading (dBuV)	AV Reading (dBuV)	Ant. / CL CF (dB)	Actual Fs		Peak Limit (dBuV/m)	AV Limit (dBuV/m)	Safe Margin (dB)	Detector Mode (PK/QP)
					Peak (dBuV/m)	AV (dBuV/m)				
11510.24	V	44.99	37.01	6.85	51.84	43.86	74.00	54.00	-10.14	average
11510.56	H	44.17	33.66	6.85	51.02	40.51	74.00	54.00	-13.49	average

Note:

1. All Readings below 1GHz are Quasi-Peak, above are performed with peak and/or average measurements as necessary.
2. Measurement Level = Reading Level + Correct Factor



Site : EMC Lab AC 102	Time : 2013/04/03
Limit : FCC_CLASS_B_03M_QP	Margin : 6
Test mode: Transmit by 802.11n (40MHz) (5795MHz)	Probe : VERTICAL/ HORIZONTAL
Power : AC 120V/60Hz	2TX

Freq. (MHz)	Ant. Pol H/V	Peak Reading (dBuV)	AV Reading (dBuV)	Ant. / CL CF (dB)	Actual Fs		Peak Limit (dBuV/m)	AV Limit (dBuV/m)	Safe Margin (dB)	Detector Mode (PK/QP)
					Peak (dBuV/m)	AV (dBuV/m)				
11590.56	V	46.96	34.87	6.92	53.88	41.79	74.00	54.00	-12.21	average
11590.25	H	44.96	35.69	6.92	51.88	42.61	74.00	54.00	-11.39	average

Note:

1. All Readings below 1GHz are Quasi-Peak, above are performed with peak and/or average measurements as necessary.
2. Measurement Level = Reading Level + Correct Factor

**For 10dBi antenna**

Under 1G

Site : EMC Lab AC 102	Time : 2013/04/03
Limit : FCC_CLASS_B_03M_QP	Margin : 6
Test mode: normal link	Probe : VERTICAL/ HORIZONTAL
Power : AC 120V/60Hz	

Frequency (MHz)	AntPol. H/V	Correct Factor (dB)	Reading level (dBuV)	Measure Level (dBuV/m)	Limit 3m (dBuV/m)	Safe Margin (dB)	Detector mode (PK/QP)
146.4000	H	-15.26	40.62	25.36	43.50	-18.14	QP
204.5999	H	-15.13	42.66	27.53	43.50	-15.97	QP
338.4599	H	-9.59	41.08	31.49	46.00	-14.51	QP
685.7199	H	-0.83	39.77	38.94	46.00	-7.06	QP
753.6200	H	0.33	36.87	37.20	46.00	-8.80	QP
832.1900	H	1.70	33.25	34.95	46.00	-11.05	QP
206.5399	V	-15.01	41.35	26.34	43.50	-17.16	QP
330.7000	V	-9.85	37.44	27.59	46.00	-18.41	QP
655.6500	V	-1.47	39.71	38.24	46.00	-7.76	QP
718.7000	V	-0.23	35.47	35.24	46.00	-10.76	QP
763.3200	V	0.48	35.76	36.24	46.00	-9.76	QP
831.2199	V	1.69	36.69	38.38	46.00	-7.62	QP

Note:

1. All Readings below 1GHz are Quasi-Peak, above are performed with peak and/or average measurements as necessary.
2. Measurement Level = Reading Level + Correct Factor



Above 1G

Site : EMC Lab AC 102	Time : 2013/04/03
Limit : FCC_CLASS_B_03M_QP	Margin : 6
Test mode: Transmit by 802.11a (5745MHz)	Probe : VERTICAL/ HORIZONTAL
Power : AC 120V/60Hz	1TX

Freq. (MHz)	Ant. Pol H/V	Peak Reading (dBuV)	AV Reading (dBuV)	Ant. / CL CF (dB)	Actual Fs		Peak Limit (dBuV/m)	AV Limit (dBuV/m)	Safe Margin (dB)	Detector Mode (PK/QP)
					Peak (dBuV/m)	AV (dBuV/m)				
11490.36	V	43.52	36.03	6.53	50.05	42.56	74.00	54.00	-11.44	average
11491.71	H	43.24	34.26	6.53	49.77	40.79	74.00	54.00	-13.21	average

Note:

1. All Readings below 1GHz are Quasi-Peak, above are performed with peak and/or average measurements as necessary.
2. Measurement Level = Reading Level + Correct Factor



Site : EMC Lab AC 102	Time : 2013/04/03
Limit : FCC_CLASS_B_03M_QP	Margin : 6
Test mode: Transmit by 802.11a (5785MHz)	Probe : VERTICAL/ HORIZONTAL
Power : AC 120V/60Hz	1TX

Freq. (MHz)	Ant. Pol H/V	Peak Reading (dBuV)	AV Reading (dBuV)	Ant. / CL CF (dB)	Actual Fs		Peak Limit (dBuV/m)	AV Limit (dBuV/m)	Safe Margin (dB)	Detector Mode (PK/QP)
					Peak (dBuV/m)	AV (dBuV/m)				
11570.36	V	46.88	36.78	6.99	53.87	43.77	74.00	54.00	-10.23	average
11570.17	H	46.31	35.62	6.99	53.30	42.61	74.00	54.00	-11.39	average

Note:

1. All Readings below 1GHz are Quasi-Peak, above are performed with peak and/or average measurements as necessary.
2. Measurement Level = Reading Level + Correct Factor



Site : EMC Lab AC 102	Time : 2013/04/03
Limit : FCC_CLASS_B_03M_QP	Margin : 6
Test mode: Transmit by 802.11a (5825MHz)	Probe : VERTICAL/ HORIZONTAL
Power : AC 120V/60Hz	1TX

Freq. (MHz)	Ant. Pol H/V	Peak Reading (dBuV)	AV Reading (dBuV)	Ant. / CL CF (dB)	Actual Fs		Peak Limit (dBuV/m)	AV Limit (dBuV/m)	Safe Margin (dB)	Detector Mode (PK/QP)
					Peak (dBuV/m)	AV (dBuV/m)				
11650.36	V	44.56	36.74	6.85	51.41	43.59	74.00	54.00	-10.41	average
11650.78	H	45.03	36.87	6.85	51.88	43.72	74.00	54.00	-10.28	average

Note:

1. All Readings below 1GHz are Quasi-Peak, above are performed with peak and/or average measurements as necessary.
2. Measurement Level = Reading Level + Correct Factor



Site : EMC Lab AC 102	Time : 2013/04/03
Limit : FCC_CLASS_B_03M_QP	Margin : 6
Test mode: Transmit by 802.11n (20MHz) (5745MHz)	Probe : VERTICAL/ HORIZONTAL
Power : AC 120V/60Hz	1TX

Freq. (MHz)	Ant. Pol H/V	Peak Reading (dBuV)	AV Reading (dBuV)	Ant. / CL CF (dB)	Actual Fs		Peak Limit (dBuV/m)	AV Limit (dBuV/m)	Safe Margin (dB)	Detector Mode (PK/QP)
					Peak (dBuV/m)	AV (dBuV/m)				
11490.03	V	45.87	36.65	6.99	52.86	43.64	74.00	54.00	-10.36	average
11490.36	H	45.36	36.24	6.99	52.35	43.23	74.00	54.00	-10.77	average

Note:

1. All Readings below 1GHz are Quasi-Peak, above are performed with peak and/or average measurements as necessary.
2. Measurement Level = Reading Level + Correct Factor



Site : EMC Lab AC 102	Time : 2013/04/03
Limit : FCC_CLASS_B_03M_QP	Margin : 6
Test mode: Transmit by 802.11n (20MHz) (5785MHz)	Probe : VERTICAL/ HORIZONTAL
Power : AC 120V/60Hz	1TX

Freq. (MHz)	Ant. Pol H/V	Peak Reading (dBuV)	AV Reading (dBuV)	Ant. / CL CF (dB)	Actual Fs		Peak Limit (dBuV/m)	AV Limit (dBuV/m)	Safe Margin (dB)	Detector Mode (PK/QP)
					Peak (dBuV/m)	AV (dBuV/m)				
11570.78	V	47.24	36.03	6.85	54.09	42.88	74.00	54.00	-11.12	average
11570.36	H	45.36	35.78	6.85	52.21	42.63	74.00	54.00	-11.37	average

Note:

1. All Readings below 1GHz are Quasi-Peak, above are performed with peak and/or average measurements as necessary.
2. Measurement Level = Reading Level + Correct Factor



Site : EMC Lab AC 102	Time : 2013/04/03
Limit : FCC_CLASS_B_03M_QP	Margin : 6
Test mode: Transmit by 802.11n (20MHz) (5825MHz)	Probe : VERTICAL/ HORIZONTAL
Power : AC 120V/60Hz	1TX

Freq. (MHz)	Ant. Pol H/V	Peak Reading (dBuV)	AV Reading (dBuV)	Ant. / CL CF (dB)	Actual Fs		Peak Limit (dBuV/m)	AV Limit (dBuV/m)	Safe Margin (dB)	Detector Mode (PK/QP)
					Peak (dBuV/m)	AV (dBuV/m)				
11650.17	V	46.57	36.58	6.61	53.18	43.19	74.00	54.00	-10.81	average
11651.87	H	44.87	36.12	6.61	51.48	42.73	74.00	54.00	-11.27	average

Note:

- All Readings below 1GHz are Quasi-Peak, above are performed with peak and/or average measurements as necessary.
- Measurement Level = Reading Level + Correct Factor



Site : EMC Lab AC 102	Time : 2013/04/03
Limit : FCC_CLASS_B_03M_QP	Margin : 6
Test mode: Transmit by 802.11n (40MHz) (5755MHz)	Probe : VERTICAL/ HORIZONTAL
Power : AC 120V/60Hz	1TX

Freq. (MHz)	Ant. Pol H/V	Peak Reading (dBuV)	AV Reading (dBuV)	Ant. / CL CF (dB)	Actual Fs		Peak Limit (dBuV/m)	AV Limit (dBuV/m)	Safe Margin (dB)	Detector Mode (PK/QP)
					Peak (dBuV/m)	AV (dBuV/m)				
11510.74	V	44.87	37.85	6.85	51.72	44.70	74.00	54.00	-9.30	average
11510.14	H	44.63	32.89	6.85	51.48	39.74	74.00	54.00	-14.26	average

Note:

1. All Readings below 1GHz are Quasi-Peak, above are performed with peak and/or average measurements as necessary.
2. Measurement Level = Reading Level + Correct Factor



Site : EMC Lab AC 102	Time : 2013/04/03
Limit : FCC_CLASS_B_03M_QP	Margin : 6
Test mode: Transmit by 802.11n (40MHz) (5795MHz)	Probe : VERTICAL/ HORIZONTAL
Power : AC 120V/60Hz	1TX

Freq. (MHz)	Ant. Pol H/V	Peak Reading (dBuV)	AV Reading (dBuV)	Ant. / CL CF (dB)	Actual Fs		Peak Limit (dBuV/m)	AV Limit (dBuV/m)	Safe Margin (dB)	Detector Mode (PK/QP)
					Peak (dBuV/m)	AV (dBuV/m)				
11590.36	V	47.25	35.02	6.92	54.17	41.94	74.00	54.00	-12.06	average
11590.26	H	45.78	34.57	6.92	52.70	41.49	74.00	54.00	-12.51	average

Note:

1. All Readings below 1GHz are Quasi-Peak, above are performed with peak and/or average measurements as necessary.
2. Measurement Level = Reading Level + Correct Factor

**For 5dBi antenna**

Under 1G

Site : EMC Lab AC 102	Time : 2013/04/03
Limit : FCC_CLASS_B_03M_QP	Margin : 6
Test mode: normal link	Probe : VERTICAL/ HORIZONTAL
Power : AC 120V/60Hz	

Frequency (MHz)	AntPol. H/V	Correct Factor (dB)	Reading level (dBuV)	Measure Level (dBuV/m)	Limit 3m (dBuV/m)	Safe Margin (dB)	Detector mode (PK/QP)
144.6700	H	-15.26	39.12	23.86	43.5	-19.64	QP
203.3300	H	-15.13	41.85	26.72	43.5	-16.78	QP
335.6111	H	-9.59	39.52	29.93	46	-16.07	QP
689.3499	H	-0.83	37.65	36.82	46	-9.18	QP
750.6699	H	0.33	35.01	35.34	46	-10.66	QP
835.7141	H	1.7	33.13	34.83	46	-11.17	QP
210.4512	V	-15.01	40.51	25.5	43.5	-18	QP
333.7123	V	-9.85	37.58	27.73	46	-18.27	QP
654.8241	V	-1.47	39.03	37.56	46	-8.44	QP
720.1457	V	-0.23	35.21	34.98	46	-11.02	QP
765.0124	V	0.48	34.96	35.44	46	-10.56	QP
830.5141	V	1.69	35.14	36.83	46	-9.17	QP

Note:

1. All Readings below 1GHz are Quasi-Peak, above are performed with peak and/or average measurements as necessary.
2. Measurement Level = Reading Level + Correct Factor



Above 1G

Site : EMC Lab AC 102	Time : 2013/04/03
Limit : FCC_CLASS_B_03M_QP	Margin : 6
Test mode: Transmit by 802.11a (5745MHz)	Probe : VERTICAL/ HORIZONTAL
Power : AC 120V/60Hz	1TX

Freq. (MHz)	Ant. Pol H/V	Peak Reading (dBuV)	AV Reading (dBuV)	Ant. / CL CF (dB)	Actual Fs		Peak Limit (dBuV/m)	AV Limit (dBuV/m)	Safe Margin (dB)	Detector Mode (PK/QP)
					Peak (dBuV/m)	AV (dBuV/m)				
11489.22	V	42.57	35.21	6.53	49.10	41.74	74.00	54.00	-12.26	average
11490.57	H	41.57	33.98	6.53	48.10	40.51	74.00	54.00	-13.49	average

Note:

1. All Readings below 1GHz are Quasi-Peak, above are performed with peak and/or average measurements as necessary.
2. Measurement Level = Reading Level + Correct Factor



Site : EMC Lab AC 102	Time : 2013/04/03
Limit : FCC_CLASS_B_03M_QP	Margin : 6
Test mode: Transmit by 802.11a (5785MHz)	Probe : VERTICAL/ HORIZONTAL
Power : AC 120V/60Hz	1TX

Freq. (MHz)	Ant. Pol H/V	Peak Reading (dBuV)	AV Reading (dBuV)	Ant. / CL CF (dB)	Actual Fs		Peak Limit (dBuV/m)	AV Limit (dBuV/m)	Safe Margin (dB)	Detector Mode (PK/QP)
					Peak (dBuV/m)	AV (dBuV/m)				
11568.94	V	45.14	35.82	6.99	52.13	42.81	74.00	54.00	-11.19	average
11571.52	H	44.91	35.02	6.99	51.90	42.01	74.00	54.00	-11.99	average

Note:

1. All Readings below 1GHz are Quasi-Peak, above are performed with peak and/or average measurements as necessary.
2. Measurement Level = Reading Level + Correct Factor



Site : EMC Lab AC 102	Time : 2013/04/03
Limit : FCC_CLASS_B_03M_QP	Margin : 6
Test mode: Transmit by 802.11a (5825MHz)	Probe : VERTICAL/ HORIZONTAL
Power : AC 120V/60Hz	1TX

Freq. (MHz)	Ant. Pol H/V	Peak Reading (dBuV)	AV Reading (dBuV)	Ant. / CL CF (dB)	Actual Fs		Peak Limit (dBuV/m)	AV Limit (dBuV/m)	Safe Margin (dB)	Detector Mode (PK/QP)
					Peak (dBuV/m)	AV (dBuV/m)				
11648.33	V	42.81	34.92	6.85	49.66	41.77	74.00	54.00	-12.23	average
11645.96	H	44.02	33.56	6.85	50.87	40.41	74.00	54.00	-13.59	average

Note:

1. All Readings below 1GHz are Quasi-Peak, above are performed with peak and/or average measurements as necessary.
2. Measurement Level = Reading Level + Correct Factor



Site : EMC Lab AC 102	Time : 2013/04/03
Limit : FCC_CLASS_B_03M_QP	Margin : 6
Test mode: Transmit by 802.11n (20MHz) (5745MHz)	Probe : VERTICAL/ HORIZONTAL
Power : AC 120V/60Hz	3TX

Freq. (MHz)	Ant. Pol H/V	Peak Reading (dBuV)	AV Reading (dBuV)	Ant. / CL CF (dB)	Actual Fs		Peak Limit (dBuV/m)	AV Limit (dBuV/m)	Safe Margin (dB)	Detector Mode (PK/QP)
					Peak (dBuV/m)	AV (dBuV/m)				
11492.55	V	44.09	35.86	6.99	51.08	42.85	74.00	54.00	-11.15	average
11490.75	H	44.91	35.82	6.99	51.90	42.81	74.00	54.00	-11.19	average

Note:

1. All Readings below 1GHz are Quasi-Peak, above are performed with peak and/or average measurements as necessary.
2. Measurement Level = Reading Level + Correct Factor



Site : EMC Lab AC 102	Time : 2013/04/03
Limit : FCC_CLASS_B_03M_QP	Margin : 6
Test mode: Transmit by 802.11n (20MHz) (5785MHz)	Probe : VERTICAL/ HORIZONTAL
Power : AC 120V/60Hz	3TX

Freq. (MHz)	Ant. Pol H/V	Peak Reading (dBuV)	AV Reading (dBuV)	Ant. / CL CF (dB)	Actual Fs		Peak Limit (dBuV/m)	AV Limit (dBuV/m)	Safe Margin (dB)	Detector Mode (PK/QP)
					Peak (dBuV/m)	AV (dBuV/m)				
11568.52	V	45.06	35.82	6.85	51.91	42.67	74.00	54.00	-11.33	average
11570.46	H	43.45	35.45	6.85	50.30	42.30	74.00	54.00	-11.70	average

Note:

1. All Readings below 1GHz are Quasi-Peak, above are performed with peak and/or average measurements as necessary.
2. Measurement Level = Reading Level + Correct Factor



Site : EMC Lab AC 102	Time : 2013/04/03
Limit : FCC_CLASS_B_03M_QP	Margin : 6
Test mode: Transmit by 802.11n (20MHz) (5825MHz)	Probe : VERTICAL/ HORIZONTAL
Power : AC 120V/60Hz	3TX

Freq. (MHz)	Ant. Pol H/V	Peak Reading (dBuV)	AV Reading (dBuV)	Ant. / CL CF (dB)	Actual Fs		Peak Limit (dBuV/m)	AV Limit (dBuV/m)	Safe Margin (dB)	Detector Mode (PK/QP)
					Peak (dBuV/m)	AV (dBuV/m)				
11653.12	V	45.22	36.11	6.61	51.83	42.72	74.00	54.00	-11.28	average
11650.33	H	44.21	35.23	6.61	50.82	41.84	74.00	54.00	-12.16	average

Note:

1. All Readings below 1GHz are Quasi-Peak, above are performed with peak and/or average measurements as necessary.
2. Measurement Level = Reading Level + Correct Factor



Site : EMC Lab AC 102	Time : 2013/04/03
Limit : FCC_CLASS_B_03M_QP	Margin : 6
Test mode: Transmit by 802.11n (40MHz) (5755MHz)	Probe : VERTICAL/ HORIZONTAL
Power : AC 120V/60Hz	3TX

Freq. (MHz)	Ant. Pol H/V	Peak Reading (dBuV)	AV Reading (dBuV)	Ant. / CL CF (dB)	Actual Fs		Peak Limit (dBuV/m)	AV Limit (dBuV/m)	Safe Margin (dB)	Detector Mode (PK/QP)
					Peak (dBuV/m)	AV (dBuV/m)				
11509.45	V	45.29	36.78	6.85	52.14	43.63	74.00	54.00	-10.37	average
11510.67	H	45.21	32.05	6.85	52.06	38.90	74.00	54.00	-15.10	average

Note:

1. All Readings below 1GHz are Quasi-Peak, above are performed with peak and/or average measurements as necessary.
2. Measurement Level = Reading Level + Correct Factor



Site : EMC Lab AC 102	Time : 2013/04/03
Limit : FCC_CLASS_B_03M_QP	Margin : 6
Test mode: Transmit by 802.11n (40MHz) (5795MHz)	Probe : VERTICAL/ HORIZONTAL
Power : AC 120V/60Hz	3TX

Freq. (MHz)	Ant. Pol H/V	Peak Reading (dBuV)	AV Reading (dBuV)	Ant. / CL CF (dB)	Actual Fs		Peak Limit (dBuV/m)	AV Limit (dBuV/m)	Safe Margin (dB)	Detector Mode (PK/QP)
					Peak (dBuV/m)	AV (dBuV/m)				
11588.92	V	46.21	34.96	6.92	53.13	41.88	74.00	54.00	-12.12	average
11590.75	H	44.67	34.92	6.92	51.59	41.84	74.00	54.00	-12.16	average

Note:

1. All Readings below 1GHz are Quasi-Peak, above are performed with peak and/or average measurements as necessary.
2. Measurement Level = Reading Level + Correct Factor



6. 6dB Bandwidth Measurement Data

6.1 Test Limit

The minimum of 6dB Bandwidth Measurement is 0.5 MHz.

6.2 Test Procedures

- The transmitter output was connected to the spectrum analyzer.
- Set RBW of spectrum analyzer to 100 KHz and VBW to 300 KHz.
- The 6 dB bandwidth is defined as the total spectrum the power of which is higher than peak power minus 6 dB.

6.3 Test Setup Layout

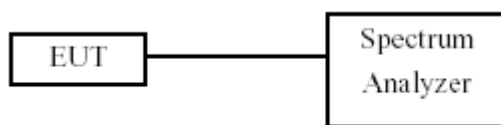

6.4 Measurement equipment

Instrument/Ancillary	Model No.	Manufacturer	Serial No.	Calibration Date	Valid Date
Spectrum Analyzer	FSP40	R&S	100324	2013.03.10	2014.03.09

6.5 Test Result and Data

Test Date: Apr 08,2013

Temperature: 25°C

Atmospheric pressure: 1020 hPa

Humidity: 46%

Modulation Standard	Channel	Frequency (MHz)	6dB Bandwidth (MHz)		
			Chain 0	Chain 1	Chain 2
802.11a	149	5745	16.7	---	---
	157	5785	16.6	---	---
	165	5825	16.7	---	---
802.11n HT20	149	5745	17.8	17.9	17.8
	157	5785	17.8	17.8	17.8
	165	5825	17.9	17.9	17.9
802.11n HT40	151	5755	36.8	36.8	36.8
	159	5795	36.4	36.4	36.4



Modulation Standard: 802.11a
Channel: 149

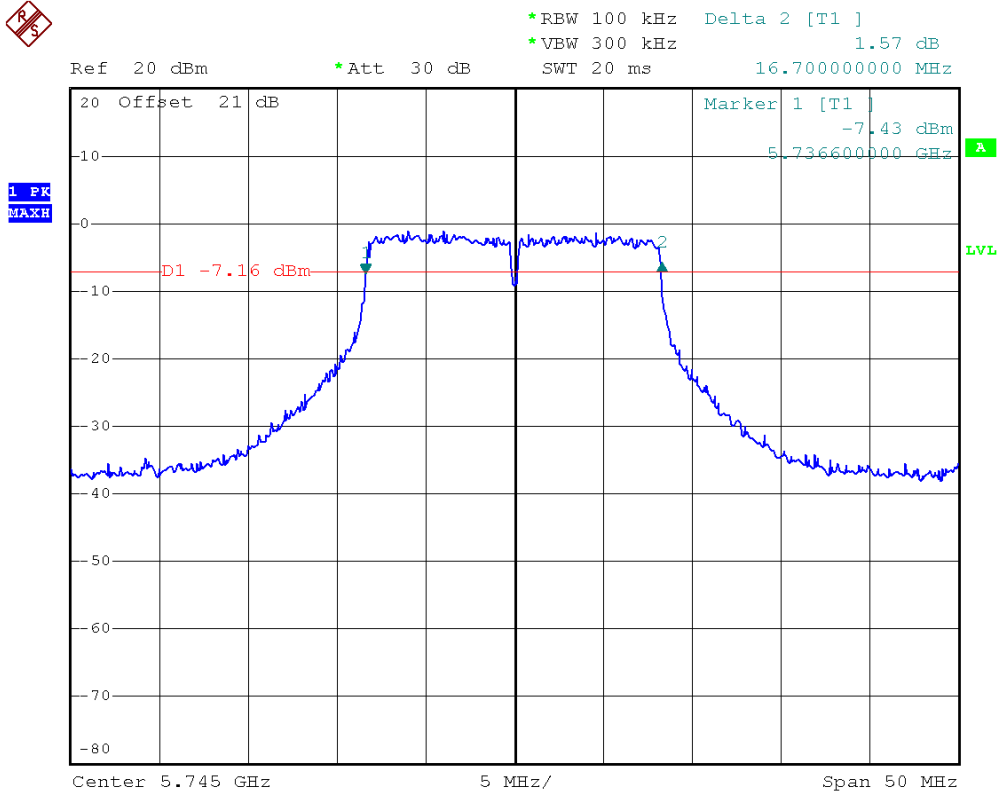

Modulation Standard: 802.11a
Channel: 157

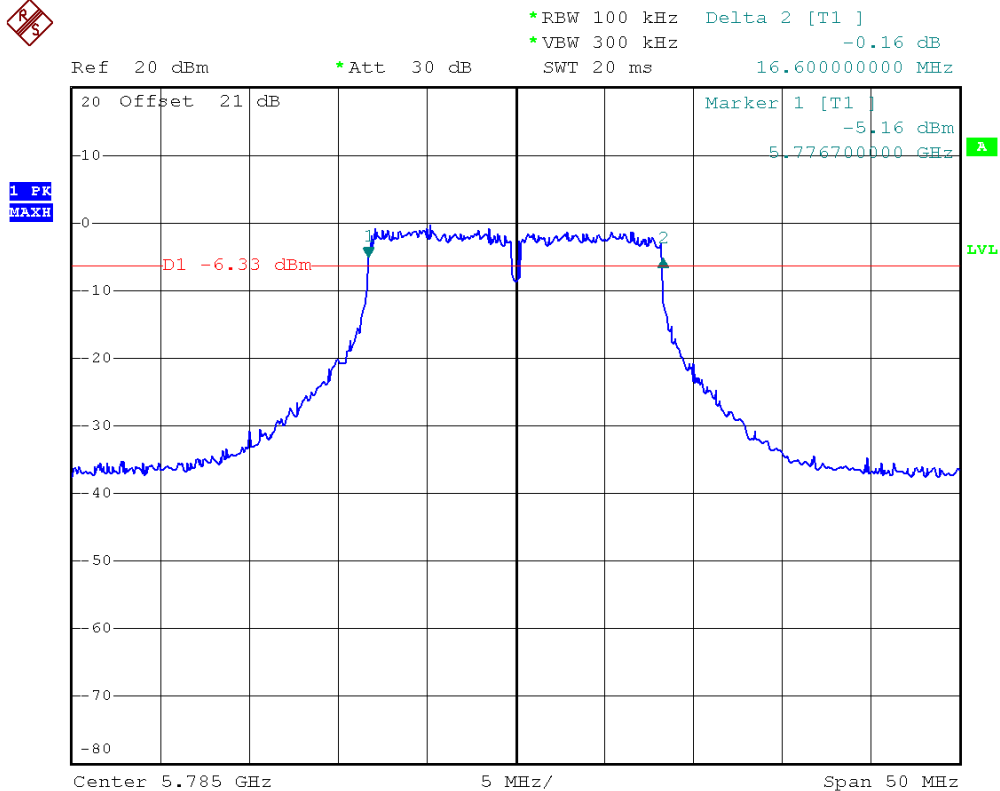



Modulation Standard: 802.11a
Channel: 165

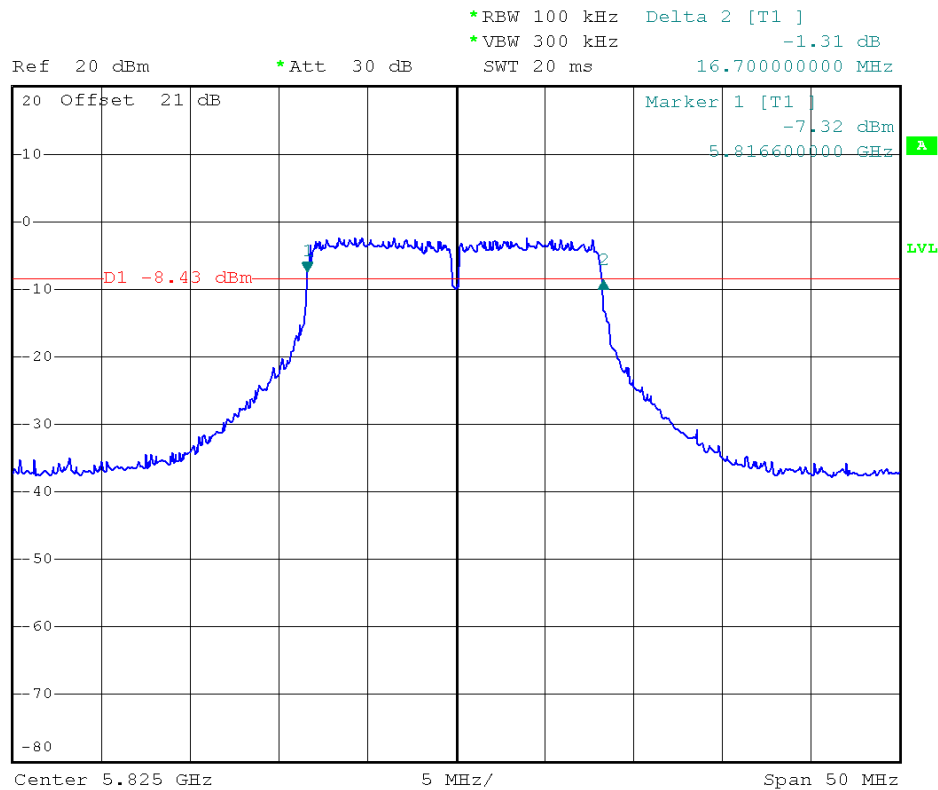

Modulation Standard: 802.11n HT20
Channel: 149 chain 0

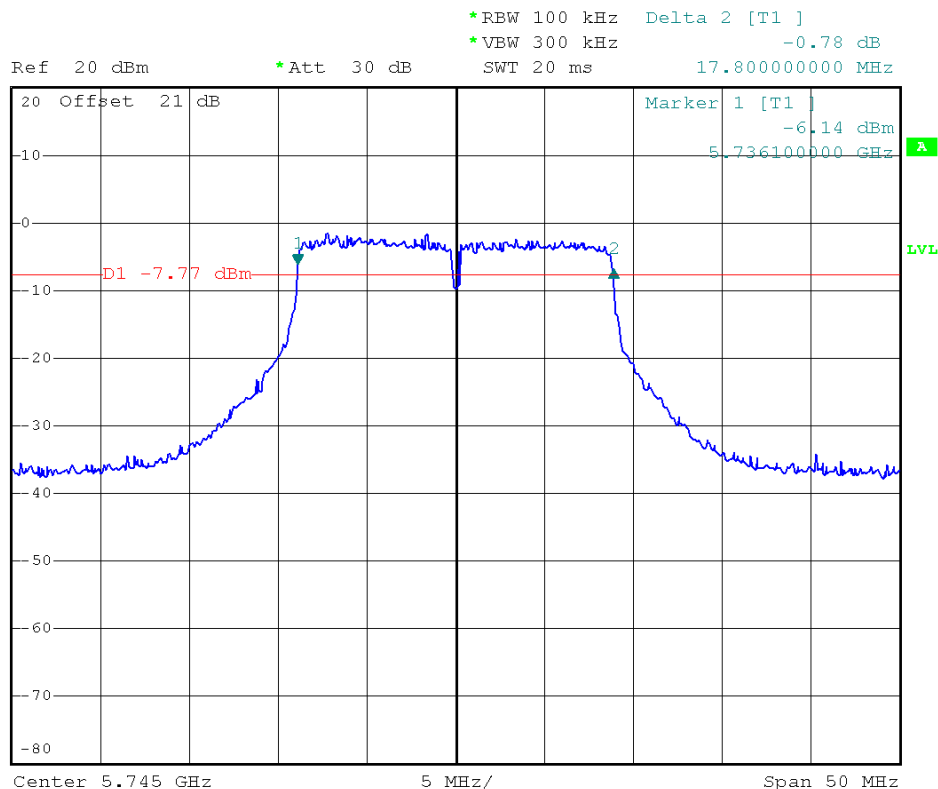



Modulation Standard: 802.11n HT20
Channel: 157 chain 0

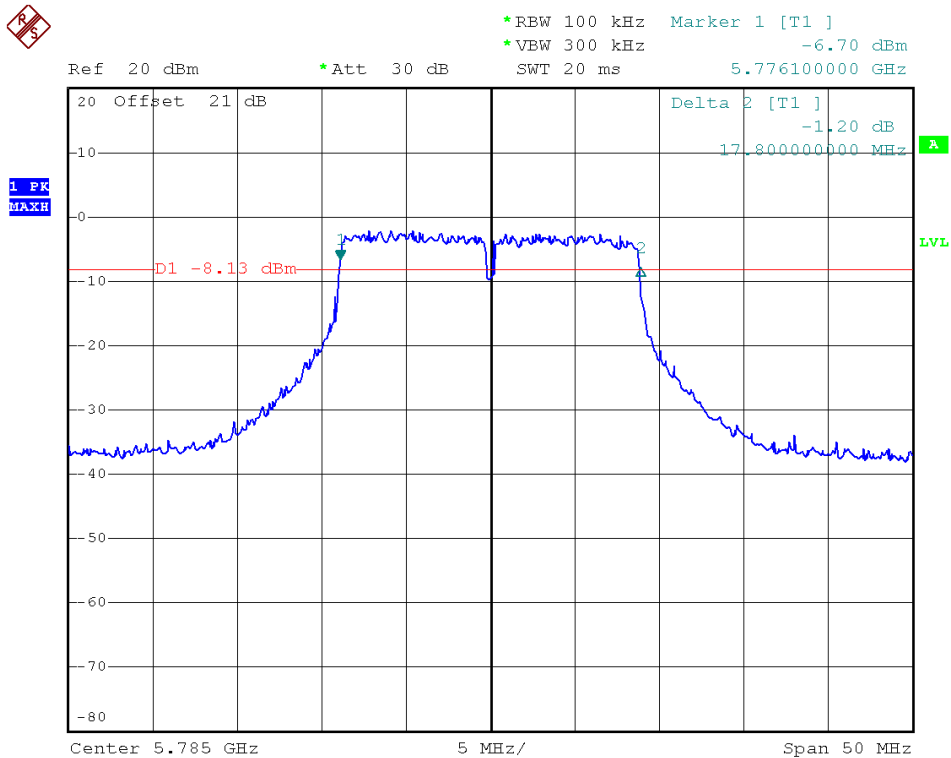

Modulation Standard: 802.11n HT20
Channel: 165 chain 0

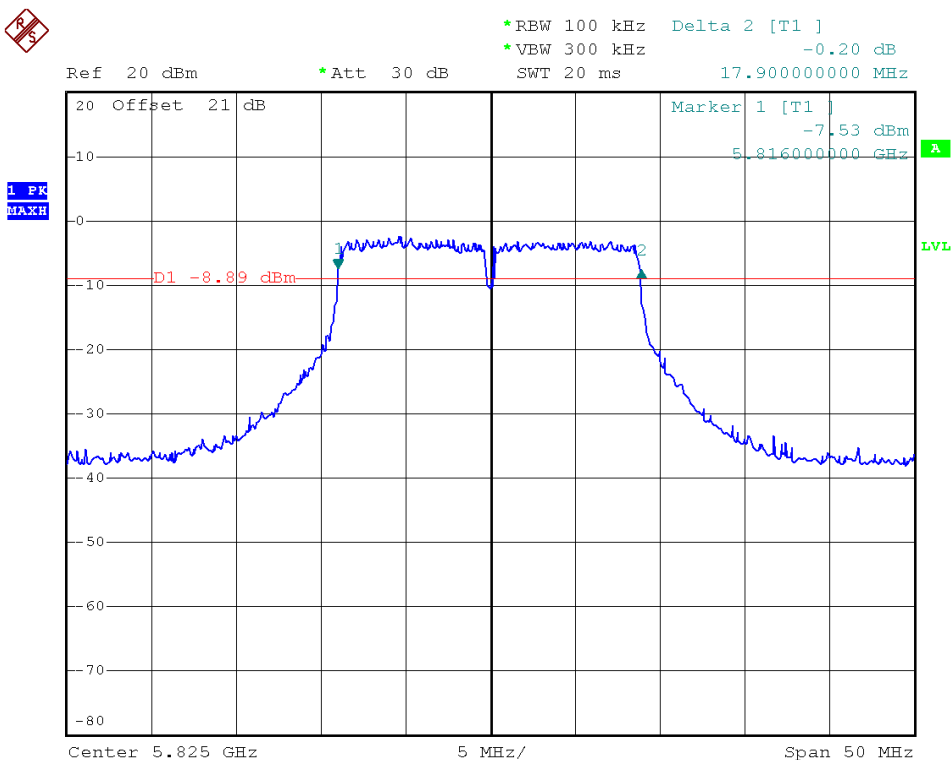



Modulation Standard: 802.11n HT20
Channel: 149 chain 1

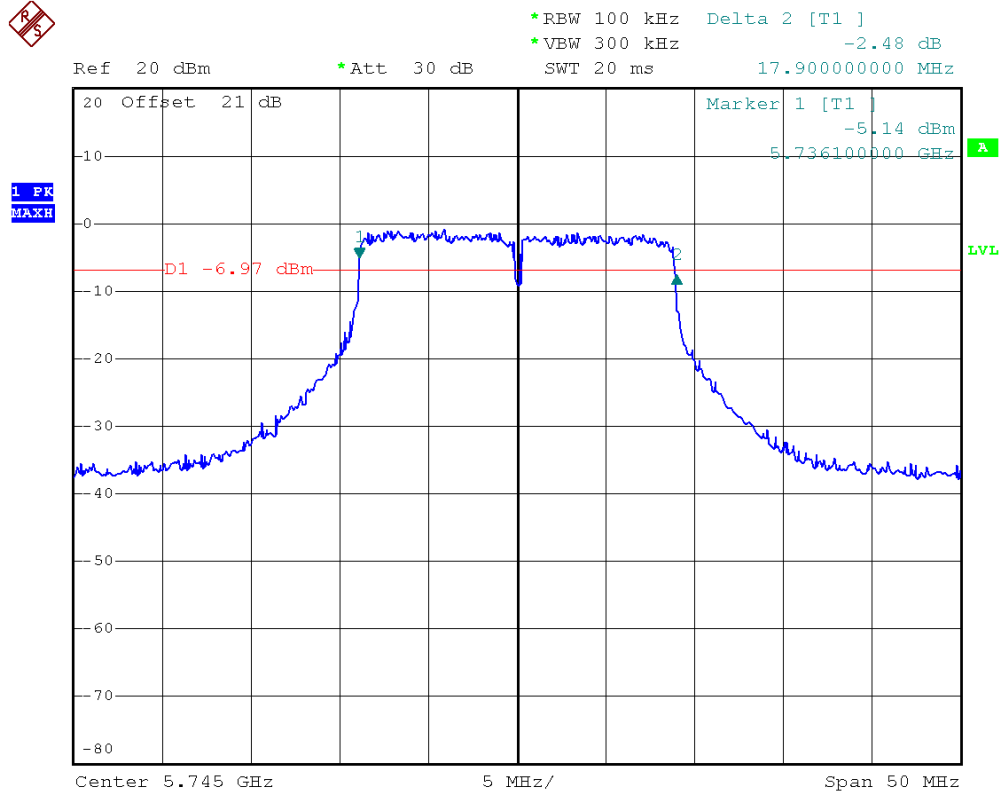

Modulation Standard: 802.11n HT20
Channel: 157 chain 1

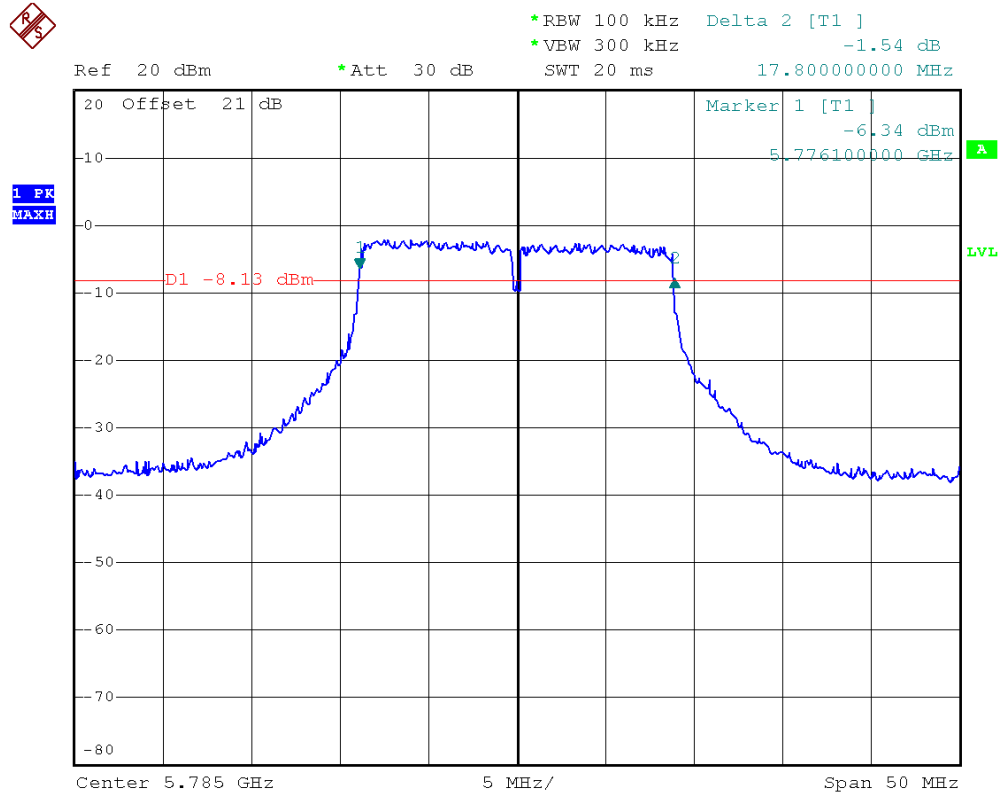



Modulation Standard: 802.11n HT20
Channel: 165 chain 1

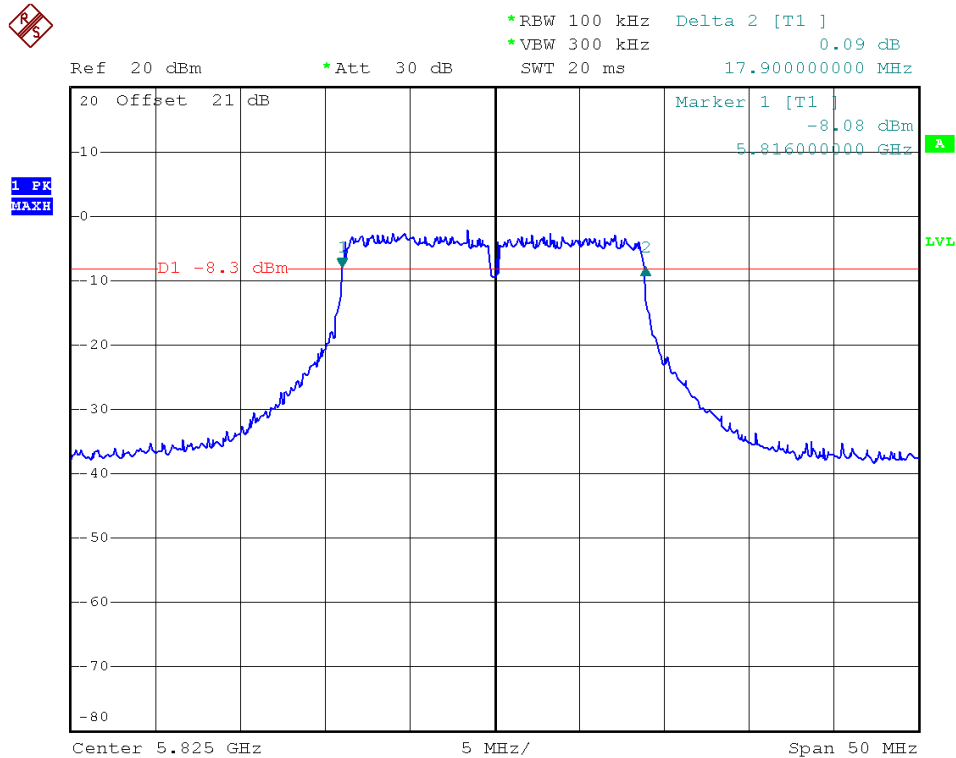

Modulation Standard: 802.11n HT20
Channel: 149 chain 2

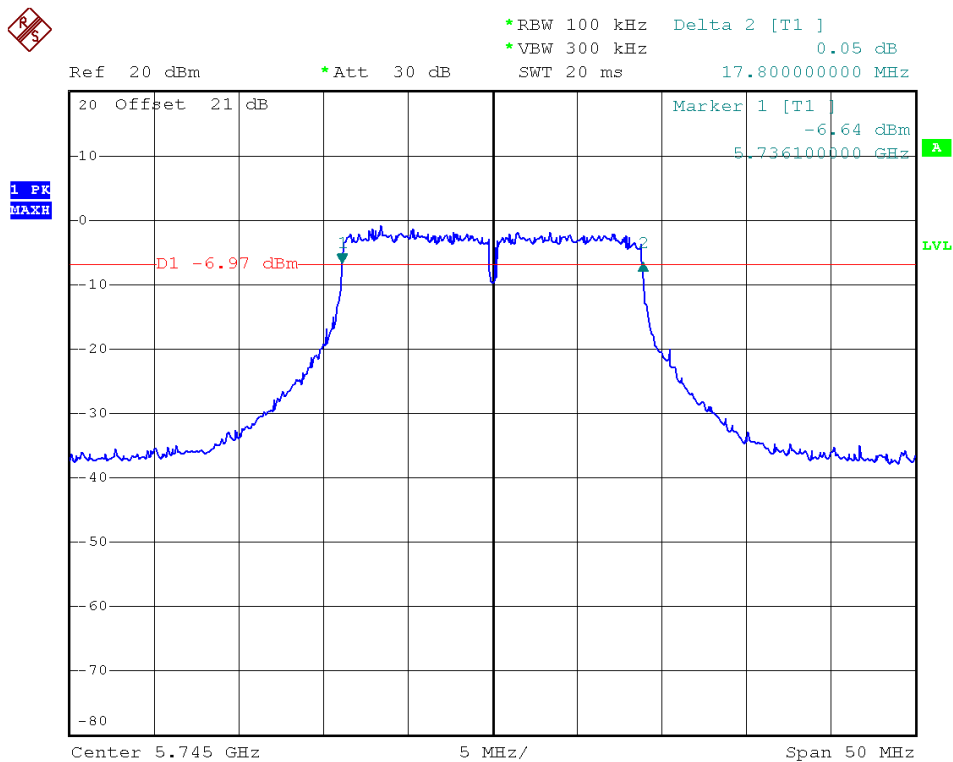



Modulation Standard: 802.11n HT20
Channel: 157 chain 2

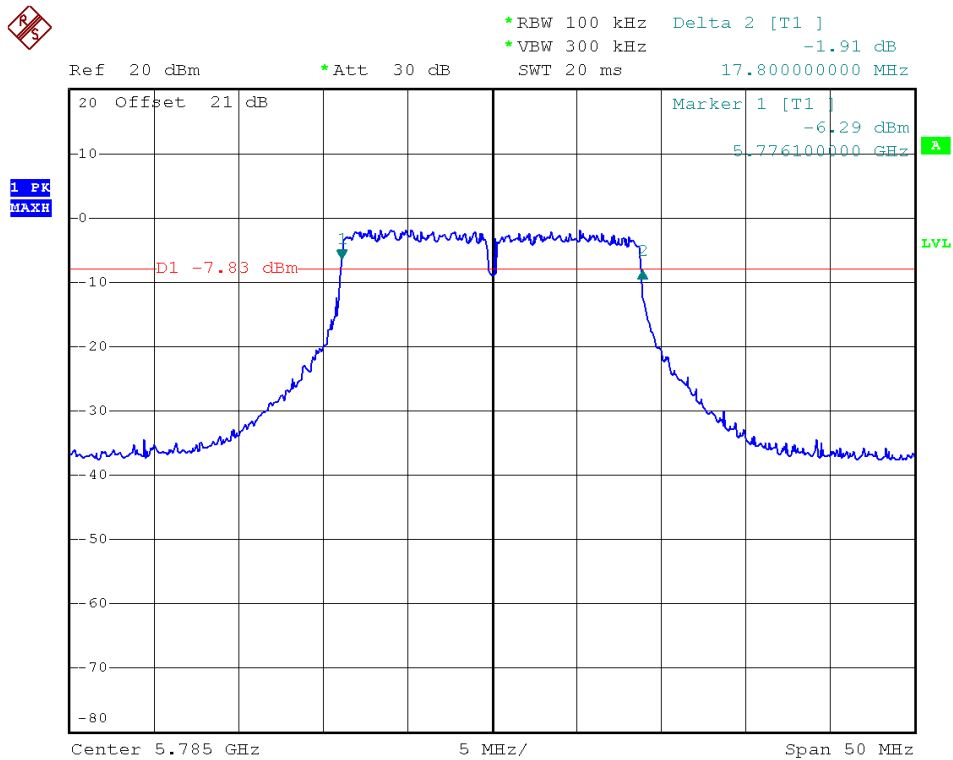

Modulation Standard: 802.11n HT20
Channel: 165 chain 2

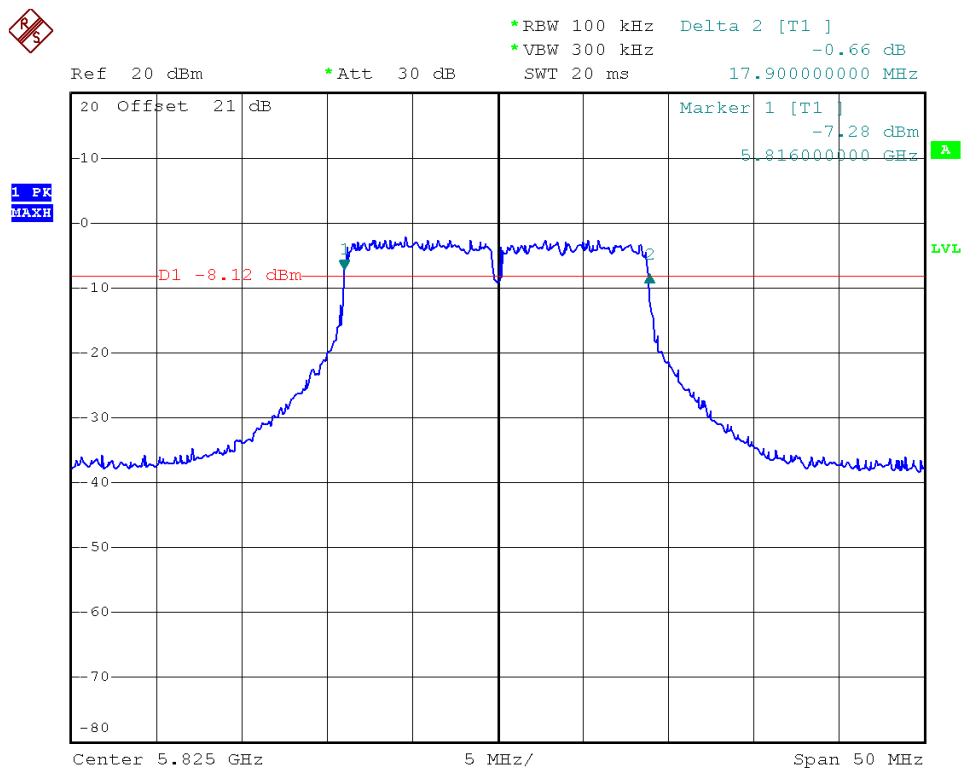



Modulation Standard: 802.11n HT40
Channel: 151 chain 0

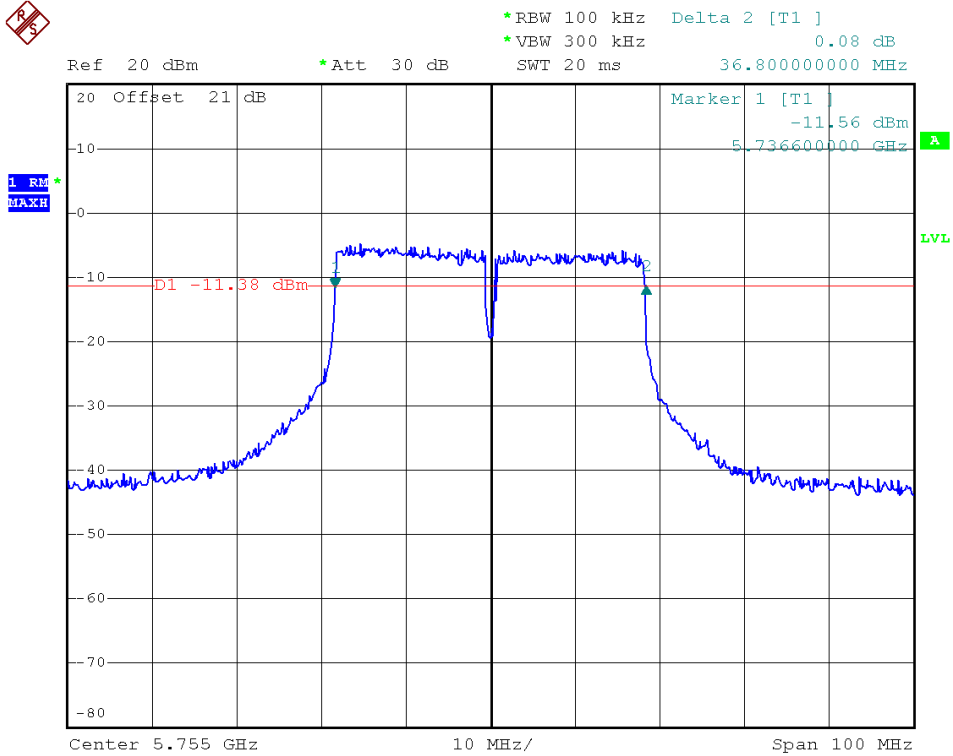

Modulation Standard: 802.11n HT40
Channel: 159 chain 0

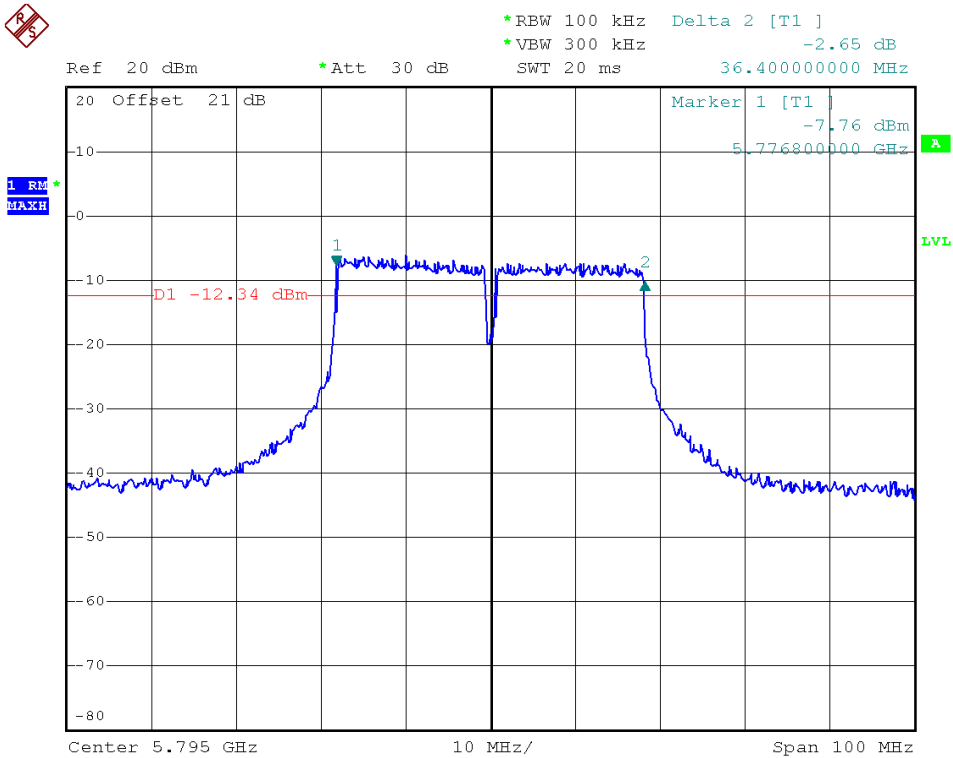



Modulation Standard: 802.11n HT40

Channel: 151 chain 1

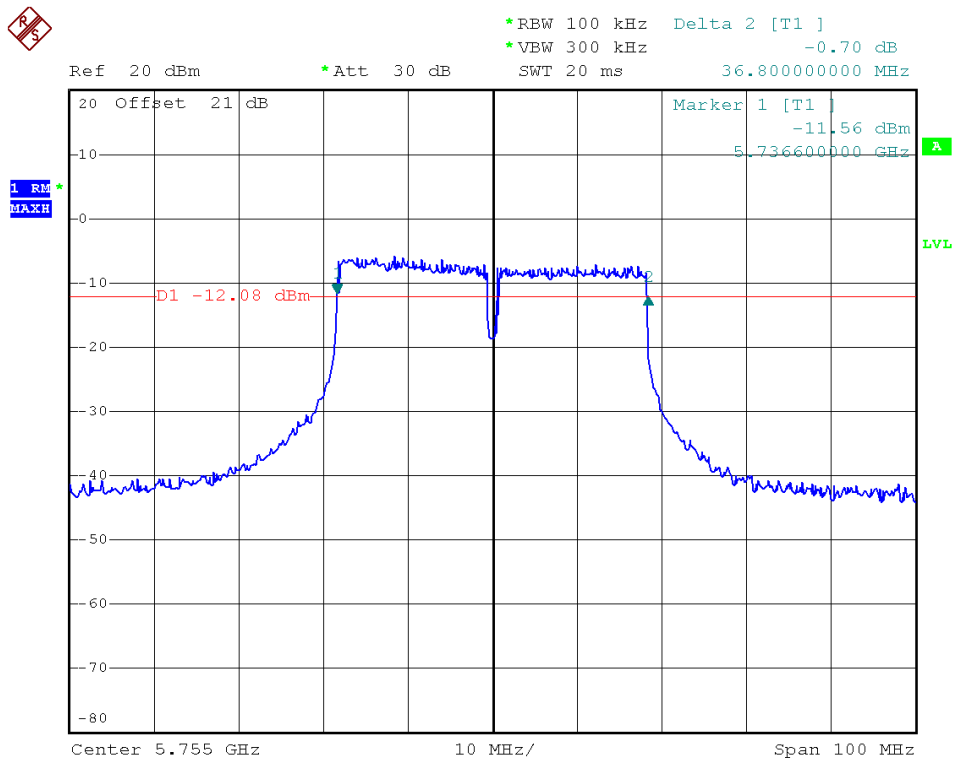

Modulation Standard: 802.11n HT40

Channel: 159 chain 1

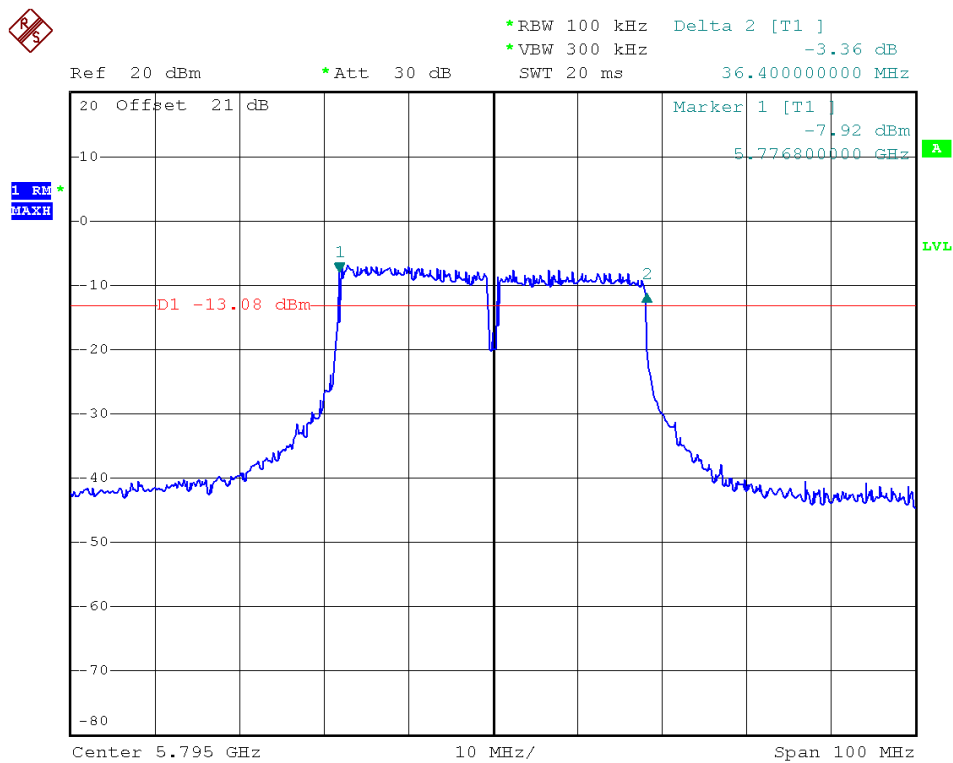



Modulation Standard: 802.11n HT40

Channel: 151 chain 2

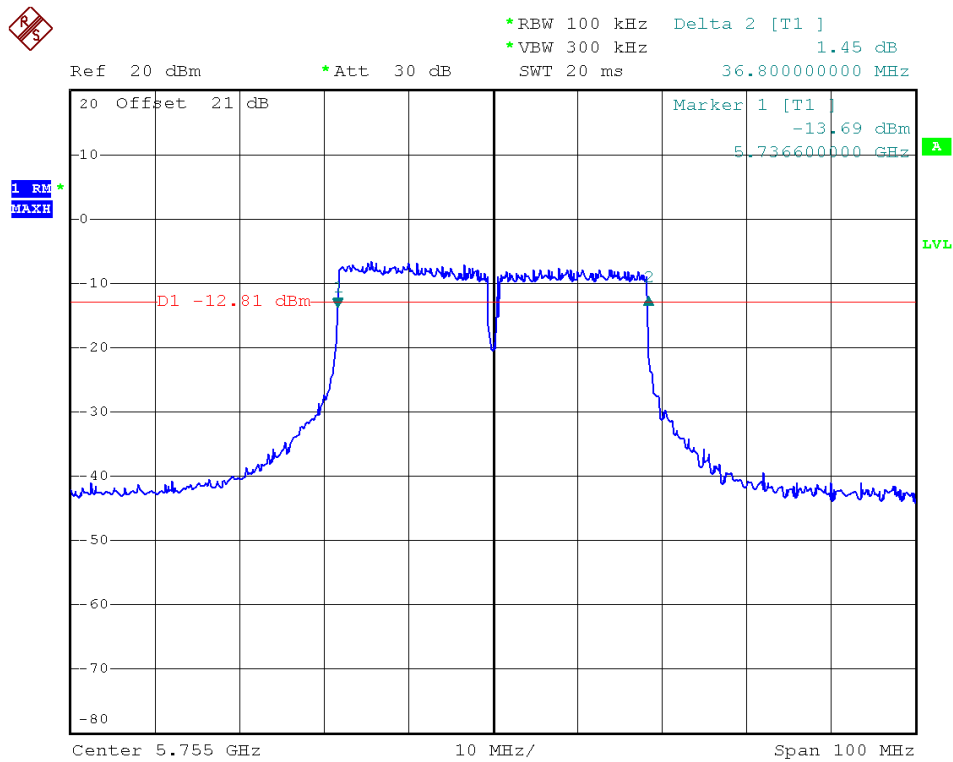

Modulation Standard: 802.11n HT40

Channel: 159 chain 2

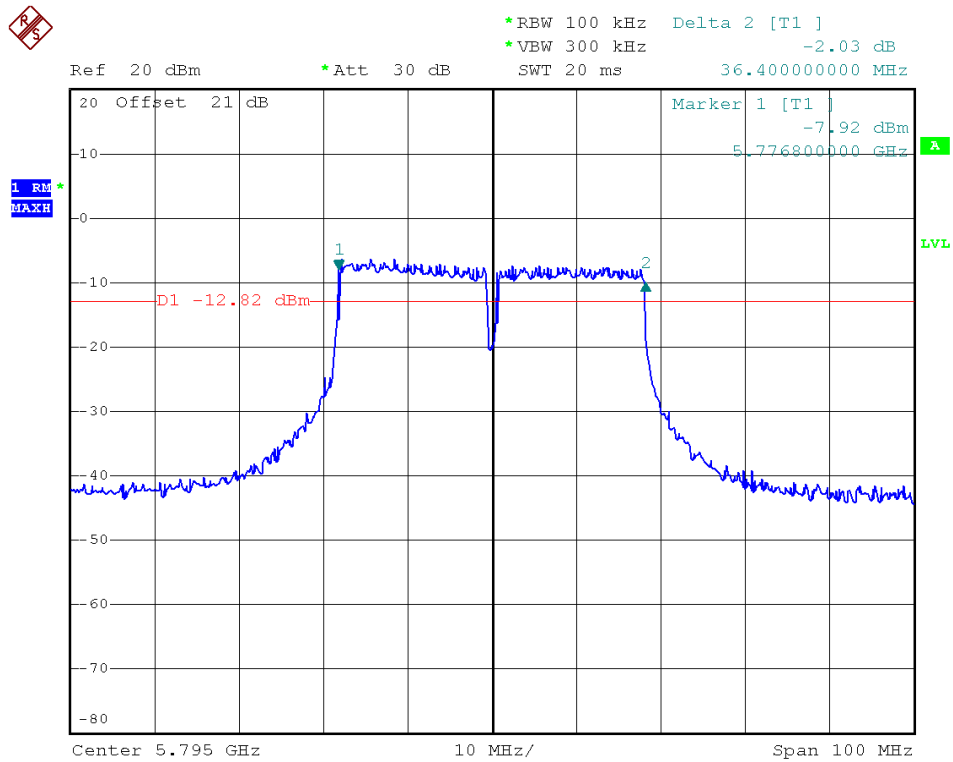



7. Maximum Peak Output Power

7.1 Test Limit

The Maximum Peak Output Power Measurement is 30dBm.

7.2 Test Procedures

The antenna port (RF output) of the EUT was connected to the input (RF input) of a power meter. Power was read directly from the meter and cable loss connection was added to the reading to obtain power at the EUT antenna terminal. The EUT Output Power was set to maximum to produce the worse case test result.

7.3 Test Setup Layout

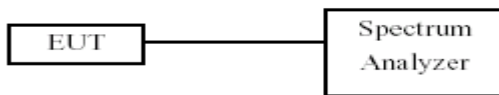

7.4 Measurement equipment

Instrument/Ancillary	Model No.	Manufacturer	Serial No.	Calibration Date	Valid Date
Spectrum Analyzer	FSP40	R&S	100324	2013.03.10	2014.03.09

7.5 Test Result and Data

Test Date: Apr 08,2013

Atmospheric pressure: 1020 hPa

Modulation Standard	Channel	Frequency (MHz)	Peak Power Output (dBm)			
			Peak			
			Chain0	Chain1	Chain2	Chain 0+Chain 1+Chain 2*
802.11a	149	5745	16.76	---	---	---
	157	5785	16.13	---	---	---
	165	5825	15.80	---	---	---
802.11n HT20	149	5745	7.41	7.32	7.32	12.12
	157	5785	7.30	7.22	7.25	12.03
	165	5825	7.23	7.52	7.48	12.18
802.11n HT40	151	5755	7.39	7.20	7.14	12.02
	159	5795	7.43	7.36	7.43	12.18

Note: Peak Power Output(Chain 0+Chain 1+Chain 2) =

$$10 * \text{LOG}_{10}(10^{(\text{Chain 0}/10)} + 10^{(\text{Chain 1}/10)} + 10^{(\text{Chain 1}/10)})$$

$$\text{Required Limit}(\text{Chain 0}|\text{Chain 1}|\text{Chain 2}) = 30 - (10 - 6) = 26.00$$

$$\text{Required Limit}(\text{Chain 0} + \text{Chain 1} + \text{Chain 2}) = 30 - (9.77 - 6) = 26.23$$



Modulation Standard: 802.11a
Channel: 149

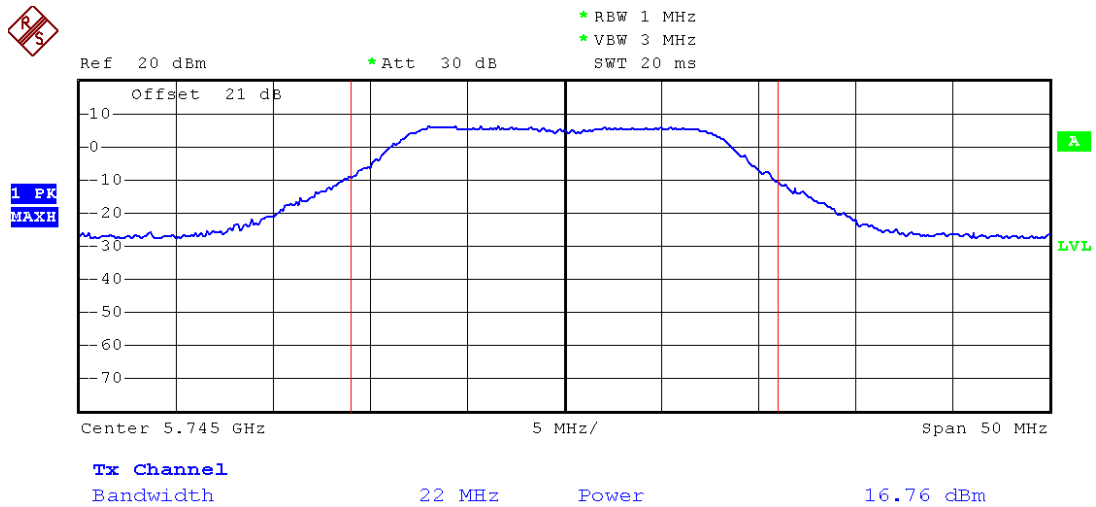

Modulation Standard: 802.11a
Channel: 157

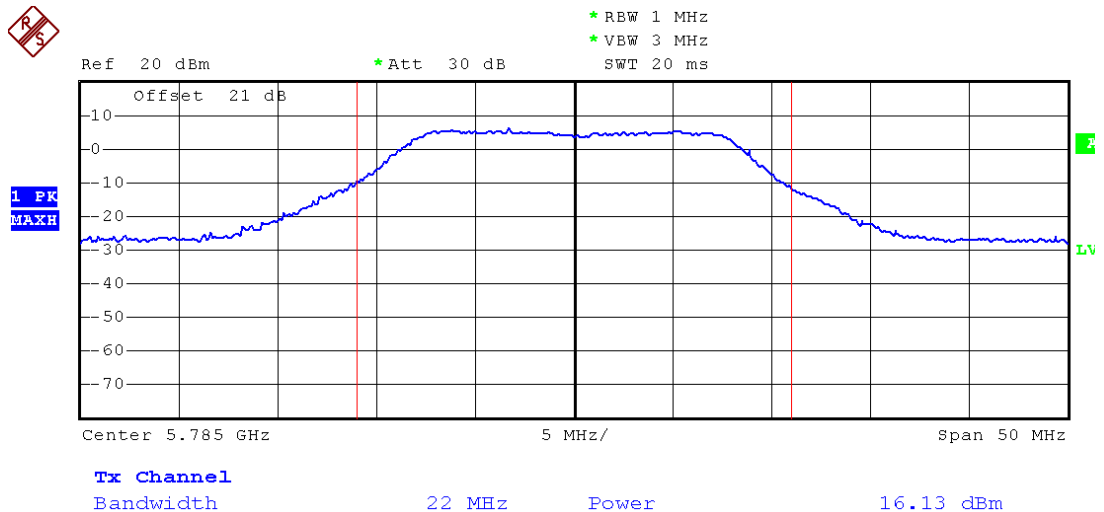



Modulation Standard: 802.11a
Channel: 165

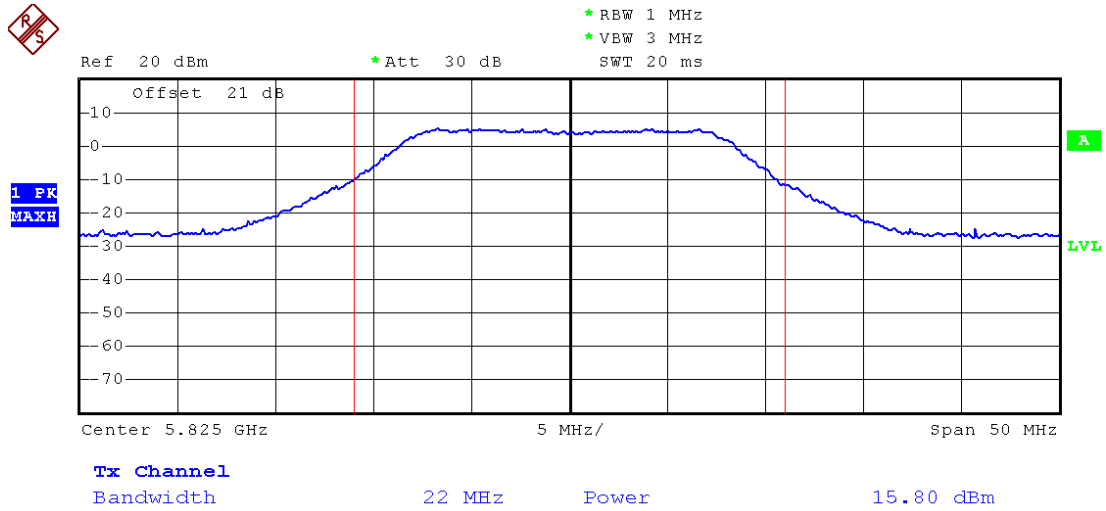

Modulation Standard: 802.11n HT20
Channel: 149 chain 0

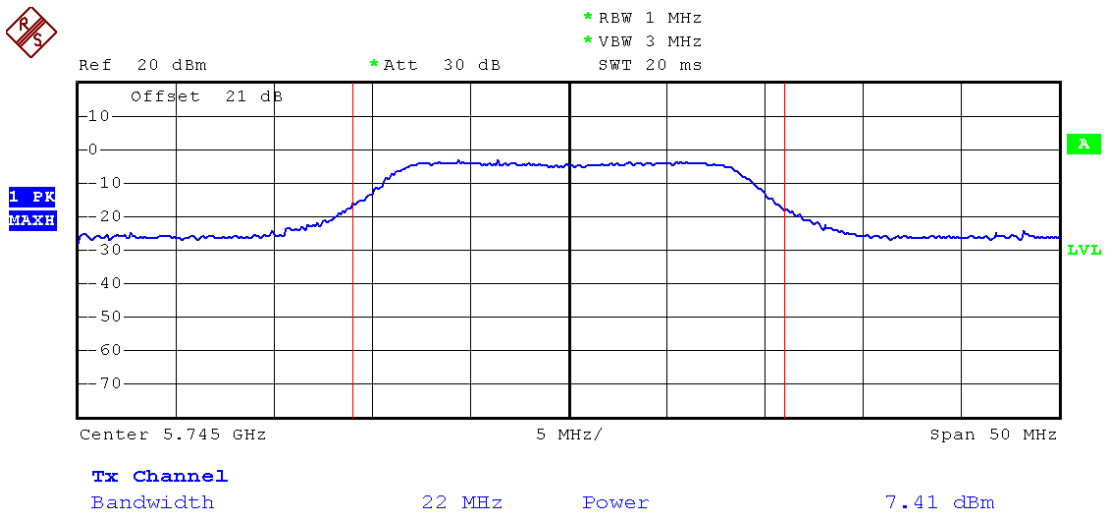



Modulation Standard: 802.11n HT20
Channel: 157 chain 0

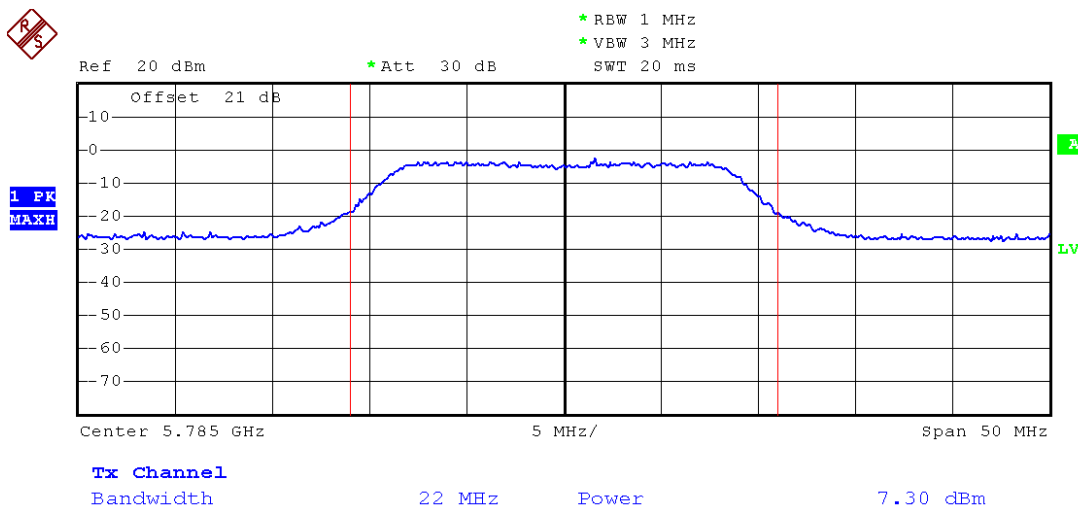

Modulation Standard: 802.11n HT20
Channel: 165 chain 0

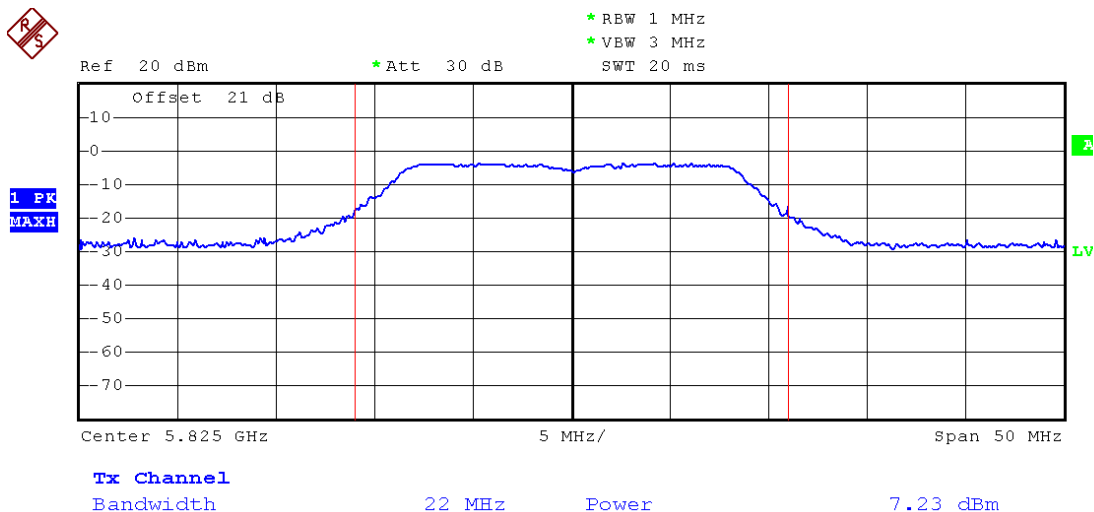



Modulation Standard: 802.11n HT20
Channel: 149 chain 1

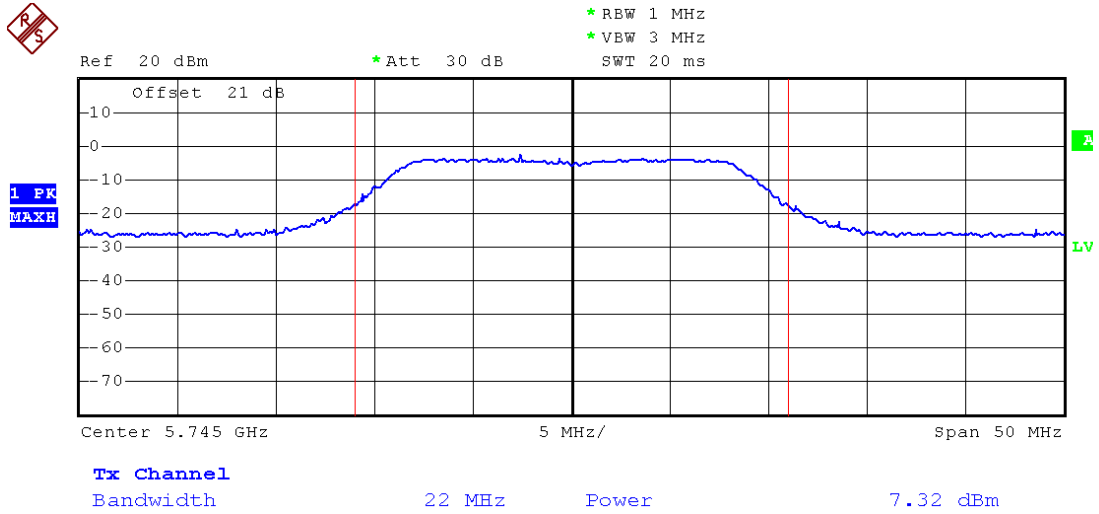

Modulation Standard: 802.11n HT20
Channel: 157 chain 1

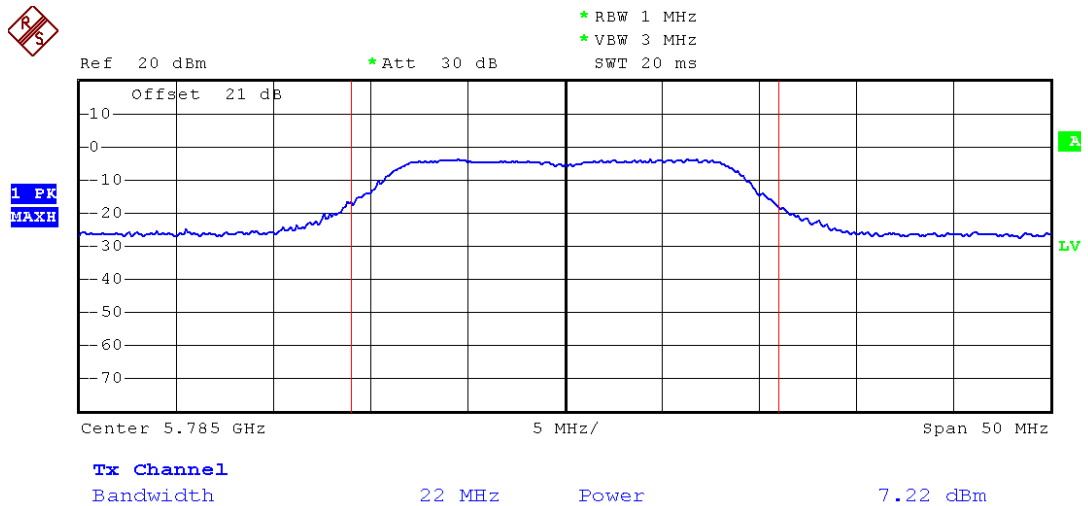



Modulation Standard: 802.11n HT20
Channel: 165 chain 1

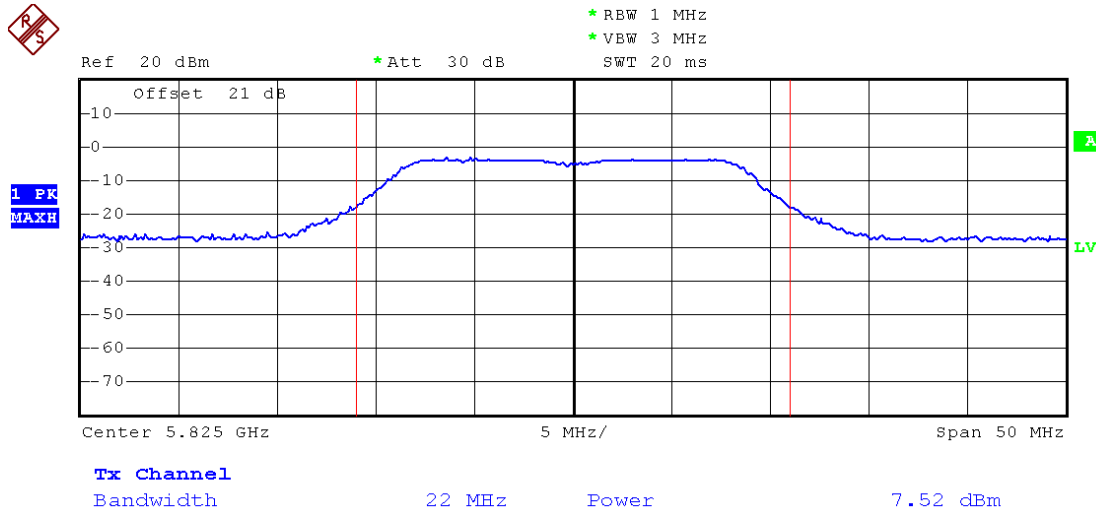

Modulation Standard: 802.11n HT20
Channel: 149 chain 2

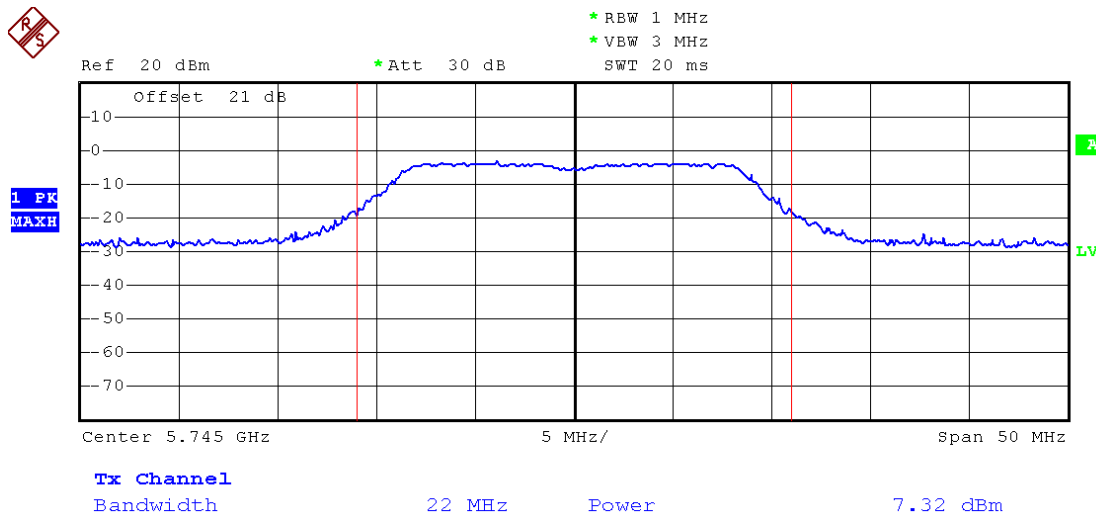



Modulation Standard: 802.11n HT20
Channel: 157 chain 2

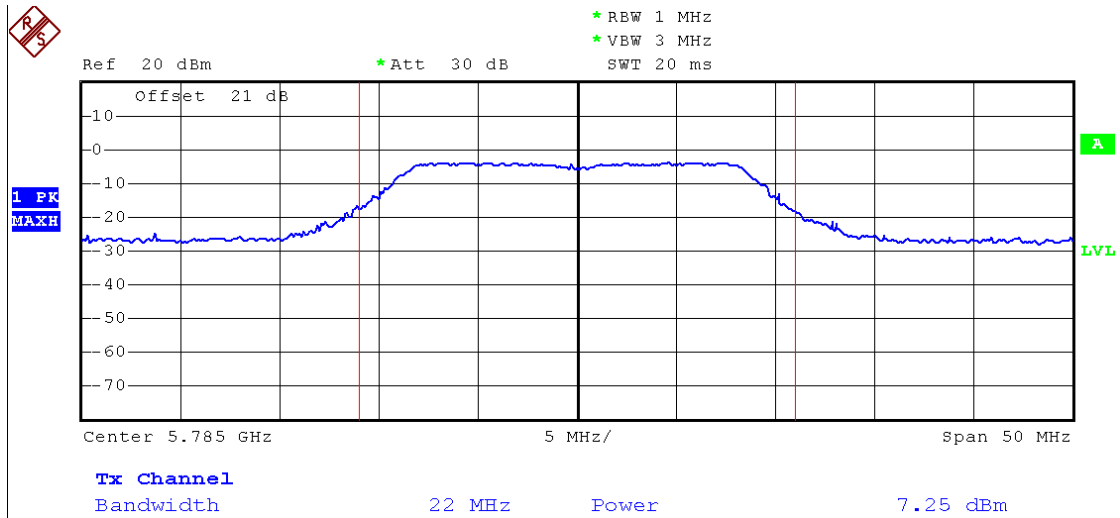

Modulation Standard: 802.11n HT20
Channel: 165 chain 2

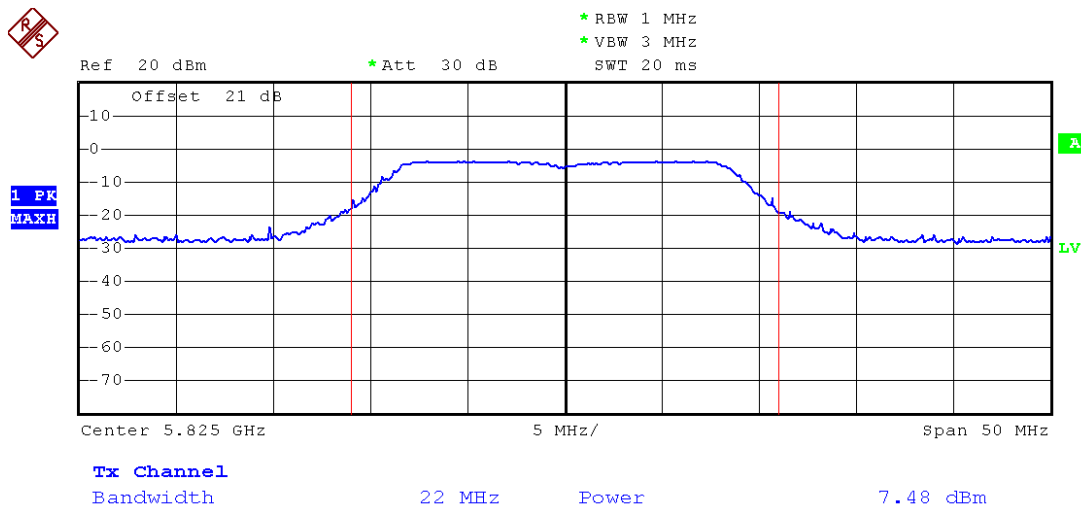



Modulation Standard: 802.11n HT40
Channel: 151 chain 0

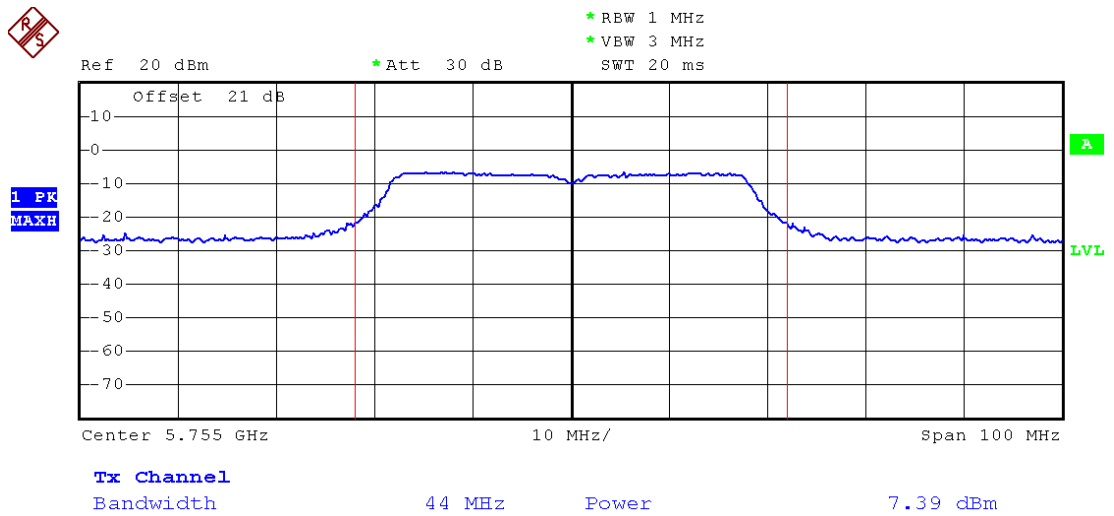

Modulation Standard: 802.11n HT40
Channel: 159 chain 0

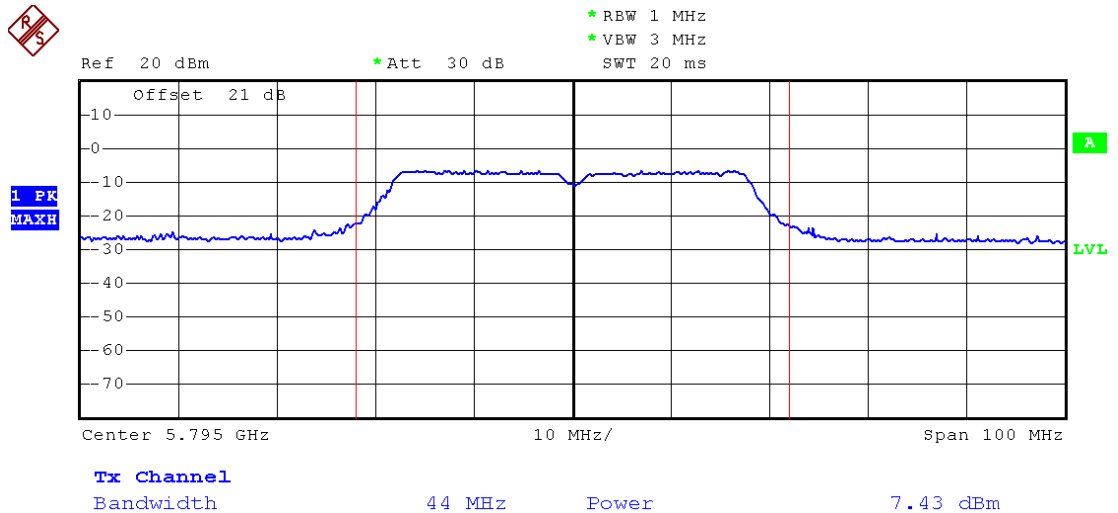



Modulation Standard: 802.11n HT40
Channel: 151 chain 1

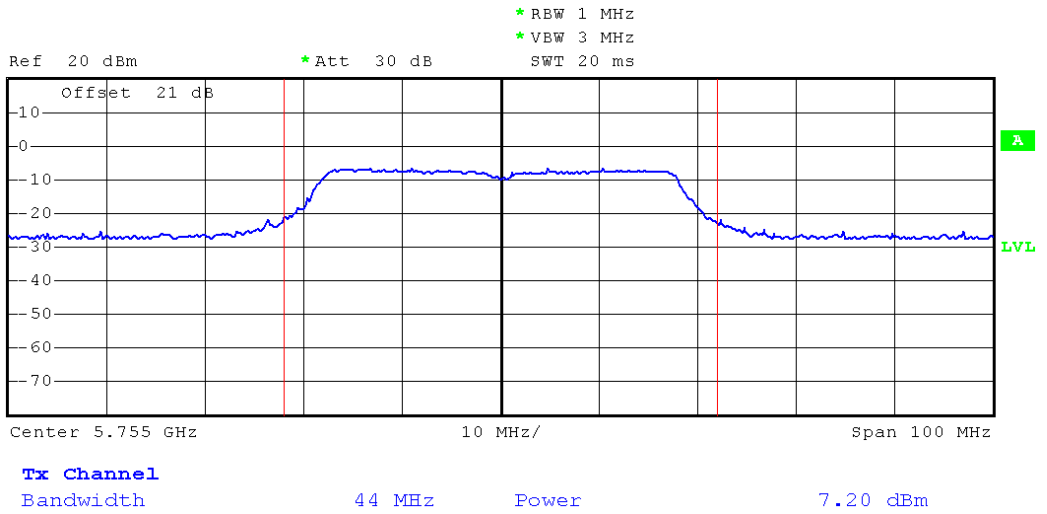

Modulation Standard: 802.11n HT40
Channel: 159 chain 1

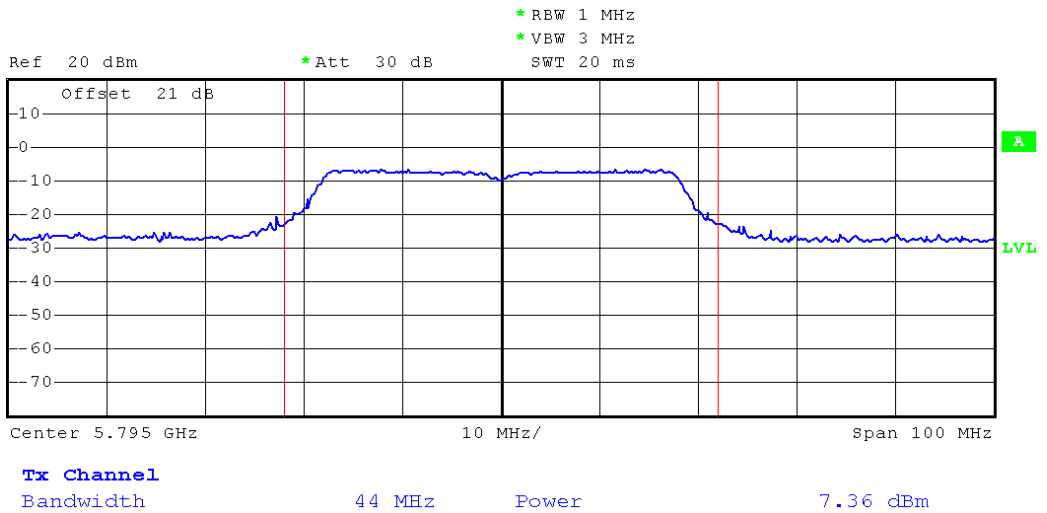



Modulation Standard: 802.11n HT40
Channel: 151 chain 2

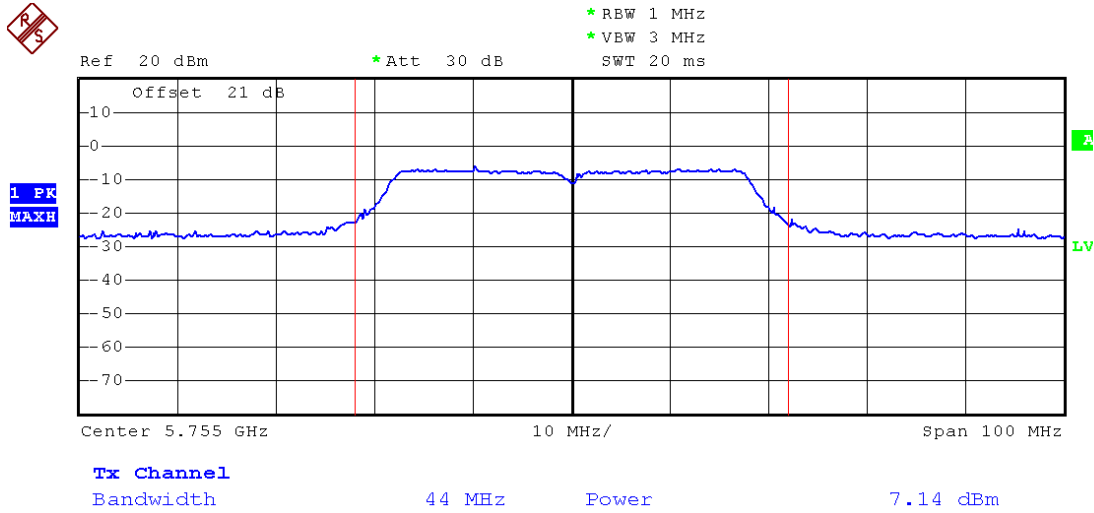

Modulation Standard: 802.11n HT40
Channel: 159 chain 2

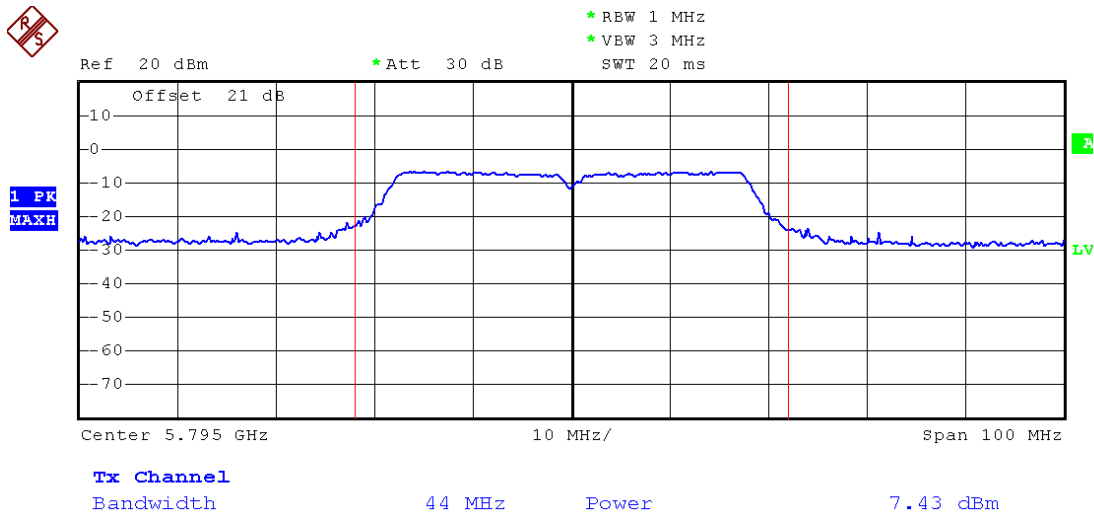



8. Power Spectral Density

8.1 Test Limit

The Maximum of Power Spectral Density Measurement is 8dBm.

8.2 Test Procedures

- The transmitter output was connected to spectrum analyzer.
- The spectrum analyzer's resolution bandwidth were set at 3KHz RBW and 30KHz VBW as that of the fundamental frequency. Set the sweep time=span/3KHz.
- The power spectral density was measured and recorded.
- Set the analyzer span to at least 1.5 times the DTS channel bandwidth.

8.3 Test Setup Layout

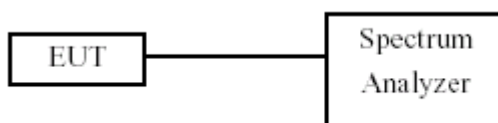

8.4 Measurement equipment

Instrument/Ancillary	Model No.	Manufacturer	Serial No.	Calibration Date	Valid Date
Spectrum Analyzer	FSP40	R&S	100324	2013.03.10	2014.03.09

8.5 Test Result and Data

Test Date: Apr 08, 2013

Temperature: 25 °C

Atmospheric pressure: 1020 hPa

Humidity: 46 %

Modulation Standard	Channel	Frequency (MHz)	Maximum Power Density of 3 kHz Bandwidth (dBm)			
			Chain 0	Chain 1	Chain 2	Chain 0+Chain 1+Chain 2
802.11a	149	5745	-10.20			
	157	5785	-11.52			
	165	5825	-12.56			
802.11n HT20	149	5745	-15.09	-15.36	-15.93	-10.67
	157	5785	-15.00	-15.57	-15.34	-10.53
	165	5825	-16.66	-15.54	-15.86	-11.22
802.11n HT40	151	5755	-15.72	-15.90	-16.26	-11.18
	159	5795	-15.62	-15.97	-15.83	-11.03

Note: Power Density (Chain 0+Chain 1+Chain 2) =

$$10 * \text{LOG}_{10}(10^{(\text{Chain 0}/10)} + 10^{(\text{Chain 1}/10)} + 10^{(\text{Chain 2}/10)})$$

$$\text{Required Limit}(\text{Chain 0}|\text{Chain 1}|\text{Chain 2}) = 8 - (10 - 6) = 4.00$$

$$\text{Required Limit}(\text{Chain 0} + \text{Chain 1} + \text{Chain 2}) = 8 - (9.77 - 6) = 4.23$$



Modulation Standard: 802.11a
Channel: 149

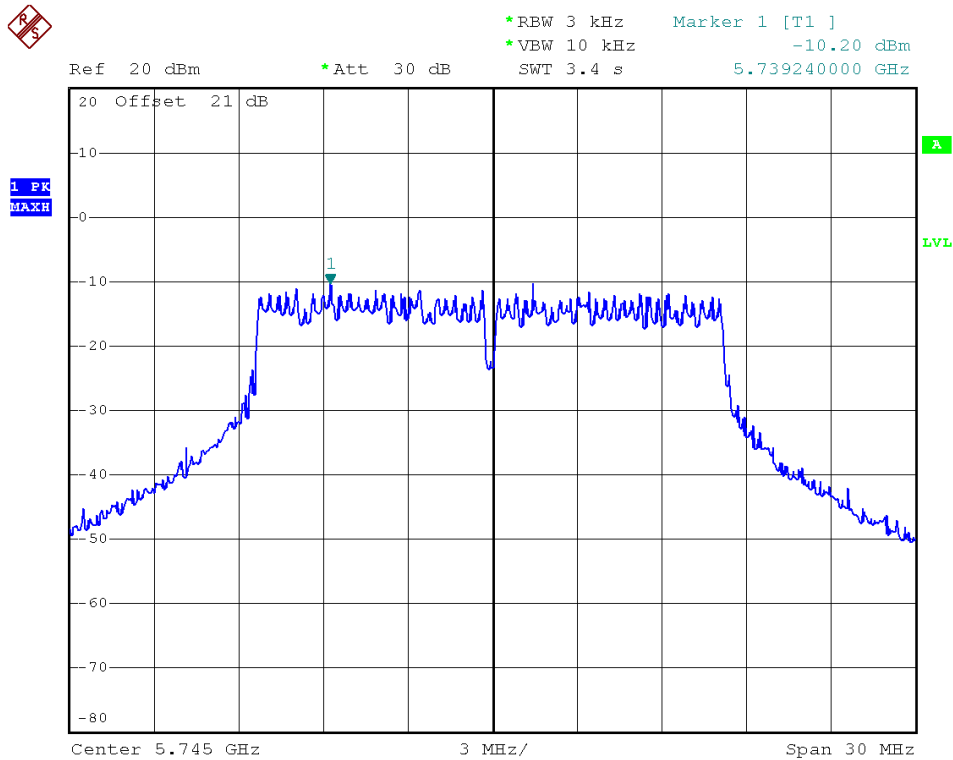

Modulation Standard: 802.11a
Channel: 157

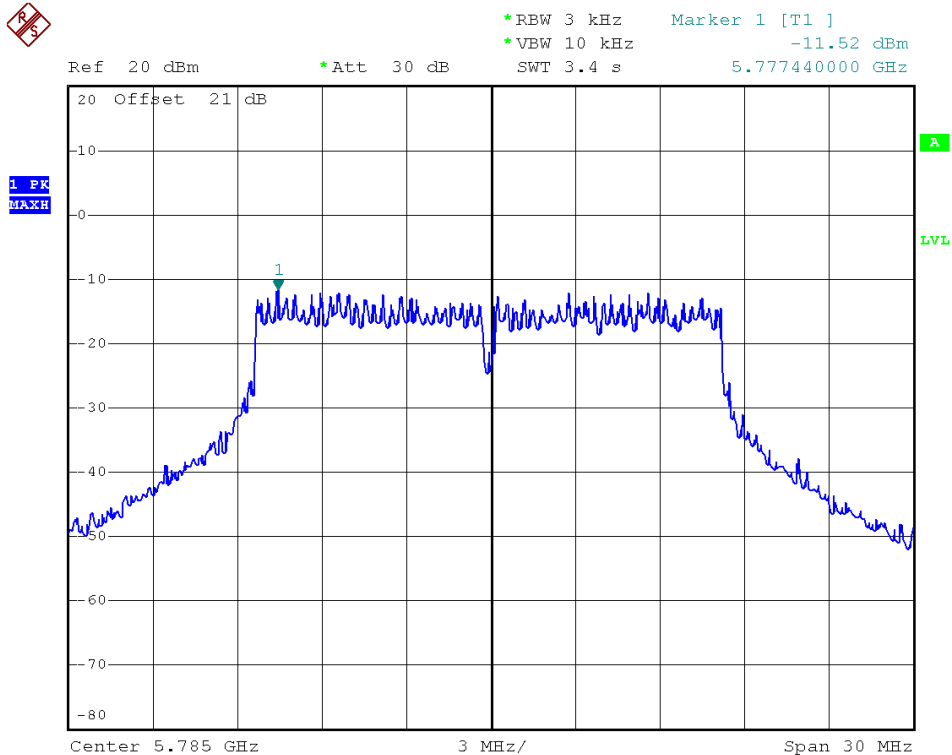



Modulation Standard: 802.11a
Channel: 165

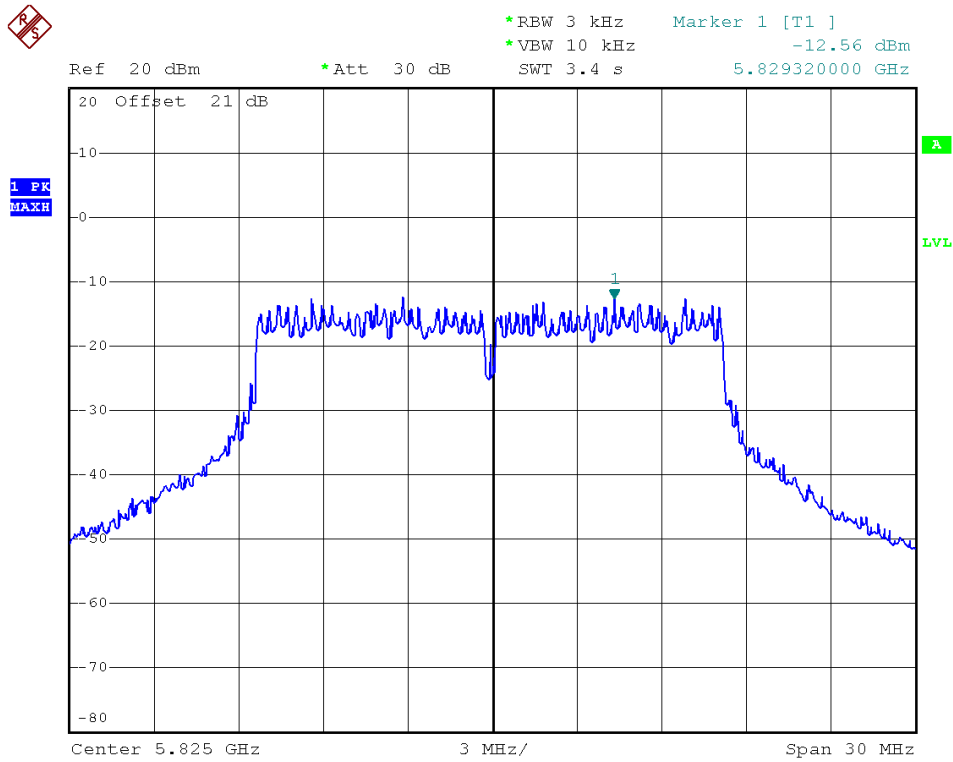

Modulation Standard: 802.11n HT20
Channel: 149 chain0

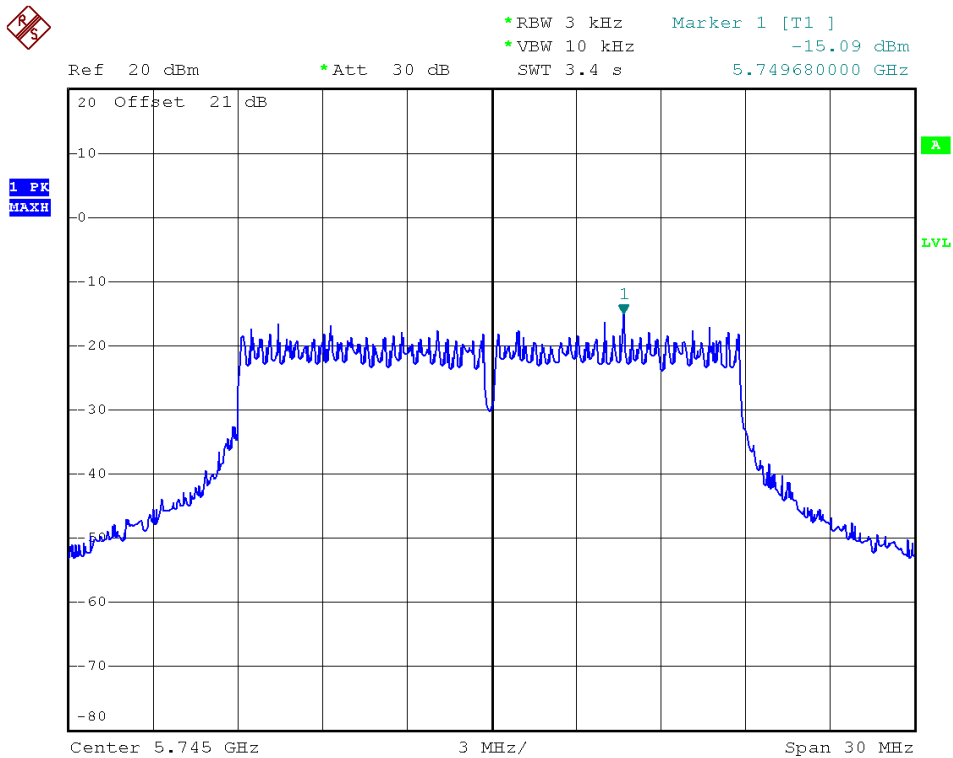



Modulation Standard: 802.11n HT20
Channel: 157 chain0

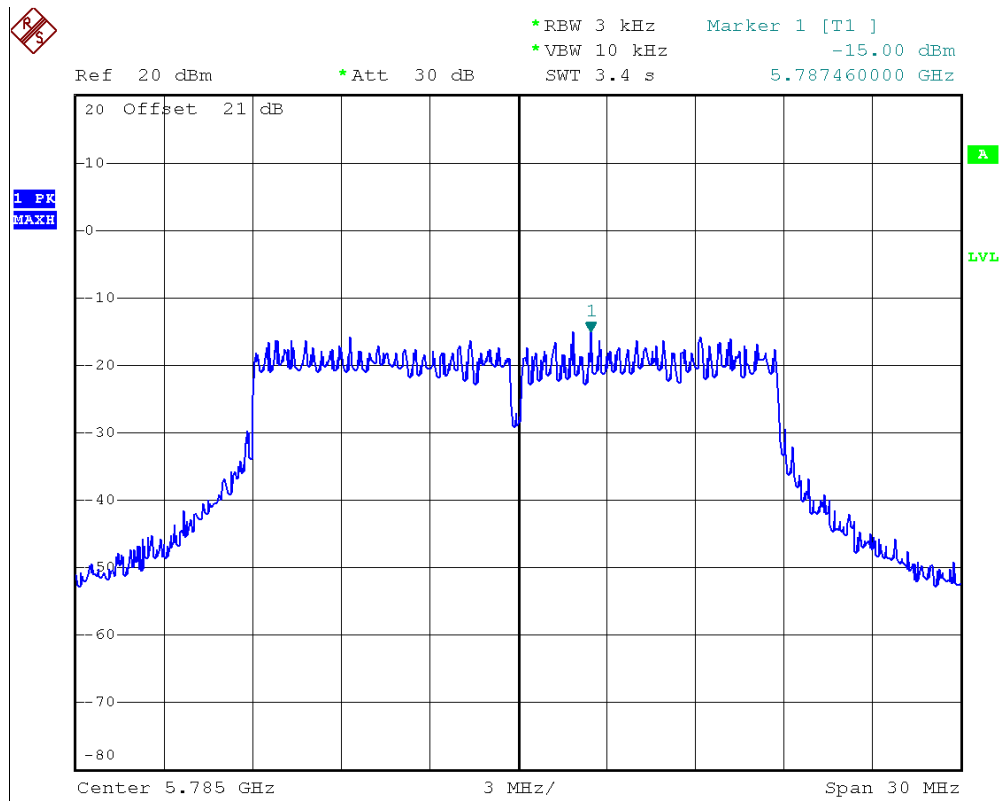

Modulation Standard: 802.11n HT20
Channel: 165 chain0

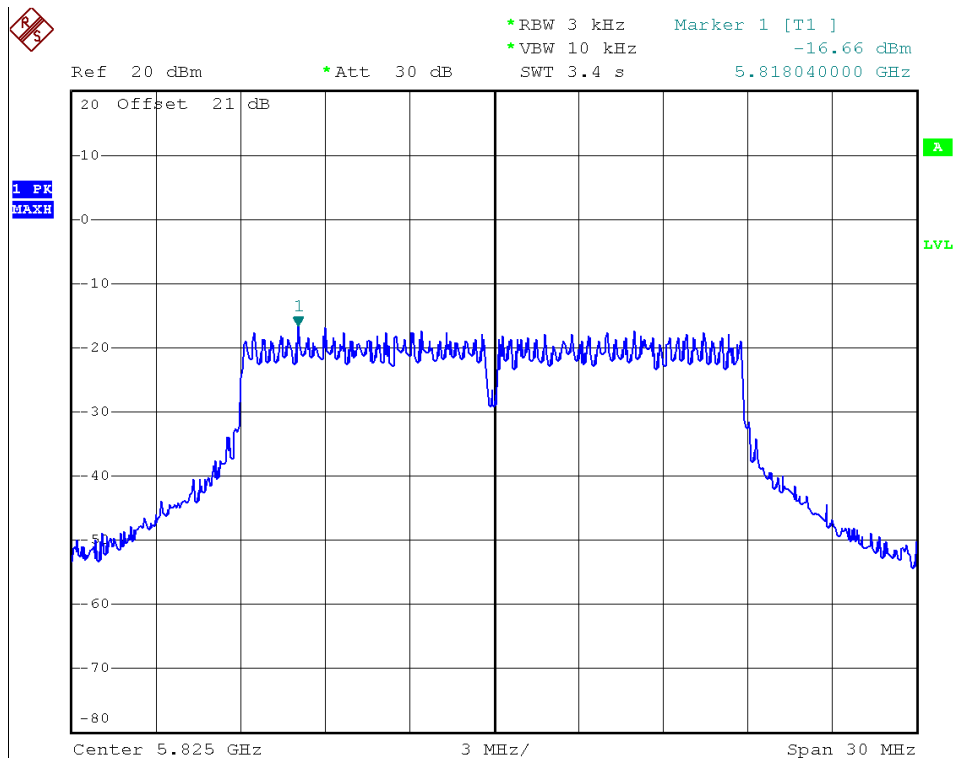



Modulation Standard: 802.11n HT20
Channel: 149 chain 1

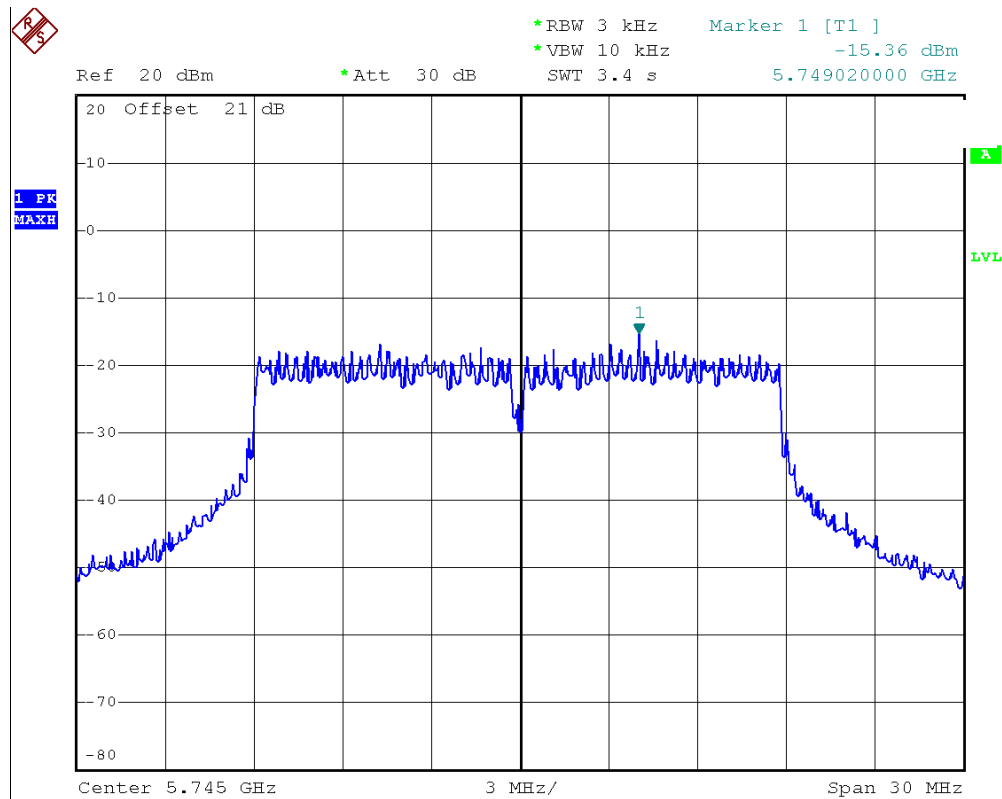

Modulation Standard: 802.11n HT20
Channel: 157 chain 1

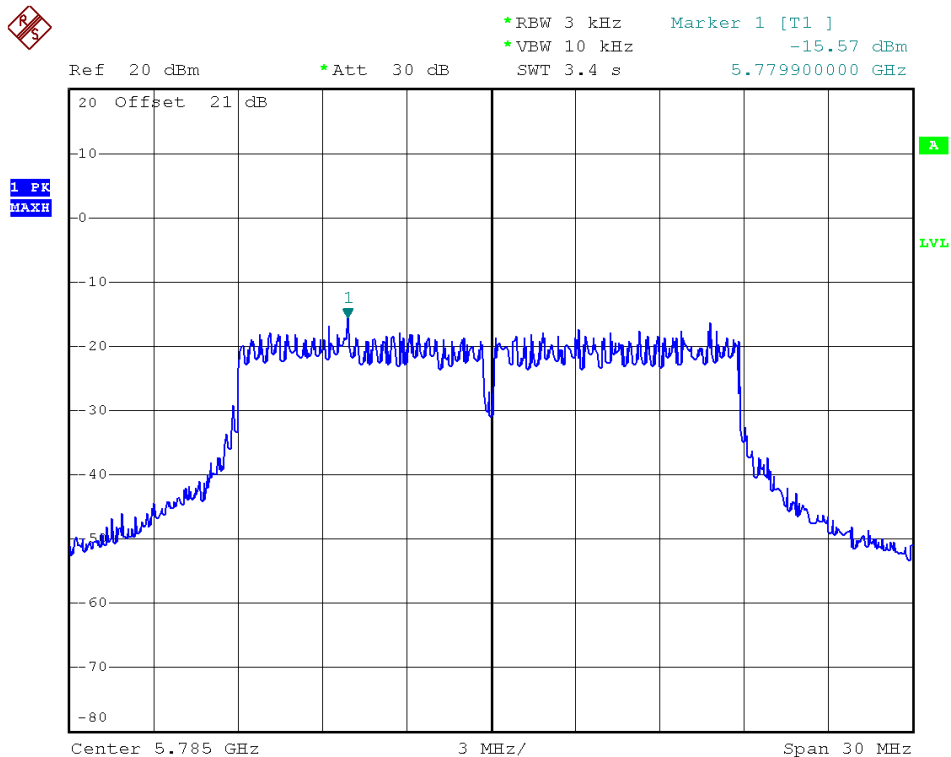



Modulation Standard: 802.11n HT20
Channel: 165 chain 1

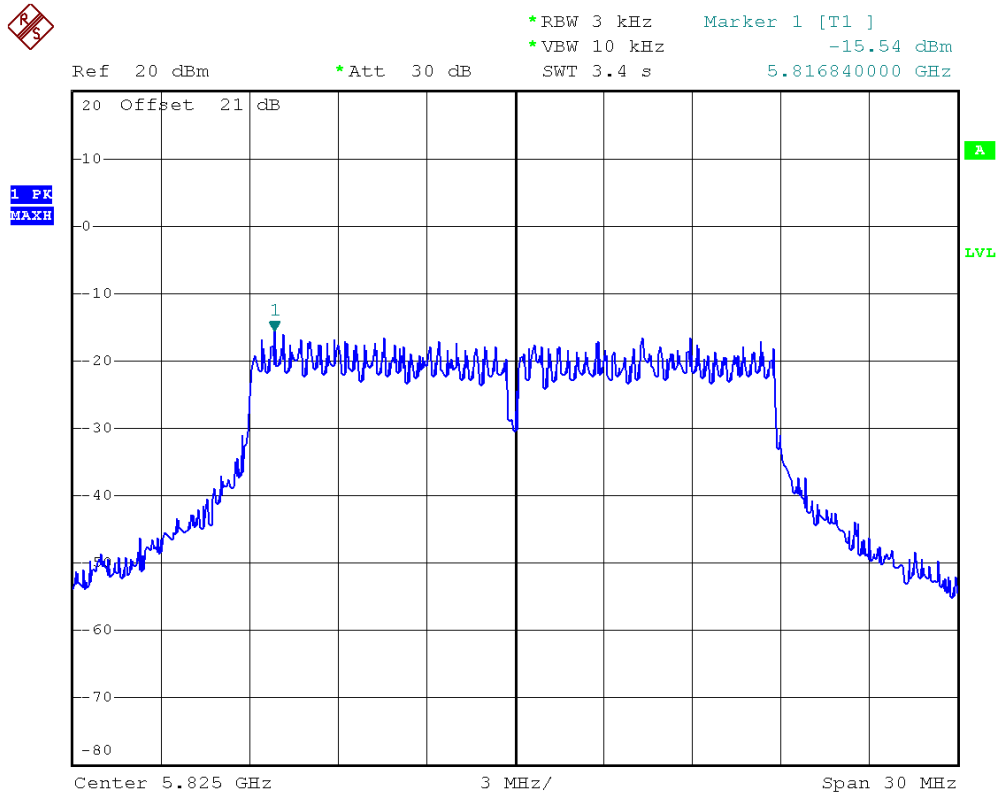

Modulation Standard: 802.11n HT20
Channel: 149 chain 2

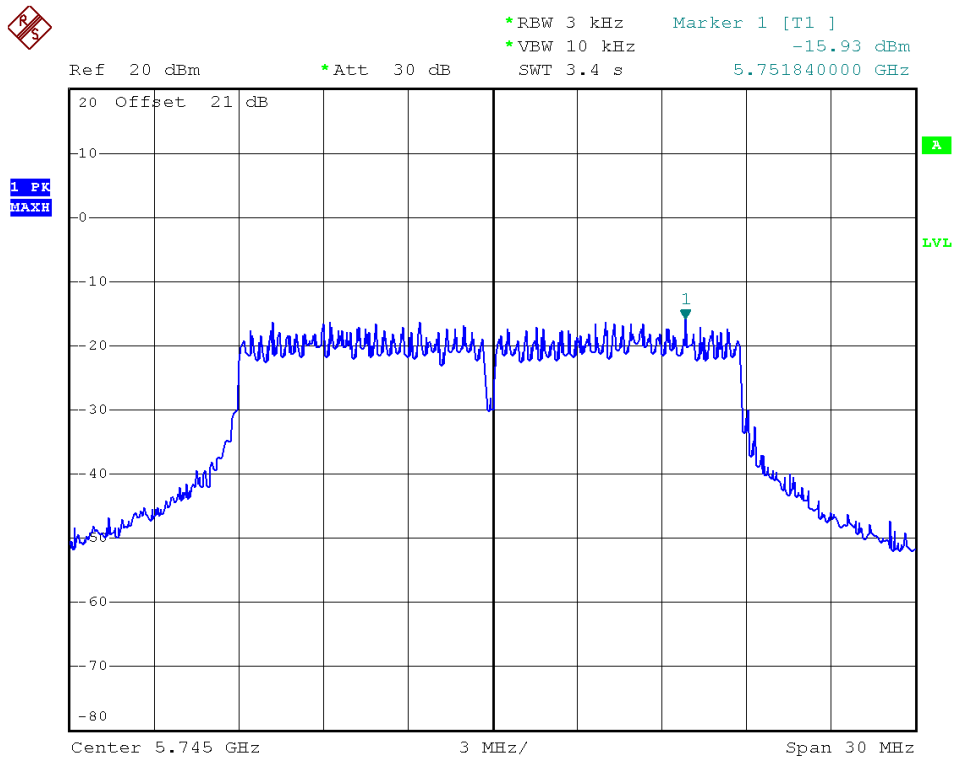



Modulation Standard: 802.11n HT20
Channel: 157 chain 2

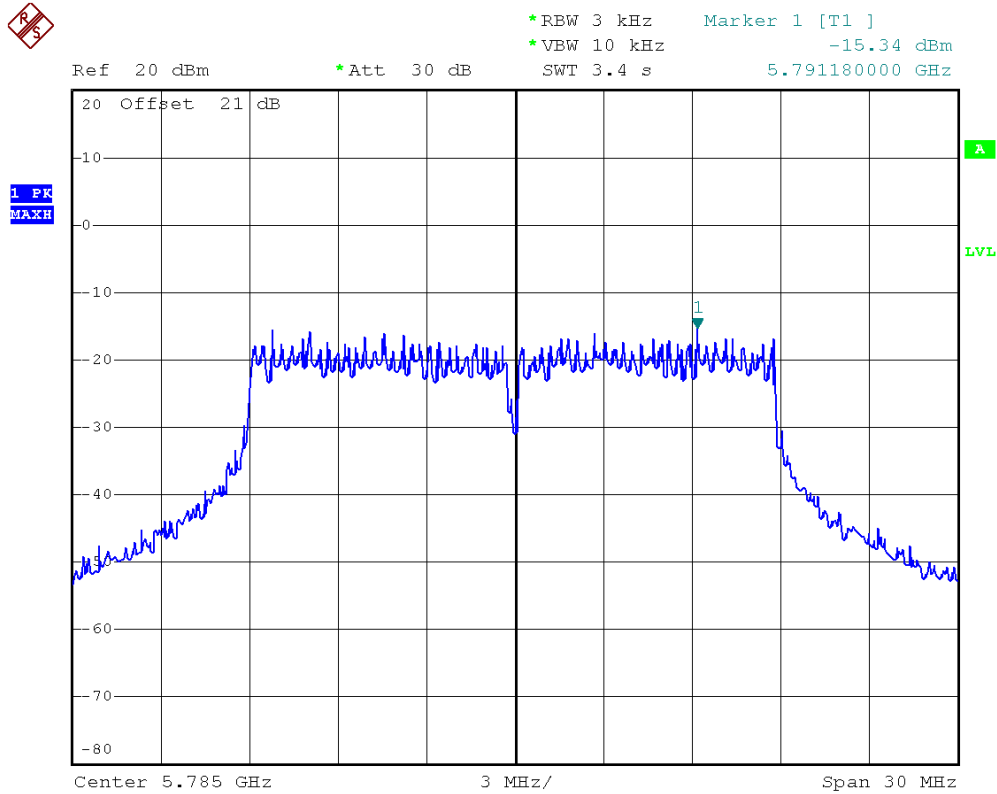

Modulation Standard: 802.11n HT20
Channel: 165 chain 2

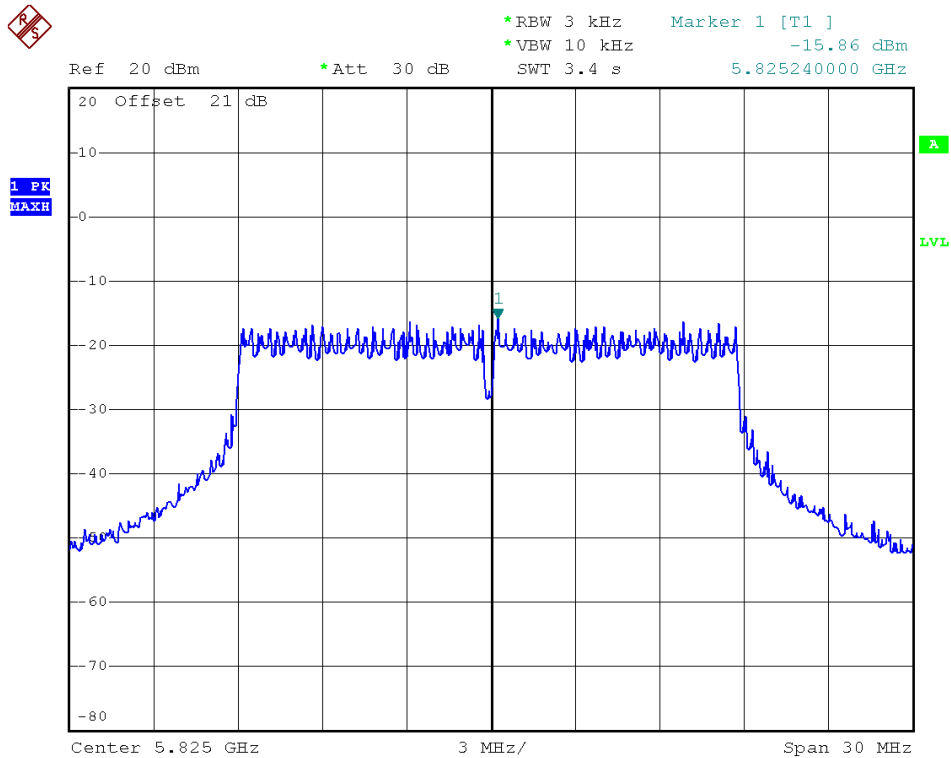



Modulation Standard: 802.11n HT40
Channel: 151 chain 0



Ref 20 dBm *Att 30 dB *RBW 3 kHz Marker 1 [T1] -15.72 dBm
*VBW 10 kHz SWT 6.8 s 5.741200000 GHz

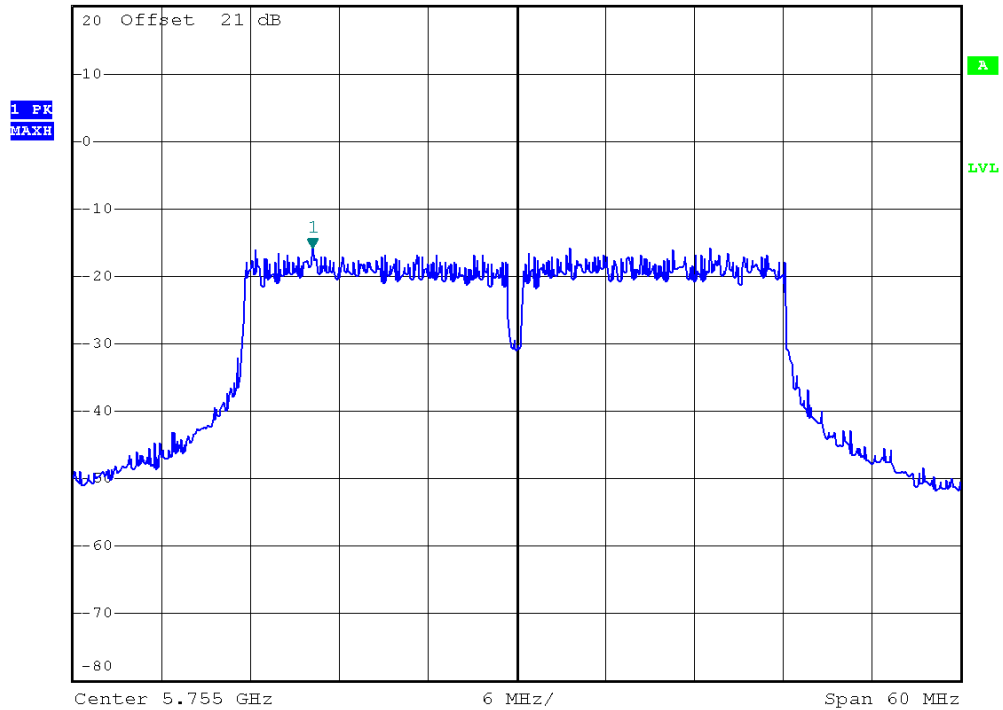

Modulation Standard: 802.11n HT40
Channel: 159 chain 0



Ref 20 dBm *Att 30 dB *RBW 3 kHz Marker 1 [T1] -15.62 dBm
*VBW 10 kHz SWT 6.8 s 5.807480000 GHz

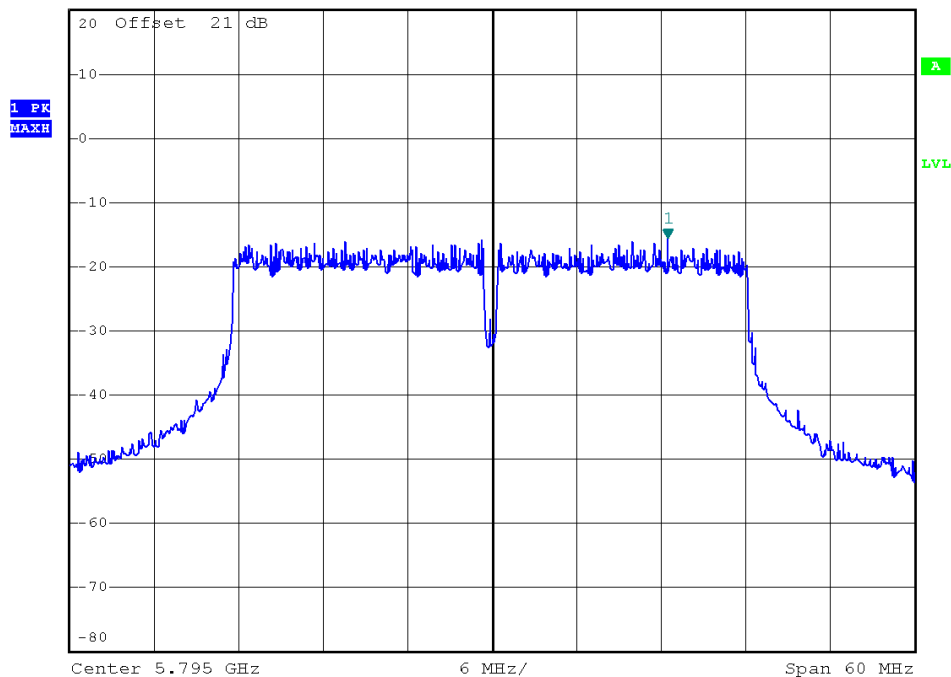



Modulation Standard: 802.11n HT40
Channel: 151 chain 1

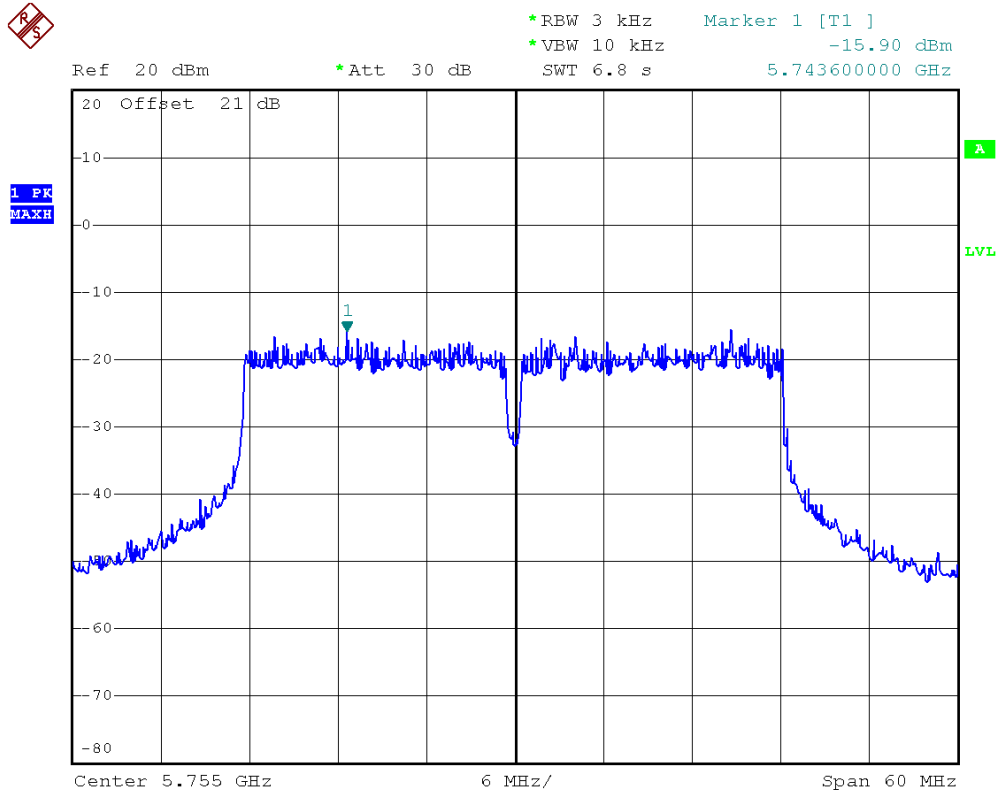

Modulation Standard: 802.11n HT40
Channel: 159 chain 1

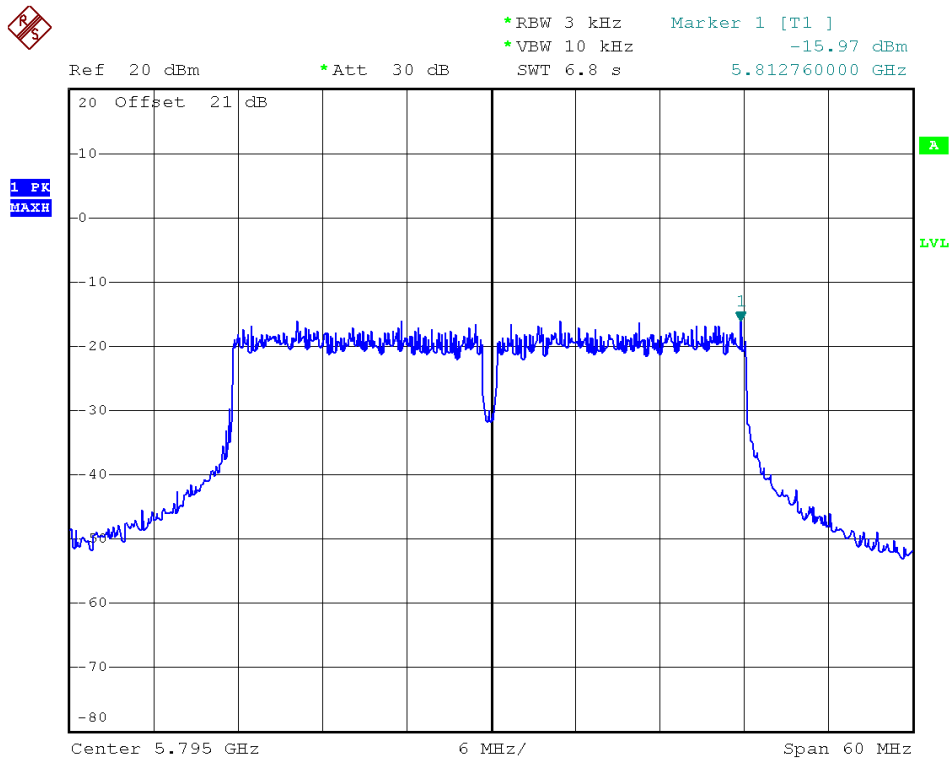



Modulation Standard: 802.11n HT40
Channel: 151 chain 2

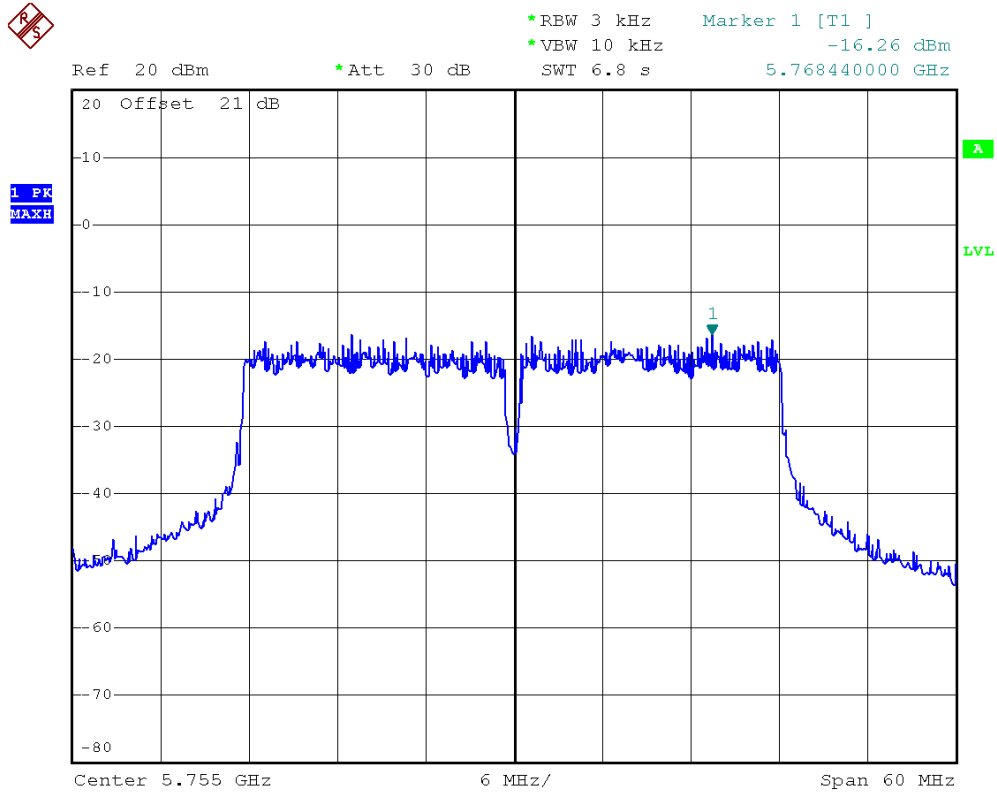

Modulation Standard: 802.11n HT40
Channel: 159 chain 2

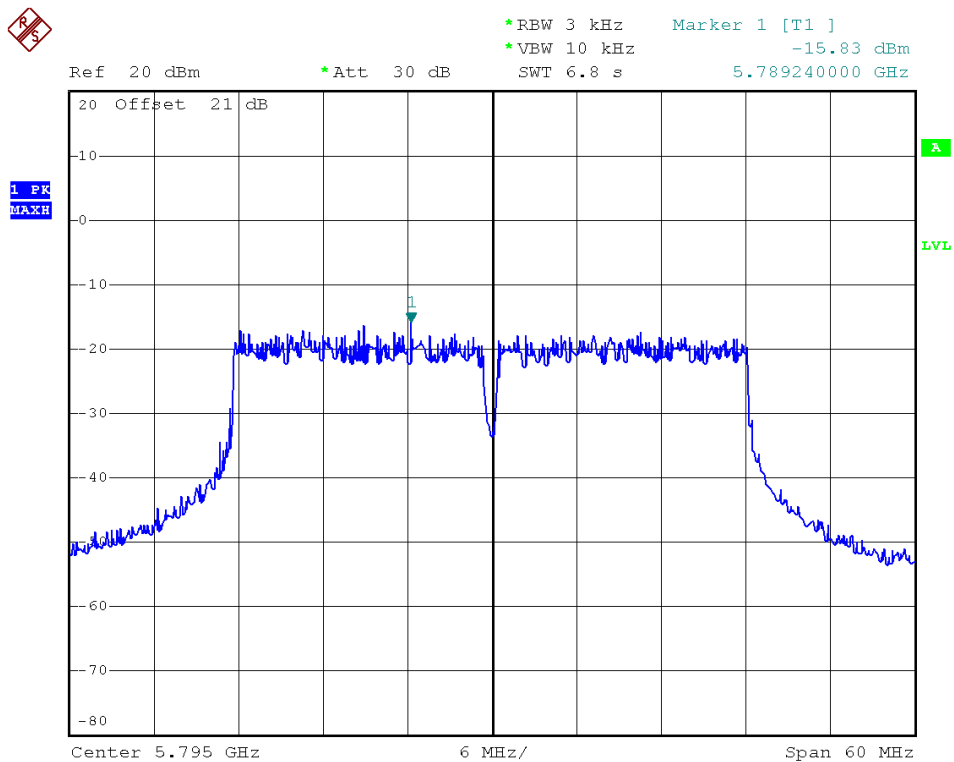



9. Spurious Emissions Measurement

9.1 Limits Of Conducted Emissions Measurement

According to §15.247(d), in any 100 kHz bandwidth outside the frequency bands in which the spread spectrum intentional radiator is operating, the radio frequency power that is produced by the intentional radiator shall be at least 20 dB below that in the 100 kHz bandwidth within the band that contains the highest level of the desired power, based on either an RF conducted or a radiated measurement, provided the transmitter demonstrates compliance with the peak conducted power limits. In addition, radiated emissions which fall in the restricted bands, as defined in §15.205(a), must also comply with the radiated emission limits specified in 15.209(a) (see Section 15.205(c)).

9.2 Measurement equipment

Instrument/Ancillary	Model No.	Manufacturer	Serial No.	Calibration Date	Valid Date
Spectrum Analyzer	FSP40	R&S	100324	2013.03.10	2014.03.09

9.3 Test Procedure (please refer to measurement standard)

Conducted RF measurements of the transmitter output were made to confirm that the EUT antenna port conducted emissions meet the specified limit and to identify any spurious signals that require further investigation or measurements on the radiated emissions site. The transmitter output is connected to the spectrum analyzer. The resolution bandwidth is set to 100 kHz. The video bandwidth is set to 100 kHz.

Measurements are made over the 30MHz to 40GHz range with the transmitter set to the lowest, middle, and highest channels.



9.4 Test Results

Modulation Standard: 802.11a
Channel: 149

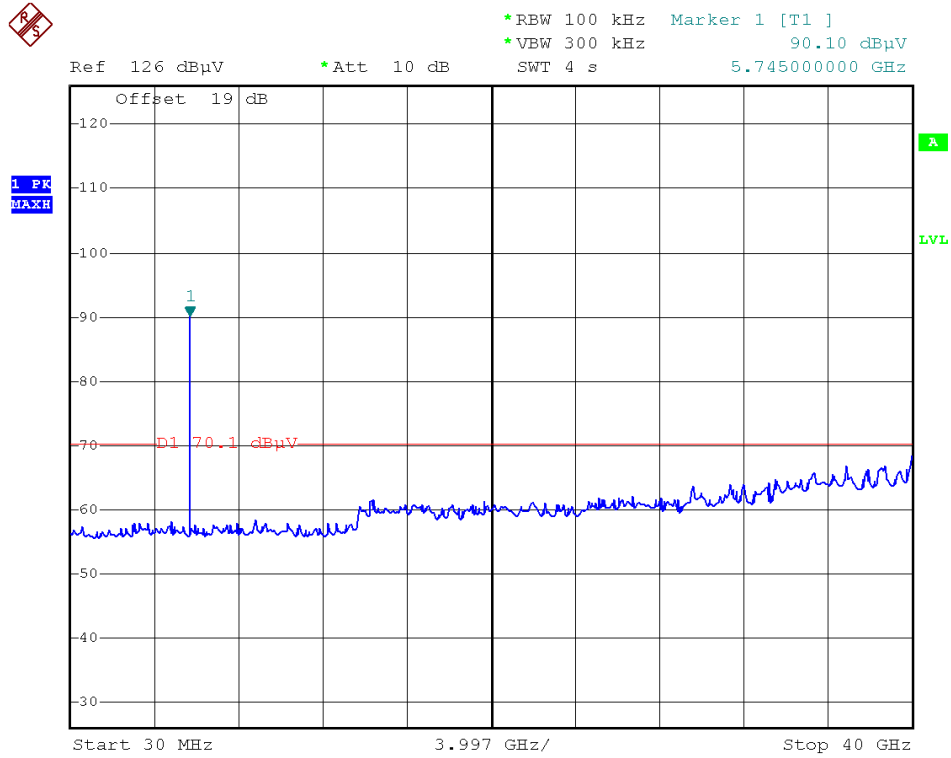

Modulation Standard: 802.11a
Channel: 157

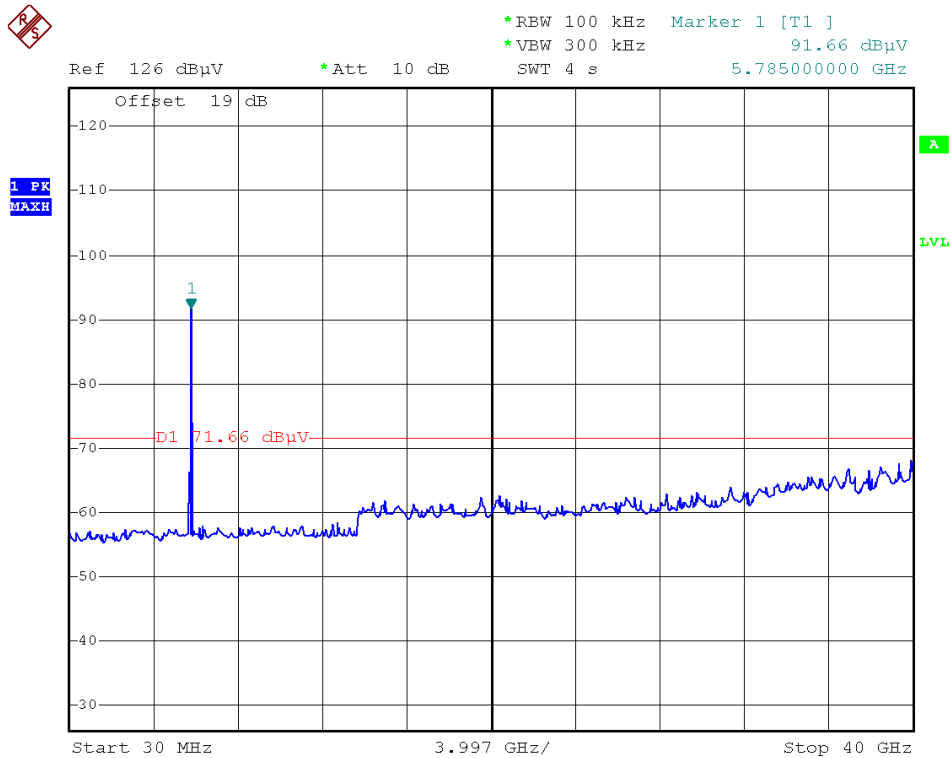



Modulation Standard: 802.11a
Channel: 165

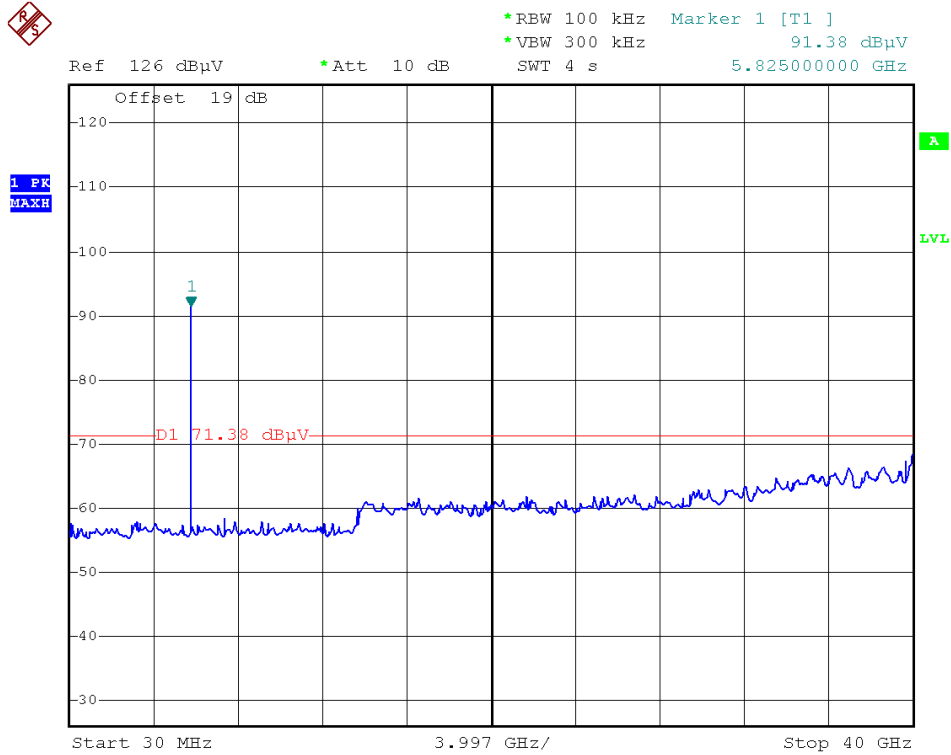

Modulation Standard: 802.11n HT20
Channel: 149 chain0

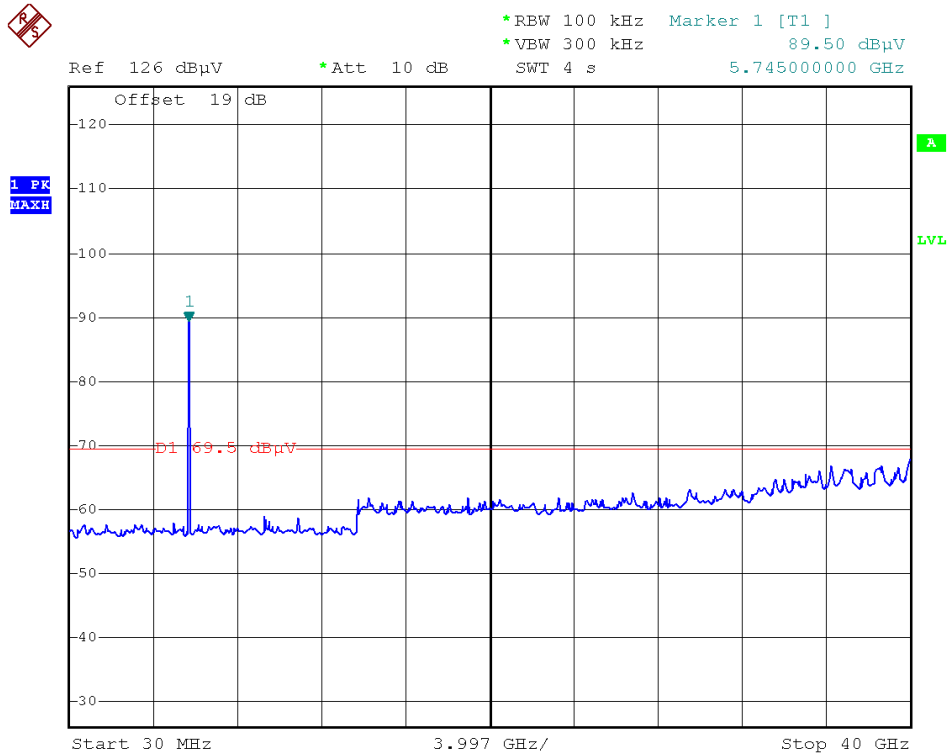



Modulation Standard: 802.11n HT20
Channel: 157 chain0

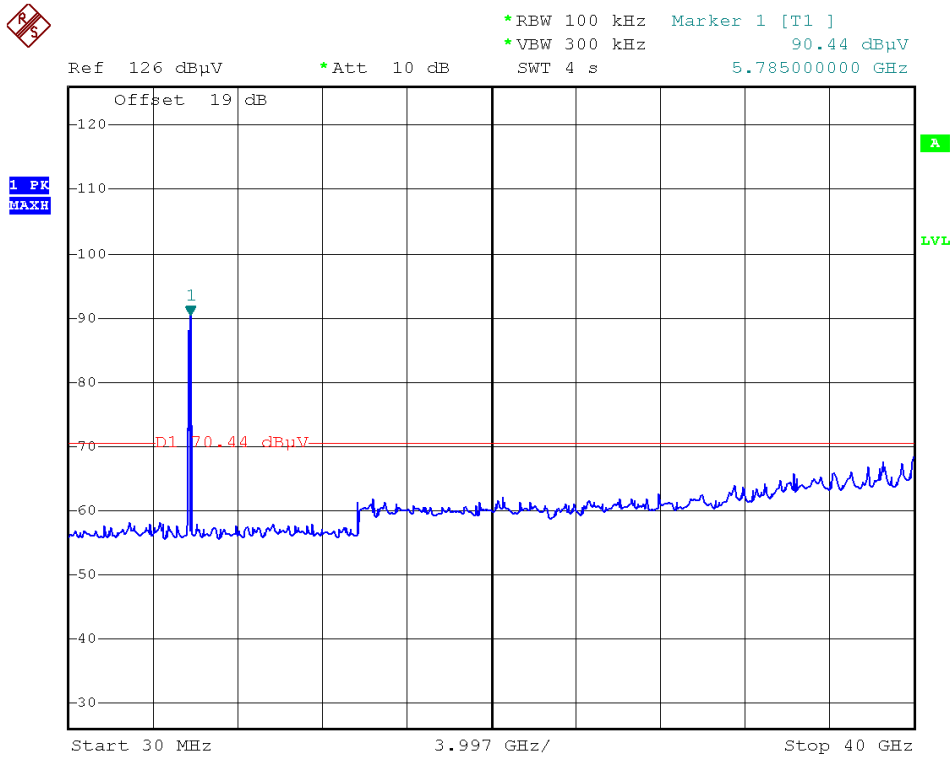

Modulation Standard: 802.11n HT20
Channel: 165 chain0

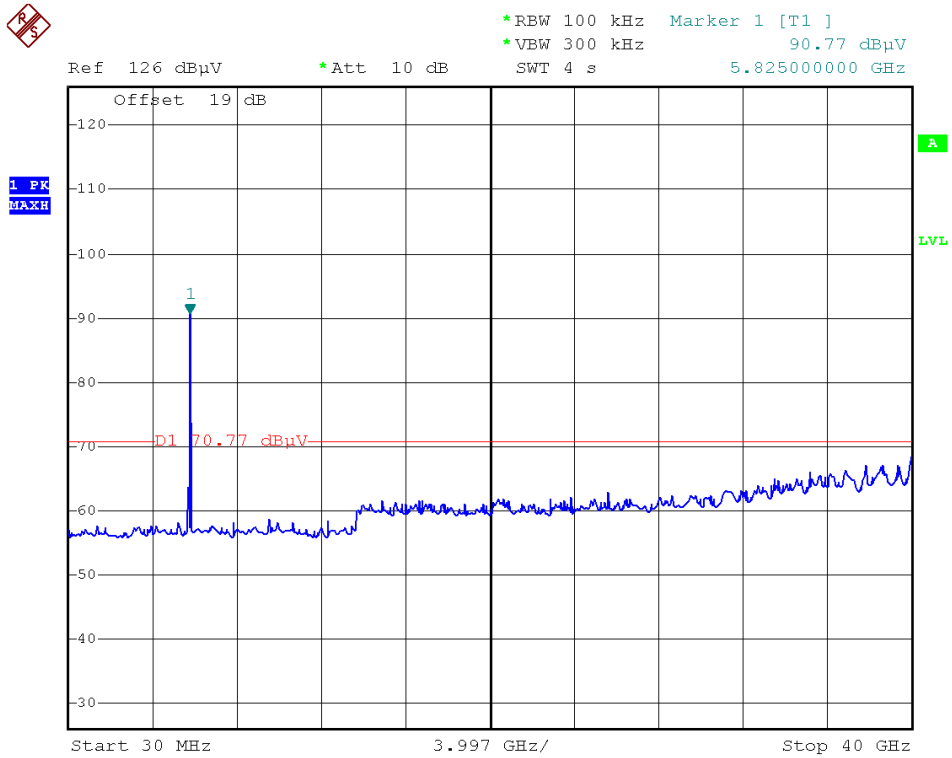



Modulation Standard: 802.11n HT20
Channel: 149 chain 1

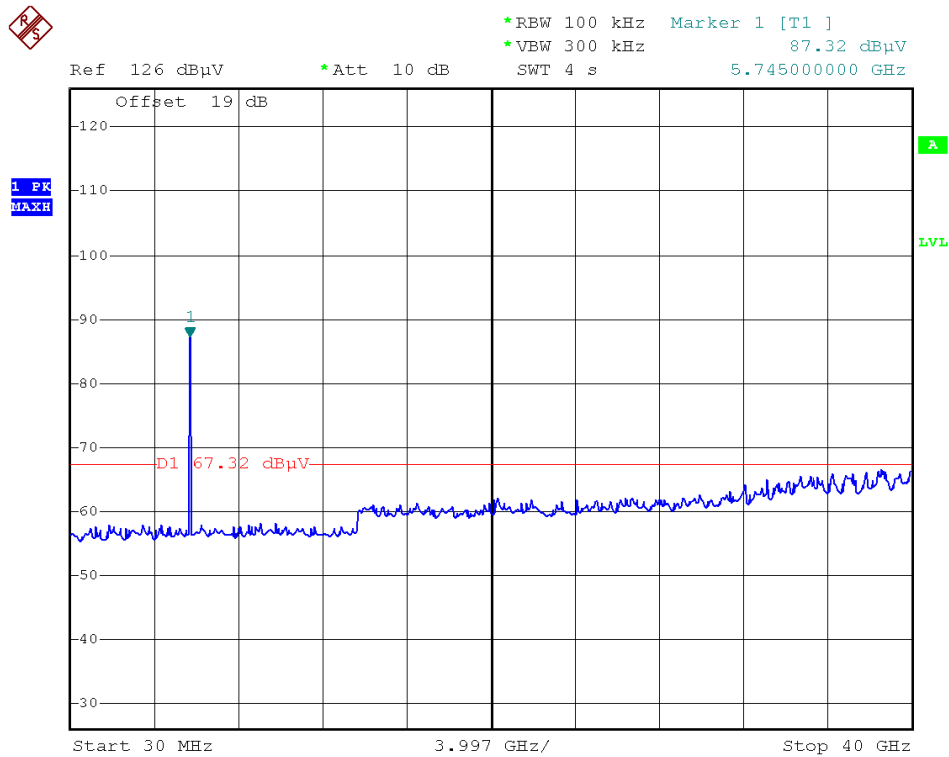

Modulation Standard: 802.11n HT20
Channel: 157 chain 1

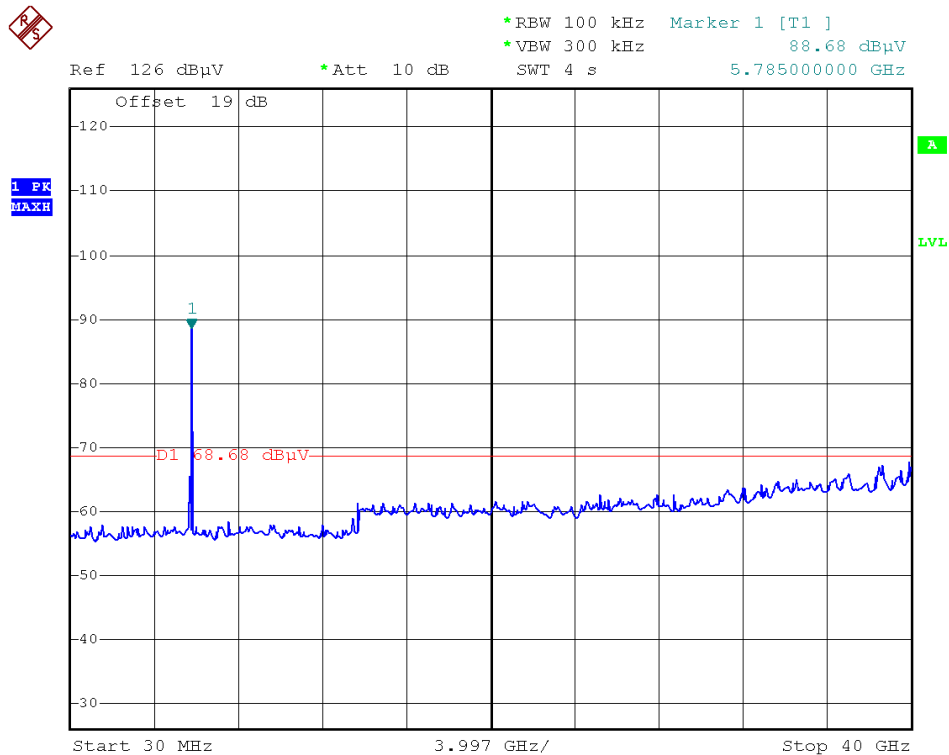



Modulation Standard: 802.11n HT20
Channel: 165 chain 1

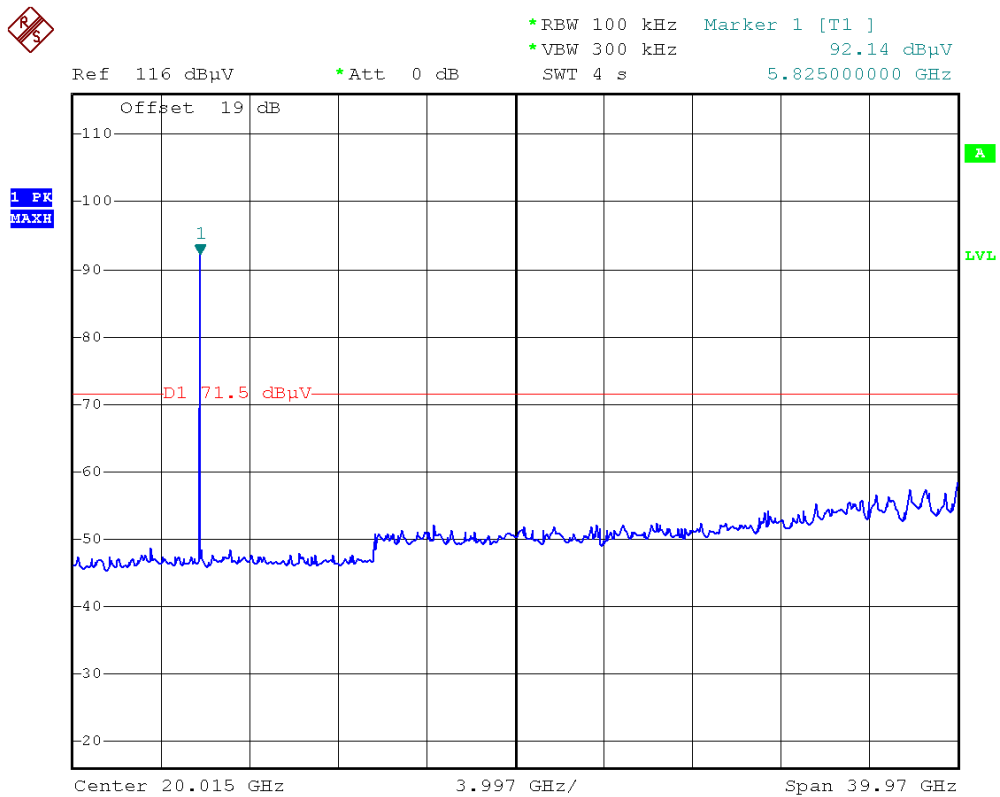

Modulation Standard: 802.11n HT20
Channel: 149 chain 2

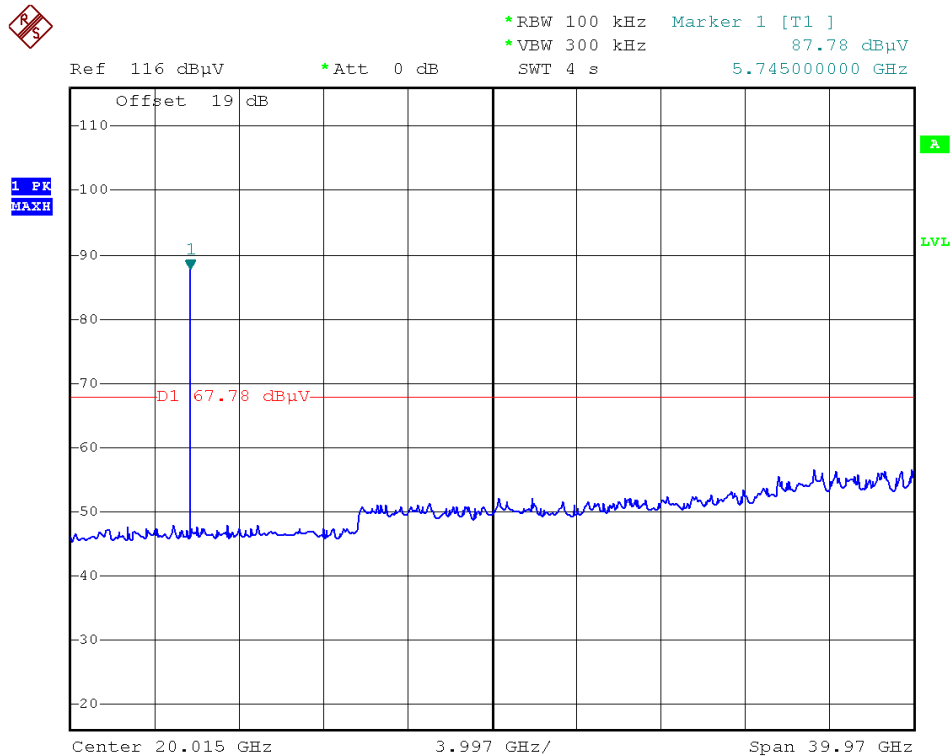



Modulation Standard: 802.11n HT20
Channel: 157 chain 2

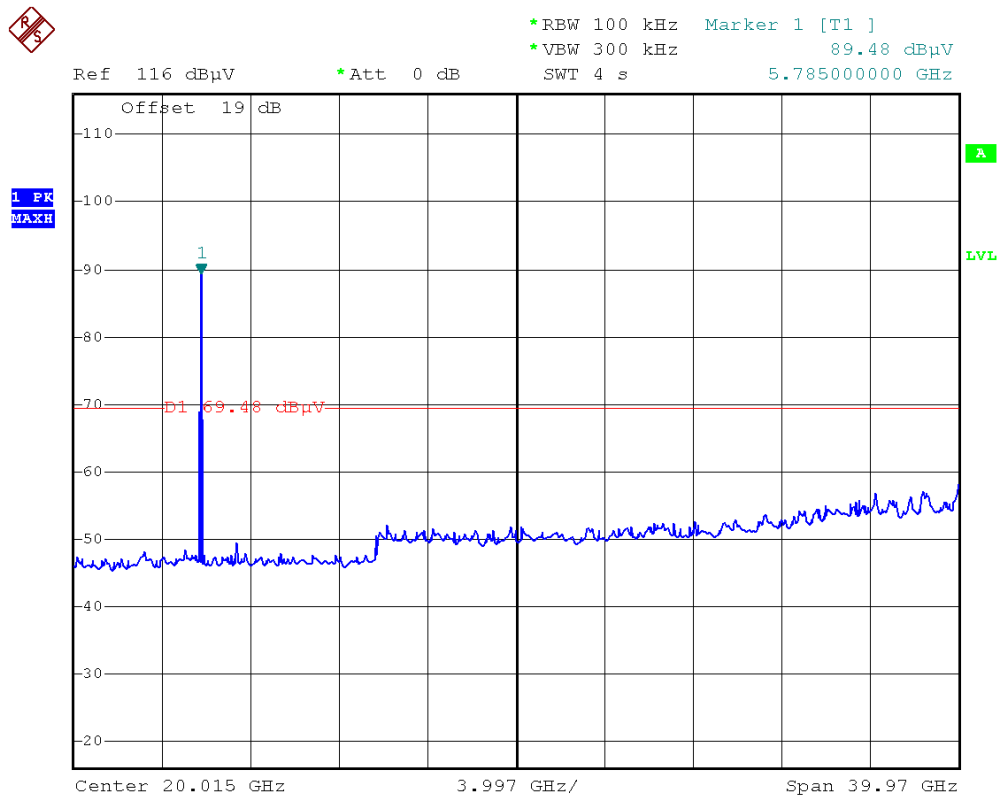

Modulation Standard: 802.11n HT20
Channel: 165 chain 2

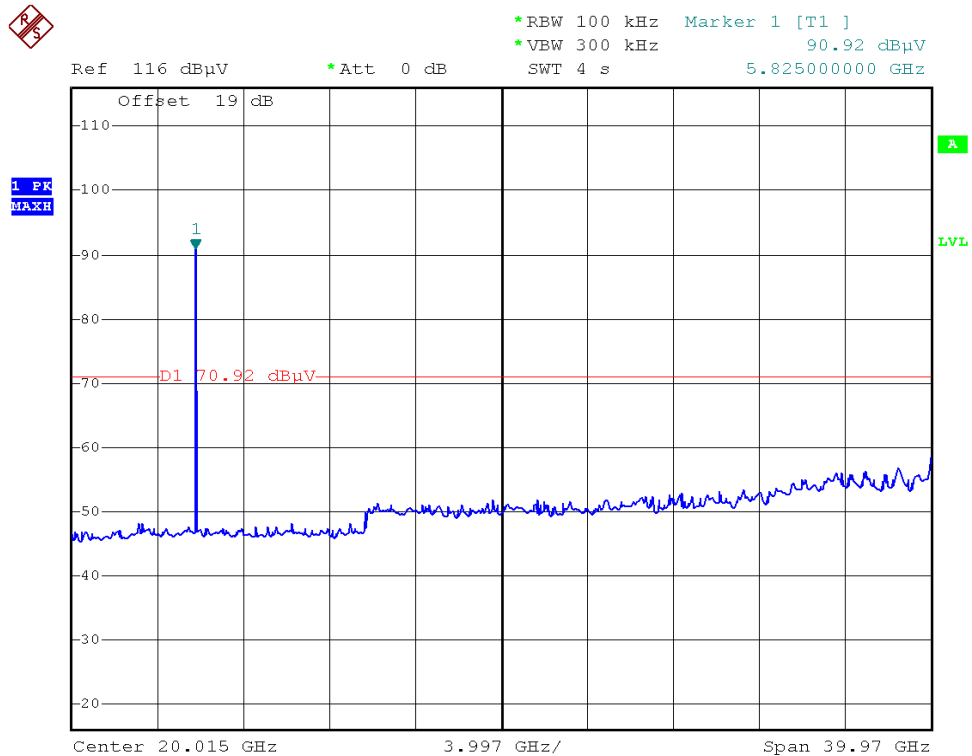



Modulation Standard: 802.11n HT40
Channel: 151 chain 0



Ref 116 dBμV *Att 0 dB *RBW 100 kHz Marker 1 [T1]
*VBW 300 kHz 86.62 dBμV
SWT 4 s 5.705740000 GHz

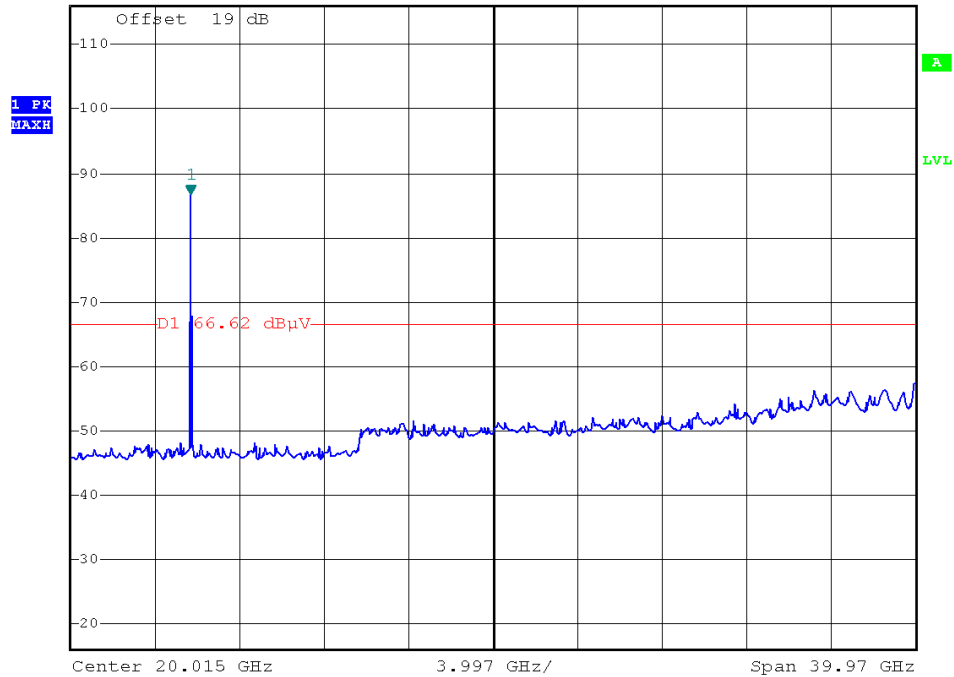

Modulation Standard: 802.11n HT40
Channel: 159 chain 0



Ref 116 dBμV *Att 0 dB *RBW 100 kHz Marker 1 [T1]
*VBW 300 kHz 87.87 dBμV
SWT 4 s 5.795000000 GHz

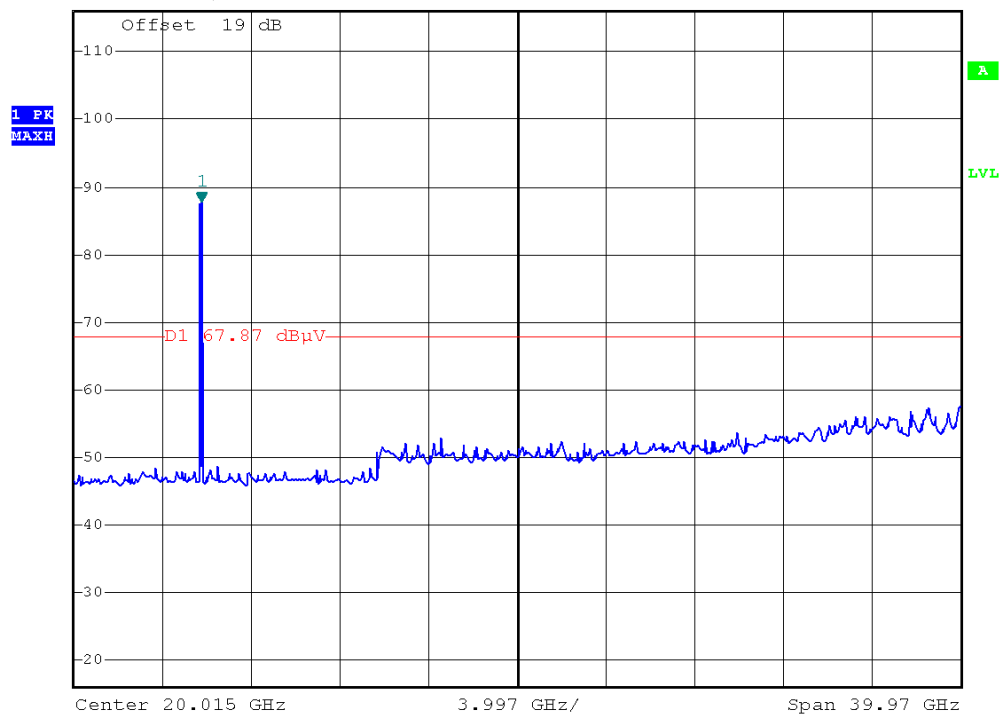



Modulation Standard: 802.11n HT40
Channel: 151 chain 1

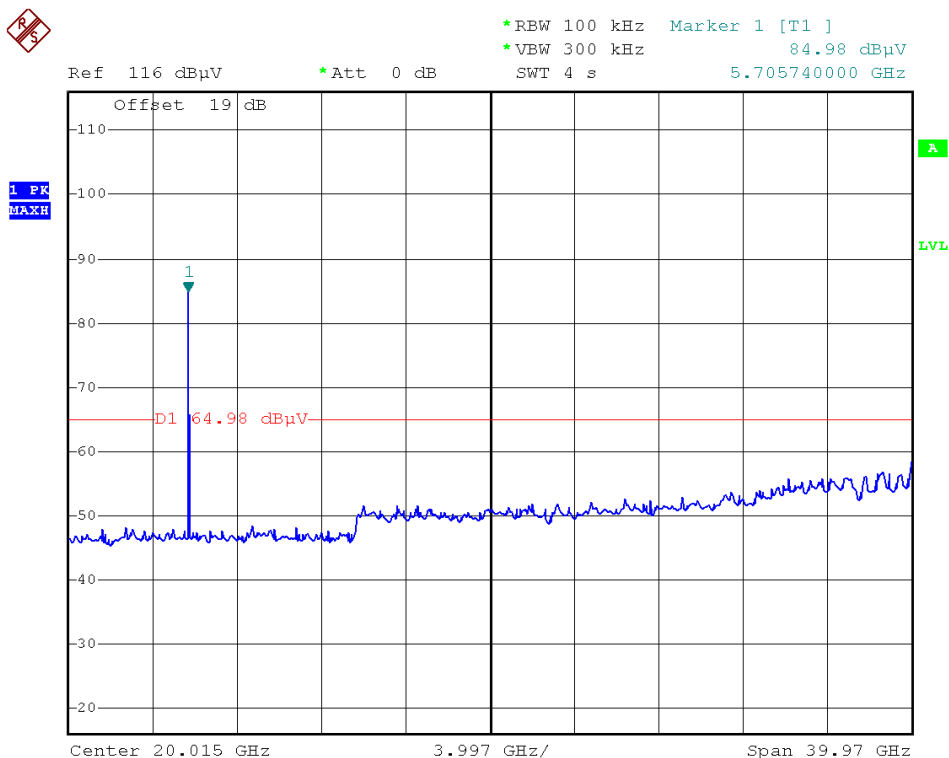

Modulation Standard: 802.11n HT40
Channel: 159 chain 1

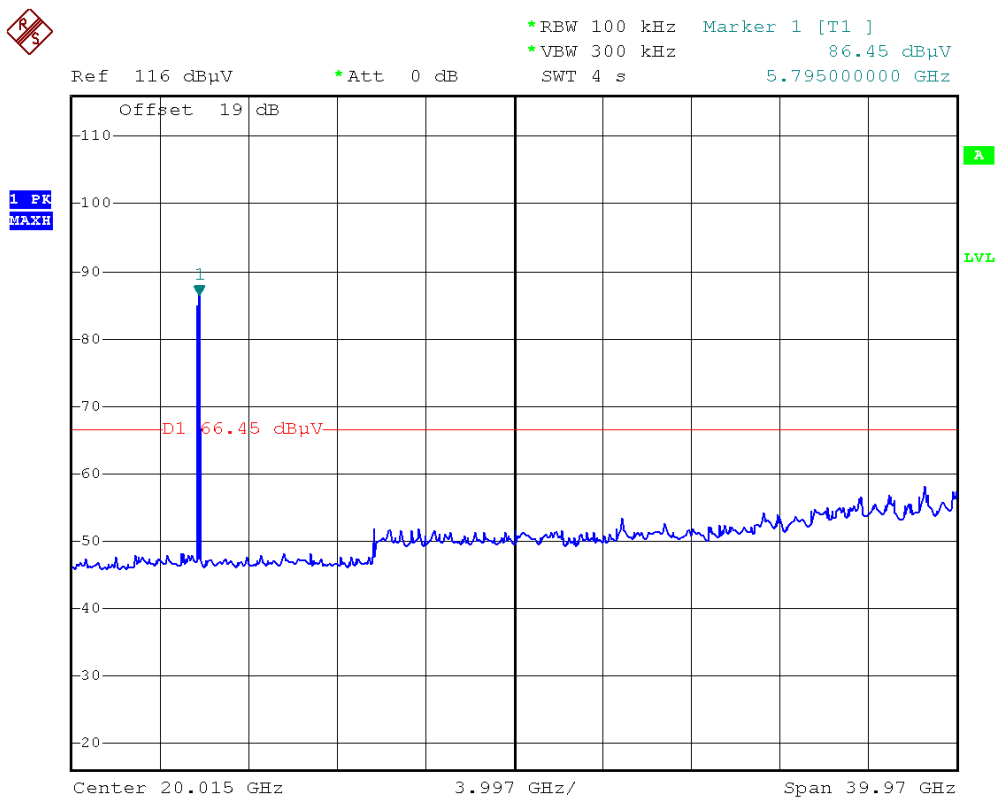



Modulation Standard: 802.11n HT40
Channel: 151 chain 2

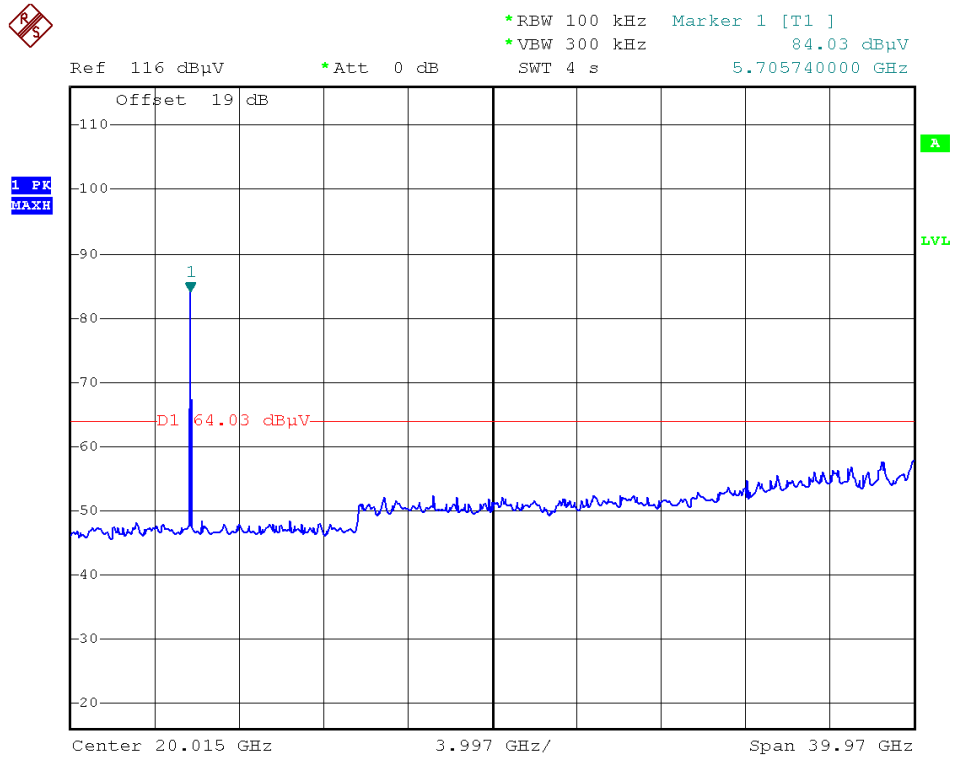

Modulation Standard: 802.11n HT40
Channel: 159 chain 2

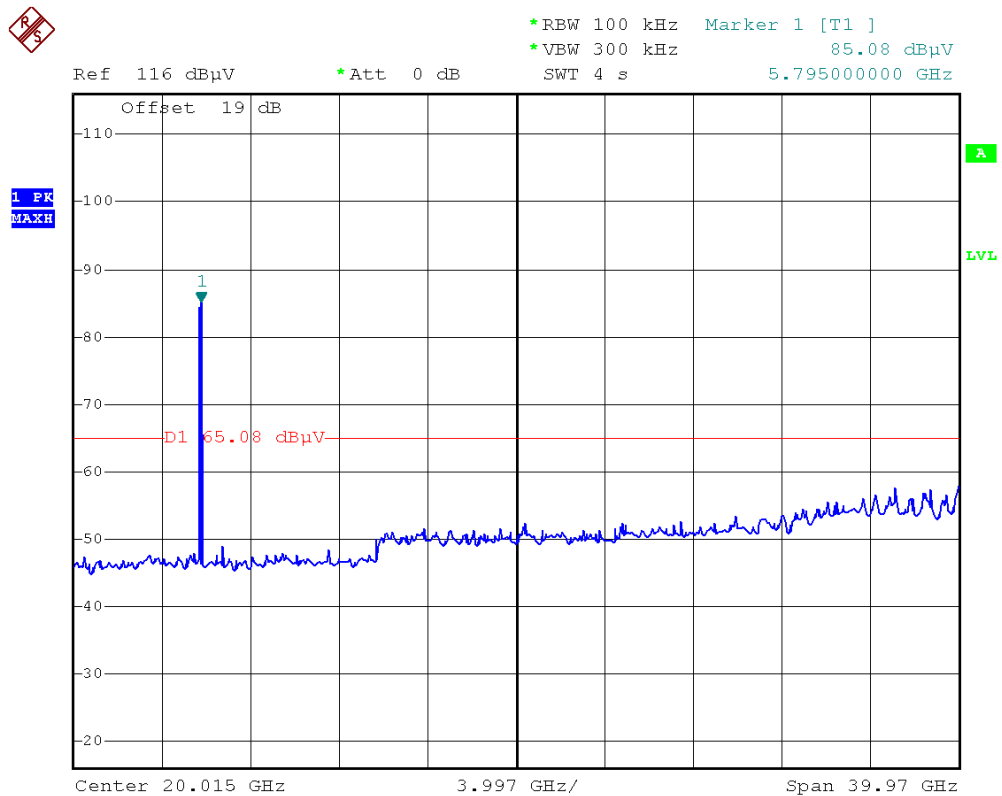



10. Restricted Bands of Operation

Only spurious emissions are permitted in any of the frequency bands listed below:

MHz	MHz	MHz	GHz
0.09000 – 0.11000	16.42000 – 16.42300	399.9 – 410.0	4.500 – 5.250
0.49500 – 0.505**	16.69475 – 16.69525	608.0 – 614.0	5.350 – 5.460
2.17350 – 2.19050	16.80425 – 16.80475	960.0 – 1240.0	7.250 – 7.750
4.12500 – 4.12800	25.50000 – 25.67000	1300.0 – 1427.0	8.025 – 8.500
4.17725 – 4.17775	37.50000 – 38.25000	1435.0 – 1626.5	9.000 – 9.200
4.20725 – 4.20775	73.00000 – 74.60000	1645.5 – 1646.5	9.300 – 9.500
6.21500 – 6.21800	74.80000 – 75.20000	1660.0 – 1710.0	10.600 – 12.700
6.26775 – 6.26825	108.00000 – 121.94000	1718.8 – 1722.2	13.250 – 13.400
6.31175 – 6.31225	123.00000 – 138.00000	2200.0 – 2300.0	14.470 – 14.500
8.29100 – 8.29400	149.90000 – 150.05000	2310.0 – 2390.0	15.350 – 16.200
8.36200 – 8.36600	156.52475 – 156.52525	2483.5 – 2500.0	17.700 – 21.400
8.37625 – 8.38675	156.70000 – 156.90000	2655.0 – 2900.0	22.010 – 23.120
8.41425 – 8.41475	162.01250 – 167.17000	3260.0 – 3267.0	23.600 – 24.000
12.29000 – 12.29300	167.72000 – 173.20000	3332.0 – 3339.0	31.200 – 31.800
12.51975 – 12.52025	240.00000 – 285.00000	3345.8 – 3358.0	36.430 – 36.500
12.57675 – 12.57725	322.00000 – 335.40000	3600.0 – 4400.0	Above 38.6
13.36000 – 13.41000			

** : Until February 1, 1999, this restricted band shall be 0.490-0.510 MHz

10.1 Labeling Requirement

The device shall bear the following statement in a conspicuous location on the device:

This device complies with part 15 of the FCC Rules. Operation is subject to the following two conditions: (1) This device may not cause harmful interference, and (2) this device must accept any interference received, including interference that may cause undesired operation.