

# RF MEASUREMENT REPORT

---

**FCC ID:** TK4WLE3002HX  
**Applicant:** Compex Systems Pte Ltd  
**Product:** WiFi 6 (802.11ax) 2x2 MU-MIMO Dual Band Module  
**Model No.:** WLE3002HX  
**Serial Model No.:** WLE3002HX-I  
**Brand Name:** COMPEX  
**FCC Classification:** Digital Transmission System (DTS)  
**FCC Rule Part(s):** Part 15 Subpart C (Section 15.247)  
**Result:** Complies  
**Received Date:** 2023-01-06  
**Test Date:** 2022-11-22 ~ 2023-01-28

**Reviewed By:**

\_\_\_\_\_  
Jame Yuan

**Approved By:**

\_\_\_\_\_  
Robin Wu



The test results relate only to the samples tested.

This equipment has been shown to be capable of compliance with the applicable technical standards as indicated in the measurement report and was tested in accordance with the measurement procedures specified in ANSI C63.10-2013. Test results reported herein relate only to the item(s) tested.

The test report shall not be reproduced except in full without the written approval of MRT Technology (Suzhou) Co., Ltd.

### Revision History

Report No.	Version	Description	Issue Date	Note
2301RSU014-U1	Rev. 01	Initial Report	2023-02-21	Valid

Note: The **WiFi 6 (802.11ax) 2x2 MU-MIMO Dual Band Module** is a variation of **WiFi 6 (802.11ax) 4x4 MU-MIMO Dual Band Module** (Report No.: 2210RSU016-U2). Except for the removal of ant 1 port and ant 3 port, everything remains unchanged and the power remains the same as before. Therefore, no matter the conduction or radiation test, we carried out data reference, and some spot check verification test was conducted for the following three items. Other items are the same and recalculated.

Item	Test Data	Remark
6dB Bandwidth	Reuse	N/A
Output Power	Reuse	Spot Check
Power Spectral Density	Reuse	N/A
Band Edge / Out-of-Band Emissions	Reuse	N/A
General Field Strength (Restricted Bands and Radiated Emission)	Reuse	Spot Check
AC Conducted Emissions 150kHz - 30MHz	Reuse	N/A

## CONTENTS

Description	Page
<b>1. General Information .....</b>	<b>5</b>
1.1. Applicant .....	5
1.2. Manufacturer .....	5
1.3. Testing Facility .....	5
1.4. Product Information.....	6
1.5. Radio Specification under Test .....	6
1.6. Working Frequencies .....	7
1.7. Antenna Details.....	7
<b>2. Test Configuration .....</b>	<b>8</b>
2.1. Test Mode.....	8
2.2. Test System Connection Diagram.....	8
2.3. Test Software .....	9
2.4. Applied Standards.....	9
2.5. Test Environment Condition .....	9
<b>3. Antenna Requirements .....</b>	<b>10</b>
<b>4. Measuring Instrument .....</b>	<b>11</b>
<b>5. Decision Rules and Measurement Uncertainty .....</b>	<b>12</b>
5.1. Decision Rules .....	12
5.2. Measurement Uncertainty .....	12
<b>6. Test Result.....</b>	<b>13</b>
6.1. Summary.....	13
6.2. 6dB Bandwidth Measurement.....	14
6.2.1. Test Limit .....	14
6.2.2. Test Procedure .....	14
6.2.3. Test Setting .....	14
6.2.4. Test Setup .....	14
6.2.5. Test Result .....	14
6.3. Output Power Measurement .....	15
6.3.1. Test Limit .....	15
6.3.2. Test Procedure .....	15
6.3.3. Test Setting .....	15
6.3.4. Test Setup .....	15
6.3.5. Test Result .....	15
6.4. Power Spectral Density Measurement .....	16
6.4.1. Test Limit .....	16

6.4.2.	Test Procedure .....	16
6.4.3.	Test Setting .....	16
6.4.4.	Test Setup .....	16
6.4.5.	Test Result .....	17
6.5.	Conducted Band Edge and Out-of-Band Emissions Measurement .....	18
6.5.1.	Test Limit .....	18
6.5.2.	Test Procedure .....	18
6.5.3.	Test Setting .....	18
6.5.4.	Test Setup .....	19
6.5.5.	Test Result .....	19
6.6.	Radiated Spurious Emission Measurement.....	20
6.6.1.	Test Limit .....	20
6.6.2.	Test Procedure .....	20
6.6.3.	Test Setting .....	20
6.6.4.	Test Setup .....	22
6.6.5.	Test Result .....	23
6.7.	Radiated Restricted Band Edge Measurement .....	24
6.7.1.	Test Limit .....	24
6.7.2.	Test Procedure .....	25
6.7.3.	Test Setting .....	25
6.7.4.	Test Setup .....	26
6.7.5.	Test Result .....	26
6.8.	AC Conducted Emissions Measurement .....	27
6.8.1.	Test Limit .....	27
6.8.2.	Test Setup .....	27
6.8.3.	Test Result .....	27
<b>Appendix A – Test Result .....</b>		<b>28</b>
A.1	Duty Cycle Test Result .....	28
A.2	6dB Bandwidth Test Result .....	30
A.3	Output Power Test Result .....	37
A.4	Power Spectral Density Test Result.....	39
A.5	Conducted Band Edge and Out-of-Band Emissions Test Result.....	52
A.6	Radiated Spurious Emission Test Result.....	77
A.7	Radiated Restricted Band Edge Test Result.....	92
A.8	AC Conducted Emissions Test Result .....	388
<b>Appendix B – Test Setup Photograph .....</b>		<b>390</b>
<b>Appendix C – EUT Photograph .....</b>		<b>391</b>



#### 1.4. Product Information

Product Name	WiFi 6 (802.11ax) 2x2 MU-MIMO Dual Band Module
Model No.	WLE3002HX
Serial Model No.	WLE3002HX-I
Wi-Fi Specification	802.11a/b/g/n/ac/ax
Antenna Information	Refer to Section 1.7
Operating Voltage	3.3Vdc
<p>Note:</p> <ol style="list-style-type: none"> <li>The information of EUT was provided by the manufacturer, and the accuracy of the information shall be the responsibility of the manufacturer.</li> <li>Model Difference: Marketing purpose only.</li> </ol>	

#### 1.5. Radio Specification under Test

Frequency Range	802.11b/g/n-HT20/ax-HE20: 2412 ~ 2462MHz 802.11n-HT40/ax-HE40: 2422 ~ 2452MHz
Channel Number	802.11b/g/n-HT20/ax-HE20: 11 802.11n-HT40/ax-HE40: 7
Type of Modulation	802.11b: DSSS 802.11g/n: OFDM 802.11ax: OFDMA
Data Rate	802.11b: 1/2/5.5/11Mbps 802.11g: 6/9/12/18/24/36/48/54Mbps 802.11n: up to 300Mbps 802.11ax: up to 574Mbps

## 1.6. Working Frequencies

802.11b/g/n-HT20/ax-HE20

Channel	Frequency	Channel	Frequency	Channel	Frequency
01	2412 MHz	02	2417 MHz	03	2422 MHz
04	2427 MHz	05	2432 MHz	06	2437 MHz
07	2442 MHz	08	2447 MHz	09	2452 MHz
10	2457 MHz	11	2462 MHz	--	--

802.11n-HT40/ax-HE40

Channel	Frequency	Channel	Frequency	Channel	Frequency
03	2422 MHz	04	2427 MHz	05	2432 MHz
06	2437 MHz	07	2442 MHz	08	2447 MHz
09	2452 MHz	--	--	--	--

## 1.7. Antenna Details

Antenna No.	Model No.	Polarization	2.4GHz Max. Peak Gain (dBi)	CDD Directional Gain (dBi)	
				For Power	For PSD
3#	02 S00029A	Omni	3.40	3.40	6.41
4#	Flatant-4x4-dualband-6dBi	Omni	6.00	6.00	9.01
5#	SAA04-22008A	Omni	4.50	4.50	7.51
6#	ALX18P-222AA1-01	Omni	2.60	2.60	5.61
7#	RFDPA171300SBLB801	Omni	2.22	2.22	5.23

Note

- The EUT supports Cyclic Delay Diversity (CDD) mode, and CDD signals are correlated.  
For CDD transmissions, directional gain is calculated as follows,  $N_{ANT} = 2$ ,  $N_{SS} = 1$ . If all antennas have the same gain,  $G_{ANT}$ , Directional gain =  $G_{ANT} + \text{Array Gain}$ , where Array Gain is as follows.
  - For power spectral density (PSD) measurements on all devices, Array Gain =  $10 \log(N_{ANT}/N_{SS})$  dB = 3.01;
  - For power measurements on IEEE 802.11 devices, Array Gain = 0 dB for  $N_{ANT} \leq 4$ ;
- We select the higher peak gain Ant 4# to perform testing, other antennas (Antenna 3#, Antenna 5#) only evaluate Radiated Spurious Emission and Radiated Restricted Band Edge for worse case mode.
- The gain of antenna #6 and antenna #7 is less than the maximum gain of the same type. So there's no evaluation of additional tests.

## 2. Test Configuration

### 2.1. Test Mode

Mode 1: Transmit by 802.11b (1Mbps)
Mode 2: Transmit by 802.11g (6Mbps)
Mode 3: Transmit by 802.11n-HT20 (MCS0)
Mode 4: Transmit by 802.11n-HT40 (MCS0)
Mode 5: Transmit by 802.11ax-HE20 (MCS0)
Mode 6: Transmit by 802.11ax-HE40 (MCS0)

Note: All modes of operation and data rates were investigated, so all RF test requirements shall be executed at the worse data rate which power is the greatest.

### 2.2. Test System Connection Diagram

The device was tested per the guidance ANSI C63.10: 2013 was used to reference the appropriate EUT setup for radiated emissions testing and AC line conducted testing.

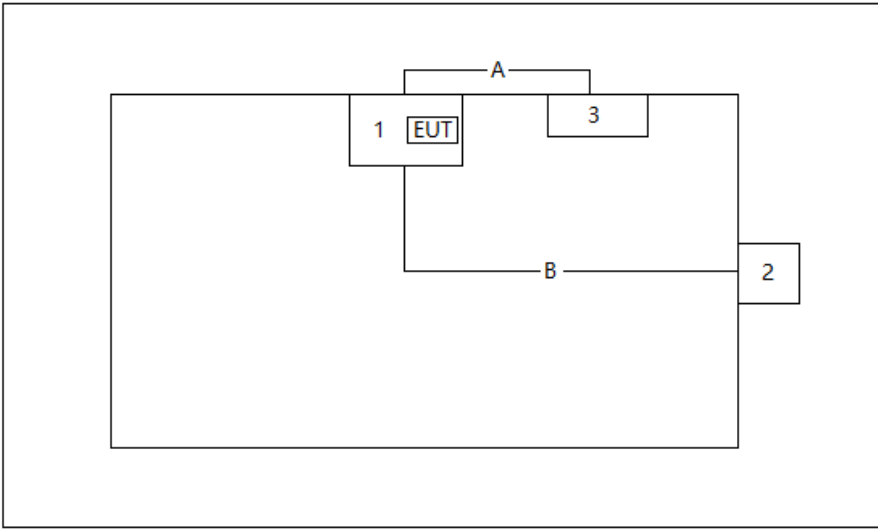
Connection Diagram – Radiated Emission testing & AC Conducted Emissions			
			
No.	Cable Type	Cable Spec.	Length
A	Power Cable	Non-Shielding	1.5m
B	LAN Cable	Non-Shielding	> 10m
No.	Product	Manufacturer	Model No.
1	Host	COMPEX	WPQXXX
2	Notebook	Lenovo	E495
3	Adapter	LEADER ELECTRONICS INC.	MU30AY120250-C5



### 2.3. Test Software

The EUT could transmit or receive via engineer order provided by the manufacturer.

### 2.4. Applied Standards

According to the specifications of the manufacturer, the EUT must comply with the requirements of the following standards:

- FCC Part 15.247
- KDB 558074 D01v05r02
- ANSI C63.10-2013

### 2.5. Test Environment Condition

Ambient Temperature	15 ~ 35°C
Relative Humidity	20 ~ 75%RH

### 3. Antenna Requirements

**Excerpt from §15.203 of the FCC Rules/Regulations:**

“An intentional radiator antenna shall be designed to ensure that no antenna other than that furnished by the responsible party can be used with the device. The use of a permanently attached antenna or of an antenna that uses a unique coupling to the intentional radiator shall be considered sufficient to comply with the provisions of this section.”

For Antenna 4# & 6# Configuration

- The antenna of the device is permanently attached.
- There are no provisions for connection to an external antenna.

For Antenna 3# & 5# & 7# Configuration

- The antenna of the device uses a unique IPEX connector.

**Conclusion:**

The unit complies with the requirement of §15.203.

#### 4. Measuring Instrument

Instrument	Manufacturer	Model No.	Asset No.	Cali. Interval	Cali. Due Date	Test Site
EMI Test Receiver	R&S	ESR7	MRTSUE06001	1 year	2022-12-29 2023-12-28	WZ-AC1
Horn Antenna	Schwarzbeck	BBHA 9120D	MRTSUE06023	1 year	2023-08-22	WZ-AC1
Preamplifier	Agilent	83017A	MRTSUE06076	1 year	2023-05-08	WZ-AC1
TRILOG Antenna	Schwarzbeck	VULB 9168	MRTSUE06172	1 year	2023-06-21	WZ-AC1
Anechoic Chamber	TDK	WZ-AC1	MRTSUE06212	1 year	2023-04-21	WZ-AC1
Thermohygrometer	testo	608-H1	MRTSUE06403	1 year	2023-06-06	WZ-AC1
Signal Analyzer	Keysight	N9010B	MRTSUE06607	1 year	2022-12-29 2023-12-28	WZ-AC1
Thermohygrometer	testo	608-H1	MRTSUE11039	1 year	2023-11-01	WZ-AC1
Horn Antenna	ETS	3117	MRTSUE06257	1 year	2023-09-18	WZ-AC1
Horn Antenna	Schwarzbeck	BBHA 9170	MRTSUE06597	1 year	2023-11-05	WZ-AC1
Preamplifier	EMCI	EMC184045SE	MRTSUE06640	1 year	2023-01-13 2024-01-12	WZ-AC1
Preamplifier	EMCI	EMC051845SE	MRTSUE06987	1 year	2023-09-08	WZ-AC1
Two-Line V-Network	R&S	ENV216	MRTSUE06002	1 year	2023-06-04	WZ-SR2
Symmetrical Attenuator	Schwarzbeck	SYMAT 40	MRTSUE06117	1 year	2023-04-10	WZ-SR2
Shielding Room	MIX-BEP	WZ-SR2	MRTSUE06215	5 years	2026-12-20	WZ-SR2
Thermohygrometer	testo	608-H1	MRTSUE06404	1 year	2023-06-06	WZ-SR2
Four-Line V-Network	R&S	ENV432	MRTSUE06615	1 year	2023-10-08	WZ-SR2
EMI Test Receiver	R&S	ESR3	MRTSUE06909	1 year	2023-10-27	WZ-SR2
V-Network	R&S	ESH3-Z6	MRTSUE06187	1 year	2023-04-06	WZ-SR2
V-Network	R&S	ESH3-Z6	MRTSUE06188	1 year	2023-04-06	WZ-SR2
CVP	Teseq	CVP 2200A	MRTSUE06455	1 year	2023-06-04	WZ-SR2
Temperature Chamber	BAOYT	BYH-150CL	MRTSUE06051	1 year	2023-10-08	WZ-TR3
Thermohygrometer	testo	608-H1	MRTSUE06401	1 year	2023-06-06	WZ-TR3
USB Power Sensor	Boonton	55006	MRTSUE06109	1 year	2023-04-06	WZ-TR3
Signal Analyzer	Keysight	N9010B	MRTSUE07027	1 year	2023-11-25	WZ-TR3
Signal Analyzer	Keysight	N9020B	MRTSUE07037	1 year	2023-03-29	WZ-TR3

Software	Version	Function
EMI Software	V3.0.0	EMI Test Software
Controller_MF 7802	1.02	RE Antenna & Turntable
Controller_MF 7802	2.03C	RE Antenna & Turntable
Agilent Power Analyzer/Agilent Power Panel	V R03.09.00	Power

## 5. Decision Rules and Measurement Uncertainty

### 5.1. Decision Rules

The Decision Rule is based on Simple Acceptance in accordance with ISO Guide 98-4: 2012 Clause 8.2. (Measurement uncertainty is not taken into account when stating conformity with a specified requirement.)

### 5.2. Measurement Uncertainty

Where relevant, the following test uncertainty levels have been estimated for tests performed on the EUT as specified in CISPR 16-4-2. This uncertainty represents an expanded uncertainty expressed at approximately the 95% confidence level using a coverage factor of  $k = 2$ .

<b>AC Conducted Emission Measurement</b>
The maximum measurement uncertainty is evaluated as: 9kHz~150kHz: 3.58dB 150kHz~30MHz: 3.20dB
<b>Radiated Disturbance</b>
The maximum measurement uncertainty is evaluated as: Coaxial: 9kHz~30MHz: 2.59dB Coplanar: 9kHz~30MHz: 2.60dB Horizontal: 30MHz~200MHz: 3.85dB 200MHz~1GHz: 4.36dB 1GHz~40GHz: 4.98dB Vertical: 30MHz~200MHz: 4.06dB 200MHz~1GHz: 5.28dB 1GHz~40GHz: 4.91dB
<b>Spurious Emissions, Conducted</b>
Measuring Uncertainty for a Level of Confidence of 95% ( $U=2Uc(y)$ ): 2.3 dB
<b>Output Power</b>
Measuring Uncertainty for a Level of Confidence of 95% ( $U=2Uc(y)$ ): 1.5 dB
<b>Power Spectrum Density</b>
Measuring Uncertainty for a Level of Confidence of 95% ( $U=2Uc(y)$ ): 2.3 dB
<b>Occupied Bandwidth</b>
Measuring Uncertainty for a Level of Confidence of 95% ( $U=2Uc(y)$ ): 3.2 %

## 6. Test Result

### 6.1. Summary

FCC Section(s)	Test Description	Test Condition	Verdict
15.247(a)(2)	6dB Bandwidth	Conducted	Pass
15.247(b)(3)	Output Power		Pass
15.247(e)	Power Spectral Density		Pass
15.247(d)	Band Edge / Out-of-Band Emissions		Pass
15.205 15.209	General Field Strength (Restricted Bands and Radiated Emission)	Radiated	Pass
15.207	AC Conducted Emissions 150kHz - 30MHz	Line Conducted	Pass

#### Notes:

- The analyzer plots shown in this section were all taken with a correction table loaded into the analyzer. The correction table was used to account for the losses of the cables and attenuators used as part of the system to connect the EUT to the analyzer at all frequencies of interest.
- For radiated emission tests, every axis (X, Y, Z) was also verified. The test results shown in the following sections represent the worst-case emissions.

## 6.2. 6dB Bandwidth Measurement

### 6.2.1. Test Limit

The minimum 6dB bandwidth shall be at least 500 kHz.

### 6.2.2. Test Procedure

ANSI C63.10 - 2013 - Section 11.8

### 6.2.3. Test Setting

1. The Spectrum's automatic bandwidth measurement capability was used to perform the 6dB bandwidth measurement. The "X" dB bandwidth parameter was set to  $X = 6$ . The bandwidth measurement was not influenced by any intermediate power nulls in the fundamental emission.
2. Set RBW = 100 kHz
3. VBW  $\geq 3 \times$  RBW
4. Detector = Peak
5. Trace mode = Max hold
6. Sweep = Auto couple
7. Allow the trace to stabilize

### 6.2.4. Test Setup

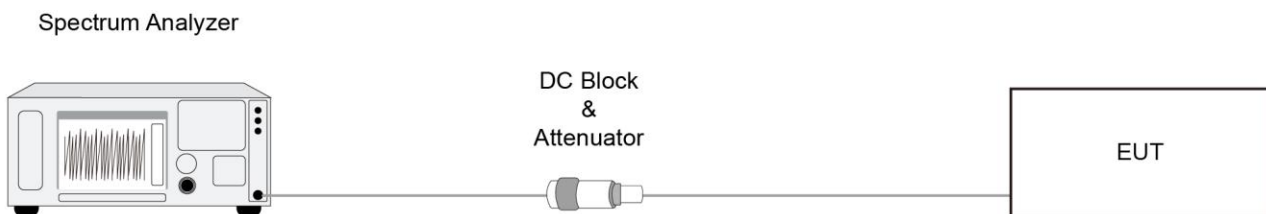

### 6.2.5. Test Result

Refer to Appendix A.2.

### 6.3. Output Power Measurement

#### 6.3.1. Test Limit

The maximum output power shall be less 1 Watt (30dBm).

The conducted output power limit specified in paragraph FCC Part 15.247(b) of this section is based on the use of antennas with directional gains that do not exceed 6 dBi. If transmitting antennas of directional gain greater than 6 dBi are used, the conducted output power from the intentional radiator shall be reduced below the stated values in paragraphs FCC Part 15.247(b)(3) of this section, as appropriate, by the amount in dB that the directional gain of the antenna exceeds 6 dBi.

#### 6.3.2. Test Procedure

ANSI C63.10 - 2013 - Section 11.9.2.3.2

#### 6.3.3. Test Setting

##### Average Power Measurement

Average power measurements were performed only when the EUT was transmitting at its maximum power control level using a broadband power meter with a pulse sensor. The power meter implemented triggering and gating capabilities which were set up such that power measurements were recorded only during the ON time of the transmitter.

#### 6.3.4. Test Setup



#### 6.3.5. Test Result

Refer to Appendix A.3.

## 6.4. Power Spectral Density Measurement

### 6.4.1. Test Limit

The maximum permissible power spectral density is 8dBm in any 3 kHz band.

The same method of determining the conducted output power shall be used to determine the power spectral density.

### 6.4.2. Test Procedure

ANSI C63.10 - 2013 - Section 11.10.5

### 6.4.3. Test Setting

1. Measure the duty cycle (x) of the transmitter output signal.
2. Set instrument center frequency to DTS channel center frequency.
3. Set span to at least 1.5 times the OBW.
4. RBW = 10 kHz.
5. VBW = 30 kHz.
6. Detector = RMS.
7. Ensure that the number of measurement points in the sweep  $\geq 2 \times \text{span}/\text{RBW}$ .
8. Sweep time = auto couple.
9. Don't use sweep triggering. Allow sweep to "free run".
10. Employ trace averaging (RMS) mode over a minimum of 100 traces.
11. Use the peak marker function to determine the maximum amplitude level.
12. Add  $10 \log (1/x)$ , where x is the duty cycle measured in step (a), to the measured PSD to compute the average PSD during the actual transmission time. If measured value exceeds requirement specified by regulatory agency, then reduce RBW (but no less than 3 kHz) and repeat (note that this may require zooming in on the emission of interest and reducing the span to meet the minimum measurement point requirement as the RBW is reduced).

### 6.4.4. Test Setup

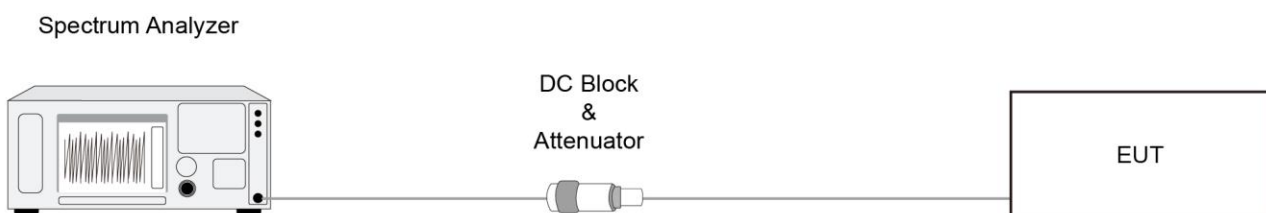



#### **6.4.5. Test Result**

Refer to Appendix A.4.

## **6.5. Conducted Band Edge and Out-of-Band Emissions Measurement**

### **6.5.1. Test Limit**

The limit for out-of-band spurious emissions at the band edge is 20dB below the fundamental emission level, as determined from the in-band power measurement of the DTS channel performed in a 100 kHz bandwidth per the PSD procedure.

### **6.5.2. Test Procedure**

ANSI C63.10-2013 - Section 11.11

### **6.5.3. Test Setting**

#### **Reference level measurement**

1. Set instrument center frequency to DTS channel center frequency
2. Set the span to  $\geq 1.5$  times the DTS bandwidth
3. Set the RBW = 100 kHz
4. Set the VBW  $\geq 3 \times$  RBW
5. Detector = peak
6. Sweep time = auto couple
7. Trace mode = max hold
8. Allow trace to fully stabilize

#### **Emission level measurement**

1. Set the center frequency and span to encompass frequency range to be measured
2. RBW = 100kHz
3. VBW = 300kHz
4. Detector = Peak
5. Trace mode = max hold
6. Sweep time = auto couple
7. The trace was allowed to stabilize

#### 6.5.4. Test Setup

Spectrum Analyzer

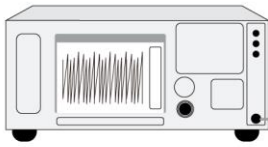

DC Block  
&  
Attenuator



#### 6.5.5. Test Result

Refer to Appendix A.5.

## 6.6. Radiated Spurious Emission Measurement

### 6.6.1. Test Limit

All out of band emissions appearing in a restricted band as specified in Section 15.205 of the Title 47 CFR must not exceed the limits shown in Table per Section 15.209.

FCC Part 15 Subpart C Paragraph 15.209		
Frequency [MHz]	Field Strength [uV/m]	Measured Distance [Meters]
0.009 - 0.490	2400/F (kHz)	300
0.490 - 1.705	24000/F (kHz)	30
1.705 - 30	30	30
30 - 88	100	3
88 - 216	150	3
216 - 960	200	3
Above 960	500	3

### 6.6.2. Test Procedure

ANSI C63.10 - 2013 - Section 11.11 & 11.12

ANSI C63.10 - 2013 - Section 6.3 (General Requirements)

ANSI C63.10 - 2013 - Section 6.4 (Standard test method below 30MHz)

ANSI C63.10 - 2013 - Section 6.5 (Standard test method above 30MHz to 1GHz)

ANSI C63.10 - 2013 - Section 6.6 (Standard test method above 1GHz)

### 6.6.3. Test Setting

**Table 1 - RBW as a function of frequency**

Frequency	RBW
9 ~ 150 kHz	200 ~ 300 Hz
0.15 ~ 30 MHz	9 ~ 10 kHz
30 ~ 1000 MHz	100 ~ 120 kHz
> 1000MHz	1MHz

**Quasi-Peak Measurements below 1GHz**

1. Analyzer center frequency was set to the frequency of the radiated spurious emission of interest
2. Span was set greater than 1MHz
3. RBW = as specified in Table 1
4. Detector = CISPR quasi-peak
5. Sweep time = auto couple
6. Trace was allowed to stabilize

**Peak Measurements above 1GHz**

1. Analyzer center frequency was set to the frequency of the radiated spurious emission of interest
2. RBW = 1MHz
3. VBW = 3MHz
4. Detector = peak
5. Sweep time = auto couple
6. Trace mode = max hold
7. Trace was allowed to stabilize

**Average Measurements above 1GHz (Method VB)**

1. Analyzer center frequency was set to the frequency of the radiated spurious emission of interest
2. RBW = 1MHz
3. VBW; If the EUT is configured to transmit with duty cycle  $\geq 98\%$ , set VBW = 10 Hz.  
If the EUT duty cycle is  $< 98\%$ , set VBW  $\geq 1/T$ . T is the minimum transmission duration.
4. Detector = Peak
5. Sweep time = auto
6. Trace mode = max hold
7. Trace was allowed to stabilize

### 6.6.4. Test Setup

Below 1GHz Test Setup:

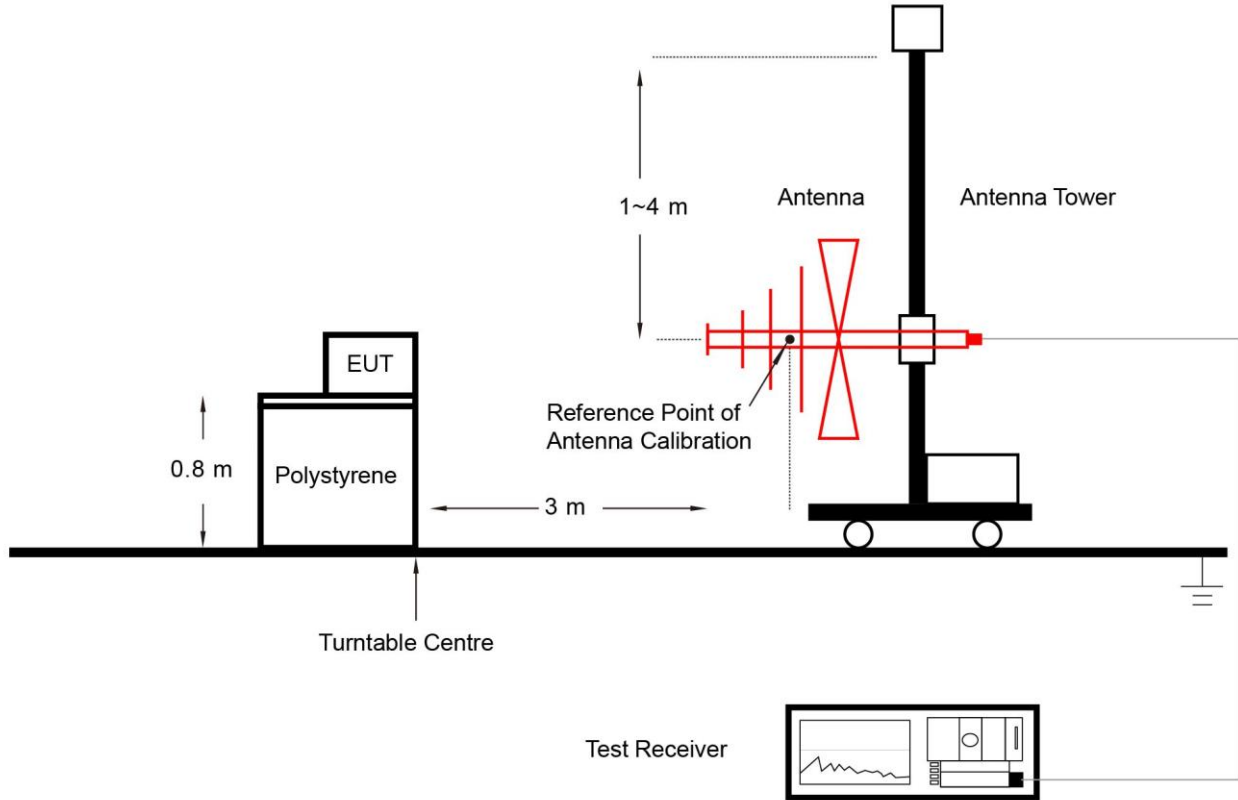

Above 1GHz Test Setup:

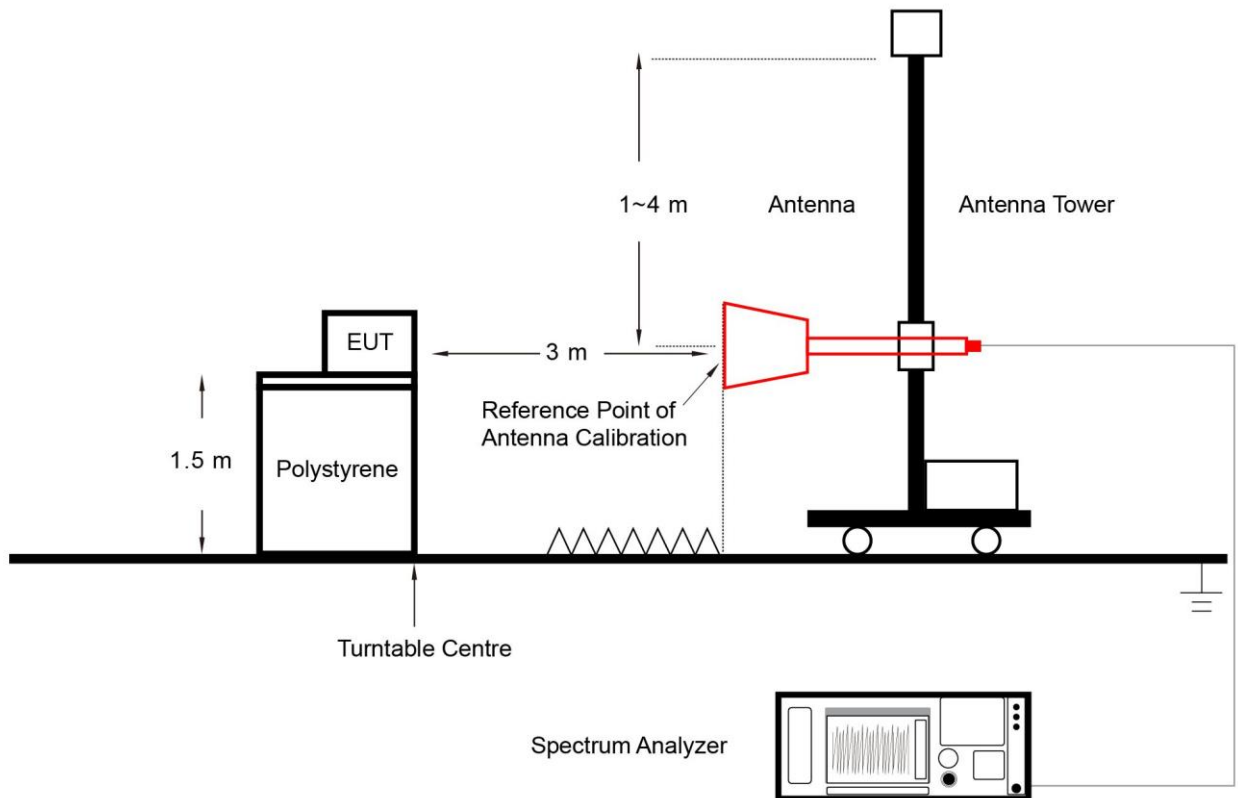

### **6.6.5. Test Result**

Refer to Appendix A.6.

## 6.7. Radiated Restricted Band Edge Measurement

### 6.7.1. Test Limit

#### For 15.205 requirement:

Radiated emissions which fall in the restricted bands, as defined in Section 15.205(a) of FCC part 15, must also comply with the radiated emission limits specified in Section 15.209(a).

Frequency (MHz)	Frequency (MHz)	Frequency (MHz)	Frequency (GHz)
0.090 - 0.110	16.42 - 16.423	399.9 - 410	4.5 - 5.15
<sup>1</sup> 0.495 - 0.505	16.69475 - 16.69525	608 - 614	5.35 - 5.46
2.1735 - 2.1905	16.80425 - 16.80475	960 - 1240	7.25 - 7.75
4.125 - 4.128	25.5 - 25.67	1300 - 1427	8.025 - 8.5
4.17725 - 4.17775	37.5 - 38.25	1435 - 1626.5	9.0 - 9.2
4.20725 - 4.20775	73 - 74.6	1645.5 - 1646.5	9.3 - 9.5
6.215 - 6.218	74.8 - 75.2	1660 - 1710	10.6 - 12.7
6.26775 - 6.26825	108 - 121.94	1718.8 - 1722.2	13.25 - 13.4
6.31175 - 6.31225	123 - 138	2200 - 2300	14.47 - 14.5
8.291 - 8.294	149.9 - 150.05	2310 - 2390	15.35 - 16.2
8.362 - 8.366	156.52475 - 156.52525	2483.5 - 2500	17.7 - 21.4
8.37625 - 8.38675	156.7 - 156.9	2690 - 2900	22.01 - 23.12
8.41425 - 8.41475	162.0125 - 167.17	3260 - 3267	23.6 - 24.0
12.29 - 12.293	167.72 - 173.2	3332 - 3339	31.2 - 31.8
12.51975 - 12.52025	240 - 285	3345.8 - 3358	36.43 - 36.5
12.57675 - 12.57725	322 - 335.4	3600 - 4400	( <sup>2</sup> )
13.36 - 13.41	--	--	--



All out of band emissions appearing in a restricted band as specified in Section 15.205 of the Title 47CFR must not exceed the limits shown in Table per Section 15.209.

FCC Part 15 Subpart C Paragraph 15.209		
Frequency [MHz]	Field Strength [uV/m]	Measured Distance [Meters]
0.009 - 0.490	2400/F (kHz)	300
0.490 - 1.705	24000/F (kHz)	30
1.705 - 30	30	30
30 - 88	100	3
88 - 216	150	3
216 - 960	200	3
Above 960	500	3

### 6.7.2. Test Procedure

ANSI C63.10-2013 Section 6.3 & 6.6 & 11.13

### 6.7.3. Test Setting

#### Peak Field Strength Measurements

1. Analyzer center frequency was set to the frequency of the radiated spurious emission of interest
2. RBW = 1MHz
3. VBW = 3MHz
4. Detector = peak
5. Sweep time = auto couple
6. Trace mode = max hold
7. Trace was allowed to stabilize

### Average Field Strength Measurements

1. Analyzer center frequency was set to the frequency of the radiated spurious emission of interest
2. RBW = 1MHz
3. VBW  $\geq 1/T$
4. As an alternative, the instrument may be set to linear detector mode. Ensure that video filtering is applied in linear voltage domain (rather than in a log or dB domain). Some instruments require linear display mode in order to accomplish this. Others have a setting for Average-VBW Type, which can be set to "Voltage" regardless of the display mode
5. Detector = Peak
6. Sweep time = auto
7. Trace mode = max hold
8. Allow max hold to run for at least 50 times (1/duty cycle) traces

#### 6.7.4. Test Setup

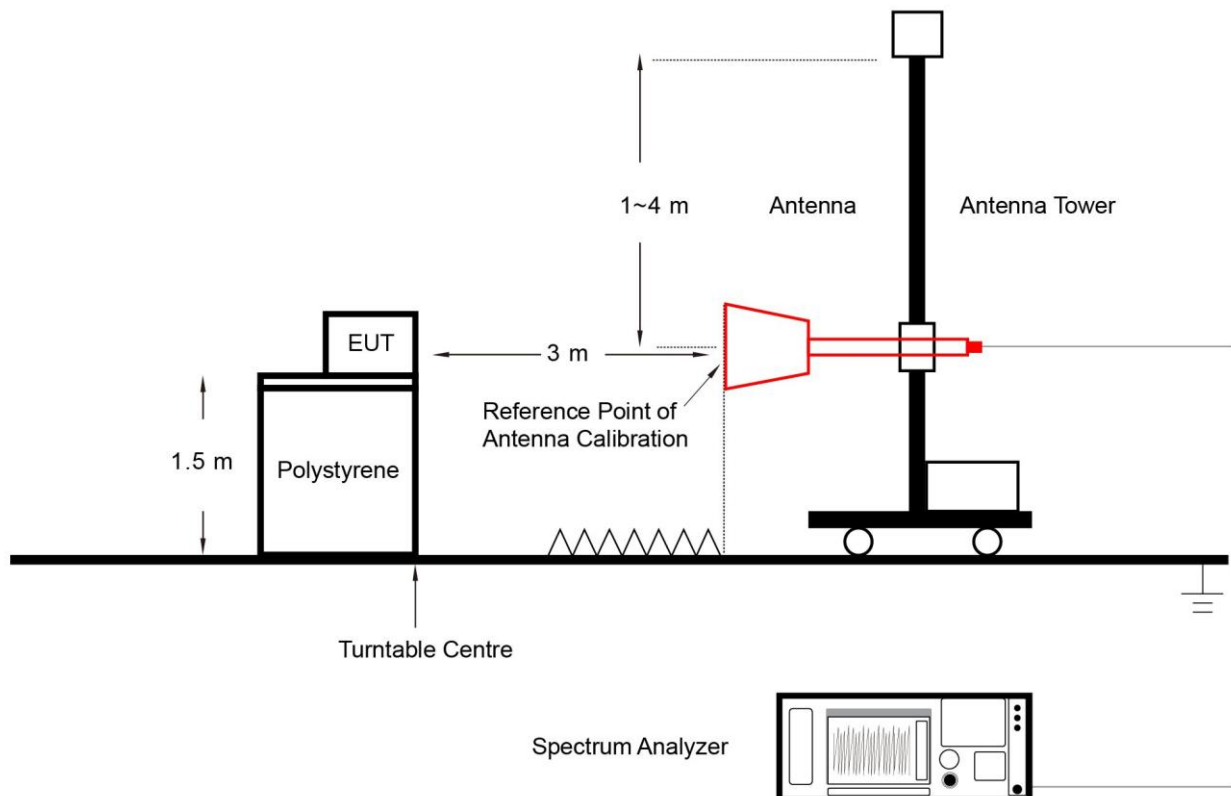

#### 6.7.5. Test Result

Refer to Appendix A.7.

## 6.8. AC Conducted Emissions Measurement

### 6.8.1. Test Limit

FCC Part 15 Subpart C Paragraph 15.207 Limits		
Frequency (MHz)	QP (dBuV)	AV (dBuV)
0.15 - 0.50	66 - 56	56 - 46
0.50 - 5.0	56	46
5.0 - 30	60	50

Note 1: The lower limit shall apply at the transition frequencies.

Note 2: The limit decreases linearly with the logarithm of the frequency in the range 0.15MHz to 0.5MHz.

### 6.8.2. Test Setup

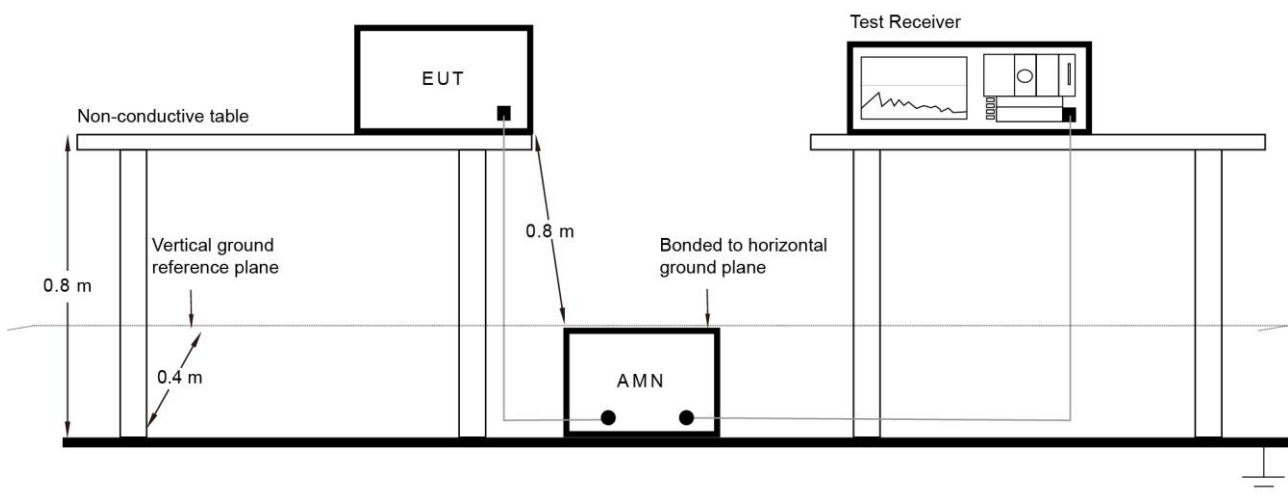

### 6.8.3. Test Result

Refer to Appendix A.8.

## Appendix A – Test Result

### A.1 Duty Cycle Test Result

Test Site	WZ-TR3	Test Engineer	Jeff Yang
Test Date	2022-11-22~2022-11-23		

Test Mode	Duty Cycle
802.11b	59.80%
802.11g	96.33%
802.11n-HT20	88.48%
802.11n-HT40	81.88%
802.11ax-HE20	91.88%
802.11ax-HE40	91.65%

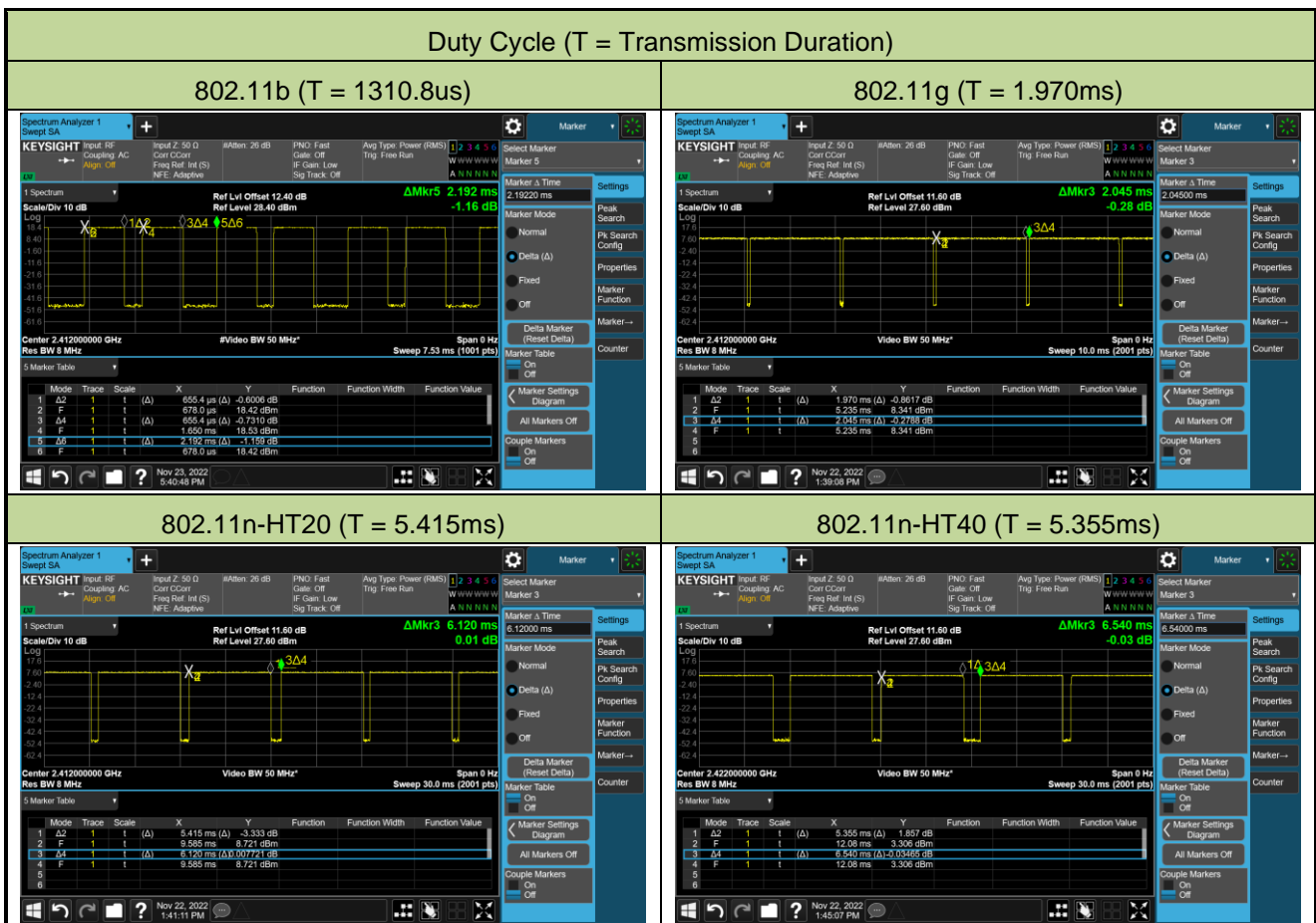

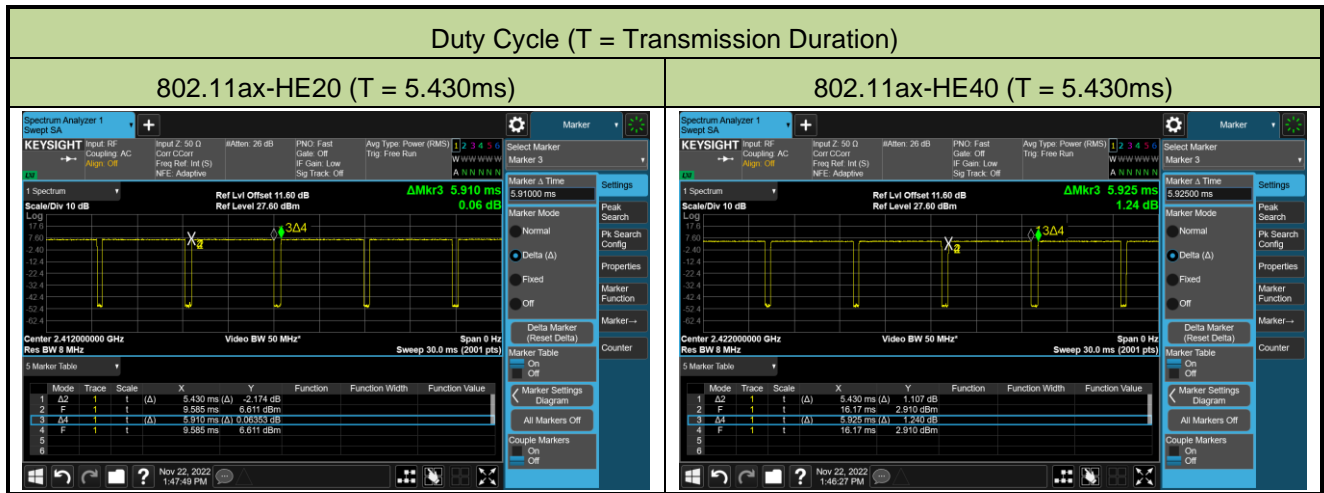

**A.2 6dB Bandwidth Test Result**

Test Site	WZ-TR3	Test Engineer	Jeff Yang
Test Date	2022-11-28		

Test Mode	Data Rate / MCS	Channel No.	Frequency (MHz)	6dB Bandwidth (MHz)	Limit (MHz)
11b	1Mbps	01	2412	8.083	≥ 0.5
11b	1Mbps	06	2437	8.112	≥ 0.5
11b	1Mbps	11	2462	8.091	≥ 0.5
11g	6Mbps	01	2412	16.37	≥ 0.5
11g	6Mbps	06	2437	16.36	≥ 0.5
11g	6Mbps	11	2462	16.36	≥ 0.5
11n-HT20	MCS0	01	2412	17.62	≥ 0.5
11n-HT20	MCS0	06	2437	17.61	≥ 0.5
11n-HT20	MCS0	11	2462	17.63	≥ 0.5
11n-HT40	MCS0	03	2422	35.05	≥ 0.5
11n-HT40	MCS0	06	2437	35.43	≥ 0.5
11n-HT40	MCS0	09	2452	35.90	≥ 0.5
11ax-HE20	MCS0	01	2412	19.06	≥ 0.5
11ax-HE20	MCS0	06	2437	19.02	≥ 0.5
11ax-HE20	MCS0	11	2462	19.02	≥ 0.5
11ax-HE40	MCS0	03	2422	37.58	≥ 0.5
11ax-HE40	MCS0	06	2437	36.84	≥ 0.5
11ax-HE40	MCS0	09	2452	37.69	≥ 0.5

802.11b 6dB Bandwidth

Channel 01 (2412MHz)



Channel 06 (2437MHz)

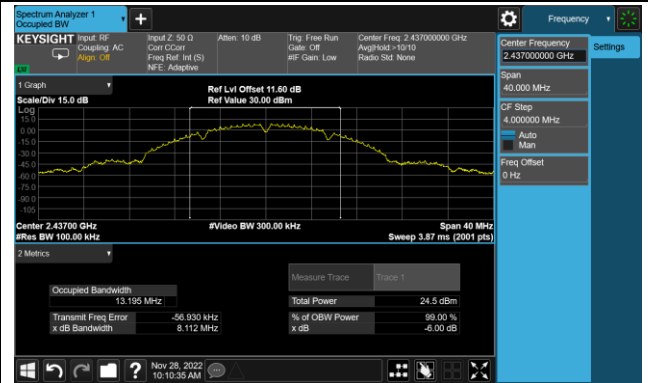

Channel 11 (2462MHz)

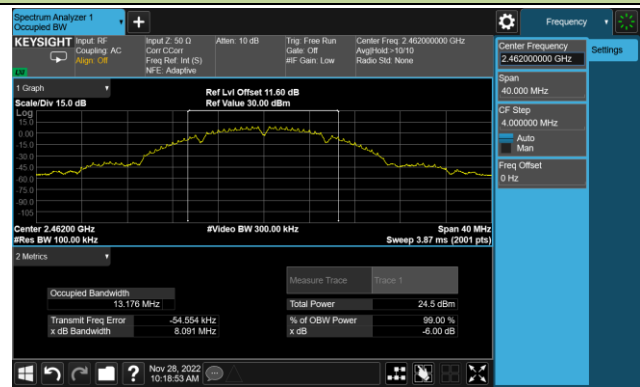

802.11g 6dB Bandwidth

Channel 01 (2412MHz)

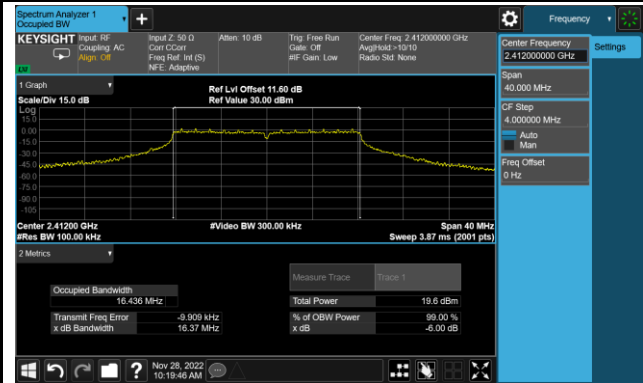

Channel 06 (2437MHz)

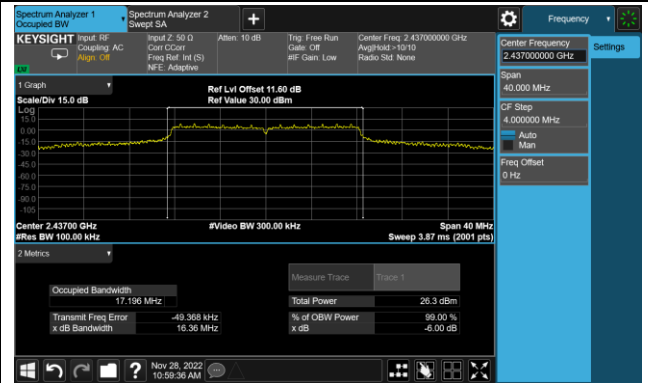

Channel 11 (2462MHz)

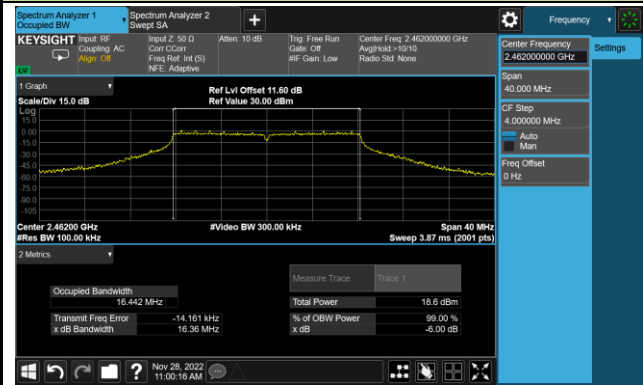



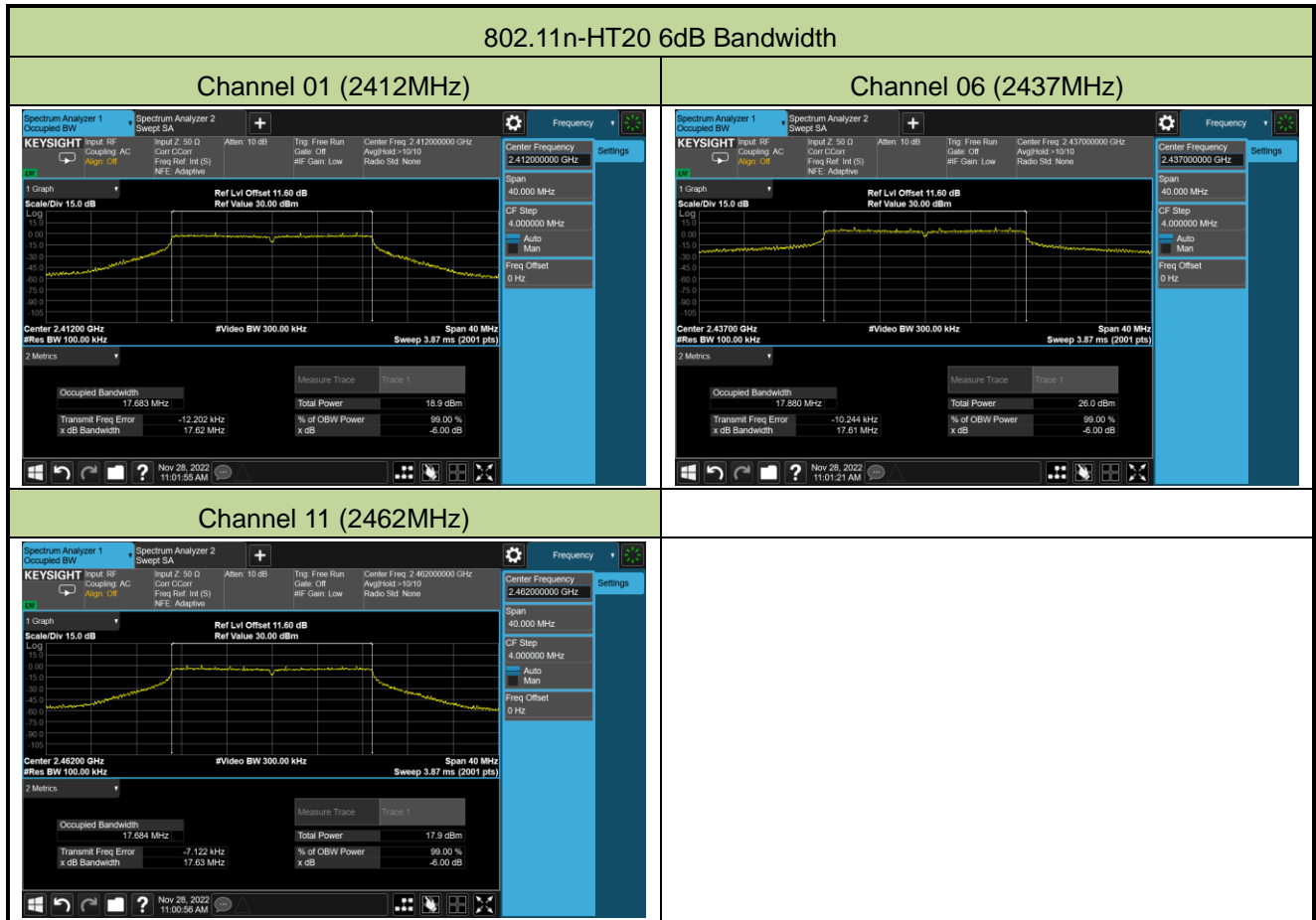

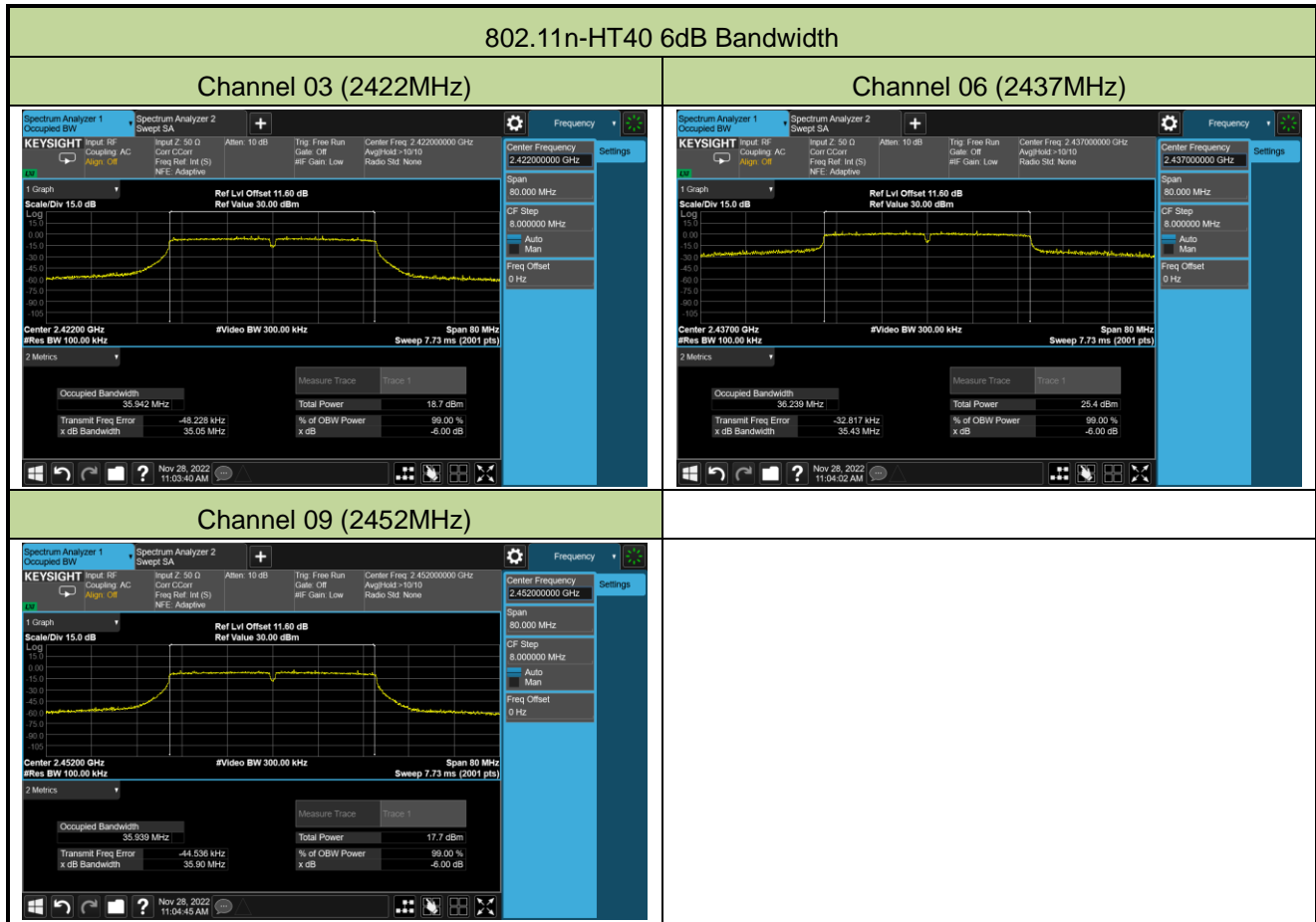

802.11ax-HE20 6dB Bandwidth

Channel 01 (2412MHz)

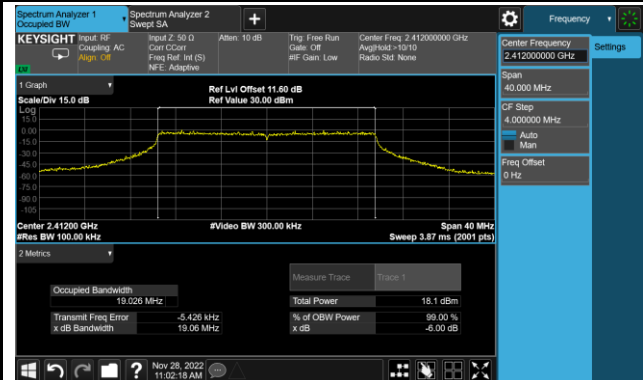

Channel 06 (2437MHz)

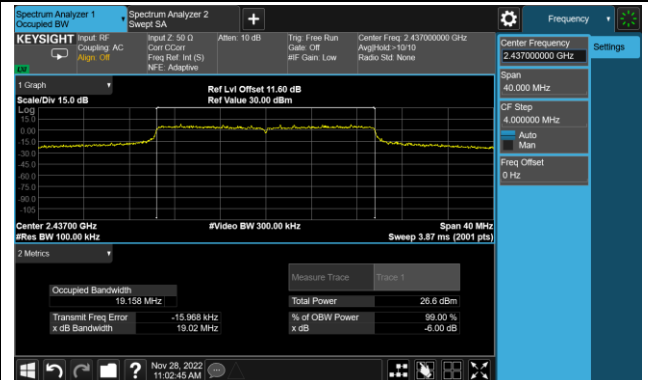

Channel 11 (2462MHz)

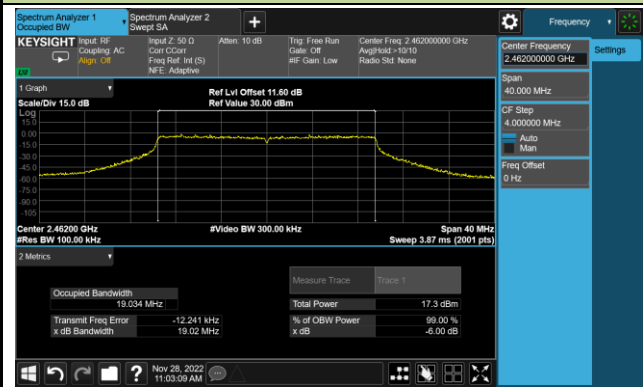

802.11ax-HE40 6dB Bandwidth

Channel 03 (2422MHz)

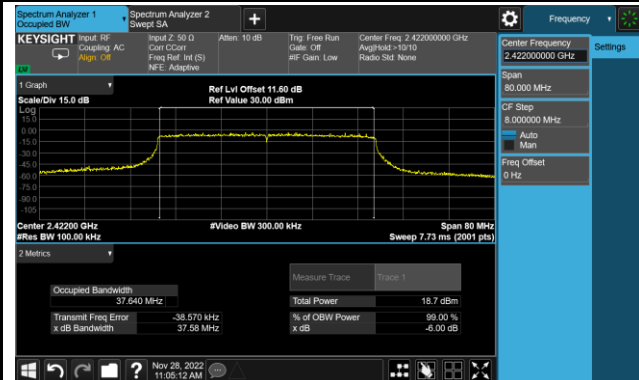

Channel 06 (2437MHz)

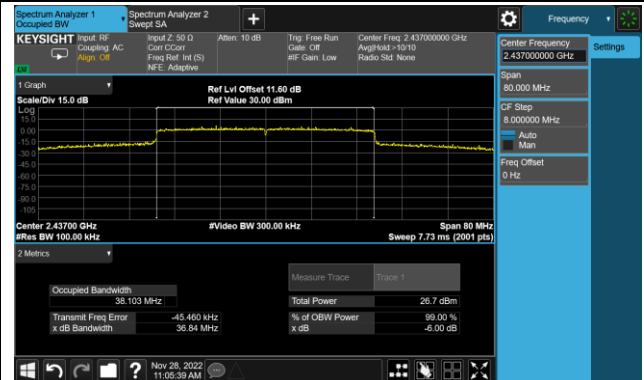

Channel 09 (2452MHz)

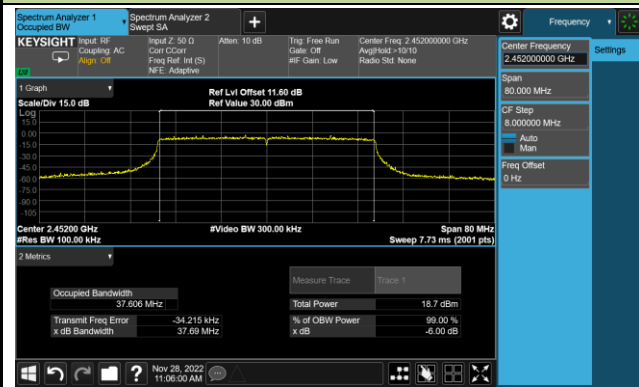

### A.3 Output Power Test Result

Spot Check Data:

Test Site	WZ-TR3	Test Engineer	Luis Yang
Test Date	2023-01-16		

Test Mode	Data Rate/ MCS	Channel No.	Freq. (MHz)	Average Power (dBm)		Total Power (dBm)	Limit (dBm)
				Ant 0	Ant 2		
11n-HT20	MCS0	06	2437	19.15	19.12	22.15	≤ 30.00
11ax-HE20	MCS0	04	2427	17.63	17.60	20.63	≤ 30.00

Note: Total Average Power (dBm) =  $10 \cdot \log \{ 10^{(\text{Ant 0 Average Power} / 10)} + 10^{(\text{Ant 2 Average Power} / 10)} \}$  (dBm).

Original Data:

Test Site	WZ-TR3	Test Engineer	Jeff Yang
Test Date	2022-11-23		

Test Mode	Data Rate/ MCS	Channel No.	Freq. (MHz)	Average Power (dBm)		Total Power (dBm)	Limit (dBm)
				Ant 0	Ant 2		
11b	1Mbps	01	2412	18.82	18.60	21.72	≤ 30.00
11b	1Mbps	06	2437	17.71	17.92	20.83	≤ 30.00
11b	1Mbps	11	2462	17.32	17.52	20.43	≤ 30.00
11g	6Mbps	01	2412	12.54	12.80	15.68	≤ 30.00
11g	6Mbps	02	2417	15.18	14.79	18.00	≤ 30.00
11g	6Mbps	03	2422	16.75	16.71	19.74	≤ 30.00
11g	6Mbps	04	2427	17.41	17.59	20.51	≤ 30.00
11g	6Mbps	06	2437	19.45	20.02	22.75	≤ 30.00
11g	6Mbps	08	2447	18.23	18.13	21.19	≤ 30.00
11g	6Mbps	09	2452	16.57	16.60	19.60	≤ 30.00
11g	6Mbps	10	2457	16.13	16.17	19.16	≤ 30.00
11g	6Mbps	11	2462	12.68	12.68	15.69	≤ 30.00
11n-HT20	MCS0	01	2412	12.48	12.79	15.65	≤ 30.00
11n-HT20	MCS0	02	2417	15.48	15.37	18.44	≤ 30.00
11n-HT20	MCS0	03	2422	16.28	16.39	19.35	≤ 30.00
11n-HT20	MCS0	04	2427	17.46	17.31	20.40	≤ 30.00
11n-HT20	MCS0	06	2437	19.54	19.94	22.75	≤ 30.00
11n-HT20	MCS0	08	2447	17.68	17.94	20.82	≤ 30.00
11n-HT20	MCS0	09	2452	16.27	16.43	19.36	≤ 30.00

11n-HT20	MCS0	10	2457	15.41	15.46	18.45	≤ 30.00
11n-HT20	MCS0	11	2462	11.96	12.03	15.01	≤ 30.00
11n-HT40	MCS0	03	2422	11.97	12.27	15.13	≤ 30.00
11n-HT40	MCS0	06	2437	14.83	14.75	17.80	≤ 30.00
11n-HT40	MCS0	09	2452	11.72	11.68	14.71	≤ 30.00
11ax-HE20	MCS0	01	2412	11.37	11.42	14.41	≤ 30.00
11ax-HE20	MCS0	02	2417	14.85	14.62	17.75	≤ 30.00
11ax-HE20	MCS0	03	2422	16.68	16.82	19.76	≤ 30.00
11ax-HE20	MCS0	04	2427	18.21	18.34	21.29	≤ 30.00
11ax-HE20	MCS0	06	2437	19.33	19.56	22.46	≤ 30.00
11ax-HE20	MCS0	08	2447	18.03	18.30	21.18	≤ 30.00
11ax-HE20	MCS0	09	2452	17.67	17.83	20.76	≤ 30.00
11ax-HE20	MCS0	10	2457	14.74	14.70	17.73	≤ 30.00
11ax-HE20	MCS0	11	2462	10.74	10.64	13.70	≤ 30.00
11ax-HE40	MCS0	03	2422	11.69	11.66	14.69	≤ 30.00
11ax-HE40	MCS0	06	2437	14.19	14.15	17.18	≤ 30.00
11ax-HE40	MCS0	09	2452	12.24	12.35	15.31	≤ 30.00

Note: Total Average Power (dBm) =  $10 \cdot \log \{ 10^{(\text{Ant 0 Average Power} / 10)} + 10^{(\text{Ant 2 Average Power} / 10)} \}$  (dBm).

**A.4 Power Spectral Density Test Result**

Test Site	WZ-TR3	Test Engineer	Jeff Yang
Test Date	2022-11-28		

Test Mode	Data Rate/ MCS	Channel No.	Freq. (MHz)	PSD (dBm / 10kHz)		Total PSD (dBm/10kHz)	Limit (dBm / 3kHz)	Result
				Ant 0	Ant 2			
11b	1Mbps	01	2412	-8.54	-8.48	-3.27	≤ 4.99	Pass
11b	1Mbps	06	2437	-7.28	-5.92	-1.30	≤ 4.99	Pass
11b	1Mbps	11	2462	-8.66	-9.04	-3.60	≤ 4.99	Pass
11g	6Mbps	01	2412	-19.76	-19.60	-16.51	≤ 4.99	Pass
11g	6Mbps	06	2437	-8.90	-8.61	-5.58	≤ 4.99	Pass
11g	6Mbps	11	2462	-15.81	-15.67	-12.57	≤ 4.99	Pass
11n-HT20	MCS0	01	2412	16.18	-16.09	-12.59	≤ 4.99	Pass
11n-HT20	MCS0	06	2437	-9.26	-9.19	-5.68	≤ 4.99	Pass
11n-HT20	MCS0	11	2462	-17.58	-16.85	-13.66	≤ 4.99	Pass
11n-HT40	MCS0	03	2422	-19.85	-19.56	-15.82	≤ 4.99	Pass
11n-HT40	MCS0	06	2437	-18.14	-17.74	-14.06	≤ 4.99	Pass
11n-HT40	MCS0	09	2452	-21.05	-20.62	-16.95	≤ 4.99	Pass
11ax-HE20	MCS0	01	2412	-18.68	-18.37	-15.14	≤ 4.99	Pass
11ax-HE20	MCS0	06	2437	-10.99	-10.34	-7.27	≤ 4.99	Pass
11ax-HE20	MCS0	11	2462	-19.73	-19.22	-16.09	≤ 4.99	Pass
11ax-HE40	MCS0	03	2422	-21.43	-20.99	-17.81	≤ 4.99	Pass
11ax-HE40	MCS0	06	2437	-20.07	-19.37	-16.32	≤ 4.99	Pass
11ax-HE40	MCS0	09	2452	-20.84	-20.63	-17.34	≤ 4.99	Pass

802.11b - PSD – Ant 0

Channel 01 (2412MHz)

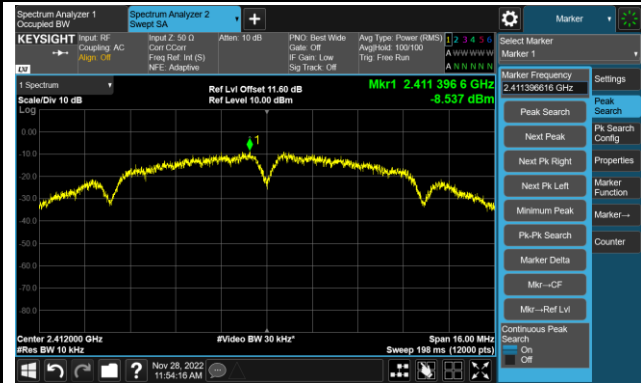

Channel 06 (2437MHz)

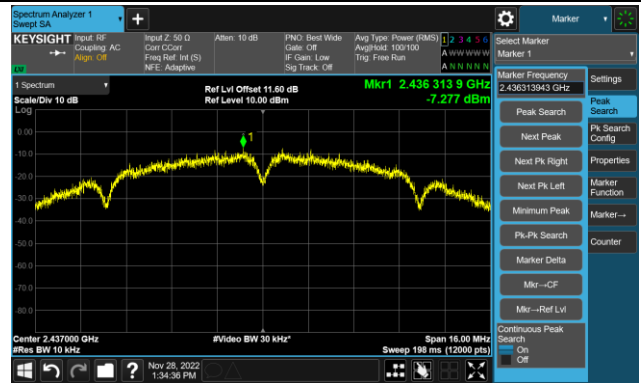

Channel 11 (2462MHz)

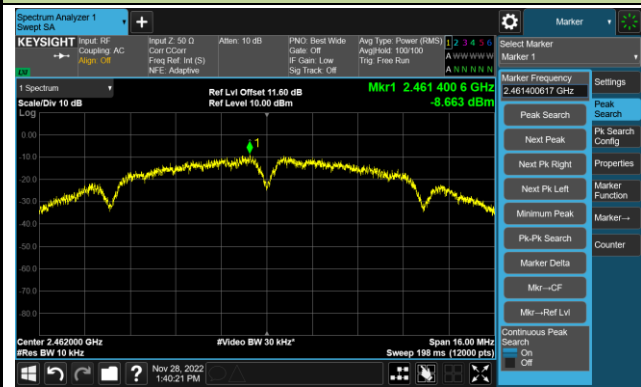



802.11g - PSD – Ant 0

Channel 01 (2412MHz)

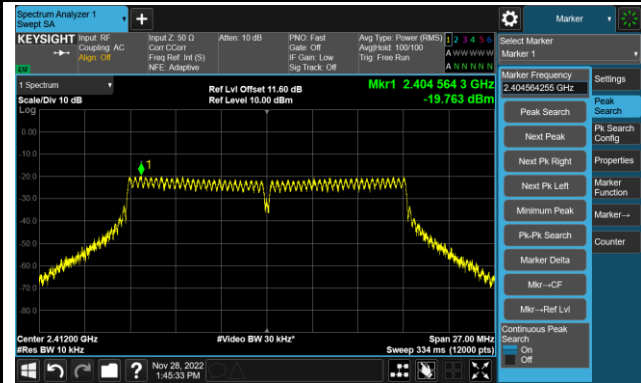

Channel 06 (2437MHz)

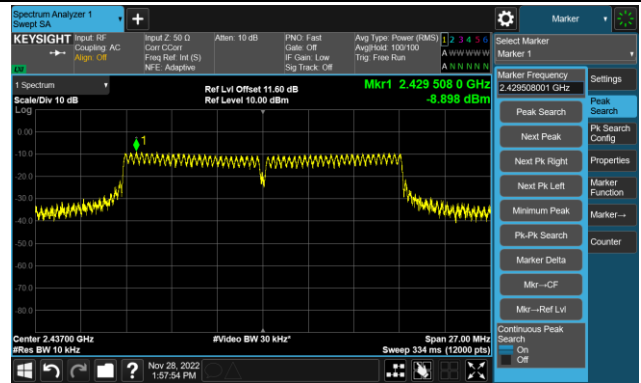

Channel 11 (2462MHz)

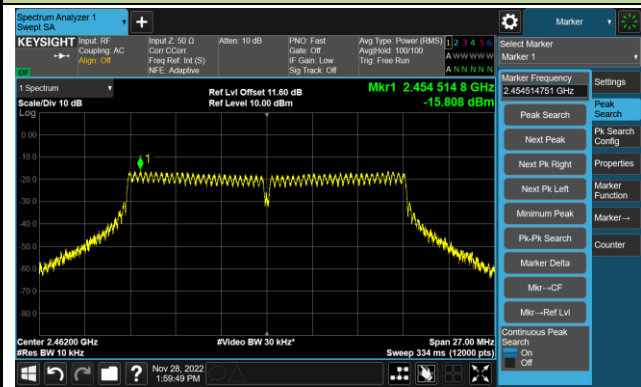

802.11n-HT20 - PSD – Ant 0

Channel 01 (2412MHz)

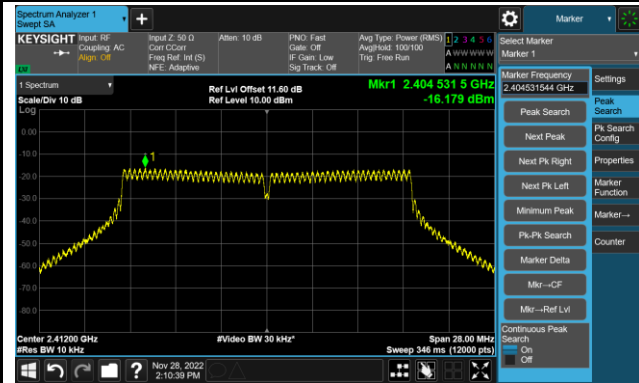

Channel 06 (2437MHz)

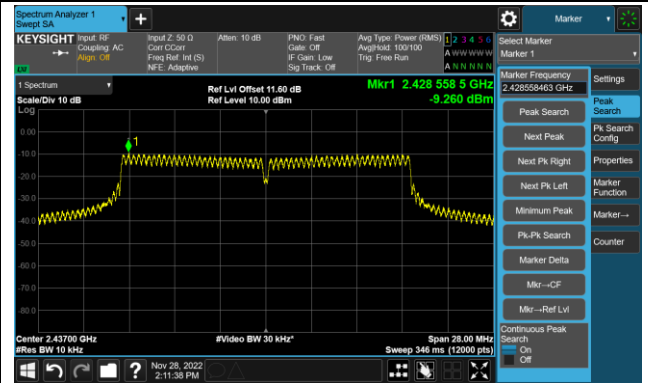

Channel 11 (2462MHz)



802.11n-HT40 - PSD – Ant 0

Channel 03 (2422MHz)

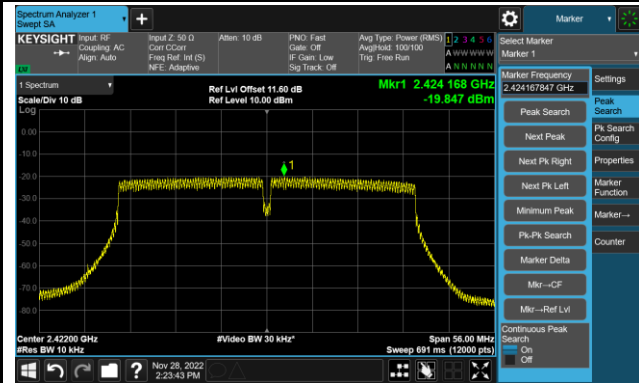

Channel 06 (2437MHz)

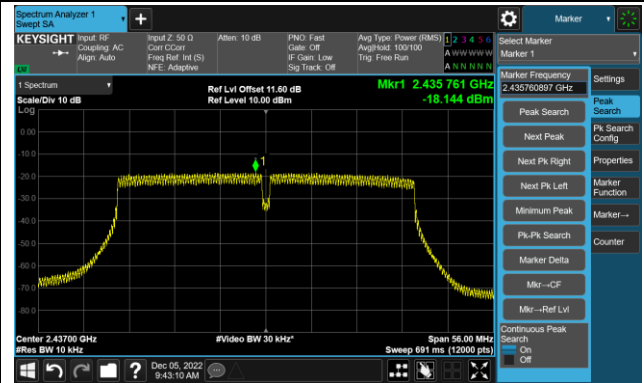

Channel 09 (2452MHz)



802.11ax-HE20 - PSD – Ant 0

Channel 01 (2412MHz)

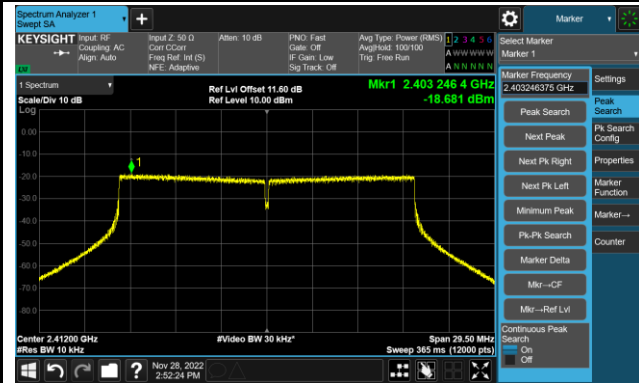

Channel 06 (2437MHz)

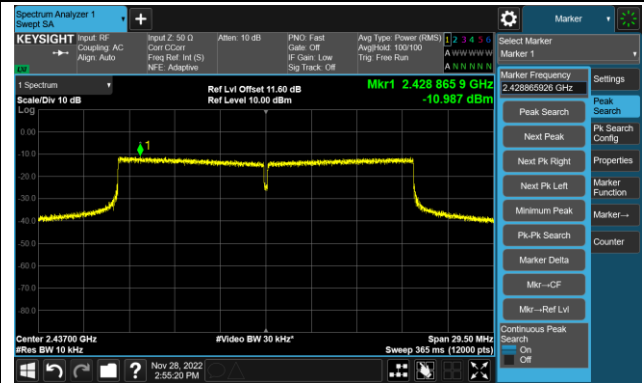

Channel 11 (2462MHz)

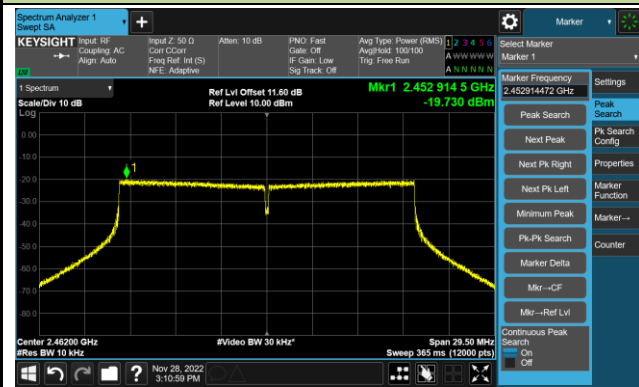

802.11ax-HE40 - PSD – Ant 0

Channel 03 (2422MHz)



Channel 06 (2437MHz)



Channel 09 (2452MHz)

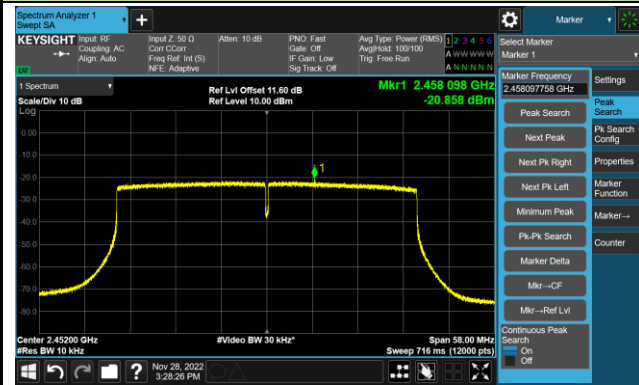

802.11b - PSD – Ant 2

Channel 01 (2412MHz)

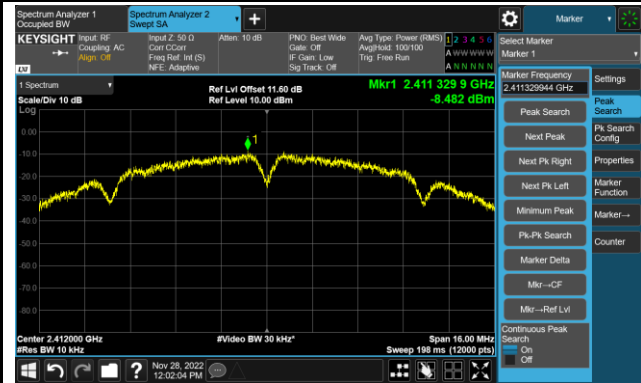

Channel 06 (2437MHz)

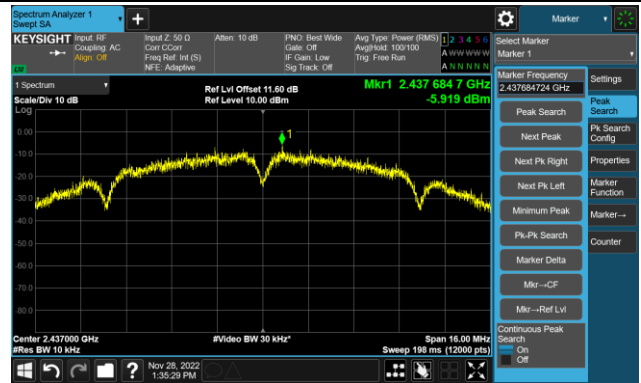

Channel 11 (2462MHz)

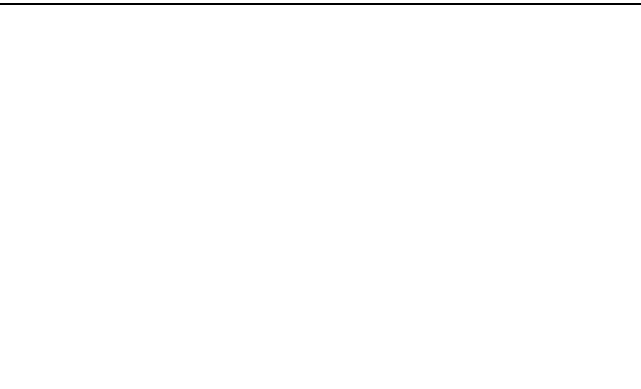

802.11g - PSD – Ant 2

Channel 01 (2412MHz)

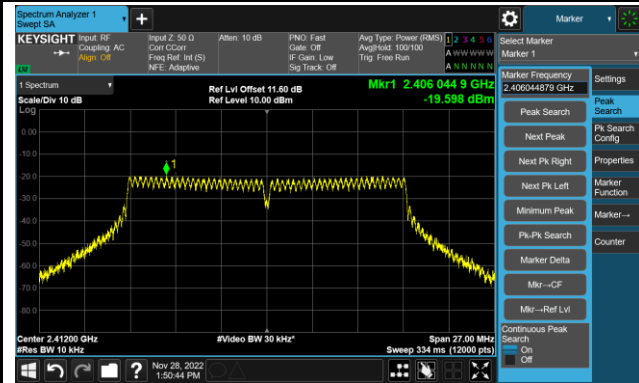

Channel 06 (2437MHz)

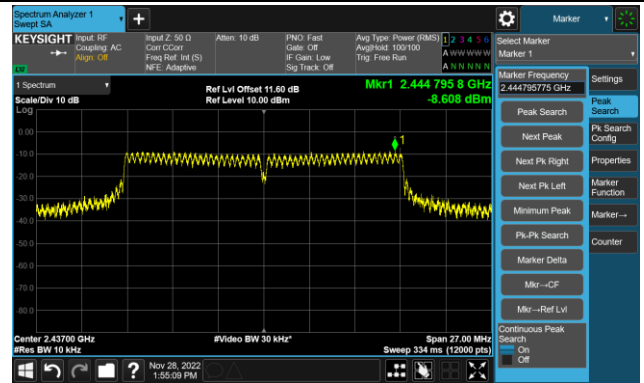

Channel 11 (2462MHz)

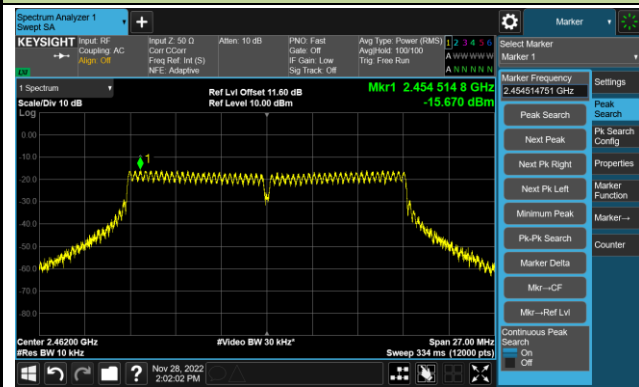

802.11n-HT20 - PSD – Ant 2

Channel 01 (2412MHz)

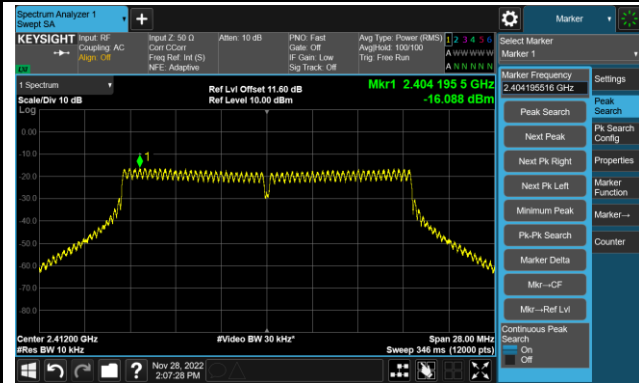

Channel 06 (2437MHz)

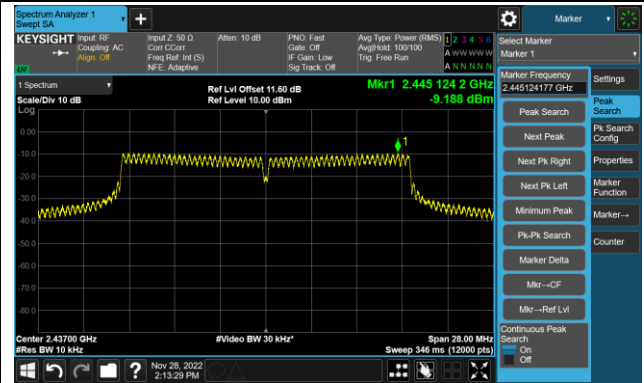

Channel 11 (2462MHz)

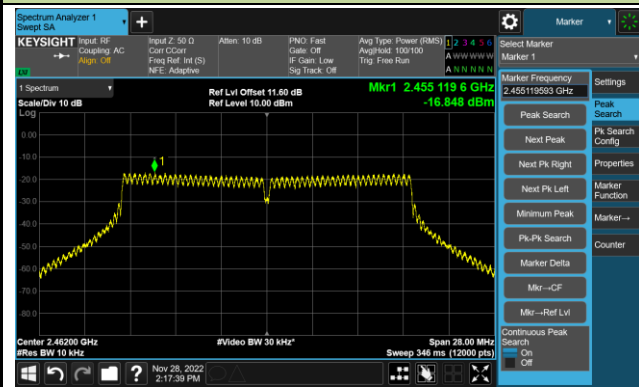



802.11n-HT40 - PSD – Ant 2

Channel 03 (2422MHz)

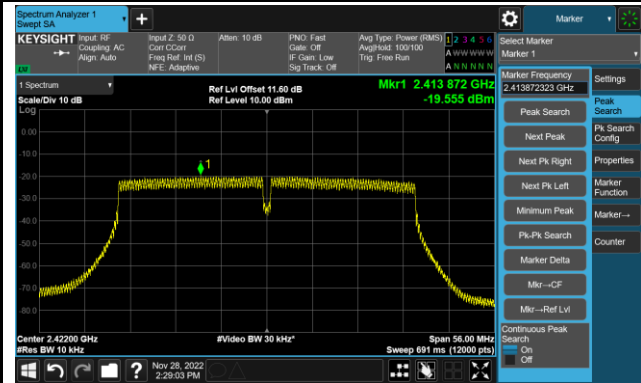

Channel 06 (2437MHz)

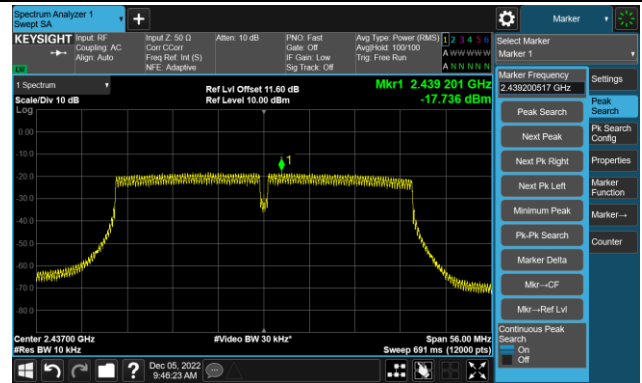

Channel 09 (2452MHz)

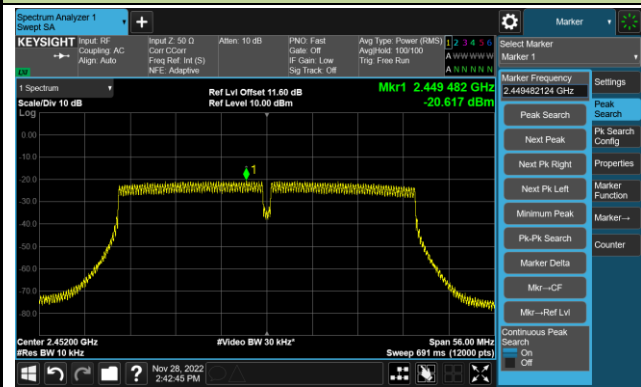

802.11ax-HE20 - PSD – Ant 2

Channel 01 (2412MHz)

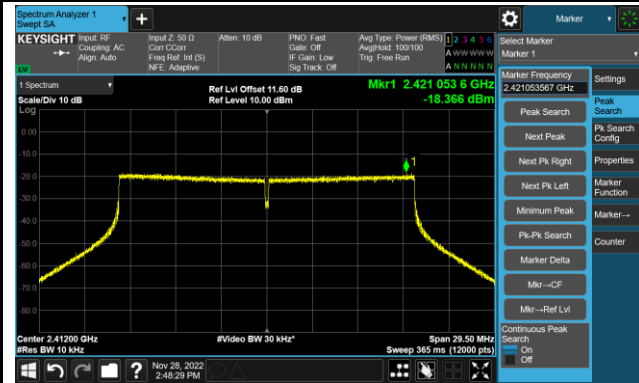

Channel 06 (2437MHz)

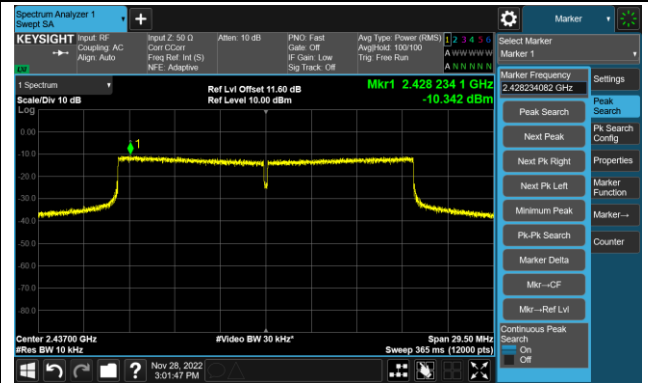

Channel 11 (2462MHz)

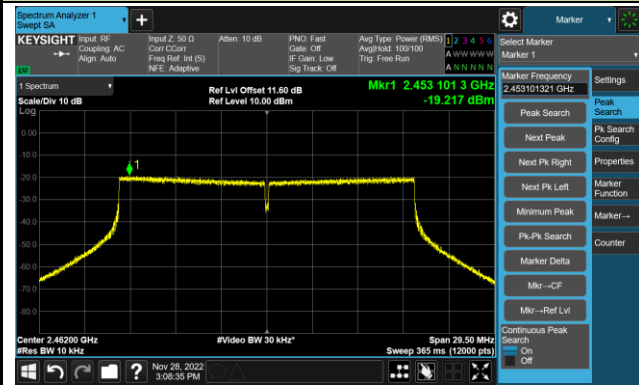

802.11ax-HE40 - PSD – Ant 2

Channel 03 (2422MHz)

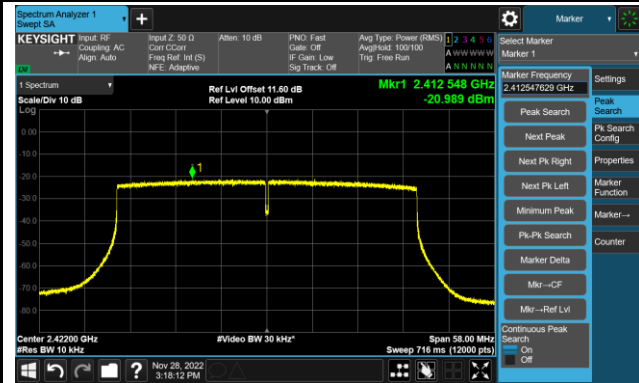

Channel 06 (2437MHz)

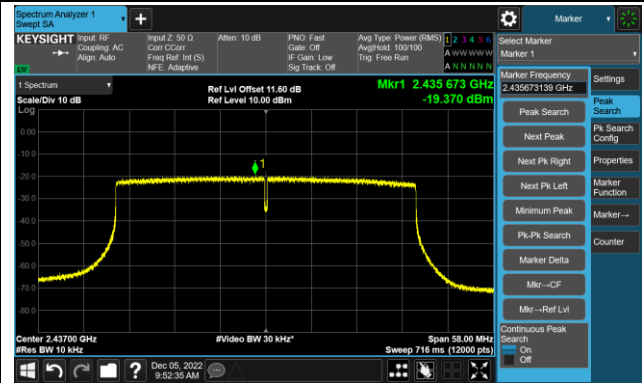

Channel 09 (2452MHz)

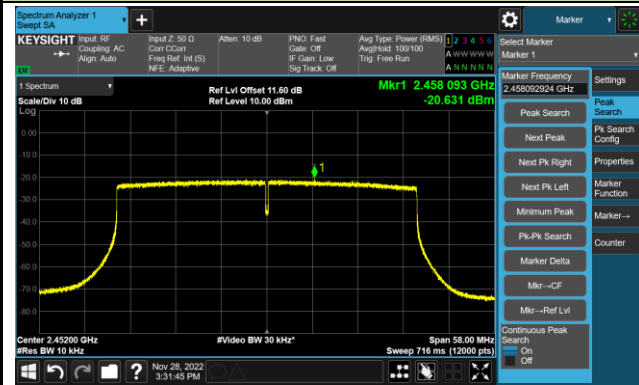

**A.5 Conducted Band Edge and Out-of-Band Emissions Test Result**

Test Site	WZ-TR3	Test Engineer	Jeff Yang
Test Date	2022-11-28~2022-11-29		

Test Mode	Data Rate / MCS	Channel No.	Frequency (MHz)	Limit
11b	1Mbps	01	2412	30dBc
11b	1Mbps	06	2437	30dBc
11b	1Mbps	11	2462	30dBc
11g	6Mbps	01	2412	30dBc
11g	6Mbps	06	2437	30dBc
11g	6Mbps	11	2462	30dBc
11n-HT20	MCS0	01	2412	30dBc
11n-HT20	MCS0	06	2437	30dBc
11n-HT20	MCS0	11	2462	30dBc
11n-HT40	MCS0	03	2422	30dBc
11n-HT40	MCS0	06	2437	30dBc
11n-HT40	MCS0	09	2452	30dBc
11ax-HE20	MCS0	01	2412	30dBc
11ax-HE20	MCS0	06	2437	30dBc
11ax-HE20	MCS0	11	2462	30dBc
11ax-HE40	MCS0	03	2422	30dBc
11ax-HE40	MCS0	06	2437	30dBc
11ax-HE40	MCS0	09	2452	30dBc

## 802.11b Out-of-Band Emissions – Ant 0

## Channel 01 (2412MHz)

## 100kHz PSD Reference Level

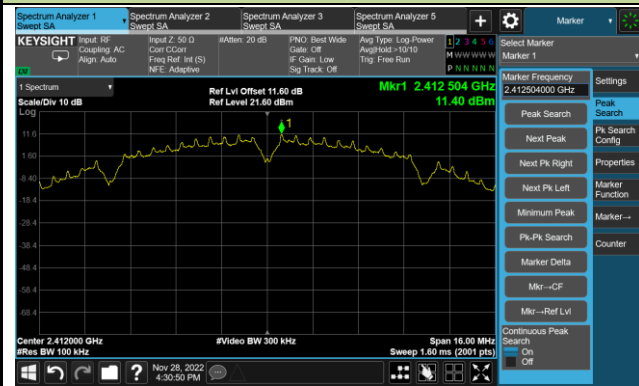

## Low Band Edge

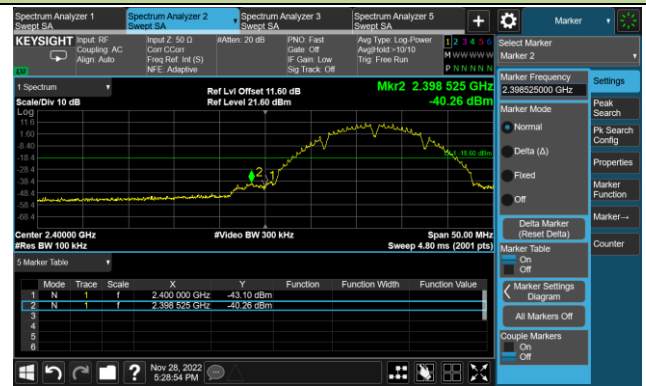

## Spurious Emission

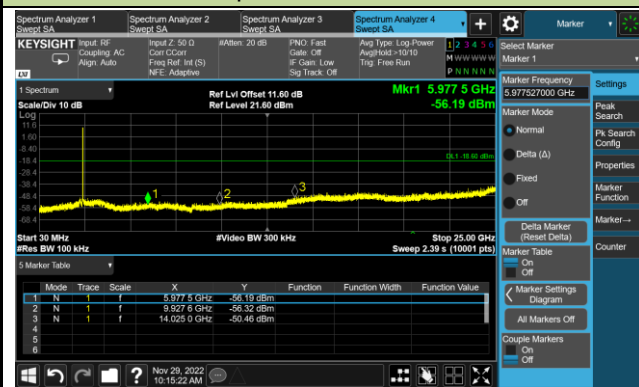

## Channel 06 (2437MHz)

## 100kHz PSD Reference Level



## Spurious Emission

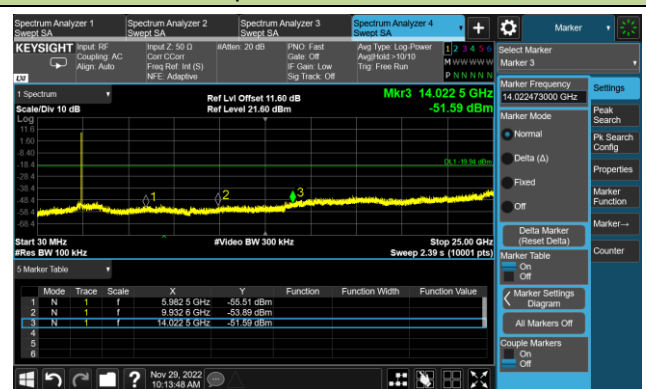

### 802.11b Out-of-Band Emissions – Ant 0

#### Channel 11 (2462MHz)

##### 100kHz PSD Reference Level

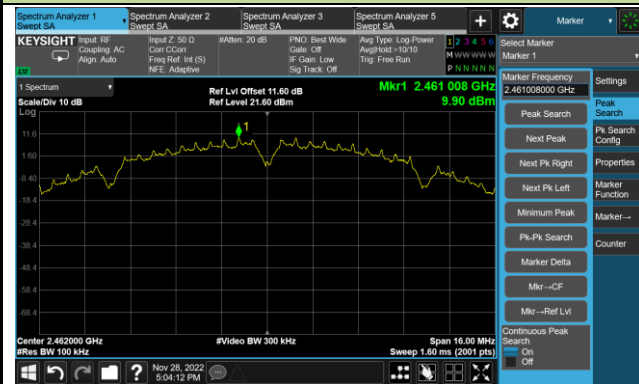

##### High Band Edge

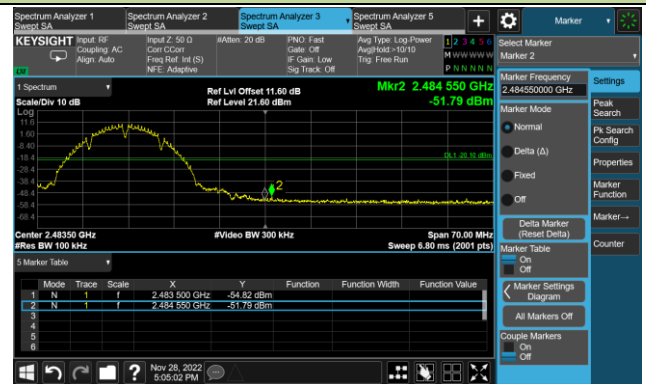

##### Spurious Emission

