

|  |                          |
|--|--------------------------|
| Site: AC2  | Time: 2016/08/25 - 10:24 |
| Limit: FCC_Part15.209_RE(3m)                                     | Engineer: Bruce Wang     |
| Probe: BBHA9120D_1-18GHz   | Polarity: Horizontal     |
| EUT: WIRELESS-ABGN 2X2 NETWORK MINIPCIE ADAPTER                  | Power: AC 120V/60Hz      |
| Test Mode: Transmit by 802.11n-HT20 at Channel 5500MHz Ant 0 + 1 |                          |

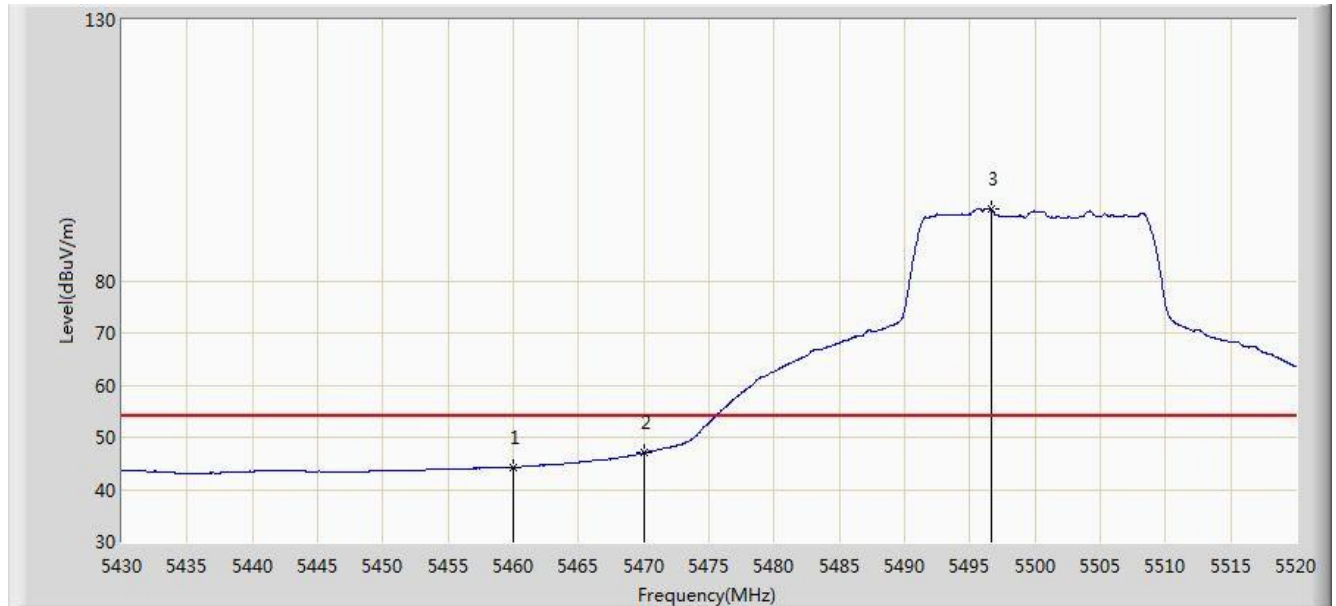

| No | Flag | Mark | Frequency (MHz) | Measure Level (dBuV/m) | Reading Level (dBuV) | Over Limit (dB) | Limit (dBuV/m) | Factor (dB) | Type |
|----|------|------|-----------------|------------------------|----------------------|-----------------|----------------|-------------|------|
| 1  |      |      | 5460.000        | 44.289                 | 41.096               | -9.711          | 54.000         | 3.194       | AV   |
| 2  |      |      | 5470.000        | 47.037                 | 43.508               | -6.963          | 54.000         | 3.529       | AV   |
| 3  |      | *    | 5496.645        | 93.787                 | 90.641               | N/A             | N/A            | 3.145       | AV   |

Note: Measure Level (dB $\mu$ V/m) = Reading Level (dB $\mu$ V) + Factor (dB)

Factor (dB) = Cable Loss (dB) + Antenna Factor (dB/m) - Pre\_Amplifier Gain (dB)

|  |                          |
|--|--------------------------|
| Site: AC2  | Time: 2016/08/25 - 10:13 |
| Limit: FCC_Part15.209_RE(3m)                                     | Engineer: Bruce Wang     |
| Probe: BBHA9120D_1-18GHz   | Polarity: Vertical       |
| EUT: WIRELESS-ABGN 2X2 NETWORK MINIPCIE ADAPTER                  | Power: AC 120V/60Hz      |
| Test Mode: Transmit by 802.11n-HT20 at Channel 5500MHz Ant 0 + 1 |                          |

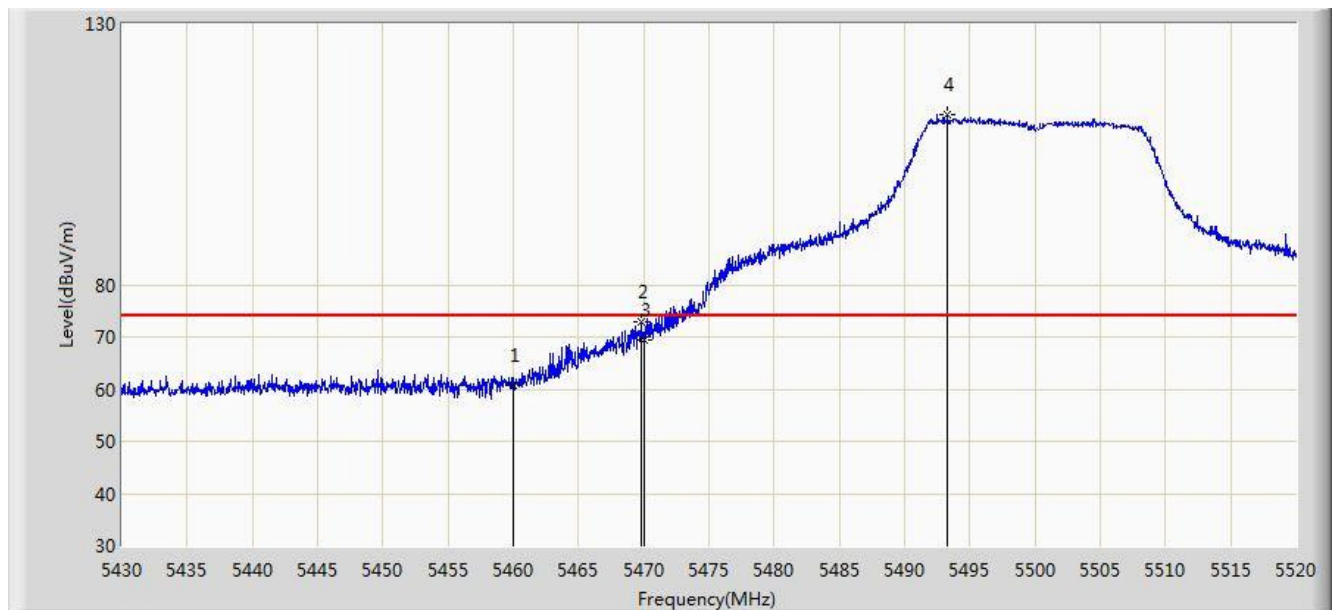

| No | Flag | Mark | Frequency (MHz) | Measure Level (dBuV/m) | Reading Level (dBuV) | Over Limit (dB) | Limit (dBuV/m) | Factor (dB) | Type |
|----|------|------|-----------------|------------------------|----------------------|-----------------|----------------|-------------|------|
| 1  |      |      | 5460.000        | 60.862                 | 57.669               | -13.138         | 74.000         | 3.194       | PK   |
| 2  |      |      | 5469.780        | 72.934                 | 69.412               | -1.066          | 74.000         | 3.522       | PK   |
| 3  |      |      | 5470.000        | 69.440                 | 65.911               | -4.560          | 74.000         | 3.529       | PK   |
| 4  |      | *    | 5493.315        | 112.715                | 109.538              | N/A             | N/A            | 3.177       | PK   |

Note: Measure Level (dB $\mu$ V/m) = Reading Level (dB $\mu$ V) + Factor (dB)

Factor (dB) = Cable Loss (dB) + Antenna Factor (dB/m) - Pre\_Amplifier Gain (dB)

|  |                          |
|--|--------------------------|
| Site: AC2  | Time: 2016/08/25 - 10:18 |
| Limit: FCC_Part15.209_RE(3m)                                     | Engineer: Bruce Wang     |
| Probe: BBHA9120D_1-18GHz   | Polarity: Vertical       |
| EUT: WIRELESS-ABGN 2X2 NETWORK MINIPCIE ADAPTER                  | Power: AC 120V/60Hz      |
| Test Mode: Transmit by 802.11n-HT20 at Channel 5500MHz Ant 0 + 1 |                          |

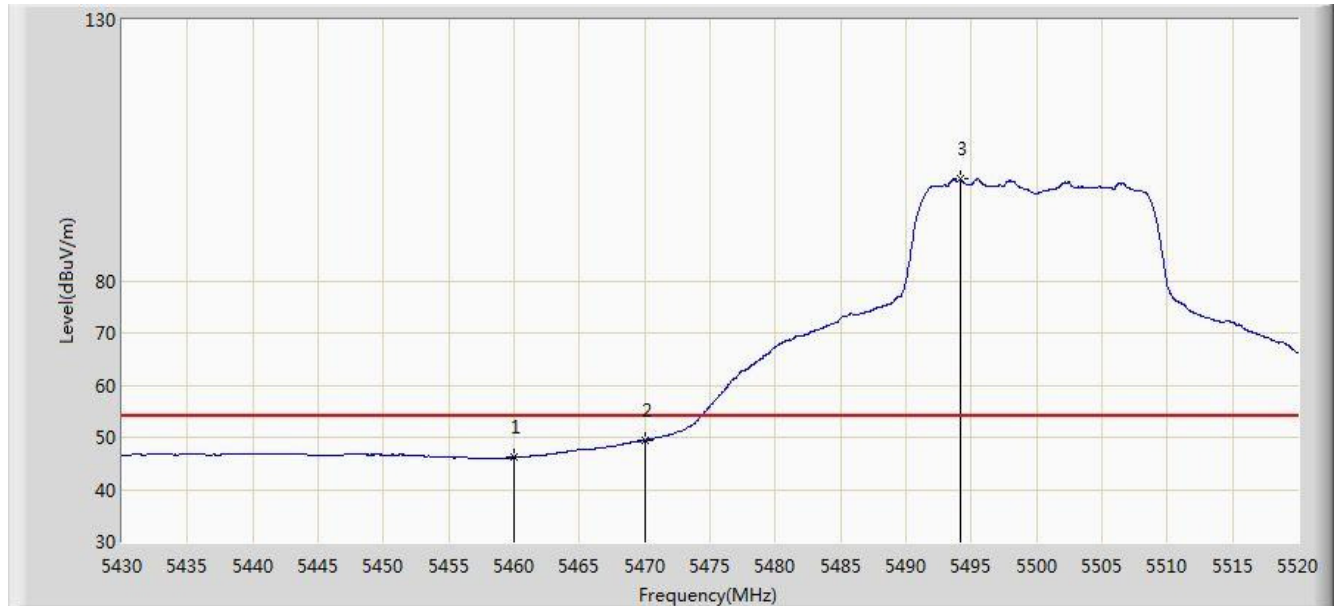

| No | Flag | Mark | Frequency (MHz) | Measure Level (dBuV/m) | Reading Level (dBuV) | Over Limit (dB) | Limit (dBuV/m) | Factor (dB) | Type |
|----|------|------|-----------------|------------------------|----------------------|-----------------|----------------|-------------|------|
| 1  |      |      | 5460.000        | 46.201                 | 43.008               | -7.799          | 54.000         | 3.194       | AV   |
| 2  |      |      | 5470.000        | 49.471                 | 45.942               | -4.529          | 54.000         | 3.529       | AV   |
| 3  |      | *    | 5494.215        | 99.489                 | 96.320               | N/A             | N/A            | 3.169       | AV   |

Note: Measure Level (dB $\mu$ V/m) = Reading Level (dB $\mu$ V) + Factor (dB)

Factor (dB) = Cable Loss (dB) + Antenna Factor (dB/m) - Pre\_Amplifier Gain (dB)

|  |                          |
|--|--------------------------|
| Site: AC2  | Time: 2016/08/25 - 10:37 |
| Limit: FCC_Part15.209_RE(3m)                                     | Engineer: Bruce Wang     |
| Probe: BBHA9120D_1-18GHz   | Polarity: Horizontal     |
| EUT: WIRELESS-ABGN 2X2 NETWORK MINIPCIE ADAPTER                  | Power: AC 120V/60Hz      |
| Test Mode: Transmit by 802.11n-HT20 at Channel 5700MHz Ant 0 + 1 |                          |

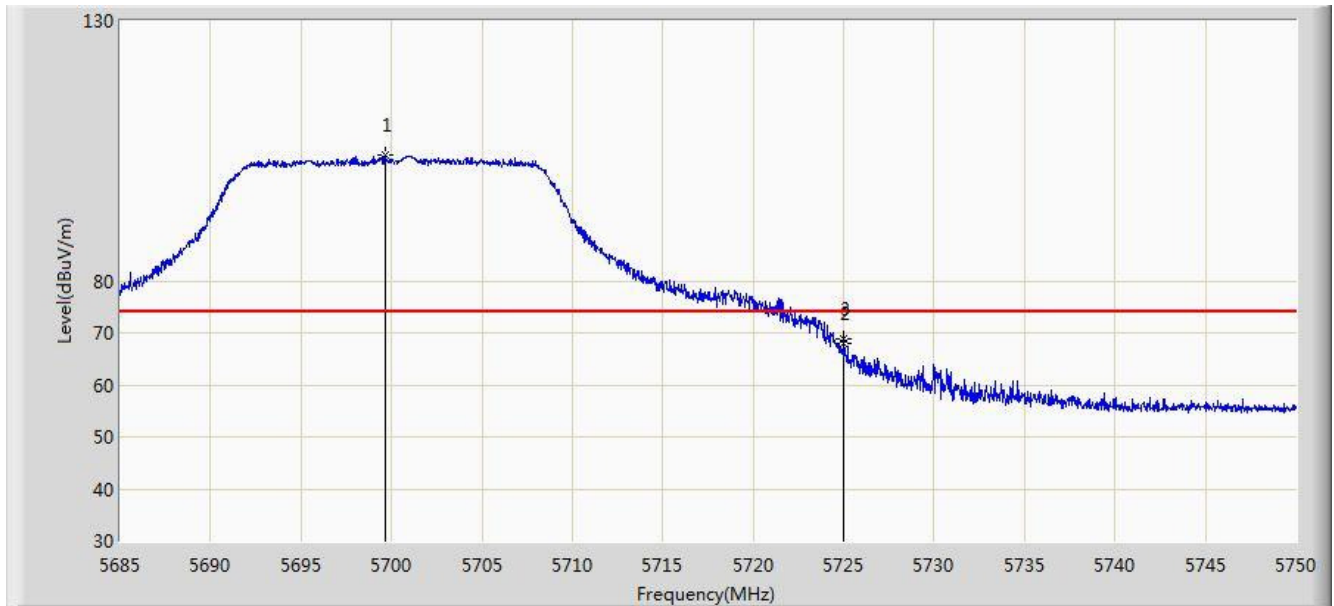

| No | Flag | Mark | Frequency (MHz) | Measure Level (dBuV/m) | Reading Level (dBuV) | Over Limit (dB) | Limit (dBuV/m) | Factor (dB) | Type |
|----|------|------|-----------------|------------------------|----------------------|-----------------|----------------|-------------|------|
| 1  |      | *    | 5699.658        | 104.175                | 100.231              | N/A             | N/A            | 3.944       | PK   |
| 2  |      |      | 5725.000        | 68.097                 | 63.991               | -10.103         | 78.200         | 4.105       | PK   |
| 3  |      |      | 5725.007        | 68.891                 | 64.785               | -5.109          | 74.000         | 4.105       | PK   |

Note: Measure Level (dBuV/m) = Reading Level (dBuV) + Factor (dB)

Factor (dB) = Cable Loss (dB) + Antenna Factor (dB/m) - Pre\_Amplifier Gain (dB)



|  |                          |
|--|--------------------------|
| Site: AC2  | Time: 2016/08/25 - 10:40 |
| Limit: FCC_Part15.209_RE(3m)                                     | Engineer: Bruce Wang     |
| Probe: BBHA9120D_1-18GHz   | Polarity: Horizontal     |
| EUT: WIRELESS-ABGN 2X2 NETWORK MINIPCIE ADAPTER                  | Power: AC 120V/60Hz      |
| Test Mode: Transmit by 802.11n-HT20 at Channel 5700MHz Ant 0 + 1 |                          |

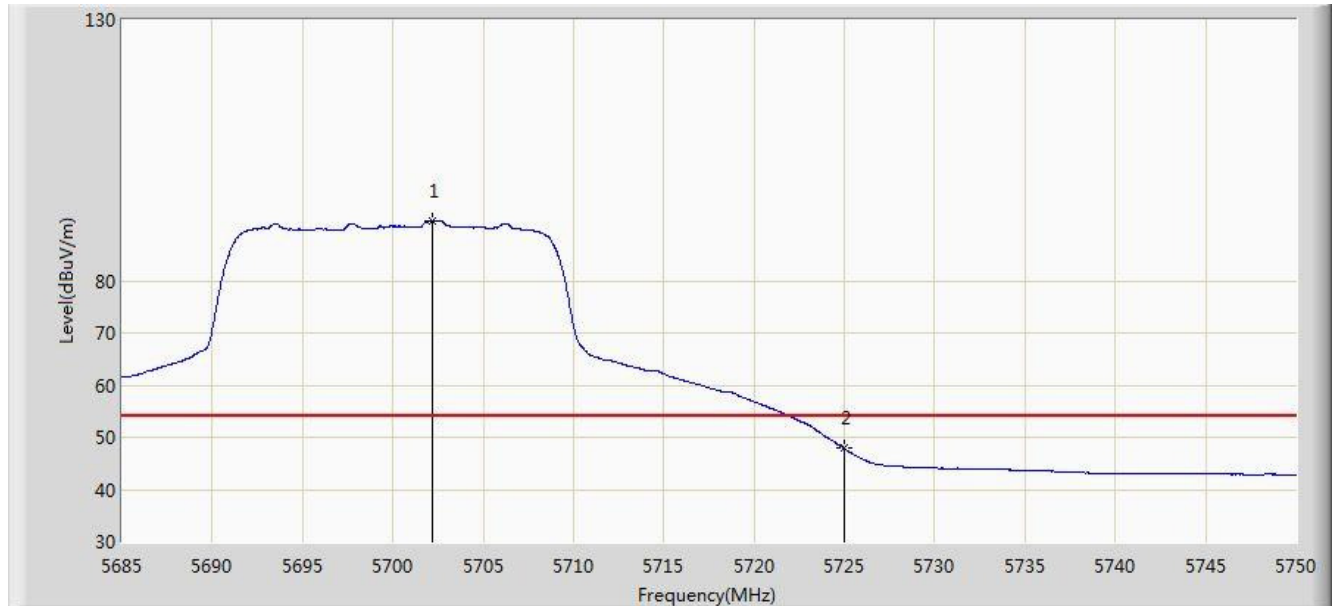

| No | Flag | Mark | Frequency (MHz) | Measure Level (dBuV/m) | Reading Level (dBuV) | Over Limit (dB) | Limit (dBuV/m) | Factor (dB) | Type |
|----|------|------|-----------------|------------------------|----------------------|-----------------|----------------|-------------|------|
| 1  |      | *    | 5702.192        | 91.416                 | 87.500               | N/A             | N/A            | 3.916       | AV   |
| 2  |      |      | 5725.000        | 47.827                 | 43.721               | -6.173          | 54.000         | 4.105       | AV   |

Note: Measure Level (dBμV/m) = Reading Level (dBμV) + Factor (dB)

Factor (dB) = Cable Loss (dB) + Antenna Factor (dB/m) - Pre\_Amplifier Gain (dB)

|  |                          |
|--|--------------------------|
| Site: AC2  | Time: 2016/08/25 - 10:26 |
| Limit: FCC_Part15.209_RE(3m)                                     | Engineer: Bruce Wang     |
| Probe: BBHA9120D_1-18GHz   | Polarity: Vertical       |
| EUT: WIRELESS-ABGN 2X2 NETWORK MINIPCIE ADAPTER                  | Power: AC 120V/60Hz      |
| Test Mode: Transmit by 802.11n-HT20 at Channel 5700MHz Ant 0 + 1 |                          |

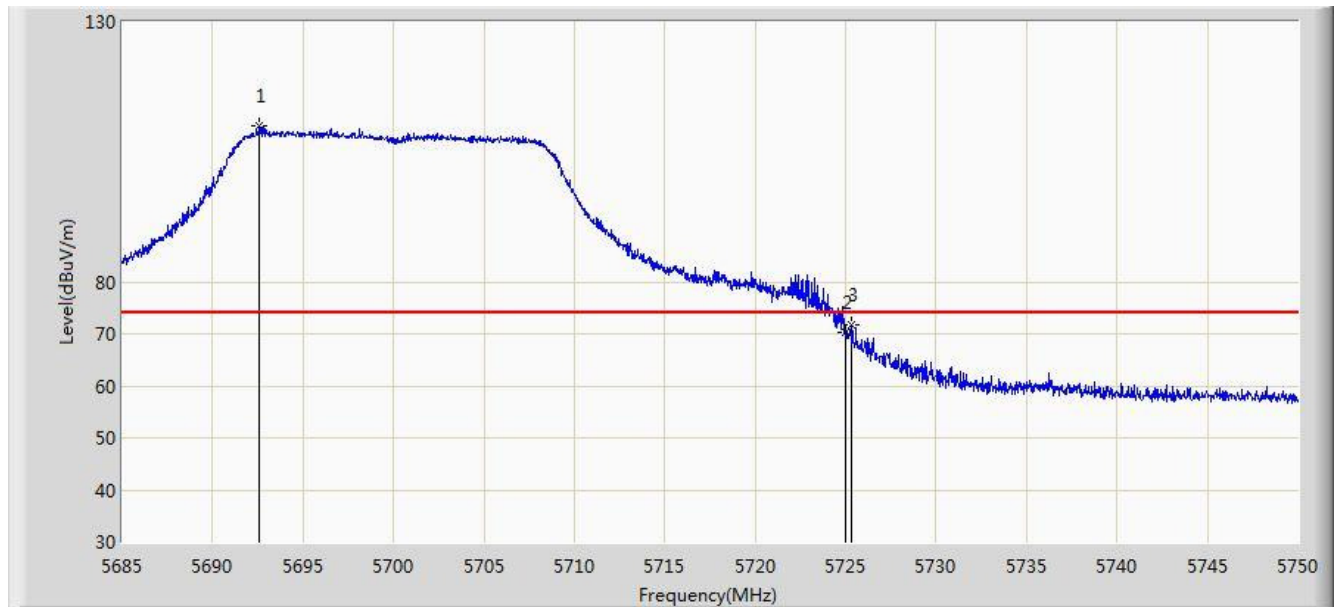

| No | Flag | Mark | Frequency (MHz) | Measure Level (dBuV/m) | Reading Level (dBuV) | Over Limit (dB) | Limit (dBuV/m) | Factor (dB) | Type |
|----|------|------|-----------------|------------------------|----------------------|-----------------|----------------|-------------|------|
| 1  |      | *    | 5692.572        | 110.032                | 106.018              | N/A             | N/A            | 4.014       | PK   |
| 2  |      |      | 5725.000        | 70.407                 | 66.301               | -7.793          | 78.200         | 4.105       | PK   |
| 3  |      |      | 5725.300        | 71.780                 | 67.667               | -2.220          | 74.000         | 4.113       | PK   |

Note: Measure Level (dB $\mu$ V/m) = Reading Level (dB $\mu$ V) + Factor (dB)

Factor (dB) = Cable Loss (dB) + Antenna Factor (dB/m) - Pre\_Amplifier Gain (dB)

|  |                          |
|--|--------------------------|
| Site: AC2  | Time: 2016/08/25 - 10:36 |
| Limit: FCC_Part15.209_RE(3m)                                     | Engineer: Bruce Wang     |
| Probe: BBHA9120D_1-18GHz   | Polarity: Vertical       |
| EUT: WIRELESS-ABGN 2X2 NETWORK MINIPCIE ADAPTER                  | Power: AC 120V/60Hz      |
| Test Mode: Transmit by 802.11n-HT20 at Channel 5700MHz Ant 0 + 1 |                          |

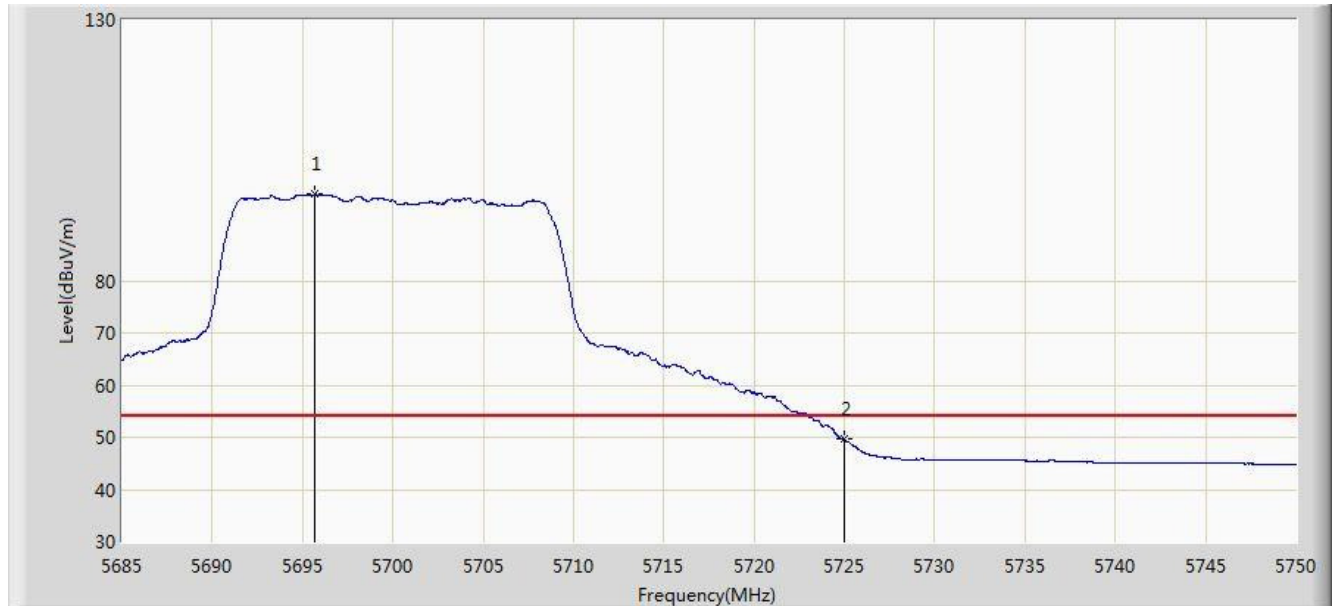

| No | Flag | Mark | Frequency (MHz) | Measure Level (dBuV/m) | Reading Level (dBuV) | Over Limit (dB) | Limit (dBuV/m) | Factor (dB) | Type |
|----|------|------|-----------------|------------------------|----------------------|-----------------|----------------|-------------|------|
| 1  |      | *    | 5695.692        | 96.578                 | 92.594               | N/A             | N/A            | 3.985       | AV   |
| 2  |      |      | 5725.000        | 49.600                 | 45.494               | -4.400          | 54.000         | 4.105       | AV   |

Note: Measure Level (dBμV/m) = Reading Level (dBμV) + Factor (dB)

Factor (dB) = Cable Loss (dB) + Antenna Factor (dB/m) - Pre\_Amplifier Gain (dB)

|  |                          |
|--|--------------------------|
| Site: AC2  | Time: 2016/08/25 - 10:44 |
| Limit: FCC_Part15.407_RE(3m)                                     | Engineer: Bruce Wang     |
| Probe: BBHA9120D_1-18GHz   | Polarity: Horizontal     |
| EUT: WIRELESS-ABGN 2X2 NETWORK MINIPCIE ADAPTER                  | Power: AC 120V/60Hz      |
| Test Mode: Transmit by 802.11n-HT20 at Channel 5745MHz Ant 0 + 1 |                          |

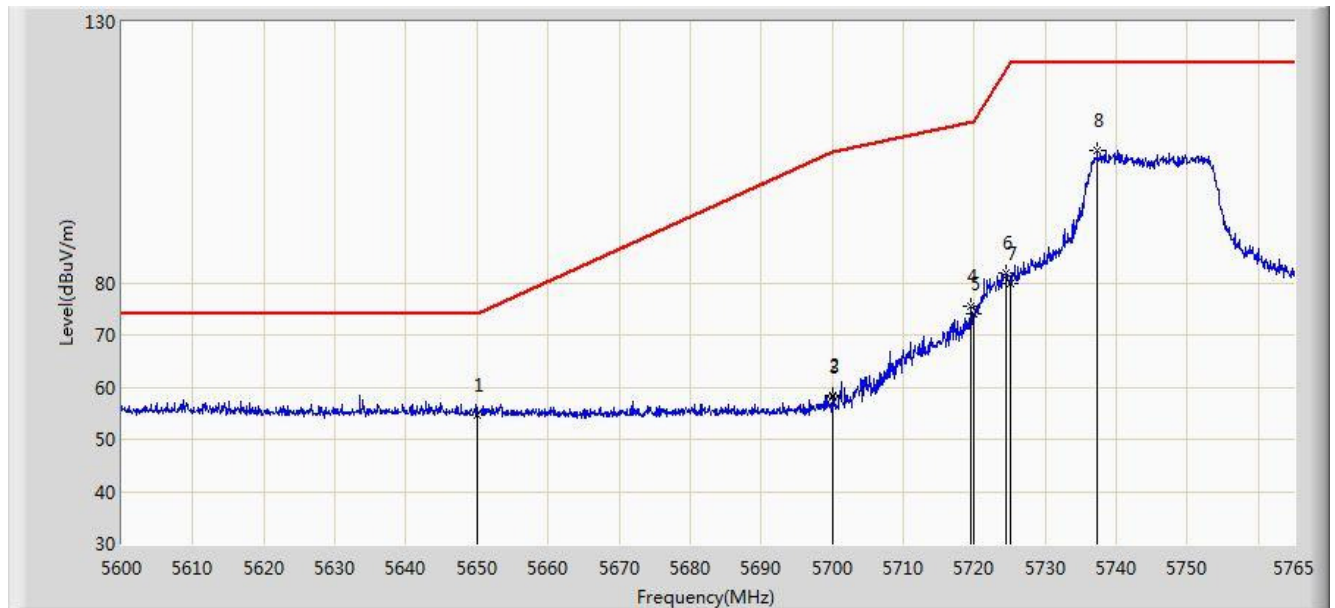

| No | Flag | Mark | Frequency (MHz) | Measure Level (dBuV/m) | Reading Level (dBuV) | Over Limit (dB) | Limit (dBuV/m) | Factor (dB) | Type |
|----|------|------|-----------------|------------------------|----------------------|-----------------|----------------|-------------|------|
| 1  |      |      | 5650.000        | 54.612                 | 50.809               | -19.388         | 74.000         | 3.803       | PK   |
| 2  |      |      | 5699.990        | 58.334                 | 54.394               | -46.860         | 105.194        | 3.940       | PK   |
| 3  |      |      | 5700.000        | 58.083                 | 54.143               | -47.117         | 105.200        | 3.940       | PK   |
| 4  |      |      | 5719.460        | 75.540                 | 71.571               | -35.109         | 110.649        | 3.970       | PK   |
| 5  |      |      | 5720.000        | 73.986                 | 70.004               | -36.814         | 110.800        | 3.982       | PK   |
| 6  |      |      | 5724.575        | 81.968                 | 77.873               | -39.263         | 121.231        | 4.095       | PK   |
| 7  |      |      | 5725.000        | 79.932                 | 75.826               | -42.268         | 122.200        | 4.105       | PK   |
| 8  |      | *    | 5737.280        | 105.472                | 101.188              | N/A             | N/A            | 4.284       | PK   |

Note: Measure Level (dBμV/m) = Reading Level (dBμV) + Factor (dB)

Factor (dB) = Cable Loss (dB) + Antenna Factor (dB/m) - Pre\_Amplifier Gain (dB)

|  |                          |
|--|--------------------------|
| Site: AC2  | Time: 2016/08/25 - 10:41 |
| Limit: FCC_Part15.407_RE(3m)                                     | Engineer: Bruce Wang     |
| Probe: BBHA9120D_1-18GHz   | Polarity: Vertical       |
| EUT: WIRELESS-ABGN 2X2 NETWORK MINIPCIE ADAPTER                  | Power: AC 120V/60Hz      |
| Test Mode: Transmit by 802.11n-HT20 at Channel 5745MHz Ant 0 + 1 |                          |

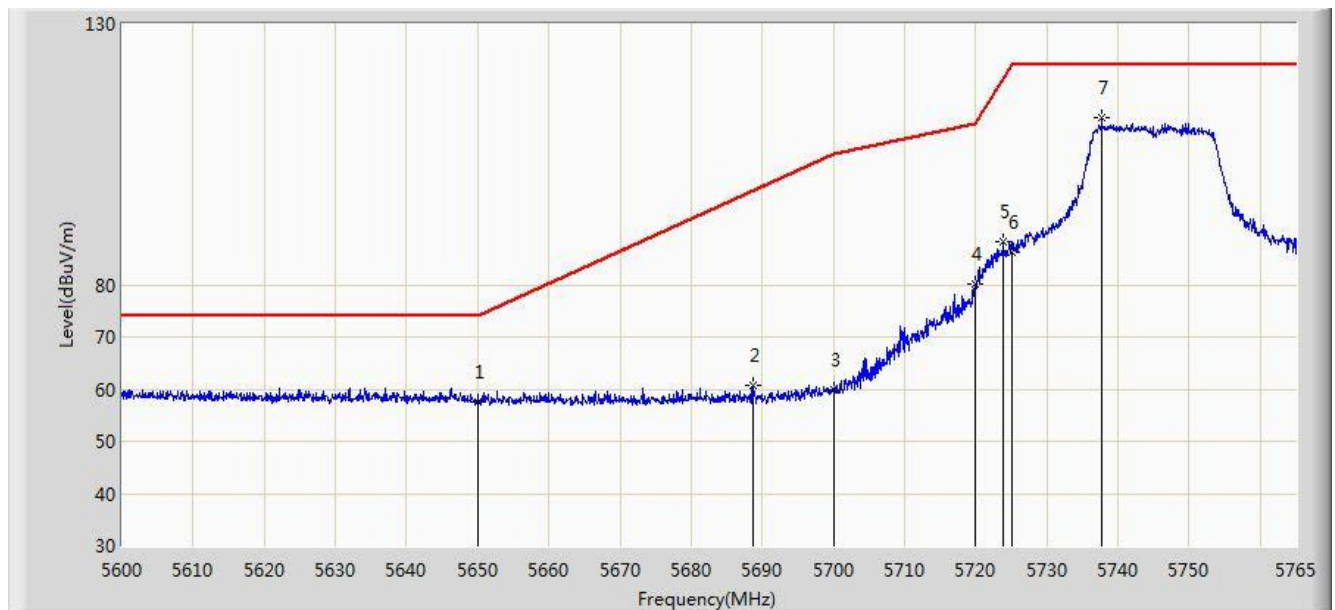

| No | Flag | Mark | Frequency (MHz) | Measure Level (dBuV/m) | Reading Level (dBuV) | Over Limit (dB) | Limit (dBuV/m) | Factor (dB) | Type |
|----|------|------|-----------------|------------------------|----------------------|-----------------|----------------|-------------|------|
| 1  |      |      | 5650.000        | 57.678                 | 53.875               | -16.322         | 74.000         | 3.803       | PK   |
| 2  |      |      | 5688.770        | 60.804                 | 56.787               | -37.412         | 98.216         | 4.017       | PK   |
| 3  |      |      | 5700.000        | 59.904                 | 55.964               | -45.296         | 105.200        | 3.940       | PK   |
| 4  |      |      | 5720.000        | 80.052                 | 76.070               | -30.748         | 110.800        | 3.982       | PK   |
| 5  |      |      | 5723.833        | 88.137                 | 84.060               | -31.403         | 119.540        | 4.076       | PK   |
| 6  |      |      | 5725.000        | 86.293                 | 82.187               | -35.907         | 122.200        | 4.105       | PK   |
| 7  |      | *    | 5737.692        | 112.056                | 107.773              | N/A             | N/A            | 4.283       | PK   |

Note: Measure Level (dB $\mu$ V/m) = Reading Level (dB $\mu$ V) + Factor (dB)

Factor (dB) = Cable Loss (dB) + Antenna Factor (dB/m) - Pre\_Amplifier Gain (dB)

|  |                          |
|--|--------------------------|
| Site: AC2  | Time: 2016/08/25 - 10:49 |
| Limit: FCC_Part15.407_RE(3m)                                     | Engineer: Bruce Wang     |
| Probe: BBHA9120D_1-18GHz   | Polarity: Horizontal     |
| EUT: WIRELESS-ABGN 2X2 NETWORK MINIPCIE ADAPTER                  | Power: AC 120V/60Hz      |
| Test Mode: Transmit by 802.11n-HT20 at Channel 5825MHz Ant 0 + 1 |                          |

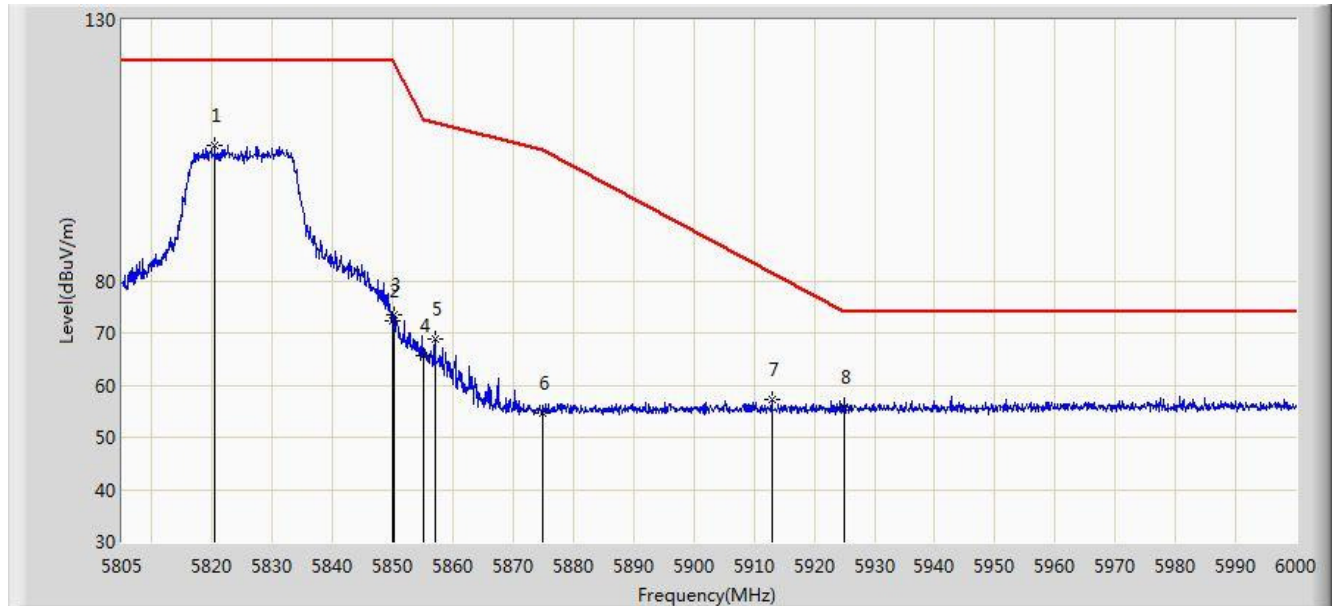

| No | Flag | Mark | Frequency (MHz) | Measure Level (dBuV/m) | Reading Level (dBuV) | Over Limit (dB) | Limit (dBuV/m) | Factor (dB) | Type |
|----|------|------|-----------------|------------------------|----------------------|-----------------|----------------|-------------|------|
| 1  |      | *    | 5820.405        | 106.002                | 101.333              | N/A             | N/A            | 4.669       | PK   |
| 2  |      |      | 5850.000        | 72.195                 | 67.200               | -50.005         | 122.200        | 4.995       | PK   |
| 3  |      |      | 5850.143        | 73.470                 | 68.475               | -48.404         | 121.874        | 4.995       | PK   |
| 4  |      |      | 5855.000        | 65.551                 | 60.563               | -45.249         | 110.800        | 4.987       | PK   |
| 5  |      |      | 5856.967        | 68.848                 | 63.864               | -41.400         | 110.248        | 4.985       | PK   |
| 6  |      |      | 5875.000        | 54.752                 | 49.745               | -50.448         | 105.200        | 5.008       | PK   |
| 7  |      |      | 5912.933        | 57.309                 | 52.139               | -24.197         | 81.506         | 5.170       | PK   |
| 8  |      |      | 5925.000        | 55.670                 | 50.518               | -18.330         | 74.000         | 5.152       | PK   |

Note: Measure Level (dBμV/m) = Reading Level (dBμV) + Factor (dB)

Factor (dB) = Cable Loss (dB) + Antenna Factor (dB/m) - Pre\_Amplifier Gain (dB)

|  |                          |
|--|--------------------------|
| Site: AC2  | Time: 2016/08/25 - 10:47 |
| Limit: FCC_Part15.407_RE(3m)                                     | Engineer: Bruce Wang     |
| Probe: BBHA9120D_1-18GHz   | Polarity: Vertical       |
| EUT: WIRELESS-ABGN 2X2 NETWORK MINIPCIE ADAPTER                  | Power: AC 120V/60Hz      |
| Test Mode: Transmit by 802.11n-HT20 at Channel 5825MHz Ant 0 + 1 |                          |

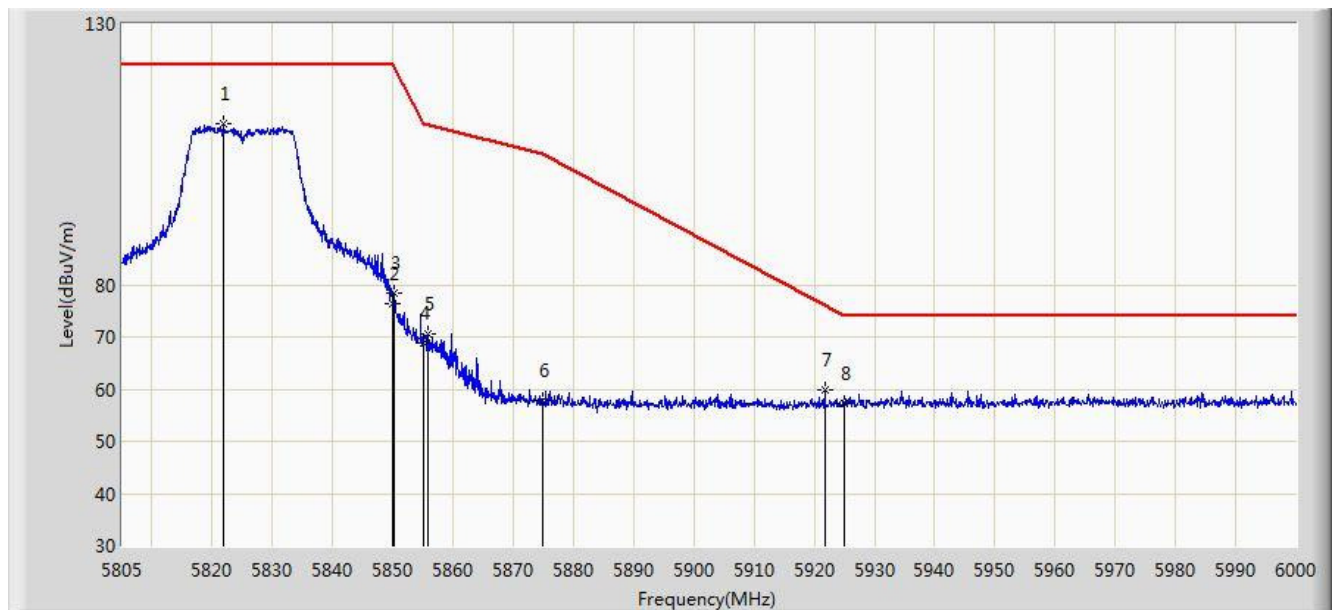

| No | Flag | Mark | Frequency (MHz) | Measure Level (dBuV/m) | Reading Level (dBuV) | Over Limit (dB) | Limit (dBuV/m) | Factor (dB) | Type |
|----|------|------|-----------------|------------------------|----------------------|-----------------|----------------|-------------|------|
| 1  |      | *    | 5821.770        | 110.745                | 106.055              | N/A             | N/A            | 4.690       | PK   |
| 2  |      |      | 5850.000        | 76.313                 | 71.318               | -45.887         | 122.200        | 4.995       | PK   |
| 3  |      |      | 5850.240        | 78.443                 | 73.448               | -43.210         | 121.653        | 4.995       | PK   |
| 4  |      |      | 5855.000        | 68.727                 | 63.739               | -42.073         | 110.800        | 4.987       | PK   |
| 5  |      |      | 5855.797        | 70.620                 | 65.634               | -39.956         | 110.576        | 4.986       | PK   |
| 6  |      |      | 5875.000        | 57.899                 | 52.892               | -47.301         | 105.200        | 5.008       | PK   |
| 7  |      |      | 5921.708        | 60.000                 | 54.843               | -16.046         | 76.046         | 5.157       | PK   |
| 8  |      |      | 5925.000        | 57.330                 | 52.178               | -16.670         | 74.000         | 5.152       | PK   |

Note: Measure Level (dB $\mu$ V/m) = Reading Level (dB $\mu$ V) + Factor (dB)

Factor (dB) = Cable Loss (dB) + Antenna Factor (dB/m) - Pre\_Amplifier Gain (dB)



|  |                          |
|--|--------------------------|
| Site: AC2  | Time: 2016/08/25 - 11:01 |
| Limit: FCC_Part15.209_RE(3m)                                     | Engineer: Bruce Wang     |
| Probe: BBHA9120D_1-18GHz   | Polarity: Horizontal     |
| EUT: WIRELESS-ABGN 2X2 NETWORK MINIPCIE ADAPTER                  | Power: AC 120V/60Hz      |
| Test Mode: Transmit by 802.11n-HT40 at Channel 5190MHz Ant 0 + 1 |                          |

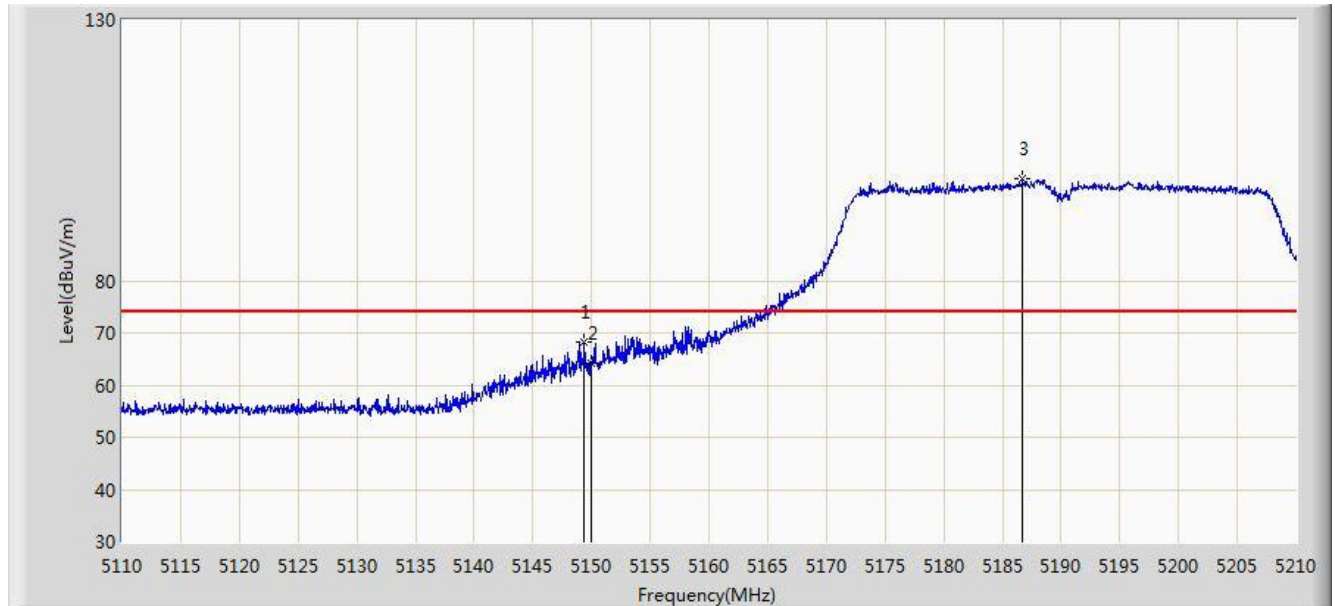

| No | Flag | Mark | Frequency (MHz) | Measure Level (dBuV/m) | Reading Level (dBuV) | Over Limit (dB) | Limit (dBuV/m) | Factor (dB) | Type |
|----|------|------|-----------------|------------------------|----------------------|-----------------|----------------|-------------|------|
| 1  |      |      | 5149.400        | 68.272                 | 65.201               | -5.728          | 74.000         | 3.071       | PK   |
| 2  |      |      | 5150.000        | 64.257                 | 61.187               | -9.743          | 74.000         | 3.069       | PK   |
| 3  |      | *    | 5186.750        | 99.706                 | 96.714               | N/A             | N/A            | 2.992       | PK   |

Note: Measure Level (dBuV/m) = Reading Level (dBuV) + Factor (dB)

Factor (dB) = Cable Loss (dB) + Antenna Factor (dB/m) - Pre\_Amplifier Gain (dB)



|  |                          |
|--|--------------------------|
| Site: AC2  | Time: 2016/08/25 - 11:04 |
| Limit: FCC_Part15.209_RE(3m)                                     | Engineer: Bruce Wang     |
| Probe: BBHA9120D_1-18GHz   | Polarity: Horizontal     |
| EUT: WIRELESS-ABGN 2X2 NETWORK MINIPCIE ADAPTER                  | Power: AC 120V/60Hz      |
| Test Mode: Transmit by 802.11n-HT40 at Channel 5190MHz Ant 0 + 1 |                          |

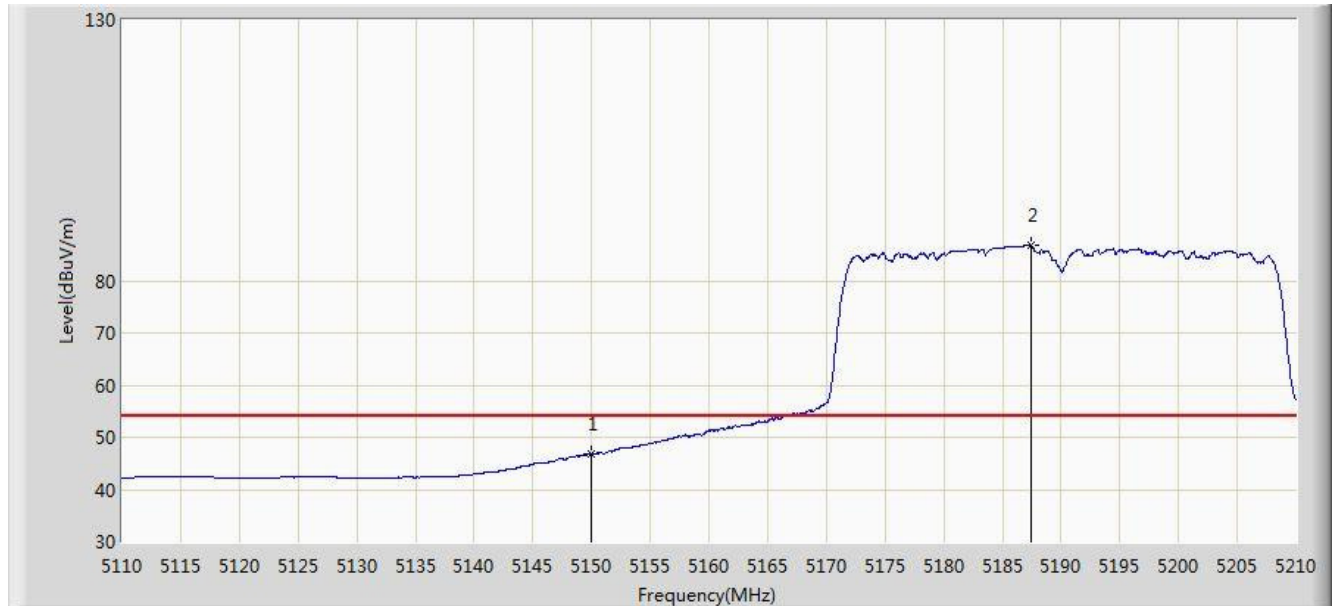

| No | Flag | Mark | Frequency (MHz) | Measure Level (dBuV/m) | Reading Level (dBuV) | Over Limit (dB) | Limit (dBuV/m) | Factor (dB) | Type |
|----|------|------|-----------------|------------------------|----------------------|-----------------|----------------|-------------|------|
| 1  |      |      | 5150.000        | 46.856                 | 43.786               | -7.144          | 54.000         | 3.069       | AV   |
| 2  |      | *    | 5187.400        | 86.769                 | 83.785               | N/A             | N/A            | 2.984       | AV   |

Note: Measure Level (dBμV/m) = Reading Level (dBμV) + Factor (dB)

Factor (dB) = Cable Loss (dB) + Antenna Factor (dB/m) - Pre\_Amplifier Gain (dB)

|  |                          |
|--|--------------------------|
| Site: AC2  | Time: 2016/08/25 - 10:55 |
| Limit: FCC_Part15.209_RE(3m)                                     | Engineer: Bruce Wang     |
| Probe: BBHA9120D_1-18GHz   | Polarity: Vertical       |
| EUT: WIRELESS-ABGN 2X2 NETWORK MINIPCIE ADAPTER                  | Power: AC 120V/60Hz      |
| Test Mode: Transmit by 802.11n-HT40 at Channel 5190MHz Ant 0 + 1 |                          |

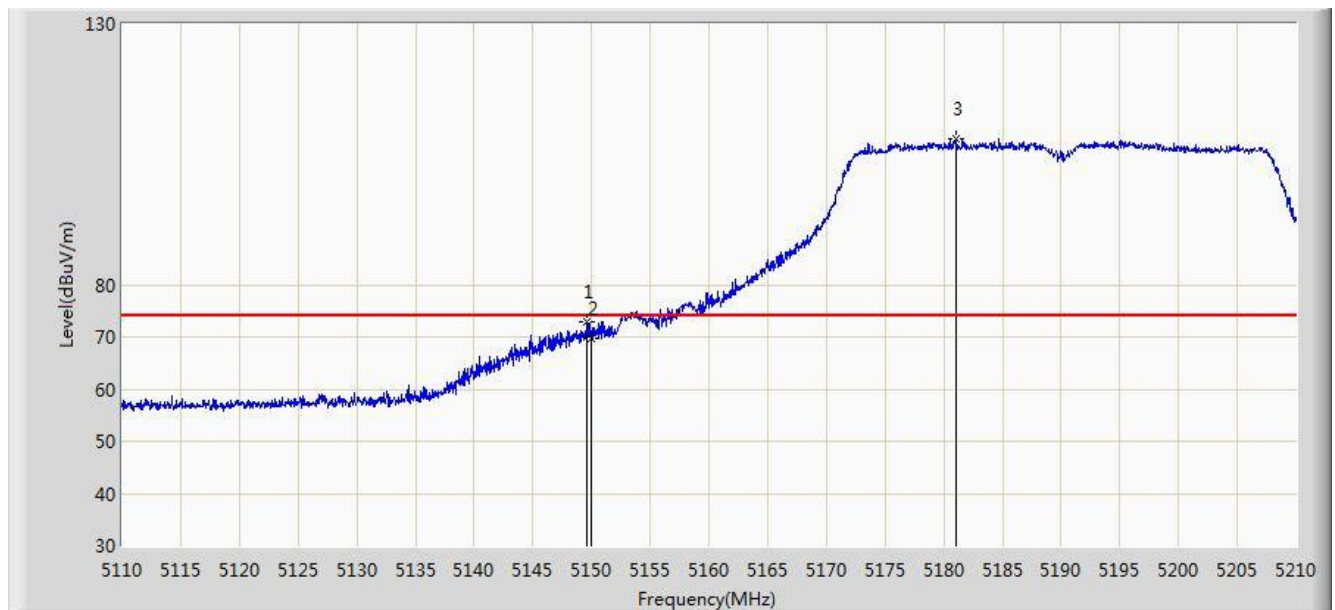

| No | Flag | Mark | Frequency (MHz) | Measure Level (dBuV/m) | Reading Level (dBuV) | Over Limit (dB) | Limit (dBuV/m) | Factor (dB) | Type |
|----|------|------|-----------------|------------------------|----------------------|-----------------|----------------|-------------|------|
| 1  |      |      | 5149.650        | 72.963                 | 69.893               | -1.037          | 74.000         | 3.070       | PK   |
| 2  |      |      | 5150.000        | 69.741                 | 66.671               | -4.259          | 74.000         | 3.069       | PK   |
| 3  |      | *    | 5181.000        | 108.010                | 104.963              | N/A             | N/A            | 3.047       | PK   |

Note: Measure Level (dB $\mu$ V/m) = Reading Level (dB $\mu$ V) + Factor (dB)

Factor (dB) = Cable Loss (dB) + Antenna Factor (dB/m) - Pre\_Amplifier Gain (dB)

|  |                          |
|--|--------------------------|
| Site: AC2  | Time: 2016/08/25 - 11:00 |
| Limit: FCC_Part15.209_RE(3m)                                     | Engineer: Bruce Wang     |
| Probe: BBHA9120D_1-18GHz   | Polarity: Vertical       |
| EUT: WIRELESS-ABGN 2X2 NETWORK MINIPCIE ADAPTER                  | Power: AC 120V/60Hz      |
| Test Mode: Transmit by 802.11n-HT40 at Channel 5190MHz Ant 0 + 1 |                          |

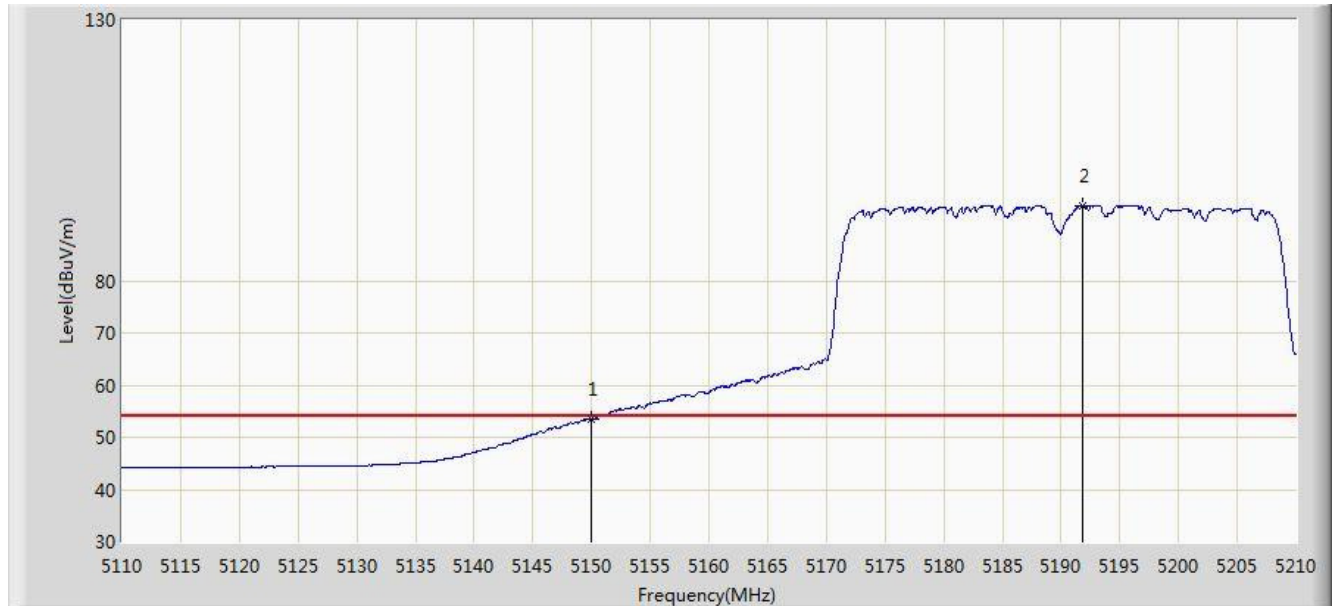

| No | Flag | Mark | Frequency (MHz) | Measure Level (dBuV/m) | Reading Level (dBuV) | Over Limit (dB) | Limit (dBuV/m) | Factor (dB) | Type |
|----|------|------|-----------------|------------------------|----------------------|-----------------|----------------|-------------|------|
| 1  |      |      | 5150.000        | 53.435                 | 50.365               | -0.565          | 54.000         | 3.069       | AV   |
| 2  |      | *    | 5191.850        | 94.454                 | 91.530               | N/A             | N/A            | 2.924       | AV   |

Note: Measure Level (dBμV/m) = Reading Level (dBμV) + Factor (dB)

Factor (dB) = Cable Loss (dB) + Antenna Factor (dB/m) - Pre\_Amplifier Gain (dB)

|  |                          |
|--|--------------------------|
| Site: AC2  | Time: 2016/08/25 - 11:15 |
| Limit: FCC_Part15.209_RE(3m)                                     | Engineer: Bruce Wang     |
| Probe: BBHA9120D_1-18GHz   | Polarity: Horizontal     |
| EUT: WIRELESS-ABGN 2X2 NETWORK MINIPCIE ADAPTER                  | Power: AC 120V/60Hz      |
| Test Mode: Transmit by 802.11n-HT40 at Channel 5310MHz Ant 0 + 1 |                          |

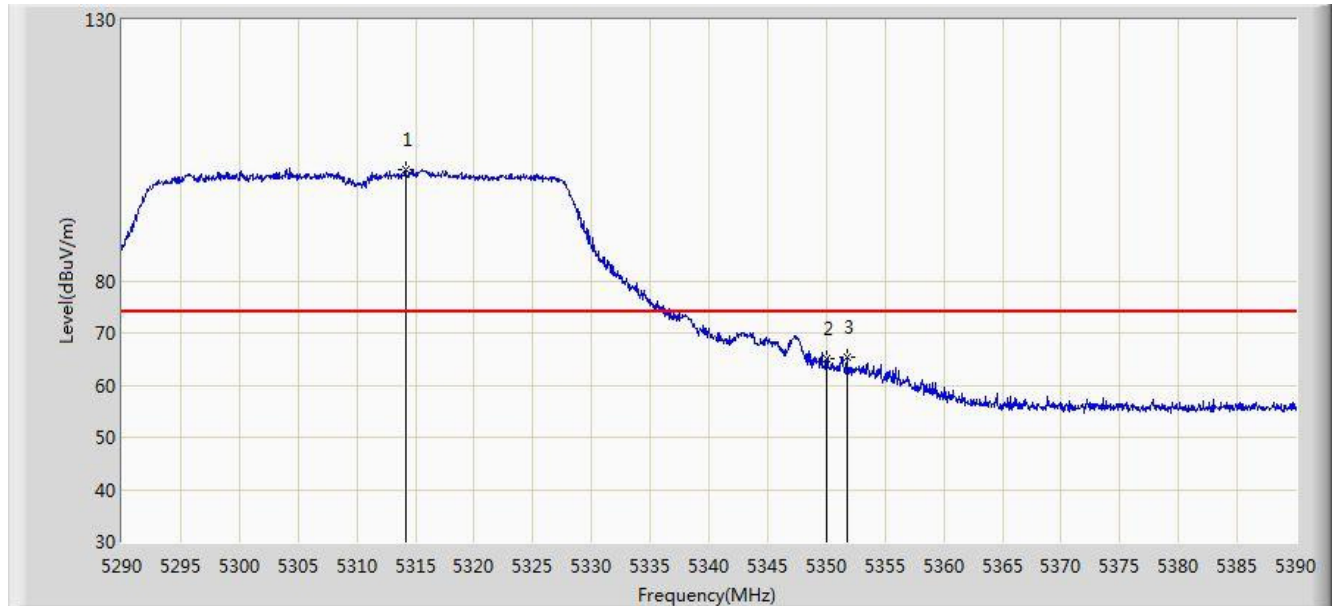

| No | Flag | Mark | Frequency (MHz) | Measure Level (dBuV/m) | Reading Level (dBuV) | Over Limit (dB) | Limit (dBuV/m) | Factor (dB) | Type |
|----|------|------|-----------------|------------------------|----------------------|-----------------|----------------|-------------|------|
| 1  |      | *    | 5314.150        | 101.414                | 98.796               | N/A             | N/A            | 2.618       | PK   |
| 2  |      |      | 5350.000        | 65.034                 | 62.337               | -8.966          | 74.000         | 2.697       | PK   |
| 3  |      |      | 5351.750        | 65.274                 | 62.570               | -8.726          | 74.000         | 2.704       | PK   |

Note: Measure Level (dBuV/m) = Reading Level (dBuV) + Factor (dB)

Factor (dB) = Cable Loss (dB) + Antenna Factor (dB/m) - Pre\_Amplifier Gain (dB)

|  |                          |
|--|--------------------------|
| Site: AC2  | Time: 2016/08/25 - 11:18 |
| Limit: FCC_Part15.209_RE(3m)                                     | Engineer: Bruce Wang     |
| Probe: BBHA9120D_1-18GHz   | Polarity: Horizontal     |
| EUT: WIRELESS-ABGN 2X2 NETWORK MINIPCIE ADAPTER                  | Power: AC 120V/60Hz      |
| Test Mode: Transmit by 802.11n-HT40 at Channel 5310MHz Ant 0 + 1 |                          |

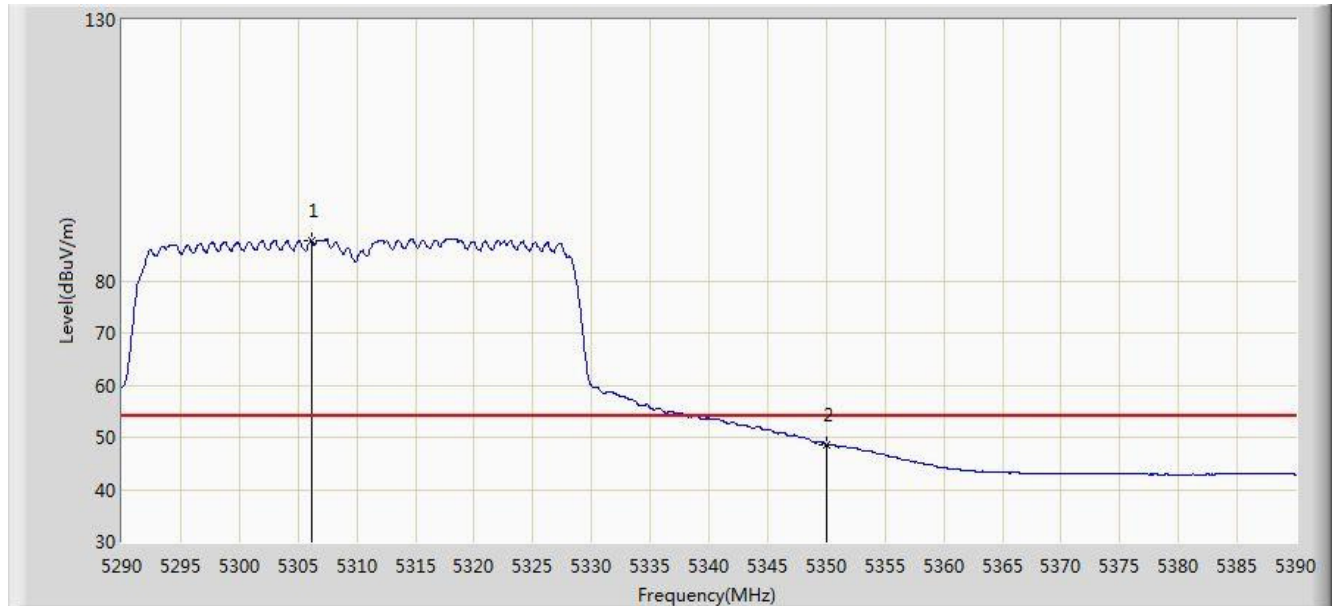

| No | Flag | Mark | Frequency (MHz) | Measure Level (dBuV/m) | Reading Level (dBuV) | Over Limit (dB) | Limit (dBuV/m) | Factor (dB) | Type |
|----|------|------|-----------------|------------------------|----------------------|-----------------|----------------|-------------|------|
| 1  |      | *    | 5306.150        | 87.650                 | 85.038               | N/A             | N/A            | 2.612       | AV   |
| 2  |      |      | 5350.000        | 48.497                 | 45.800               | -5.503          | 54.000         | 2.697       | AV   |

Note: Measure Level (dBμV/m) = Reading Level (dBμV) + Factor (dB)

Factor (dB) = Cable Loss (dB) + Antenna Factor (dB/m) - Pre\_Amplifier Gain (dB)

|  |                          |
|--|--------------------------|
| Site: AC2  | Time: 2016/08/25 - 11:05 |
| Limit: FCC_Part15.209_RE(3m)                                     | Engineer: Bruce Wang     |
| Probe: BBHA9120D_1-18GHz   | Polarity: Vertical       |
| EUT: WIRELESS-ABGN 2X2 NETWORK MINIPCIE ADAPTER                  | Power: AC 120V/60Hz      |
| Test Mode: Transmit by 802.11n-HT40 at Channel 5310MHz Ant 0 + 1 |                          |

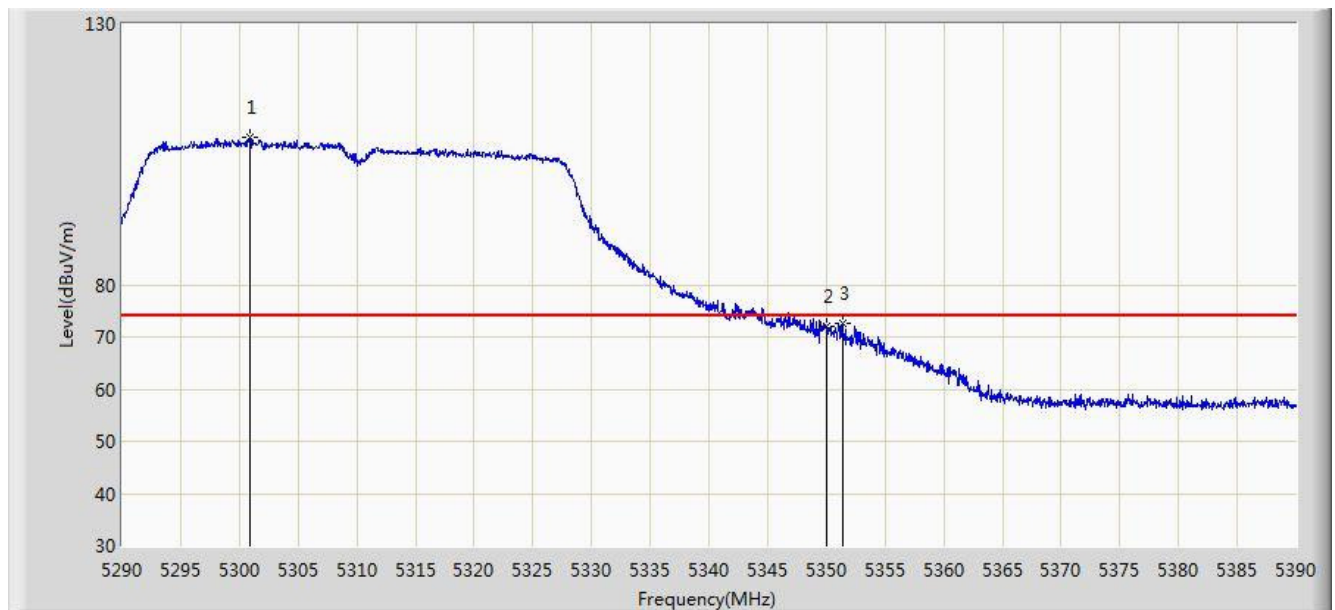

| No | Flag | Mark | Frequency (MHz) | Measure Level (dBuV/m) | Reading Level (dBuV) | Over Limit (dB) | Limit (dBuV/m) | Factor (dB) | Type |
|----|------|------|-----------------|------------------------|----------------------|-----------------|----------------|-------------|------|
| 1  |      | *    | 5300.900        | 108.187                | 105.567              | N/A             | N/A            | 2.619       | PK   |
| 2  |      |      | 5350.000        | 72.138                 | 69.441               | -1.862          | 74.000         | 2.697       | PK   |
| 3  |      |      | 5351.400        | 72.661                 | 69.958               | -1.339          | 74.000         | 2.703       | PK   |

Note: Measure Level (dB $\mu$ V/m) = Reading Level (dB $\mu$ V) + Factor (dB)

Factor (dB) = Cable Loss (dB) + Antenna Factor (dB/m) - Pre\_Amplifier Gain (dB)

|  |                          |
|--|--------------------------|
| Site: AC2  | Time: 2016/08/25 - 11:13 |
| Limit: FCC_Part15.209_RE(3m)                                     | Engineer: Bruce Wang     |
| Probe: BBHA9120D_1-18GHz   | Polarity: Vertical       |
| EUT: WIRELESS-ABGN 2X2 NETWORK MINIPCIE ADAPTER                  | Power: AC 120V/60Hz      |
| Test Mode: Transmit by 802.11n-HT40 at Channel 5310MHz Ant 0 + 1 |                          |

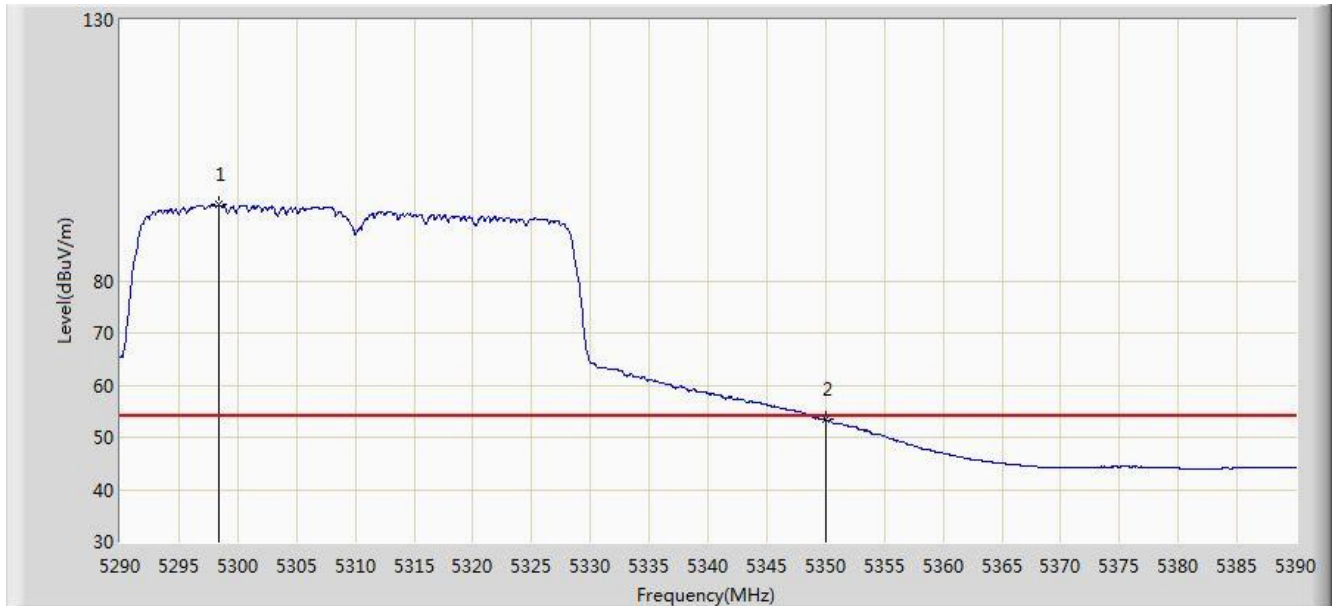

| No | Flag | Mark | Frequency (MHz) | Measure Level (dBuV/m) | Reading Level (dBuV) | Over Limit (dB) | Limit (dBuV/m) | Factor (dB) | Type |
|----|------|------|-----------------|------------------------|----------------------|-----------------|----------------|-------------|------|
| 1  |      | *    | 5298.400        | 94.494                 | 91.860               | N/A             | N/A            | 2.634       | AV   |
| 2  |      |      | 5350.000        | 53.335                 | 50.638               | -0.665          | 54.000         | 2.697       | AV   |

Note: Measure Level (dBμV/m) = Reading Level (dBμV) + Factor (dB)

Factor (dB) = Cable Loss (dB) + Antenna Factor (dB/m) - Pre\_Amplifier Gain (dB)

|  |                          |
|--|--------------------------|
| Site: AC2  | Time: 2016/08/25 - 11:28 |
| Limit: FCC_Part15.209_RE(3m)                                     | Engineer: Bruce Wang     |
| Probe: BBHA9120D_1-18GHz   | Polarity: Horizontal     |
| EUT: WIRELESS-ABGN 2X2 NETWORK MINIPCIE ADAPTER                  | Power: AC 120V/60Hz      |
| Test Mode: Transmit by 802.11n-HT40 at Channel 5510MHz Ant 0 + 1 |                          |

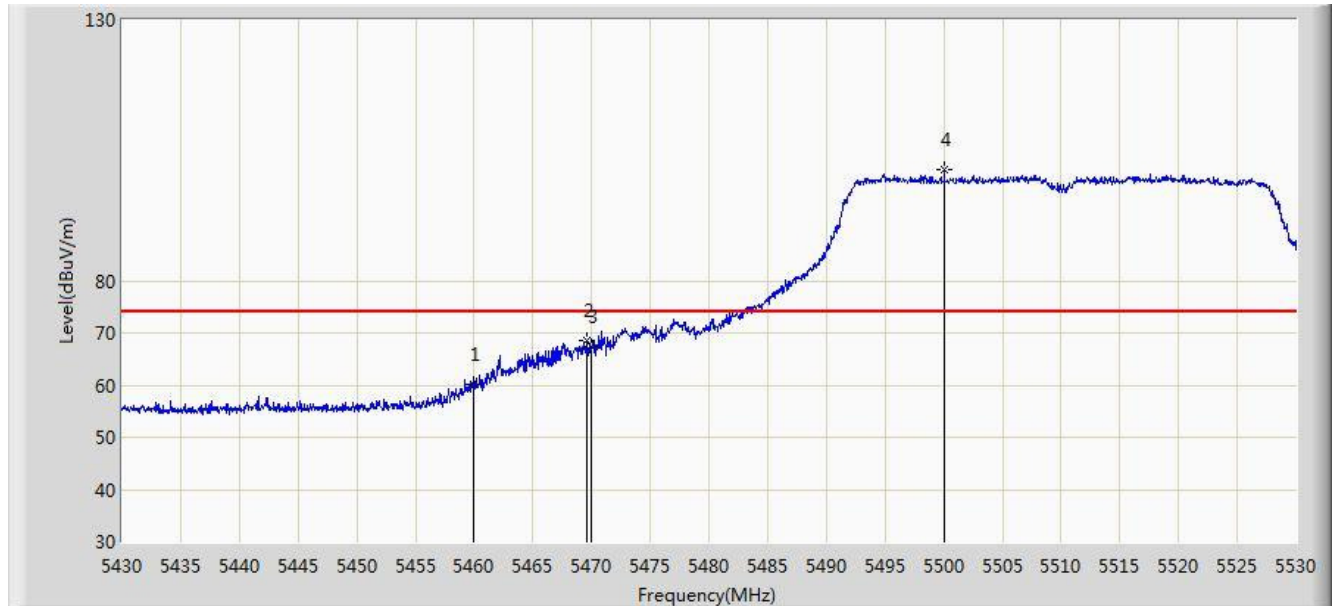

| No | Flag | Mark | Frequency (MHz) | Measure Level (dBuV/m) | Reading Level (dBuV) | Over Limit (dB) | Limit (dBuV/m) | Factor (dB) | Type |
|----|------|------|-----------------|------------------------|----------------------|-----------------|----------------|-------------|------|
| 1  |      |      | 5460.000        | 60.277                 | 57.084               | -13.723         | 74.000         | 3.194       | PK   |
| 2  |      |      | 5469.650        | 68.652                 | 65.135               | -5.348          | 74.000         | 3.518       | PK   |
| 3  |      |      | 5470.000        | 67.392                 | 63.863               | -6.608          | 74.000         | 3.529       | PK   |
| 4  |      | *    | 5500.050        | 101.424                | 98.311               | N/A             | N/A            | 3.114       | PK   |

Note: Measure Level (dB $\mu$ V/m) = Reading Level (dB $\mu$ V) + Factor (dB)

Factor (dB) = Cable Loss (dB) + Antenna Factor (dB/m) - Pre\_Amplifier Gain (dB)



|  |                          |
|--|--------------------------|
| Site: AC2  | Time: 2016/08/25 - 11:31 |
| Limit: FCC_Part15.209_RE(3m)                                     | Engineer: Bruce Wang     |
| Probe: BBHA9120D_1-18GHz   | Polarity: Horizontal     |
| EUT: WIRELESS-ABGN 2X2 NETWORK MINIPCIE ADAPTER                  | Power: AC 120V/60Hz      |
| Test Mode: Transmit by 802.11n-HT40 at Channel 5510MHz Ant 0 + 1 |                          |

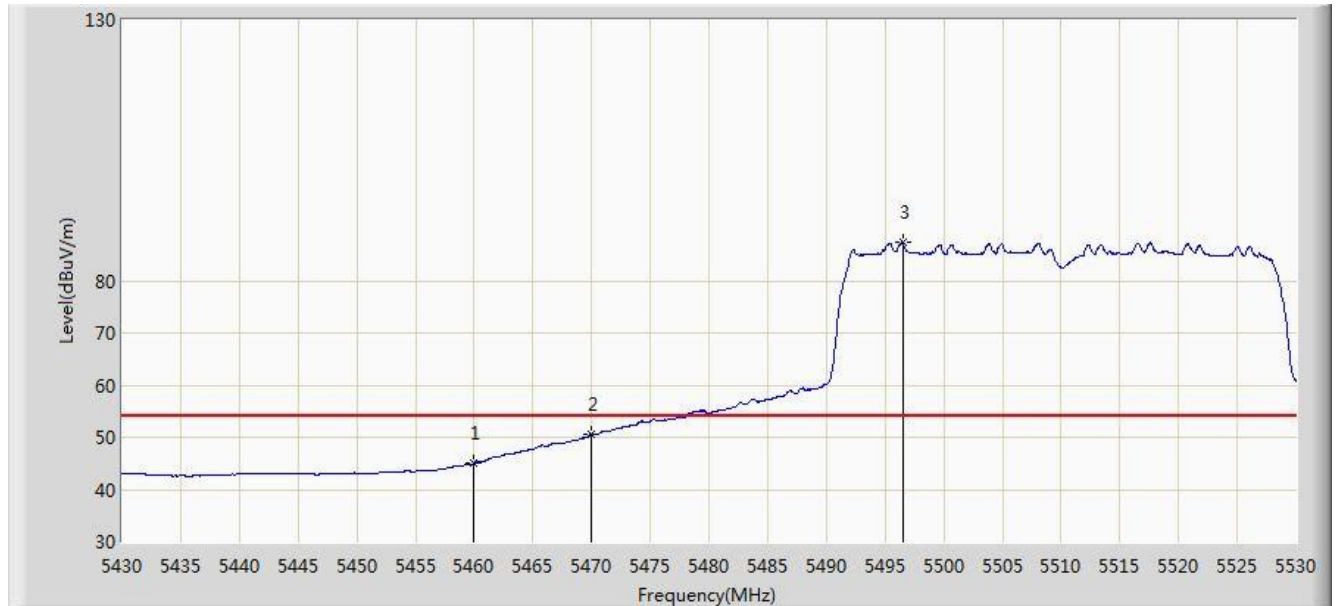

| No | Flag | Mark | Frequency (MHz) | Measure Level (dBuV/m) | Reading Level (dBuV) | Over Limit (dB) | Limit (dBuV/m) | Factor (dB) | Type |
|----|------|------|-----------------|------------------------|----------------------|-----------------|----------------|-------------|------|
| 1  |      |      | 5460.000        | 45.005                 | 41.812               | -8.995          | 54.000         | 3.194       | AV   |
| 2  |      |      | 5470.000        | 50.563                 | 47.034               | -3.437          | 54.000         | 3.529       | AV   |
| 3  |      | *    | 5496.500        | 87.305                 | 84.158               | N/A             | N/A            | 3.147       | AV   |

Note: Measure Level (dBuV/m) = Reading Level (dBuV) + Factor (dB)

Factor (dB) = Cable Loss (dB) + Antenna Factor (dB/m) - Pre\_Amplifier Gain (dB)

|  |                          |
|--|--------------------------|
| Site: AC2  | Time: 2016/08/25 - 11:19 |
| Limit: FCC_Part15.209_RE(3m)                                     | Engineer: Bruce Wang     |
| Probe: BBHA9120D_1-18GHz   | Polarity: Vertical       |
| EUT: WIRELESS-ABGN 2X2 NETWORK MINIPCIE ADAPTER                  | Power: AC 120V/60Hz      |
| Test Mode: Transmit by 802.11n-HT40 at Channel 5510MHz Ant 0 + 1 |                          |

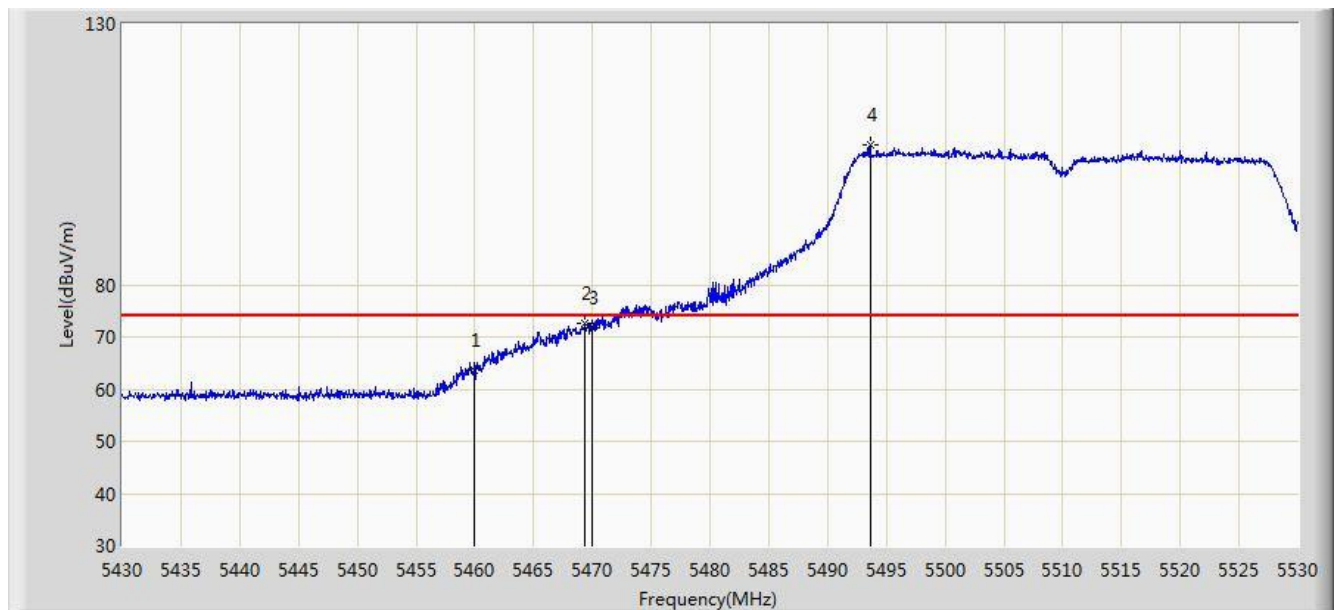

| No | Flag | Mark | Frequency (MHz) | Measure Level (dBuV/m) | Reading Level (dBuV) | Over Limit (dB) | Limit (dBuV/m) | Factor (dB) | Type |
|----|------|------|-----------------|------------------------|----------------------|-----------------|----------------|-------------|------|
| 1  |      |      | 5460.000        | 63.752                 | 60.559               | -10.248         | 74.000         | 3.194       | PK   |
| 2  |      |      | 5469.400        | 72.704                 | 69.195               | -1.296          | 74.000         | 3.509       | PK   |
| 3  |      |      | 5470.000        | 71.865                 | 68.336               | -2.135          | 74.000         | 3.529       | PK   |
| 4  |      | *    | 5493.650        | 106.812                | 103.638              | N/A             | N/A            | 3.174       | PK   |

Note: Measure Level (dB $\mu$ V/m) = Reading Level (dB $\mu$ V) + Factor (dB)

Factor (dB) = Cable Loss (dB) + Antenna Factor (dB/m) - Pre\_Amplifier Gain (dB)

|  |                          |
|--|--------------------------|
| Site: AC2  | Time: 2016/08/25 - 11:27 |
| Limit: FCC_Part15.209_RE(3m)                                     | Engineer: Bruce Wang     |
| Probe: BBHA9120D_1-18GHz   | Polarity: Vertical       |
| EUT: WIRELESS-ABGN 2X2 NETWORK MINIPCIE ADAPTER                  | Power: AC 120V/60Hz      |
| Test Mode: Transmit by 802.11n-HT40 at Channel 5510MHz Ant 0 + 1 |                          |

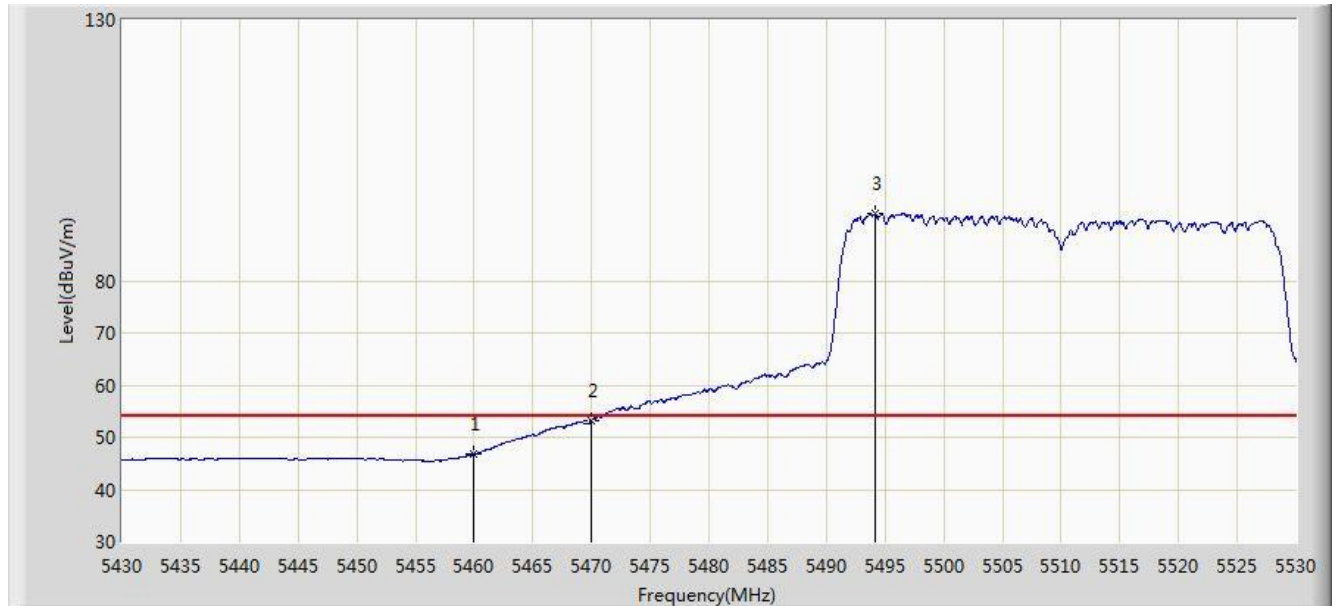

| No | Flag | Mark | Frequency (MHz) | Measure Level (dBuV/m) | Reading Level (dBuV) | Over Limit (dB) | Limit (dBuV/m) | Factor (dB) | Type |
|----|------|------|-----------------|------------------------|----------------------|-----------------|----------------|-------------|------|
| 1  |      |      | 5460.000        | 46.955                 | 43.762               | -7.045          | 54.000         | 3.194       | AV   |
| 2  |      |      | 5470.000        | 53.270                 | 49.741               | -0.730          | 54.000         | 3.529       | AV   |
| 3  |      | *    | 5494.200        | 92.799                 | 89.630               | N/A             | N/A            | 3.169       | AV   |

Note: Measure Level (dBuV/m) = Reading Level (dBuV) + Factor (dB)

Factor (dB) = Cable Loss (dB) + Antenna Factor (dB/m) - Pre\_Amplifier Gain (dB)

|  |                          |
|--|--------------------------|
| Site: AC2  | Time: 2016/08/25 - 11:41 |
| Limit: FCC_Part15.209_RE(3m)                                     | Engineer: Bruce Wang     |
| Probe: BBHA9120D_1-18GHz   | Polarity: Horizontal     |
| EUT: WIRELESS-ABGN 2X2 NETWORK MINIPCIE ADAPTER                  | Power: AC 120V/60Hz      |
| Test Mode: Transmit by 802.11n-HT40 at Channel 5670MHz Ant 0 + 1 |                          |

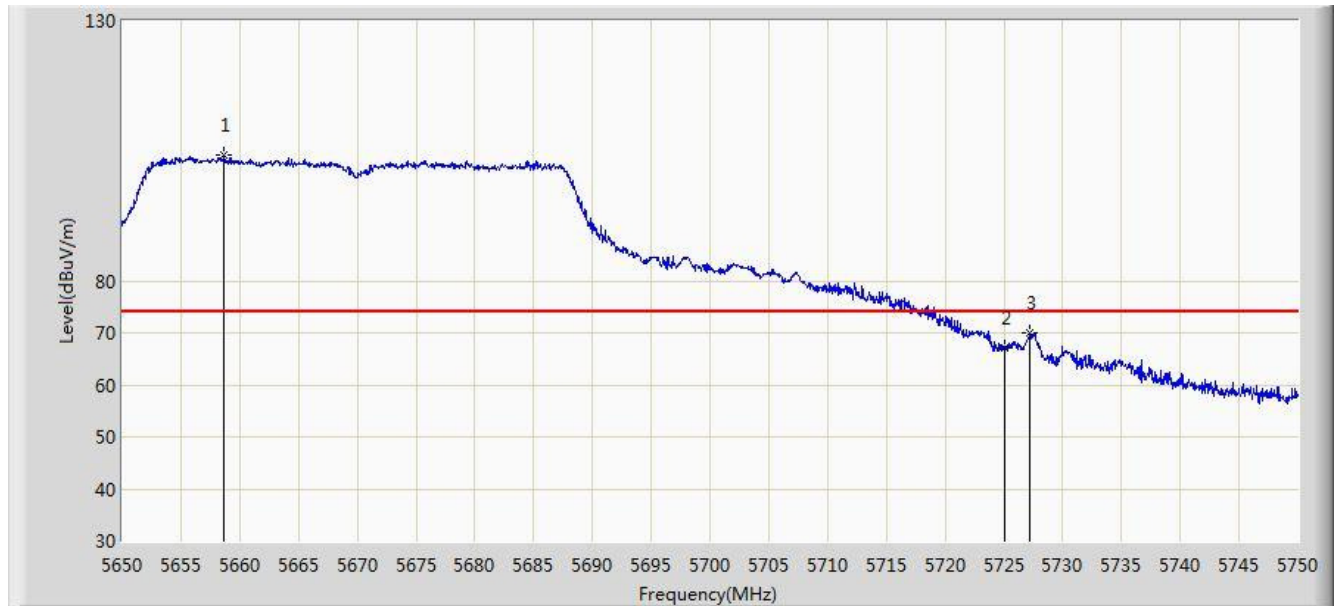

| No | Flag | Mark | Frequency (MHz) | Measure Level (dBuV/m) | Reading Level (dBuV) | Over Limit (dB) | Limit (dBuV/m) | Factor (dB) | Type |
|----|------|------|-----------------|------------------------|----------------------|-----------------|----------------|-------------|------|
| 1  |      | *    | 5658.700        | 104.081                | 100.469              | N/A             | N/A            | 3.611       | PK   |
| 2  |      |      | 5725.000        | 67.223                 | 63.117               | -10.977         | 78.200         | 4.105       | PK   |
| 3  |      |      | 5727.250        | 69.982                 | 65.820               | -4.018          | 74.000         | 4.162       | PK   |

Note: Measure Level (dBuV/m) = Reading Level (dBuV) + Factor (dB)

Factor (dB) = Cable Loss (dB) + Antenna Factor (dB/m) - Pre\_Amplifier Gain (dB)

|  |                          |
|--|--------------------------|
| Site: AC2  | Time: 2016/08/25 - 11:44 |
| Limit: FCC_Part15.209_RE(3m)                                     | Engineer: Bruce Wang     |
| Probe: BBHA9120D_1-18GHz   | Polarity: Horizontal     |
| EUT: WIRELESS-ABGN 2X2 NETWORK MINIPCIE ADAPTER                  | Power: AC 120V/60Hz      |
| Test Mode: Transmit by 802.11n-HT40 at Channel 5670MHz Ant 0 + 1 |                          |

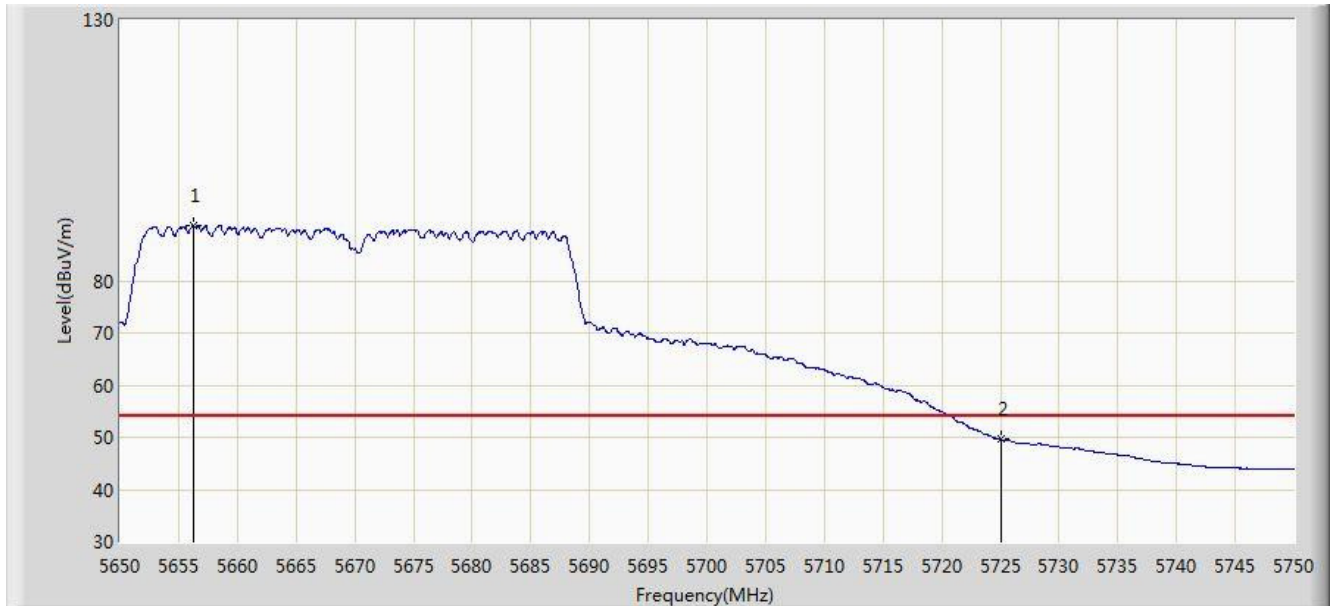

| No | Flag | Mark | Frequency (MHz) | Measure Level (dBuV/m) | Reading Level (dBuV) | Over Limit (dB) | Limit (dBuV/m) | Factor (dB) | Type |
|----|------|------|-----------------|------------------------|----------------------|-----------------|----------------|-------------|------|
| 1  |      | *    | 5656.300        | 90.554                 | 86.891               | N/A             | N/A            | 3.662       | AV   |
| 2  |      |      | 5725.000        | 49.629                 | 45.523               | -4.371          | 54.000         | 4.105       | AV   |

Note: Measure Level (dBμV/m) = Reading Level (dBμV) + Factor (dB)

Factor (dB) = Cable Loss (dB) + Antenna Factor (dB/m) - Pre\_Amplifier Gain (dB)

|  |                          |
|--|--------------------------|
| Site: AC2  | Time: 2016/08/25 - 11:33 |
| Limit: FCC_Part15.209_RE(3m)                                     | Engineer: Bruce Wang     |
| Probe: BBHA9120D_1-18GHz   | Polarity: Vertical       |
| EUT: WIRELESS-ABGN 2X2 NETWORK MINIPCIE ADAPTER                  | Power: AC 120V/60Hz      |
| Test Mode: Transmit by 802.11n-HT40 at Channel 5670MHz Ant 0 + 1 |                          |

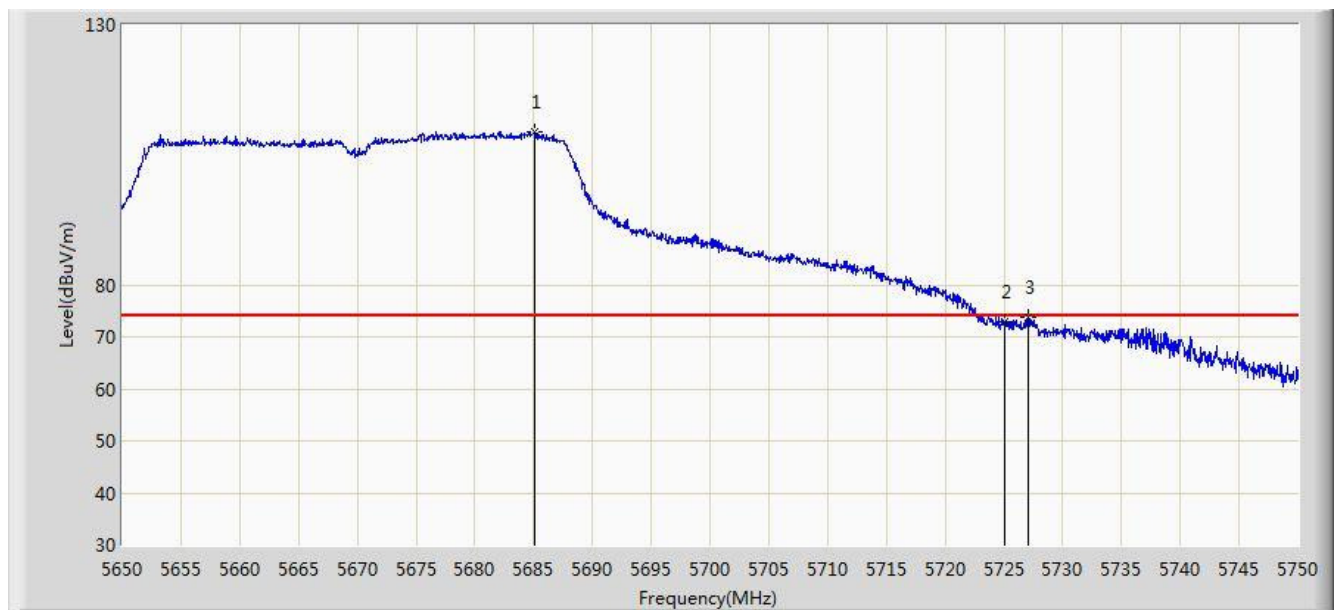

| No | Flag | Mark | Frequency (MHz) | Measure Level (dBuV/m) | Reading Level (dBuV) | Over Limit (dB) | Limit (dBuV/m) | Factor (dB) | Type |
|----|------|------|-----------------|------------------------|----------------------|-----------------|----------------|-------------|------|
| 1  |      | *    | 5685.050        | 109.455                | 105.440              | N/A             | N/A            | 4.015       | PK   |
| 2  |      |      | 5725.000        | 72.974                 | 68.868               | -5.226          | 78.200         | 4.105       | PK   |
| 3  |      |      | 5727.050        | 73.664                 | 69.507               | -0.336          | 74.000         | 4.157       | PK   |

Note: Measure Level (dB $\mu$ V/m) = Reading Level (dB $\mu$ V) + Factor (dB)

Factor (dB) = Cable Loss (dB) + Antenna Factor (dB/m) - Pre\_Amplifier Gain (dB)

|  |                          |
|--|--------------------------|
| Site: AC2  | Time: 2016/08/25 - 11:38 |
| Limit: FCC_Part15.209_RE(3m)                                     | Engineer: Bruce Wang     |
| Probe: BBHA9120D_1-18GHz   | Polarity: Vertical       |
| EUT: WIRELESS-ABGN 2X2 NETWORK MINIPCIE ADAPTER                  | Power: AC 120V/60Hz      |
| Test Mode: Transmit by 802.11n-HT40 at Channel 5670MHz Ant 0 + 1 |                          |

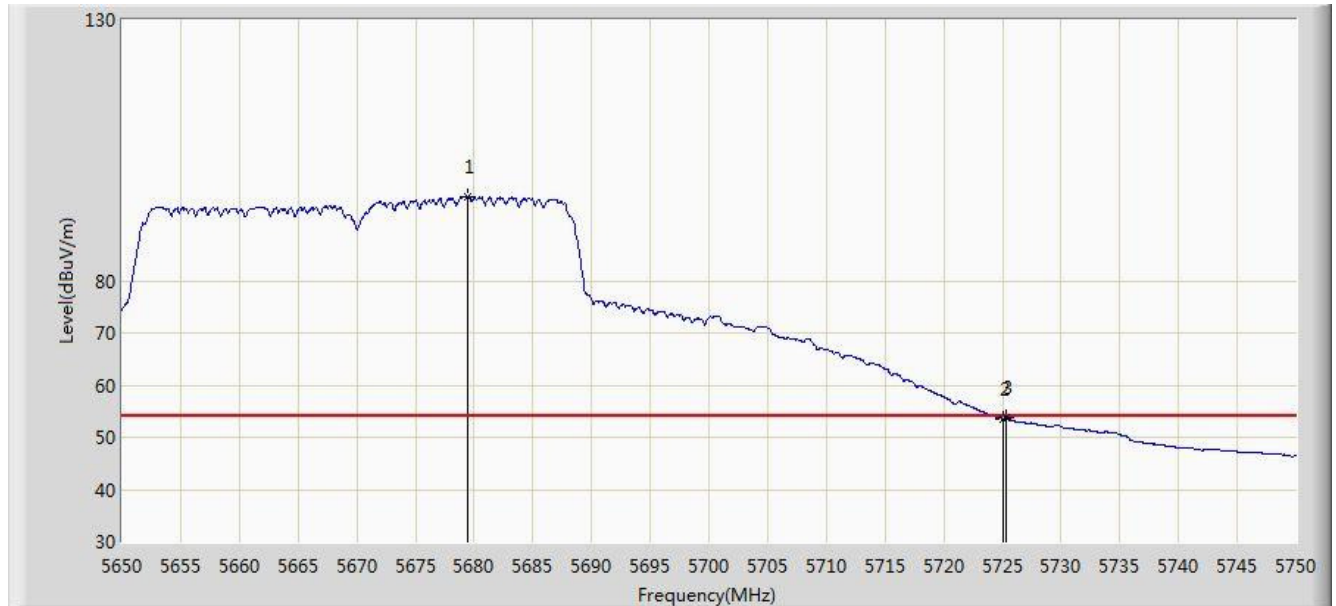

| No | Flag | Mark | Frequency (MHz) | Measure Level (dBuV/m) | Reading Level (dBuV) | Over Limit (dB) | Limit (dBuV/m) | Factor (dB) | Type |
|----|------|------|-----------------|------------------------|----------------------|-----------------|----------------|-------------|------|
| 1  |      | *    | 5679.450        | 96.104                 | 92.106               | N/A             | N/A            | 3.998       | AV   |
| 2  |      |      | 5725.000        | 53.514                 | 49.408               | -0.486          | 54.000         | 4.105       | AV   |
| 3  |      |      | 5725.350        | 53.747                 | 49.633               | -0.253          | 54.000         | 4.114       | AV   |

Note: Measure Level (dBuV/m) = Reading Level (dBuV) + Factor (dB)

Factor (dB) = Cable Loss (dB) + Antenna Factor (dB/m) - Pre\_Amplifier Gain (dB)

|  |                          |
|--|--------------------------|
| Site: AC2  | Time: 2016/08/25 - 11:49 |
| Limit: FCC_Part15.407_RE(3m)                                     | Engineer: Bruce Wang     |
| Probe: BBHA9120D_1-18GHz   | Polarity: Horizontal     |
| EUT: WIRELESS-ABGN 2X2 NETWORK MINIPCIE ADAPTER                  | Power: AC 120V/60Hz      |
| Test Mode: Transmit by 802.11n-HT40 at Channel 5755MHz Ant 0 + 1 |                          |

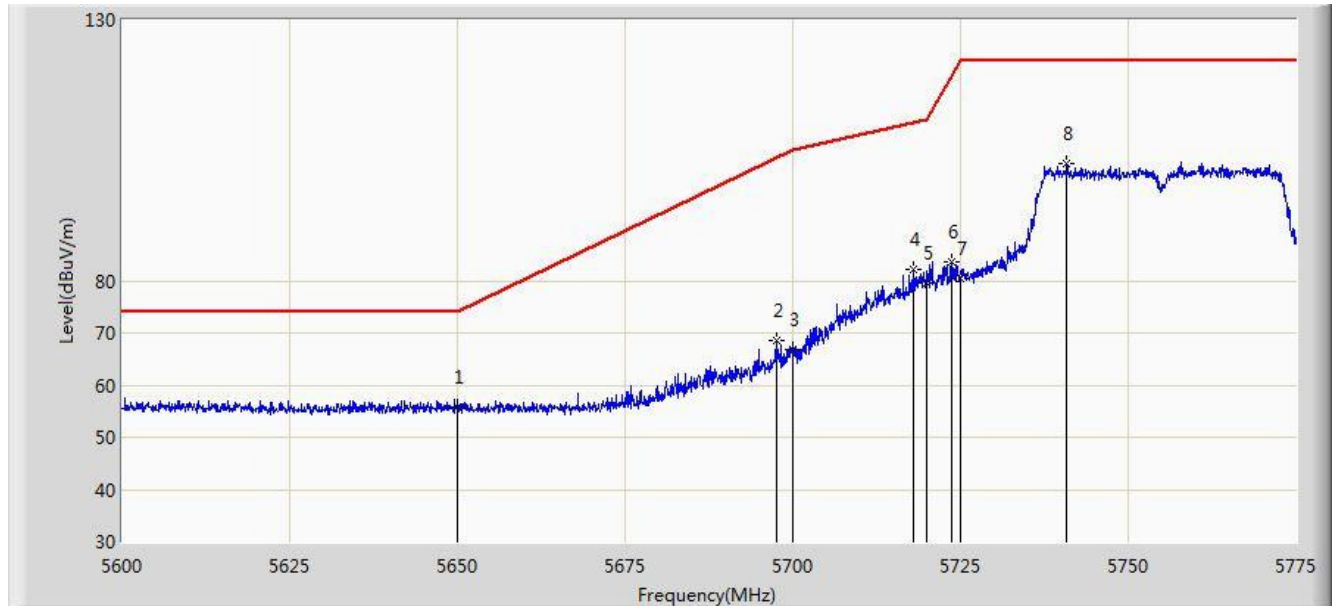

| No | Flag | Mark | Frequency (MHz) | Measure Level (dBuV/m) | Reading Level (dBuV) | Over Limit (dB) | Limit (dBuV/m) | Factor (dB) | Type |
|----|------|------|-----------------|------------------------|----------------------|-----------------|----------------|-------------|------|
| 1  |      | *    | 5650.000        | 55.678                 | 51.875               | -18.322         | 74.000         | 3.803       | PK   |
| 2  |      |      | 5697.650        | 68.499                 | 64.534               | -35.240         | 103.740        | 3.966       | PK   |
| 3  |      |      | 5700.000        | 66.715                 | 62.775               | -38.485         | 105.200        | 3.940       | PK   |
| 4  |      |      | 5717.950        | 82.125                 | 78.193               | -28.102         | 110.227        | 3.932       | PK   |
| 5  |      |      | 5720.000        | 79.573                 | 75.591               | -31.227         | 110.800        | 3.982       | PK   |
| 6  |      |      | 5723.725        | 83.691                 | 79.617               | -35.603         | 119.294        | 4.074       | PK   |
| 7  |      |      | 5725.000        | 80.336                 | 76.230               | -41.864         | 122.200        | 4.105       | PK   |
| 8  |      |      | 5740.788        | 102.348                | 98.072               | N/A             | N/A            | 4.277       | PK   |

Note: Measure Level (dBμV/m) = Reading Level (dBμV) + Factor (dB)

Factor (dB) = Cable Loss (dB) + Antenna Factor (dB/m) - Pre\_Amplifier Gain (dB)



|  |                          |
|--|--------------------------|
| Site: AC2  | Time: 2016/08/25 - 11:46 |
| Limit: FCC_Part15.407_RE(3m)                                     | Engineer: Bruce Wang     |
| Probe: BBHA9120D_1-18GHz   | Polarity: Vertical       |
| EUT: WIRELESS-ABGN 2X2 NETWORK MINIPCIE ADAPTER                  | Power: AC 120V/60Hz      |
| Test Mode: Transmit by 802.11n-HT40 at Channel 5755MHz Ant 0 + 1 |                          |

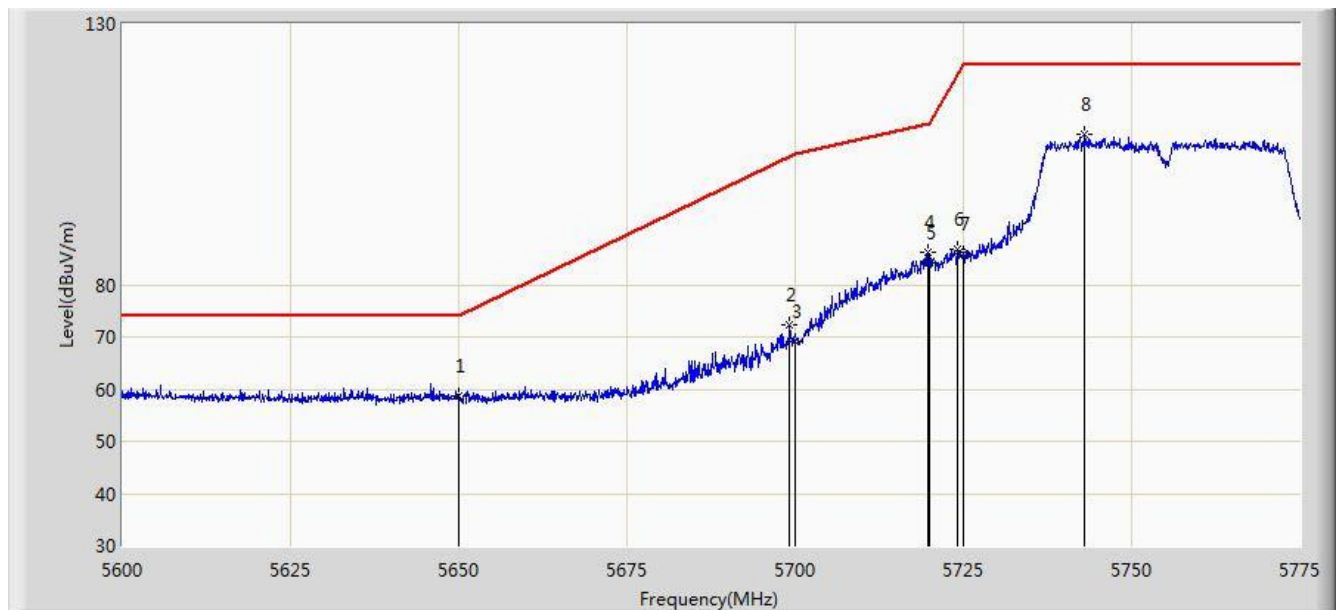

| No | Flag | Mark | Frequency (MHz) | Measure Level (dBuV/m) | Reading Level (dBuV) | Over Limit (dB) | Limit (dBuV/m) | Factor (dB) | Type |
|----|------|------|-----------------|------------------------|----------------------|-----------------|----------------|-------------|------|
| 1  |      |      | 5650.000        | 58.689                 | 54.886               | -15.311         | 74.000         | 3.803       | PK   |
| 2  |      |      | 5699.225        | 72.317                 | 68.369               | -32.401         | 104.718        | 3.948       | PK   |
| 3  |      |      | 5700.000        | 69.097                 | 65.157               | -36.103         | 105.200        | 3.940       | PK   |
| 4  |      |      | 5719.700        | 86.181                 | 82.206               | -24.535         | 110.716        | 3.975       | PK   |
| 5  |      |      | 5720.000        | 84.113                 | 80.131               | -26.687         | 110.800        | 3.982       | PK   |
| 6  |      |      | 5724.075        | 86.828                 | 82.745               | -33.264         | 120.092        | 4.082       | PK   |
| 7  |      |      | 5725.000        | 85.911                 | 81.805               | -36.289         | 122.200        | 4.105       | PK   |
| 8  |      | *    | 5743.062        | 108.753                | 104.483              | N/A             | N/A            | 4.270       | PK   |

Note: Measure Level (dB $\mu$ V/m) = Reading Level (dB $\mu$ V) + Factor (dB)

Factor (dB) = Cable Loss (dB) + Antenna Factor (dB/m) - Pre\_Amplifier Gain (dB)

|  |                          |
|--|--------------------------|
| Site: AC2  | Time: 2016/08/25 - 11:55 |
| Limit: FCC_Part15.407_RE(3m)                                     | Engineer: Bruce Wang     |
| Probe: BBHA9120D_1-18GHz   | Polarity: Horizontal     |
| EUT: WIRELESS-ABGN 2X2 NETWORK MINIPCIE ADAPTER                  | Power: AC 120V/60Hz      |
| Test Mode: Transmit by 802.11n-HT40 at Channel 5795MHz Ant 0 + 1 |                          |

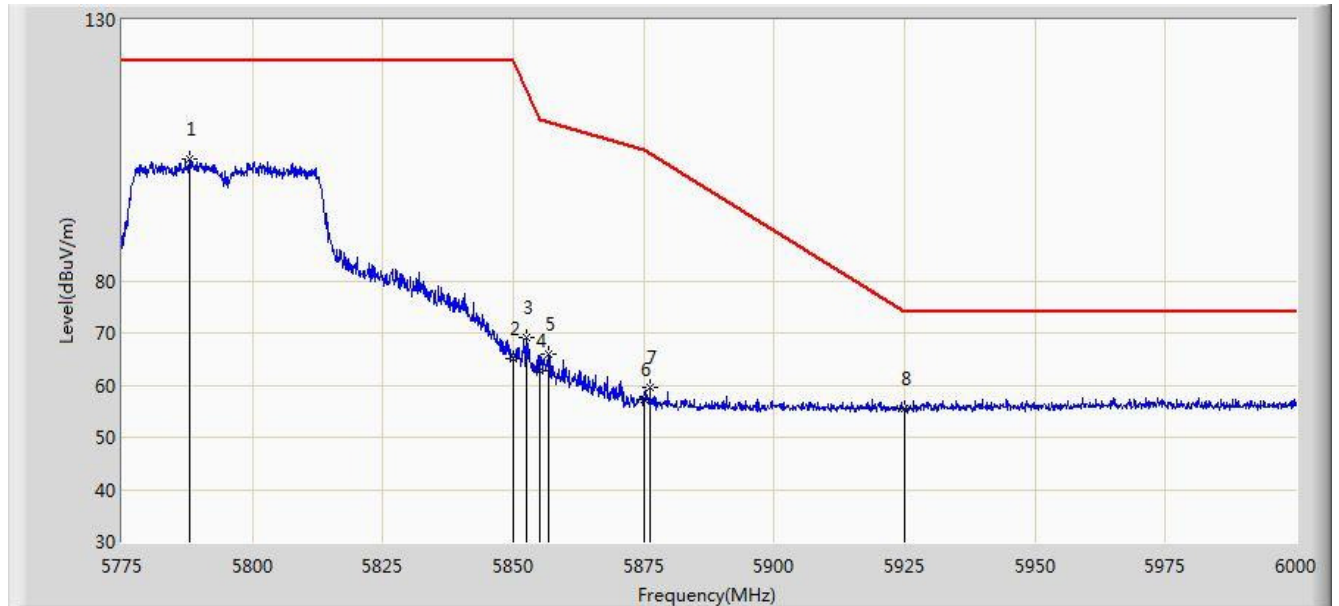

| No | Flag | Mark | Frequency (MHz) | Measure Level (dBuV/m) | Reading Level (dBuV) | Over Limit (dB) | Limit (dBuV/m) | Factor (dB) | Type |
|----|------|------|-----------------|------------------------|----------------------|-----------------|----------------|-------------|------|
| 1  |      |      | 5787.937        | 103.362                | 98.850               | N/A             | N/A            | 4.512       | PK   |
| 2  |      |      | 5850.000        | 65.018                 | 60.023               | -57.182         | 122.200        | 4.995       | PK   |
| 3  |      |      | 5852.400        | 69.183                 | 64.192               | -47.543         | 116.727        | 4.991       | PK   |
| 4  |      |      | 5855.000        | 62.711                 | 57.723               | -48.089         | 110.800        | 4.987       | PK   |
| 5  |      |      | 5856.675        | 65.829                 | 60.844               | -44.501         | 110.330        | 4.984       | PK   |
| 6  |      |      | 5875.000        | 57.332                 | 52.325               | -47.868         | 105.200        | 5.008       | PK   |
| 7  |      |      | 5876.250        | 59.572                 | 54.551               | -44.845         | 104.417        | 5.021       | PK   |
| 8  |      | *    | 5925.000        | 55.467                 | 50.315               | -18.533         | 74.000         | 5.152       | PK   |

Note: Measure Level (dBμV/m) = Reading Level (dBμV) + Factor (dB)

Factor (dB) = Cable Loss (dB) + Antenna Factor (dB/m) - Pre\_Amplifier Gain (dB)

|  |                          |
|--|--------------------------|
| Site: AC2  | Time: 2016/08/25 - 11:54 |
| Limit: FCC_Part15.407_RE(3m)                                     | Engineer: Bruce Wang     |
| Probe: BBHA9120D_1-18GHz   | Polarity: Vertical       |
| EUT: WIRELESS-ABGN 2X2 NETWORK MINIPCIE ADAPTER                  | Power: AC 120V/60Hz      |
| Test Mode: Transmit by 802.11n-HT40 at Channel 5795MHz Ant 0 + 1 |                          |

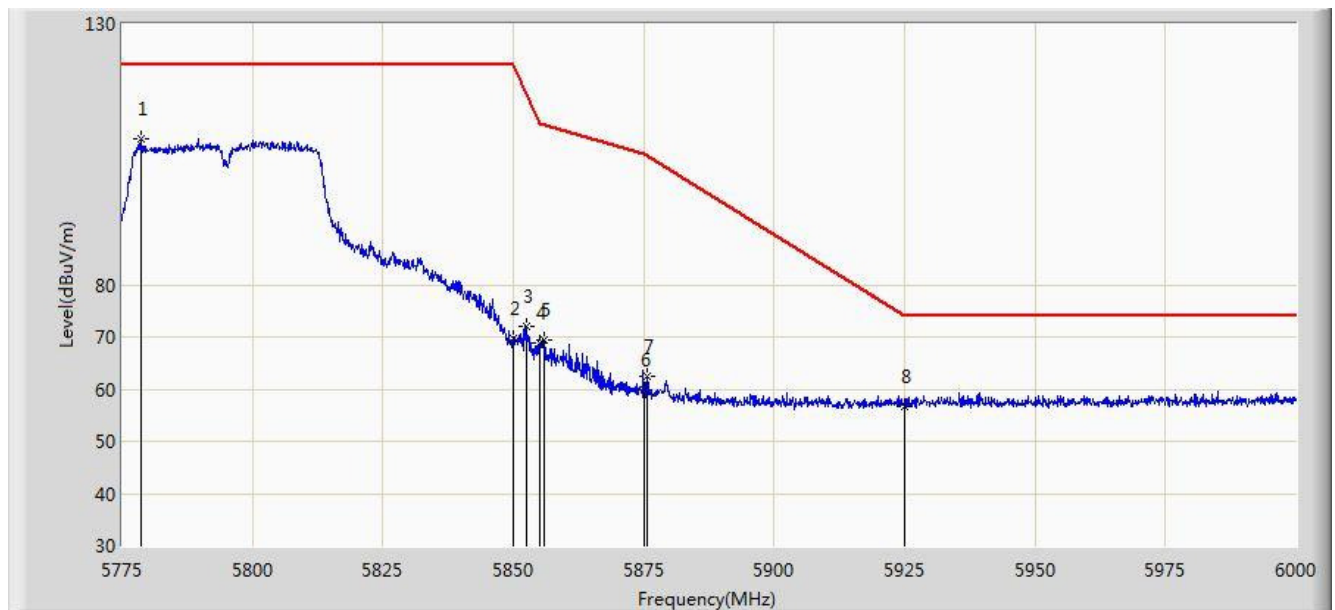

| No | Flag | Mark | Frequency (MHz) | Measure Level (dBuV/m) | Reading Level (dBuV) | Over Limit (dB) | Limit (dBuV/m) | Factor (dB) | Type |
|----|------|------|-----------------|------------------------|----------------------|-----------------|----------------|-------------|------|
| 1  |      | *    | 5778.712        | 107.856                | 103.445              | N/A             | N/A            | 4.410       | PK   |
| 2  |      |      | 5850.000        | 69.598                 | 64.603               | -52.602         | 122.200        | 4.995       | PK   |
| 3  |      |      | 5852.513        | 72.164                 | 67.173               | -44.305         | 116.469        | 4.991       | PK   |
| 4  |      |      | 5855.000        | 68.848                 | 63.860               | -41.952         | 110.800        | 4.987       | PK   |
| 5  |      |      | 5855.888        | 69.392                 | 64.406               | -41.159         | 110.551        | 4.986       | PK   |
| 6  |      |      | 5875.000        | 59.968                 | 54.961               | -45.232         | 105.200        | 5.008       | PK   |
| 7  |      |      | 5875.575        | 62.332                 | 57.318               | -42.508         | 104.840        | 5.014       | PK   |
| 8  |      |      | 5925.000        | 56.752                 | 51.600               | -17.248         | 74.000         | 5.152       | PK   |

Note: Measure Level (dB $\mu$ V/m) = Reading Level (dB $\mu$ V) + Factor (dB)

Factor (dB) = Cable Loss (dB) + Antenna Factor (dB/m) - Pre\_Amplifier Gain (dB)

**Panel Antenna**

|   |                          |
|---|--------------------------|
| Site: AC2   | Time: 2016/08/27 - 12:00 |
| Limit: FCC_Part15.209_RE(3m)                            | Engineer: Bruce Wang     |
| Probe: BBHA9120D_1-18GHz                                | Polarity: Vertical       |
| EUT: WIRELESS-ABGN 2X2 NETWORK MINIPCIE ADAPTER         | Power: AC 120V/60Hz      |
| Test Mode: Transmit by 802.11a at Channel 5180MHz Ant 0 |                          |

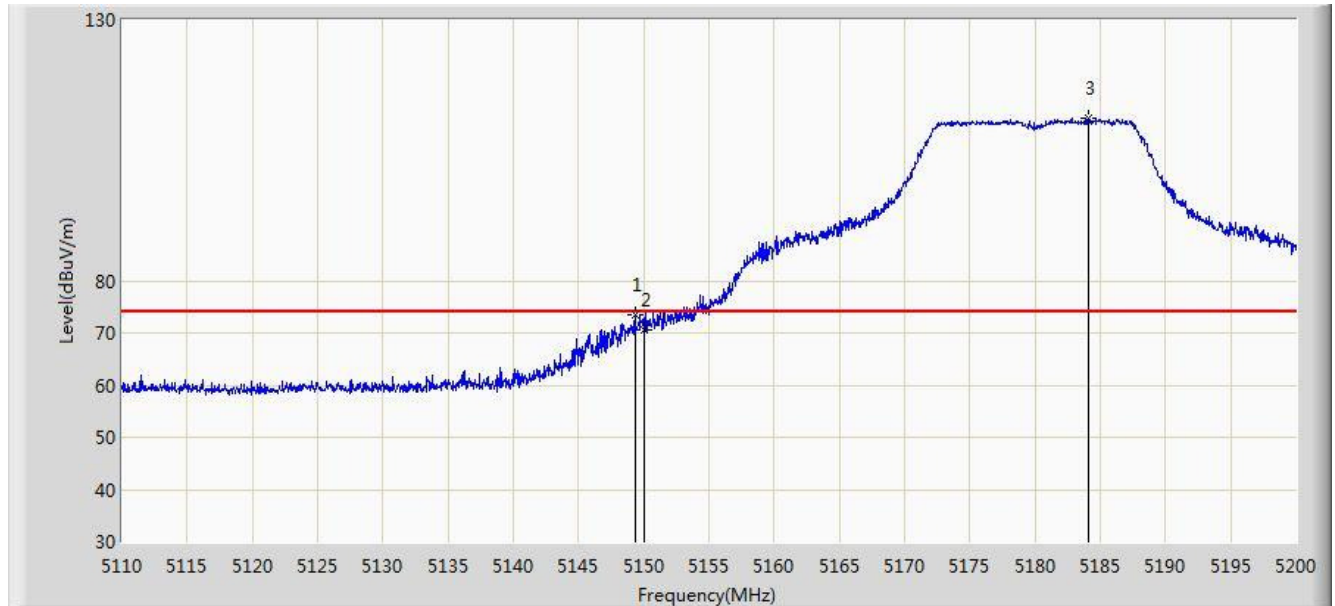

| No | Flag | Mark | Frequency (MHz) | Measure Level (dBuV/m) | Reading Level (dBuV) | Over Limit (dB) | Limit (dBuV/m) | Factor | Type |
|----|------|------|-----------------|------------------------|----------------------|-----------------|----------------|--------|------|
| 1  |      |      | 5149.330        | 73.444                 | 70.373               | -0.556          | 74.000         | 3.071  | PK   |
| 2  |      |      | 5150.000        | 70.697                 | 67.627               | -3.303          | 74.000         | 3.069  | PK   |
| 3  |      | *    | 5184.115        | 111.261                | 108.236              | N/A             | N/A            | 3.025  | PK   |

Note: Measure Level (dBuV/m) = Reading Level (dBuV) + Factor (dB)

Factor (dB) = Cable Loss (dB) + Antenna Factor (dB/m) - Pre\_Amplifier Gain (dB)

|   |                          |
|---|--------------------------|
| Site: AC2   | Time: 2016/08/27 - 12:03 |
| Limit: FCC_Part15.209_RE(3m)                            | Engineer: Bruce Wang     |
| Probe: BBHA9120D_1-18GHz                                | Polarity: Vertical       |
| EUT: WIRELESS-ABGN 2X2 NETWORK MINIPCIE ADAPTER         | Power: AC 120V/60Hz      |
| Test Mode: Transmit by 802.11a at Channel 5180MHz Ant 0 |                          |

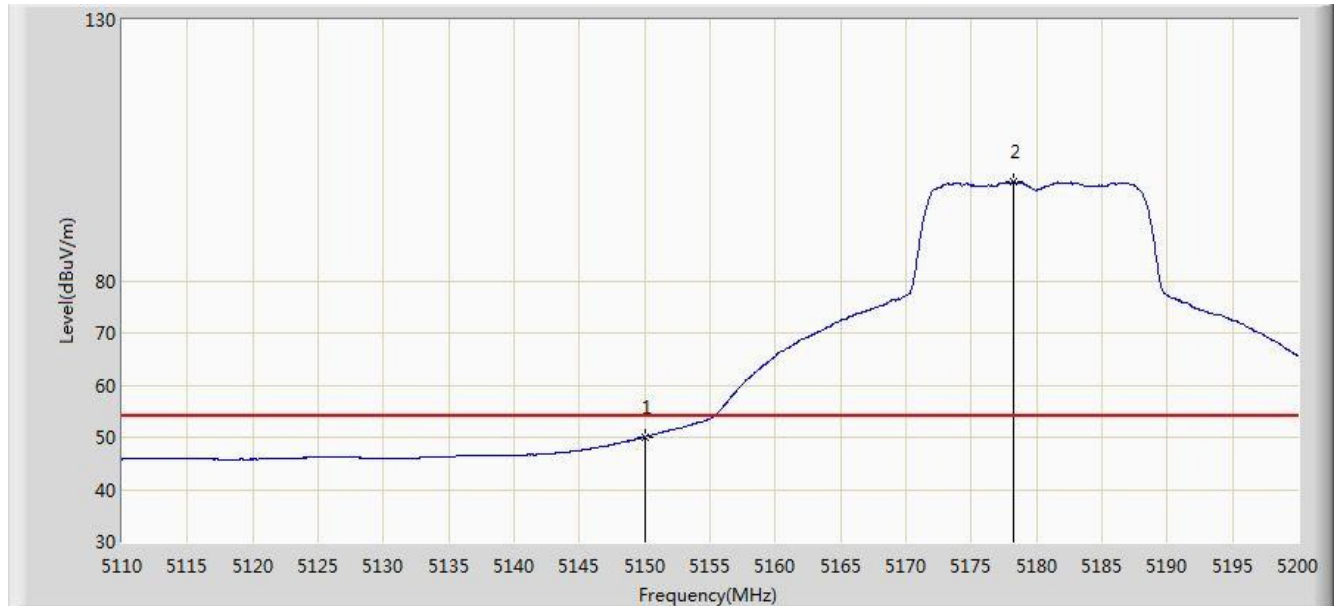

| No | Flag | Mark | Frequency (MHz) | Measure Level (dBuV/m) | Reading Level (dBuV) | Over Limit (dB) | Limit (dBuV/m) | Factor | Type |
|----|------|------|-----------------|------------------------|----------------------|-----------------|----------------|--------|------|
| 1  |      |      | 5150.000        | 50.095                 | 47.025               | -3.905          | 54.000         | 3.069  | AV   |
| 2  |      | *    | 5178.265        | 98.879                 | 95.843               | N/A             | N/A            | 3.036  | AV   |

Note: Measure Level (dBμV/m) = Reading Level (dBμV) + Factor (dB)

Factor (dB) = Cable Loss (dB) + Antenna Factor (dB/m) - Pre\_Amplifier Gain (dB)

|   |                          |
|---|--------------------------|
| Site: AC2   | Time: 2016/08/27 - 12:10 |
| Limit: FCC_Part15.209_RE(3m)                            | Engineer: Bruce Wang     |
| Probe: BBHA9120D_1-18GHz                                | Polarity: Horizontal     |
| EUT: WIRELESS-ABGN 2X2 NETWORK MINIPCIE ADAPTER         | Power: AC 120V/60Hz      |
| Test Mode: Transmit by 802.11a at Channel 5180MHz Ant 0 |                          |

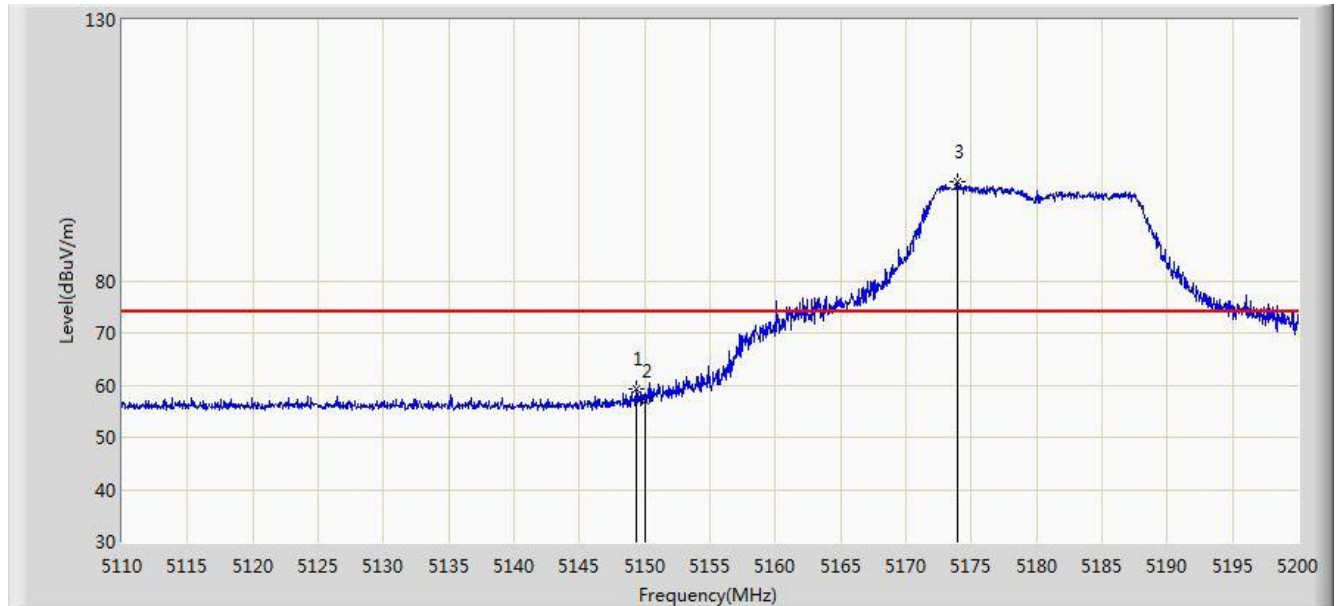

| No | Flag | Mark | Frequency (MHz) | Measure Level (dBuV/m) | Reading Level (dBuV) | Over Limit (dB) | Limit (dBuV/m) | Factor | Type |
|----|------|------|-----------------|------------------------|----------------------|-----------------|----------------|--------|------|
| 1  |      |      | 5149.330        | 59.231                 | 56.160               | -14.769         | 74.000         | 3.071  | PK   |
| 2  |      |      | 5150.000        | 56.898                 | 53.828               | -17.102         | 74.000         | 3.069  | PK   |
| 3  |      | *    | 5173.900        | 98.853                 | 95.834               | N/A             | N/A            | 3.019  | PK   |

Note: Measure Level (dBuV/m) = Reading Level (dBuV) + Factor (dB)

Factor (dB) = Cable Loss (dB) + Antenna Factor (dB/m) - Pre\_Amplifier Gain (dB)

|   |                          |
|---|--------------------------|
| Site: AC2   | Time: 2016/08/27 - 12:14 |
| Limit: FCC_Part15.209_RE(3m)                            | Engineer: Bruce Wang     |
| Probe: BBHA9120D_1-18GHz                                | Polarity: Horizontal     |
| EUT: WIRELESS-ABGN 2X2 NETWORK MINIPCIE ADAPTER         | Power: AC 120V/60Hz      |
| Test Mode: Transmit by 802.11a at Channel 5180MHz Ant 0 |                          |

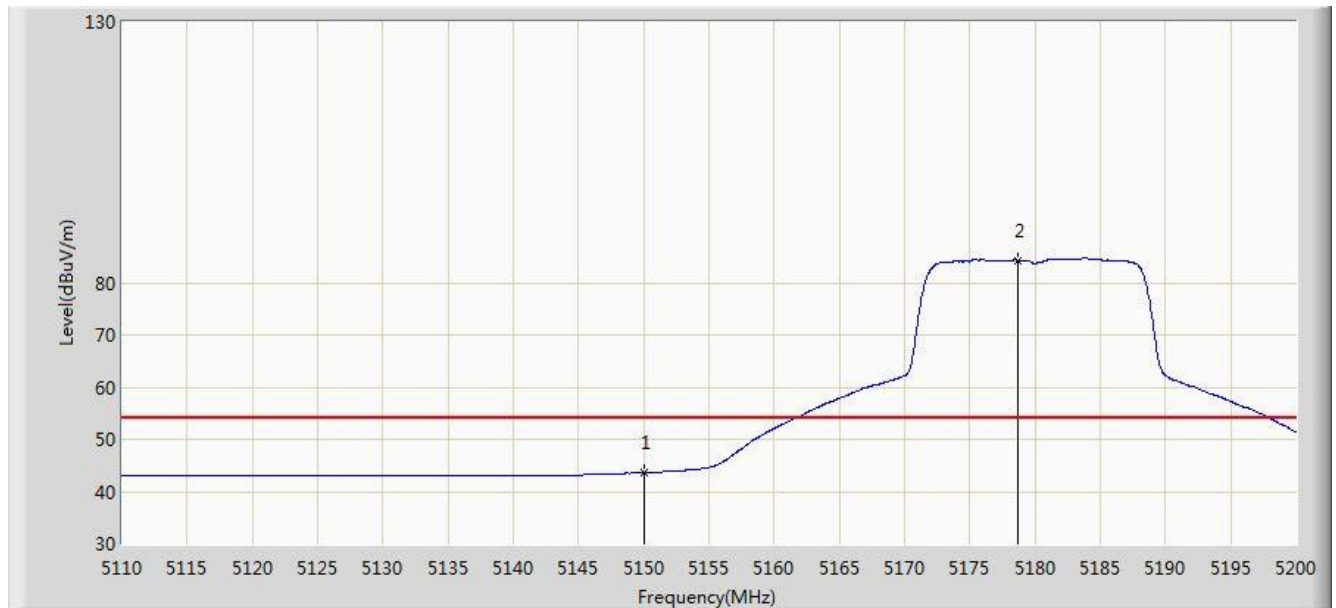

| No | Flag | Mark | Frequency (MHz) | Measure Level (dBuV/m) | Reading Level (dBuV) | Over Limit (dB) | Limit (dBuV/m) | Factor | Type |
|----|------|------|-----------------|------------------------|----------------------|-----------------|----------------|--------|------|
| 1  |      |      | 5150.000        | 43.647                 | 40.577               | -10.353         | 54.000         | 3.069  | AV   |
| 2  |      | *    | 5178.670        | 84.342                 | 81.304               | N/A             | N/A            | 3.038  | AV   |

Note: Measure Level (dBμV/m) = Reading Level (dBμV) + Factor (dB)

Factor (dB) = Cable Loss (dB) + Antenna Factor (dB/m) - Pre\_Amplifier Gain (dB)

|   |                          |
|---|--------------------------|
| Site: AC2   | Time: 2016/08/27 - 13:43 |
| Limit: FCC_Part15.209_RE(3m)                            | Engineer: Bruce Wang     |
| Probe: BBHA9120D_1-18GHz                                | Polarity: Vertical       |
| EUT: WIRELESS-ABGN 2X2 NETWORK MINIPCIE ADAPTER         | Power: AC 120V/60Hz      |
| Test Mode: Transmit by 802.11a at Channel 5320MHz Ant 0 |                          |

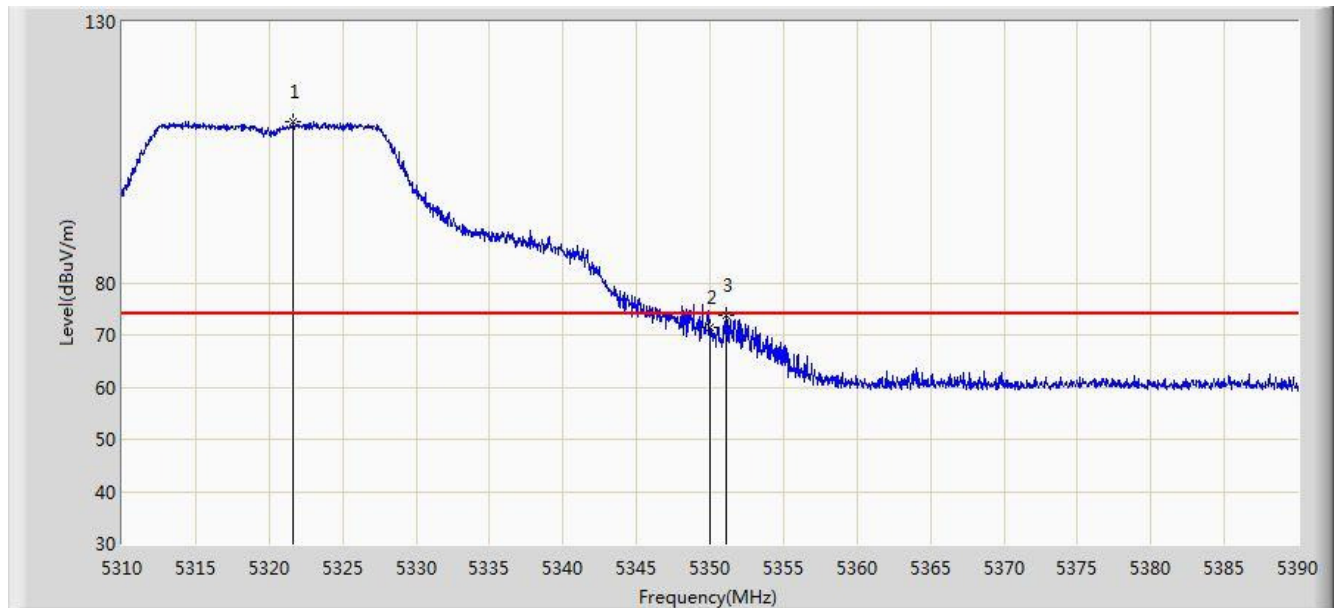

| No | Flag | Mark | Frequency (MHz) | Measure Level (dBuV/m) | Reading Level (dBuV) | Over Limit (dB) | Limit (dBuV/m) | Factor | Type |
|----|------|------|-----------------|------------------------|----------------------|-----------------|----------------|--------|------|
| 1  |      | *    | 5321.640        | 110.736                | 108.067              | N/A             | N/A            | 2.669  | PK   |
| 2  |      |      | 5350.000        | 71.471                 | 68.774               | -2.529          | 74.000         | 2.697  | PK   |
| 3  |      |      | 5351.120        | 73.649                 | 70.948               | -0.351          | 74.000         | 2.701  | PK   |

Note: Measure Level (dBuV/m) = Reading Level (dBuV) + Factor (dB)

Factor (dB) = Cable Loss (dB) + Antenna Factor (dB/m) - Pre\_Amplifier Gain (dB)



|   |                          |
|---|--------------------------|
| Site: AC2   | Time: 2016/08/27 - 13:45 |
| Limit: FCC_Part15.209_RE(3m)                            | Engineer: Bruce Wang     |
| Probe: BBHA9120D_1-18GHz                                | Polarity: Vertical       |
| EUT: WIRELESS-ABGN 2X2 NETWORK MINIPCIE ADAPTER         | Power: AC 120V/60Hz      |
| Test Mode: Transmit by 802.11a at Channel 5320MHz Ant 0 |                          |

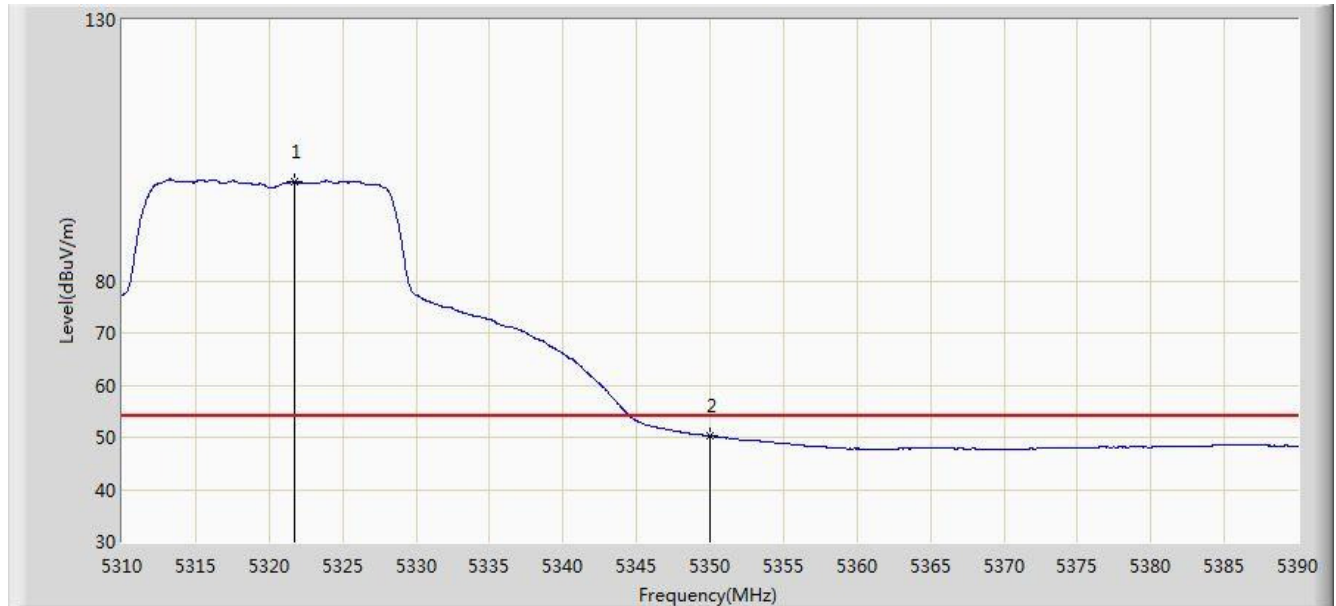

| No | Flag | Mark | Frequency (MHz) | Measure Level (dBuV/m) | Reading Level (dBuV) | Over Limit (dB) | Limit (dBuV/m) | Factor | Type |
|----|------|------|-----------------|------------------------|----------------------|-----------------|----------------|--------|------|
| 1  |      | *    | 5321.680        | 99.101                 | 96.432               | N/A             | N/A            | 2.669  | AV   |
| 2  |      |      | 5350.000        | 50.167                 | 47.470               | -3.833          | 54.000         | 2.697  | AV   |

Note: Measure Level (dBμV/m) = Reading Level (dBμV) + Factor (dB)

Factor (dB) = Cable Loss (dB) + Antenna Factor (dB/m) - Pre\_Amplifier Gain (dB)

|   |                          |
|---|--------------------------|
| Site: AC2   | Time: 2016/08/27 - 13:47 |
| Limit: FCC_Part15.209_RE(3m)                            | Engineer: Bruce Wang     |
| Probe: BBHA9120D_1-18GHz                                | Polarity: Horizontal     |
| EUT: WIRELESS-ABGN 2X2 NETWORK MINIPCIE ADAPTER         | Power: AC 120V/60Hz      |
| Test Mode: Transmit by 802.11a at Channel 5320MHz Ant 0 |                          |

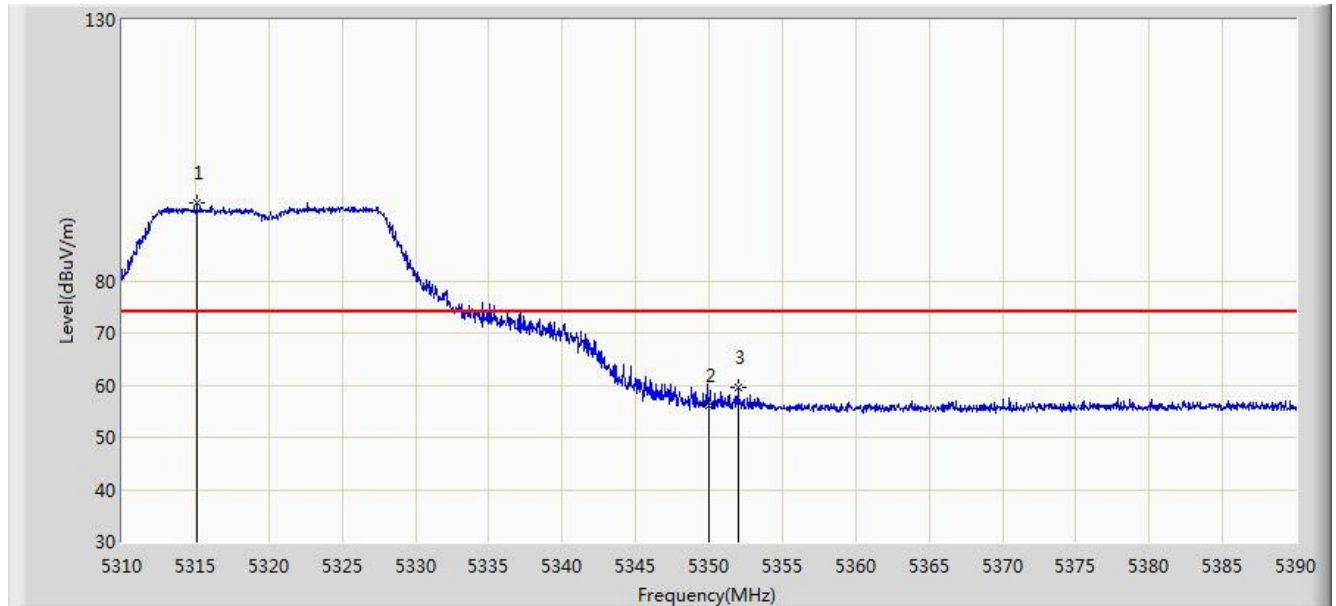

| No | Flag | Mark | Frequency (MHz) | Measure Level (dBuV/m) | Reading Level (dBuV) | Over Limit (dB) | Limit (dBuV/m) | Factor | Type |
|----|------|------|-----------------|------------------------|----------------------|-----------------|----------------|--------|------|
| 1  |      | *    | 5315.120        | 95.011                 | 92.384               | N/A             | N/A            | 2.627  | PK   |
| 2  |      |      | 5350.000        | 56.124                 | 53.427               | -17.876         | 74.000         | 2.697  | PK   |
| 3  |      |      | 5351.960        | 59.625                 | 56.920               | -14.375         | 74.000         | 2.705  | PK   |

Note: Measure Level (dB $\mu$ V/m) = Reading Level (dB $\mu$ V) + Factor (dB)

Factor (dB) = Cable Loss (dB) + Antenna Factor (dB/m) - Pre\_Amplifier Gain (dB)

|   |                          |
|---|--------------------------|
| Site: AC2   | Time: 2016/08/27 - 13:49 |
| Limit: FCC_Part15.209_RE(3m)                            | Engineer: Bruce Wang     |
| Probe: BBHA9120D_1-18GHz                                | Polarity: Horizontal     |
| EUT: WIRELESS-ABGN 2X2 NETWORK MINIPCIE ADAPTER         | Power: AC 120V/60Hz      |
| Test Mode: Transmit by 802.11a at Channel 5320MHz Ant 0 |                          |

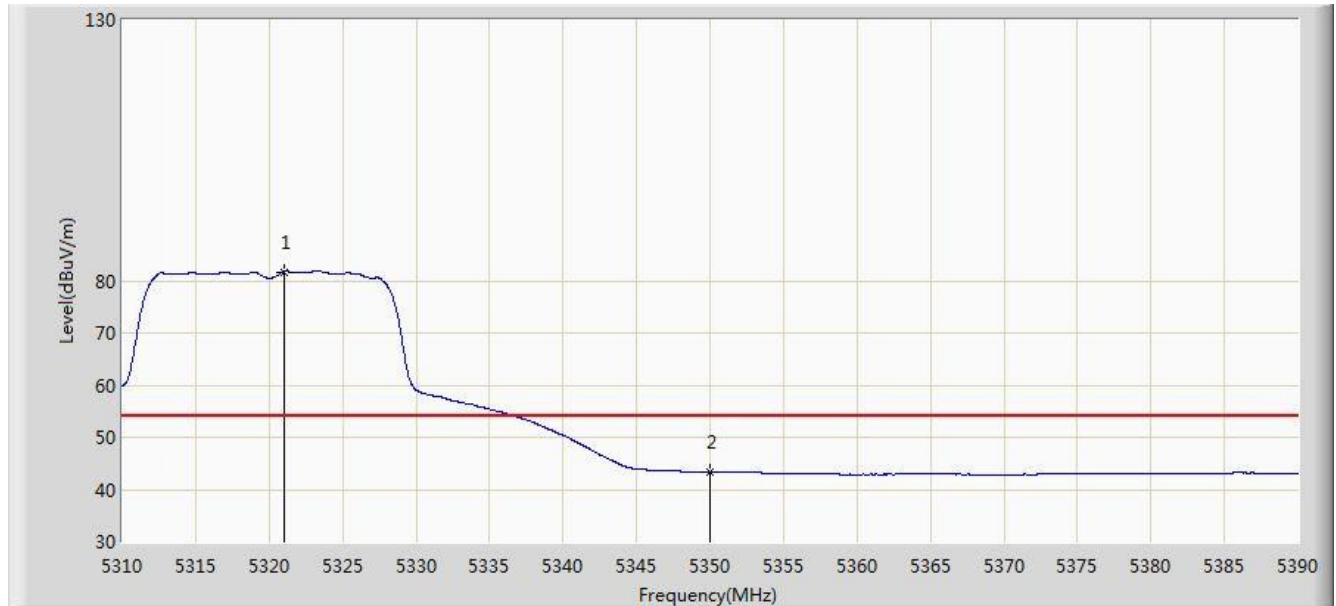

| No | Flag | Mark | Frequency (MHz) | Measure Level (dBuV/m) | Reading Level (dBuV) | Over Limit (dB) | Limit (dBuV/m) | Factor | Type |
|----|------|------|-----------------|------------------------|----------------------|-----------------|----------------|--------|------|
| 1  |      | *    | 5321.000        | 81.728                 | 79.062               | N/A             | N/A            | 2.667  | AV   |
| 2  |      |      | 5350.000        | 43.290                 | 40.593               | -10.710         | 54.000         | 2.697  | AV   |

Note: Measure Level (dBμV/m) = Reading Level (dBμV) + Factor (dB)

Factor (dB) = Cable Loss (dB) + Antenna Factor (dB/m) - Pre\_Amplifier Gain (dB)

|   |                          |
|---|--------------------------|
| Site: AC2   | Time: 2016/08/27 - 15:57 |
| Limit: FCC_Part15.209_RE(3m)                            | Engineer: Bruce Wang     |
| Probe: BBHA9120D_1-18GHz                                | Polarity: Vertical       |
| EUT: WIRELESS-ABGN 2X2 NETWORK MINIPCIE ADAPTER         | Power: AC 120V/60Hz      |
| Test Mode: Transmit by 802.11a at Channel 5500MHz Ant 0 |                          |

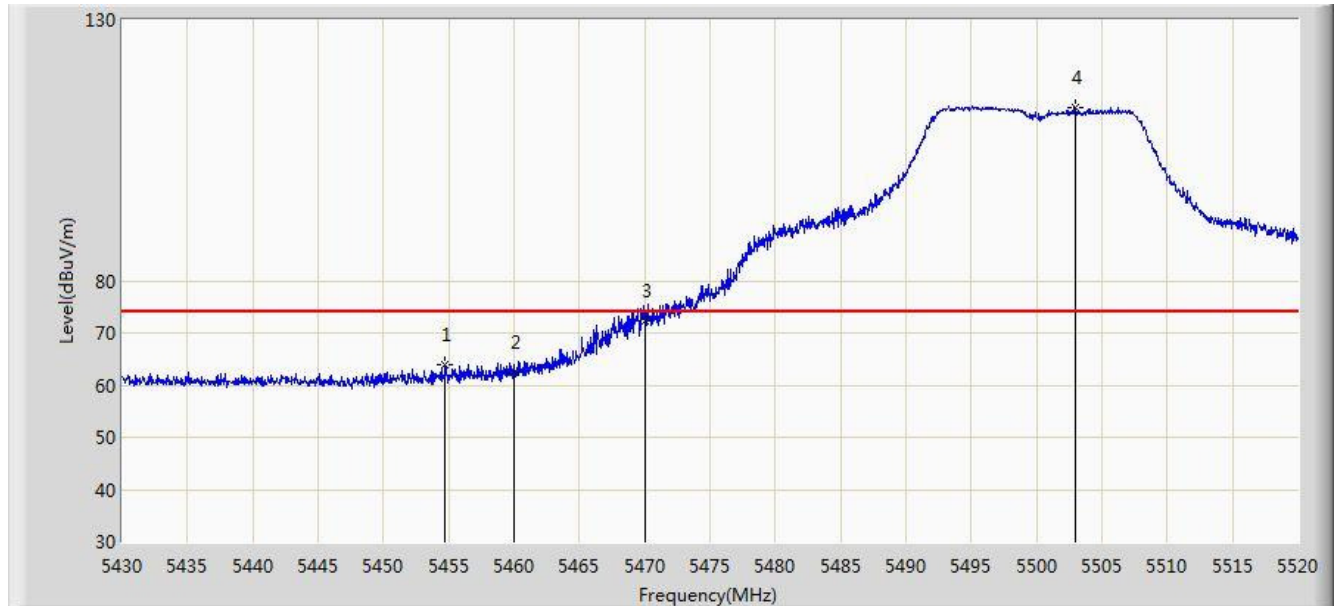

| No | Flag | Mark | Frequency (MHz) | Measure Level (dBuV/m) | Reading Level (dBuV) | Over Limit (dB) | Limit (dBuV/m) | Factor | Type |
|----|------|------|-----------------|------------------------|----------------------|-----------------|----------------|--------|------|
| 1  |      |      | 5454.705        | 63.802                 | 60.787               | -10.198         | 74.000         | 3.015  | PK   |
| 2  |      |      | 5460.000        | 62.579                 | 59.386               | -11.421         | 74.000         | 3.194  | PK   |
| 3  |      |      | 5470.000        | 72.229                 | 68.700               | -1.771          | 74.000         | 3.529  | PK   |
| 4  |      | *    | 5502.990        | 113.096                | 110.011              | N/A             | N/A            | 3.085  | PK   |

Note: Measure Level (dB $\mu$ V/m) = Reading Level (dB $\mu$ V) + Factor (dB)

Factor (dB) = Cable Loss (dB) + Antenna Factor (dB/m) - Pre\_Amplifier Gain (dB)

|   |                          |
|---|--------------------------|
| Site: AC2   | Time: 2016/08/27 - 15:59 |
| Limit: FCC_Part15.209_RE(3m)                            | Engineer: Bruce Wang     |
| Probe: BBHA9120D_1-18GHz                                | Polarity: Vertical       |
| EUT: WIRELESS-ABGN 2X2 NETWORK MINIPCIE ADAPTER         | Power: AC 120V/60Hz      |
| Test Mode: Transmit by 802.11a at Channel 5500MHz Ant 0 |                          |

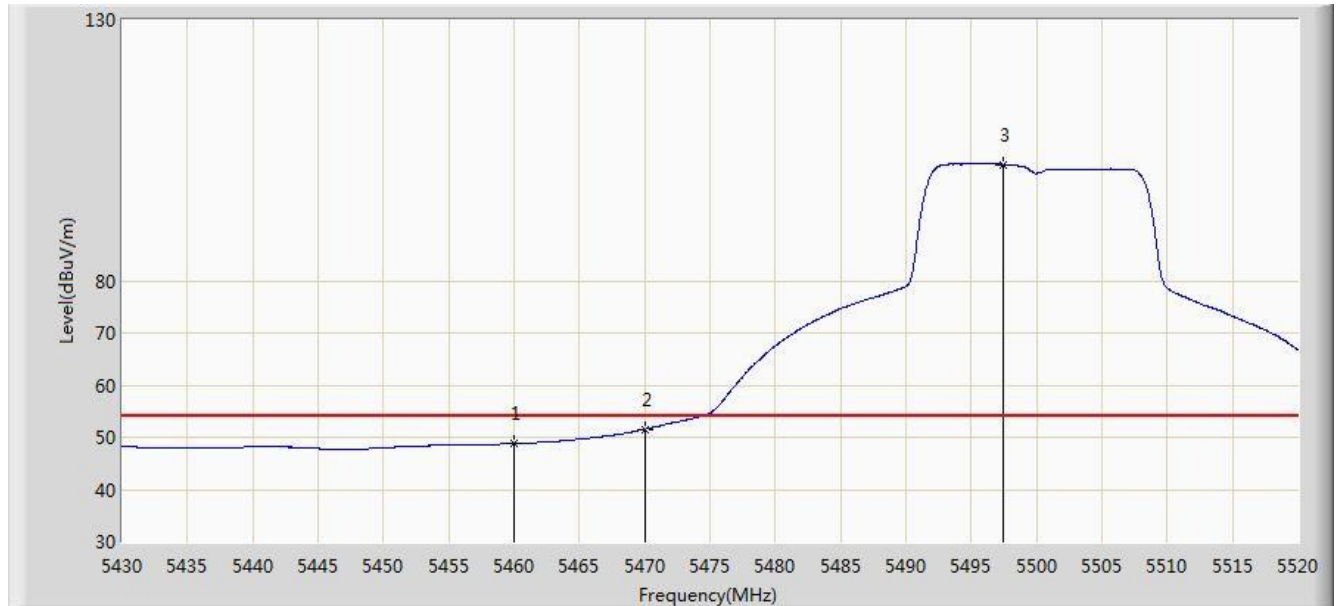

| No | Flag | Mark | Frequency (MHz) | Measure Level (dBuV/m) | Reading Level (dBuV) | Over Limit (dB) | Limit (dBuV/m) | Factor | Type |
|----|------|------|-----------------|------------------------|----------------------|-----------------|----------------|--------|------|
| 1  |      |      | 5460.000        | 48.814                 | 45.621               | -5.186          | 54.000         | 3.194  | AV   |
| 2  |      |      | 5470.000        | 51.563                 | 48.034               | -2.437          | 54.000         | 3.529  | AV   |
| 3  |      | *    | 5497.410        | 102.232                | 99.094               | N/A             | N/A            | 3.138  | AV   |

Note: Measure Level (dB $\mu$ V/m) = Reading Level (dB $\mu$ V) + Factor (dB)

Factor (dB) = Cable Loss (dB) + Antenna Factor (dB/m) - Pre\_Amplifier Gain (dB)

|   |                          |
|---|--------------------------|
| Site: AC2   | Time: 2016/08/27 - 16:02 |
| Limit: FCC_Part15.209_RE(3m)                            | Engineer: Bruce Wang     |
| Probe: BBHA9120D_1-18GHz                                | Polarity: Horizontal     |
| EUT: WIRELESS-ABGN 2X2 NETWORK MINIPCIE ADAPTER         | Power: AC 120V/60Hz      |
| Test Mode: Transmit by 802.11a at Channel 5500MHz Ant 0 |                          |

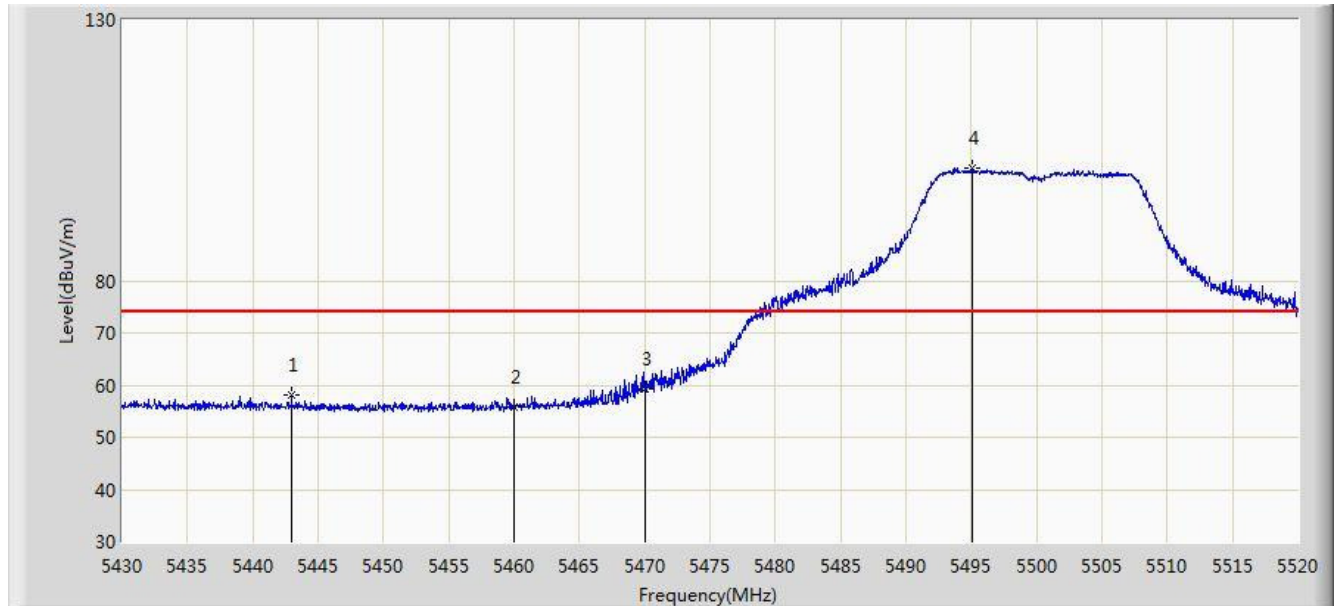

| No | Flag | Mark | Frequency (MHz) | Measure Level (dBuV/m) | Reading Level (dBuV) | Over Limit (dB) | Limit (dBuV/m) | Factor | Type |
|----|------|------|-----------------|------------------------|----------------------|-----------------|----------------|--------|------|
| 1  |      |      | 5442.960        | 58.087                 | 54.921               | -15.913         | 74.000         | 3.166  | PK   |
| 2  |      |      | 5460.000        | 55.721                 | 52.528               | -18.279         | 74.000         | 3.194  | PK   |
| 3  |      |      | 5470.000        | 59.221                 | 55.692               | -14.779         | 74.000         | 3.529  | PK   |
| 4  |      | *    | 5495.115        | 101.681                | 98.521               | N/A             | N/A            | 3.161  | PK   |

Note: Measure Level (dB $\mu$ V/m) = Reading Level (dB $\mu$ V) + Factor (dB)

Factor (dB) = Cable Loss (dB) + Antenna Factor (dB/m) - Pre\_Amplifier Gain (dB)

|   |                          |
|---|--------------------------|
| Site: AC2   | Time: 2016/08/27 - 16:04 |
| Limit: FCC_Part15.209_RE(3m)                            | Engineer: Bruce Wang     |
| Probe: BBHA9120D_1-18GHz                                | Polarity: Horizontal     |
| EUT: WIRELESS-ABGN 2X2 NETWORK MINIPCIE ADAPTER         | Power: AC 120V/60Hz      |
| Test Mode: Transmit by 802.11a at Channel 5500MHz Ant 0 |                          |

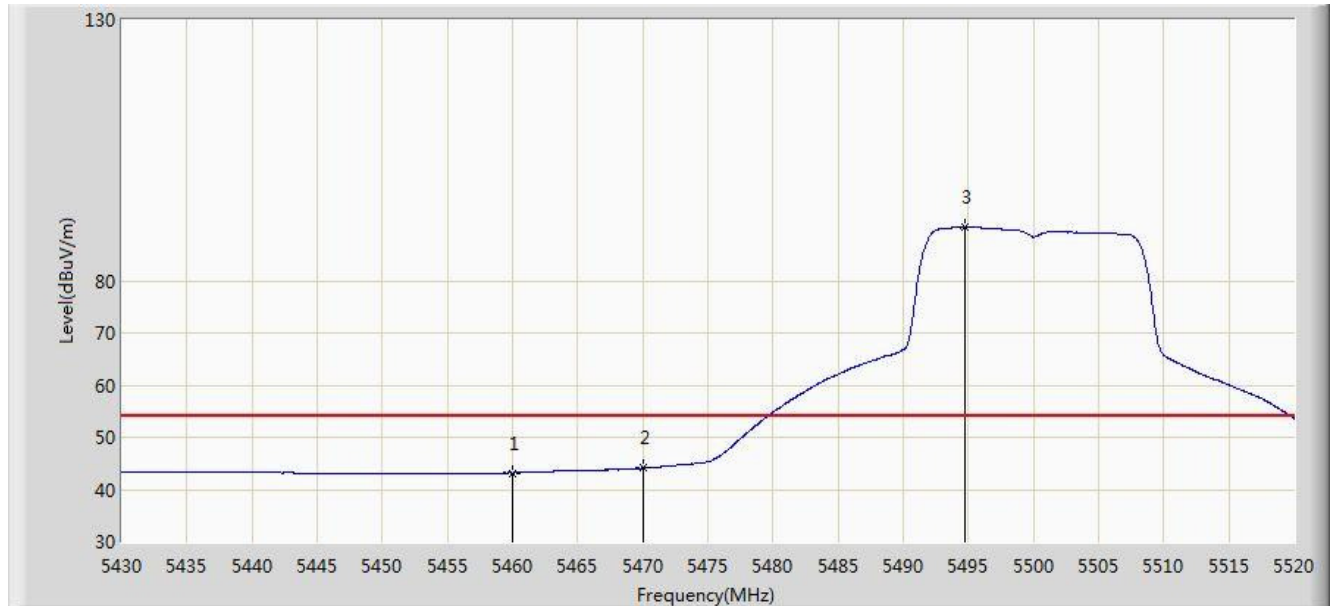

| No | Flag | Mark | Frequency (MHz) | Measure Level (dBuV/m) | Reading Level (dBuV) | Over Limit (dB) | Limit (dBuV/m) | Factor | Type |
|----|------|------|-----------------|------------------------|----------------------|-----------------|----------------|--------|------|
| 1  |      |      | 5460.000        | 43.180                 | 39.987               | -10.820         | 54.000         | 3.194  | AV   |
| 2  |      |      | 5470.000        | 44.087                 | 40.558               | -9.913          | 54.000         | 3.529  | AV   |
| 3  |      | *    | 5494.755        | 90.177                 | 87.013               | N/A             | N/A            | 3.163  | AV   |

Note: Measure Level (dBuV/m) = Reading Level (dBuV) + Factor (dB)

Factor (dB) = Cable Loss (dB) + Antenna Factor (dB/m) - Pre\_Amplifier Gain (dB)

|   |                          |
|---|--------------------------|
| Site: AC2   | Time: 2016/08/27 - 16:19 |
| Limit: FCC_Part15.209_RE(3m)                            | Engineer: Bruce Wang     |
| Probe: BBHA9120D_1-18GHz                                | Polarity: Vertical       |
| EUT: WIRELESS-ABGN 2X2 NETWORK MINIPCIE ADAPTER         | Power: AC 120V/60Hz      |
| Test Mode: Transmit by 802.11a at Channel 5700MHz Ant 0 |                          |

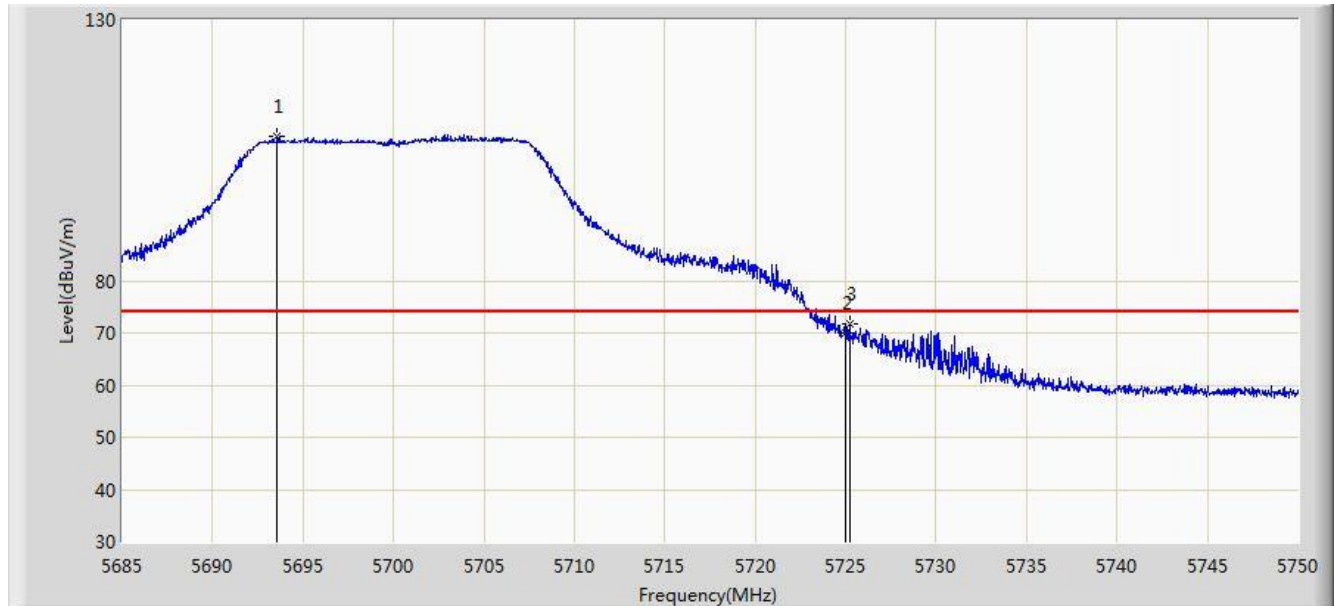

| No | Flag | Mark | Frequency (MHz) | Measure Level (dBuV/m) | Reading Level (dBuV) | Over Limit (dB) | Limit (dBuV/m) | Factor | Type |
|----|------|------|-----------------|------------------------|----------------------|-----------------|----------------|--------|------|
| 1  |      | *    | 5693.580        | 107.590                | 103.586              | N/A             | N/A            | 4.005  | PK   |
| 2  |      |      | 5725.000        | 69.991                 | 65.885               | -4.009          | 74.000         | 4.105  | PK   |
| 3  |      |      | 5725.203        | 71.848                 | 67.737               | -2.152          | 74.000         | 4.111  | PK   |

Note: Measure Level (dBμV/m) = Reading Level (dBμV) + Factor (dB)

Factor (dB) = Cable Loss (dB) + Antenna Factor (dB/m) - Pre\_Amplifier Gain (dB)



|   |                          |
|---|--------------------------|
| Site: AC2   | Time: 2016/08/27 - 16:22 |
| Limit: FCC_Part15.209_RE(3m)                            | Engineer: Bruce Wang     |
| Probe: BBHA9120D_1-18GHz                                | Polarity: Vertical       |
| EUT: WIRELESS-ABGN 2X2 NETWORK MINIPCIE ADAPTER         | Power: AC 120V/60Hz      |
| Test Mode: Transmit by 802.11a at Channel 5700MHz Ant 0 |                          |

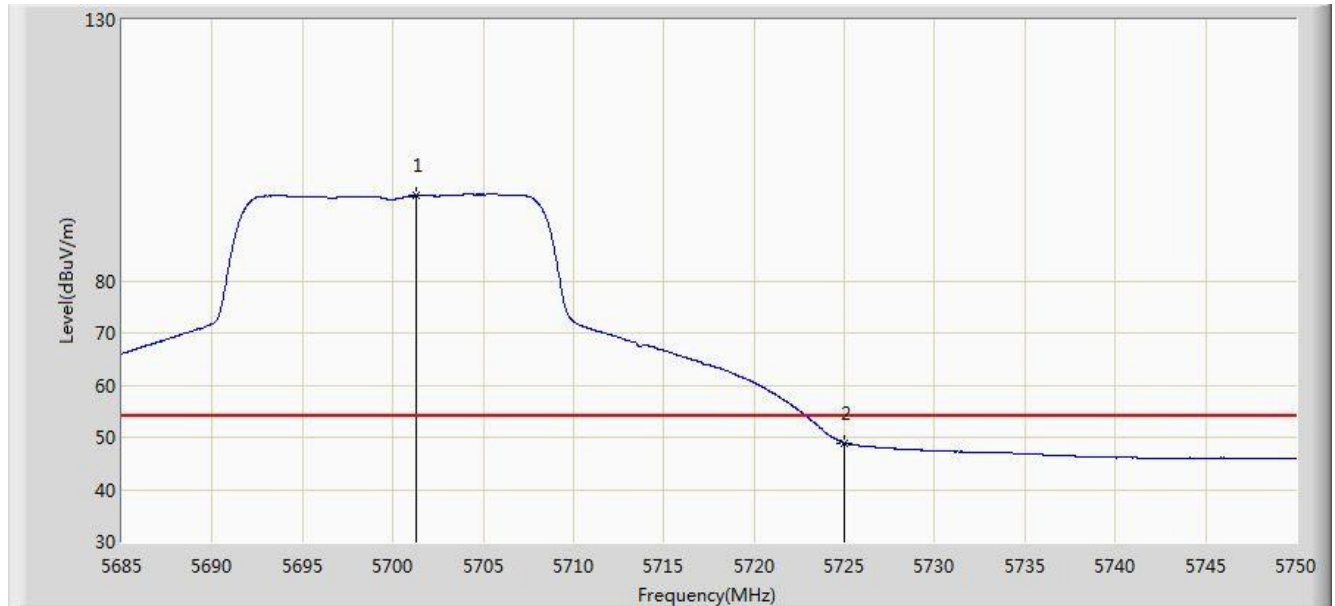

| No | Flag | Mark | Frequency (MHz) | Measure Level (dBuV/m) | Reading Level (dBuV) | Over Limit (dB) | Limit (dBuV/m) | Factor | Type |
|----|------|------|-----------------|------------------------|----------------------|-----------------|----------------|--------|------|
| 1  |      | *    | 5701.250        | 96.313                 | 92.387               | N/A             | N/A            | 3.927  | AV   |
| 2  |      |      | 5725.000        | 48.926                 | 44.820               | -5.074          | 54.000         | 4.105  | AV   |

Note: Measure Level (dB $\mu$ V/m) = Reading Level (dB $\mu$ V) + Factor (dB)

Factor (dB) = Cable Loss (dB) + Antenna Factor (dB/m) - Pre\_Amplifier Gain (dB)

|   |                          |
|---|--------------------------|
| Site: AC2   | Time: 2016/08/27 - 16:23 |
| Limit: FCC_Part15.209_RE(3m)                            | Engineer: Bruce Wang     |
| Probe: BBHA9120D_1-18GHz                                | Polarity: Horizontal     |
| EUT: WIRELESS-ABGN 2X2 NETWORK MINIPCIE ADAPTER         | Power: AC 120V/60Hz      |
| Test Mode: Transmit by 802.11a at Channel 5700MHz Ant 0 |                          |

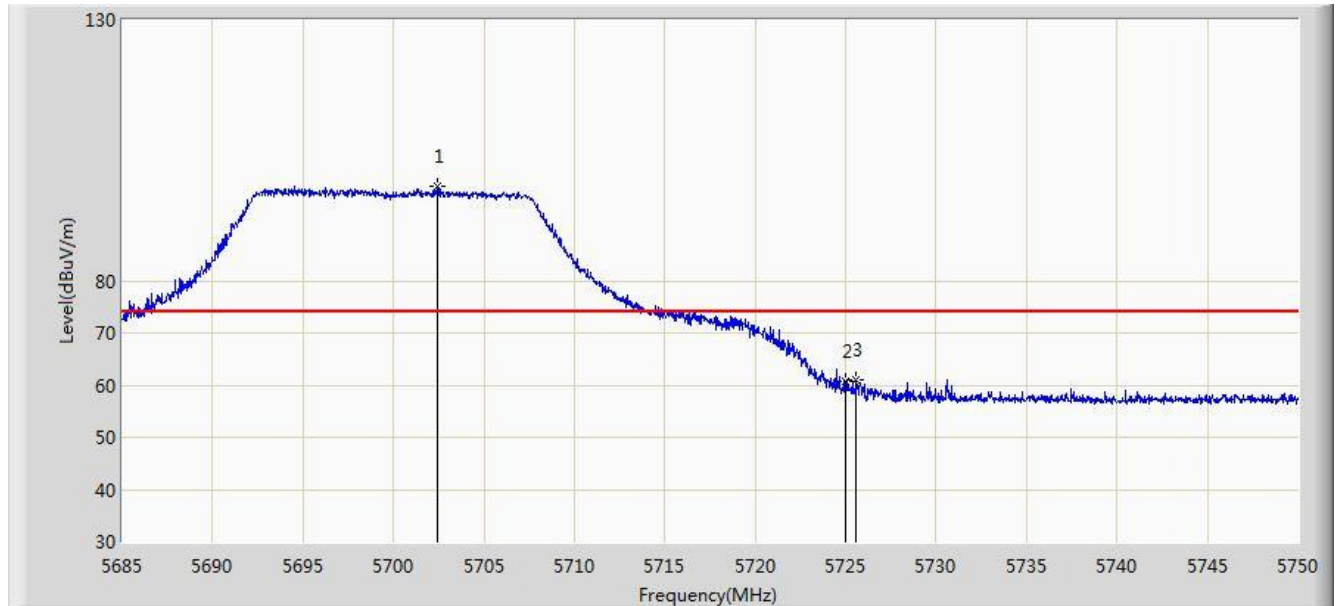

| No | Flag | Mark | Frequency (MHz) | Measure Level (dBuV/m) | Reading Level (dBuV) | Over Limit (dB) | Limit (dBuV/m) | Factor | Type |
|----|------|------|-----------------|------------------------|----------------------|-----------------|----------------|--------|------|
| 1  |      | *    | 5702.420        | 98.030                 | 94.116               | N/A             | N/A            | 3.914  | PK   |
| 2  |      |      | 5725.000        | 60.726                 | 56.620               | -13.274         | 74.000         | 4.105  | PK   |
| 3  |      |      | 5725.592        | 60.999                 | 56.879               | -13.001         | 74.000         | 4.120  | PK   |

Note: Measure Level (dBuV/m) = Reading Level (dBuV) + Factor (dB)

Factor (dB) = Cable Loss (dB) + Antenna Factor (dB/m) - Pre\_Amplifier Gain (dB)

|   |                          |
|---|--------------------------|
| Site: AC2   | Time: 2016/08/27 - 16:26 |
| Limit: FCC_Part15.209_RE(3m)                            | Engineer: Bruce Wang     |
| Probe: BBHA9120D_1-18GHz                                | Polarity: Horizontal     |
| EUT: WIRELESS-ABGN 2X2 NETWORK MINIPCIE ADAPTER         | Power: AC 120V/60Hz      |
| Test Mode: Transmit by 802.11a at Channel 5700MHz Ant 0 |                          |

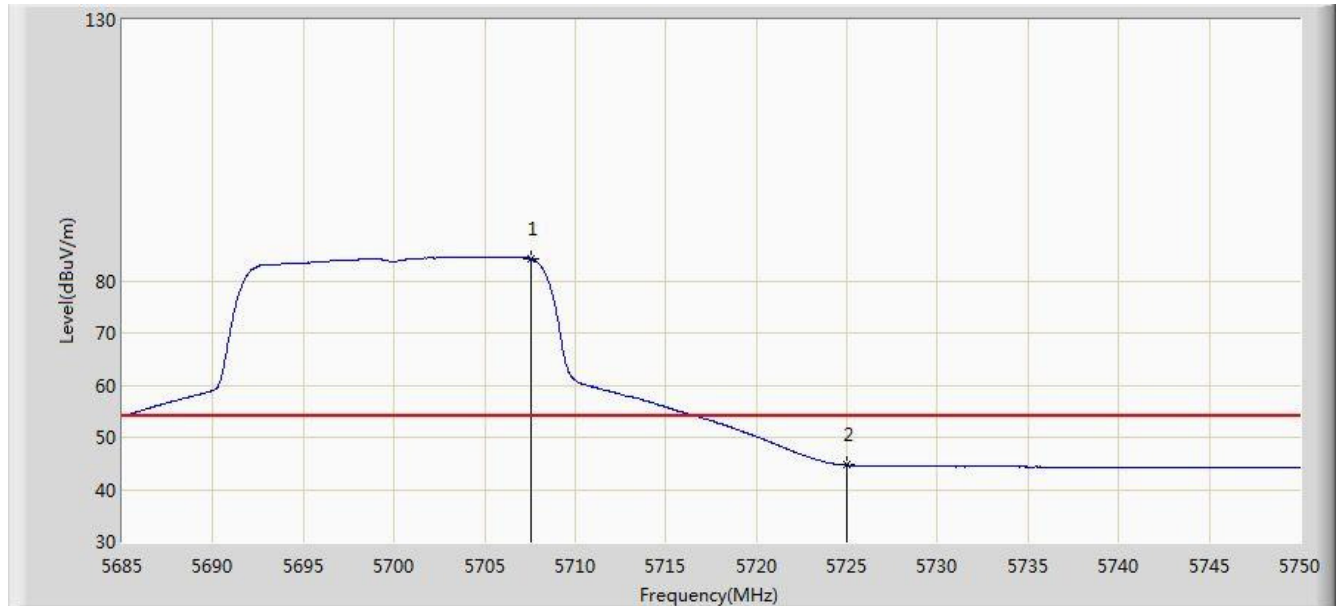

| No | Flag | Mark | Frequency (MHz) | Measure Level (dBuV/m) | Reading Level (dBuV) | Over Limit (dB) | Limit (dBuV/m) | Factor | Type |
|----|------|------|-----------------|------------------------|----------------------|-----------------|----------------|--------|------|
| 1  |      | *    | 5707.522        | 84.294                 | 80.427               | N/A             | N/A            | 3.866  | AV   |
| 2  |      |      | 5725.000        | 44.657                 | 40.551               | -9.343          | 54.000         | 4.105  | AV   |

Note: Measure Level (dBμV/m) = Reading Level (dBμV) + Factor (dB)

Factor (dB) = Cable Loss (dB) + Antenna Factor (dB/m) - Pre\_Amplifier Gain (dB)

|   |                          |
|---|--------------------------|
| Site: AC2   | Time: 2016/08/27 - 16:28 |
| Limit: FCC_Part15.407_RE(3m)                            | Engineer: Bruce Wang     |
| Probe: BBHA9120D_1-18GHz                                | Polarity: Vertical       |
| EUT: WIRELESS-ABGN 2X2 NETWORK MINIPCIE ADAPTER         | Power: AC 120V/60Hz      |
| Test Mode: Transmit by 802.11a at Channel 5745MHz Ant 0 |                          |

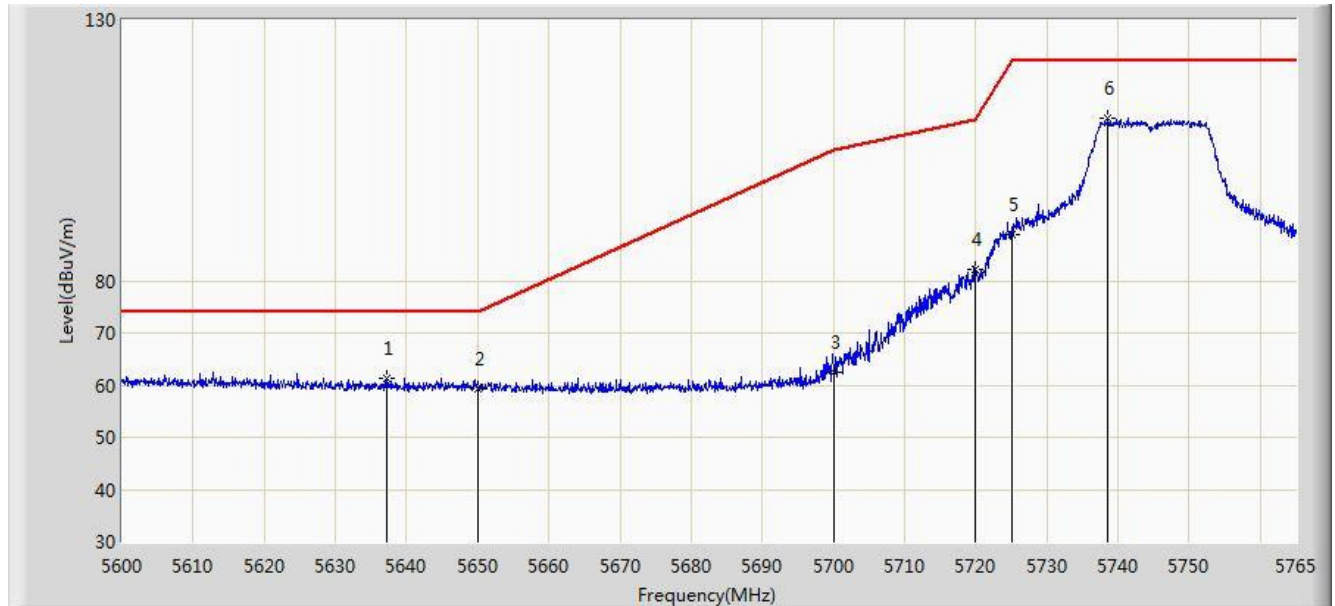

| No | Flag | Mark | Frequency (MHz) | Measure Level (dBuV/m) | Reading Level (dBuV) | Over Limit (dB) | Limit (dBuV/m) | Factor | Type |
|----|------|------|-----------------|------------------------|----------------------|-----------------|----------------|--------|------|
| 1  |      |      | 5637.125        | 61.424                 | 57.659               | -12.576         | 74.000         | 3.765  | PK   |
| 2  |      |      | 5650.000        | 59.169                 | 55.366               | -14.831         | 74.000         | 3.803  | PK   |
| 3  |      |      | 5700.000        | 62.565                 | 58.625               | -42.635         | 105.200        | 3.940  | PK   |
| 4  |      |      | 5720.000        | 82.138                 | 78.156               | -28.662         | 110.800        | 3.982  | PK   |
| 5  |      |      | 5725.000        | 88.902                 | 84.796               | -33.298         | 122.200        | 4.105  | PK   |
| 6  |      | *    | 5738.518        | 111.218                | 106.936              | N/A             | N/A            | 4.282  | PK   |

Note: Measure Level (dB $\mu$ V/m) = Reading Level (dB $\mu$ V) + Factor (dB)

Factor (dB) = Cable Loss (dB) + Antenna Factor (dB/m) - Pre\_Amplifier Gain (dB)

|   |                          |
|---|--------------------------|
| Site: AC2   | Time: 2016/08/27 - 16:37 |
| Limit: FCC_Part15.407_RE(3m)                            | Engineer: Bruce Wang     |
| Probe: BBHA9120D_1-18GHz                                | Polarity: Horizontal     |
| EUT: WIRELESS-ABGN 2X2 NETWORK MINIPCIE ADAPTER         | Power: AC 120V/60Hz      |
| Test Mode: Transmit by 802.11a at Channel 5745MHz Ant 0 |                          |

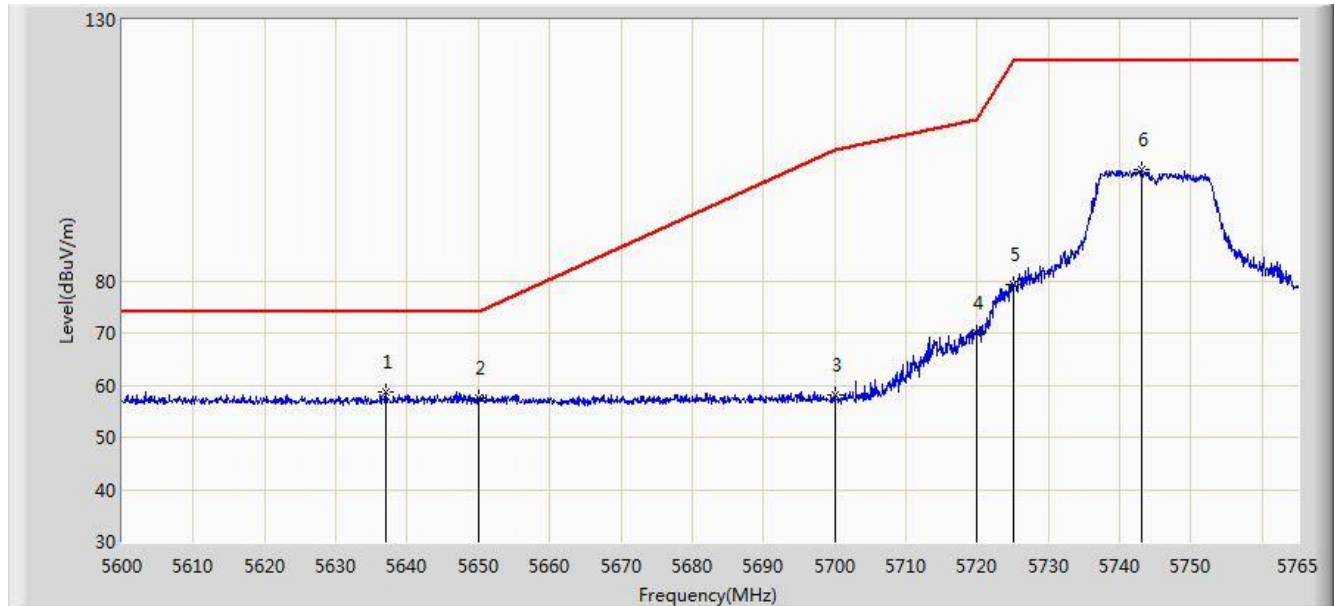

| No | Flag | Mark | Frequency (MHz) | Measure Level (dBuV/m) | Reading Level (dBuV) | Over Limit (dB) | Limit (dBuV/m) | Factor | Type |
|----|------|------|-----------------|------------------------|----------------------|-----------------|----------------|--------|------|
| 1  |      | *    | 5636.960        | 58.558                 | 54.796               | -15.442         | 74.000         | 3.761  | PK   |
| 2  |      |      | 5650.000        | 57.521                 | 53.718               | -16.479         | 74.000         | 3.803  | PK   |
| 3  |      |      | 5700.000        | 57.995                 | 54.055               | -47.205         | 105.200        | 3.940  | PK   |
| 4  |      |      | 5720.000        | 69.979                 | 65.997               | -40.821         | 110.800        | 3.982  | PK   |
| 5  |      |      | 5725.000        | 79.370                 | 75.264               | -42.830         | 122.200        | 4.105  | PK   |
| 6  |      |      | 5743.055        | 101.383                | 97.113               | N/A             | N/A            | 4.270  | PK   |

Note: Measure Level (dB $\mu$ V/m) = Reading Level (dB $\mu$ V) + Factor (dB)

Factor (dB) = Cable Loss (dB) + Antenna Factor (dB/m) - Pre\_Amplifier Gain (dB)

|   |                          |
|---|--------------------------|
| Site: AC2   | Time: 2016/08/27 - 16:41 |
| Limit: FCC_Part15.407_RE(3m)                            | Engineer: Bruce Wang     |
| Probe: BBHA9120D_1-18GHz                                | Polarity: Vertical       |
| EUT: WIRELESS-ABGN 2X2 NETWORK MINIPCIE ADAPTER         | Power: AC 120V/60Hz      |
| Test Mode: Transmit by 802.11a at Channel 5825MHz Ant 0 |                          |

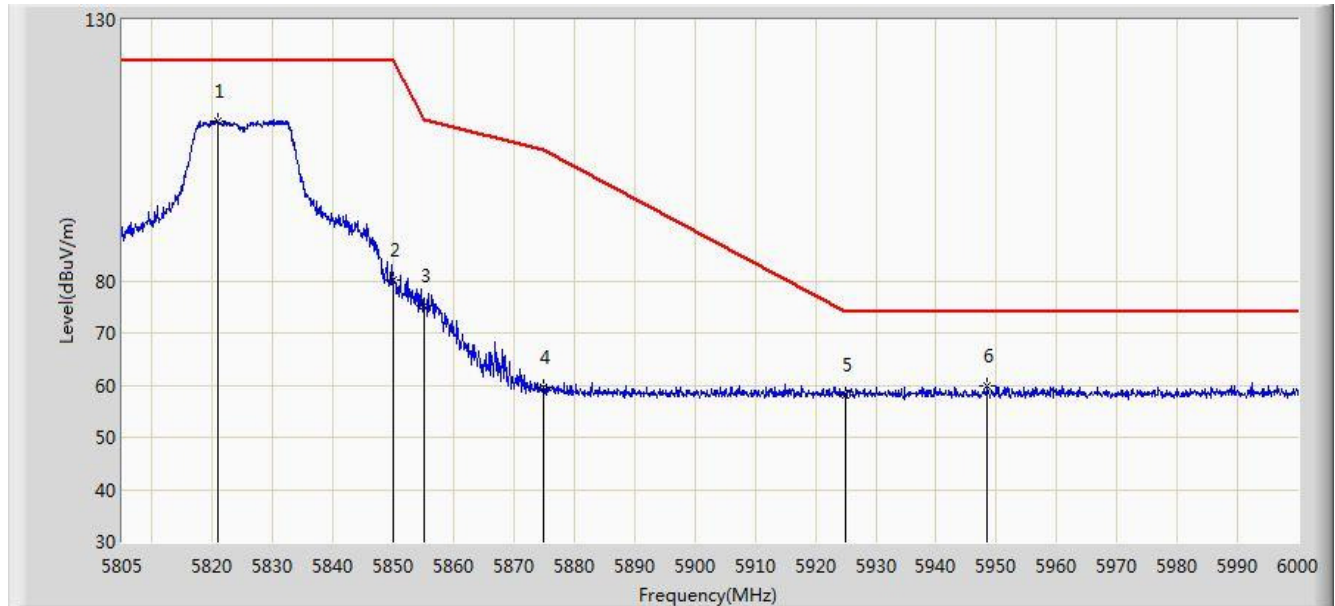

| No | Flag | Mark | Frequency (MHz) | Measure Level (dBuV/m) | Reading Level (dBuV) | Over Limit (dB) | Limit (dBuV/m) | Factor | Type |
|----|------|------|-----------------|------------------------|----------------------|-----------------|----------------|--------|------|
| 1  |      | *    | 5820.893        | 110.608                | 105.932              | N/A             | N/A            | 4.676  | PK   |
| 2  |      |      | 5850.000        | 80.214                 | 75.219               | -41.986         | 122.200        | 4.995  | PK   |
| 3  |      |      | 5855.000        | 75.239                 | 70.251               | -35.561         | 110.800        | 4.987  | PK   |
| 4  |      |      | 5875.000        | 59.480                 | 54.473               | -45.720         | 105.200        | 5.008  | PK   |
| 5  |      |      | 5925.000        | 58.225                 | 53.073               | -15.775         | 74.000         | 5.152  | PK   |
| 6  |      |      | 5948.422        | 59.983                 | 54.789               | -14.017         | 74.000         | 5.194  | PK   |

Note: Measure Level (dBuV/m) = Reading Level (dBuV) + Factor (dB)

Factor (dB) = Cable Loss (dB) + Antenna Factor (dB/m) - Pre\_Amplifier Gain (dB)

|   |                          |
|---|--------------------------|
| Site: AC2   | Time: 2016/08/27 - 16:44 |
| Limit: FCC_Part15.407_RE(3m)                            | Engineer: Bruce Wang     |
| Probe: BBHA9120D_1-18GHz                                | Polarity: Horizontal     |
| EUT: WIRELESS-ABGN 2X2 NETWORK MINIPCIE ADAPTER         | Power: AC 120V/60Hz      |
| Test Mode: Transmit by 802.11a at Channel 5825MHz Ant 0 |                          |

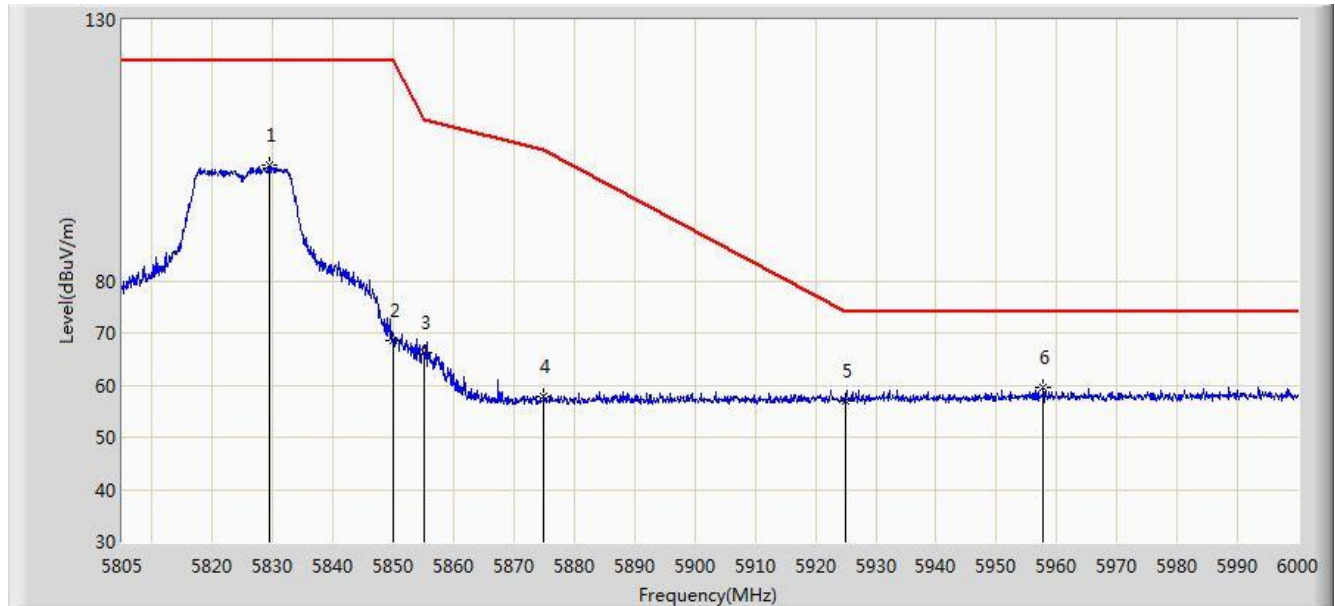

| No | Flag | Mark | Frequency (MHz) | Measure Level (dBuV/m) | Reading Level (dBuV) | Over Limit (dB) | Limit (dBuV/m) | Factor | Type |
|----|------|------|-----------------|------------------------|----------------------|-----------------|----------------|--------|------|
| 1  |      |      | 5829.375        | 102.186                | 97.378               | N/A             | N/A            | 4.808  | PK   |
| 2  |      |      | 5850.000        | 68.564                 | 63.569               | -53.636         | 122.200        | 4.995  | PK   |
| 3  |      |      | 5855.000        | 66.291                 | 61.303               | -44.509         | 110.800        | 4.987  | PK   |
| 4  |      |      | 5875.000        | 57.962                 | 52.955               | -47.238         | 105.200        | 5.008  | PK   |
| 5  |      |      | 5925.000        | 56.818                 | 51.666               | -17.182         | 74.000         | 5.152  | PK   |
| 6  |      | *    | 5957.783        | 59.446                 | 54.107               | -14.554         | 74.000         | 5.340  | PK   |

Note: Measure Level (dBuV/m) = Reading Level (dBuV) + Factor (dB)

Factor (dB) = Cable Loss (dB) + Antenna Factor (dB/m) - Pre\_Amplifier Gain (dB)

|   |                          |
|---|--------------------------|
| Site: AC2   | Time: 2016/08/27 - 17:01 |
| Limit: FCC_Part15.209_RE(3m)                            | Engineer: Bruce Wang     |
| Probe: BBHA9120D_1-18GHz                                | Polarity: Vertical       |
| EUT: WIRELESS-ABGN 2X2 NETWORK MINIPCIE ADAPTER         | Power: AC 120V/60Hz      |
| Test Mode: Transmit by 802.11a at Channel 5180MHz Ant 1 |                          |

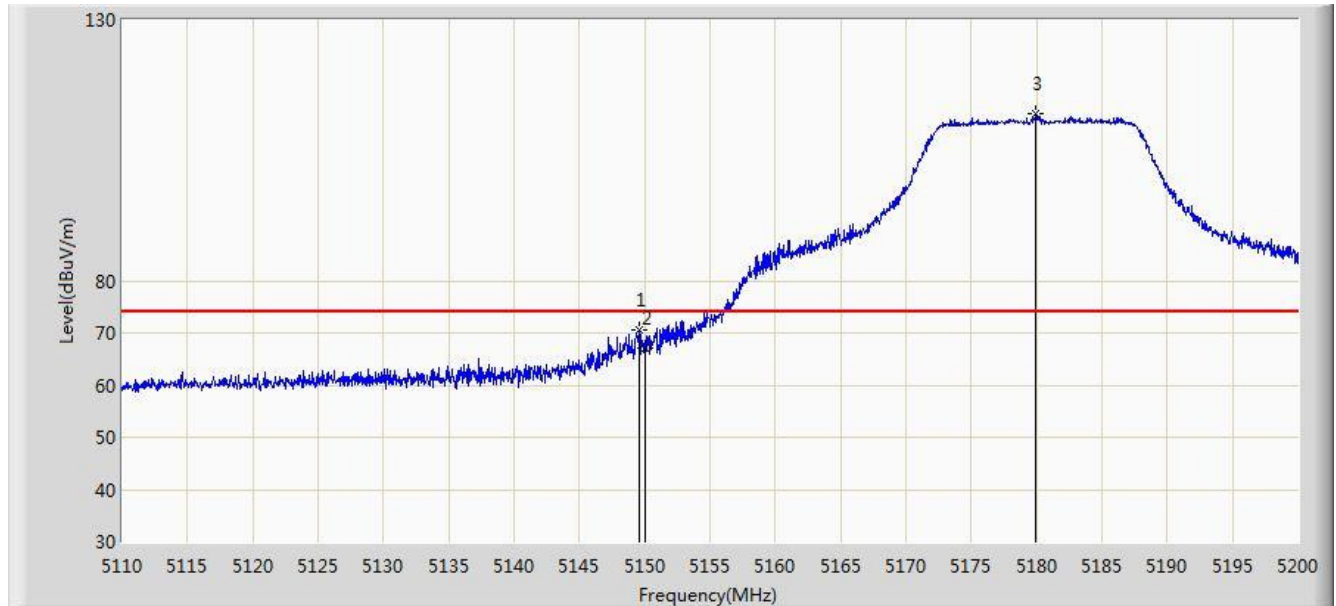

| No | Flag | Mark | Frequency (MHz) | Measure Level (dBuV/m) | Reading Level (dBuV) | Over Limit (dB) | Limit (dBuV/m) | Factor | Type |
|----|------|------|-----------------|------------------------|----------------------|-----------------|----------------|--------|------|
| 1  |      |      | 5149.600        | 70.645                 | 67.575               | -3.355          | 74.000         | 3.070  | PK   |
| 2  |      |      | 5150.000        | 67.049                 | 63.979               | -6.951          | 74.000         | 3.069  | PK   |
| 3  |      | *    | 5179.975        | 111.918                | 108.875              | N/A             | N/A            | 3.043  | PK   |

Note: Measure Level (dBuV/m) = Reading Level (dBuV) + Factor (dB)

Factor (dB) = Cable Loss (dB) + Antenna Factor (dB/m) - Pre\_Amplifier Gain (dB)



|   |                          |
|---|--------------------------|
| Site: AC2   | Time: 2016/08/27 - 17:03 |
| Limit: FCC_Part15.209_RE(3m)                            | Engineer: Bruce Wang     |
| Probe: BBHA9120D_1-18GHz                                | Polarity: Vertical       |
| EUT: WIRELESS-ABGN 2X2 NETWORK MINIPCIE ADAPTER         | Power: AC 120V/60Hz      |
| Test Mode: Transmit by 802.11a at Channel 5180MHz Ant 1 |                          |

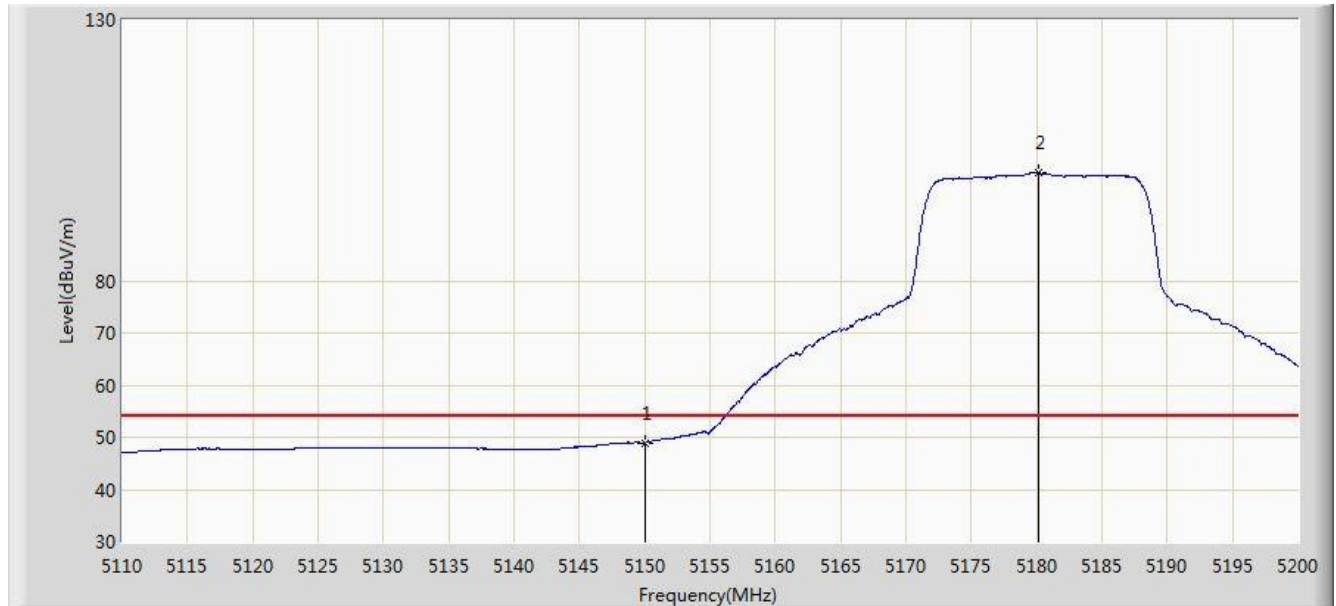

| No | Flag | Mark | Frequency (MHz) | Measure Level (dBuV/m) | Reading Level (dBuV) | Over Limit (dB) | Limit (dBuV/m) | Factor | Type |
|----|------|------|-----------------|------------------------|----------------------|-----------------|----------------|--------|------|
| 1  |      |      | 5150.000        | 48.880                 | 45.810               | -5.120          | 54.000         | 3.069  | AV   |
| 2  |      | *    | 5180.200        | 100.670                | 97.626               | N/A             | N/A            | 3.043  | AV   |

Note: Measure Level (dBμV/m) = Reading Level (dBμV) + Factor (dB)

Factor (dB) = Cable Loss (dB) + Antenna Factor (dB/m) - Pre\_Amplifier Gain (dB)

|   |                          |
|---|--------------------------|
| Site: AC2   | Time: 2016/08/27 - 17:04 |
| Limit: FCC_Part15.209_RE(3m)                            | Engineer: Bruce Wang     |
| Probe: BBHA9120D_1-18GHz                                | Polarity: Horizontal     |
| EUT: WIRELESS-ABGN 2X2 NETWORK MINIPCIE ADAPTER         | Power: AC 120V/60Hz      |
| Test Mode: Transmit by 802.11a at Channel 5180MHz Ant 1 |                          |

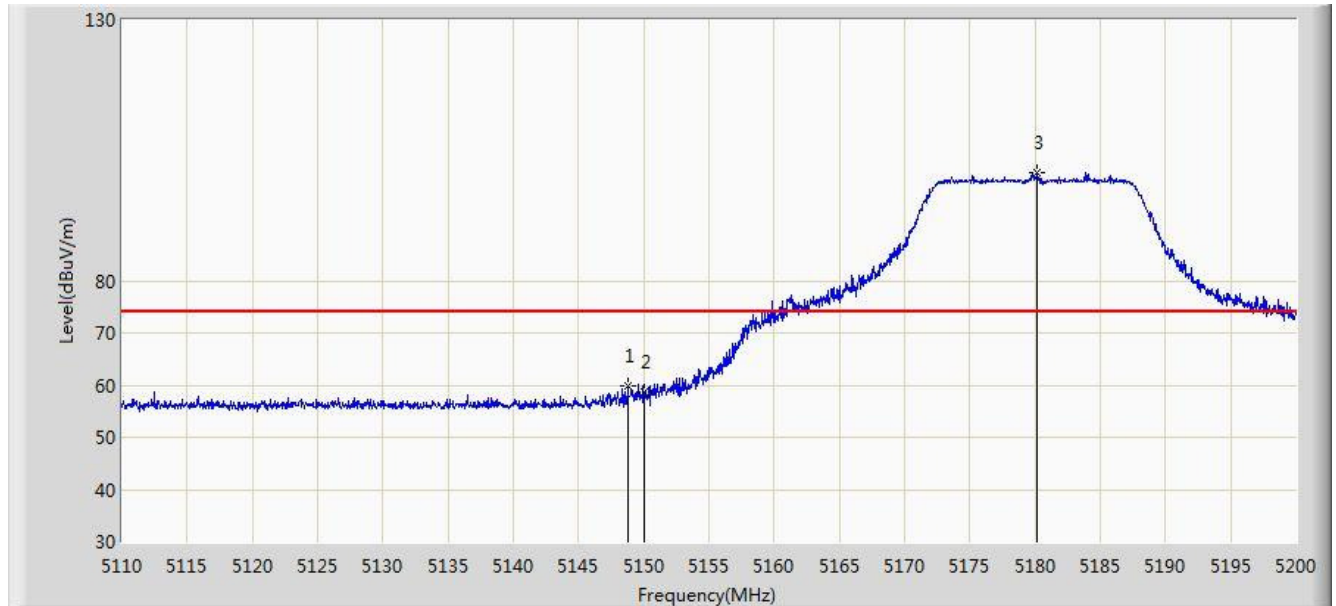

| No | Flag | Mark | Frequency (MHz) | Measure Level (dBuV/m) | Reading Level (dBuV) | Over Limit (dB) | Limit (dBuV/m) | Factor | Type |
|----|------|------|-----------------|------------------------|----------------------|-----------------|----------------|--------|------|
| 1  |      |      | 5148.790        | 59.818                 | 56.746               | -14.182         | 74.000         | 3.072  | PK   |
| 2  |      |      | 5150.000        | 58.734                 | 55.664               | -15.266         | 74.000         | 3.069  | PK   |
| 3  |      | *    | 5180.200        | 100.672                | 97.628               | N/A             | N/A            | 3.043  | PK   |

Note: Measure Level (dBuV/m) = Reading Level (dBuV) + Factor (dB)

Factor (dB) = Cable Loss (dB) + Antenna Factor (dB/m) - Pre\_Amplifier Gain (dB)

|   |                          |
|---|--------------------------|
| Site: AC2   | Time: 2016/08/27 - 17:06 |
| Limit: FCC_Part15.209_RE(3m)                            | Engineer: Bruce Wang     |
| Probe: BBHA9120D_1-18GHz                                | Polarity: Horizontal     |
| EUT: WIRELESS-ABGN 2X2 NETWORK MINIPCIE ADAPTER         | Power: AC 120V/60Hz      |
| Test Mode: Transmit by 802.11a at Channel 5180MHz Ant 1 |                          |

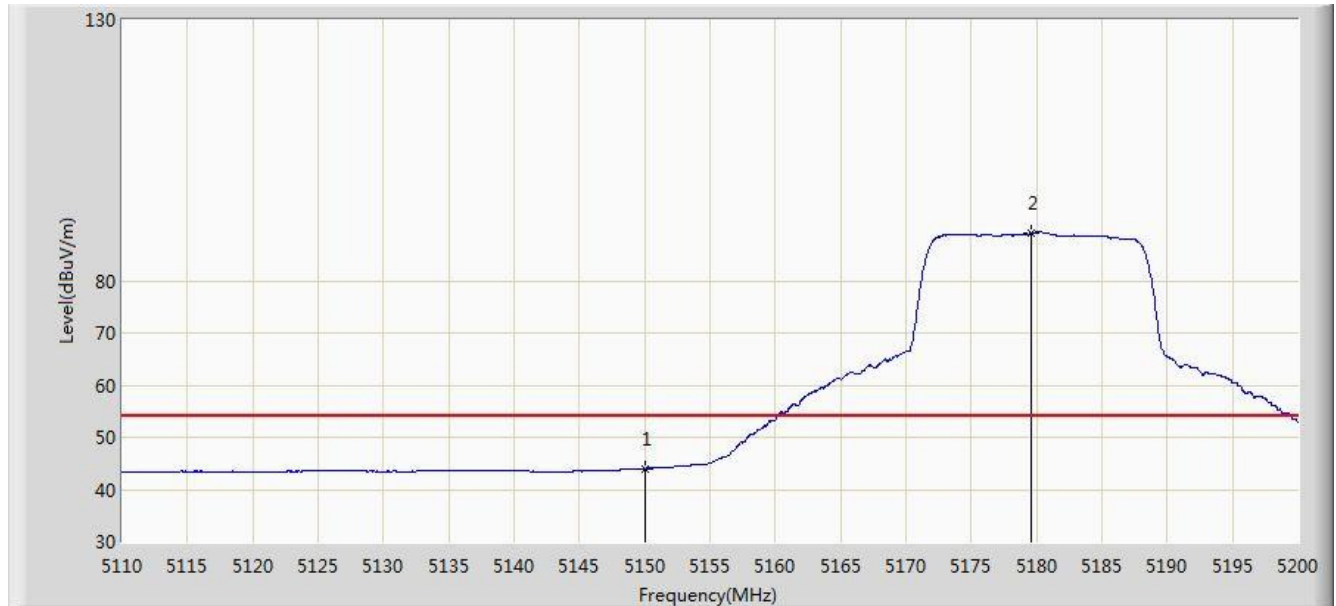

| No | Flag | Mark | Frequency (MHz) | Measure Level (dBuV/m) | Reading Level (dBuV) | Over Limit (dB) | Limit (dBuV/m) | Factor | Type |
|----|------|------|-----------------|------------------------|----------------------|-----------------|----------------|--------|------|
| 1  |      |      | 5150.000        | 44.019                 | 40.949               | -9.981          | 54.000         | 3.069  | AV   |
| 2  |      | *    | 5179.615        | 89.163                 | 86.122               | N/A             | N/A            | 3.041  | AV   |

Note: Measure Level (dBμV/m) = Reading Level (dBμV) + Factor (dB)

Factor (dB) = Cable Loss (dB) + Antenna Factor (dB/m) - Pre\_Amplifier Gain (dB)

|   |                          |
|---|--------------------------|
| Site: AC2   | Time: 2016/08/27 - 17:17 |
| Limit: FCC_Part15.209_RE(3m)                            | Engineer: Bruce Wang     |
| Probe: BBHA9120D_1-18GHz                                | Polarity: Vertical       |
| EUT: WIRELESS-ABGN 2X2 NETWORK MINIPCIE ADAPTER         | Power: AC 120V/60Hz      |
| Test Mode: Transmit by 802.11a at Channel 5320MHz Ant 1 |                          |

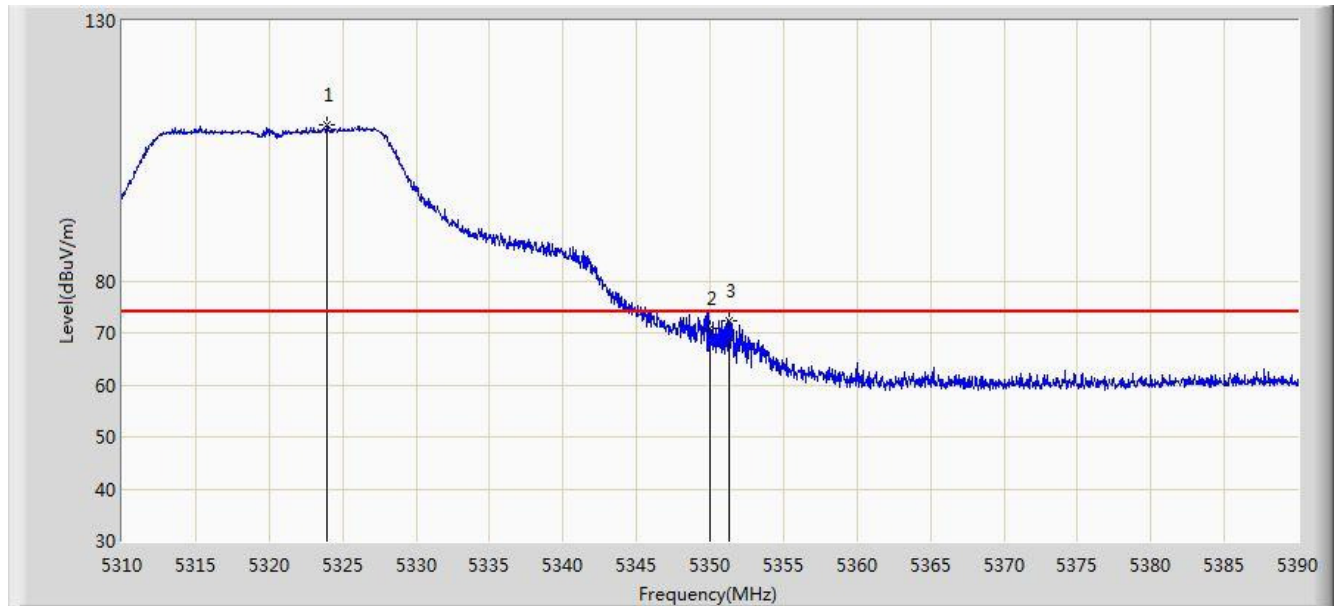

| No | Flag | Mark | Frequency (MHz) | Measure Level (dBuV/m) | Reading Level (dBuV) | Over Limit (dB) | Limit (dBuV/m) | Factor | Type |
|----|------|------|-----------------|------------------------|----------------------|-----------------|----------------|--------|------|
| 1  |      | *    | 5323.960        | 109.957                | 107.278              | N/A             | N/A            | 2.680  | PK   |
| 2  |      |      | 5350.000        | 70.859                 | 68.162               | -3.141          | 74.000         | 2.697  | PK   |
| 3  |      |      | 5351.320        | 72.404                 | 69.702               | -1.596          | 74.000         | 2.702  | PK   |

Note: Measure Level (dBuV/m) = Reading Level (dBuV) + Factor (dB)

Factor (dB) = Cable Loss (dB) + Antenna Factor (dB/m) - Pre\_Amplifier Gain (dB)

|   |                          |
|---|--------------------------|
| Site: AC2   | Time: 2016/08/27 - 17:20 |
| Limit: FCC_Part15.209_RE(3m)                            | Engineer: Bruce Wang     |
| Probe: BBHA9120D_1-18GHz                                | Polarity: Vertical       |
| EUT: WIRELESS-ABGN 2X2 NETWORK MINIPCIE ADAPTER         | Power: AC 120V/60Hz      |
| Test Mode: Transmit by 802.11a at Channel 5320MHz Ant 1 |                          |

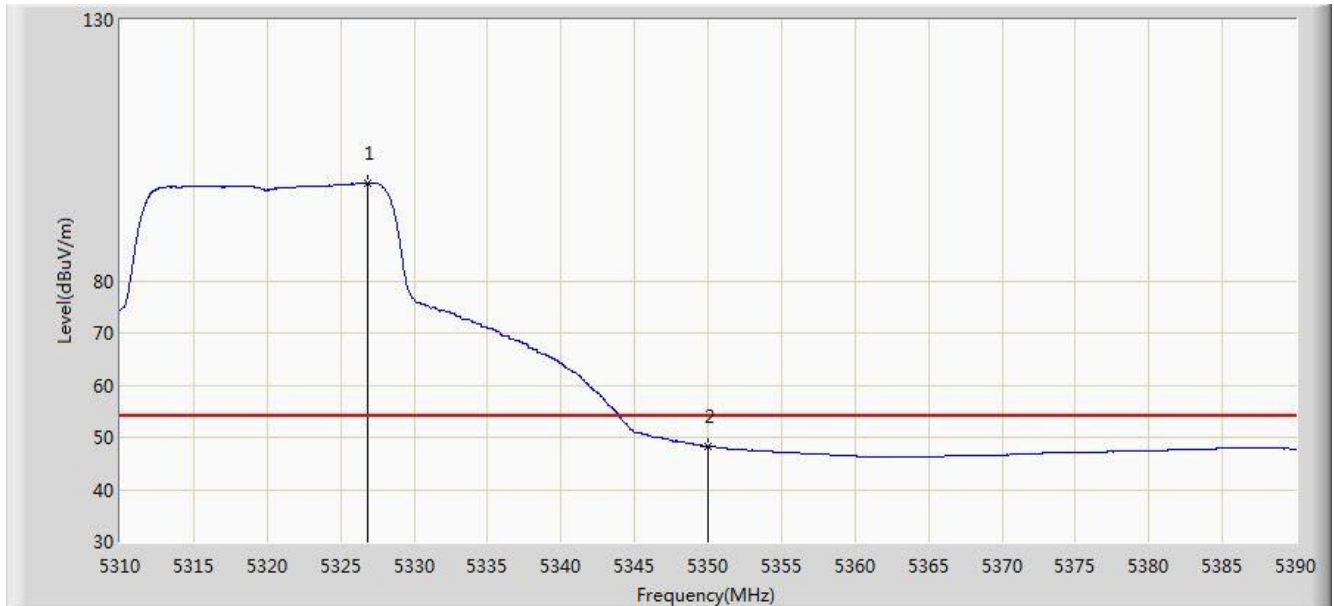

| No | Flag | Mark | Frequency (MHz) | Measure Level (dBuV/m) | Reading Level (dBuV) | Over Limit (dB) | Limit (dBuV/m) | Factor | Type |
|----|------|------|-----------------|------------------------|----------------------|-----------------|----------------|--------|------|
| 1  |      | *    | 5326.880        | 98.656                 | 95.963               | N/A             | N/A            | 2.692  | AV   |
| 2  |      |      | 5350.000        | 48.212                 | 45.515               | -5.788          | 54.000         | 2.697  | AV   |

Note: Measure Level (dBμV/m) = Reading Level (dBμV) + Factor (dB)

Factor (dB) = Cable Loss (dB) + Antenna Factor (dB/m) - Pre\_Amplifier Gain (dB)

|   |                          |
|---|--------------------------|
| Site: AC2   | Time: 2016/08/27 - 17:22 |
| Limit: FCC_Part15.209_RE(3m)                            | Engineer: Bruce Wang     |
| Probe: BBHA9120D_1-18GHz                                | Polarity: Horizontal     |
| EUT: WIRELESS-ABGN 2X2 NETWORK MINIPCIE ADAPTER         | Power: AC 120V/60Hz      |
| Test Mode: Transmit by 802.11a at Channel 5320MHz Ant 1 |                          |

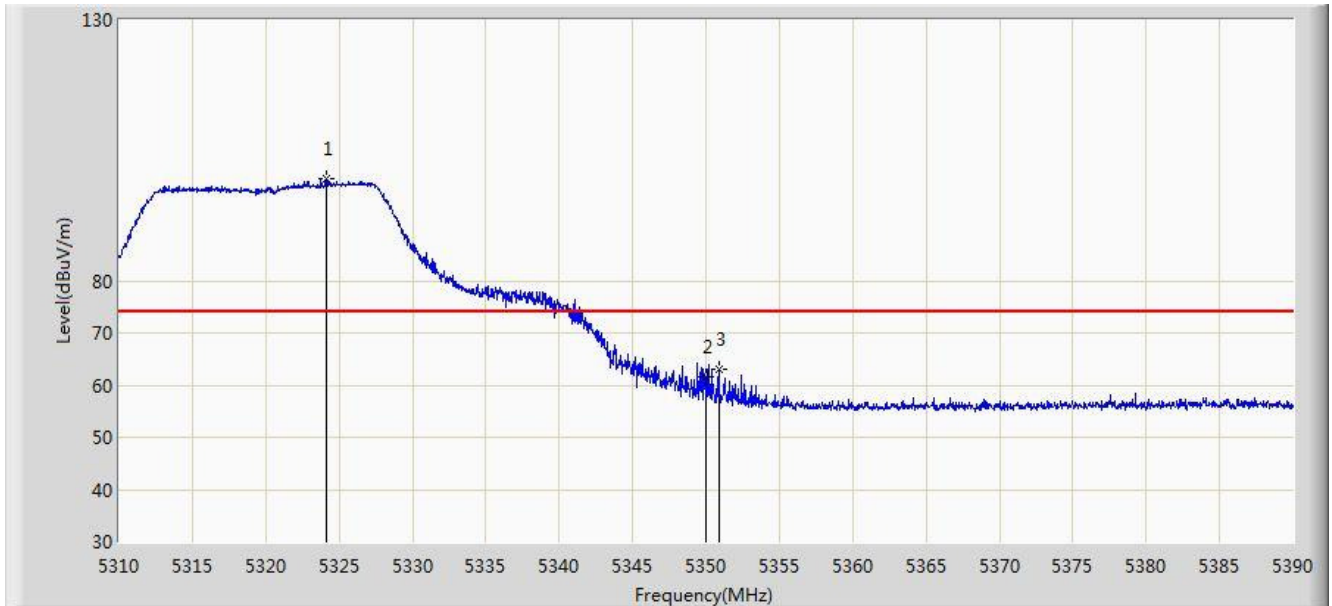

| No | Flag | Mark | Frequency (MHz) | Measure Level (dBuV/m) | Reading Level (dBuV) | Over Limit (dB) | Limit (dBuV/m) | Factor | Type |
|----|------|------|-----------------|------------------------|----------------------|-----------------|----------------|--------|------|
| 1  |      | *    | 5324.120        | 99.703                 | 97.023               | N/A             | N/A            | 2.680  | PK   |
| 2  |      |      | 5350.000        | 61.644                 | 58.947               | -12.356         | 74.000         | 2.697  | PK   |
| 3  |      |      | 5350.880        | 63.079                 | 60.378               | -10.921         | 74.000         | 2.701  | PK   |

Note: Measure Level (dBuV/m) = Reading Level (dBuV) + Factor (dB)

Factor (dB) = Cable Loss (dB) + Antenna Factor (dB/m) - Pre\_Amplifier Gain (dB)

|   |                          |
|---|--------------------------|
| Site: AC2   | Time: 2016/08/27 - 17:24 |
| Limit: FCC_Part15.209_RE(3m)                            | Engineer: Bruce Wang     |
| Probe: BBHA9120D_1-18GHz                                | Polarity: Horizontal     |
| EUT: WIRELESS-ABGN 2X2 NETWORK MINIPCIE ADAPTER         | Power: AC 120V/60Hz      |
| Test Mode: Transmit by 802.11a at Channel 5320MHz Ant 1 |                          |

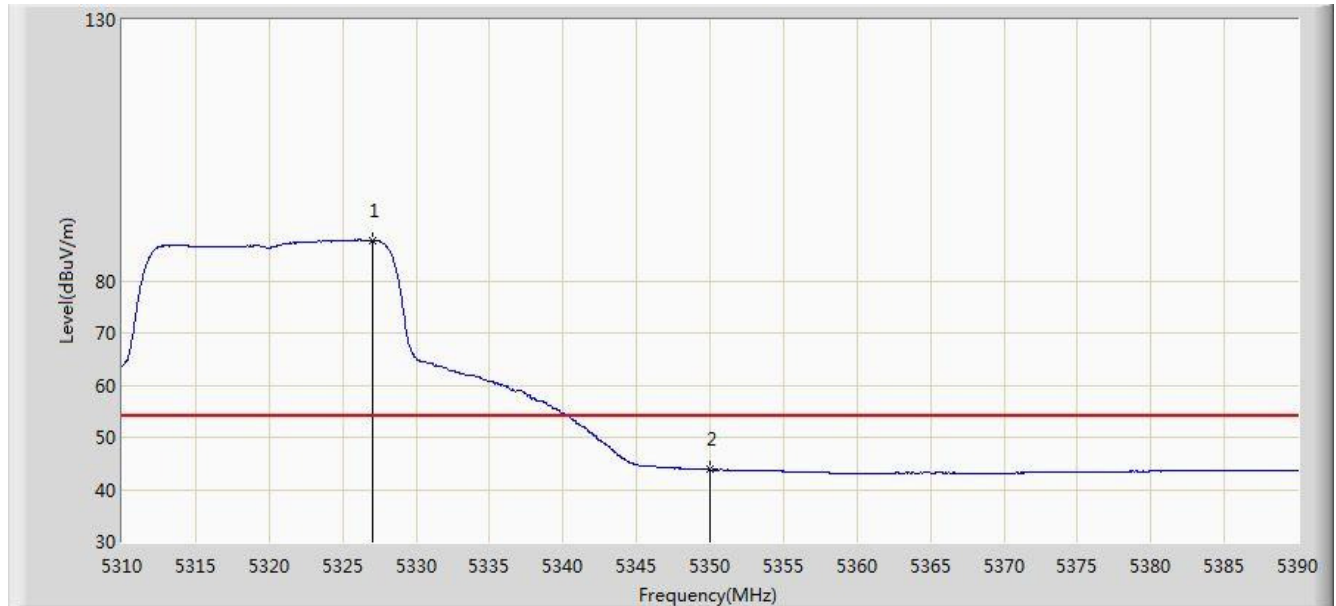

| No | Flag | Mark | Frequency (MHz) | Measure Level (dBuV/m) | Reading Level (dBuV) | Over Limit (dB) | Limit (dBuV/m) | Factor | Type |
|----|------|------|-----------------|------------------------|----------------------|-----------------|----------------|--------|------|
| 1  |      | *    | 5327.000        | 87.666                 | 84.973               | N/A             | N/A            | 2.693  | AV   |
| 2  |      |      | 5350.000        | 43.793                 | 41.096               | -10.207         | 54.000         | 2.697  | AV   |

Note: Measure Level (dBμV/m) = Reading Level (dBμV) + Factor (dB)

Factor (dB) = Cable Loss (dB) + Antenna Factor (dB/m) - Pre\_Amplifier Gain (dB)

|   |                          |
|---|--------------------------|
| Site: AC2   | Time: 2016/08/27 - 17:30 |
| Limit: FCC_Part15.209_RE(3m)                            | Engineer: Bruce Wang     |
| Probe: BBHA9120D_1-18GHz                                | Polarity: Vertical       |
| EUT: WIRELESS-ABGN 2X2 NETWORK MINIPCIE ADAPTER         | Power: AC 120V/60Hz      |
| Test Mode: Transmit by 802.11a at Channel 5500MHz Ant 1 |                          |

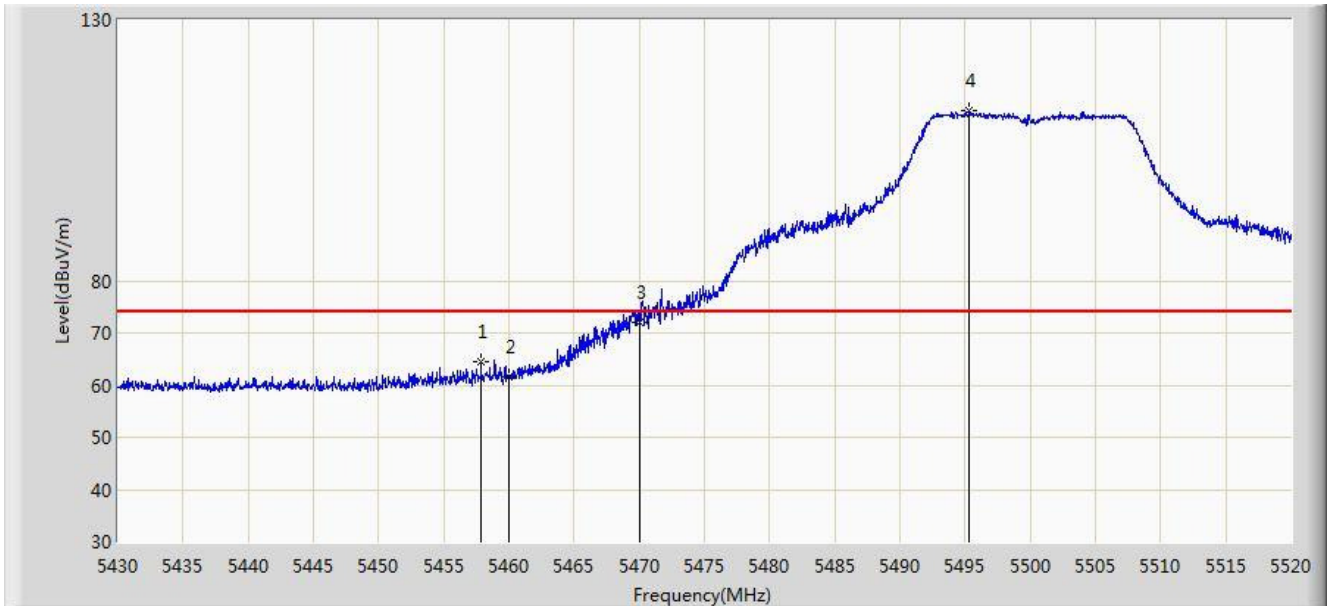

| No | Flag | Mark | Frequency (MHz) | Measure Level (dBuV/m) | Reading Level (dBuV) | Over Limit (dB) | Limit (dBuV/m) | Factor | Type |
|----|------|------|-----------------|------------------------|----------------------|-----------------|----------------|--------|------|
| 1  |      |      | 5457.855        | 64.427                 | 61.306               | -9.573          | 74.000         | 3.122  | PK   |
| 2  |      |      | 5460.000        | 61.725                 | 58.532               | -12.275         | 74.000         | 3.194  | PK   |
| 3  |      |      | 5470.000        | 72.158                 | 68.629               | -1.842          | 74.000         | 3.529  | PK   |
| 4  |      | *    | 5495.340        | 112.468                | 109.310              | N/A             | N/A            | 3.158  | PK   |

Note: Measure Level (dB $\mu$ V/m) = Reading Level (dB $\mu$ V) + Factor (dB)

Factor (dB) = Cable Loss (dB) + Antenna Factor (dB/m) - Pre\_Amplifier Gain (dB)



|   |                          |
|---|--------------------------|
| Site: AC2   | Time: 2016/08/27 - 17:33 |
| Limit: FCC_Part15.209_RE(3m)                            | Engineer: Bruce Wang     |
| Probe: BBHA9120D_1-18GHz                                | Polarity: Vertical       |
| EUT: WIRELESS-ABGN 2X2 NETWORK MINIPCIE ADAPTER         | Power: AC 120V/60Hz      |
| Test Mode: Transmit by 802.11a at Channel 5500MHz Ant 1 |                          |

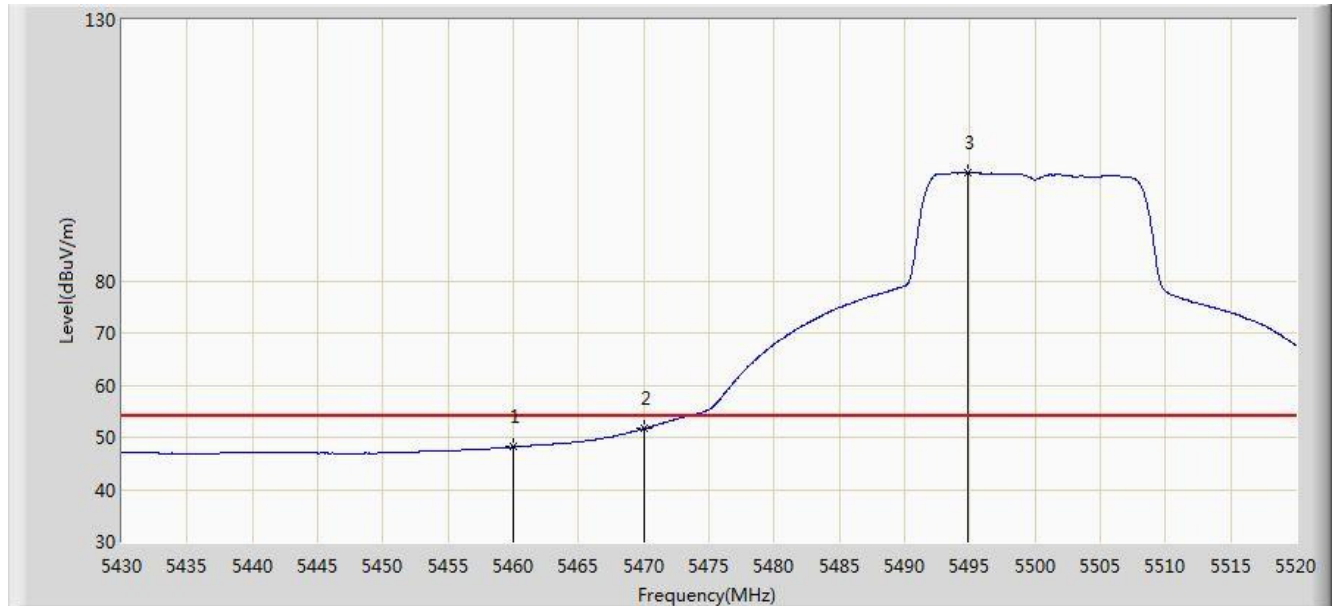

| No | Flag | Mark | Frequency (MHz) | Measure Level (dBuV/m) | Reading Level (dBuV) | Over Limit (dB) | Limit (dBuV/m) | Factor | Type |
|----|------|------|-----------------|------------------------|----------------------|-----------------|----------------|--------|------|
| 1  |      |      | 5460.000        | 48.168                 | 44.975               | -5.832          | 54.000         | 3.194  | AV   |
| 2  |      |      | 5470.000        | 51.679                 | 48.150               | -2.321          | 54.000         | 3.529  | AV   |
| 3  |      | *    | 5494.800        | 100.654                | 97.491               | N/A             | N/A            | 3.163  | AV   |

Note: Measure Level (dBuV/m) = Reading Level (dBuV) + Factor (dB)

Factor (dB) = Cable Loss (dB) + Antenna Factor (dB/m) - Pre\_Amplifier Gain (dB)

|   |                          |
|---|--------------------------|
| Site: AC2   | Time: 2016/08/27 - 17:34 |
| Limit: FCC_Part15.209_RE(3m)                            | Engineer: Bruce Wang     |
| Probe: BBHA9120D_1-18GHz                                | Polarity: Horizontal     |
| EUT: WIRELESS-ABGN 2X2 NETWORK MINIPCIE ADAPTER         | Power: AC 120V/60Hz      |
| Test Mode: Transmit by 802.11a at Channel 5500MHz Ant 1 |                          |

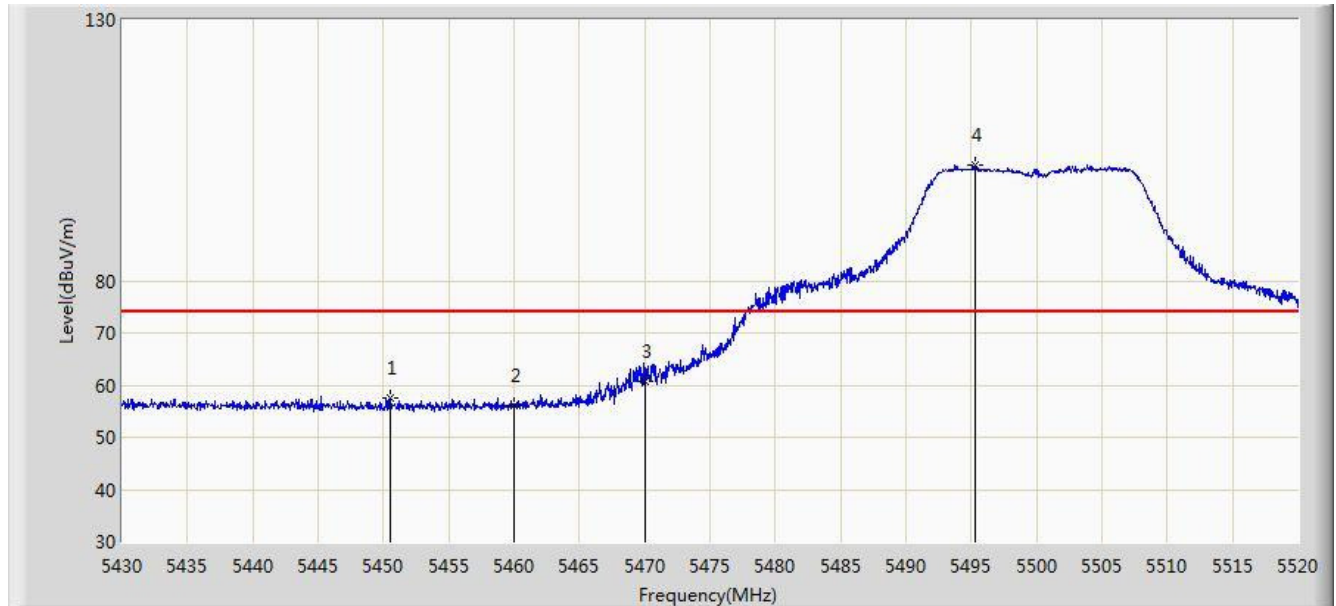

| No | Flag | Mark | Frequency (MHz) | Measure Level (dBuV/m) | Reading Level (dBuV) | Over Limit (dB) | Limit (dBuV/m) | Factor | Type |
|----|------|------|-----------------|------------------------|----------------------|-----------------|----------------|--------|------|
| 1  |      |      | 5450.520        | 57.528                 | 54.531               | -16.472         | 74.000         | 2.997  | PK   |
| 2  |      |      | 5460.000        | 56.100                 | 52.907               | -17.900         | 74.000         | 3.194  | PK   |
| 3  |      |      | 5470.000        | 60.700                 | 57.171               | -13.300         | 74.000         | 3.529  | PK   |
| 4  |      | *    | 5495.340        | 102.228                | 99.070               | N/A             | N/A            | 3.158  | PK   |

Note: Measure Level (dBμV/m) = Reading Level (dBμV) + Factor (dB)

Factor (dB) = Cable Loss (dB) + Antenna Factor (dB/m) - Pre\_Amplifier Gain (dB)

|   |                          |
|---|--------------------------|
| Site: AC2   | Time: 2016/08/27 - 17:36 |
| Limit: FCC_Part15.209_RE(3m)                            | Engineer: Bruce Wang     |
| Probe: BBHA9120D_1-18GHz                                | Polarity: Horizontal     |
| EUT: WIRELESS-ABGN 2X2 NETWORK MINIPCIE ADAPTER         | Power: AC 120V/60Hz      |
| Test Mode: Transmit by 802.11a at Channel 5500MHz Ant 1 |                          |

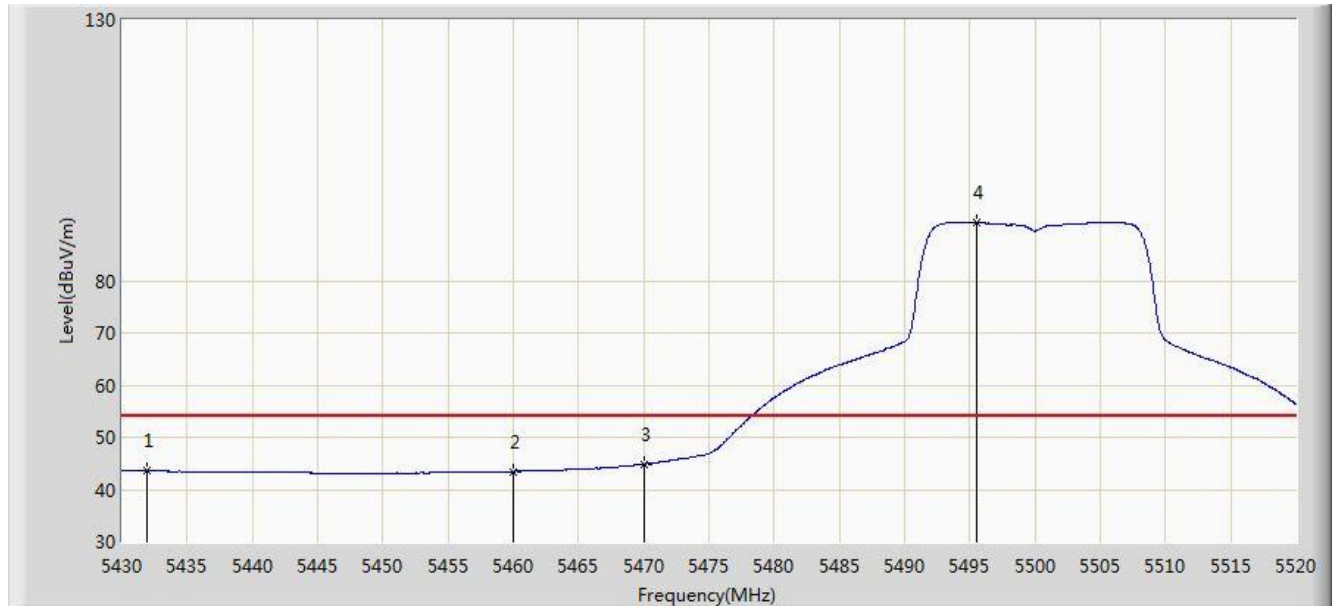

| No | Flag | Mark | Frequency (MHz) | Measure Level (dBuV/m) | Reading Level (dBuV) | Over Limit (dB) | Limit (dBuV/m) | Factor | Type |
|----|------|------|-----------------|------------------------|----------------------|-----------------|----------------|--------|------|
| 1  |      |      | 5431.890        | 43.566                 | 40.235               | -10.434         | 54.000         | 3.331  | AV   |
| 2  |      |      | 5460.000        | 43.453                 | 40.260               | -10.547         | 54.000         | 3.194  | AV   |
| 3  |      |      | 5470.000        | 44.813                 | 41.284               | -9.187          | 54.000         | 3.529  | AV   |
| 4  |      | *    | 5495.475        | 91.145                 | 87.988               | N/A             | N/A            | 3.156  | AV   |

Note: Measure Level (dB $\mu$ V/m) = Reading Level (dB $\mu$ V) + Factor (dB)

Factor (dB) = Cable Loss (dB) + Antenna Factor (dB/m) - Pre\_Amplifier Gain (dB)

|   |                          |
|---|--------------------------|
| Site: AC2   | Time: 2016/08/27 - 17:49 |
| Limit: FCC_Part15.209_RE(3m)                            | Engineer: Bruce Wang     |
| Probe: BBHA9120D_1-18GHz                                | Polarity: Vertical       |
| EUT: WIRELESS-ABGN 2X2 NETWORK MINIPCIE ADAPTER         | Power: AC 120V/60Hz      |
| Test Mode: Transmit by 802.11a at Channel 5700MHz Ant 1 |                          |

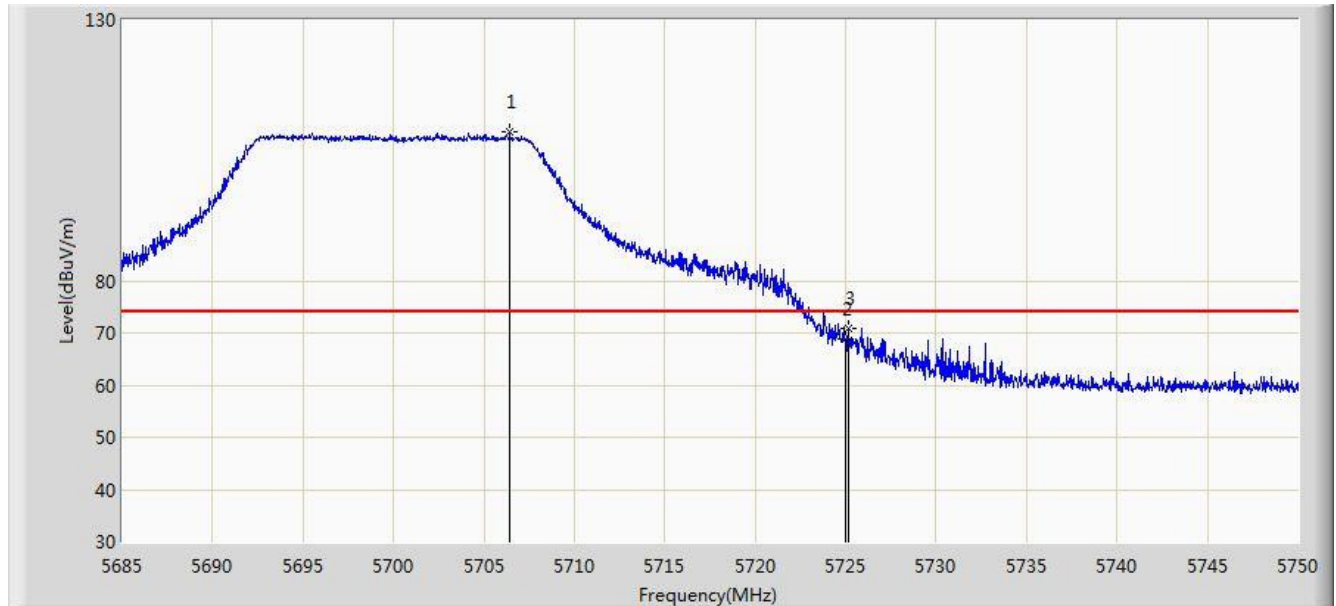

| No | Flag | Mark | Frequency (MHz) | Measure Level (dBuV/m) | Reading Level (dBuV) | Over Limit (dB) | Limit (dBuV/m) | Factor | Type |
|----|------|------|-----------------|------------------------|----------------------|-----------------|----------------|--------|------|
| 1  |      | *    | 5706.417        | 108.468                | 104.591              | N/A             | N/A            | 3.876  | PK   |
| 2  |      |      | 5725.000        | 68.755                 | 64.649               | -5.245          | 74.000         | 4.105  | PK   |
| 3  |      |      | 5725.138        | 70.998                 | 66.889               | -3.002          | 74.000         | 4.109  | PK   |

Note: Measure Level (dBuV/m) = Reading Level (dBuV) + Factor (dB)

Factor (dB) = Cable Loss (dB) + Antenna Factor (dB/m) - Pre\_Amplifier Gain (dB)

|   |                          |
|---|--------------------------|
| Site: AC2   | Time: 2016/08/27 - 17:52 |
| Limit: FCC_Part15.209_RE(3m)                            | Engineer: Bruce Wang     |
| Probe: BBHA9120D_1-18GHz                                | Polarity: Vertical       |
| EUT: WIRELESS-ABGN 2X2 NETWORK MINIPCIE ADAPTER         | Power: AC 120V/60Hz      |
| Test Mode: Transmit by 802.11a at Channel 5700MHz Ant 1 |                          |

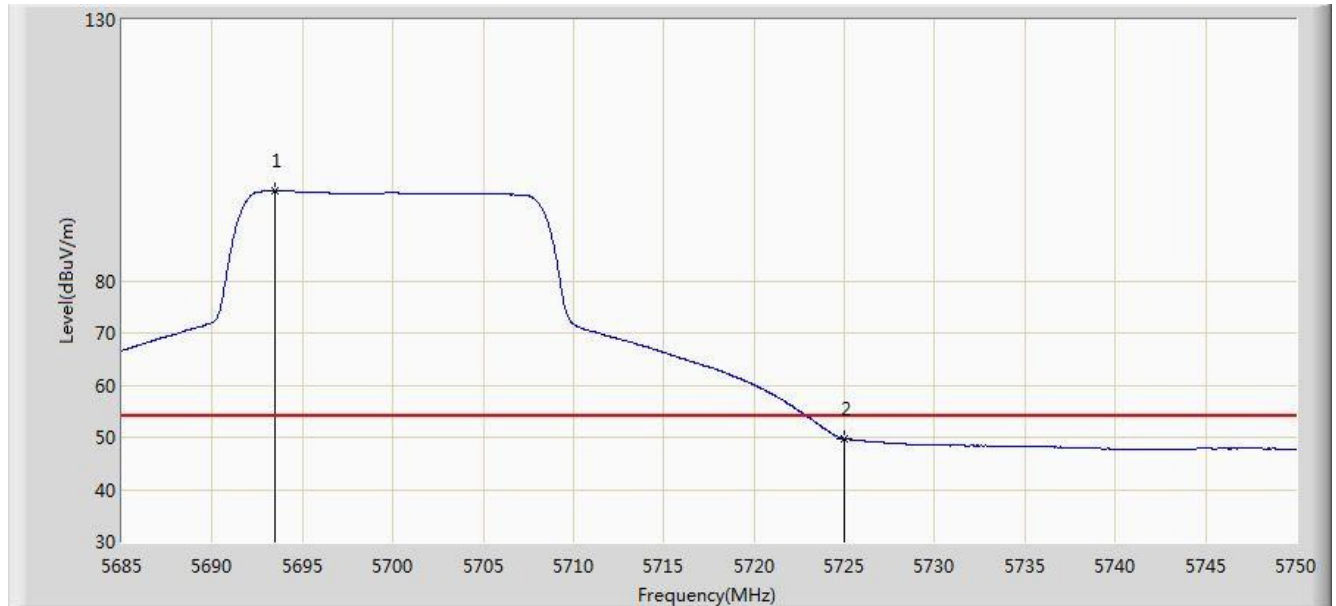

| No | Flag | Mark | Frequency (MHz) | Measure Level (dBuV/m) | Reading Level (dBuV) | Over Limit (dB) | Limit (dBuV/m) | Factor | Type |
|----|------|------|-----------------|------------------------|----------------------|-----------------|----------------|--------|------|
| 1  |      | *    | 5693.450        | 97.290                 | 93.284               | N/A             | N/A            | 4.005  | AV   |
| 2  |      |      | 5725.000        | 49.762                 | 45.656               | -4.238          | 54.000         | 4.105  | AV   |

Note: Measure Level (dBμV/m) = Reading Level (dBμV) + Factor (dB)

Factor (dB) = Cable Loss (dB) + Antenna Factor (dB/m) - Pre\_Amplifier Gain (dB)

|   |                          |
|---|--------------------------|
| Site: AC2   | Time: 2016/08/27 - 17:53 |
| Limit: FCC_Part15.209_RE(3m)                            | Engineer: Bruce Wang     |
| Probe: BBHA9120D_1-18GHz                                | Polarity: Horizontal     |
| EUT: WIRELESS-ABGN 2X2 NETWORK MINIPCIE ADAPTER         | Power: AC 120V/60Hz      |
| Test Mode: Transmit by 802.11a at Channel 5700MHz Ant 1 |                          |

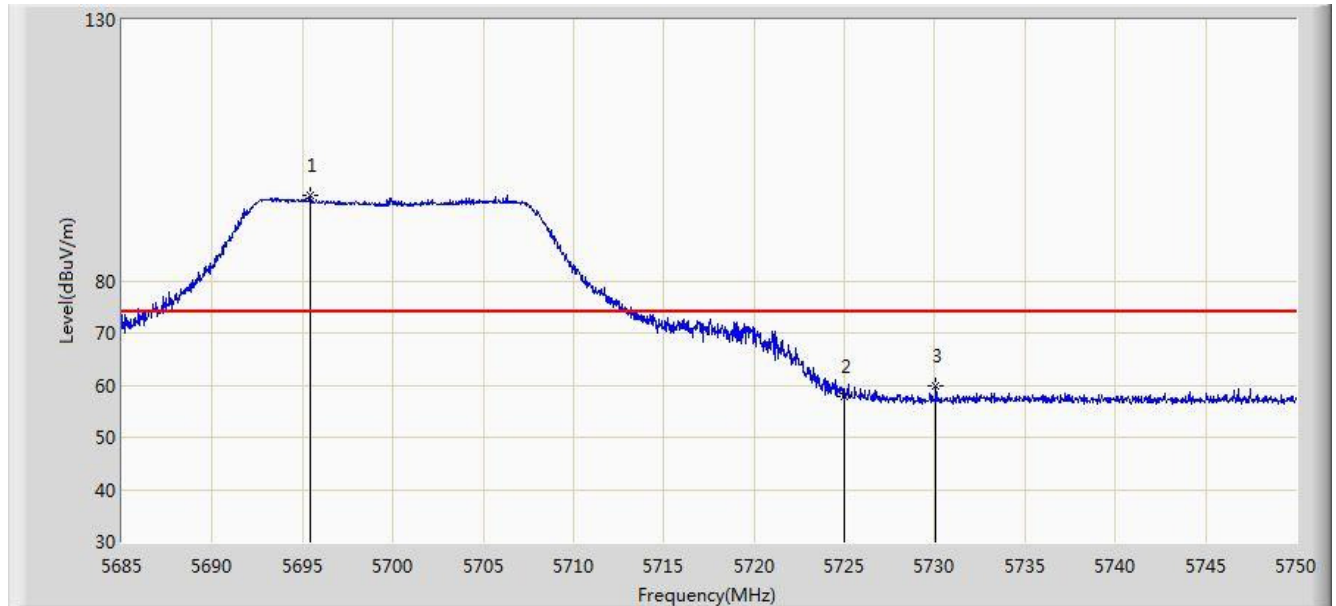

| No | Flag | Mark | Frequency (MHz) | Measure Level (dBuV/m) | Reading Level (dBuV) | Over Limit (dB) | Limit (dBuV/m) | Factor | Type |
|----|------|------|-----------------|------------------------|----------------------|-----------------|----------------|--------|------|
| 1  |      | *    | 5695.465        | 96.362                 | 92.376               | N/A             | N/A            | 3.986  | PK   |
| 2  |      |      | 5725.000        | 57.684                 | 53.578               | -16.316         | 74.000         | 4.105  | PK   |
| 3  |      |      | 5730.078        | 59.751                 | 55.518               | -14.249         | 74.000         | 4.233  | PK   |

Note: Measure Level (dB $\mu$ V/m) = Reading Level (dB $\mu$ V) + Factor (dB)

Factor (dB) = Cable Loss (dB) + Antenna Factor (dB/m) - Pre\_Amplifier Gain (dB)

|   |                          |
|---|--------------------------|
| Site: AC2   | Time: 2016/08/27 - 17:55 |
| Limit: FCC_Part15.209_RE(3m)                            | Engineer: Bruce Wang     |
| Probe: BBHA9120D_1-18GHz                                | Polarity: Horizontal     |
| EUT: WIRELESS-ABGN 2X2 NETWORK MINIPCIE ADAPTER         | Power: AC 120V/60Hz      |
| Test Mode: Transmit by 802.11a at Channel 5700MHz Ant 1 |                          |

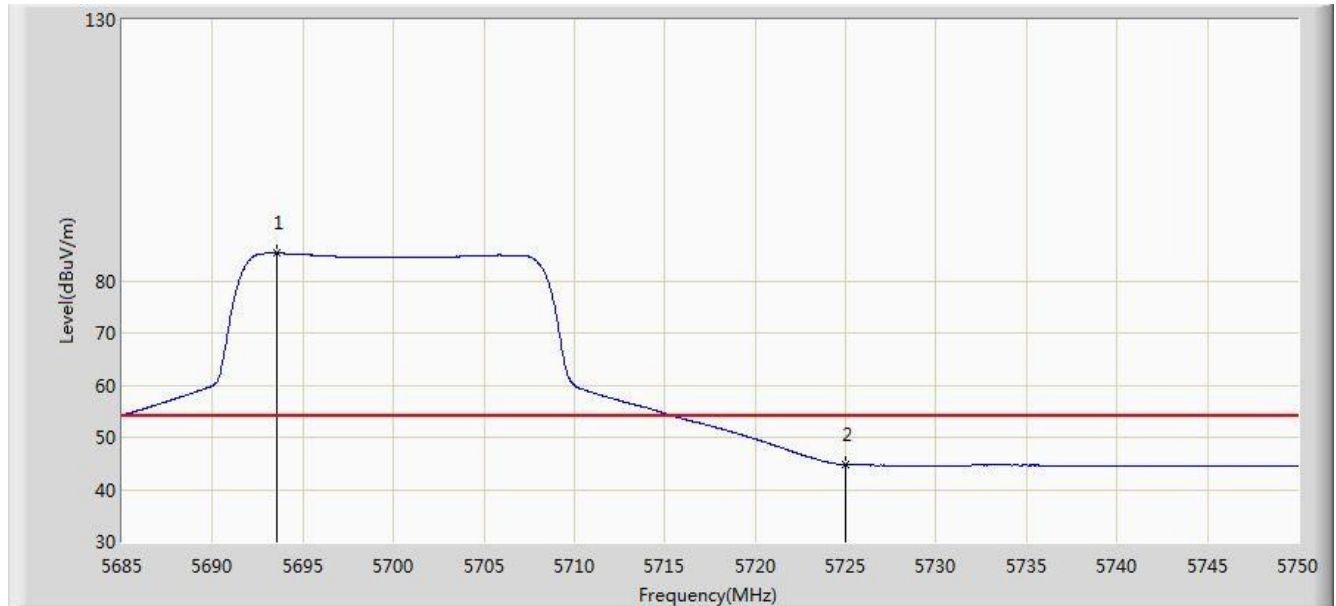

| No | Flag | Mark | Frequency (MHz) | Measure Level (dBuV/m) | Reading Level (dBuV) | Over Limit (dB) | Limit (dBuV/m) | Factor | Type |
|----|------|------|-----------------|------------------------|----------------------|-----------------|----------------|--------|------|
| 1  |      | *    | 5693.547        | 85.335                 | 81.330               | N/A             | N/A            | 4.005  | AV   |
| 2  |      |      | 5725.000        | 44.782                 | 40.676               | -9.218          | 54.000         | 4.105  | AV   |

Note: Measure Level (dBμV/m) = Reading Level (dBμV) + Factor (dB)

Factor (dB) = Cable Loss (dB) + Antenna Factor (dB/m) - Pre\_Amplifier Gain (dB)

|   |                          |
|---|--------------------------|
| Site: AC2   | Time: 2016/08/27 - 17:57 |
| Limit: FCC_Part15.407_RE(3m)                            | Engineer: Bruce Wang     |
| Probe: BBHA9120D_1-18GHz                                | Polarity: Vertical       |
| EUT: WIRELESS-ABGN 2X2 NETWORK MINIPCIE ADAPTER         | Power: AC 120V/60Hz      |
| Test Mode: Transmit by 802.11a at Channel 5745MHz Ant 1 |                          |

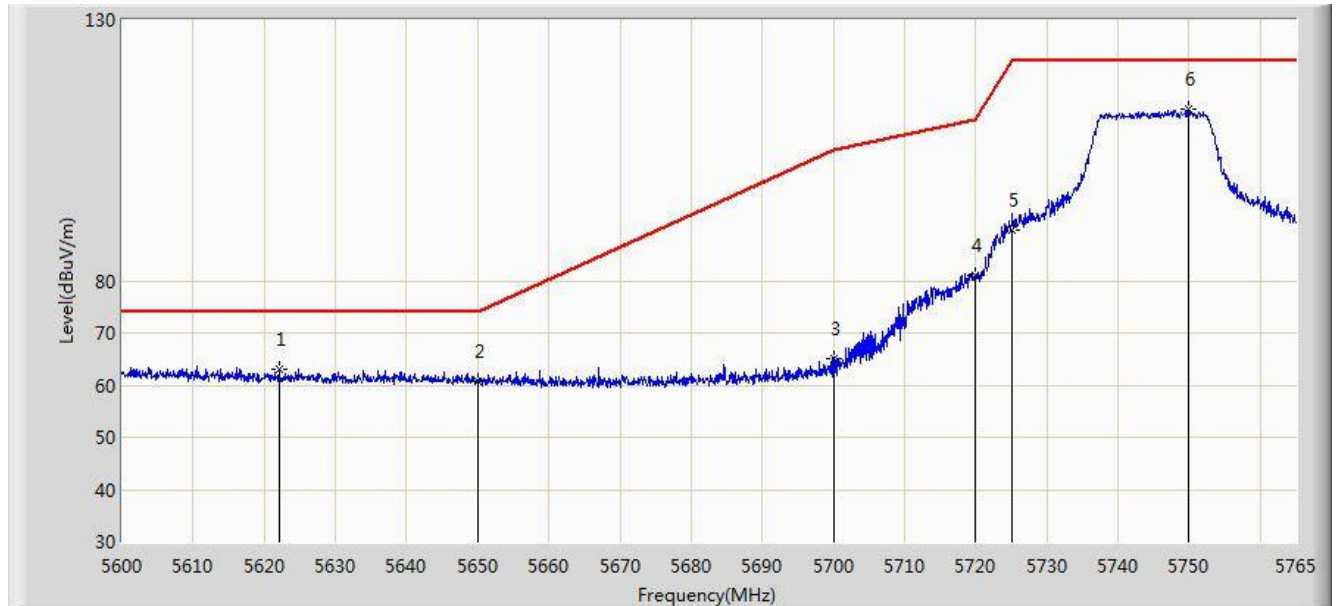

| No | Flag | Mark | Frequency (MHz) | Measure Level (dBuV/m) | Reading Level (dBuV) | Over Limit (dB) | Limit (dBuV/m) | Factor | Type |
|----|------|------|-----------------|------------------------|----------------------|-----------------|----------------|--------|------|
| 1  |      |      | 5622.027        | 63.085                 | 59.491               | -10.915         | 74.000         | 3.594  | PK   |
| 2  |      |      | 5650.000        | 60.597                 | 56.794               | -13.403         | 74.000         | 3.803  | PK   |
| 3  |      |      | 5700.000        | 65.051                 | 61.111               | -40.149         | 105.200        | 3.940  | PK   |
| 4  |      |      | 5720.000        | 81.087                 | 77.105               | -29.713         | 110.800        | 3.982  | PK   |
| 5  |      |      | 5725.000        | 89.750                 | 85.644               | -32.450         | 122.200        | 4.105  | PK   |
| 6  |      | *    | 5749.985        | 112.807                | 108.541              | N/A             | N/A            | 4.266  | PK   |

Note: Measure Level (dBuV/m) = Reading Level (dBuV) + Factor (dB)

Factor (dB) = Cable Loss (dB) + Antenna Factor (dB/m) - Pre\_Amplifier Gain (dB)



|   |                          |
|---|--------------------------|
| Site: AC2   | Time: 2016/08/27 - 18:01 |
| Limit: FCC_Part15.407_RE(3m)                            | Engineer: Bruce Wang     |
| Probe: BBHA9120D_1-18GHz                                | Polarity: Horizontal     |
| EUT: WIRELESS-ABGN 2X2 NETWORK MINIPCIE ADAPTER         | Power: AC 120V/60Hz      |
| Test Mode: Transmit by 802.11a at Channel 5745MHz Ant 1 |                          |

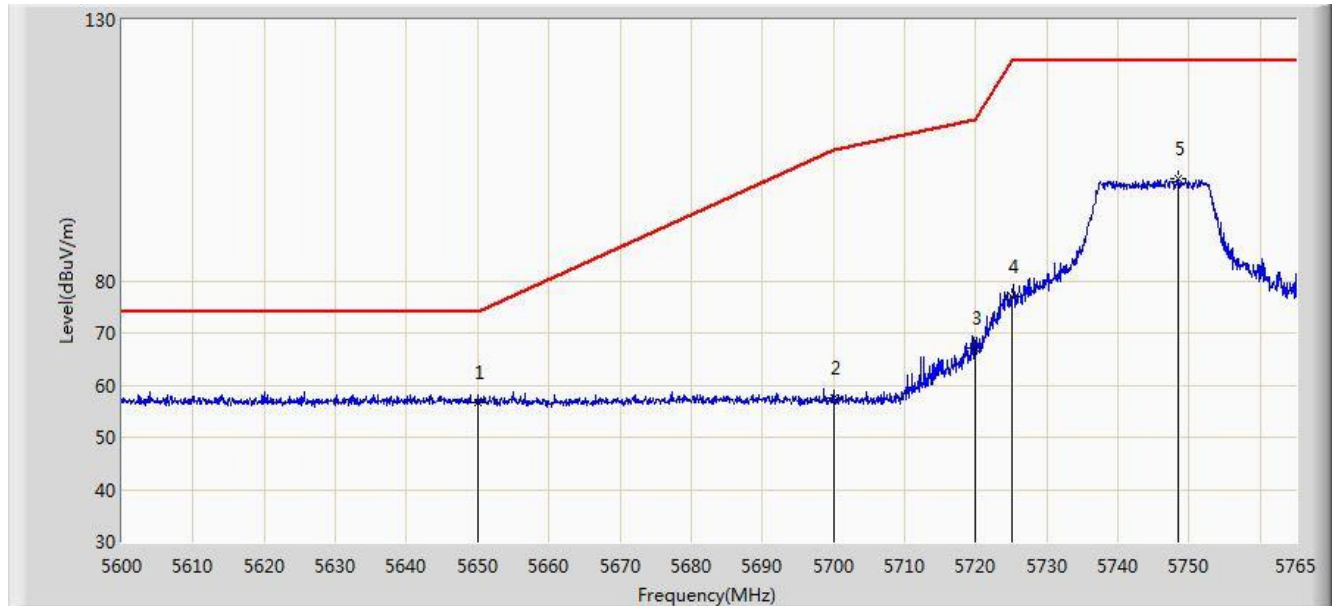

| No | Flag | Mark | Frequency (MHz) | Measure Level (dBuV/m) | Reading Level (dBuV) | Over Limit (dB) | Limit (dBuV/m) | Factor | Type |
|----|------|------|-----------------|------------------------|----------------------|-----------------|----------------|--------|------|
| 1  |      | *    | 5650.000        | 56.669                 | 52.866               | -17.331         | 74.000         | 3.803  | PK   |
| 2  |      |      | 5700.000        | 57.415                 | 53.475               | -47.785         | 105.200        | 3.940  | PK   |
| 3  |      |      | 5720.000        | 67.080                 | 63.098               | -43.720         | 110.800        | 3.982  | PK   |
| 4  |      |      | 5725.000        | 76.945                 | 72.839               | -45.255         | 122.200        | 4.105  | PK   |
| 5  |      |      | 5748.500        | 99.486                 | 95.219               | N/A             | N/A            | 4.267  | PK   |

Note: Measure Level (dB $\mu$ V/m) = Reading Level (dB $\mu$ V) + Factor (dB)

Factor (dB) = Cable Loss (dB) + Antenna Factor (dB/m) - Pre\_Amplifier Gain (dB)

|   |                          |
|---|--------------------------|
| Site: AC2   | Time: 2016/08/27 - 18:04 |
| Limit: FCC_Part15.407_RE(3m)                            | Engineer: Bruce Wang     |
| Probe: BBHA9120D_1-18GHz                                | Polarity: Vertical       |
| EUT: WIRELESS-ABGN 2X2 NETWORK MINIPCIE ADAPTER         | Power: AC 120V/60Hz      |
| Test Mode: Transmit by 802.11a at Channel 5825MHz Ant 1 |                          |

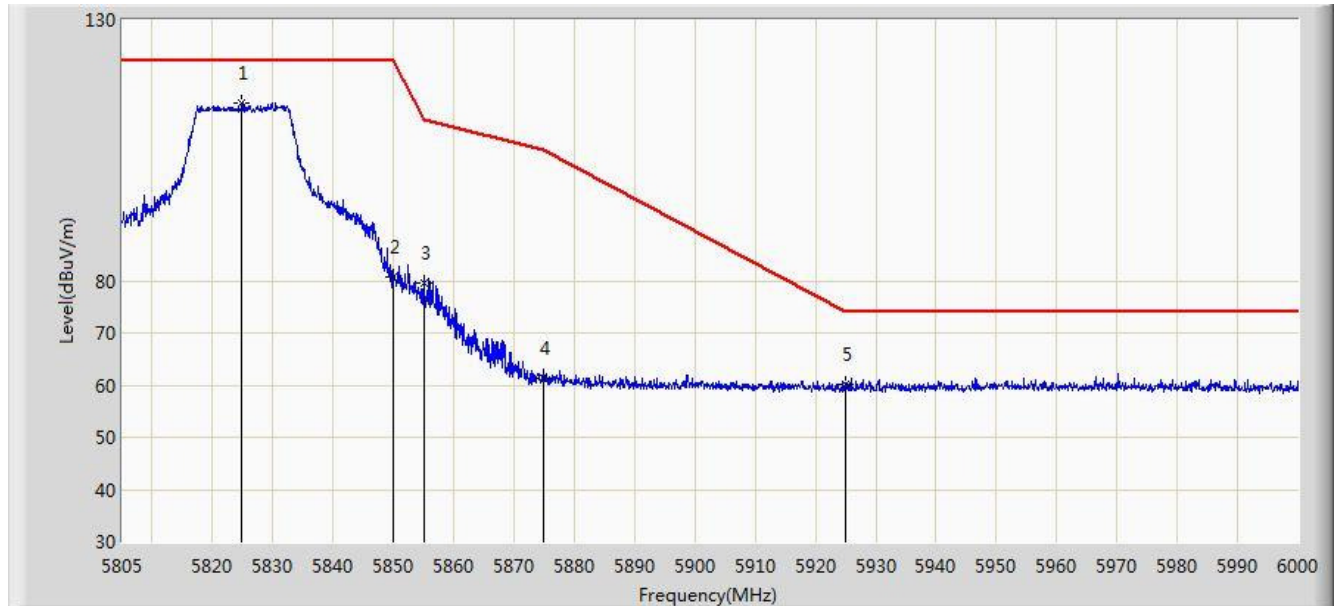

| No | Flag | Mark | Frequency (MHz) | Measure Level (dBuV/m) | Reading Level (dBuV) | Over Limit (dB) | Limit (dBuV/m) | Factor | Type |
|----|------|------|-----------------|------------------------|----------------------|-----------------|----------------|--------|------|
| 1  |      | *    | 5824.890        | 114.182                | 109.446              | N/A             | N/A            | 4.736  | PK   |
| 2  |      |      | 5850.000        | 80.833                 | 75.838               | -41.367         | 122.200        | 4.995  | PK   |
| 3  |      |      | 5855.000        | 79.507                 | 74.519               | -31.293         | 110.800        | 4.987  | PK   |
| 4  |      |      | 5875.000        | 61.348                 | 56.341               | -43.852         | 105.200        | 5.008  | PK   |
| 5  |      |      | 5925.000        | 60.043                 | 54.891               | -13.957         | 74.000         | 5.152  | PK   |

Note: Measure Level (dBμV/m) = Reading Level (dBμV) + Factor (dB)

Factor (dB) = Cable Loss (dB) + Antenna Factor (dB/m) - Pre\_Amplifier Gain (dB)

|   |                          |
|---|--------------------------|
| Site: AC2   | Time: 2016/08/27 - 18:07 |
| Limit: FCC_Part15.407_RE(3m)                            | Engineer: Bruce Wang     |
| Probe: BBHA9120D_1-18GHz                                | Polarity: Horizontal     |
| EUT: WIRELESS-ABGN 2X2 NETWORK MINIPCIE ADAPTER         | Power: AC 120V/60Hz      |
| Test Mode: Transmit by 802.11a at Channel 5825MHz Ant 1 |                          |

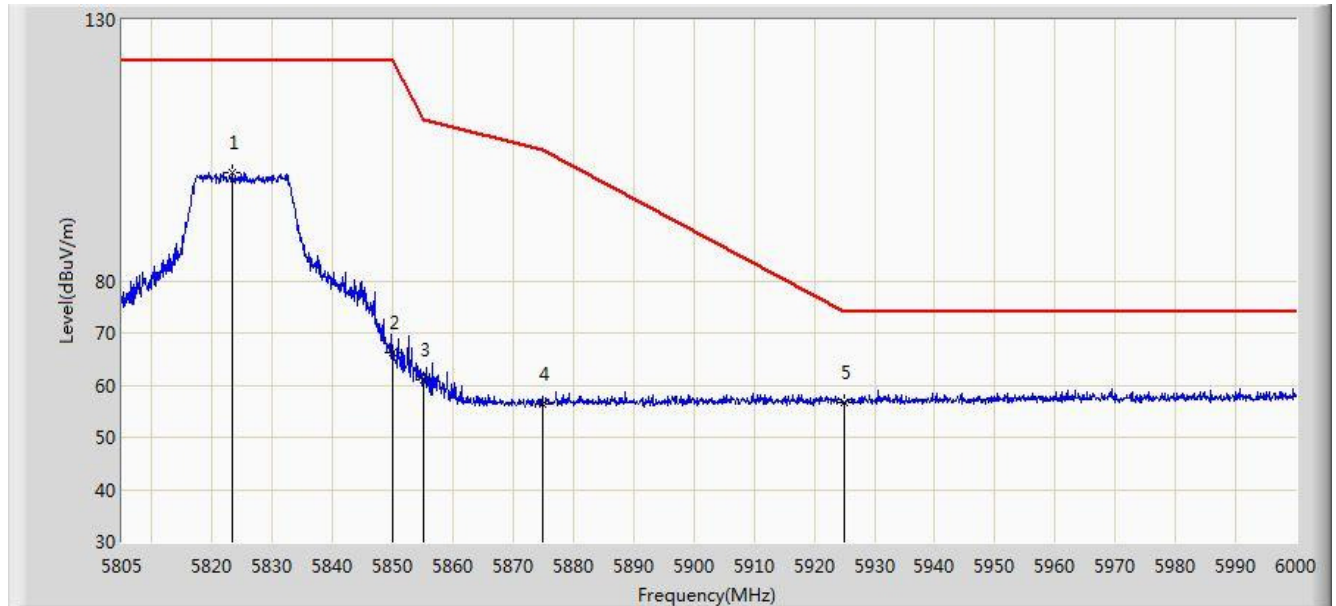

| No | Flag | Mark | Frequency (MHz) | Measure Level (dBuV/m) | Reading Level (dBuV) | Over Limit (dB) | Limit (dBuV/m) | Factor | Type |
|----|------|------|-----------------|------------------------|----------------------|-----------------|----------------|--------|------|
| 1  |      |      | 5823.232        | 100.657                | 95.946               | N/A             | N/A            | 4.712  | PK   |
| 2  |      |      | 5850.000        | 66.365                 | 61.370               | -55.835         | 122.200        | 4.995  | PK   |
| 3  |      |      | 5855.000        | 61.036                 | 56.048               | -49.764         | 110.800        | 4.987  | PK   |
| 4  |      |      | 5875.000        | 56.375                 | 51.368               | -48.825         | 105.200        | 5.008  | PK   |
| 5  |      | *    | 5925.000        | 56.699                 | 51.547               | -17.301         | 74.000         | 5.152  | PK   |

Note: Measure Level (dBμV/m) = Reading Level (dBμV) + Factor (dB)

Factor (dB) = Cable Loss (dB) + Antenna Factor (dB/m) - Pre\_Amplifier Gain (dB)

|  |                          |
|--|--------------------------|
| Site: AC2  | Time: 2016/08/27 - 18:09 |
| Limit: FCC_Part15.209_RE(3m)                                     | Engineer: Bruce Wang     |
| Probe: BBHA9120D_1-18GHz   | Polarity: Vertical       |
| EUT: WIRELESS-ABGN 2X2 NETWORK MINIPCIE ADAPTER                  | Power: AC 120V/60Hz      |
| Test Mode: Transmit by 802.11n-HT20 at Channel 5180MHz Ant 0 + 1 |                          |

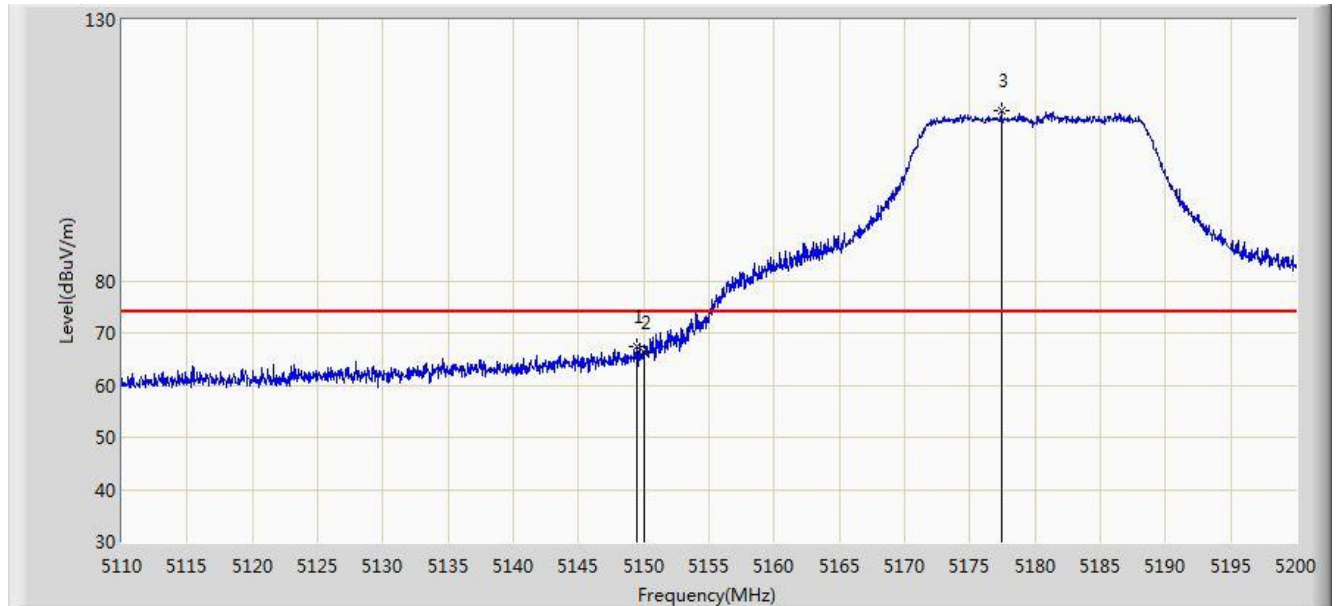

| No | Flag | Mark | Frequency (MHz) | Measure Level (dBuV/m) | Reading Level (dBuV) | Over Limit (dB) | Limit (dBuV/m) | Factor | Type |
|----|------|------|-----------------|------------------------|----------------------|-----------------|----------------|--------|------|
| 1  |      |      | 5149.510        | 67.314                 | 64.243               | -6.686          | 74.000         | 3.071  | PK   |
| 2  |      |      | 5150.000        | 66.121                 | 63.051               | -7.879          | 74.000         | 3.069  | PK   |
| 3  |      | *    | 5177.410        | 112.493                | 109.460              | N/A             | N/A            | 3.033  | PK   |

Note: Measure Level (dB $\mu$ V/m) = Reading Level (dB $\mu$ V) + Factor (dB)

Factor (dB) = Cable Loss (dB) + Antenna Factor (dB/m) - Pre\_Amplifier Gain (dB)

|  |                          |
|--|--------------------------|
| Site: AC2  | Time: 2016/08/27 - 18:14 |
| Limit: FCC_Part15.209_RE(3m)                                     | Engineer: Bruce Wang     |
| Probe: BBHA9120D_1-18GHz   | Polarity: Vertical       |
| EUT: WIRELESS-ABGN 2X2 NETWORK MINIPCIE ADAPTER                  | Power: AC 120V/60Hz      |
| Test Mode: Transmit by 802.11n-HT20 at Channel 5180MHz Ant 0 + 1 |                          |

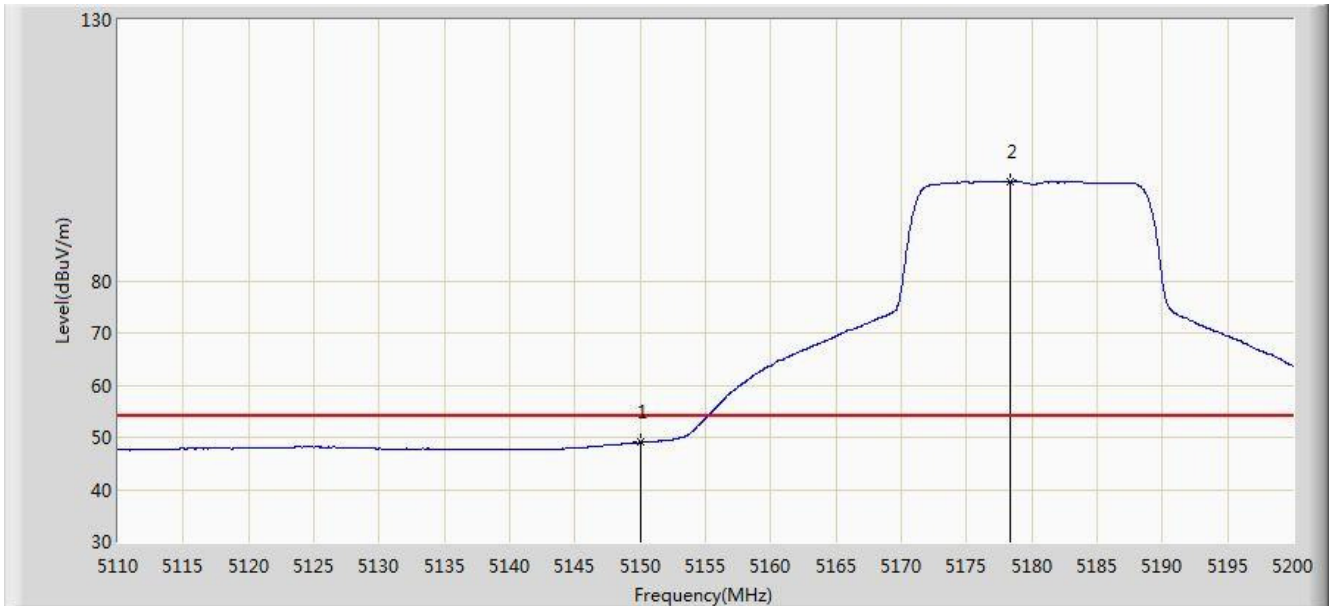

| No | Flag | Mark | Frequency (MHz) | Measure Level (dBuV/m) | Reading Level (dBuV) | Over Limit (dB) | Limit (dBuV/m) | Factor | Type |
|----|------|------|-----------------|------------------------|----------------------|-----------------|----------------|--------|------|
| 1  |      |      | 5150.000        | 48.994                 | 45.924               | -5.006          | 54.000         | 3.069  | AV   |
| 2  |      | *    | 5178.400        | 99.103                 | 96.066               | N/A             | N/A            | 3.037  | AV   |

Note: Measure Level (dB $\mu$ V/m) = Reading Level (dB $\mu$ V) + Factor (dB)

Factor (dB) = Cable Loss (dB) + Antenna Factor (dB/m) - Pre\_Amplifier Gain (dB)

|  |                          |
|--|--------------------------|
| Site: AC2  | Time: 2016/08/27 - 18:15 |
| Limit: FCC_Part15.209_RE(3m)                                     | Engineer: Bruce Wang     |
| Probe: BBHA9120D_1-18GHz   | Polarity: Horizontal     |
| EUT: WIRELESS-ABGN 2X2 NETWORK MINIPCIE ADAPTER                  | Power: AC 120V/60Hz      |
| Test Mode: Transmit by 802.11n-HT20 at Channel 5180MHz Ant 0 + 1 |                          |

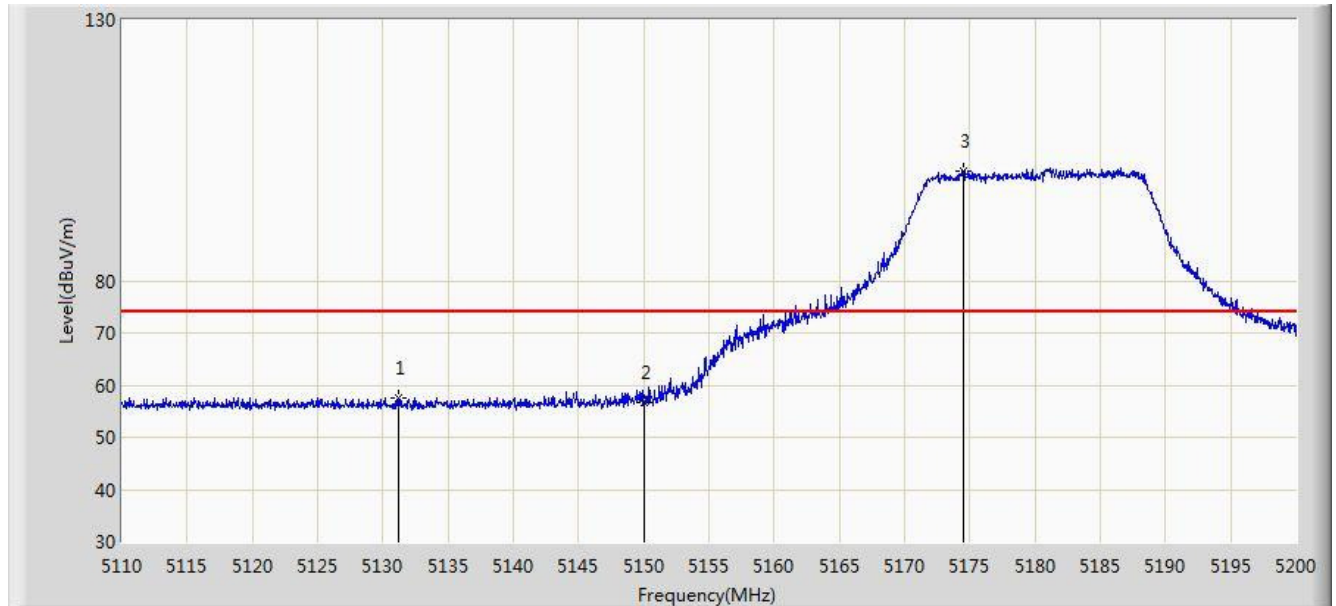

| No | Flag | Mark | Frequency (MHz) | Measure Level (dBuV/m) | Reading Level (dBuV) | Over Limit (dB) | Limit (dBuV/m) | Factor | Type |
|----|------|------|-----------------|------------------------|----------------------|-----------------|----------------|--------|------|
| 1  |      |      | 5131.150        | 57.553                 | 54.400               | -16.447         | 74.000         | 3.153  | PK   |
| 2  |      |      | 5150.000        | 56.767                 | 53.697               | -17.233         | 74.000         | 3.069  | PK   |
| 3  |      | *    | 5174.485        | 100.976                | 97.955               | N/A             | N/A            | 3.021  | PK   |

Note: Measure Level (dBuV/m) = Reading Level (dBuV) + Factor (dB)

Factor (dB) = Cable Loss (dB) + Antenna Factor (dB/m) - Pre\_Amplifier Gain (dB)

|  |                          |
|--|--------------------------|
| Site: AC2  | Time: 2016/08/27 - 18:18 |
| Limit: FCC_Part15.209_RE(3m)                                     | Engineer: Bruce Wang     |
| Probe: BBHA9120D_1-18GHz   | Polarity: Horizontal     |
| EUT: WIRELESS-ABGN 2X2 NETWORK MINIPCIE ADAPTER                  | Power: AC 120V/60Hz      |
| Test Mode: Transmit by 802.11n-HT20 at Channel 5180MHz Ant 0 + 1 |                          |



| No | Flag | Mark | Frequency (MHz) | Measure Level (dBuV/m) | Reading Level (dBuV) | Over Limit (dB) | Limit (dBuV/m) | Factor | Type |
|----|------|------|-----------------|------------------------|----------------------|-----------------|----------------|--------|------|
| 1  |      |      | 5150.000        | 44.275                 | 41.205               | -9.725          | 54.000         | 3.069  | AV   |
| 2  |      | *    | 5179.075        | 88.178                 | 85.139               | N/A             | N/A            | 3.039  | AV   |

Note: Measure Level (dB $\mu$ V/m) = Reading Level (dB $\mu$ V) + Factor (dB)

Factor (dB) = Cable Loss (dB) + Antenna Factor (dB/m) - Pre\_Amplifier Gain (dB)

|  |                          |
|--|--------------------------|
| Site: AC2  | Time: 2016/08/27 - 18:30 |
| Limit: FCC_Part15.209_RE(3m)                                     | Engineer: Bruce Wang     |
| Probe: BBHA9120D_1-18GHz   | Polarity: Vertical       |
| EUT: WIRELESS-ABGN 2X2 NETWORK MINIPCIE ADAPTER                  | Power: AC 120V/60Hz      |
| Test Mode: Transmit by 802.11n-HT20 at Channel 5320MHz Ant 0 + 1 |                          |

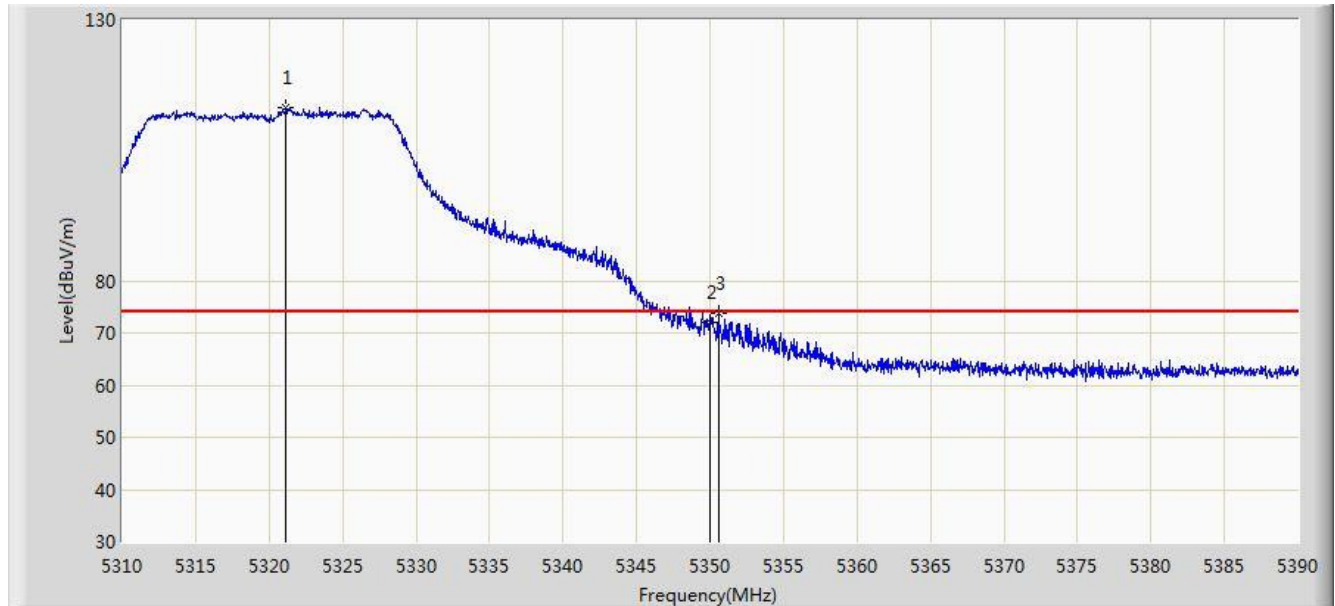

| No | Flag | Mark | Frequency (MHz) | Measure Level (dBuV/m) | Reading Level (dBuV) | Over Limit (dB) | Limit (dBuV/m) | Factor | Type |
|----|------|------|-----------------|------------------------|----------------------|-----------------|----------------|--------|------|
| 1  |      | *    | 5321.160        | 113.219                | 110.552              | N/A             | N/A            | 2.668  | PK   |
| 2  |      |      | 5350.000        | 71.981                 | 69.284               | -2.019          | 74.000         | 2.697  | PK   |
| 3  |      |      | 5350.560        | 73.869                 | 71.170               | -0.131          | 74.000         | 2.699  | PK   |

Note: Measure Level (dB $\mu$ V/m) = Reading Level (dB $\mu$ V) + Factor (dB)

Factor (dB) = Cable Loss (dB) + Antenna Factor (dB/m) - Pre\_Amplifier Gain (dB)



|  |                          |
|--|--------------------------|
| Site: AC2  | Time: 2016/08/27 - 18:33 |
| Limit: FCC_Part15.209_RE(3m)                                     | Engineer: Bruce Wang     |
| Probe: BBHA9120D_1-18GHz   | Polarity: Vertical       |
| EUT: WIRELESS-ABGN 2X2 NETWORK MINIPCIE ADAPTER                  | Power: AC 120V/60Hz      |
| Test Mode: Transmit by 802.11n-HT20 at Channel 5320MHz Ant 0 + 1 |                          |

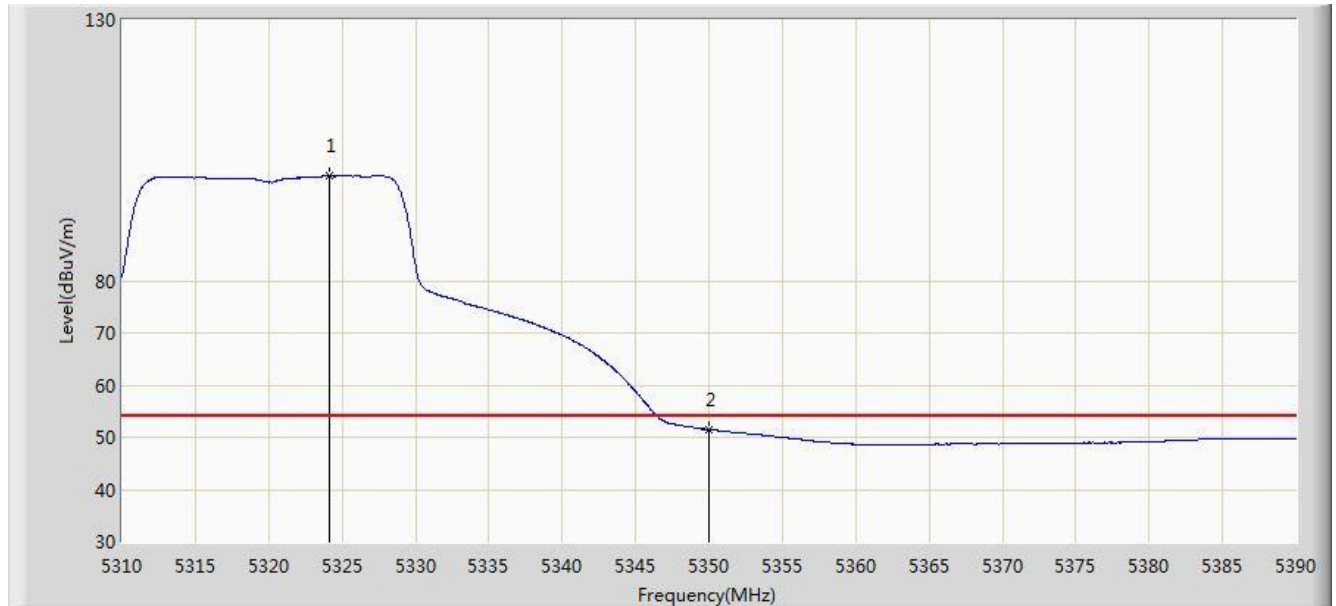

| No | Flag | Mark | Frequency (MHz) | Measure Level (dBuV/m) | Reading Level (dBuV) | Over Limit (dB) | Limit (dBuV/m) | Factor | Type |
|----|------|------|-----------------|------------------------|----------------------|-----------------|----------------|--------|------|
| 1  |      | *    | 5324.120        | 100.036                | 97.356               | N/A             | N/A            | 2.680  | AV   |
| 2  |      |      | 5350.000        | 51.489                 | 48.792               | -2.511          | 54.000         | 2.697  | AV   |

Note: Measure Level (dBμV/m) = Reading Level (dBμV) + Factor (dB)

Factor (dB) = Cable Loss (dB) + Antenna Factor (dB/m) - Pre\_Amplifier Gain (dB)

|  |                          |
|--|--------------------------|
| Site: AC2  | Time: 2016/08/27 - 18:33 |
| Limit: FCC_Part15.209_RE(3m)                                     | Engineer: Bruce Wang     |
| Probe: BBHA9120D_1-18GHz   | Polarity: Horizontal     |
| EUT: WIRELESS-ABGN 2X2 NETWORK MINIPCIE ADAPTER                  | Power: AC 120V/60Hz      |
| Test Mode: Transmit by 802.11n-HT20 at Channel 5320MHz Ant 0 + 1 |                          |

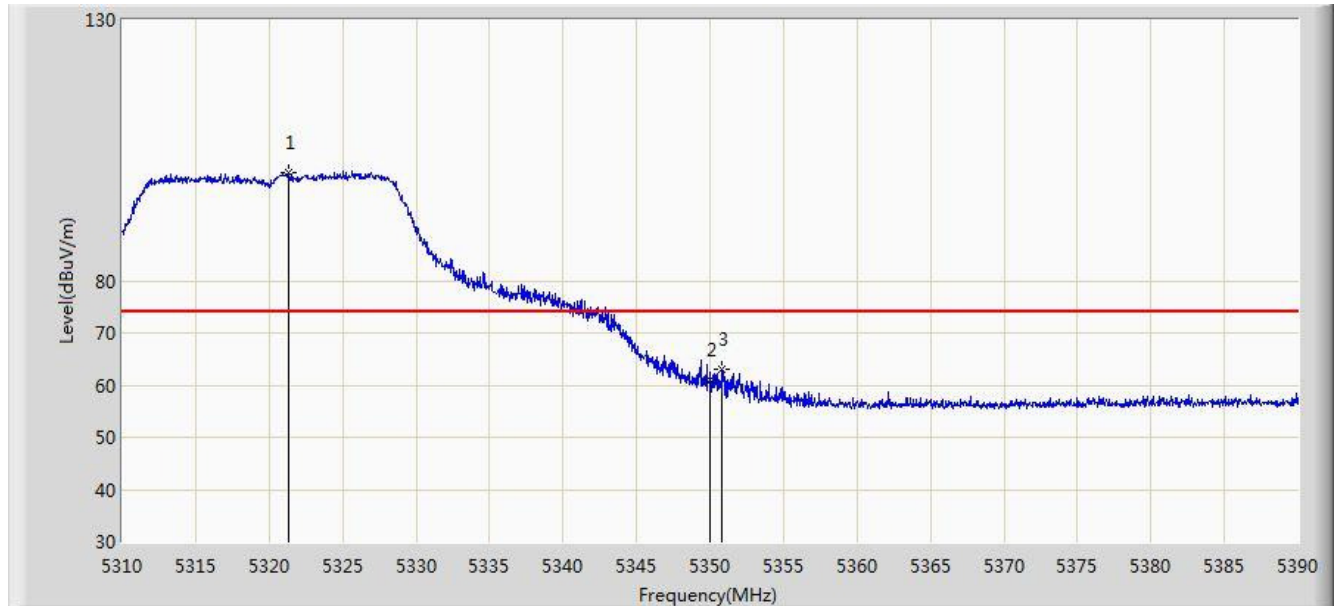

| No | Flag | Mark | Frequency (MHz) | Measure Level (dBuV/m) | Reading Level (dBuV) | Over Limit (dB) | Limit (dBuV/m) | Factor | Type |
|----|------|------|-----------------|------------------------|----------------------|-----------------|----------------|--------|------|
| 1  |      | *    | 5321.280        | 100.730                | 98.062               | N/A             | N/A            | 2.667  | PK   |
| 2  |      |      | 5350.000        | 60.996                 | 58.299               | -13.004         | 74.000         | 2.697  | PK   |
| 3  |      |      | 5350.800        | 62.973                 | 60.273               | -11.027         | 74.000         | 2.700  | PK   |

Note: Measure Level (dBuV/m) = Reading Level (dBuV) + Factor (dB)

Factor (dB) = Cable Loss (dB) + Antenna Factor (dB/m) - Pre\_Amplifier Gain (dB)

|  |                          |
|--|--------------------------|
| Site: AC2  | Time: 2016/08/27 - 18:36 |
| Limit: FCC_Part15.209_RE(3m)                                     | Engineer: Bruce Wang     |
| Probe: BBHA9120D_1-18GHz   | Polarity: Horizontal     |
| EUT: WIRELESS-ABGN 2X2 NETWORK MINIPCIE ADAPTER                  | Power: AC 120V/60Hz      |
| Test Mode: Transmit by 802.11n-HT20 at Channel 5320MHz Ant 0 + 1 |                          |

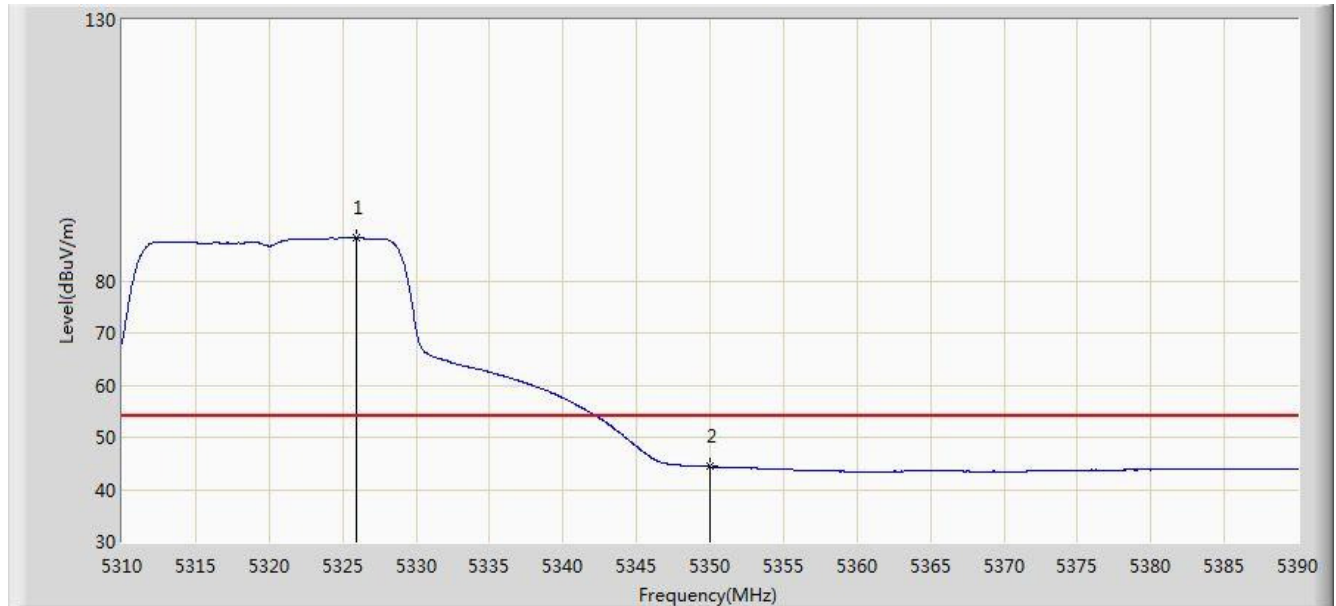

| No | Flag | Mark | Frequency (MHz) | Measure Level (dBuV/m) | Reading Level (dBuV) | Over Limit (dB) | Limit (dBuV/m) | Factor | Type |
|----|------|------|-----------------|------------------------|----------------------|-----------------|----------------|--------|------|
| 1  |      | *    | 5325.920        | 88.246                 | 85.558               | N/A             | N/A            | 2.688  | AV   |
| 2  |      |      | 5350.000        | 44.351                 | 41.654               | -9.649          | 54.000         | 2.697  | AV   |

Note: Measure Level (dBμV/m) = Reading Level (dBμV) + Factor (dB)

Factor (dB) = Cable Loss (dB) + Antenna Factor (dB/m) - Pre\_Amplifier Gain (dB)

|  |                          |
|--|--------------------------|
| Site: AC2  | Time: 2016/08/27 - 18:50 |
| Limit: FCC_Part15.209_RE(3m)                                     | Engineer: Bruce Wang     |
| Probe: BBHA9120D_1-18GHz   | Polarity: Vertical       |
| EUT: WIRELESS-ABGN 2X2 NETWORK MINIPCIE ADAPTER                  | Power: AC 120V/60Hz      |
| Test Mode: Transmit by 802.11n-HT20 at Channel 5500MHz Ant 0 + 1 |                          |

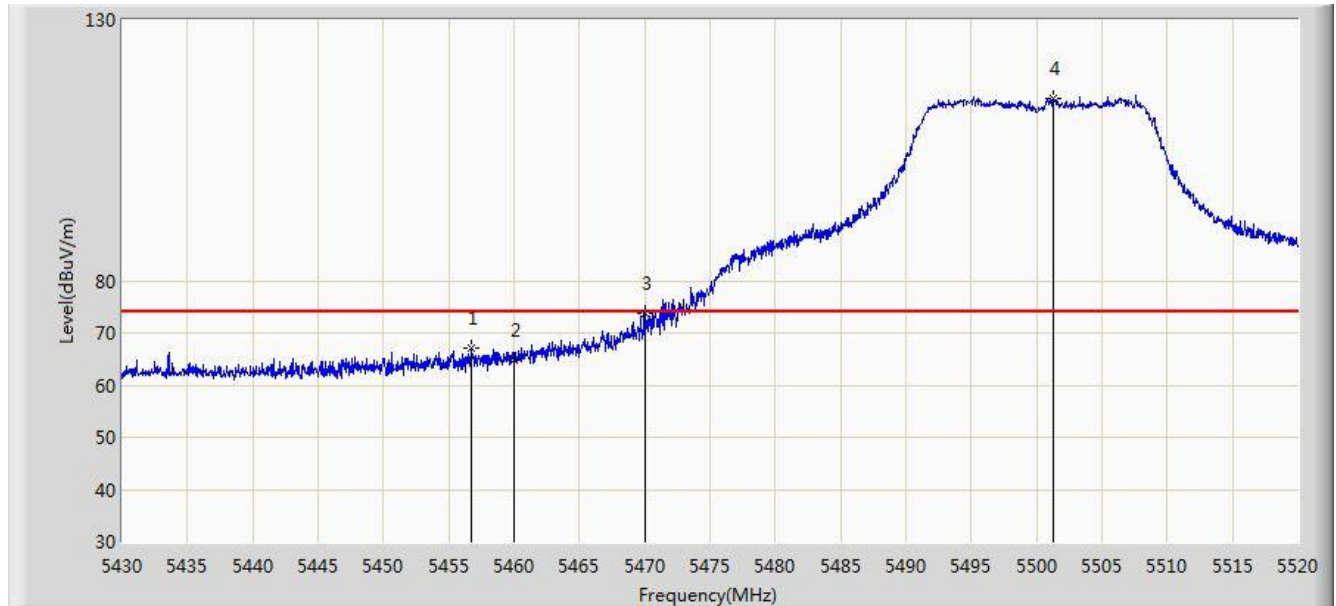

| No | Flag | Mark | Frequency (MHz) | Measure Level (dBuV/m) | Reading Level (dBuV) | Over Limit (dB) | Limit (dBuV/m) | Factor | Type |
|----|------|------|-----------------|------------------------|----------------------|-----------------|----------------|--------|------|
| 1  |      |      | 5456.775        | 66.991                 | 63.906               | -7.009          | 74.000         | 3.085  | PK   |
| 2  |      |      | 5460.000        | 64.895                 | 61.702               | -9.105          | 74.000         | 3.194  | PK   |
| 3  |      |      | 5470.000        | 73.741                 | 70.212               | -0.259          | 74.000         | 3.529  | PK   |
| 4  |      | *    | 5501.325        | 115.072                | 111.971              | N/A             | N/A            | 3.101  | PK   |

Note: Measure Level (dB $\mu$ V/m) = Reading Level (dB $\mu$ V) + Factor (dB)

Factor (dB) = Cable Loss (dB) + Antenna Factor (dB/m) - Pre\_Amplifier Gain (dB)

|  |                          |
|--|--------------------------|
| Site: AC2  | Time: 2016/08/27 - 18:51 |
| Limit: FCC_Part15.209_RE(3m)                                     | Engineer: Bruce Wang     |
| Probe: BBHA9120D_1-18GHz   | Polarity: Vertical       |
| EUT: WIRELESS-ABGN 2X2 NETWORK MINIPCIE ADAPTER                  | Power: AC 120V/60Hz      |
| Test Mode: Transmit by 802.11n-HT20 at Channel 5500MHz Ant 0 + 1 |                          |

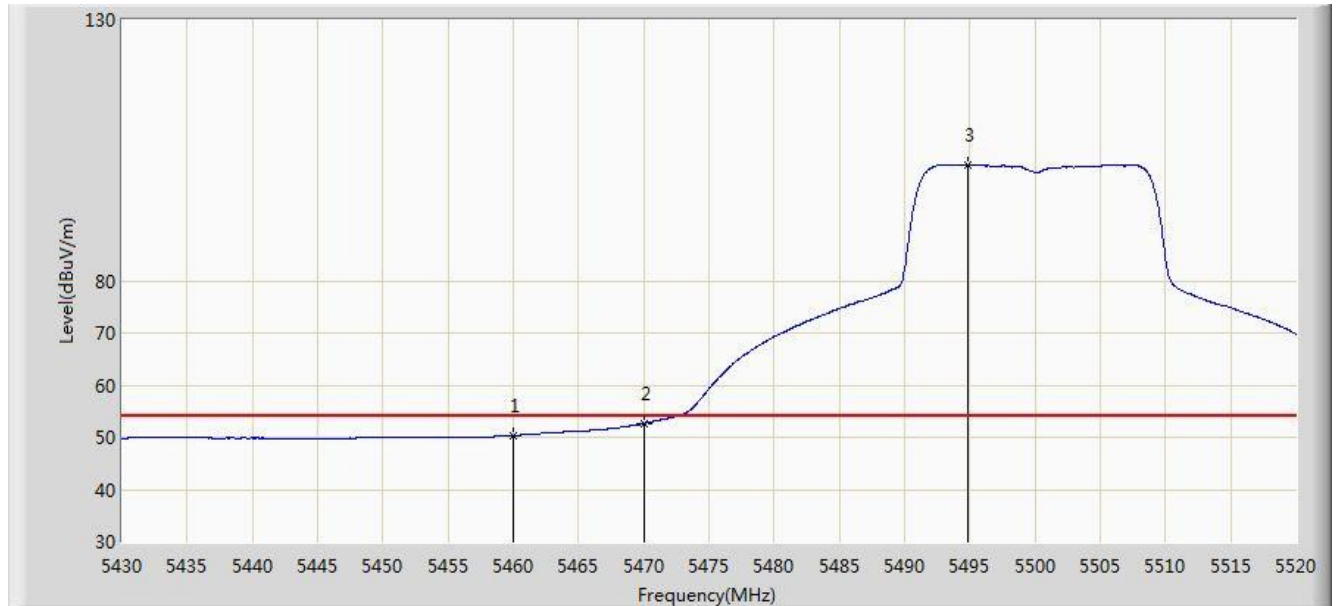

| No | Flag | Mark | Frequency (MHz) | Measure Level (dBuV/m) | Reading Level (dBuV) | Over Limit (dB) | Limit (dBuV/m) | Factor | Type |
|----|------|------|-----------------|------------------------|----------------------|-----------------|----------------|--------|------|
| 1  |      |      | 5460.000        | 50.391                 | 47.198               | -3.609          | 54.000         | 3.194  | AV   |
| 2  |      |      | 5470.000        | 52.686                 | 49.157               | -1.314          | 54.000         | 3.529  | AV   |
| 3  |      | *    | 5494.890        | 102.267                | 99.105               | N/A             | N/A            | 3.161  | AV   |

Note: Measure Level (dB $\mu$ V/m) = Reading Level (dB $\mu$ V) + Factor (dB)

Factor (dB) = Cable Loss (dB) + Antenna Factor (dB/m) - Pre\_Amplifier Gain (dB)

|  |                          |
|--|--------------------------|
| Site: AC2  | Time: 2016/08/27 - 18:53 |
| Limit: FCC_Part15.209_RE(3m)                                     | Engineer: Bruce Wang     |
| Probe: BBHA9120D_1-18GHz   | Polarity: Horizontal     |
| EUT: WIRELESS-ABGN 2X2 NETWORK MINIPCIE ADAPTER                  | Power: AC 120V/60Hz      |
| Test Mode: Transmit by 802.11n-HT20 at Channel 5500MHz Ant 0 + 1 |                          |

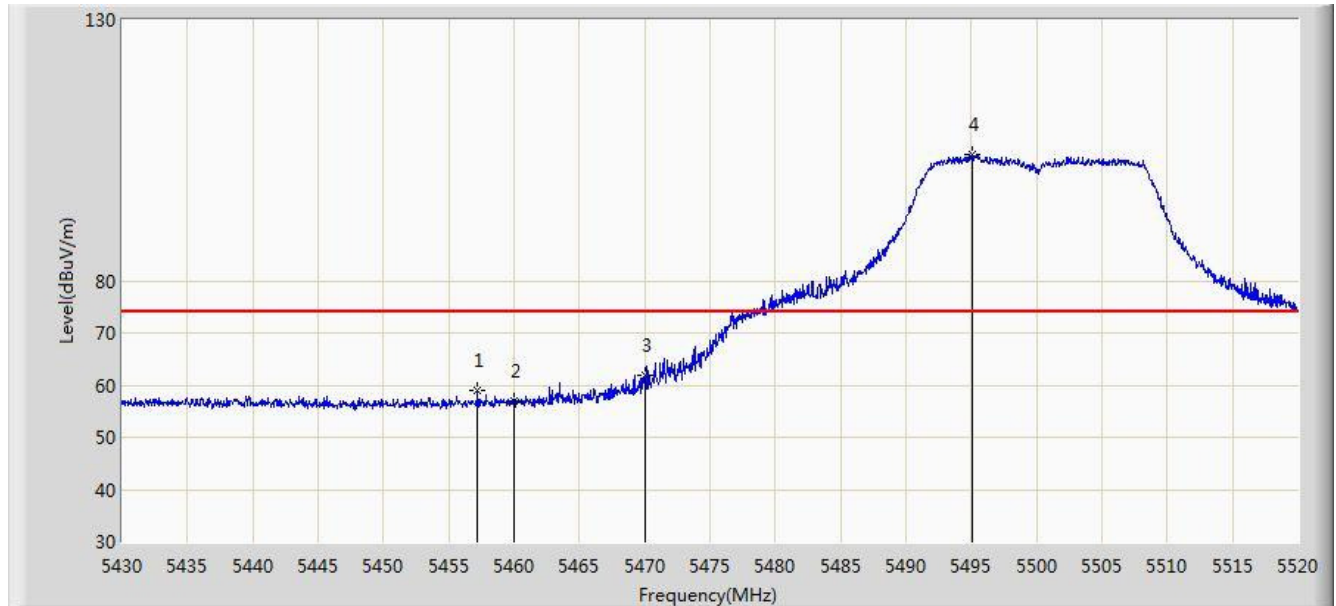

| No | Flag | Mark | Frequency (MHz) | Measure Level (dBuV/m) | Reading Level (dBuV) | Over Limit (dB) | Limit (dBuV/m) | Factor | Type |
|----|------|------|-----------------|------------------------|----------------------|-----------------|----------------|--------|------|
| 1  |      |      | 5457.225        | 59.032                 | 55.932               | -14.968         | 74.000         | 3.100  | PK   |
| 2  |      |      | 5460.000        | 56.845                 | 53.652               | -17.155         | 74.000         | 3.194  | PK   |
| 3  |      |      | 5470.000        | 61.889                 | 58.360               | -12.111         | 74.000         | 3.529  | PK   |
| 4  |      | *    | 5495.025        | 104.096                | 100.935              | N/A             | N/A            | 3.162  | PK   |

Note: Measure Level (dBμV/m) = Reading Level (dBμV) + Factor (dB)

Factor (dB) = Cable Loss (dB) + Antenna Factor (dB/m) - Pre\_Amplifier Gain (dB)

|  |                          |
|--|--------------------------|
| Site: AC2  | Time: 2016/08/27 - 18:55 |
| Limit: FCC_Part15.209_RE(3m)                                     | Engineer: Bruce Wang     |
| Probe: BBHA9120D_1-18GHz   | Polarity: Horizontal     |
| EUT: WIRELESS-ABGN 2X2 NETWORK MINIPCIE ADAPTER                  | Power: AC 120V/60Hz      |
| Test Mode: Transmit by 802.11n-HT20 at Channel 5500MHz Ant 0 + 1 |                          |

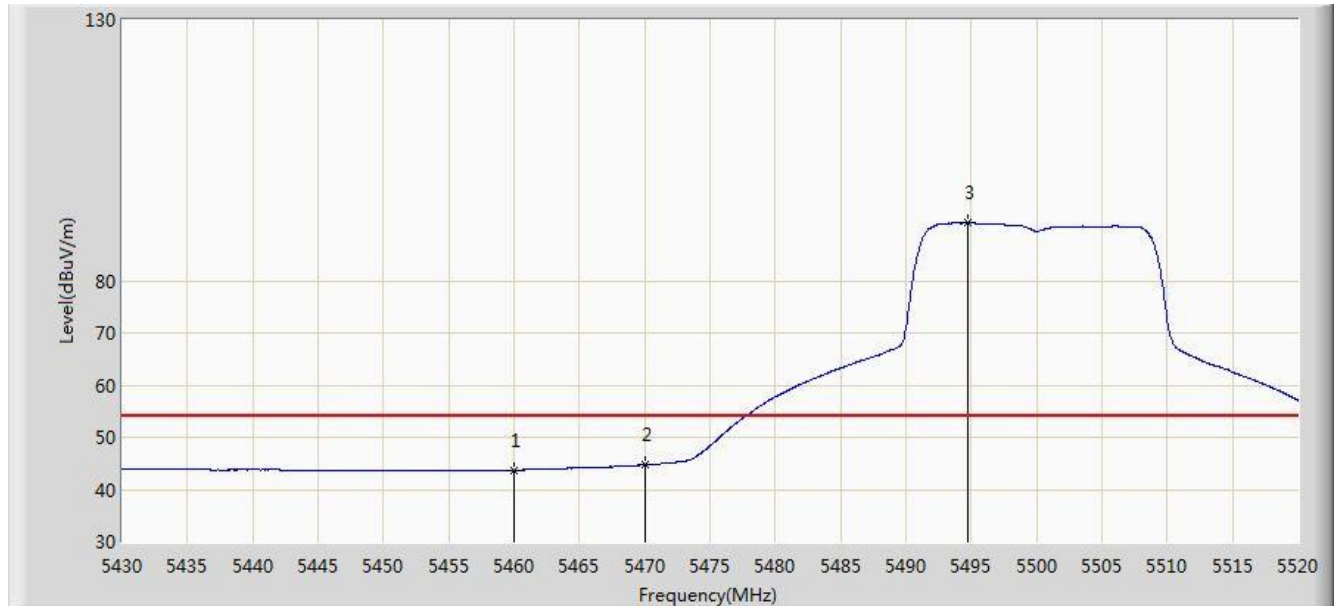

| No | Flag | Mark | Frequency (MHz) | Measure Level (dBuV/m) | Reading Level (dBuV) | Over Limit (dB) | Limit (dBuV/m) | Factor | Type |
|----|------|------|-----------------|------------------------|----------------------|-----------------|----------------|--------|------|
| 1  |      |      | 5460.000        | 43.720                 | 40.527               | -10.280         | 54.000         | 3.194  | AV   |
| 2  |      |      | 5470.000        | 44.686                 | 41.157               | -9.314          | 54.000         | 3.529  | AV   |
| 3  |      | *    | 5494.755        | 91.188                 | 88.024               | N/A             | N/A            | 3.163  | AV   |

Note: Measure Level (dBuV/m) = Reading Level (dBuV) + Factor (dB)

Factor (dB) = Cable Loss (dB) + Antenna Factor (dB/m) - Pre\_Amplifier Gain (dB)

|  |                          |
|--|--------------------------|
| Site: AC2  | Time: 2016/08/27 - 19:11 |
| Limit: FCC_Part15.209_RE(3m)                                     | Engineer: Bruce Wang     |
| Probe: BBHA9120D_1-18GHz   | Polarity: Vertical       |
| EUT: WIRELESS-ABGN 2X2 NETWORK MINIPCIE ADAPTER                  | Power: AC 120V/60Hz      |
| Test Mode: Transmit by 802.11n-HT20 at Channel 5700MHz Ant 0 + 1 |                          |

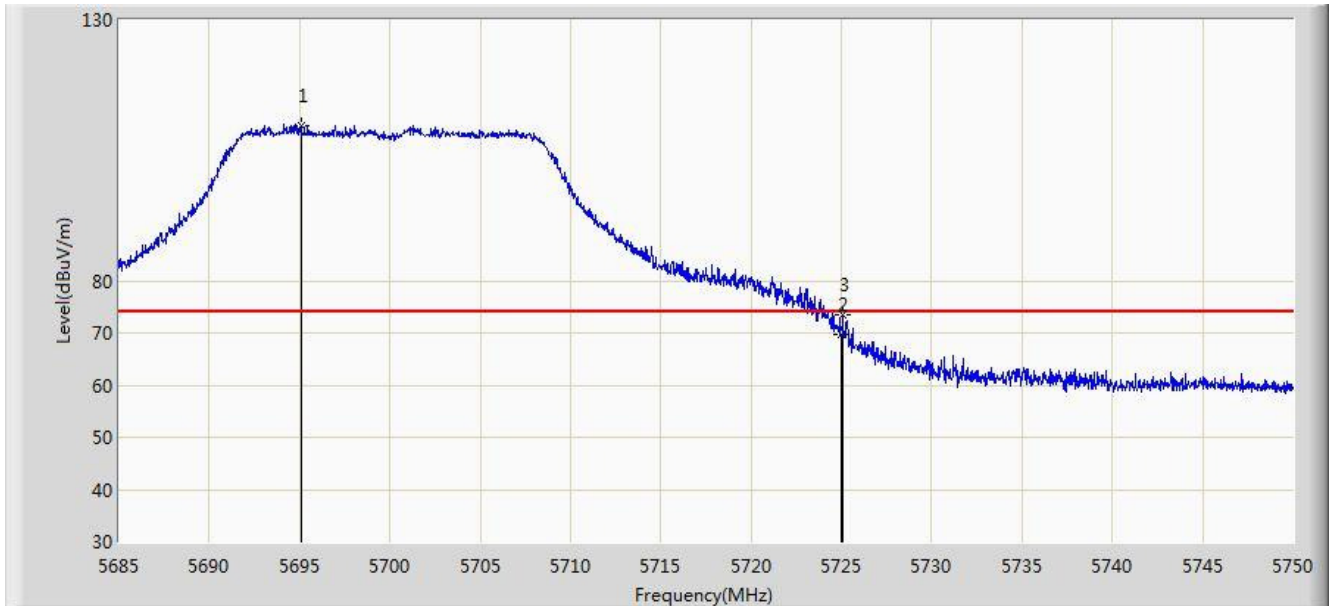

| No | Flag | Mark | Frequency (MHz) | Measure Level (dBuV/m) | Reading Level (dBuV) | Over Limit (dB) | Limit (dBuV/m) | Factor | Type |
|----|------|------|-----------------|------------------------|----------------------|-----------------|----------------|--------|------|
| 1  |      | *    | 5695.075        | 109.806                | 105.816              | N/A             | N/A            | 3.991  | PK   |
| 2  |      |      | 5725.000        | 69.732                 | 65.626               | -4.268          | 74.000         | 4.105  | PK   |
| 3  |      |      | 5725.072        | 73.609                 | 69.502               | -0.391          | 74.000         | 4.108  | PK   |

Note: Measure Level (dBuV/m) = Reading Level (dBuV) + Factor (dB)

Factor (dB) = Cable Loss (dB) + Antenna Factor (dB/m) - Pre\_Amplifier Gain (dB)



|  |                          |
|--|--------------------------|
| Site: AC2  | Time: 2016/08/27 - 19:14 |
| Limit: FCC_Part15.209_RE(3m)                                     | Engineer: Bruce Wang     |
| Probe: BBHA9120D_1-18GHz   | Polarity: Vertical       |
| EUT: WIRELESS-ABGN 2X2 NETWORK MINIPCIE ADAPTER                  | Power: AC 120V/60Hz      |
| Test Mode: Transmit by 802.11n-HT20 at Channel 5700MHz Ant 0 + 1 |                          |

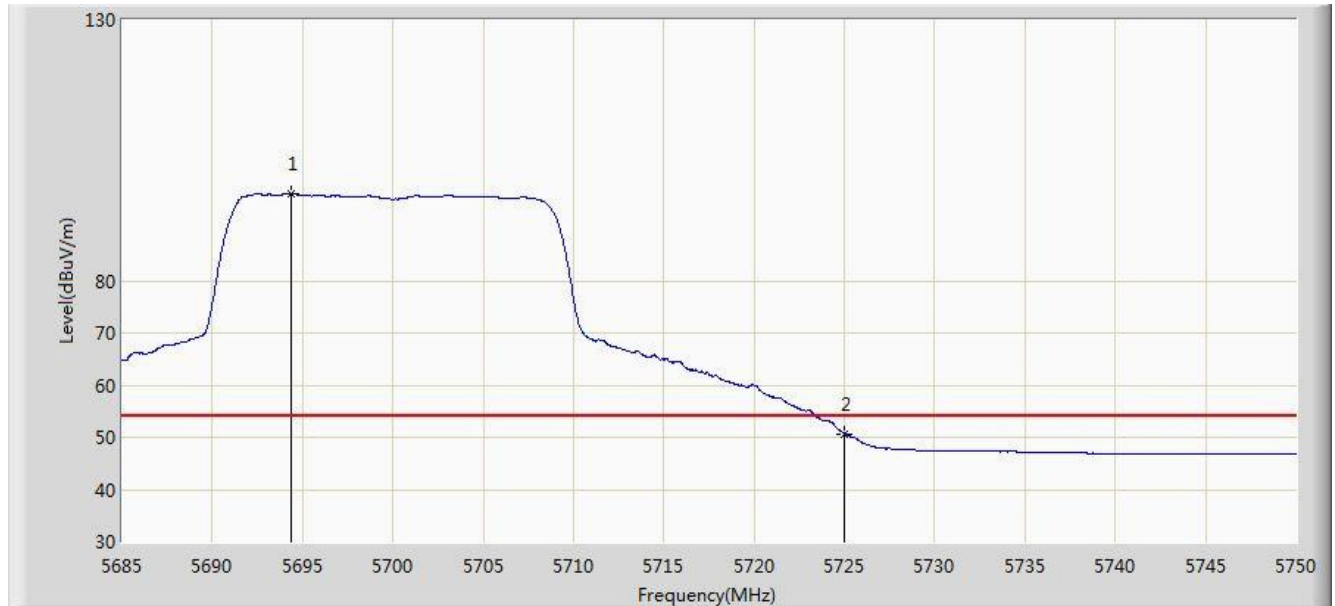

| No | Flag | Mark | Frequency (MHz) | Measure Level (dBuV/m) | Reading Level (dBuV) | Over Limit (dB) | Limit (dBuV/m) | Factor | Type |
|----|------|------|-----------------|------------------------|----------------------|-----------------|----------------|--------|------|
| 1  |      | *    | 5694.360        | 96.629                 | 92.632               | N/A             | N/A            | 3.996  | AV   |
| 2  |      |      | 5725.000        | 50.694                 | 46.588               | -3.306          | 54.000         | 4.105  | AV   |

Note: Measure Level (dBμV/m) = Reading Level (dBμV) + Factor (dB)

Factor (dB) = Cable Loss (dB) + Antenna Factor (dB/m) - Pre\_Amplifier Gain (dB)

|  |                          |
|--|--------------------------|
| Site: AC2  | Time: 2016/08/27 - 19:15 |
| Limit: FCC_Part15.209_RE(3m)                                     | Engineer: Bruce Wang     |
| Probe: BBHA9120D_1-18GHz   | Polarity: Horizontal     |
| EUT: WIRELESS-ABGN 2X2 NETWORK MINIPCIE ADAPTER                  | Power: AC 120V/60Hz      |
| Test Mode: Transmit by 802.11n-HT20 at Channel 5700MHz Ant 0 + 1 |                          |

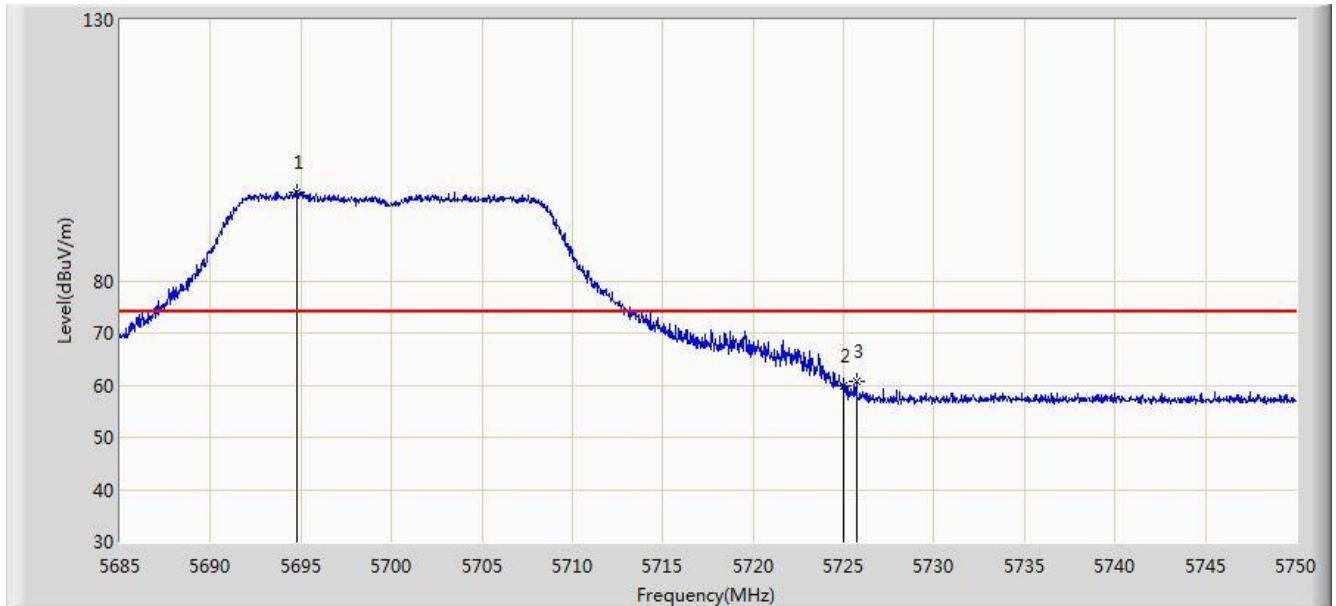

| No | Flag | Mark | Frequency (MHz) | Measure Level (dBuV/m) | Reading Level (dBuV) | Over Limit (dB) | Limit (dBuV/m) | Factor | Type |
|----|------|------|-----------------|------------------------|----------------------|-----------------|----------------|--------|------|
| 1  |      | *    | 5694.815        | 96.933                 | 92.940               | N/A             | N/A            | 3.992  | PK   |
| 2  |      |      | 5725.000        | 59.739                 | 55.633               | -14.261         | 74.000         | 4.105  | PK   |
| 3  |      |      | 5725.723        | 60.788                 | 56.665               | -13.212         | 74.000         | 4.124  | PK   |

Note: Measure Level (dB $\mu$ V/m) = Reading Level (dB $\mu$ V) + Factor (dB)

Factor (dB) = Cable Loss (dB) + Antenna Factor (dB/m) - Pre\_Amplifier Gain (dB)

|  |                          |
|--|--------------------------|
| Site: AC2  | Time: 2016/08/27 - 19:18 |
| Limit: FCC_Part15.209_RE(3m)                                     | Engineer: Bruce Wang     |
| Probe: BBHA9120D_1-18GHz   | Polarity: Horizontal     |
| EUT: WIRELESS-ABGN 2X2 NETWORK MINIPCIE ADAPTER                  | Power: AC 120V/60Hz      |
| Test Mode: Transmit by 802.11n-HT20 at Channel 5700MHz Ant 0 + 1 |                          |

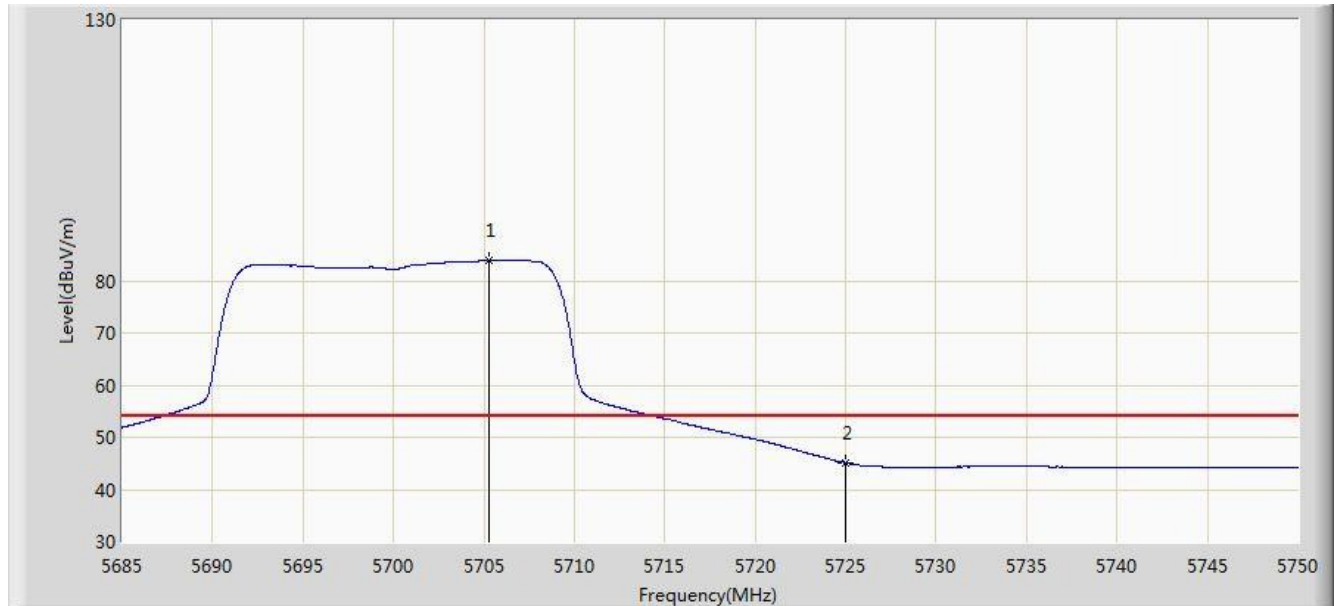

| No | Flag | Mark | Frequency (MHz) | Measure Level (dBuV/m) | Reading Level (dBuV) | Over Limit (dB) | Limit (dBuV/m) | Factor | Type |
|----|------|------|-----------------|------------------------|----------------------|-----------------|----------------|--------|------|
| 1  |      | *    | 5705.280        | 83.805                 | 79.918               | N/A             | N/A            | 3.887  | AV   |
| 2  |      |      | 5725.000        | 45.109                 | 41.003               | -8.891          | 54.000         | 4.105  | AV   |

Note: Measure Level (dBμV/m) = Reading Level (dBμV) + Factor (dB)

Factor (dB) = Cable Loss (dB) + Antenna Factor (dB/m) - Pre\_Amplifier Gain (dB)

|  |                          |
|--|--------------------------|
| Site: AC2  | Time: 2016/08/27 - 19:21 |
| Limit: FCC_Part15.407_RE(3m)                                     | Engineer: Bruce Wang     |
| Probe: BBHA9120D_1-18GHz   | Polarity: Vertical       |
| EUT: WIRELESS-ABGN 2X2 NETWORK MINIPCIE ADAPTER                  | Power: AC 120V/60Hz      |
| Test Mode: Transmit by 802.11n-HT20 at Channel 5745MHz Ant 0 + 1 |                          |

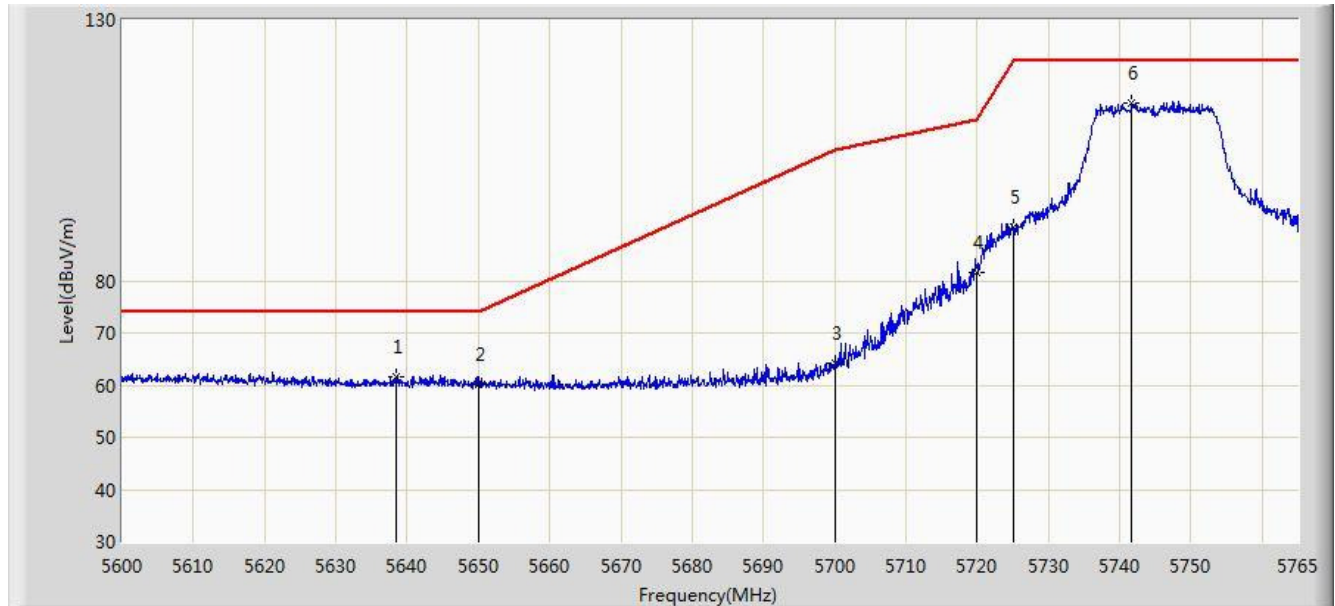

| No | Flag | Mark | Frequency (MHz) | Measure Level (dBuV/m) | Reading Level (dBuV) | Over Limit (dB) | Limit (dBuV/m) | Factor | Type |
|----|------|------|-----------------|------------------------|----------------------|-----------------|----------------|--------|------|
| 1  |      |      | 5638.362        | 61.525                 | 57.733               | -12.475         | 74.000         | 3.791  | PK   |
| 2  |      |      | 5650.000        | 60.203                 | 56.400               | -13.797         | 74.000         | 3.803  | PK   |
| 3  |      |      | 5700.000        | 64.294                 | 60.354               | -40.906         | 105.200        | 3.940  | PK   |
| 4  |      |      | 5720.000        | 81.493                 | 77.511               | -29.307         | 110.800        | 3.982  | PK   |
| 5  |      |      | 5725.000        | 90.249                 | 86.143               | -31.951         | 122.200        | 4.105  | PK   |
| 6  |      | *    | 5741.735        | 114.150                | 109.876              | N/A             | N/A            | 4.274  | PK   |

Note: Measure Level (dBμV/m) = Reading Level (dBμV) + Factor (dB)

Factor (dB) = Cable Loss (dB) + Antenna Factor (dB/m) - Pre\_Amplifier Gain (dB)

|  |                          |
|--|--------------------------|
| Site: AC2  | Time: 2016/08/27 - 19:24 |
| Limit: FCC_Part15.407_RE(3m)                                     | Engineer: Bruce Wang     |
| Probe: BBHA9120D_1-18GHz   | Polarity: Horizontal     |
| EUT: WIRELESS-ABGN 2X2 NETWORK MINIPCIE ADAPTER                  | Power: AC 120V/60Hz      |
| Test Mode: Transmit by 802.11n-HT20 at Channel 5745MHz Ant 0 + 1 |                          |

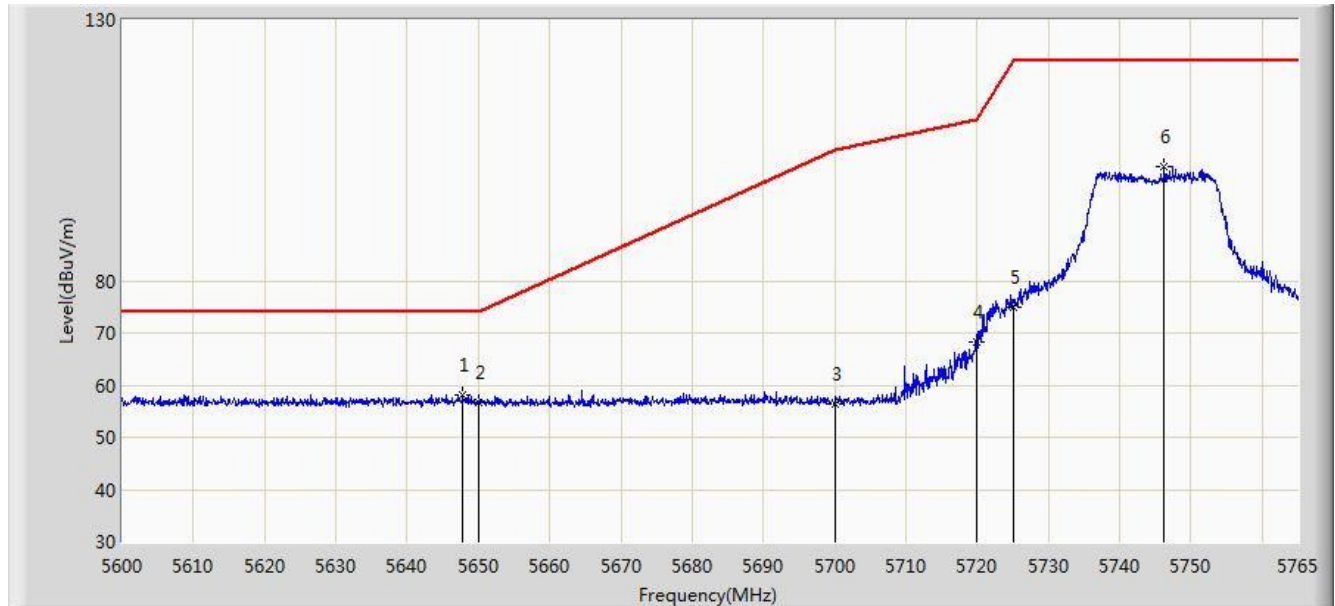

| No | Flag | Mark | Frequency (MHz) | Measure Level (dBuV/m) | Reading Level (dBuV) | Over Limit (dB) | Limit (dBuV/m) | Factor | Type |
|----|------|------|-----------------|------------------------|----------------------|-----------------|----------------|--------|------|
| 1  |      | *    | 5647.768        | 58.143                 | 54.289               | -15.857         | 74.000         | 3.854  | PK   |
| 2  |      |      | 5650.000        | 56.673                 | 52.870               | -17.327         | 74.000         | 3.803  | PK   |
| 3  |      |      | 5700.000        | 56.488                 | 52.548               | -48.712         | 105.200        | 3.940  | PK   |
| 4  |      |      | 5720.000        | 68.365                 | 64.383               | -42.435         | 110.800        | 3.982  | PK   |
| 5  |      |      | 5725.000        | 75.013                 | 70.907               | -47.187         | 122.200        | 4.105  | PK   |
| 6  |      |      | 5746.272        | 101.831                | 97.563               | N/A             | N/A            | 4.268  | PK   |

Note: Measure Level (dB $\mu$ V/m) = Reading Level (dB $\mu$ V) + Factor (dB)

Factor (dB) = Cable Loss (dB) + Antenna Factor (dB/m) - Pre\_Amplifier Gain (dB)

|  |                          |
|--|--------------------------|
| Site: AC2  | Time: 2016/08/27 - 19:26 |
| Limit: FCC_Part15.407_RE(3m)                                     | Engineer: Bruce Wang     |
| Probe: BBHA9120D_1-18GHz   | Polarity: Vertical       |
| EUT: WIRELESS-ABGN 2X2 NETWORK MINIPCIE ADAPTER                  | Power: AC 120V/60Hz      |
| Test Mode: Transmit by 802.11n-HT20 at Channel 5825MHz Ant 0 + 1 |                          |

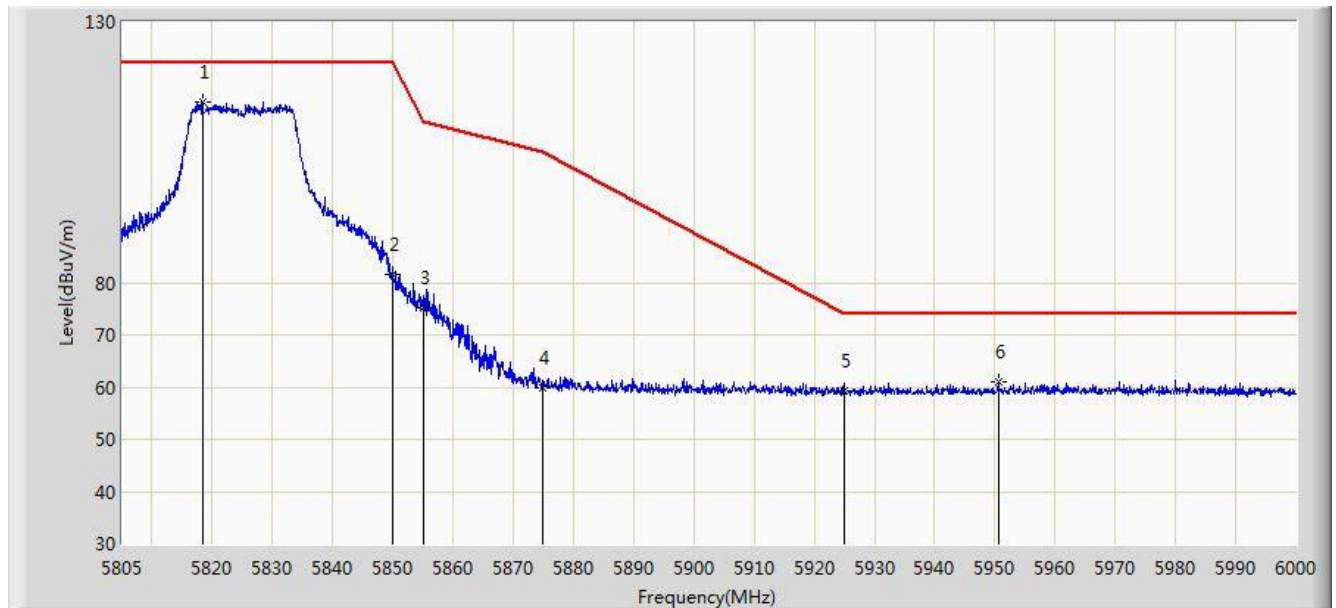

| No | Flag | Mark | Frequency (MHz) | Measure Level (dBuV/m) | Reading Level (dBuV) | Over Limit (dB) | Limit (dBuV/m) | Factor | Type |
|----|------|------|-----------------|------------------------|----------------------|-----------------|----------------|--------|------|
| 1  |      | *    | 5818.455        | 114.650                | 109.988              | N/A             | N/A            | 4.662  | PK   |
| 2  |      |      | 5850.000        | 81.535                 | 76.540               | -40.665         | 122.200        | 4.995  | PK   |
| 3  |      |      | 5855.000        | 75.345                 | 70.357               | -35.455         | 110.800        | 4.987  | PK   |
| 4  |      |      | 5875.000        | 59.903                 | 54.896               | -45.297         | 105.200        | 5.008  | PK   |
| 5  |      |      | 5925.000        | 59.389                 | 54.237               | -14.611         | 74.000         | 5.152  | PK   |
| 6  |      |      | 5950.567        | 61.131                 | 55.907               | -12.869         | 74.000         | 5.224  | PK   |

Note: Measure Level (dB $\mu$ V/m) = Reading Level (dB $\mu$ V) + Factor (dB)

Factor (dB) = Cable Loss (dB) + Antenna Factor (dB/m) - Pre\_Amplifier Gain (dB)

|  |                          |
|--|--------------------------|
| Site: AC2  | Time: 2016/08/27 - 19:30 |
| Limit: FCC_Part15.407_RE(3m)                                     | Engineer: Bruce Wang     |
| Probe: BBHA9120D_1-18GHz   | Polarity: Horizontal     |
| EUT: WIRELESS-ABGN 2X2 NETWORK MINIPCIE ADAPTER                  | Power: AC 120V/60Hz      |
| Test Mode: Transmit by 802.11n-HT20 at Channel 5825MHz Ant 0 + 1 |                          |

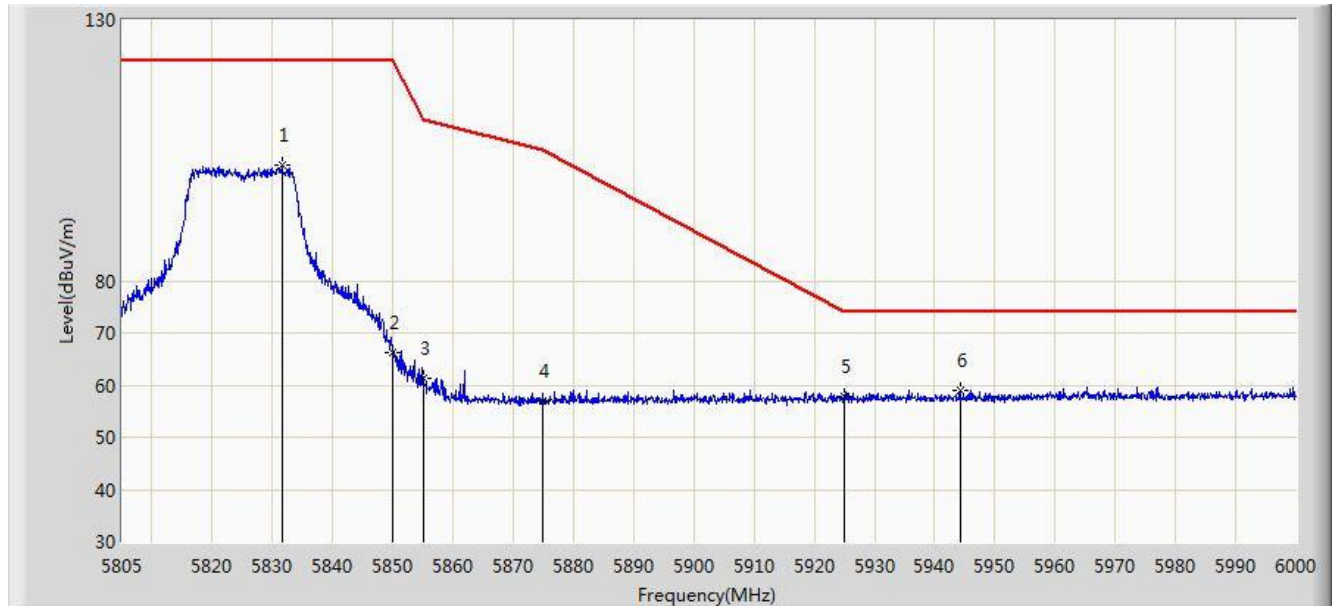

| No | Flag | Mark | Frequency (MHz) | Measure Level (dBuV/m) | Reading Level (dBuV) | Over Limit (dB) | Limit (dBuV/m) | Factor | Type |
|----|------|------|-----------------|------------------------|----------------------|-----------------|----------------|--------|------|
| 1  |      |      | 5831.520        | 102.254                | 97.407               | N/A             | N/A            | 4.847  | PK   |
| 2  |      |      | 5850.000        | 66.100                 | 61.105               | -56.100         | 122.200        | 4.995  | PK   |
| 3  |      |      | 5855.000        | 61.338                 | 56.350               | -49.462         | 110.800        | 4.987  | PK   |
| 4  |      |      | 5875.000        | 56.882                 | 51.875               | -48.318         | 105.200        | 5.008  | PK   |
| 5  |      |      | 5925.000        | 57.787                 | 52.635               | -16.213         | 74.000         | 5.152  | PK   |
| 6  |      | *    | 5944.230        | 59.103                 | 53.933               | -14.897         | 74.000         | 5.170  | PK   |

Note: Measure Level (dBμV/m) = Reading Level (dBμV) + Factor (dB)

Factor (dB) = Cable Loss (dB) + Antenna Factor (dB/m) - Pre\_Amplifier Gain (dB)

|  |                          |
|--|--------------------------|
| Site: AC2  | Time: 2016/08/27 - 19:49 |
| Limit: FCC_Part15.209_RE(3m)                                     | Engineer: Bruce Wang     |
| Probe: BBHA9120D_1-18GHz   | Polarity: Vertical       |
| EUT: WIRELESS-ABGN 2X2 NETWORK MINIPCIE ADAPTER                  | Power: AC 120V/60Hz      |
| Test Mode: Transmit by 802.11n-HT40 at Channel 5190MHz Ant 0 + 1 |                          |

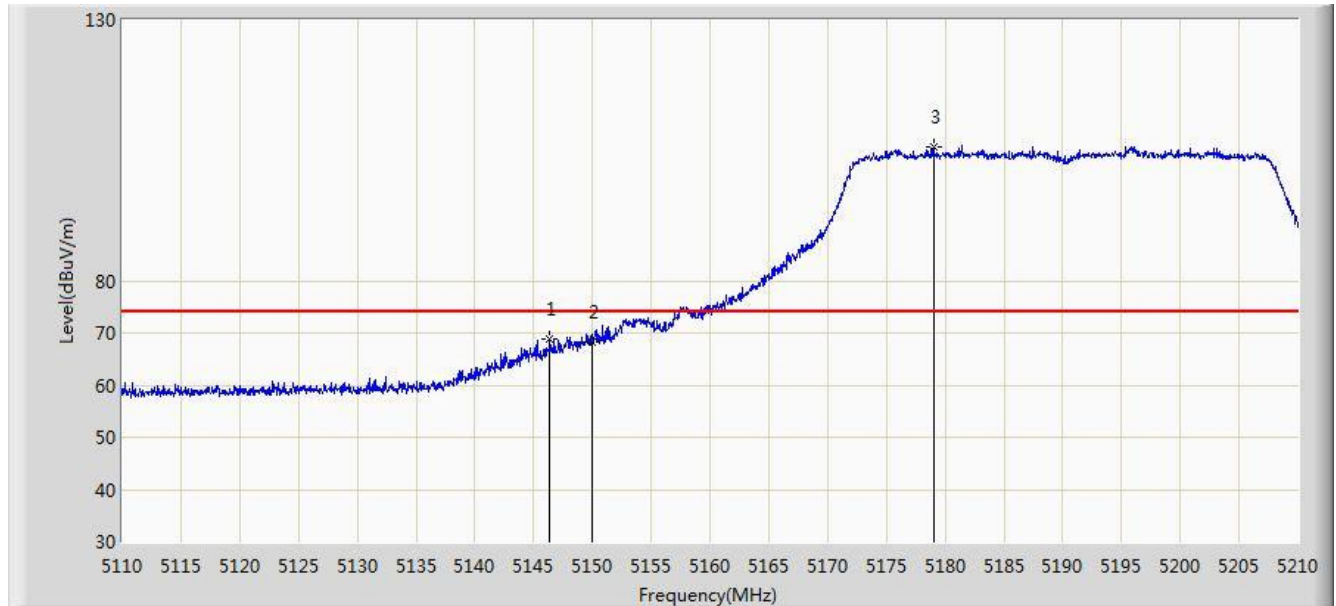

| No | Flag | Mark | Frequency (MHz) | Measure Level (dBuV/m) | Reading Level (dBuV) | Over Limit (dB) | Limit (dBuV/m) | Factor | Type |
|----|------|------|-----------------|------------------------|----------------------|-----------------|----------------|--------|------|
| 1  |      |      | 5146.400        | 68.912                 | 65.834               | -5.088          | 74.000         | 3.078  | PK   |
| 2  |      |      | 5150.000        | 68.266                 | 65.196               | -5.734          | 74.000         | 3.069  | PK   |
| 3  |      | *    | 5179.050        | 105.512                | 102.473              | N/A             | N/A            | 3.039  | PK   |

Note: Measure Level (dB $\mu$ V/m) = Reading Level (dB $\mu$ V) + Factor (dB)

Factor (dB) = Cable Loss (dB) + Antenna Factor (dB/m) - Pre\_Amplifier Gain (dB)



|  |                          |
|--|--------------------------|
| Site: AC2  | Time: 2016/08/27 - 19:51 |
| Limit: FCC_Part15.209_RE(3m)                                     | Engineer: Bruce Wang     |
| Probe: BBHA9120D_1-18GHz   | Polarity: Vertical       |
| EUT: WIRELESS-ABGN 2X2 NETWORK MINIPCIE ADAPTER                  | Power: AC 120V/60Hz      |
| Test Mode: Transmit by 802.11n-HT40 at Channel 5190MHz Ant 0 + 1 |                          |

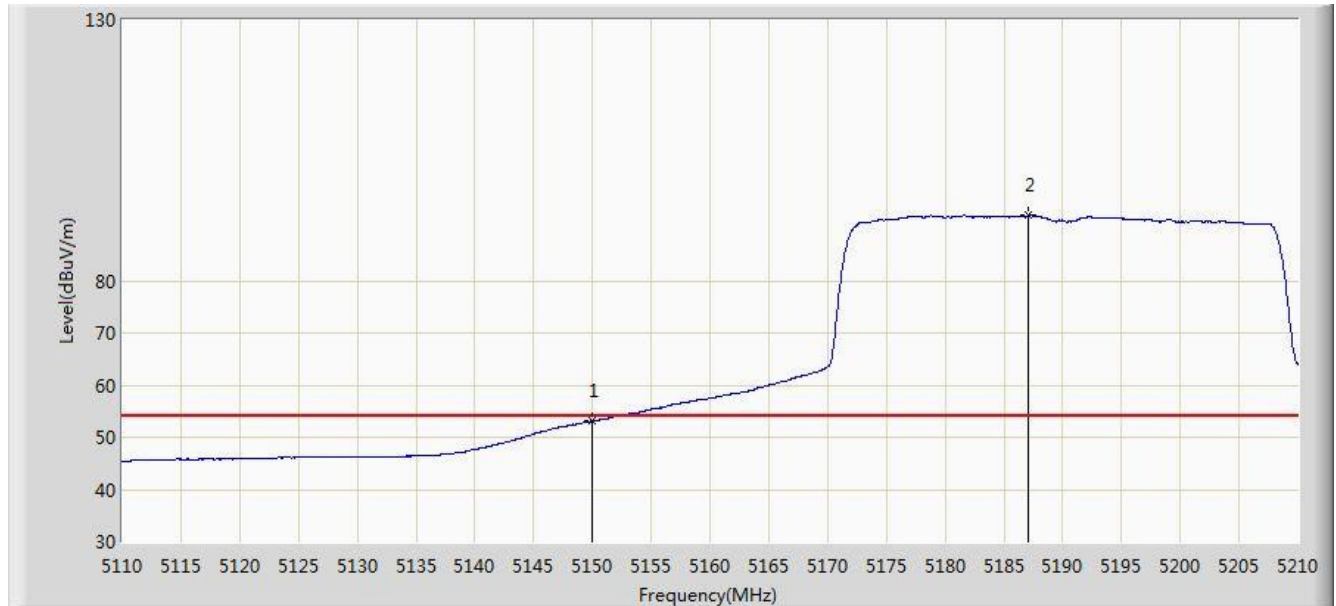

| No | Flag | Mark | Frequency (MHz) | Measure Level (dBuV/m) | Reading Level (dBuV) | Over Limit (dB) | Limit (dBuV/m) | Factor | Type |
|----|------|------|-----------------|------------------------|----------------------|-----------------|----------------|--------|------|
| 1  |      |      | 5150.000        | 53.127                 | 50.057               | -0.873          | 54.000         | 3.069  | AV   |
| 2  |      | *    | 5187.100        | 92.486                 | 89.499               | N/A             | N/A            | 2.988  | AV   |

Note: Measure Level (dBμV/m) = Reading Level (dBμV) + Factor (dB)

Factor (dB) = Cable Loss (dB) + Antenna Factor (dB/m) - Pre\_Amplifier Gain (dB)

|  |                          |
|--|--------------------------|
| Site: AC2  | Time: 2016/08/27 - 19:55 |
| Limit: FCC_Part15.209_RE(3m)                                     | Engineer: Bruce Wang     |
| Probe: BBHA9120D_1-18GHz   | Polarity: Horizontal     |
| EUT: WIRELESS-ABGN 2X2 NETWORK MINIPCIE ADAPTER                  | Power: AC 120V/60Hz      |
| Test Mode: Transmit by 802.11n-HT40 at Channel 5190MHz Ant 0 + 1 |                          |

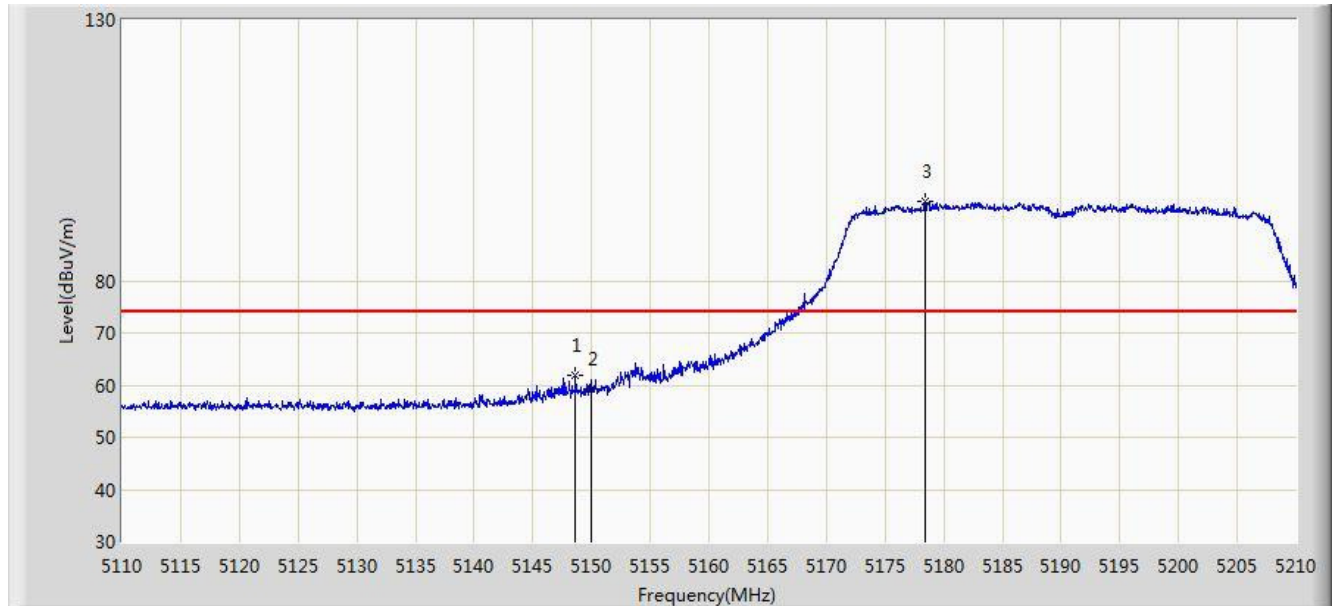

| No | Flag | Mark | Frequency (MHz) | Measure Level (dBuV/m) | Reading Level (dBuV) | Over Limit (dB) | Limit (dBuV/m) | Factor | Type |
|----|------|------|-----------------|------------------------|----------------------|-----------------|----------------|--------|------|
| 1  |      |      | 5148.650        | 61.753                 | 58.680               | -12.247         | 74.000         | 3.073  | PK   |
| 2  |      |      | 5150.000        | 59.387                 | 56.317               | -14.613         | 74.000         | 3.069  | PK   |
| 3  |      | *    | 5178.400        | 95.187                 | 92.150               | N/A             | N/A            | 3.037  | PK   |

Note: Measure Level (dBuV/m) = Reading Level (dBuV) + Factor (dB)

Factor (dB) = Cable Loss (dB) + Antenna Factor (dB/m) - Pre\_Amplifier Gain (dB)

|  |                          |
|--|--------------------------|
| Site: AC2  | Time: 2016/08/27 - 19:58 |
| Limit: FCC_Part15.209_RE(3m)                                     | Engineer: Bruce Wang     |
| Probe: BBHA9120D_1-18GHz   | Polarity: Horizontal     |
| EUT: WIRELESS-ABGN 2X2 NETWORK MINIPCIE ADAPTER                  | Power: AC 120V/60Hz      |
| Test Mode: Transmit by 802.11n-HT40 at Channel 5190MHz Ant 0 + 1 |                          |

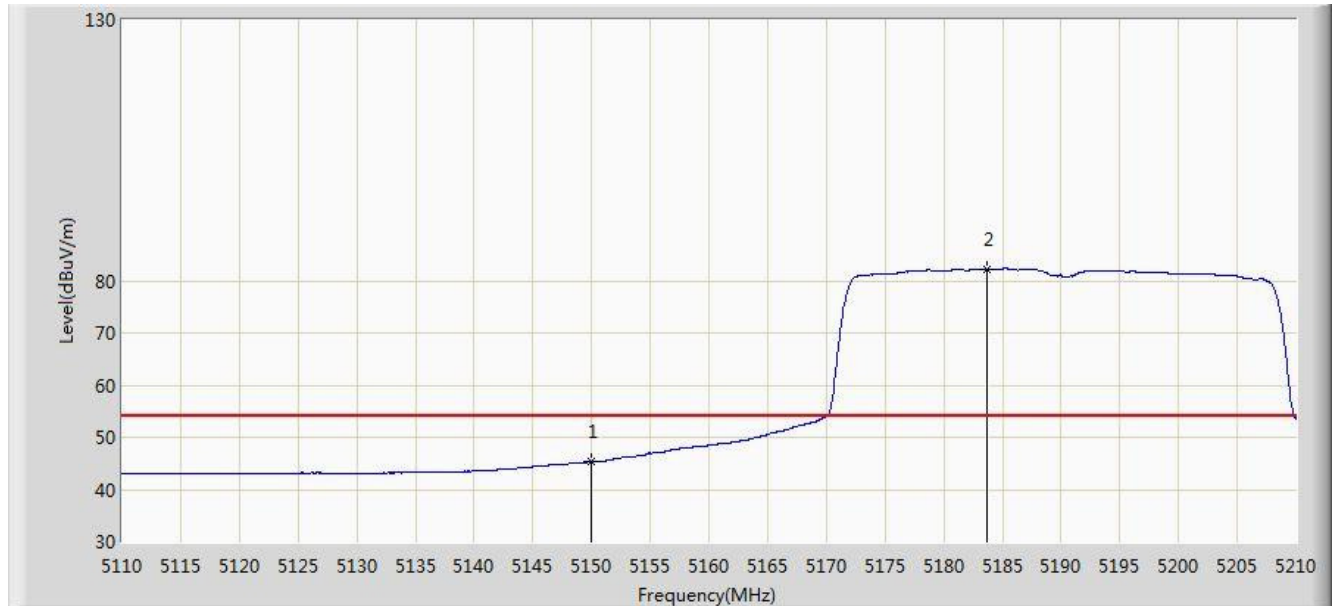

| No | Flag | Mark | Frequency (MHz) | Measure Level (dBuV/m) | Reading Level (dBuV) | Over Limit (dB) | Limit (dBuV/m) | Factor | Type |
|----|------|------|-----------------|------------------------|----------------------|-----------------|----------------|--------|------|
| 1  |      |      | 5150.000        | 45.301                 | 42.231               | -8.699          | 54.000         | 3.069  | AV   |
| 2  |      | *    | 5183.650        | 82.123                 | 79.093               | N/A             | N/A            | 3.030  | AV   |

Note: Measure Level (dBμV/m) = Reading Level (dBμV) + Factor (dB)

Factor (dB) = Cable Loss (dB) + Antenna Factor (dB/m) - Pre\_Amplifier Gain (dB)

|  |                          |
|--|--------------------------|
| Site: AC2  | Time: 2016/08/27 - 20:27 |
| Limit: FCC_Part15.209_RE(3m)                                     | Engineer: Bruce Wang     |
| Probe: BBHA9120D_1-18GHz   | Polarity: Vertical       |
| EUT: WIRELESS-ABGN 2X2 NETWORK MINIPCIE ADAPTER                  | Power: AC 120V/60Hz      |
| Test Mode: Transmit by 802.11n-HT40 at Channel 5310MHz Ant 0 + 1 |                          |

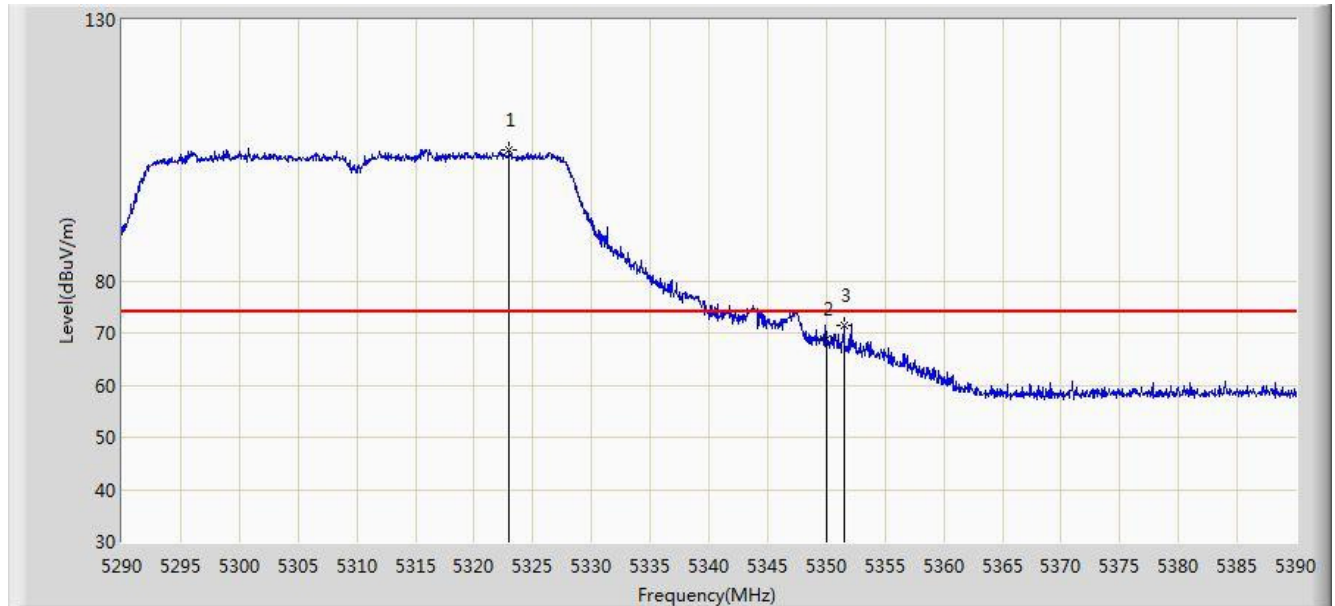

| No | Flag | Mark | Frequency (MHz) | Measure Level (dBuV/m) | Reading Level (dBuV) | Over Limit (dB) | Limit (dBuV/m) | Factor | Type |
|----|------|------|-----------------|------------------------|----------------------|-----------------|----------------|--------|------|
| 1  |      | *    | 5322.950        | 105.114                | 102.439              | N/A             | N/A            | 2.675  | PK   |
| 2  |      |      | 5350.000        | 68.772                 | 66.075               | -5.228          | 74.000         | 2.697  | PK   |
| 3  |      |      | 5351.500        | 71.466                 | 68.763               | -2.534          | 74.000         | 2.703  | PK   |

Note: Measure Level (dBuV/m) = Reading Level (dBuV) + Factor (dB)

Factor (dB) = Cable Loss (dB) + Antenna Factor (dB/m) - Pre\_Amplifier Gain (dB)

|  |                          |
|--|--------------------------|
| Site: AC2  | Time: 2016/08/27 - 20:28 |
| Limit: FCC_Part15.209_RE(3m)                                     | Engineer: Bruce Wang     |
| Probe: BBHA9120D_1-18GHz   | Polarity: Vertical       |
| EUT: WIRELESS-ABGN 2X2 NETWORK MINIPCIE ADAPTER                  | Power: AC 120V/60Hz      |
| Test Mode: Transmit by 802.11n-HT40 at Channel 5310MHz Ant 0 + 1 |                          |

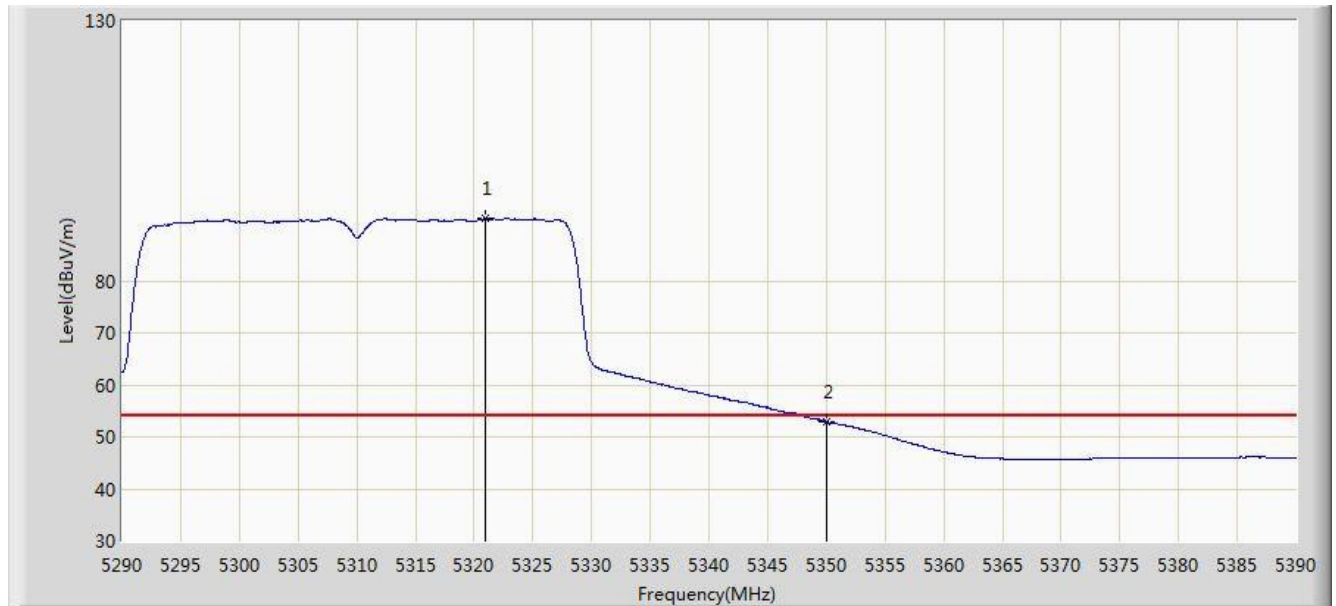

| No | Flag | Mark | Frequency (MHz) | Measure Level (dBuV/m) | Reading Level (dBuV) | Over Limit (dB) | Limit (dBuV/m) | Factor | Type |
|----|------|------|-----------------|------------------------|----------------------|-----------------|----------------|--------|------|
| 1  |      | *    | 5320.900        | 91.930                 | 89.264               | N/A             | N/A            | 2.665  | AV   |
| 2  |      |      | 5350.000        | 52.940                 | 50.243               | -1.060          | 54.000         | 2.697  | AV   |

Note: Measure Level (dBμV/m) = Reading Level (dBμV) + Factor (dB)

Factor (dB) = Cable Loss (dB) + Antenna Factor (dB/m) - Pre\_Amplifier Gain (dB)

|  |                          |
|--|--------------------------|
| Site: AC2  | Time: 2016/08/27 - 20:30 |
| Limit: FCC_Part15.209_RE(3m)                                     | Engineer: Bruce Wang     |
| Probe: BBHA9120D_1-18GHz   | Polarity: Horizontal     |
| EUT: WIRELESS-ABGN 2X2 NETWORK MINIPCIE ADAPTER                  | Power: AC 120V/60Hz      |
| Test Mode: Transmit by 802.11n-HT40 at Channel 5310MHz Ant 0 + 1 |                          |

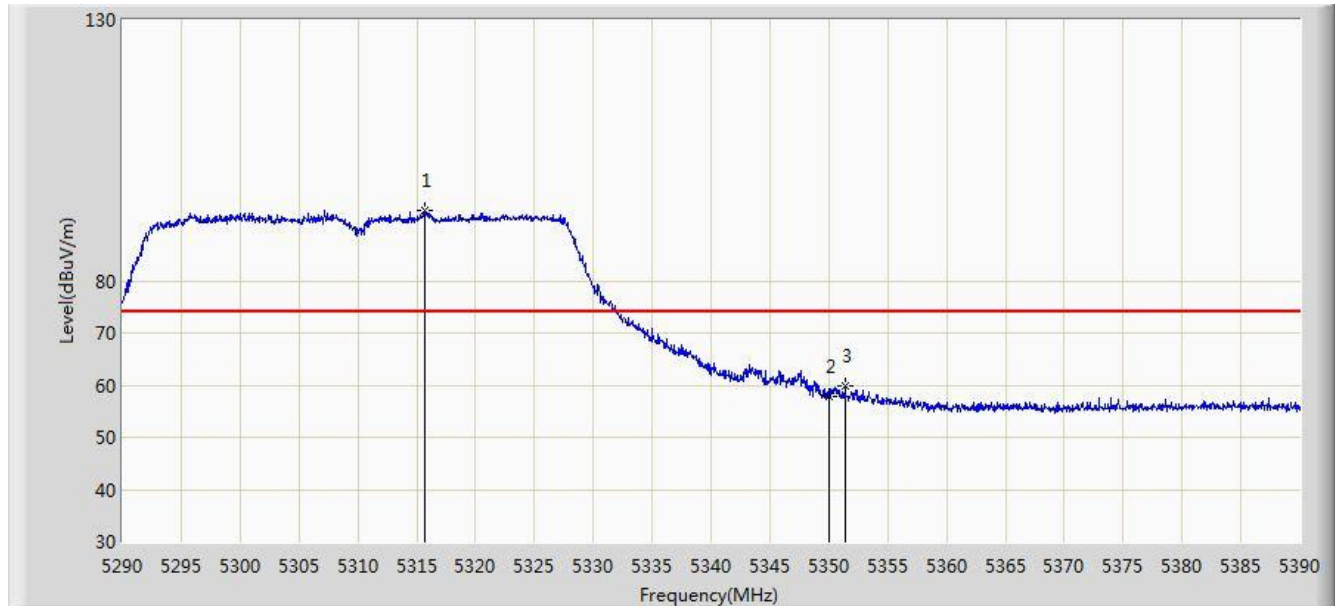

| No | Flag | Mark | Frequency (MHz) | Measure Level (dBuV/m) | Reading Level (dBuV) | Over Limit (dB) | Limit (dBuV/m) | Factor | Type |
|----|------|------|-----------------|------------------------|----------------------|-----------------|----------------|--------|------|
| 1  |      | *    | 5315.750        | 93.416                 | 90.784               | N/A             | N/A            | 2.632  | PK   |
| 2  |      |      | 5350.000        | 57.949                 | 55.252               | -16.051         | 74.000         | 2.697  | PK   |
| 3  |      |      | 5351.400        | 59.767                 | 57.064               | -14.233         | 74.000         | 2.703  | PK   |

Note: Measure Level (dBuV/m) = Reading Level (dBuV) + Factor (dB)

Factor (dB) = Cable Loss (dB) + Antenna Factor (dB/m) - Pre\_Amplifier Gain (dB)

|  |                          |
|--|--------------------------|
| Site: AC2  | Time: 2016/08/27 - 20:31 |
| Limit: FCC_Part15.209_RE(3m)                                     | Engineer: Bruce Wang     |
| Probe: BBHA9120D_1-18GHz   | Polarity: Horizontal     |
| EUT: WIRELESS-ABGN 2X2 NETWORK MINIPCIE ADAPTER                  | Power: AC 120V/60Hz      |
| Test Mode: Transmit by 802.11n-HT40 at Channel 5310MHz Ant 0 + 1 |                          |

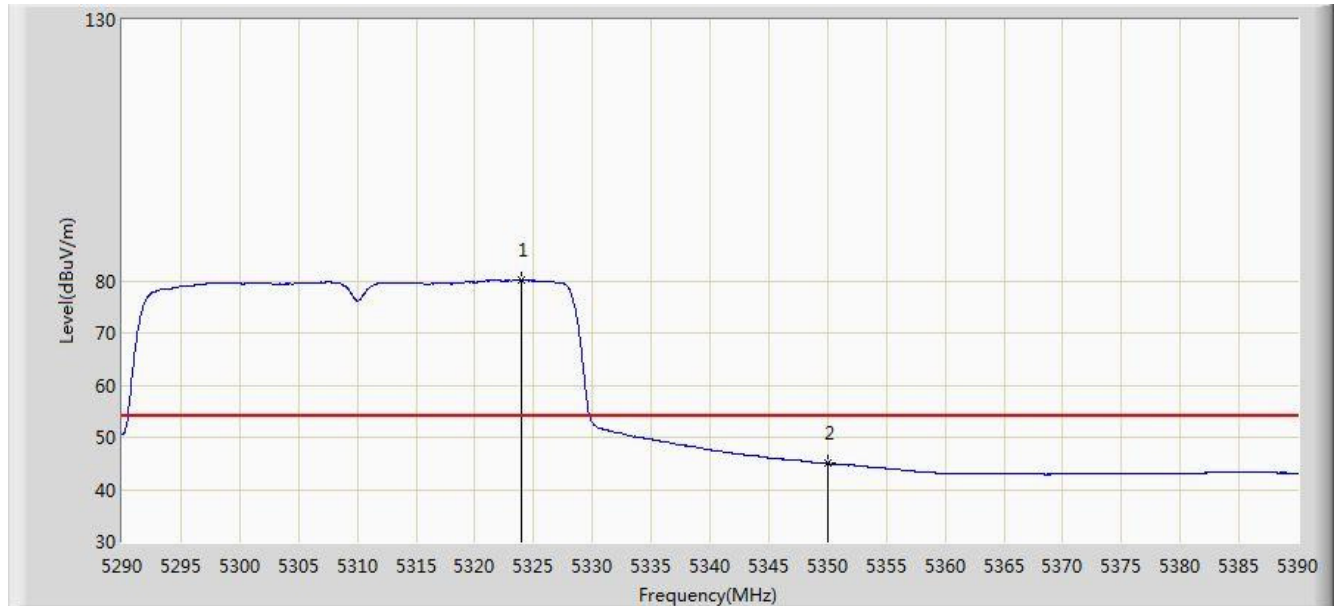

| No | Flag | Mark | Frequency (MHz) | Measure Level (dBuV/m) | Reading Level (dBuV) | Over Limit (dB) | Limit (dBuV/m) | Factor | Type |
|----|------|------|-----------------|------------------------|----------------------|-----------------|----------------|--------|------|
| 1  |      | *    | 5324.000        | 80.165                 | 77.485               | N/A             | N/A            | 2.680  | AV   |
| 2  |      |      | 5350.000        | 45.016                 | 42.319               | -8.984          | 54.000         | 2.697  | AV   |

Note: Measure Level (dBμV/m) = Reading Level (dBμV) + Factor (dB)

Factor (dB) = Cable Loss (dB) + Antenna Factor (dB/m) - Pre\_Amplifier Gain (dB)

|  |                          |
|--|--------------------------|
| Site: AC2  | Time: 2016/08/27 - 20:54 |
| Limit: FCC_Part15.209_RE(3m)                                     | Engineer: Bruce Wang     |
| Probe: BBHA9120D_1-18GHz   | Polarity: Vertical       |
| EUT: WIRELESS-ABGN 2X2 NETWORK MINIPCIE ADAPTER                  | Power: AC 120V/60Hz      |
| Test Mode: Transmit by 802.11n-HT40 at Channel 5510MHz Ant 0 + 1 |                          |

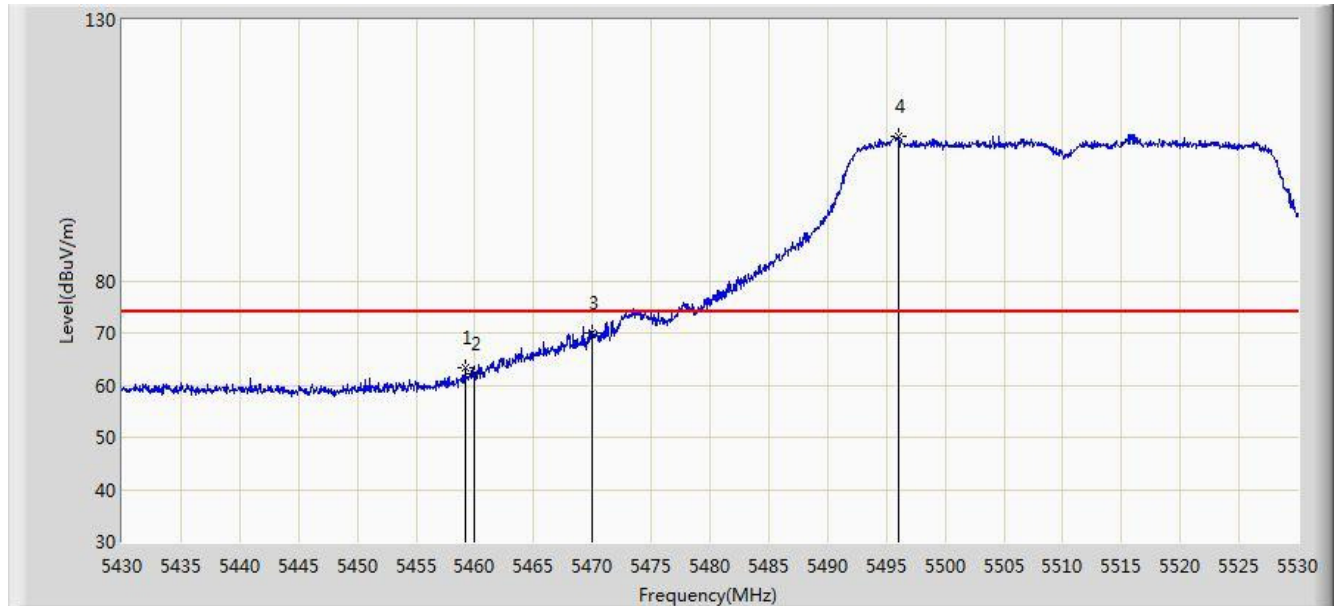

| No | Flag | Mark | Frequency (MHz) | Measure Level (dBuV/m) | Reading Level (dBuV) | Over Limit (dB) | Limit (dBuV/m) | Factor | Type |
|----|------|------|-----------------|------------------------|----------------------|-----------------|----------------|--------|------|
| 1  |      |      | 5459.150        | 63.194                 | 60.029               | -10.806         | 74.000         | 3.165  | PK   |
| 2  |      |      | 5460.000        | 62.048                 | 58.855               | -11.952         | 74.000         | 3.194  | PK   |
| 3  |      |      | 5470.000        | 70.008                 | 66.479               | -3.992          | 74.000         | 3.529  | PK   |
| 4  |      | *    | 5496.000        | 107.590                | 104.438              | N/A             | N/A            | 3.152  | PK   |

Note: Measure Level (dB $\mu$ V/m) = Reading Level (dB $\mu$ V) + Factor (dB)

Factor (dB) = Cable Loss (dB) + Antenna Factor (dB/m) - Pre\_Amplifier Gain (dB)



|  |                          |
|--|--------------------------|
| Site: AC2  | Time: 2016/08/27 - 20:57 |
| Limit: FCC_Part15.209_RE(3m)                                     | Engineer: Bruce Wang     |
| Probe: BBHA9120D_1-18GHz   | Polarity: Vertical       |
| EUT: WIRELESS-ABGN 2X2 NETWORK MINIPCIE ADAPTER                  | Power: AC 120V/60Hz      |
| Test Mode: Transmit by 802.11n-HT40 at Channel 5510MHz Ant 0 + 1 |                          |

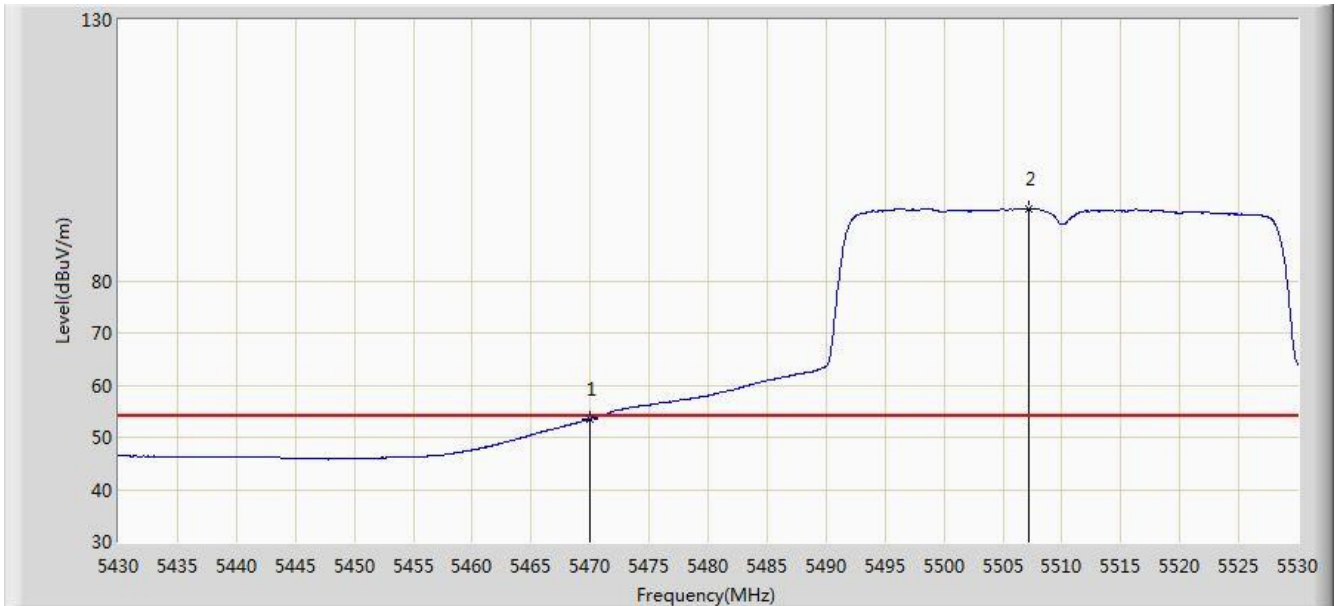

| No | Flag | Mark | Frequency (MHz) | Measure Level (dBuV/m) | Reading Level (dBuV) | Over Limit (dB) | Limit (dBuV/m) | Factor | Type |
|----|------|------|-----------------|------------------------|----------------------|-----------------|----------------|--------|------|
| 1  |      |      | 5470.000        | 53.523                 | 49.994               | -0.477          | 54.000         | 3.529  | AV   |
| 2  |      | *    | 5507.200        | 93.857                 | 90.738               | N/A             | N/A            | 3.120  | AV   |

Note: Measure Level (dBμV/m) = Reading Level (dBμV) + Factor (dB)

Factor (dB) = Cable Loss (dB) + Antenna Factor (dB/m) - Pre\_Amplifier Gain (dB)

|  |                          |
|--|--------------------------|
| Site: AC2  | Time: 2016/08/27 - 20:58 |
| Limit: FCC_Part15.209_RE(3m)                                     | Engineer: Bruce Wang     |
| Probe: BBHA9120D_1-18GHz   | Polarity: Horizontal     |
| EUT: WIRELESS-ABGN 2X2 NETWORK MINIPCIE ADAPTER                  | Power: AC 120V/60Hz      |
| Test Mode: Transmit by 802.11n-HT40 at Channel 5510MHz Ant 0 + 1 |                          |

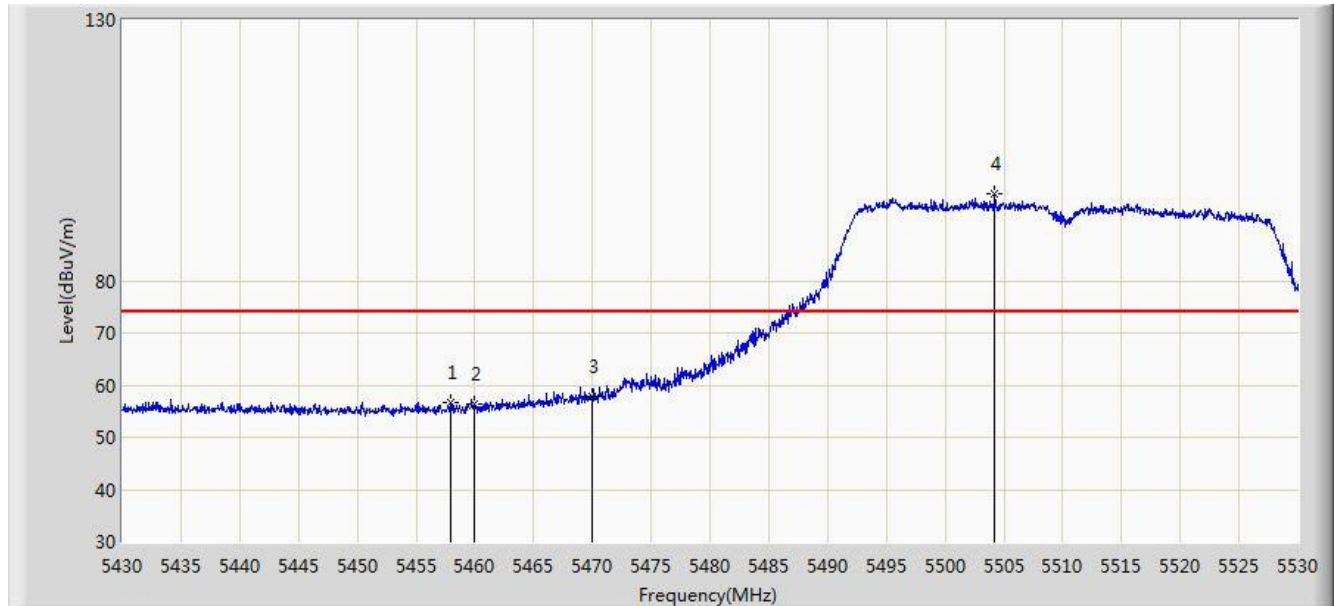

| No | Flag | Mark | Frequency (MHz) | Measure Level (dBuV/m) | Reading Level (dBuV) | Over Limit (dB) | Limit (dBuV/m) | Factor | Type |
|----|------|------|-----------------|------------------------|----------------------|-----------------|----------------|--------|------|
| 1  |      |      | 5457.900        | 56.797                 | 53.674               | -17.203         | 74.000         | 3.123  | PK   |
| 2  |      |      | 5460.000        | 56.360                 | 53.167               | -17.640         | 74.000         | 3.194  | PK   |
| 3  |      |      | 5470.000        | 57.899                 | 54.370               | -16.101         | 74.000         | 3.529  | PK   |
| 4  |      | *    | 5504.200        | 96.760                 | 93.687               | N/A             | N/A            | 3.074  | PK   |

Note: Measure Level (dBμV/m) = Reading Level (dBμV) + Factor (dB)

Factor (dB) = Cable Loss (dB) + Antenna Factor (dB/m) - Pre\_Amplifier Gain (dB)

|  |                          |
|--|--------------------------|
| Site: AC2  | Time: 2016/08/27 - 21:00 |
| Limit: FCC_Part15.209_RE(3m)                                     | Engineer: Bruce Wang     |
| Probe: BBHA9120D_1-18GHz   | Polarity: Horizontal     |
| EUT: WIRELESS-ABGN 2X2 NETWORK MINIPCIE ADAPTER                  | Power: AC 120V/60Hz      |
| Test Mode: Transmit by 802.11n-HT40 at Channel 5510MHz Ant 0 + 1 |                          |

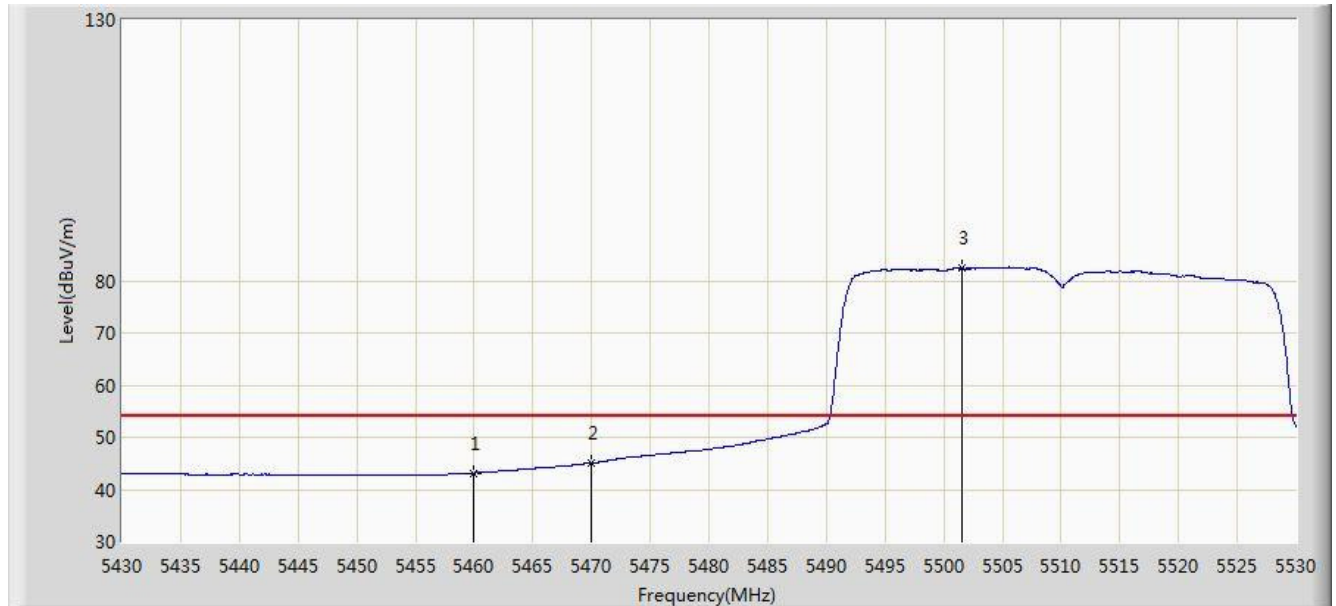

| No | Flag | Mark | Frequency (MHz) | Measure Level (dBuV/m) | Reading Level (dBuV) | Over Limit (dB) | Limit (dBuV/m) | Factor | Type |
|----|------|------|-----------------|------------------------|----------------------|-----------------|----------------|--------|------|
| 1  |      |      | 5460.000        | 43.128                 | 39.935               | -10.872         | 54.000         | 3.194  | AV   |
| 2  |      |      | 5470.000        | 45.074                 | 41.545               | -8.926          | 54.000         | 3.529  | AV   |
| 3  |      | *    | 5501.500        | 82.350                 | 79.251               | N/A             | N/A            | 3.099  | AV   |

Note: Measure Level (dBuV/m) = Reading Level (dBuV) + Factor (dB)

Factor (dB) = Cable Loss (dB) + Antenna Factor (dB/m) - Pre\_Amplifier Gain (dB)

|  |                          |
|--|--------------------------|
| Site: AC2  | Time: 2016/08/27 - 21:09 |
| Limit: FCC_Part15.209_RE(3m)                                     | Engineer: Bruce Wang     |
| Probe: BBHA9120D_1-18GHz   | Polarity: Vertical       |
| EUT: WIRELESS-ABGN 2X2 NETWORK MINIPCIE ADAPTER                  | Power: AC 120V/60Hz      |
| Test Mode: Transmit by 802.11n-HT40 at Channel 5670MHz Ant 0 + 1 |                          |

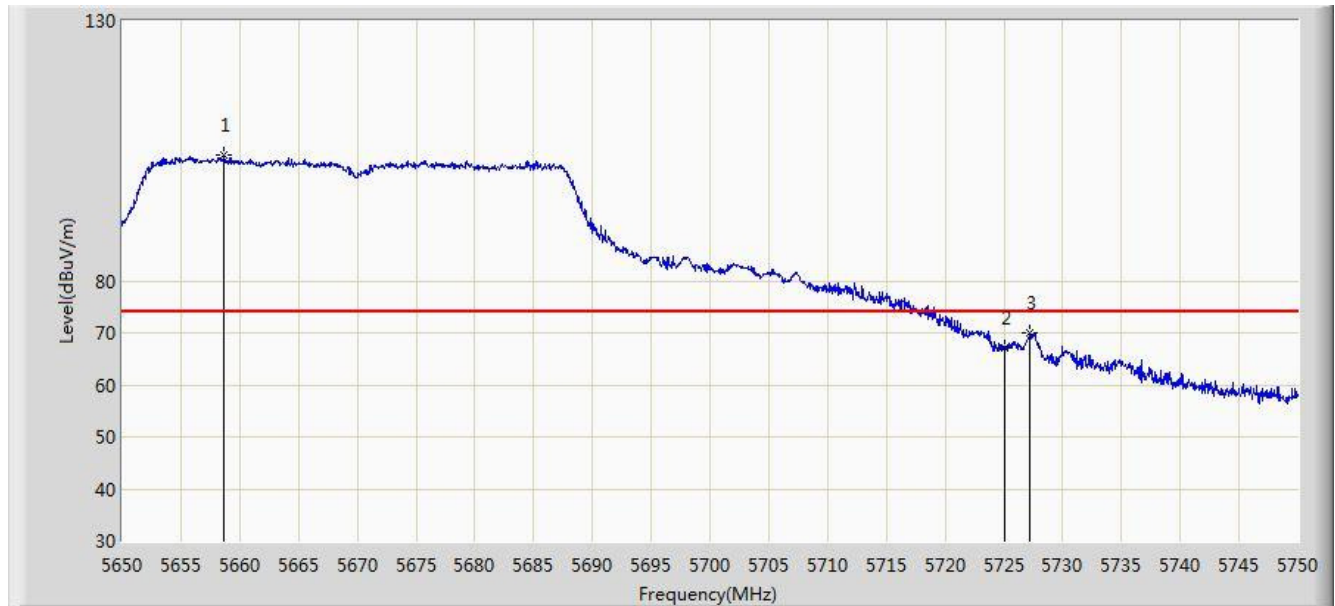

| No | Flag | Mark | Frequency (MHz) | Measure Level (dBuV/m) | Reading Level (dBuV) | Over Limit (dB) | Limit (dBuV/m) | Factor | Type |
|----|------|------|-----------------|------------------------|----------------------|-----------------|----------------|--------|------|
| 1  |      | *    | 5658.700        | 104.081                | 100.469              | N/A             | N/A            | 3.611  | PK   |
| 2  |      |      | 5725.000        | 67.223                 | 63.117               | -10.977         | 78.200         | 4.105  | PK   |
| 3  |      |      | 5727.360        | 70.082                 | 65.920               | -3.918          | 74.000         | 4.162  | PK   |

Note: Measure Level (dBuV/m) = Reading Level (dBuV) + Factor (dB)

Factor (dB) = Cable Loss (dB) + Antenna Factor (dB/m) - Pre\_Amplifier Gain (dB)

|  |                          |
|--|--------------------------|
| Site: AC2  | Time: 2016/08/27 - 21:11 |
| Limit: FCC_Part15.209_RE(3m)                                     | Engineer: Bruce Wang     |
| Probe: BBHA9120D_1-18GHz   | Polarity: Vertical       |
| EUT: WIRELESS-ABGN 2X2 NETWORK MINIPCIE ADAPTER                  | Power: AC 120V/60Hz      |
| Test Mode: Transmit by 802.11n-HT40 at Channel 5670MHz Ant 0 + 1 |                          |

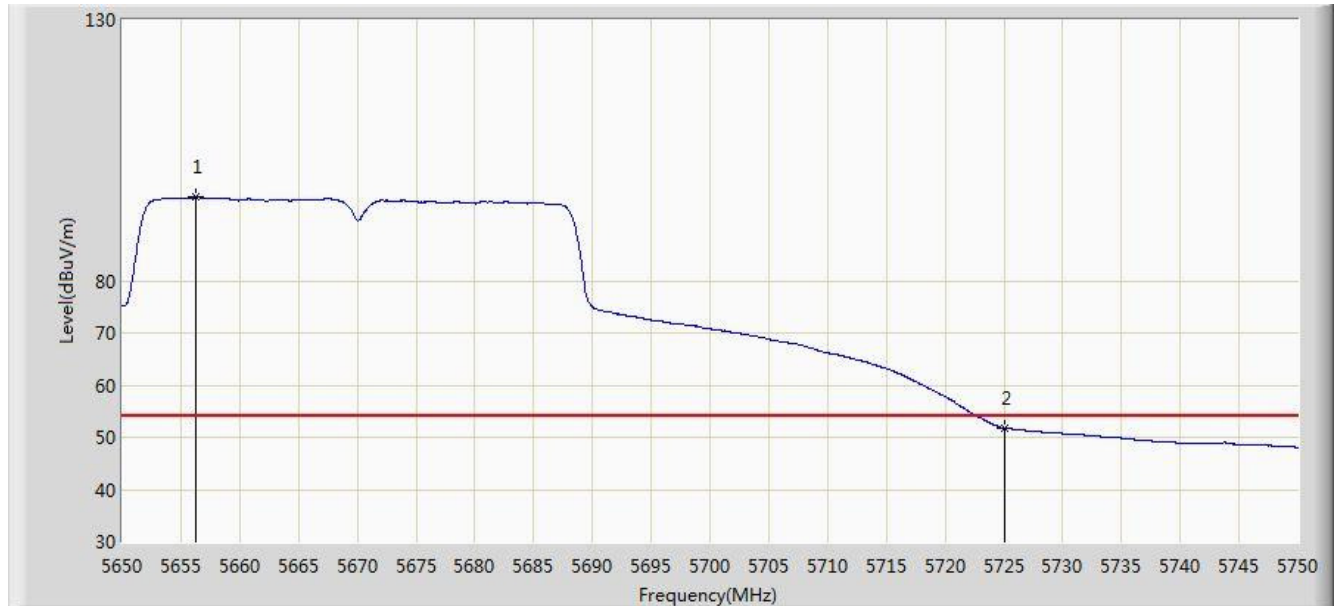

| No | Flag | Mark | Frequency (MHz) | Measure Level (dBuV/m) | Reading Level (dBuV) | Over Limit (dB) | Limit (dBuV/m) | Factor | Type |
|----|------|------|-----------------|------------------------|----------------------|-----------------|----------------|--------|------|
| 1  |      | *    | 5656.300        | 96.027                 | 92.364               | N/A             | N/A            | 3.662  | AV   |
| 2  |      |      | 5725.000        | 51.808                 | 47.702               | -2.192          | 54.000         | 4.105  | AV   |

Note: Measure Level (dB $\mu$ V/m) = Reading Level (dB $\mu$ V) + Factor (dB)

Factor (dB) = Cable Loss (dB) + Antenna Factor (dB/m) - Pre\_Amplifier Gain (dB)

|  |                          |
|--|--------------------------|
| Site: AC2  | Time: 2016/08/27 - 21:13 |
| Limit: FCC_Part15.209_RE(3m)                                     | Engineer: Bruce Wang     |
| Probe: BBHA9120D_1-18GHz   | Polarity: Horizontal     |
| EUT: WIRELESS-ABGN 2X2 NETWORK MINIPCIE ADAPTER                  | Power: AC 120V/60Hz      |
| Test Mode: Transmit by 802.11n-HT40 at Channel 5670MHz Ant 0 + 1 |                          |

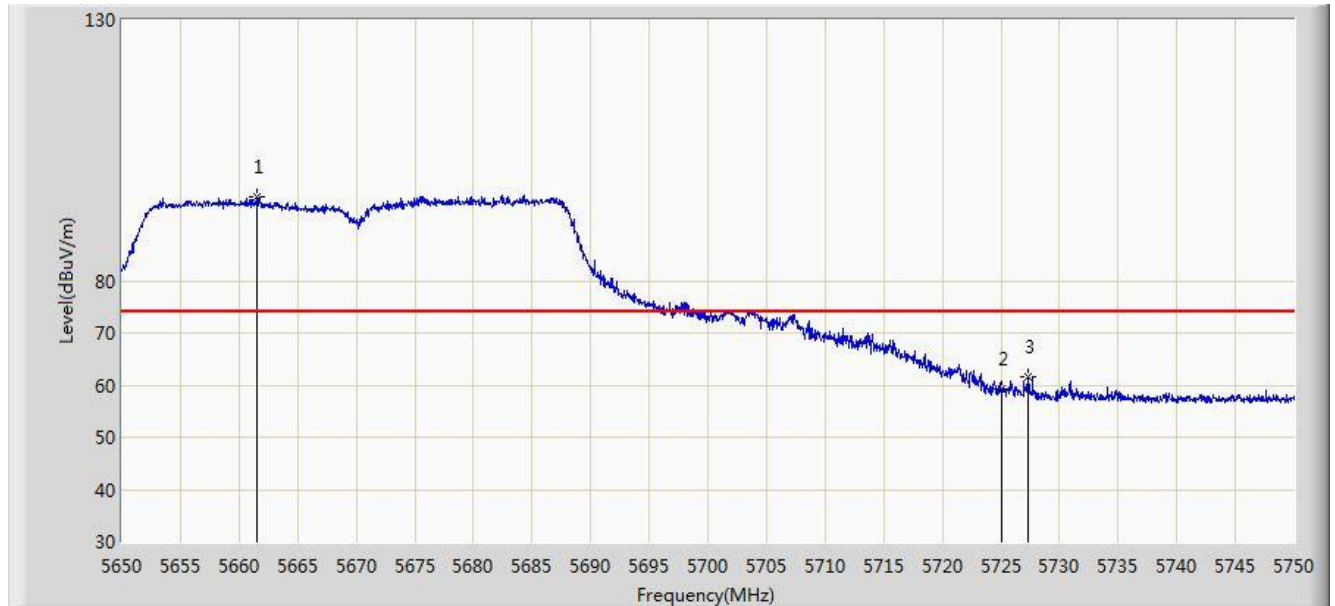

| No | Flag | Mark | Frequency (MHz) | Measure Level (dBuV/m) | Reading Level (dBuV) | Over Limit (dB) | Limit (dBuV/m) | Factor | Type |
|----|------|------|-----------------|------------------------|----------------------|-----------------|----------------|--------|------|
| 1  |      | *    | 5661.550        | 96.152                 | 92.594               | N/A             | N/A            | 3.559  | PK   |
| 2  |      |      | 5725.000        | 59.143                 | 55.037               | -14.857         | 74.000         | 4.105  | PK   |
| 3  |      |      | 5727.350        | 61.584                 | 57.420               | -12.416         | 74.000         | 4.164  | PK   |

Note: Measure Level (dBuV/m) = Reading Level (dBuV) + Factor (dB)

Factor (dB) = Cable Loss (dB) + Antenna Factor (dB/m) - Pre\_Amplifier Gain (dB)

|  |                          |
|--|--------------------------|
| Site: AC2  | Time: 2016/08/27 - 21:16 |
| Limit: FCC_Part15.209_RE(3m)                                     | Engineer: Bruce Wang     |
| Probe: BBHA9120D_1-18GHz   | Polarity: Horizontal     |
| EUT: WIRELESS-ABGN 2X2 NETWORK MINIPCIE ADAPTER                  | Power: AC 120V/60Hz      |
| Test Mode: Transmit by 802.11n-HT40 at Channel 5670MHz Ant 0 + 1 |                          |

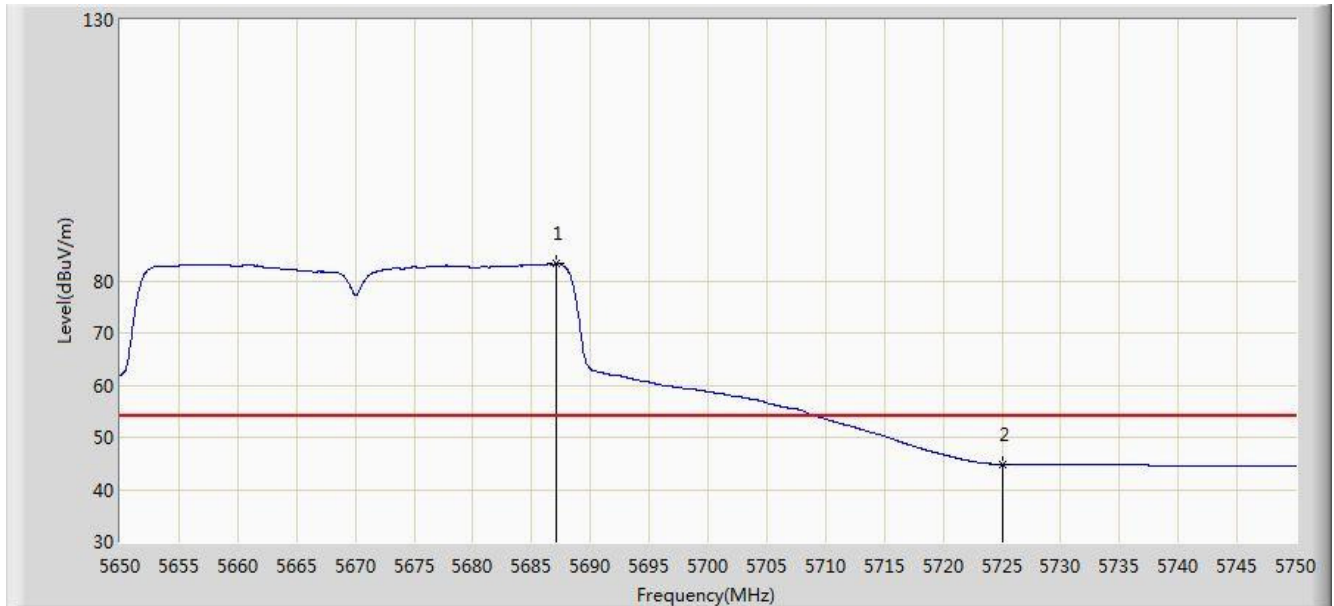

| No | Flag | Mark | Frequency (MHz) | Measure Level (dBuV/m) | Reading Level (dBuV) | Over Limit (dB) | Limit (dBuV/m) | Factor | Type |
|----|------|------|-----------------|------------------------|----------------------|-----------------|----------------|--------|------|
| 1  |      | *    | 5687.100        | 83.205                 | 79.189               | N/A             | N/A            | 4.016  | AV   |
| 2  |      |      | 5725.000        | 44.859                 | 40.753               | -9.141          | 54.000         | 4.105  | AV   |

Note: Measure Level (dBμV/m) = Reading Level (dBμV) + Factor (dB)

Factor (dB) = Cable Loss (dB) + Antenna Factor (dB/m) - Pre\_Amplifier Gain (dB)

|  |                          |
|--|--------------------------|
| Site: AC2  | Time: 2016/08/27 - 21:17 |
| Limit: FCC_Part15.407_RE(3m)                                     | Engineer: Bruce Wang     |
| Probe: BBHA9120D_1-18GHz   | Polarity: Vertical       |
| EUT: WIRELESS-ABGN 2X2 NETWORK MINIPCIE ADAPTER                  | Power: AC 120V/60Hz      |
| Test Mode: Transmit by 802.11n-HT40 at Channel 5755MHz Ant 0 + 1 |                          |

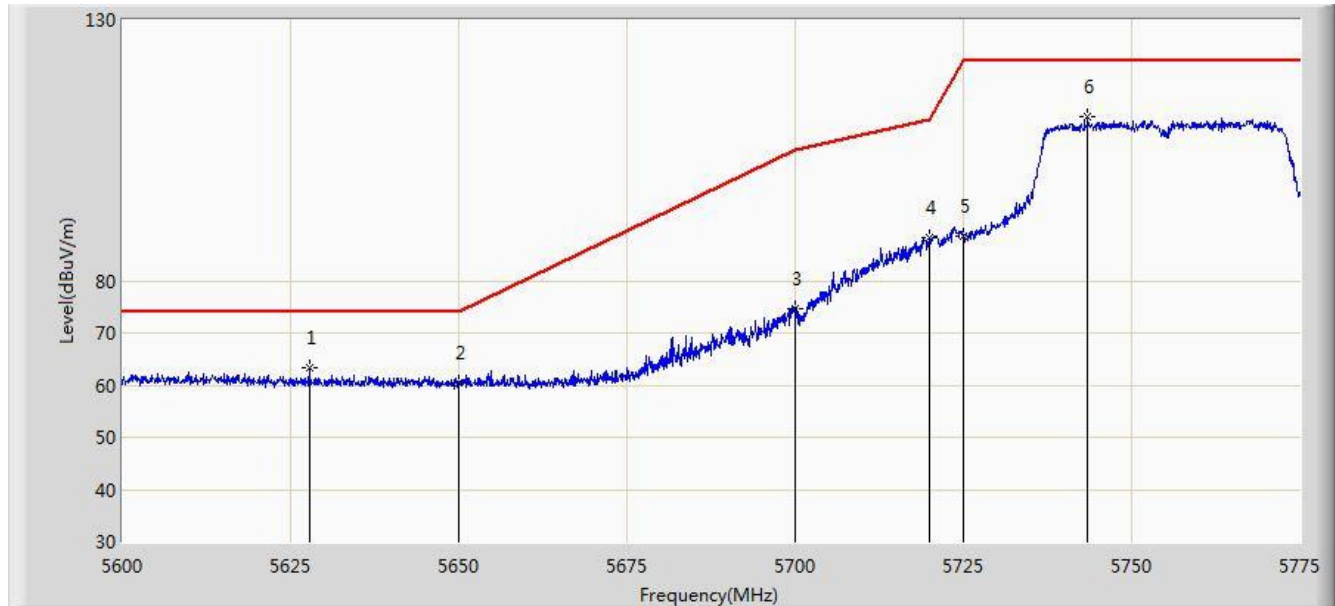

| No | Flag | Mark | Frequency (MHz) | Measure Level (dBuV/m) | Reading Level (dBuV) | Over Limit (dB) | Limit (dBuV/m) | Factor | Type |
|----|------|------|-----------------|------------------------|----------------------|-----------------|----------------|--------|------|
| 1  |      |      | 5627.825        | 63.189                 | 59.623               | -10.811         | 74.000         | 3.567  | PK   |
| 2  |      |      | 5650.000        | 60.498                 | 56.695               | -13.502         | 74.000         | 3.803  | PK   |
| 3  |      |      | 5700.000        | 74.737                 | 70.797               | -30.463         | 105.200        | 3.940  | PK   |
| 4  |      |      | 5720.000        | 88.193                 | 84.211               | -22.607         | 110.800        | 3.982  | PK   |
| 5  |      |      | 5725.000        | 88.483                 | 84.377               | -33.717         | 122.200        | 4.105  | PK   |
| 6  |      | *    | 5743.500        | 111.434                | 107.164              | N/A             | N/A            | 4.271  | PK   |

Note: Measure Level (dB $\mu$ V/m) = Reading Level (dB $\mu$ V) + Factor (dB)

Factor (dB) = Cable Loss (dB) + Antenna Factor (dB/m) - Pre\_Amplifier Gain (dB)



|  |                          |
|--|--------------------------|
| Site: AC2  | Time: 2016/08/27 - 21:20 |
| Limit: FCC_Part15.407_RE(3m)                                     | Engineer: Bruce Wang     |
| Probe: BBHA9120D_1-18GHz   | Polarity: Horizontal     |
| EUT: WIRELESS-ABGN 2X2 NETWORK MINIPCIE ADAPTER                  | Power: AC 120V/60Hz      |
| Test Mode: Transmit by 802.11n-HT40 at Channel 5755MHz Ant 0 + 1 |                          |

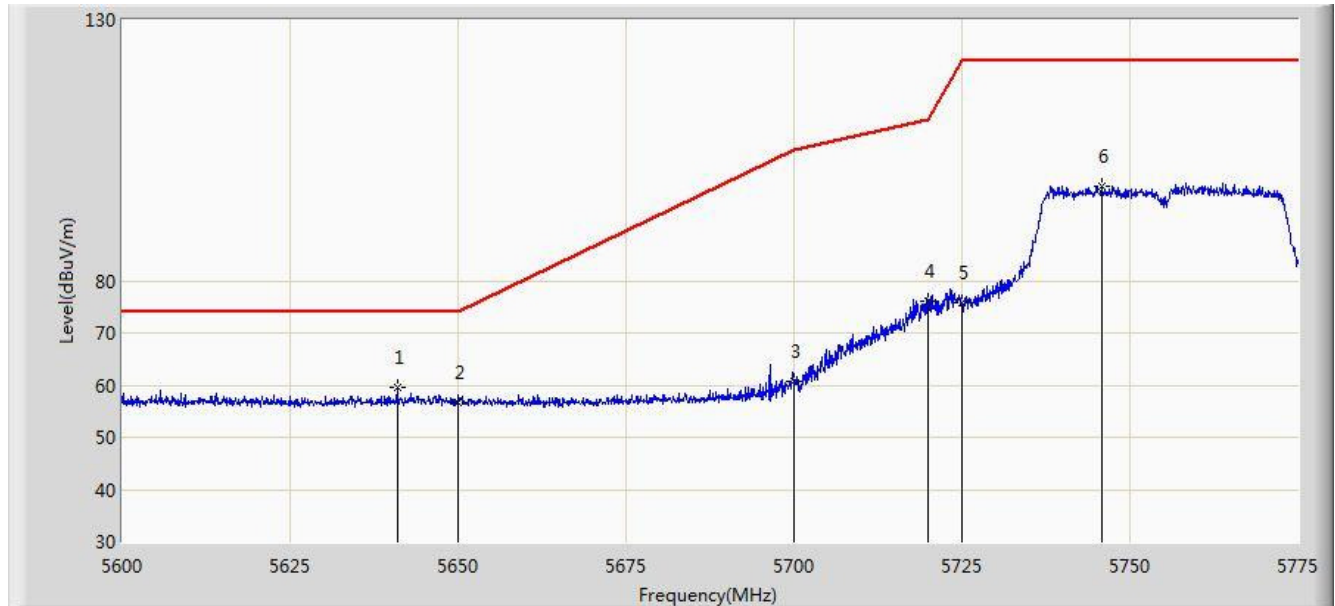

| No | Flag | Mark | Frequency (MHz) | Measure Level (dBuV/m) | Reading Level (dBuV) | Over Limit (dB) | Limit (dBuV/m) | Factor | Type |
|----|------|------|-----------------|------------------------|----------------------|-----------------|----------------|--------|------|
| 1  |      | *    | 5640.950        | 59.503                 | 55.656               | -14.497         | 74.000         | 3.847  | PK   |
| 2  |      |      | 5650.000        | 56.811                 | 53.008               | -17.189         | 74.000         | 3.803  | PK   |
| 3  |      |      | 5700.000        | 60.791                 | 56.851               | -44.409         | 105.200        | 3.940  | PK   |
| 4  |      |      | 5720.000        | 76.185                 | 72.203               | -34.615         | 110.800        | 3.982  | PK   |
| 5  |      |      | 5725.000        | 75.720                 | 71.614               | -46.480         | 122.200        | 4.105  | PK   |
| 6  |      |      | 5745.775        | 98.169                 | 93.900               | N/A             | N/A            | 4.269  | PK   |

Note: Measure Level (dB $\mu$ V/m) = Reading Level (dB $\mu$ V) + Factor (dB)

Factor (dB) = Cable Loss (dB) + Antenna Factor (dB/m) - Pre\_Amplifier Gain (dB)

|  |                          |
|--|--------------------------|
| Site: AC2  | Time: 2016/08/27 - 21:22 |
| Limit: FCC_Part15.407_RE(3m)                                     | Engineer: Bruce Wang     |
| Probe: BBHA9120D_1-18GHz   | Polarity: Vertical       |
| EUT: WIRELESS-ABGN 2X2 NETWORK MINIPCIE ADAPTER                  | Power: AC 120V/60Hz      |
| Test Mode: Transmit by 802.11n-HT40 at Channel 5795MHz Ant 0 + 1 |                          |

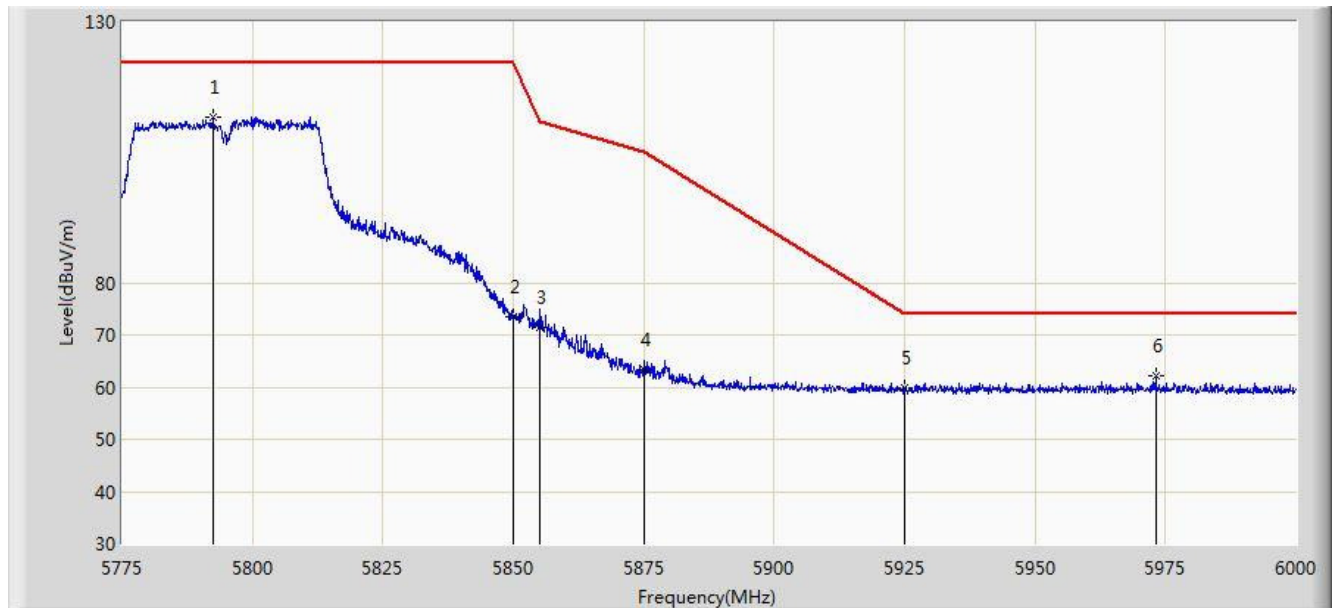

| No | Flag | Mark | Frequency (MHz) | Measure Level (dBuV/m) | Reading Level (dBuV) | Over Limit (dB) | Limit (dBuV/m) | Factor | Type |
|----|------|------|-----------------|------------------------|----------------------|-----------------|----------------|--------|------|
| 1  |      | *    | 5792.437        | 111.620                | 107.044              | N/A             | N/A            | 4.577  | PK   |
| 2  |      |      | 5850.000        | 73.365                 | 68.370               | -48.835         | 122.200        | 4.995  | PK   |
| 3  |      |      | 5855.000        | 71.462                 | 66.474               | -39.338         | 110.800        | 4.987  | PK   |
| 4  |      |      | 5875.000        | 63.307                 | 58.300               | -41.893         | 105.200        | 5.008  | PK   |
| 5  |      |      | 5925.000        | 59.727                 | 54.575               | -14.273         | 74.000         | 5.152  | PK   |
| 6  |      |      | 5973.112        | 62.140                 | 56.955               | -11.860         | 74.000         | 5.185  | PK   |

Note: Measure Level (dBμV/m) = Reading Level (dBμV) + Factor (dB)

Factor (dB) = Cable Loss (dB) + Antenna Factor (dB/m) - Pre\_Amplifier Gain (dB)

|  |                          |
|--|--------------------------|
| Site: AC2  | Time: 2016/08/27 - 21:26 |
| Limit: FCC_Part15.407_RE(3m)                                     | Engineer: Bruce Wang     |
| Probe: BBHA9120D_1-18GHz   | Polarity: Horizontal     |
| EUT: WIRELESS-ABGN 2X2 NETWORK MINIPCIE ADAPTER                  | Power: AC 120V/60Hz      |
| Test Mode: Transmit by 802.11n-HT40 at Channel 5795MHz Ant 0 + 1 |                          |

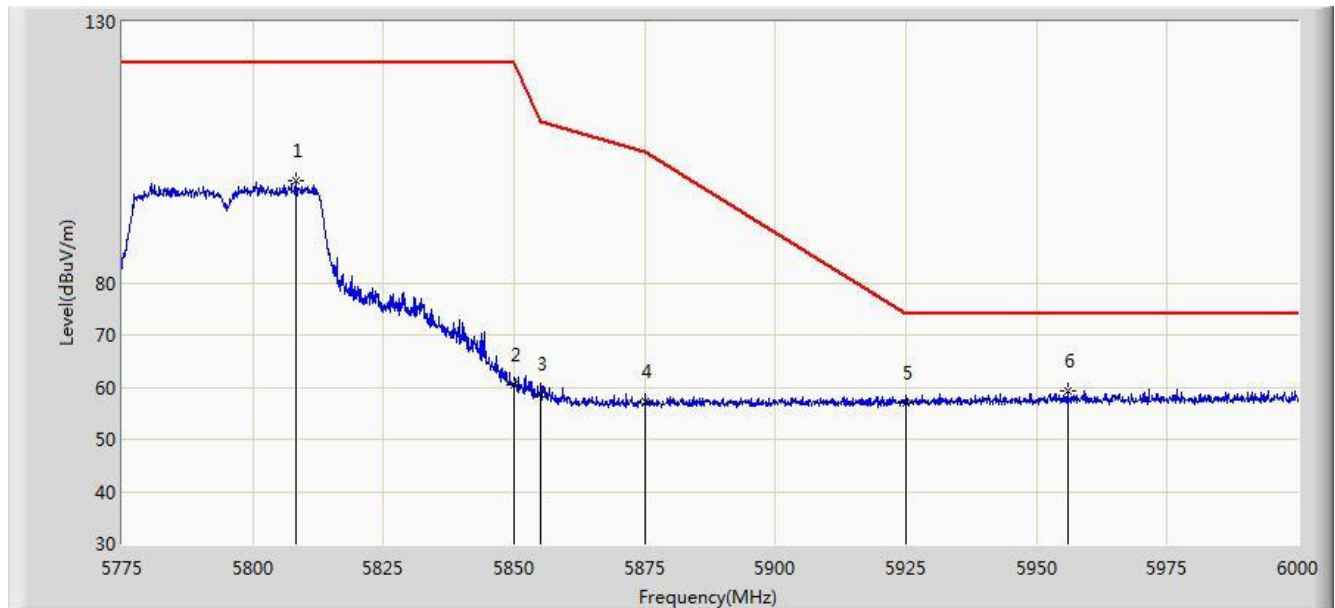

| No | Flag | Mark | Frequency (MHz) | Measure Level (dBuV/m) | Reading Level (dBuV) | Over Limit (dB) | Limit (dBuV/m) | Factor | Type |
|----|------|------|-----------------|------------------------|----------------------|-----------------|----------------|--------|------|
| 1  |      |      | 5808.300        | 99.518                 | 94.861               | N/A             | N/A            | 4.657  | PK   |
| 2  |      |      | 5850.000        | 60.512                 | 55.517               | -61.688         | 122.200        | 4.995  | PK   |
| 3  |      |      | 5855.000        | 58.807                 | 53.819               | -51.993         | 110.800        | 4.987  | PK   |
| 4  |      |      | 5875.000        | 57.243                 | 52.236               | -47.957         | 105.200        | 5.008  | PK   |
| 5  |      |      | 5925.000        | 57.030                 | 51.878               | -16.970         | 74.000         | 5.152  | PK   |
| 6  |      | *    | 5955.900        | 59.267                 | 53.958               | -14.733         | 74.000         | 5.309  | PK   |

Note: Measure Level (dBμV/m) = Reading Level (dBμV) + Factor (dB)

Factor (dB) = Cable Loss (dB) + Antenna Factor (dB/m) - Pre\_Amplifier Gain (dB)

## 7.10. AC Conducted Emissions Measurement

### 7.10.1. Test Limit

| FCC Part 15.207 Limits |                 |                 |
|------------------------|-----------------|-----------------|
| Frequency (MHz)        | QP (dB $\mu$ V) | AV (dB $\mu$ V) |
| 0.15 - 0.50            | 66 - 56         | 56 - 46         |
| 0.50 - 5.0             | 56              | 46              |
| 5.0 - 30               | 60              | 50              |

Note 1: The lower limit shall apply at the transition frequencies.

Note 2: The limit decreases linearly with the logarithm of the frequency in the range 0.15MHz to 0.5MHz.

### 7.10.2. Test Procedure

The EUT was setup according to ANSI C63.4, 2009 and tested according to KDB 789033 for compliance to FCC 47CFR 15.247 requirements. The EUT was placed on a platform of nominal size, 1 m by 1.5 m, raised 80 cm above the conducting ground plane. The vertical conducting plane was located 40 cm to the rear of the EUT. All other surfaces of EUT were at least 80 cm from any other grounded conducting surface. The EUT and simulators are connected to the main power through a line impedance stabilization network (LISN). The LISN provides a 50 ohm /50uH coupling impedance for the measuring equipment. The peripheral devices are also connected to the main power through a LISN. (Please refer to the block diagram of the test setup and photographs) Each current-carrying conductor of the EUT power cord, except the ground (safety) conductor, was individually connected through a LISN to the input power source.

The excess length of the power cord between the EUT and the LISN receptacle were folded back and forth at the center of the lead to form a bundle not exceeding 40 cm in length.

Conducted emissions were investigated over the frequency range from 0.15MHz to 30MHz using a receiver bandwidth of 9 kHz.

### 7.10.3. Test Setup

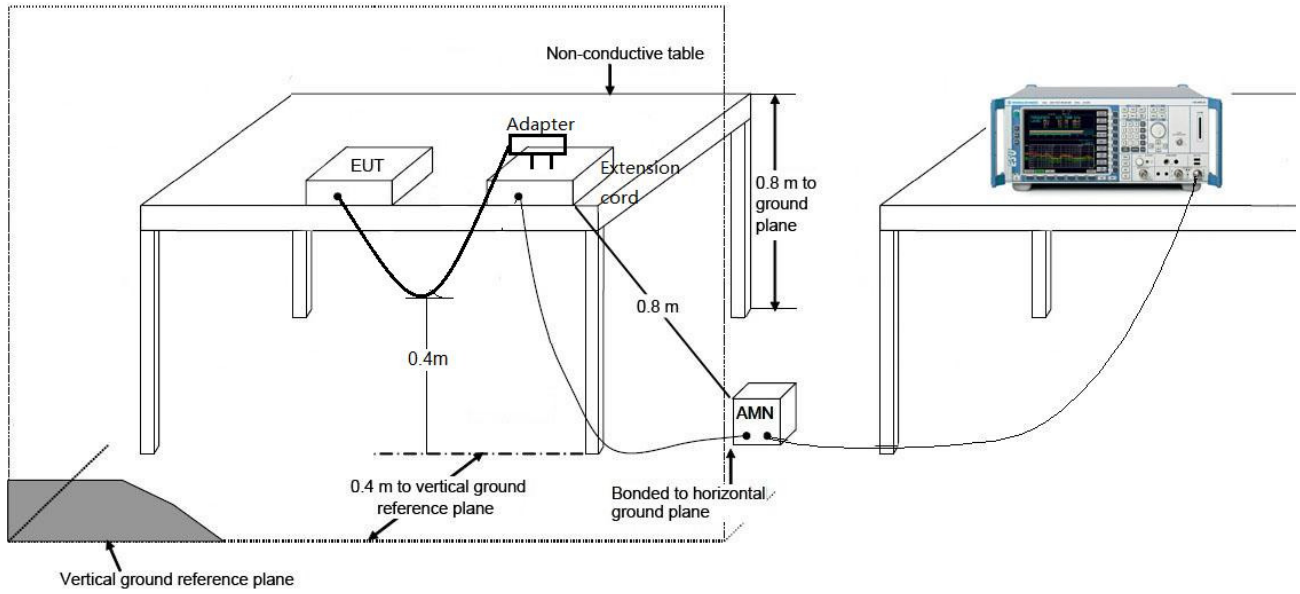

**7.10.4. Test Result**

|   |                          |
|---|--------------------------|
| Site: SR2   | Time: 2016/08/31 - 19:18 |
| Limit: FCC_Part15.207_CE_AC Power                                   | Engineer: Roy Cheng      |
| Probe: ENV216_101683_Filter On                                      | Polarity: Line           |
| EUT: WIRELESS-ABGN 2X2 NETWORK MINIPCIE ADAPTER                     | Power: AC 120V/60Hz      |
| <b>Worst Mode:</b> Transmit by 802.11a at channel 5180MHz Ant 0 + 1 |                          |

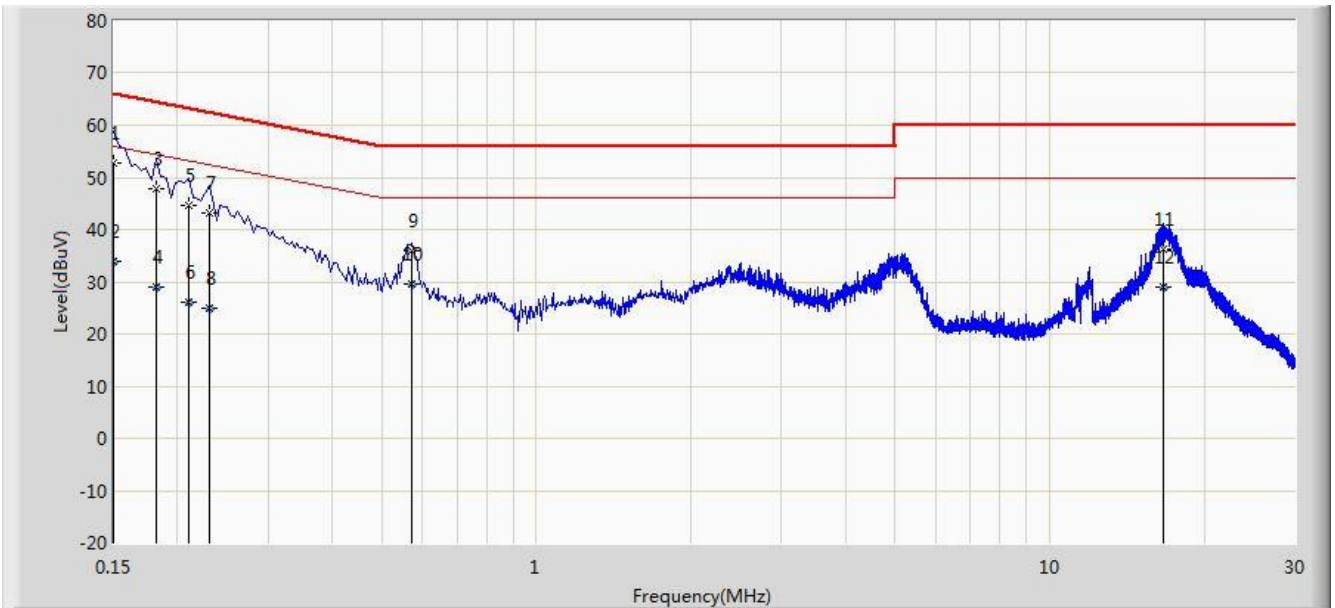

| No | Flag | Mark | Frequency (MHz) | Measure Level (dBuV) | Reading Level (dBuV) | Over Limit (dB) | Limit (dBuV) | Factor (dB) | Type |
|----|------|------|-----------------|----------------------|----------------------|-----------------|--------------|-------------|------|
| 1  |      | *    | 0.150           | 52.759               | 41.591               | -13.241         | 66.000       | 11.168      | QP   |
| 2  |      |      | 0.150           | 33.793               | 22.625               | -22.207         | 56.000       | 11.168      | AV   |
| 3  |      |      | 0.182           | 47.926               | 37.878               | -16.468         | 64.394       | 10.048      | QP   |
| 4  |      |      | 0.182           | 29.128               | 19.080               | -25.266         | 54.394       | 10.048      | AV   |
| 5  |      |      | 0.210           | 44.576               | 34.608               | -18.629         | 63.205       | 9.969       | QP   |
| 6  |      |      | 0.210           | 25.969               | 16.000               | -27.236         | 53.205       | 9.969       | AV   |
| 7  |      |      | 0.230           | 43.162               | 33.215               | -19.288         | 62.450       | 9.947       | QP   |
| 8  |      |      | 0.230           | 25.017               | 15.069               | -27.433         | 52.450       | 9.947       | AV   |
| 9  |      |      | 0.570           | 35.904               | 25.773               | -20.096         | 56.000       | 10.130      | QP   |
| 10 |      |      | 0.570           | 29.516               | 19.386               | -16.484         | 46.000       | 10.130      | AV   |
| 11 |      |      | 16.682          | 36.297               | 26.226               | -23.703         | 60.000       | 10.071      | QP   |
| 12 |      |      | 16.682          | 29.087               | 19.016               | -20.913         | 50.000       | 10.071      | AV   |

Note: Measure Level (dBμV) = Reading Level (dBμV) + Factor (dB)

Factor (dB) = Cable Loss (dB) + LISN Factor (dB)

|   |                          |
|---|--------------------------|
| Site: SR2   | Time: 2016/08/31 - 19:23 |
| Limit: FCC_Part15.207_CE_AC Power                                   | Engineer: Roy Cheng      |
| Probe: ENV216_101683_Filter On                                      | Polarity: Neutral        |
| EUT: WIRELESS-ABGN 2X2 NETWORK MINIPCIE ADAPTER                     | Power: AC 120V/60Hz      |
| <b>Worst Mode:</b> Transmit by 802.11a at channel 5180MHz Ant 0 + 1 |                          |

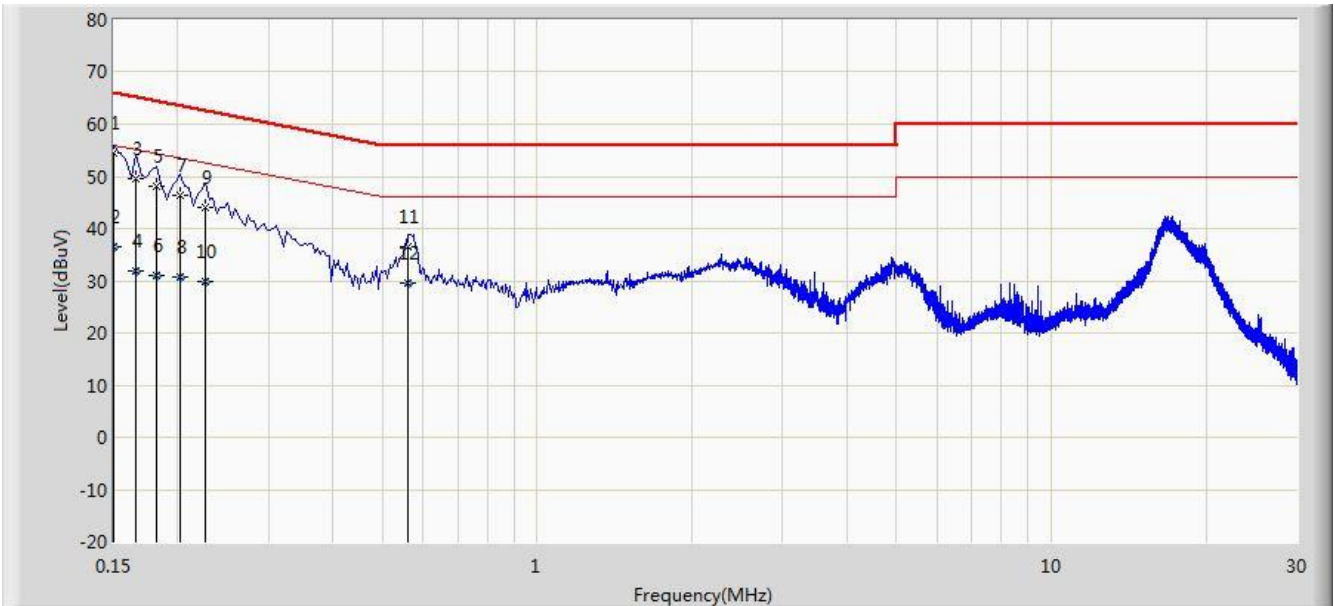

| No | Flag | Mark | Frequency (MHz) | Measure Level (dBuV) | Reading Level (dBuV) | Over Limit (dB) | Limit (dBuV) | Factor (dB) | Type |
|----|------|------|-----------------|----------------------|----------------------|-----------------|--------------|-------------|------|
| 1  |      | *    | 0.150           | 54.630               | 43.488               | -11.370         | 66.000       | 11.142      | QP   |
| 2  |      |      | 0.150           | 36.384               | 25.242               | -19.616         | 56.000       | 11.142      | AV   |
| 3  |      |      | 0.166           | 49.689               | 39.618               | -15.469         | 65.158       | 10.071      | QP   |
| 4  |      |      | 0.166           | 31.818               | 21.747               | -23.341         | 55.158       | 10.071      | AV   |
| 5  |      |      | 0.182           | 48.089               | 38.046               | -16.305         | 64.394       | 10.042      | QP   |
| 6  |      |      | 0.182           | 30.989               | 20.947               | -23.404         | 54.394       | 10.042      | AV   |
| 7  |      |      | 0.202           | 46.456               | 36.448               | -17.072         | 63.528       | 10.008      | QP   |
| 8  |      |      | 0.202           | 30.746               | 20.738               | -22.782         | 53.528       | 10.008      | AV   |
| 9  |      |      | 0.226           | 44.150               | 34.168               | -18.445         | 62.595       | 9.982       | QP   |
| 10 |      |      | 0.226           | 29.939               | 19.956               | -22.656         | 52.595       | 9.982       | AV   |
| 11 |      |      | 0.562           | 36.576               | 26.424               | -19.424         | 56.000       | 10.152      | QP   |
| 12 |      |      | 0.562           | 29.510               | 19.357               | -16.490         | 46.000       | 10.152      | AV   |

Note: Measure Level (dBμV) = Reading Level (dBμV) + Factor (dB)

Factor (dB) = Cable Loss (dB) + LISN Factor (dB)

## 8. CONCLUSION

The data collected relate only the item(s) tested and show that the EUT: **WIRELESS-ABGN 2X2 NETWORK MINIPCIE ADAPTER FCC ID: TK4WLE200NX** is in compliance with Part 15E of the FCC Rules.

---

The End