



DFS MEASUREMENT REPORT

FCC PART 15.407

FCC ID: TK4WLE1216V520

APPLICANT: Compex Systems Pte Ltd

Application Type: Certification

Product: 4x4 Wave-2 802.11ac/a/n Mini PCIe WiFi Module

Model No.: WLE1216V5-20, WLE1216V5-20-I

Brand Name: COMPEX

FCC Classification: Unlicensed National Information Infrastructure (UNII)

FCC Rule Part(s): Part 15.407(h)(2), KDB 905462 D02v02,
KDB 905462 D03v02, KDB 905462 D04v01

Type of Device: Master Device
 Client Device without radar detection
 Client Device with radar detection

Test Date: October 25 ~ November 20, 2017

Reviewed By : Jame Yuan
(Jame Yuan)

Approved By : Marlin Chen
(Marlin Chen)



The test results relate only to the samples tested.

This equipment has been shown to be capable of compliance with the applicable technical standards as indicated in the measurement report and was tested in accordance with the measurement procedures specified in KDB 905462 D02v02. Test results reported herein relate only to the item(s) tested.

The test report shall not be reproduced except in full without the written approval of MRT Technology (Suzhou) Co., Ltd.

Revision History

Report No.	Version	Description	Issue Date	Note
1710RSU02002	Rev. 01	Initial Report	11-20-2017	Valid

CONTENTS

Description	Page
Revision History	2
§2.1033 General Information	5
1. INTRODUCTION	6
1.1. Scope	6
1.2. MRT Test Location	6
2. PRODUCT INFORMATION	7
2.1. Equipment Description.....	7
2.2. DFS Band Carrier Frequencies Operation	7
2.3. Description of Available Antennas.....	8
2.4. Description of Support Units	8
2.5. Test Mode	8
3. DFS DETECTION THRESHOLDS AND RADAR TEST WAVEFORMS	9
3.1. Applicability	9
3.2. DFS Devices Requirements.....	10
3.3. DFS Detection Threshold Values	11
3.4. Parameters of DFS Test Signals	12
3.5. Conducted Test Setup	15
4. TEST EQUIPMENT CALIBRATION DATE	16
5. TEST RESULT	17
5.1. Summary	17
5.2. Radar Waveform Calibration.....	18
5.2.1. Calibration Setup	18
5.2.2. Calibration Procedure	18
5.2.3. Calibration Result	19
5.3. Channel Loading Test Result	23
5.4. In-Service Monitoring for Channel Move Time & Channel Closing Transmission Time Measurement.....	24
5.4.1. Test Limit	24
5.4.2. Test Procedure Used	24
5.4.3. Test Result.....	25
6. CONCLUSION	28

§2.1033 General Information

Applicant:	Compex Systems Pte Ltd
Applicant Address:	No:9 Harrison Road, Harrison Industrial Building, #05-01, Singapore 369651
Manufacturer:	Compex Systems Pte Ltd
Manufacturer Address:	No:9 Harrison Road, Harrison Industrial Building, #05-01, Singapore 369651
Test Site:	MRT Technology (Suzhou) Co., Ltd
Test Site Address:	D8 Building, Youxin Industrial Park, No.2 Tian'edang Rd., Wuzhong Economic Development Zone, Suzhou, China
MRT FCC Registration No.:	809388
Model No.:	WLE1216V5-20, WLE1216V5-20-I
FCC ID:	TK4WLE1216V520
Test Device Serial No.:	N/A <input type="checkbox"/> Production <input checked="" type="checkbox"/> Pre-Production <input type="checkbox"/> Engineering

Test Facility / Accreditations

Measurements were performed at MRT Laboratory located in Tian'edang Rd., Suzhou, China.

- MRT facility is a FCC registered (MRT Reg. No. 809388) test facility with the site description report on file and has met all the requirements specified in Section 2.948 of the FCC Rules.
- MRT facility is an IC registered (MRT Reg. No. 11384A-1) test laboratory with the site description on file at Industry Canada.
- MRT facility is a VCCI registered (R-4179, G-814, C-4664, T-2206) test laboratory with the site description on file at VCCI Council.
- MRT Lab is accredited to ISO 17025 by the American Association for Laboratory Accreditation (A2LA) under the American Association for Laboratory Accreditation Program (A2LA Cert. No. 3628.01) in EMC, Telecommunications and Radio testing for FCC, Industry Canada, EU and TELEC Rules.



1. INTRODUCTION

1.1. Scope

Measurement and determination of electromagnetic emissions (EMC) of radio frequency devices including intentional and/or unintentional radiators for compliance with the technical rules and regulations of the Federal Communications Commission and the Industry Canada Certification and Engineering Bureau.

1.2. MRT Test Location

The map below shows the location of the MRT LABORATORY, its proximity to the Taihu Lake. These measurement tests were conducted at the MRT Technology (Suzhou) Co., Ltd. Facility located at D8 Building, No.2 Tian'edang Rd., Wuzhong Economic Development Zone, Suzhou, China. The detailed description of the measurement facility was found to be in compliance with the requirements of § 2.948 according to ANSI C63.4-2009 on September 30, 2013.



2. PRODUCT INFORMATION

2.1. Equipment Description

Product Name	4x4 Wave-2 802.11ac/a/n Mini PCIe WiFi Module
Model No.	WLE1216V5-20, WLE1216V5-20-I
Radio Type	Intentional Transceiver
Operation Mode	Client device without radar detection
Frequency Range	For 802.11a/n-HT20/ac-VHT20: 5260~5320MHz, 5500~5720MHz For 802.11n-HT40/ac-VHT40: 5270~5310MHz, 5510~5710MHz For 802.11ac-VHT80: 5290MHz, 5530MHz, 5610MHz, 5690MHz
Type of Modulation	802.11a/n/ac: OFDM;
Uniform Spreading	For the 5250-5350MHz, 5470-5725MHz bands, the Master device provides, on aggregate, uniform loading of the spectrum across all devices by selecting an operating channel among the available channels using a random algorithm.

Note: The difference between models is for different market sale.

2.2. DFS Band Carrier Frequencies Operation

802.11a/n-HT20/-VHT20 Center Working Frequency of Each Channel					
Channel	Frequency	Channel	Frequency	Channel	Frequency
52	5260 MHz	56	5280 MHz	60	5300 MHz
64	5320 MHz	100	5500 MHz	104	5520 MHz
108	5540 MHz	112	5560 MHz	116	5580 MHz
120	5600 MHz	124	5620 MHz	128	5640 MHz
132	5660 MHz	136	5680 MHz	140	5700 MHz
144	5720 MHz	N/A	N/A	N/A	N/A

802.11n-HT40/ac-VHT40 Center Working Frequency of Each Channel					
Channel	Frequency	Channel	Frequency	Channel	Frequency
54	5270 MHz	62	5310 MHz	102	5510 MHz
110	5550 MHz	118	5590 MHz	126	5630 MHz
134	5670 MHz	142	5710MHz	N/A	N/A

802.11ac-VHT80 Center Working Frequency of Each Channel					
Channel	Frequency	Channel	Frequency	Channel	Frequency
58	5290 MHz	106	5530 MHz	122	5610 MHz
138	5690 MHz	N/A	N/A	N/A	N/A

2.3. Description of Available Antennas

No.	Antenna	Manufacturer	Frequency Band (MHz)	Max Peak Gain (dBi)
Wi-Fi External Antenna List (5GHz 4*4 MIMO)				
1#	Omni Directional	Exceltek Electronics Technology Co., Ltd.	2400 ~ 2500	3.0
			5150 ~ 5850	5.0
2#	Omni Directional	Laird Smart Technology Co., Ltd.	2400 ~ 2500	2.2
			5150 ~ 5850	3.5
3#	Omni Directional	Linx Technologies	2400 ~ 2500	2.5
			5150 ~ 5850	4.6
4#	Omni Directional	Kenbotong Technology Co., Ltd.	5150 ~ 5850	10.0

Note 1: The device didn't support beam-forming technology and Cyclic Delay Diversity (CDD) technology, and the transmit signals are uncorrected, so no add array gain to the band power and band PSD.

Note 2: We selected the max peak gain antenna 4# to perform all RF testing.

2.4. Description of Support Units

The EUT has been tested with associated equipment below:

Description	Manufacturer	Model No.
Access Point	Compex Systems Pte Ltd	WPJXXX

2.5. Test Mode

Test Mode	Mode 1: Communication with Wireless Router
-----------	--

3. DFS DETECTION THRESHOLDS AND RADAR TEST WAVEFORMS

3.1. Applicability

The following table from FCC KDB 905462 D02 UNII DFS Compliance Procedures New Rules v02 lists the applicable requirements for the DFS testing.

Requirement	Operational Mode		
	Master	Client Without Radar Detection	Client With Radar Detection
Non-Occupancy Period	Yes	Not required	Yes
DFS Detection Threshold	Yes	Not required	Yes
Channel Availability Check Time	Yes	Not required	Not required
U-NII Detection Bandwidth	Yes	Not required	Yes

Table 3-1: Applicability of DFS Requirements Prior to Use of a Channel

Requirement	Operational Mode	
	Master Device or Client With Radar Detection	Client Without Radar Detection
DFS Detection Threshold	Yes	Not required
Channel Closing Transmission Time	Yes	Yes
Channel Move Time	Yes	Yes
U-NII Detection Bandwidth	Yes	Not required

Additional requirements for devices with multiple bandwidth modes	Master Device or Client with Radar Detection	Client Without Radar Detection
U-NII Detection Bandwidth and Statistical Performance Check	All BW modes must be tested	Not required
Channel Move Time and Channel Closing Transmission Time	Test using widest BW mode available	Test using the widest BW mode available for the link
All other tests	Any single BW mode	Not required

Note: Frequencies selected for statistical performance check should include several frequencies within the radar detection bandwidth and frequencies near the edge of the radar detection bandwidth. For 802.11 devices it is suggested to select frequencies in each of the bonded 20 MHz channels and the channel center frequency.

Table 3-2: Applicability of DFS Requirements during normal operation

3.2. DFS Devices Requirements

Per FCC KDB 905462 D02 UNII DFS Compliance Procedures New Rules v02 the following are the requirements for Client Devices:

- a) A Client Device will not transmit before having received appropriate control signals from a Master Device.
- b) A Client Device will stop all its transmissions whenever instructed by a Master Device to which it is associated and will meet the Channel Move Time and Channel Closing transmission time requirements. The Client Device will not resume any transmissions until it has again received control signals from a Master Device.
- c) If a Client Device is performing In-Service Monitoring and detects a Radar Waveform above the DFS Detection Threshold, it will inform the Master Device. This is equivalent to the Master Device detecting the Radar Waveform.
- d) Irrespective of Client Device or Master Device detection the Channel Move Time and Channel Closing Transmission Time requirements remain the same.
- e) The client test frequency must be monitored to ensure no transmission of any type has occurred for 30 minutes. Note: If the client moves with the master, the device is considered compliant if nothing appears in the client non-occupancy period test. For devices that shut down (rather than moving channels), no beacons should appear.

Channel Move Time and Channel Closing Transmission Time requirements are listed in the following table.

Parameter	Value
Non-occupancy period	Minimum 30 minutes
Channel Availability Check Time	60 seconds
Channel Move Time	10 seconds See Note 1.
Channel Closing Transmission Time	200 milliseconds + an aggregate of 60 milliseconds over remaining 10 second period. See Notes 1 and 2.
U-NII Detection Bandwidth	Minimum 100% of the U-NII 99% transmission power bandwidth. See Note 3.
<p>Note 1: Channel Move Time and the Channel Closing Transmission Time should be performed with Radar Type 0. The measurement timing begins at the end of the Radar Type 0 burst.</p> <p>Note 2: The Channel Closing Transmission Time is comprised of 200 milliseconds starting at the beginning of the Channel Move Time plus any additional intermittent control signals required to facilitate a Channel move (an aggregate of 60 milliseconds) during the remainder of the 10 second period. The aggregate duration of control signals will not count quiet periods in between</p>	

transmissions.

Note 3: During the U-NII Detection Bandwidth detection test, radar type 0 should be used. For each frequency step the minimum percentage of detection is 90 percent. Measurements are performed with no data traffic.

Table 3-3: DFS Response Requirements

3.3. DFS Detection Threshold Values

The DFS detection thresholds are defined for Master devices and Client Devices with In-service monitoring. These detection thresholds are listed in the following table.

Maximum Transmit Power	Value (See Notes 1, 2, and 3)
EIRP \geq 200 milliwatt	-64 dBm
EIRP < 200 milliwatt and power spectral density < 10 dBm/MHz	-62 dBm
EIRP < 200 milliwatt that do not meet the power spectral density requirement	-64 dBm

Note 1: This is the level at the input of the receiver assuming a 0 dBi receive antenna.

Note 2: Throughout these test procedures an additional 1 dB has been added to the amplitude of the test transmission waveforms to account for variations in measurement equipment. This will ensure that the test signal is at or above the detection threshold level to trigger a DFS response.

Note3: EIRP is based on the highest antenna gain. For MIMO devices refer to KDB Publication 662911 D01.

Table 3-4: Detection Thresholds for Master Devices and Client Devices with Radar Detection

3.4. Parameters of DFS Test Signals

This section provides the parameters for required test waveforms, minimum percentage of successful detections, and the minimum number of trials that must be used for determining DFS conformance. Step intervals of 0.1 microsecond for Pulse Width, 1 microsecond for PRI, 1 MHz for chirp width and 1 for the number of pulses will be utilized for the random determination of specific test waveforms.

Short Pulse Radar Test Waveforms

Radar Type	Pulse Width (μsec)	PRI (μsec)	Number of Pulses	Minimum Percentage of Successful Detection	Minimum Number of Trials
0	1	1428	18	See Note 1	See Note 1
1	1	Test A: 15 unique PRI values randomly selected from the list of 23 PRI values in Table 3-6	$\text{Roundup} \left\{ \left(\frac{1}{360} \right), \left(\frac{19 \cdot 10^6}{\text{PRI}_{\mu\text{sec}}} \right) \right\}$	60%	30
		Test B: 15 unique PRI values randomly selected within the range of 518-3066 μsec, with a minimum increment of 1 μsec, excluding PRI values selected in Test A			
2	1-5	150-230	23-29	60%	30
3	6-10	200-500	16-18	60%	30
4	11-20	200-500	12-16	60%	30
Aggregate (Radar Types 1-4)				80%	120
Note 1: Short Pulse Radar Type 0 should be used for the detection bandwidth test, channel move time, and channel closing time tests.					

Table 3-5: Parameters for Short Pulse Radar Waveforms

A minimum of 30 unique waveforms are required for each of the Short Pulse Radar Types 2 through 4. If more than 30 waveforms are used for Short Pulse Radar Types 2 through 4, then each additional waveform must also be unique and not repeated from the previous waveforms.

Pulse Repetition Frequency Number	Pulse Repetition Frequency (Pulses Per Second)	Pulse Repetition Interval (Microseconds)
1	1930.5	518
2	1858.7	538
3	1792.1	558
4	1730.1	578
5	1672.2	598
6	1618.1	618
7	1567.4	638
8	1519.8	658
9	1474.9	678
10	1432.7	698
11	1392.8	718
12	1355	738
13	1319.3	758
14	1285.3	778
15	1253.1	798
16	1222.5	818
17	1193.3	838
18	1165.6	858
19	1139	878
20	1113.6	898
21	1089.3	918
22	1066.1	938
23	326.2	3066

Table 3-6: Pulse Repetition Intervals Values for Test A

Long Pulse Radar Test Waveform

Radar Type	Pulse Width (μsec)	Chirp Width (MHz)	PRI (μsec)	Number of Pulses per Burst	Number of Bursts	Minimum Percentage of Successful Detection	Minimum Number of Trials
5	50 - 100	5 - 20	1000 - 2000	1 - 3	8 - 20	80%	30

Table 3-7: Parameters for Long Pulse Radar Waveforms

The parameters for this waveform are randomly chosen. Thirty unique waveforms are required for the Long Pulse Radar Type waveforms. If more than 30 waveforms are used for the Long Pulse Radar Type waveforms, then each additional waveform must also be unique and not repeated from the previous waveforms.

Frequency Hopping Radar Test Waveform

Radar Type	Pulse Width (μsec)	PRI (μsec)	Pulses Per Hop	Hopping Rate (kHz)	Hopping Sequence Length (msec)	Minimum Percentage of Successful Detection	Minimum Number of Trials
6	1	333	9	0.333	300	70%	30

Table 3-8: Parameters for Frequency Hopping Radar Waveforms

For the Frequency Hopping Radar Type, the same Burst parameters are used for each waveform. The hopping sequence is different for each waveform and a 100-length segment is selected from the hopping sequence defined by the following algorithm:

The first frequency in a hopping sequence is selected randomly from the group of 475 integer frequencies from 5250 – 5724MHz. Next, the frequency that was just chosen is removed from the group and a frequency is randomly selected from the remaining 474 frequencies in the group. This process continues until all 475 frequencies are chosen for the set. For selection of a random frequency, the frequencies remaining within the group are always treated as equally likely.

3.5. Conducted Test Setup

The FCC KDB 905462 D02 UNII DFS Compliance Procedures New Rules v02 describes a radiated test setup and a conducted test setup. The conducted test setup was used for this testing. Figure 3-1 shows the typical test setup.

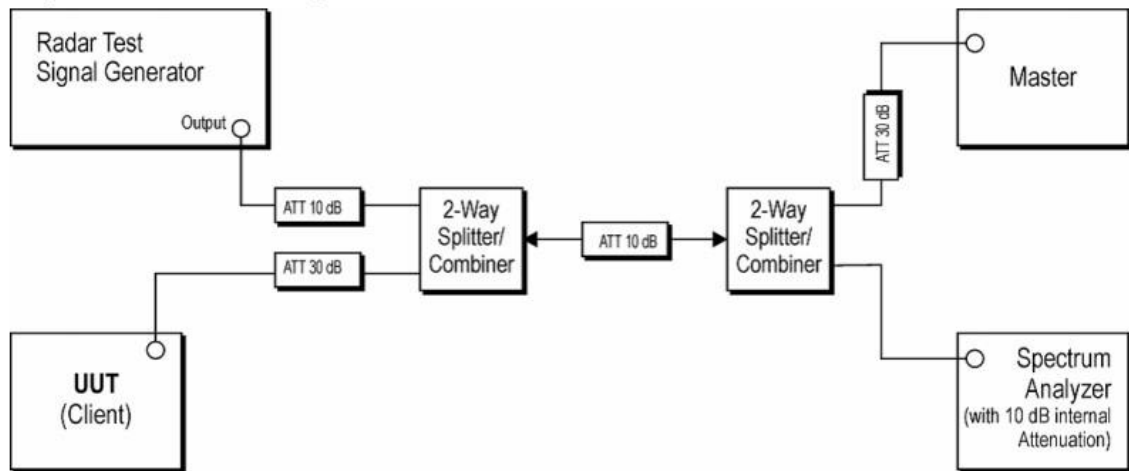

Figure 3-1: Conducted Test Setup where UUT is a Client and Radar Test Waveforms are injected into the Masters

4. TEST EQUIPMENT CALIBRATION DATE

Dynamic Frequency Selection (DFS) - TR4

Instrument	Manufacturer	Type No.	Asset No.	Cal. Date
EXA Signal Analyzer	KEYSIGHT	N9010A	MRTTWA00012	2017/07/11
MXG X-Series Microwave Analog Signal Generator	Keysight	N5183B	MRTTWA00080	2017/10/09
Combiner	WOKEN	0120N02208001D	MRTTWA00081	N/A

Master Device	Manufacturer	Type No.	FCC ID
Wireless LAN Access Point	Nokia	WO4C-AC400	2AD8UFZCW12A1

Software	Version	Manufacturer	Function
Pulse Building	N/A	Agilent	Radar Signal Generation Software
DFS Tool	V 6.9.2	Agilent	DFS Test Software

5. TEST RESULT

5.1. Summary

Product Name: 802.11ac Dual Band Module
FCC ID: TK4WLE1216V520
FCC Classification: Unlicensed National Information Infrastructure (UNII)

Parameter	Limit	Test Result	Reference
Channel Move Time, Channel Closing Transmission Time	Refer Table 3-3	Pass	Section 5.4

5.2. Radar Waveform Calibration

5.2.1. Calibration Setup

The conducted test setup was used for this calibration testing. Figure 3-2 shows the typical test setup.

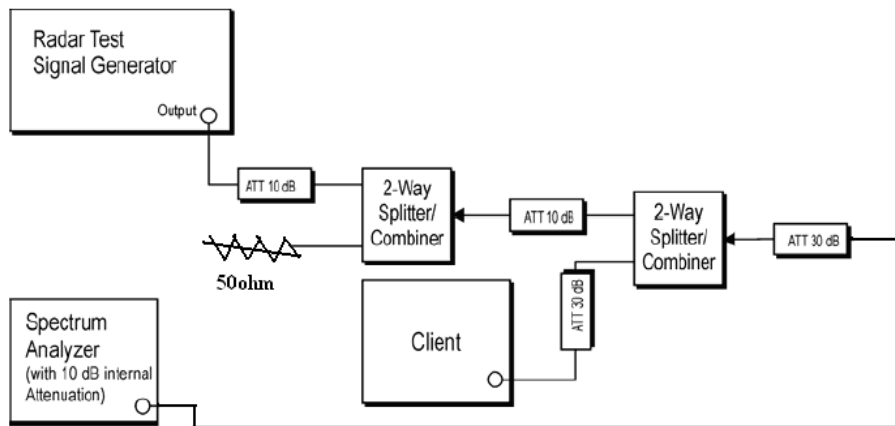

Figure 3-2: Conducted Test Setup

5.2.2. Calibration Procedure

The Interference Radar Detection Threshold Level is $(-64\text{dBm}) + (0) [\text{dBi}] + 1 \text{ dB} = -63 \text{ dBm}$ that had been taken into account the output power range and antenna gain. The above equipment setup was used to calibrate the conducted Radar Waveform. A vector signal generator was utilized to establish the test signal level for each radar type. During this process there were replace 50ohm terminal form Master and Client device and no transmissions by either the Master or Client Device. The spectrum analyzer was switched to the zero span (Time Domain) at the frequency of the Radar Waveform generator. Peak detection was used. The spectrum analyzer resolution bandwidth (RBW) and video bandwidth (VBW) were set to at least 3MHz. The vector signal generator amplitude was set so that the power level measured at the spectrum analyzer was $(-64\text{dBm}) + (0) [\text{dBi}] + 1 \text{ dB} = -63\text{dBm}$. Capture the spectrum analyzer plots on short pulse radar types, long pulse radar type and hopping radar waveform.

5.2.3. Cablibration Result

Radar #0 DFS detection threshold level and the burst of pulses on the Channel frequency

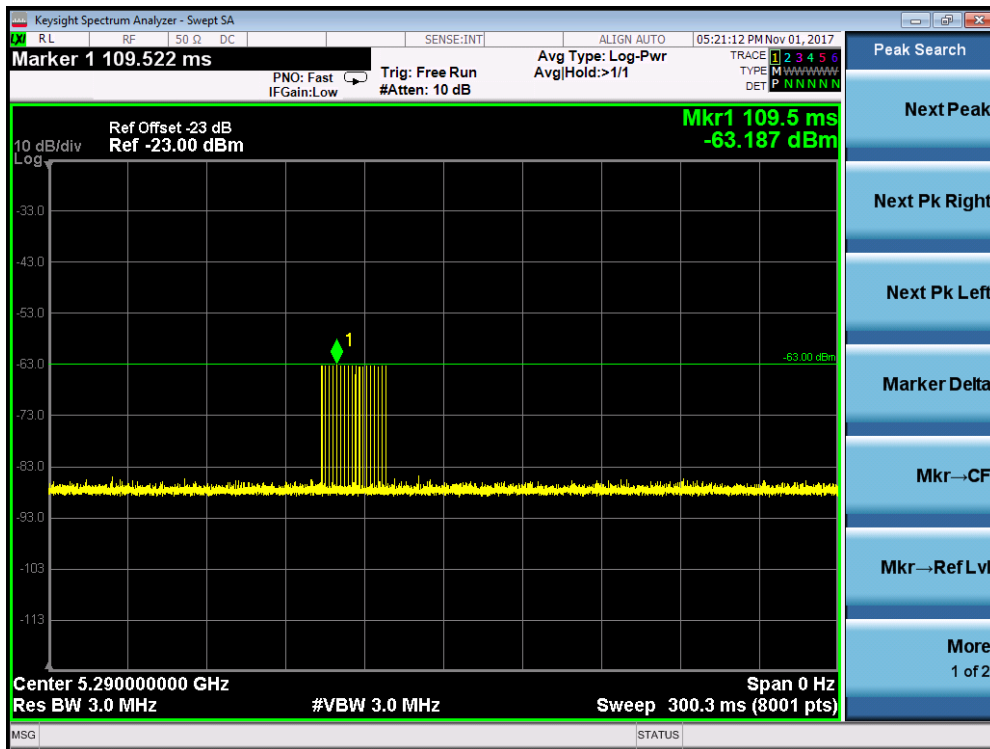

Radar #1(Test A) DFS detection threshold level and the burst of pulses on the Channel frequency

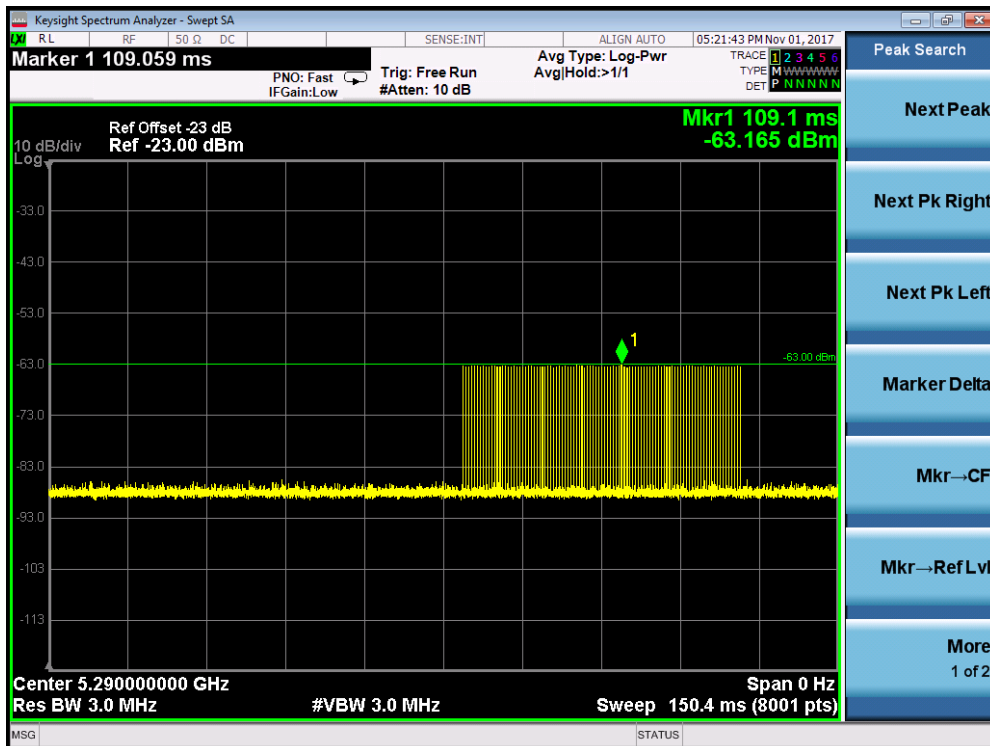

PRI = 878us and the number of pulses = 61

Radar #1(Test B) DFS detection threshold level and the burst of pulses on the Channel frequency

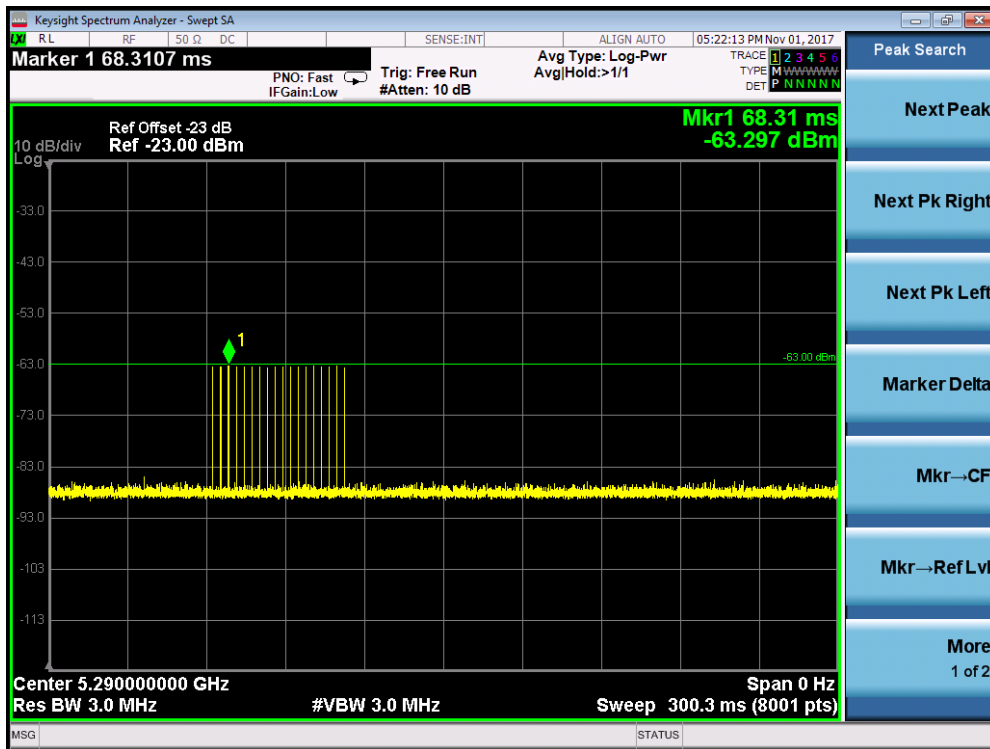

PRI = 2.911ms and the number of pulses = 19

Radar #2 DFS detection threshold level and the burst of pulses on the Channel frequency

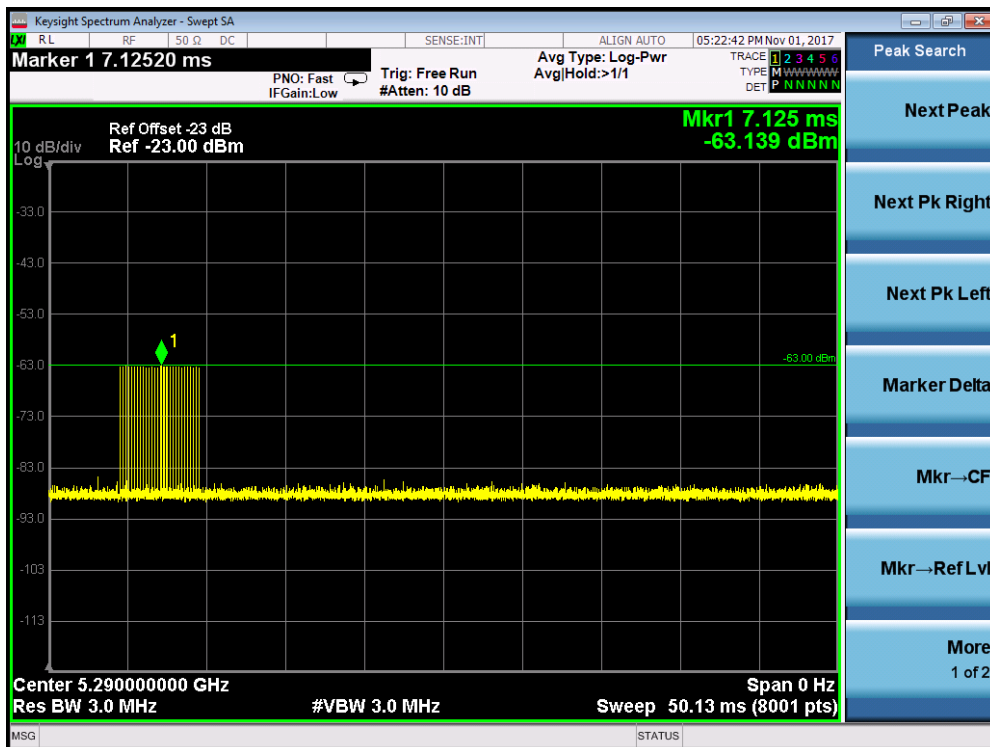

Radar #3 DFS detection threshold level and the burst of pulses on the Channel frequency

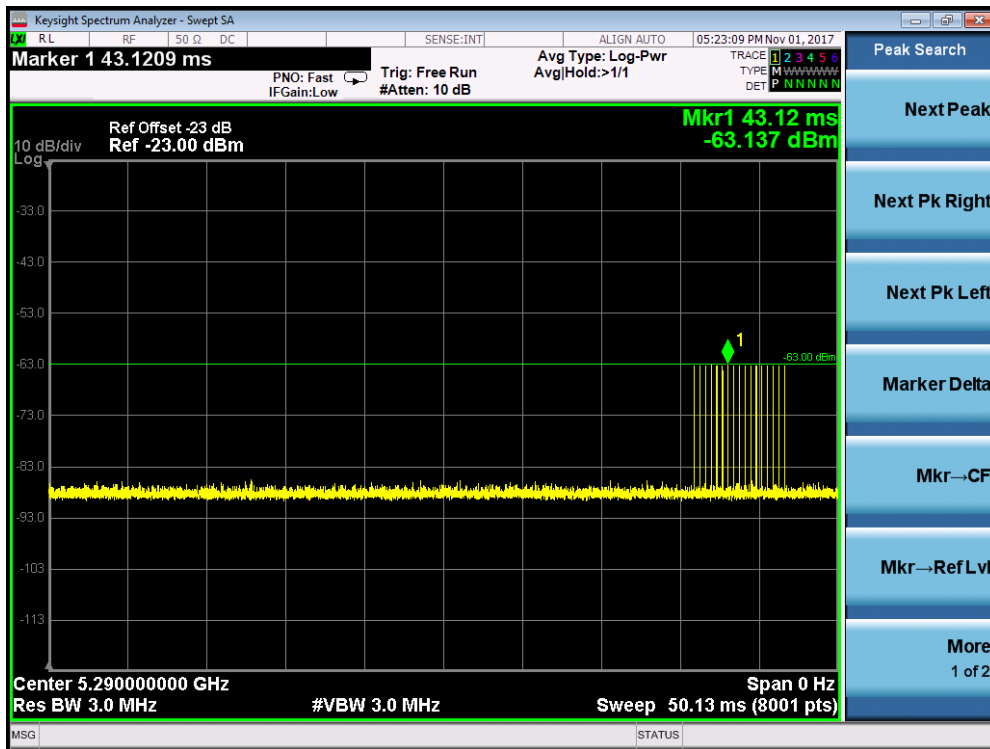

Radar #4 DFS detection threshold level and the burst of pulses on the Channel frequency

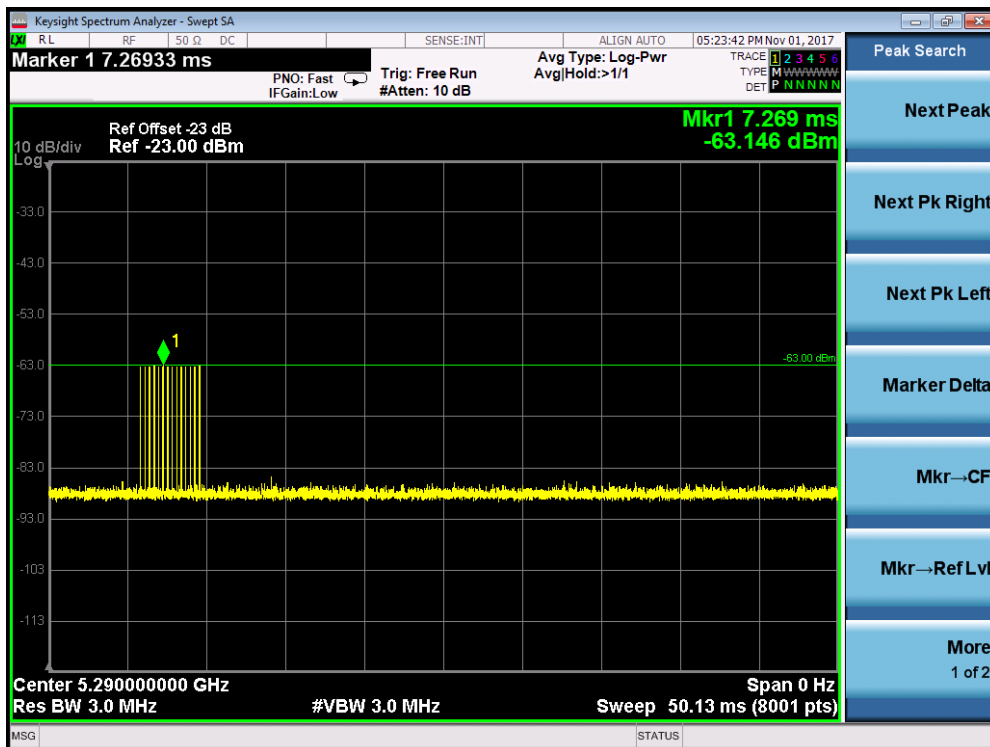

Radar #5 DFS detection threshold level and 12sec long burst on the Channel frequency

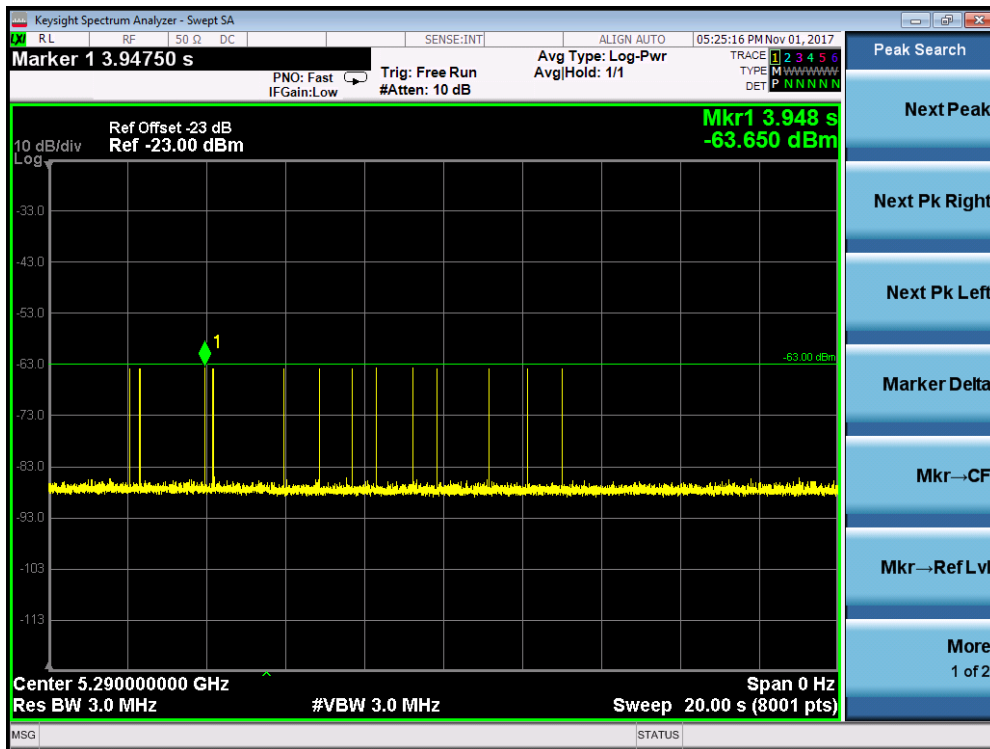

Radar #6 DFS detection threshold level and a single hop (9 pulses) on the Channel frequency within UNII detection bandwidth

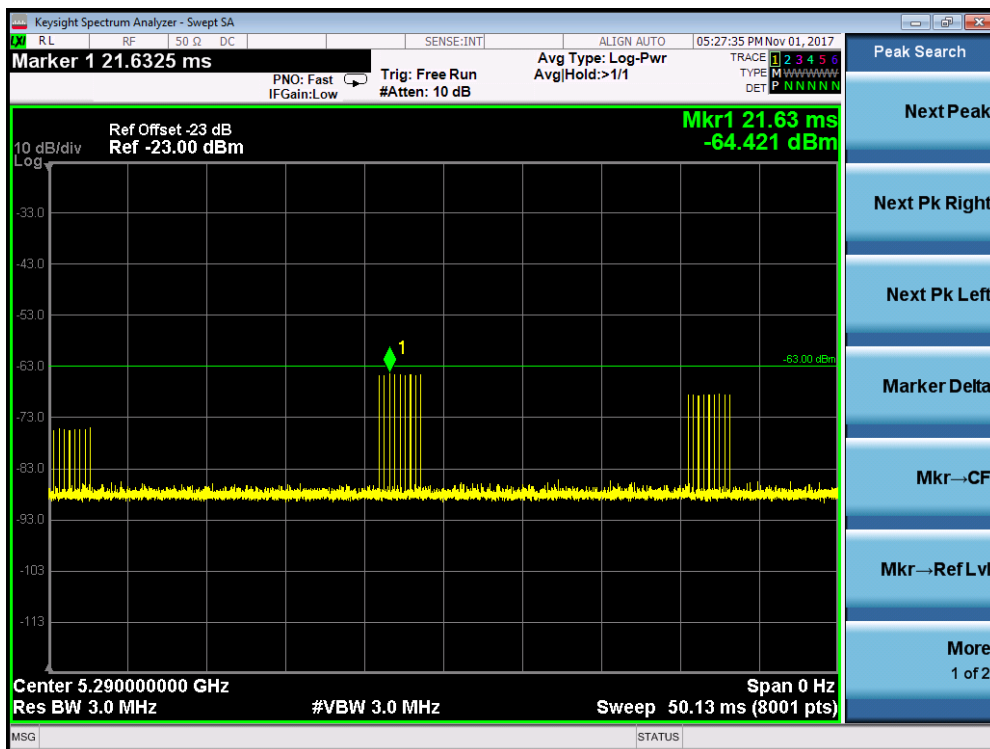

5.3. Channel Loading Test Result

System testing was performed with the designated MPEG test file that streams full motion video from the Tablet PC to the Client in full motion video mode using the media player with the V2.61 Codec package. This file is used by IP and Frame based systems for loading the test channel during the In-service compliance testing of the U-NII device. Packet ratio = Time On/ (Time On + Off Time).

Channel Loading Plot - 802.11ac-VHT80+80 - 5290MHz

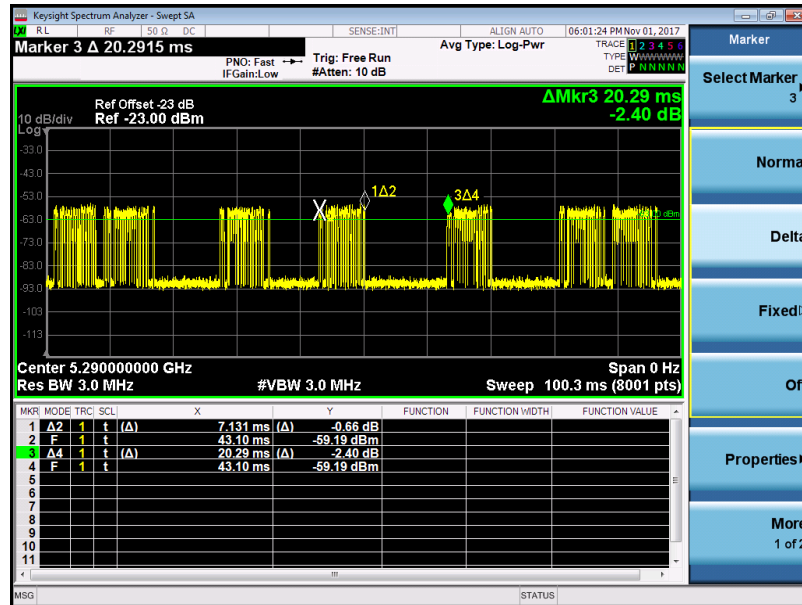

Channel Loading Plot - 802.11ac-VHT80+80 - 5530MHz

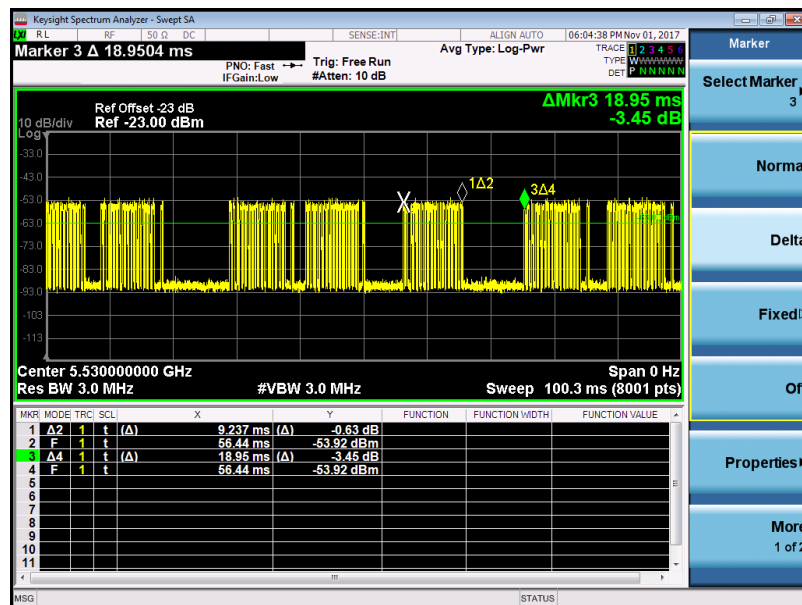

Test Mode	Packet ratio	Requirement ratio	Test Result
802.11ac-VHT80+80 5290MHz	35.15%	>17%	Pass
802.11ac-VHT80+80 5530MHz	48.74%	>17%	Pass

5.4. In-Service Monitoring for Channel Move Time & Channel Closing Transmission Time Measurement

5.4.1. Test Limit

The EUT has In-Service Monitoring function to continuously monitor the radar signals. If the radar is detected, must leave the channel (Shutdown). The Channel Move Time to cease all transmissions on the current channel upon detection of a Radar Waveform above the DFS Detection Threshold within 10 sec. The total duration of Channel Closing Transmission Time is 260ms, consisting of data signals and the aggregate of control signals, by a U-NII device during the Channel Move Time.

5.4.2. Test Procedure Used

1. The test should be performed with Radar Type 0. The measurement timing begins at the end of the Radar Type 0.
2. When the radar burst with a level equal to the DFS Detection Threshold + 1dB is generated on the Operating Channel of the U-NII device. A U-NII device operating as a Master Device will associate with the Client Device at Channel. Stream the MPEG test file from the Master Device to the Client Device on the selected Channel for the entire period of the test. At time T0 the Radar Waveform generator sends a Burst of pulses for each of the radar types at Detection Threshold + 1dB.
2. Observe the transmissions of the EUT at the end of the radar Burst on the Operating Channel. Measure and record the transmissions from the EUT during the observation time (Channel Move Time).
3. Measurement of the aggregate duration of the Channel Closing Transmission Time method. With the spectrum analyzer set to zero span tuned to the center frequency of the EUT operating channel at the radar simulated frequency, peak detection, and max hold, the dwell time per bin is given by: $Dwell (1.5ms) = S (12 \text{ sec}) / B (8000)$; where Dwell is the dwell time per spectrum analyzer sampling bin, S is the sweep time and B is the number of spectrum analyzer sampling bins. An upper bound of the aggregate duration of the intermittent control signals of Channel Closing Transmission Time is calculated by: $20MHz: C (19.5 \text{ ms}) = N (13) \times Dwell (1.5 \text{ ms})$; where C is the Closing Time, N is the number of spectrum analyzer sampling bins showing a U-NII transmission and Dwell is the dwell time per bin.

5.4.3. Test Result

Channel Move Time and Channel Closing Transmission Time for 802.11ac-VHT80+80 5290MHz

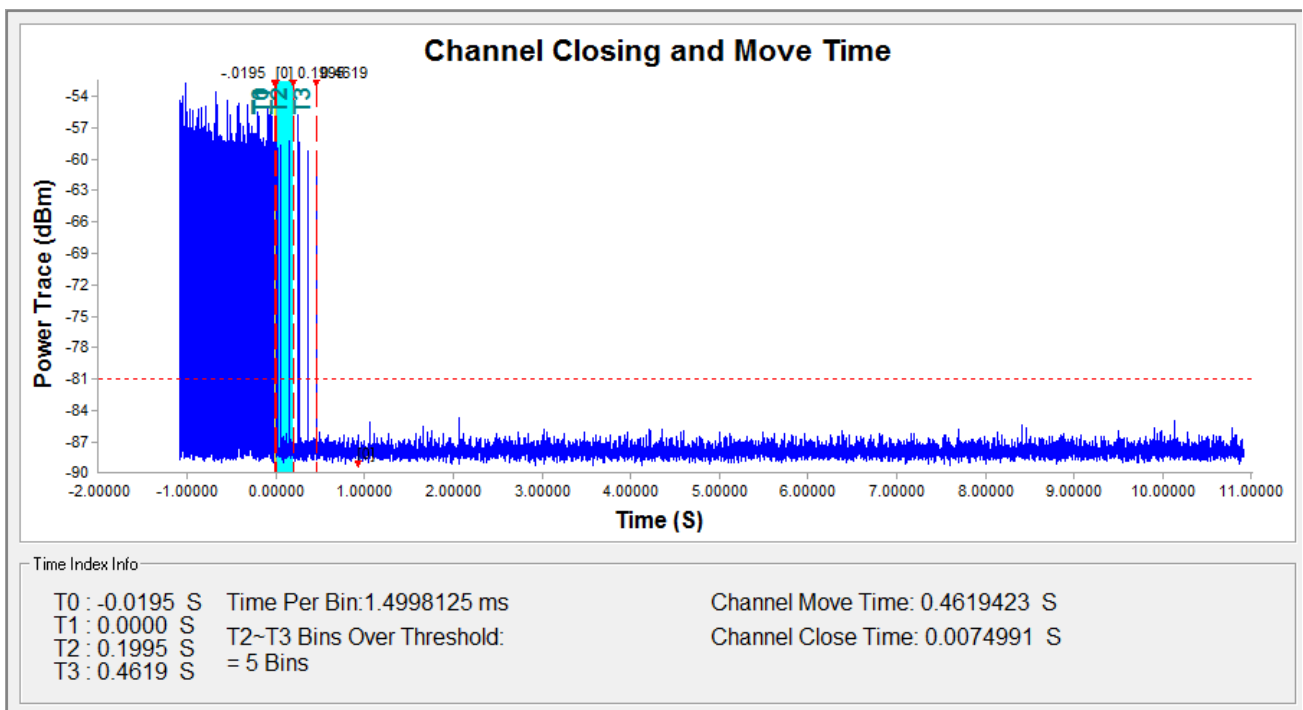
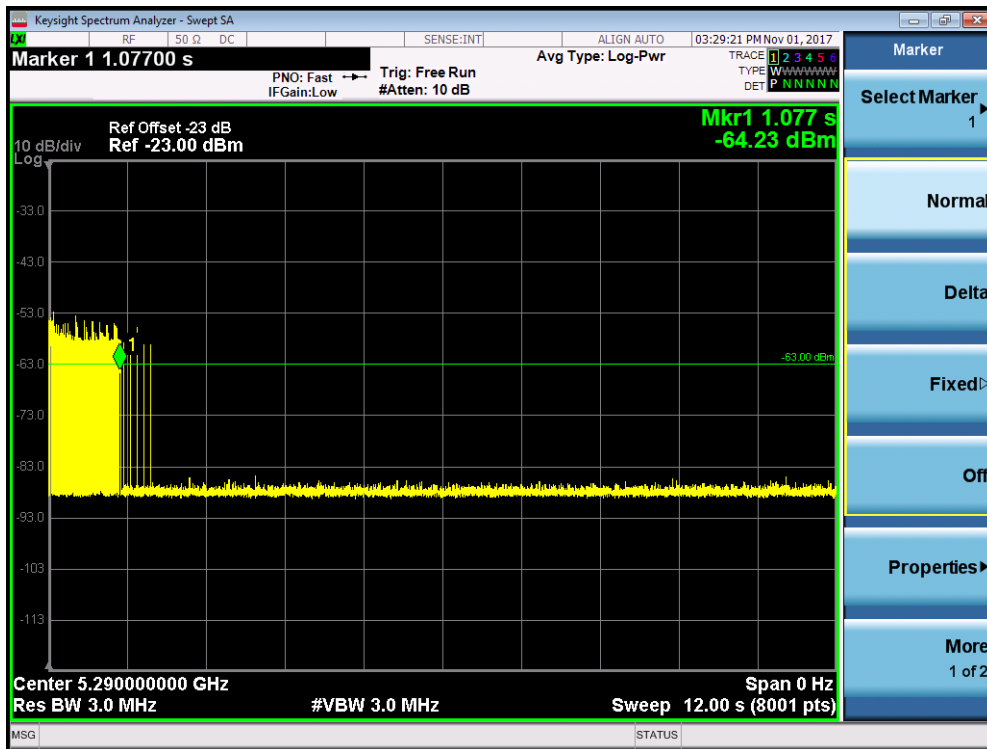

Channel Move Time and Channel Closing Transmission Time for 802.11ac-VHT80+80 5530MHz

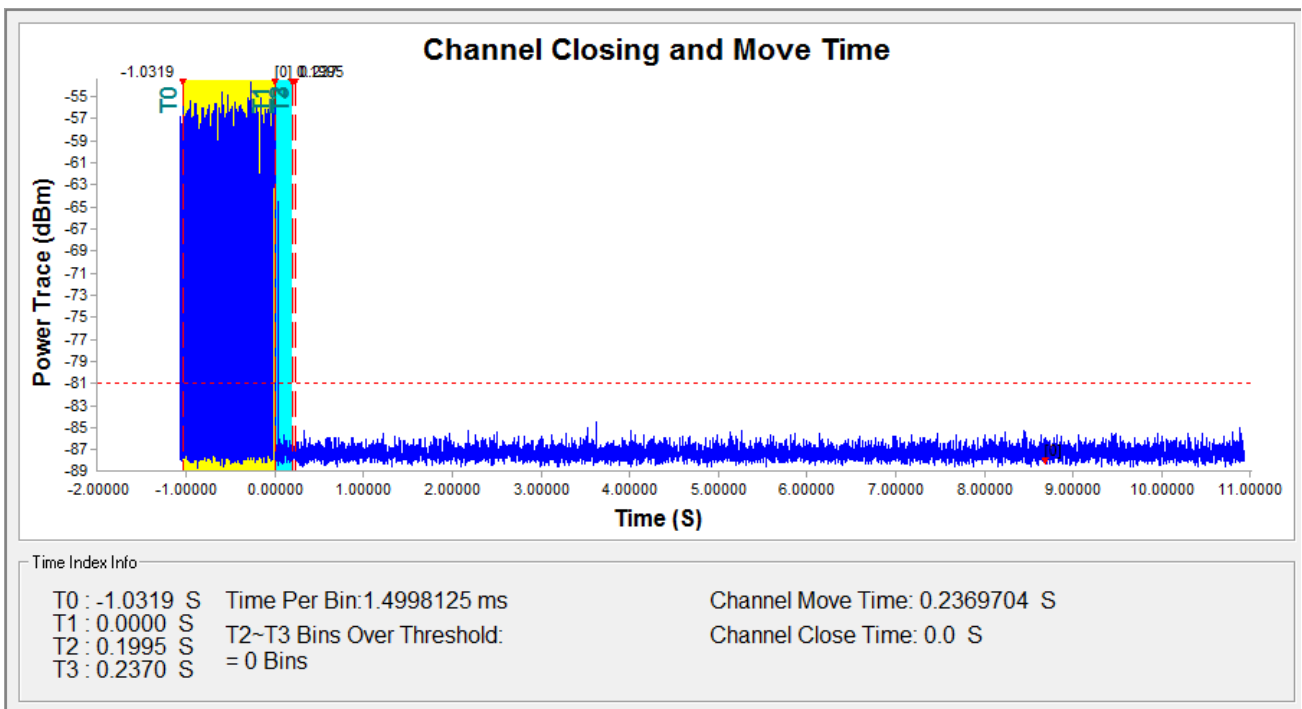
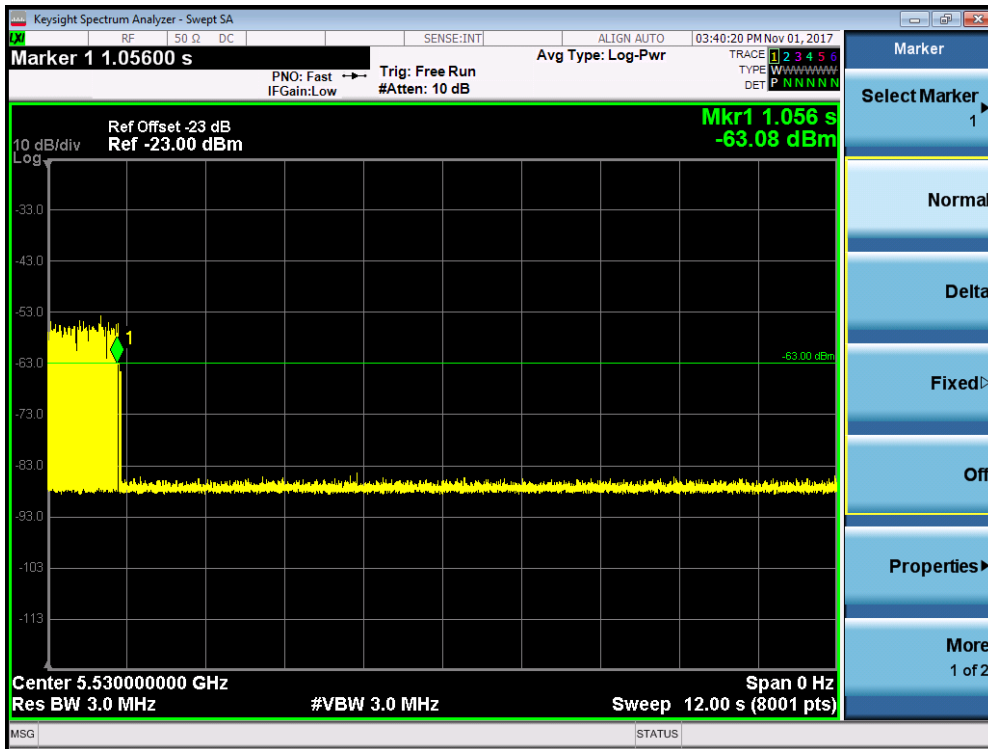

Parameter	Test Result		Limit
	5290MHz	5530MHz	
Channel Move Time (s)	0.46 s	0.24 s	< 10s
Channel Closing Transmission Time (ms) (Note)	7.5 ms	0 ms	< 60ms

Note1: The Channel Closing Transmission Time is comprised of 200 milliseconds starting at the beginning of the Channel Move Time plus any additional intermittent control signals required to facilitate a channel move (an aggregate of 60 milliseconds) during the remainder of the 10 seconds period. The aggregate duration of control signals will not count quiet periods in between transmissions.

Note2: Radar type0 was used for In-Service Monitoring testing.

6. CONCLUSION

The data collected relate only the item(s) tested and show that the **4x4 Wave-2 802.11ac/a/n Mini PCIe WiFi Module FCC ID: TK4WLE1216V520** is in compliance with Part 15E of the FCC Rules.

————— The End —————