

SAR Test Report

Product Name : Wireless-AG (108MBPS) Network USB
Adapter

Model No. : IW A VEPORT WLU108AG-MC

Applicant : Compex Systems Pte Ltd.

Address : 135 Joo Seng Road, #08-01 PM Industrial
Building Singapore 368363

Date of Receipt : 2007/08/08

Issued Date : 2008/01/31

Report No. : 078146R-HPUSP09V01

The test results relate only to the samples tested.

The test report shall not be reproduced except in full without the written approval of QuieTek Corporation.

Test Report Certification

Issued Date: 2008/01/31

Report No.: 078146R-HPUSP09V01



Product Name : Wireless-AG (108MBPS) Network USB Adapter
 Applicant : Compex Systems Pte Ltd.
 Address : 135 Joo Seng Road, #08-01 PM Industrial Building
 Singapore 368363
 Manufacturer : Compex Systems Pte Ltd.
 Model No. : IW A VEPORT WLU108AG-MC
 FCC ID : TK4-WLU108AG-MC
 Trade Name : Compex
 Applicable Standard : FCC Oet65 Supplement C June 2001
 IEEE Std. 1528-2003 47CFR § 2.1093
 Test Result : Max. SAR Measurement (1g)
 802.11b: 0.542 W/kg
 802.11g: 0.540 W/kg
 802.11a (5.2GHz): 1.205 W/kg
 802.11a (5.8GHz): 1.314 W/kg
 Application Type : Certification

The test results relate only to the samples tested.

The test report shall not be reproduced except in full without the written approval of Quietek Corporation.

Documented By : Nicole Huang
 (Engineering Adm. Assistant/
 Nicole Huang)

Tested By : Jung Chang
 (Engineer / Jung Chang)

Approved By : Vincent Lin
 (Deputy Manager / Vincent Lin)

TABLE OF CONTENTS

Description	Page
1. General Information	5
1.1 EUT Description	5
1.2 Test Environment	6
2. SAR Measurement System	7
2.1 ALSAS-10U System Description	7
2.1.1 Applications	7
2.1.2 Area Scans.....	7
2.1.3 Zoom Scan (Cube Scan Averaging).....	8
2.1.4 ALSAS-10U Interpolation and Extrapolation Uncertainty.....	8
2.2 Isotropic E-Field Probe	8
2.2.1 Isotropic E-Field Probe Specification.....	10
2.3 Boundary Detection Unit and Probe Mounting Device	10
2.4 Daq-Paq (Analog to Digital Electronics).....	11
2.5 Axis Articulated Robot	11
2.6 ALSAS Universal Workstation.....	12
2.7 Universal Device Positioner.....	12
2.8 Phantom Types.....	12
2.8.1 APREL SAM Phantoms	13
2.8.2 APREL Laboratories Universal Phantom	13
3. Tissue Simulating Liquid	14
3.1 The composition of the tissue simulating liquid	14
3.2 Tissue Calibration Result	14
3.3 Tissue Dielectric Parameters for Head and Body Phantoms	17
4. SAR Measurement Procedure	18
4.1 SAR System Validation.....	18
4.1.1 Validation Dipoles.....	18
4.1.2 Validation Result.....	18
4.2 SAR Measurement Procedure.....	20
5. SAR Exposure Limits	21
6. Test Equipment List	22
7. Measurement Uncertainty.....	23
8. Test Results.....	24
8.1 SAR Test Results Summary	24
Appendix.....	31

Appendix A. SAR System Validation Data

Appendix B. SAR measurement Data

Appendix C. Test Setup Photographs & EUT Photographs

Appendix D. Probe Calibration Data

Appendix E. Dipole Calibration Data

1. General Information

1.1 EUT Description

Product Name	Wireless-AG (108MBPS) Network USB Adapter
Trade Name	Compex
Model No.	IW A VEPOR T WLU108AG-MC
FCC ID	TK4-WLU108AG-MC
TX Frequency	2412MHz~2462MHz 5150MHz~5350MHz 5745MHz~5825MHz
Type of Modulation	DSSS/OFDM
Antenna Type	Fixed
Device Category	Portable
RF Exposure Environment	Uncontrolled
Transfer Rate	802.11b: 11Mbps 802.11g: 54Mbps 802.11a: 54Mbps
Max. Output Power (Conducted)	802.11b: 12.85 dBm 802.11g: 10.27 dBm 802.11a (5.2GHz): 16.09 dBm 802.11a (5.8GHz): 15.01 dBm

1.2 Test Environment

Ambient conditions in the laboratory:

Items	Required	Actual
Temperature (°C)	18-25	21.6
Humidity (%RH)	30-70	50

Site Description:

Accredited by TAF
Accredited Number: 0914
Effective through: December 12, 2008



Site Name: Quietek Corporation

Site Address: No. 5, Ruei-Shu Valley, Ruei-Ping Tsuen,
Lin-Kou Shiang, Taipei,
Taiwan, R.O.C.
TEL: 886-2-8601-3788 / FAX: 886-2-8601-3789
E-Mail: service@quietek.com

2. SAR Measurement System

2.1 ALSAS-10U System Description

ALSAS-10-U is fully compliant with the technical and scientific requirements of IEEE 1528, IEC 62209, CENELEC, ARIB, ACA, and the Federal Communications Commission. The system comprises of a six axes articulated robot which utilizes a dedicated controller.

ALSAS-10U uses the latest methodologies and FDTD modeling to provide a platform which is repeatable with minimum uncertainty.

2.1.1 Applications

Predefined measurement procedures compliant with the guidelines of CENELEC, IEEE, IEC, FCC, etc are utilized during the assessment for the device. Automatic detection for all SAR maxima are embedded within the core architecture for the system, ensuring that peak locations used for centering the zoom scan are within a 1mm resolution and a 0.05mm repeatable position. System operation range currently available up-to 6 GHz in simulated tissue.

2.1.2 Area Scans

Area scans are defined prior to the measurement process being executed with a user defined variable spacing between each measurement point (integral) allowing low uncertainty measurements to be conducted. Scans defined for FCC applications utilize a 10mm² step integral, with 1mm interpolation used to locate the peak SAR area used for zoom scan assessments.

Where the system identifies multiple SAR peaks (which are within 25% of peak value) the system will provide the user with the option of assessing each peak location individually for zoom scan averaging.



2.1.3 Zoom Scan (Cube Scan Averaging)

The averaging zoom scan volume utilized in the ALSAS-10U software is in the shape of a cube and the side dimension of a 1 g or 10 g mass is dependent on the density of the liquid representing the simulated tissue. A density of 1000 kg/m³ is used to represent the head and body tissue density and not the phantom liquid density, in order to be consistent with the definition of the liquid dielectric properties, i.e. the side length of the 1 g cube is 10mm, with the side length of the 10 g cube 21,5mm.

When the cube intersects with the surface of the phantom, it is oriented so that 3 vertices touch the surface of the shell or the center of a face is tangent to the surface. The face of the cube closest to the surface is modified in order to conform to the tangent surface.

The zoom scan integer steps can be user defined so as to reduce uncertainty, but normal practice for typical test applications (including FCC) utilize a physical step of 5x5x8 (8mmx8mmx5mm) providing a volume of 32mm in the X & Y axis, and 35mm in the Z axis.

2.1.4 ALSAS-10U Interpolation and Extrapolation Uncertainty

The overall uncertainty for the methodology and algorithms the used during the SAR calculation was evaluated using the data from IEEE 1528 based on the example f3 algorithm:

$$f_3(x, y, z) = A \frac{a^2}{\frac{a^2}{4} + x'^2 + y'^2} \cdot \left(e^{-\frac{2z}{a}} + \frac{a^2}{2(a + 2z)^2} \right)$$

2.2 Isotropic E-Field Probe

The isotropic E-Field probe has been fully calibrated and assessed for isotropicity, and boundary effect within a controlled environment. Depending on the frequency for which the probe is calibrated the method utilized for calibration will change. A number of methods is used for calibrating probes, and these are outlined in the table below:

Calibration Frequency	Air Calibration	Tissue Calibration
2450MHz	Waveguide	Temperature
5200MHz	Waveguide	Temperature
5800MHz	Waveguide	Temperature

The E-Field probe utilizes a triangular sensor arrangement as detailed in the diagram below:

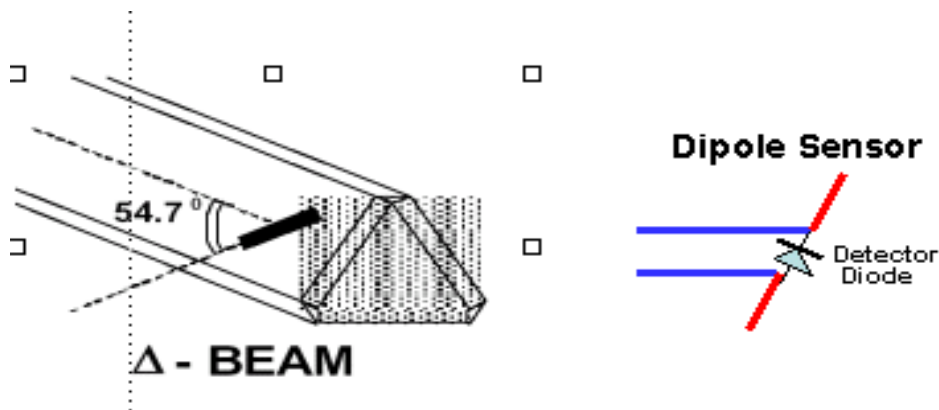

SAR is assessed with a calibrated probe which moves at a default height of 5mm from the center of the diode, which is mounted to the sensor, to the phantom surface (in the Z Axis). The 5mm offset height has been selected so as to minimize any resultant boundary effect due to the probe being in close proximity to the phantom surface.

The following algorithm is an example of the function used by the system for linearization of the output from the probe when measuring complex modulation schemes.

$$V_i = U_i + U_i^2 \cdot \frac{cf}{dcp_i}$$

2.2.1 Isotropic E-Field Probe Specification

Calibration in Air	Frequency Dependent Below 2GHz Calibration in air performed in a TEM Cell Above 2GHz Calibration in air performed in waveguide
Sensitivity	0.70 $\mu\text{V}/(\text{V}/\text{m})^2$ to 0.85 $\mu\text{V}/(\text{V}/\text{m})^2$
Dynamic Range	0.0005 W/kg to 100W/kg
Isotropic Response	Better than 0.2dB
Diode Compression point (DCP)	Calibration for Specific Frequency
Probe Tip Radius	< 5mm
Sensor Offset	1.56 (+/- 0.02mm)
Probe Length	290mm
Video Bandwidth	@ 500 Hz: 1dB @1.02 KHz: 3dB
Boundary Effect	Less than 2% for distance greater than 2.4mm
Spatial Resolution	Diameter less than 5mm Compliant with Standards

2.3 Boundary Detection Unit and Probe Mounting Device

ALSAS-10U incorporates a boundary detection unit with a sensitivity of 0.05mm for detecting all types of surfaces. The robust design allows for detection during probe tilt (probe normalize) exercises, and utilizes a second stage emergency stop. The signal electronics are fed directly into the robot controller for high accuracy surface detection in lateral and axial detection modes (X, Y, & Z).

The probe is mounted directly onto the Boundary Detection unit for accurate tooling and displacement calculations controlled by the robot kinematics. The probe is connect to an isolated probe interconnect where the output stage of the probe is fed directly into the amplifier stage of the Daq-Paq.

2.4 Daq-Paq (Analog to Digital Electronics)

ALSAS-10U incorporates a fully calibrated Daq-Paq (analog to digital conversion system) which has a 4 channel input stage, sent via a 2 stage auto-set amplifier module. The input signal is amplified accordingly so as to offer a dynamic range from 5µV to 800mV. Integration of the fields measured is carried out at board level utilizing a Co-Processor which then sends the measured fields down into the main computational module in digitized form via an RS232 communications port. Probe linearity and duty cycle compensation is carried out within the main Daq-Paq module.

ADC	12 Bit
Amplifier Range	20mV to 200mV and 150mV to 800mV
Field Integration	Local Co-Processor utilizing proprietary integration algorithms
Number of Input Channels	4 in total 3 dedicated and 1 spare
Communication	Packet data via RS232

2.5 Axis Articulated Robot



ALSAS-10U utilizes a six axis articulated robot, which is controlled using a Pentium based real-time movement controller. The movement kinematics engine utilizes proprietary (Thermo CRS) interpolation and extrapolation algorithms, which allow full freedom of movement for each of the six joints within the working envelope. Utilization of joint 6 allows for full probe rotation with a tolerance better than 0.05mm around the central axis.

Robot/Controller Manufacturer	Thermo CRS
Number of Axis	Six independently controlled axis
Positioning Repeatability	0.05mm
Controller Type	Single phase Pentium based C500C
Robot Reach	710mm
Communication	RS232 and LAN compatible

2.6 ALSAS Universal Workstation

ALSAS Universal workstation allows for repeatability and fast adaptability. It allows users to do calibration, testing and measurements using different types of phantoms with one set up, which significantly speeds up the measurement process.

2.7 Universal Device Positioner

The universal device positioner allow complete freedom of movement of the EUT. Developed to hold a EUT in a free-space scenario any additional loading attributable to the material used in the construction of the positioner has been eliminated. Repeatability has been enhanced through the linear scales which form the design used to indicate positioning for any given test scenario in all major axes. A 15° tilt indicator is included for the of aid cheek to tilt movements for head SAR analysis. Overall uncertainty for measurements have been reduced due to the design of the Universal device positioner, which allows positioning of a device in as near to a free-space scenario as possible, and by providing the means for complete repeatability.



2.8 Phantom Types

The ALSAS-10U allows the integration of multiple phantom types. SAM Phantoms fully compliant with IEEE 1528, Universal Phantom, and Universal Flat.

2.8.1 APREL SAM Phantoms

The SAM phantoms developed using the IEEE SAM CAD file. They are fully compliant with the requirements for both IEEE 1528 and FCC Supplement C. Both the left and right SAM phantoms are interchangeable, transparent and include the IEEE 1528 grid with visible NF and MB lines.

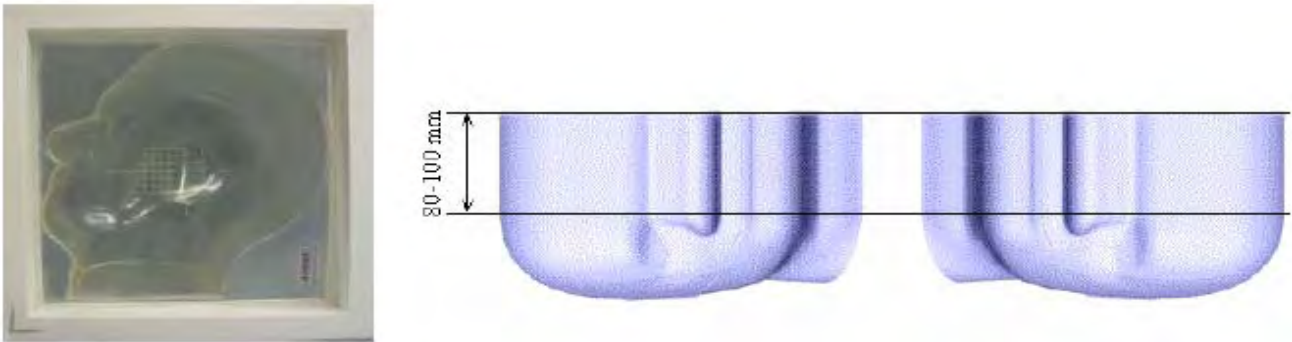

2.8.2 APREL Laboratories Universal Phantom

The Universal Phantom is used on the ALSAS-10U as a system validation phantom. The Universal Phantom has been fully validated both experimentally from 800MHz to 6GHz and numerically using XFDTD numerical software. The shell thickness is 2mm overall, with a 4mm spacer located at the NF/MB intersection providing an overall thickness of 6mm in line with the requirements of IEEE-1528.



The design allows for fast and accurate measurements, of handsets, by allowing the conservative SAR to be evaluated at on frequency for both left and right head experiments in one measurement.

3. Tissue Simulating Liquid

3.1 The composition of the tissue simulating liquid

INGREDIENT (% Weight)	2450MHz Head	2450MHz Body	5200MHz Head	5200MHz Body	5800MHz Head	5800MHz Body
Water	46.7	73.2	67.63	76	68.29	75.68
Salt	0.00	0.04	0.00	0.00	0.00	0.43
Sugar	0.00	0.00	0.00	0.00	0.00	0.00
HEC	0.00	0.00	0.00	0.00	0.00	0.00
Preventol	0.00	0.00	0.00	0.00	0.00	0.00
DGBE	53.3	26.7	3.38	4.44	2.44	4.42
Triton X-100	0.00	0.00	28.99	19.56	29.27	19.47

3.2 Tissue Calibration Result

The dielectric parameters of the liquids were verified prior to the SAR evaluation using APREL Dielectric Probe Kit and Anritsu MS4623B Vector Network Analyzer.

Head Tissue Simulant Measurement				
Frequency [MHz]	Description	Dielectric Parameters		Tissue Temp. [°C]
		ϵ_r	σ [s/m]	
2450MHz	Reference result ± 5% window	39.2 37.24 to 41.16	1.8 1.71 to 1.89	N/A
	20-Dec-07	38.33	1.816	20.1

Body Tissue Simulant Measurement				
Frequency [MHz]	Description	Dielectric Parameters		Tissue Temp. [°C]
		ϵ_r	σ [s/m]	
2450MHz	Reference result ± 5% window	52.5 49.875 to 55.125	1.78 1.691 to 1.869	N/A
	20-Dec-07	53.41	1.868	20.1
2412 MHz	Low channel	53.32	1.860	20.1
2437 MHz	Mid channel	53.47	1.854	20.1
2462 MHz	High channel	53.64	1.856	20.1

Head Tissue Simulant Measurement				
Frequency [MHz]	Description	Dielectric Parameters		Tissue Temp. [°C]
		ϵ_r	σ [s/m]	
5200MHz	Reference result ± 5% window	39.94 37.943 to 41.937	5.24 4.978 to 5.502	N/A
	18-Dec-07	38.66	5.014	21.1

Body Tissue Simulant Measurement				
Frequency [MHz]	Description	Dielectric Parameters		Tissue Temp. [°C]
		ϵ_r	σ [s/m]	
5200MHz	Reference result ± 5% window	48.9 46.455 to 51.345	5.35 5.0825 to 5.6175	N/A
	18-Dec-07	47.21	5.314	21.1
5180 MHz	Low channel	47.17	5.414	21.1
5220 MHz	Mid channel	47.33	5.317	21.1
5240 MHz	High channel	47.31	5.279	21.1

Head Tissue Simulant Measurement				
Frequency [MHz]	Description	Dielectric Parameters		Tissue Temp. [°C]
		ϵ_r	σ [s/m]	
5800MHz	Reference result ± 5% window	35.15 33.3925 to 36.9075	6.4 6.08 to 6.72	N/A
	17-Dec-07	36.07	6.317	21.1

Body Tissue Simulant Measurement				
Frequency [MHz]	Description	Dielectric Parameters		Tissue Temp. [°C]
		ϵ_r	σ [s/m]	
5800MHz	Reference result ± 5% window	48.2 45.79 to 50.61	6 5.7 to 6.3	N/A
	17-Dec-07	48.31	6.124	21.1
5745 MHz	Low channel	48.19	6.019	21.1
5785 MHz	Mid channel	48.26	6.127	21.1
5825 MHz	High channel	48.44	6.121	21.1

3.3 Tissue Dielectric Parameters for Head and Body Phantoms

The head tissue dielectric parameters recommended by the IEEE SCC-34/SC-2 in P1528 have been incorporated in the following table. These head parameters are derived from planar layer models simulating the highest expected SAR for the dielectric properties and tissue thickness variations in a human head. Other head and body tissue parameters that have not been specified in P1528 are derived from the tissue dielectric parameters computed from the 4-Cole-Cole equations described in Reference [12] and extrapolated according to the head parameters specified in P1528.

Target Frequency (MHz)	Head		Body	
	ϵ_r	σ (S/m)	ϵ_r	σ (S/m)
150	52.3	0.76	61.9	0.80
300	45.3	0.87	58.2	0.92
450	43.5	0.87	56.7	0.94
835	41.5	0.90	55.2	0.97
900	41.5	0.97	55.0	1.05
915	41.5	0.98	55.0	1.06
1450	40.5	1.20	54.0	1.30
1610	40.3	1.29	53.8	1.40
1800 – 2000	40.0	1.40	53.3	1.52
2450	39.2	1.80	52.7	1.95
3000	38.5	2.40	52.0	2.73
5800	35.3	5.27	48.2	6.00

(ϵ_r = relative permittivity, σ = conductivity and $\rho = 1000 \text{ kg/m}^3$)

4. SAR Measurement Procedure

4.1 SAR System Validation

4.1.1 Validation Dipoles

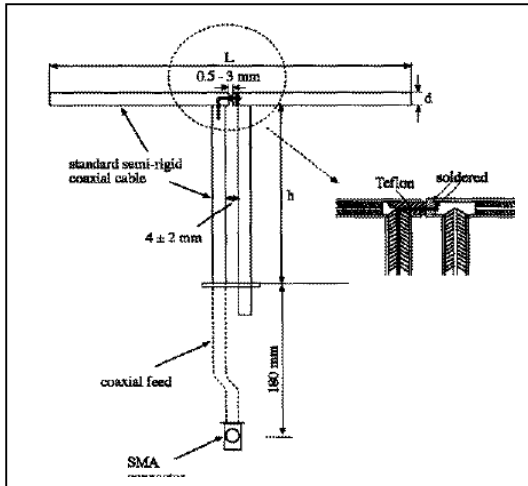

The dipoles used is based on the IEEE-1528 standard, and is complied with mechanical and electrical specifications in line with the requirements of both IEEE and FCC Supplement C. the table below provides details for the mechanical and electrical specifications for the dipoles.

Frequency	L (mm)	h (mm)	d (mm)
2450MHz	53.5	30.4	3.6
5200MHz	23.6	14.0	3.6
5800MHz	21.6	12.6	3.6

4.1.2 Validation Result

System Performance Check at 2450MHz				
Validation Kit: ASL-D-2450-S-2				
Frequency [MHz]	Description	SAR [w/kg] 1g	SAR [w/kg] 10g	Tissue Temp. [°C]
2450 MHz	Reference result ± 5% window	48.07 45.6665 to 50.4735	25.65 24.3675 to 26.9325	N/A
	20-Dec-07	50.436	24.414	20.1
Note: All SAR values are normalized to 1W forward power.				

System Performance Check at 5200MHz			
Validation Kit: ASL-D-5200-S-2			
Frequency [MHz]	Description	SAR [w/kg] 1g	Tissue Temp. [°C]
5200 MHz	Reference result ± 5% window	58.8 55.86 to 61.74	N/A
	18-Dec-07	57.661	21.1
Note: All SAR values are normalized to 1W forward power.			

System Performance Check at 5800MHz			
Validation Kit: ASL-D-5800-S-2			
Frequency [MHz]	Description	SAR [w/kg] 1g	Tissue Temp. [°C]
5800 MHz	Reference result ± 5% window	57.9 55.005 to 60.795	N/A
	17-Dec-07	58.114	21.1
Note: All SAR values are normalized to 1W forward power.			

4.2 SAR Measurement Procedure

The ALSAS-10U calculates SAR using the following equation,

$$SAR = \frac{\sigma |E|^2}{\rho}$$

σ : represents the simulated tissue conductivity

ρ : represents the tissue density

The EUT is set to transmit at the required power in line with product specification, at each frequency relating to the LOW, MID, and HIGH channel settings.

Pre-scans are made on the device to establish the location for the transmitting antenna, using a large area scan in either air or tissue simulation fluid.

The EUT is placed against the Universal Phantom where the maximum area scan dimensions are larger than the physical size of the resonating antenna. When the scan size is not large enough to cover the peak SAR distribution, it is modified by either extending the area scan size in both the X and Y directions, or the device is shifted within the predefined area.

The area scan is then run to establish the peak SAR location (interpolated resolution set at 1mm²) which is then used to orient the center of the zoom scan. The zoom scan is then executed and the 1g and 10g averages are derived from the zoom scan volume (interpolated resolution set at 1mm³).

5. SAR Exposure Limits

SAR assessments have been made in line with the requirements of IEEE-1528, FCC Supplement C, and comply with ANSI/IEEE C95.1-1992 “Uncontrolled Environments” limits. These limits apply to a location which is deemed as “Uncontrolled Environment” which can be described as a situation where the general public may be exposed to an RF source with no prior knowledge or control over their exposure.

Limits for General Population/Uncontrolled Exposure (W/kg)

Type Exposure	Uncontrolled Environment Limit
Spatial Peak SAR (1g cube tissue for brain or body)	1.60 W/kg
Spatial Average SAR (whole body)	0.08 W/kg
Spatial Peak SAR (10g for hands, feet, ankles and wrist)	4.00 W/kg

6. Test Equipment List

Instrument	Manufacturer	Model No.	Serial No.	Last Calibration	Next Calibration
Data Acquisition Package	Apriel	ALS-DAQ-PAQ-2	QTK-337	Nov. 2006	only once
Apriel Laboratories Probe	Apriel	ALS-E020	264	Aug. 2007	Aug. 2008
Apriel Reference Dipole 2450Mhz	Apriel	ALS-D-2450-S-2	QTK-319	Jun. 2006	Jun. 2008
Apriel Reference Dipole 5200Mhz	Apriel	ALS-D-2450-S-2	QTK-320	Jun. 2006	Jun. 2008
Apriel Reference Dipole 5800Mhz	Apriel	ALS-D-2450-S-2	QTK-321	Jun. 2006	Jun. 2008
Boundary Detection Sensor System	Apriel	ALS-PMDPS-2	QTK-336	N/A	N/A
Dielectric Probe Kit	Apriel	ALS-PR-DIEL	QTK-296	N/A	N/A
Universal Work Station	Apriel	ALS-UWS	QTK-326	N/A	N/A
Device Holder 2.0	Apriel	ALS-H-E-SET-2	QTK-294	N/A	N/A
Left Ear SAM Phantom	Apriel	ALS-P-SAM-L	QTK-292	N/A	N/A
Right Ear SAM Phantom	Apriel	ALS-P-SAM-R	QTK-288	N/A	N/A
Universal Phantom	Apriel	ALS-P-UP-1	QTK-246	N/A	N/A
Apriel Dipole Spacer	Apriel	ALS-DS-U	QTK-295	N/A	N/A
SAR Software	Apriel	ALSAS-10	Ver. 2.1.0	N/A	N/A
CRS C500C Controller	Thermo	ALS-C500	RCF0404433	N/A	N/A
CRF F3 Robot	Thermo	ALS-F3	RAF0412222	N/A	N/A
Power Amplifier	Mini-Circuit	ZHL-42	D051404-20	N/A	N/A
Directional Coupler	Agilent	778D-012	50550	N/A	N/A
Universal Radio Communication Tester	Rohde & Schwarz	CMU 200	104846	Apr. 2007	Apr. 2008
Radio Communication Analyzer	Anritsu	MT8820A	6200323183	Apr. 2007	Apr. 2008
Vector Network	Anritsu	MS4623B	992801	Apr. 2007	Apr. 2008
Signal Generator	Anritsu	MG3692A	042319	Jun. 2007	Jun. 2008
Power Meter	Anritsu	ML2487A	6K00001447	Apr. 2007	Apr. 2008
Wide Bandwidth Sensor	Anritsu	MA2491	030677	Apr. 2007	Apr. 2008

7. Measurement Uncertainty

Exposure Assessment Measurement Uncertainty

Source of Uncertainty	Tolerance Value	Probability Distribution	Divisor	c_i^+ (1-g)	c_i^- (10-g)	Standard Uncertainty (1-g) %	Standard Uncertainty (10-g) %
Measurement System							
Probe Calibration	3.5	normal	1	1	1	3.5	3.5
Axial Isotropy	3.7	rectangular	$\sqrt{3}$	$(1-cp)^{1/2}$	$(1-cp)^{1/2}$	1.5	1.5
Hemispherical Isotropy	10.9	rectangular	$\sqrt{3}$	\sqrt{cp}	\sqrt{cp}	4.4	4.4
Boundary Effect	1.0	rectangular	$\sqrt{3}$	1	1	0.6	0.6
Linearity	4.7	rectangular	$\sqrt{3}$	1	1	2.7	2.7
Detection Limit	1.0	rectangular	$\sqrt{3}$	1	1	0.6	0.6
Readout Electronics	1.0	normal	1	1	1	1.0	1.0
Response Time	0.8	rectangular	$\sqrt{3}$	1	1	0.5	0.5
Integration Time	1.7	rectangular	$\sqrt{3}$	1	1	1.0	1.0
RF Ambient Condition	3.0	rectangular	$\sqrt{3}$	1	1	1.7	1.7
Probe Positioner Mech.	0.4	rectangular	$\sqrt{3}$	1	1	0.2	0.2
Restriction							
Probe Positioning with respect to Phantom Shell	2.9	rectangular	$\sqrt{3}$	1	1	1.7	1.7
Extrapolation and Integration	3.7	rectangular	$\sqrt{3}$	1	1	2.1	2.1
Test Sample Positioning	4.0	normal	1	1	1	4.0	4.0
Device Holder Uncertainty	2.0	normal	1	1	1	2.0	2.0
Drift of Output Power	4.7	rectangular	$\sqrt{3}$	1	1	2.7	2.7
Phantom and Setup							
Phantom Uncertainty(shape & thickness tolerance)	3.4	rectangular	$\sqrt{3}$	1	1	2.0	2.0
Liquid Conductivity(target)	5.0	rectangular	$\sqrt{3}$	0.7	0.5	2.0	1.4
Liquid Conductivity(meas.)	0.1	normal	1	0.7	0.5	0.1	0.0
Liquid Permittivity(target)	2.0	rectangular	$\sqrt{3}$	0.6	0.5	0.7	0.6
Liquid Permittivity(meas.)	2.6	normal	1	0.6	0.5	1.6	1.3
Combined Uncertainty		RSS				9.6	9.5
Combined Uncertainty (coverage factor=2)		Normal(k=2)				19.3	18.9

8. Test Results

8.1 SAR Test Results Summary

SAR MEASUREMENT						
Ambient Temperature (°C): 21.6 ± 2			Relative Humidity (%): 50			
Liquid Temperature (°C): 20.1 ± 2			Depth of Liquid (cm):>15			
Product: Wireless-AG (108MBPS) Network USB Adapter						
Test Mode: 802.11b						
Test Position Body	Antenna Position	Frequency		Conducted Peak Power (dBm)	SAR 1g (W/kg)	Limit (W/kg)
		Channel	MHz			
Front	Fixed	1	2412	11.38	**	1.6
Front	Fixed	6	2437	12.44	0.185	1.6
Front	Fixed	11	2462	12.85	**	1.6
Back	Fixed	1	2412	11.38	0.542	1.6
Back	Fixed	6	2437	12.44	0.476	1.6
Back	Fixed	11	2462	12.85	0.507	1.6
Top	Fixed	1	2412	11.38	**	1.6
Top	Fixed	6	2437	12.44	0.191	1.6
Top	Fixed	11	2462	12.85	**	1.6
Note: The client declared that the EUT was only operated in EUT front.						

SAR MEASUREMENT						
Ambient Temperature (°C): 21.6 ± 2				Relative Humidity (%): 50		
Liquid Temperature (°C): 20.1 ± 2				Depth of Liquid (cm):>15		
Product: Wireless-AG (108MBPS) Network USB Adapter						
Test Mode: 802.11g						
Test Position Body	Antenna Position	Frequency		Conducted Peak Power (dBm)	SAR 1g (W/kg)	Limit (W/kg)
		Channel	MHz			
Front	Fixed	1	2412	9.10	**	1.6
Front	Fixed	6	2437	8.36	0.093	1.6
Front	Fixed	11	2462	9.46	**	1.6
Back	Fixed	1	2412	9.10	0.418	1.6
Back	Fixed	6	2437	8.36	0.311	1.6
Back	Fixed	11	2462	9.46	0.540	1.6
Top	Fixed	1	2412	9.10	**	1.6
Top	Fixed	6	2437	8.36	0.102	1.6
Top	Fixed	11	2462	9.46	**	1.6
Note: The client declared that the EUT was only operated in EUT front.						

SAR MEASUREMENT						
Ambient Temperature (°C): 21.6 ± 2				Relative Humidity (%): 50		
Liquid Temperature (°C): 20.1 ± 2				Depth of Liquid (cm):>15		
Product: Wireless-AG (108MBPS) Network USB Adapter						
Test Mode: 802.11g Super						
Test Position Body	Antenna Position	Frequency		Conducted Peak Power (dBm)	SAR 1g (W/kg)	Limit (W/kg)
		Channel	MHz			
Front	Fixed	3	2422	10.07	**	1.6
Front	Fixed	7	2442	9.32	0.135	1.6
Front	Fixed	11	2462	10.27	**	1.6
Back	Fixed	3	2422	10.07	0.387	1.6
Back	Fixed	7	2442	9.32	0.254	1.6
Back	Fixed	11	2462	10.27	0.375	1.6
Top	Fixed	3	2422	10.07	**	1.6
Top	Fixed	7	2442	9.32	0.137	1.6
Top	Fixed	11	2462	10.27	**	1.6
Note: The client declared that the EUT was only operated in EUT front.						

SAR MEASUREMENT						
Ambient Temperature (°C): 22.4 ± 2				Relative Humidity (%): 51		
Liquid Temperature (°C): 21.1 ± 2				Depth of Liquid (cm):>15		
Product: Wireless-AG (108MBPS) Network USB Adapter						
Test Mode: 802.11a, 5.2GHz						
Test Position Body	Antenna Position	Frequency		Conducted Peak Power (dBm)	SAR 1g (W/kg)	Limit (W/kg)
		Channel	MHz			
Front	Fixed	52	5260	14.40	0.421	1.6
Front	Fixed	56	5280	14.26	**	1.6
Front	Fixed	64	5320	14.33	**	1.6
Back	Fixed	36	5180	11.82	0.297	1.6
Back	Fixed	40	5200	12.21	0.416	1.6
Back	Fixed	48	5240	12.83	0.519	1.6
Back	Fixed	52	5260	14.40	0.647	1.6
Back	Fixed	56	5280	14.26	0.637	1.6
Back	Fixed	64	5320	14.33	0.792	1.6
Top	Fixed	52	5260	14.40	0.377	1.6
Top	Fixed	56	5280	14.26	**	1.6
Top	Fixed	64	5320	14.33	**	1.6

Note: The client declared that the EUT was only operated in EUT front.

SAR MEASUREMENT						
Ambient Temperature (°C): 22.4 ± 2				Relative Humidity (%): 51		
Liquid Temperature (°C): 21.1 ± 2				Depth of Liquid (cm):>15		
Product: Wireless-AG (108MBPS) Network USB Adapter						
Test Mode: 802.11a, 5.2GHz Super						
Test Position Body	Antenna Position	Frequency		Conducted Peak Power (dBm)	SAR 1g (W/kg)	Limit (W/kg)
		Channel	MHz			
Front	Fixed	56	5280	16.09	0.789	1.6
Front	Fixed	64	5320	15.49	**	1.6
Back	Fixed	40	5200	13.56	0.586	1.6
Back	Fixed	44	5220	14.91	0.591	1.6
Back	Fixed	56	5280	16.09	1.205	1.6
Back	Fixed	64	5320	15.49	1.185	1.6
Top	Fixed	56	5280	16.09	0.541	1.6
Top	Fixed	64	5320	15.49	**	1.6
Note: The client declared that the EUT was only operated in EUT front.						

SAR MEASUREMENT						
Ambient Temperature (°C): 22.4 ± 2				Relative Humidity (%): 51		
Liquid Temperature (°C): 21.1 ± 2				Depth of Liquid (cm):>15		
Product: Wireless-AG (108MBPS) Network USB Adapter						
Test Mode: 802.11a, 5.8GHz						
Test Position Body	Antenna Position	Frequency		Conducted Peak Power (dBm)	SAR 1g (W/kg)	Limit (W/kg)
		Channel	MHz			
Front	Fixed	148	5740	13.31	**	1.6
Front	Fixed	160	5800	14.58	0.401	1.6
Front	Fixed	168	5840	14.10	**	1.6
Back	Fixed	148	5740	13.31	1.300	1.6
Back	Fixed	160	5800	14.58	1.314	1.6
Back	Fixed	168	5840	14.10	1.261	1.6
Top	Fixed	148	5740	13.31	**	1.6
Top	Fixed	160	5800	14.58	0.435	1.6
Top	Fixed	168	5840	14.10	**	1.6
Note: The client declared that the EUT was only operated in EUT front.						

SAR MEASUREMENT						
Ambient Temperature (°C): 22.4 ± 2				Relative Humidity (%): 51		
Liquid Temperature (°C): 21.1 ± 2				Depth of Liquid (cm):>15		
Product: Wireless-AG (108MBPS) Network USB Adapter						
Test Mode: 802.11a, 5.8GHz Super						
Test Position Body	Antenna Position	Frequency		Conducted Peak Power (dBm)	SAR 1g (W/kg)	Limit (W/kg)
		Channel	MHz			
Front	Fixed	152	5760	14.93	**	1.6
Front	Fixed	160	5800	15.01	0.401	1.6
Front	Fixed	164	5820	13.66	**	1.6
Back	Fixed	152	5760	14.93	1.287	1.6
Back	Fixed	160	5800	15.01	1.314	1.6
Back	Fixed	164	5820	13.66	1.267	1.6
Top	Fixed	152	5760	14.93	**	1.6
Top	Fixed	160	5800	15.01	0.435	1.6
Top	Fixed	164	5820	13.66	**	1.6
Note: The client declared that the EUT was only operated in EUT front.						

Appendix**Appendix A. SAR System Validation Data****Appendix B. SAR measurement Data****Appendix C. Test Setup Photographs & EUT Photographs****Appendix D. Probe Calibration Data****Appendix E. Dipole Calibration Data**

Appendix A. SAR System Validation DataALSAS-10U VER 2.3.2 APREL Laboratories
SAR Test ReportReport Date : 20-Dec-2007
Measurement Date : 20-Dec-2007

Product Data

Device Name : Dipole-2450
Type : Dipole
Frequency : 2450.00 MHz
Max. Transmit Pwr : 1 W
Drift Time : 0 min(s)
Length : 51.5 mm
Width : 3.6 mm
Depth : 30.4 mm
Power Drift-Start : 42.237 W/kg
Power Drift-Finish: 43.071 W/kg
Power Drift (%) : 1.976

Phantom Data

Type : Uni-Phantom
Size (mm) : 280 x 280 x 200
Location : Center

Tissue Data

Type : HEAD
Serial No. : 325-H
Frequency : 2450.00 MHz
Last Calib. Date : 20-Dec-2007
Temperature : 20.10 °C
Ambient Temp. : 21.60 °C
Humidity : 50.00 RH%
Epsilon : 38.33 F/m
Sigma : 1.816 S/m
Density : 1000.00 kg/cu. m

Probe Data

Name : Probe 264
Model : E020
Type : E-Field Triangle
Serial No. : 264
Last Calib. Date : 22-Aug-2007
Frequency : 2450.00 MHz
Duty Cycle Factor: 1
Conversion Factor: 5
Probe Sensitivity: 1.20 1.20 1.20 $\mu\text{V}/(\text{V}/\text{m})^2$
Compression Point: 95.00 mV
Offset : 1.56 mm

Measurement Data

Crest Factor : 1
Tissue Temp. : 20.10 °C
Ambient Temp. : 21.60 °C
Area Scan : 5x5x1 : Measurement x=12mm, y=12mm, z=4mm
Zoom Scan : 7x7x7 : Measurement x=5mm, y=5mm, z=5mm
Frequency : 2450 MHz

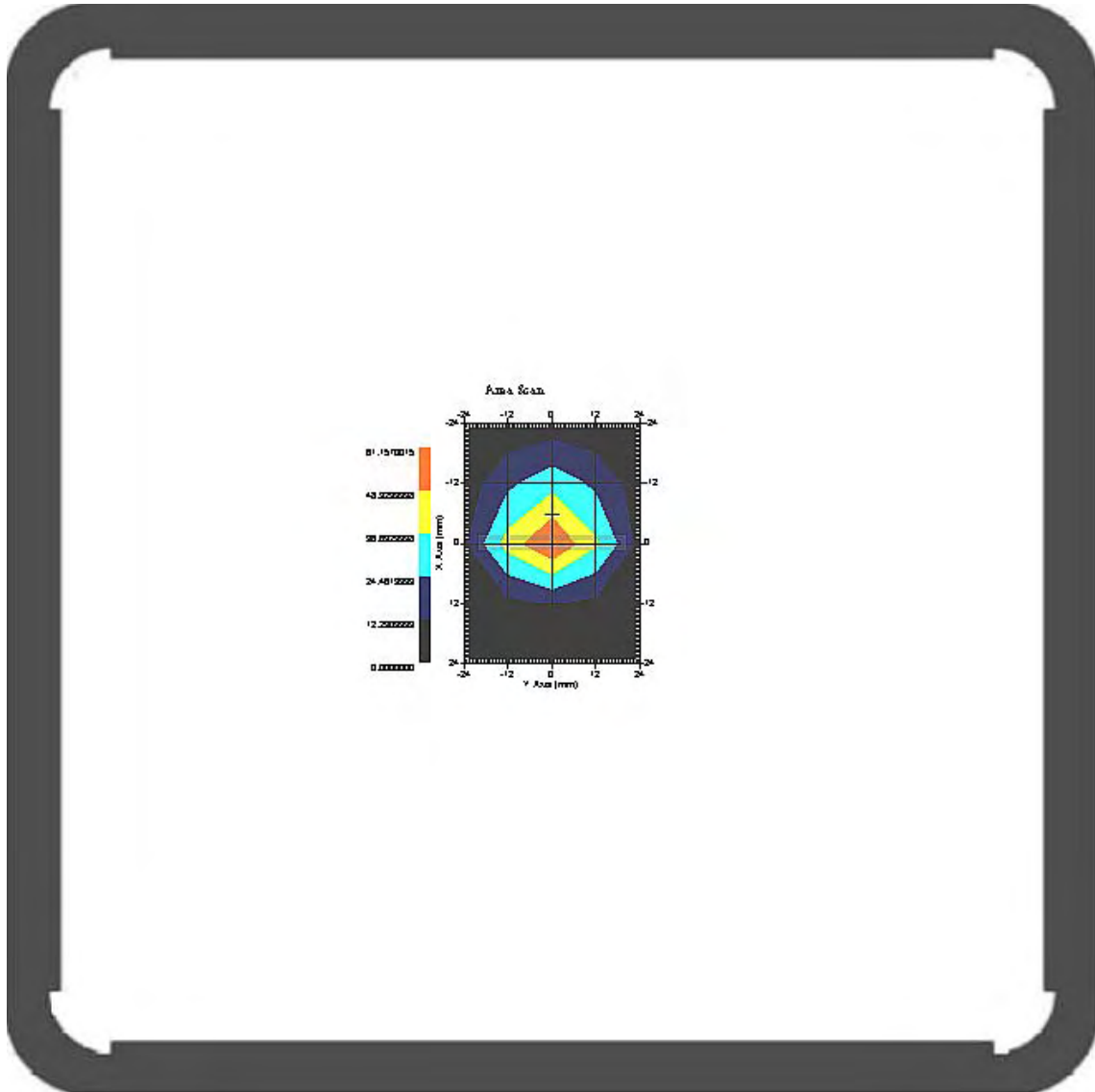

1 gram SAR value : 50.436 W/kg
10 gram SAR value : 24.414 W/kg
Area Scan Peak SAR : 61.157 W/kg
Zoom Scan Peak SAR : 103.890 W/kg

SAR-Z Axis
at Hotspot x:0.07 y:-0.01

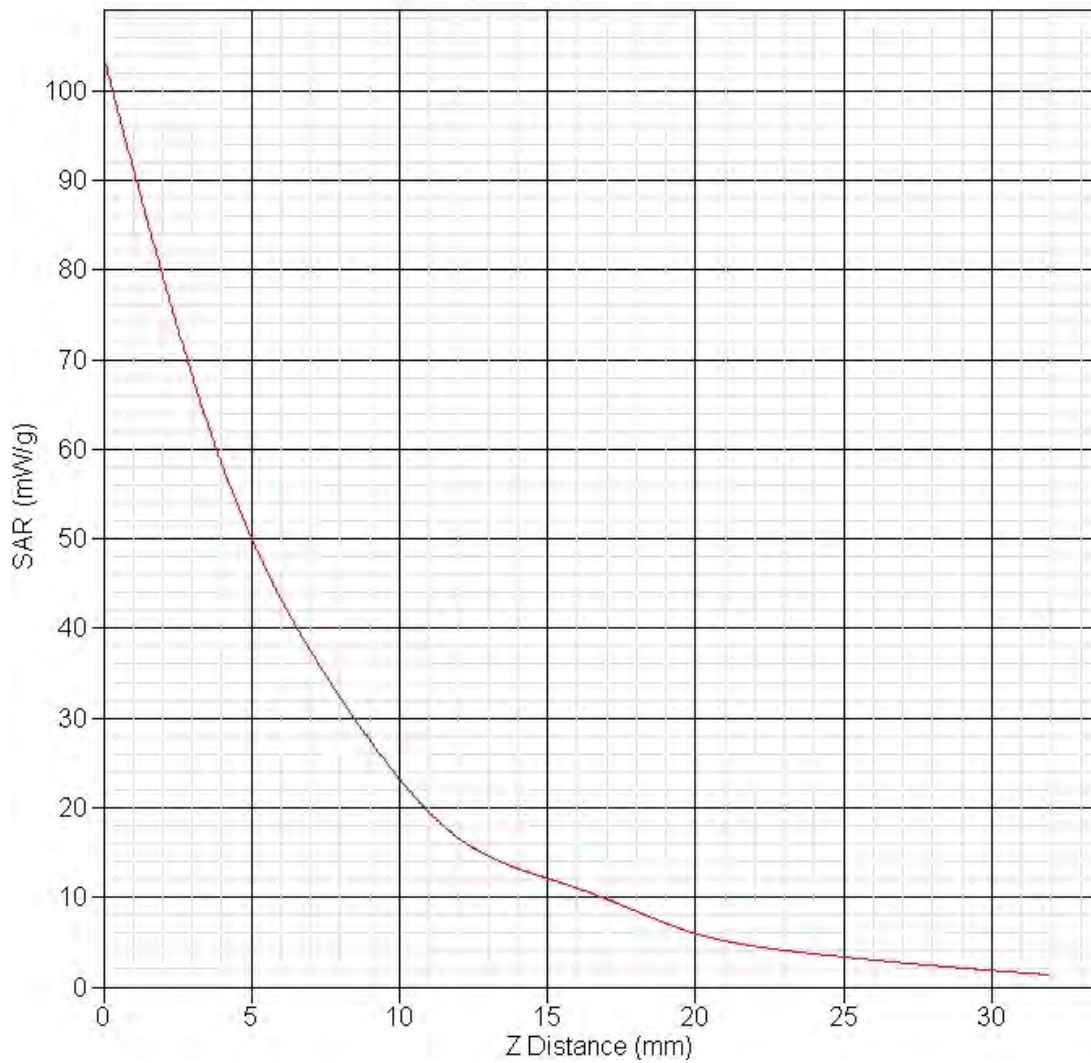

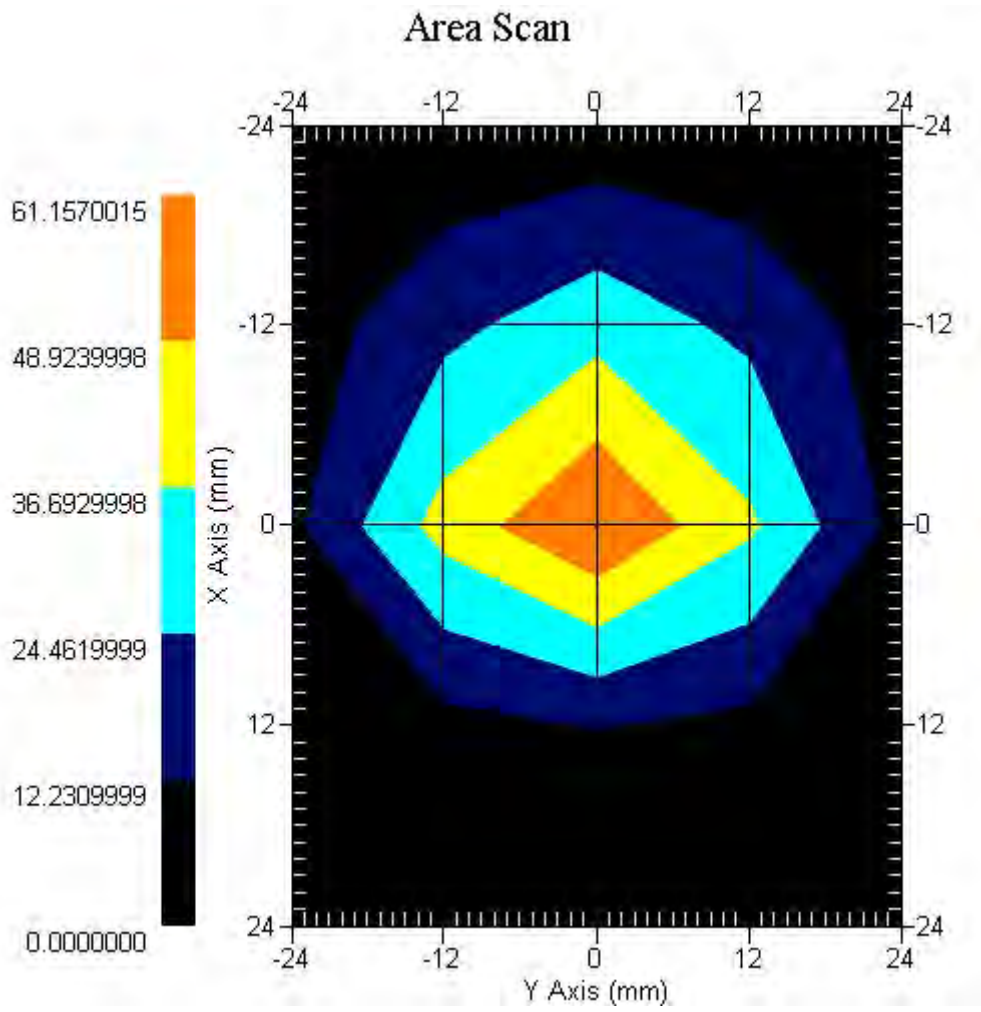

ALSAS-10U VER 2.3.2 APREL Laboratories SAR Test Report

Report Date : 18-Dec-2007
Measurement Date : 18-Dec-2007

Product Data

Device Name : Dipole-5200
Type : Dipole
Frequency : 5200.00 MHz
Max. Transmit Pwr : 1 W
Drift Time : 0 min(s)
Length : 23 mm
Width : 3.6 mm
Depth : 89.8 mm
Power Drift-Start : 41.170 W/kg
Power Drift-Finish: 42.516 W/kg
Power Drift (%) : 3.270

Phantom Data

Type : Uni-Phantom
Size (mm) : 280 x 280 x 200
Location : Center

Tissue Data

Type : HEAD
Serial No. : 326-H
Frequency : 5200.00 MHz
Last Calib. Date : 18-Dec-2007
Temperature : 21.10 °C
Ambient Temp. : 22.40 °C
Humidity : 51.00 RH%
Epsilon : 38.66 F/m
Sigma : 5.014 S/m
Density : 1000.00 kg/cu. m

Probe Data

Name : Probe 264
Model : E020
Type : E-Field Triangle
Serial No. : 264
Last Calib. Date : 22-Aug-2007
Frequency : 5200.00 MHz
Duty Cycle Factor: 1
Conversion Factor: 4.5
Probe Sensitivity: 0.61 0.61 0.61 $\mu\text{V}/(\text{V}/\text{m})^2$
Compression Point: 95.00 mV
Offset : 1.56 mm

Measurement Data

Crest Factor : 1
Tissue Temp. : 21.10 °C
Ambient Temp. : 22.40 °C
Area Scan : 5x5x1 : Measurement x=12mm, y=12mm, z=4mm
Zoom Scan : 7x7x7 : Measurement x=5mm, y=5mm, z=5mm
Frequency : 5200 MHz

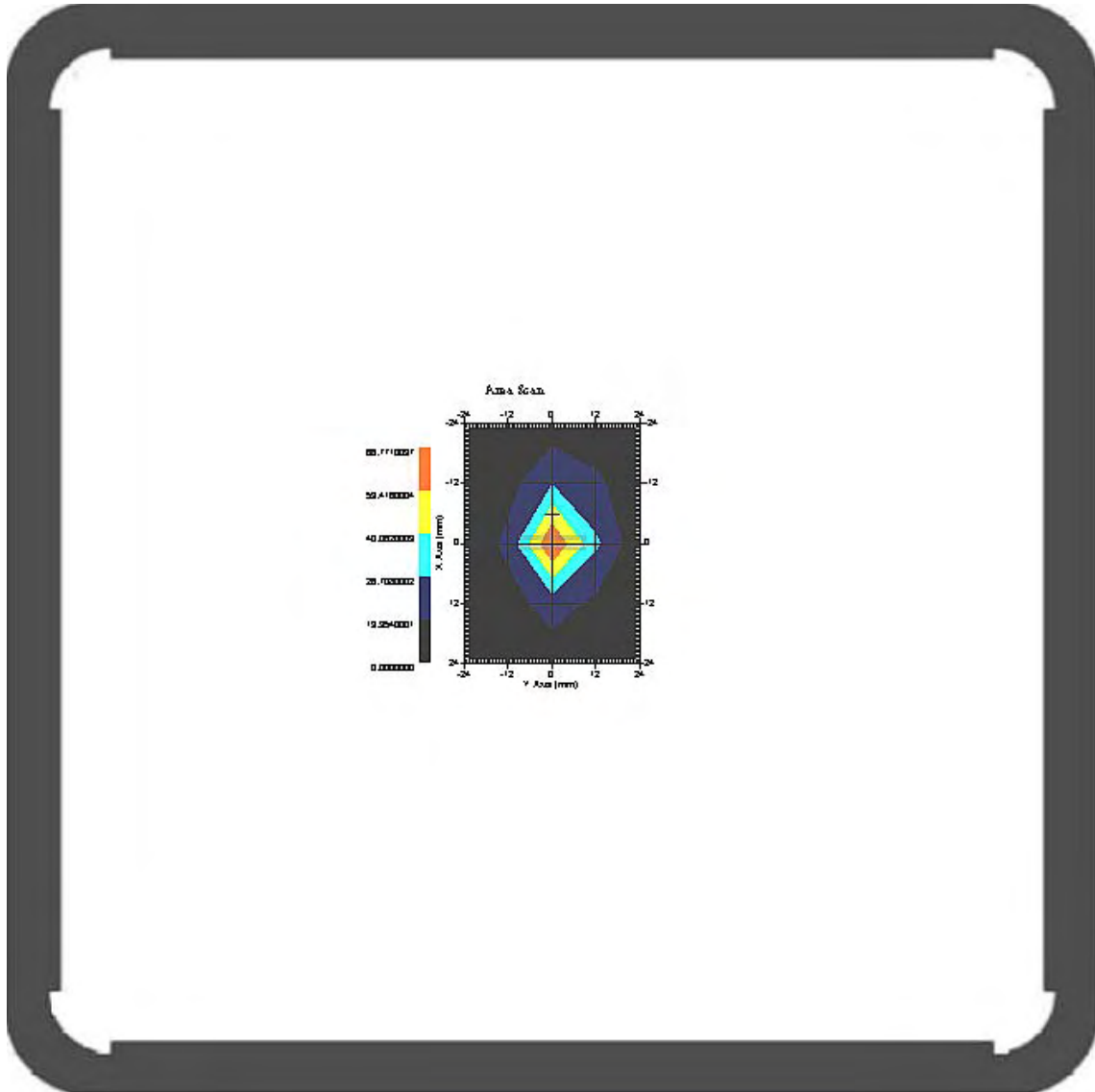

1 gram SAR value : 57.661 W/kg
10 gram SAR value : 21.115 W/kg
Area Scan Peak SAR : 66.771 W/kg
Zoom Scan Peak SAR : 169.139 W/kg

SAR-Z Axis
at Hotspot x:0.07 y:-0.01

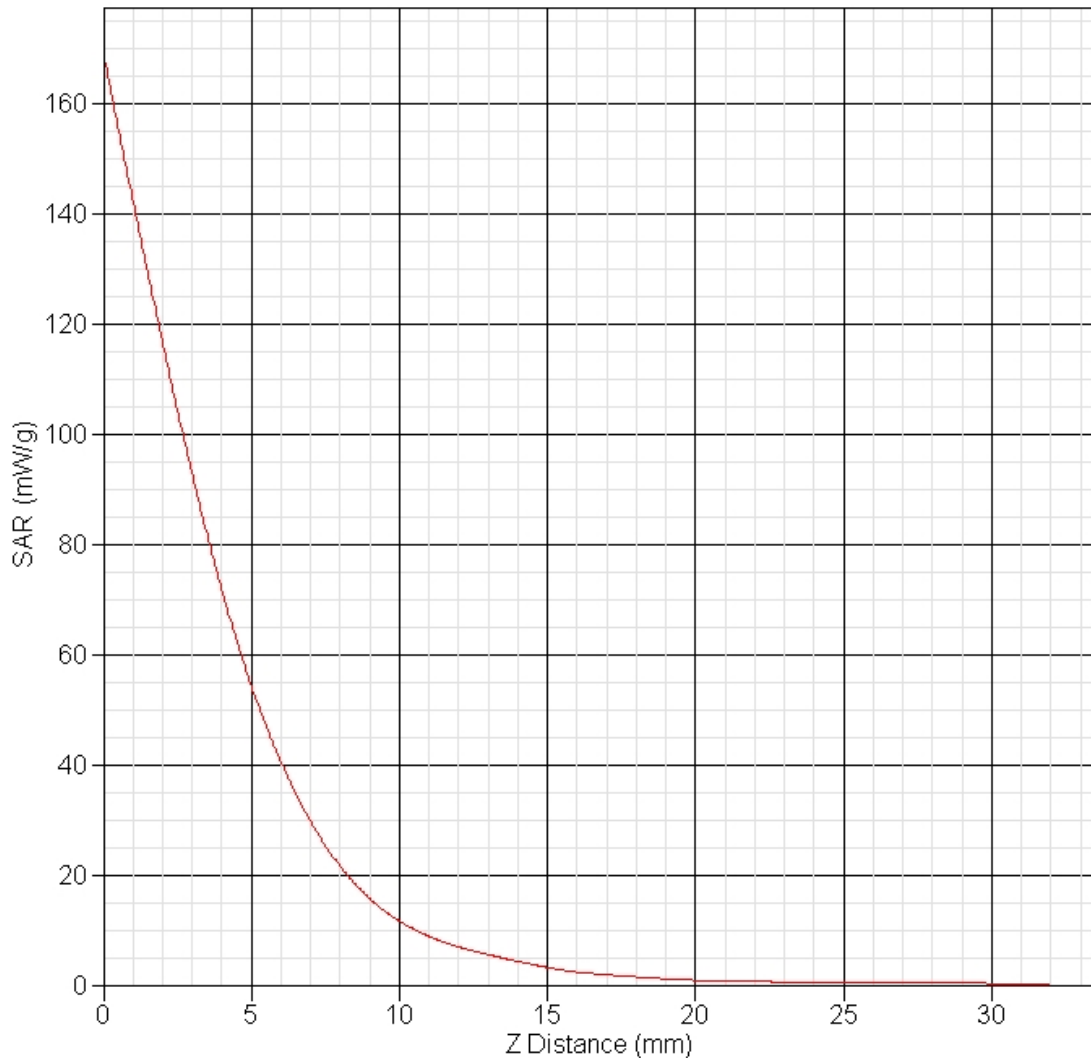

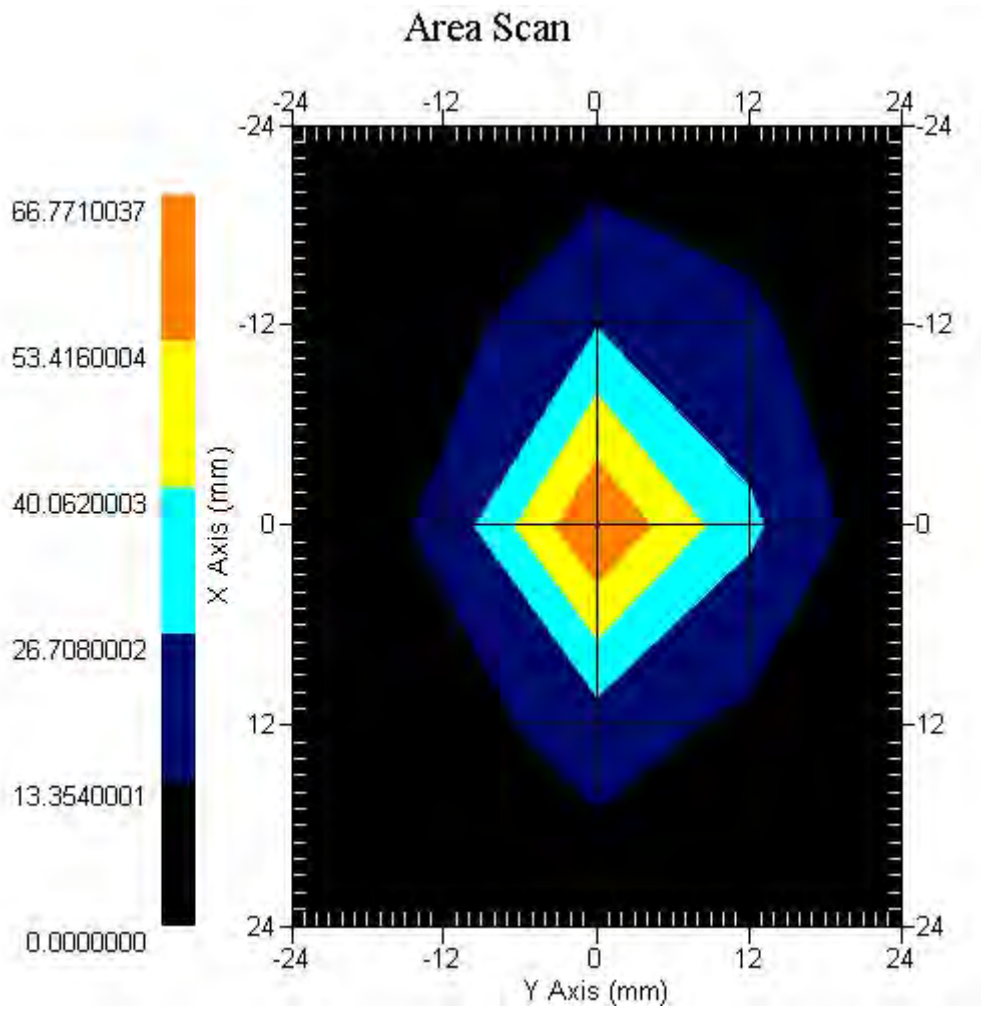

ALSAS-10U VER 2.3.2 APREL Laboratories SAR Test Report

Report Date : 17-Dec-2007
Measurement Date : 17-Dec-2007

Product Data

Device Name : Dipole-5800
Type : Dipole
Frequency : 5800.00 MHz
Max. Transmit Pwr : 1 W
Drift Time : 0 min(s)
Length : 21.4 mm
Width : 3.6 mm
Depth : 89.8 mm
Power Drift-Start : 37.013 W/kg
Power Drift-Finish: 37.473 W/kg
Power Drift (%) : 1.242

Phantom Data

Type : Uni-Phantom
Size (mm) : 280 x 280 x 200
Location : Center

Tissue Data

Type : HEAD
Serial No. : 327-H
Frequency : 5800.00 MHz
Last Calib. Date : 17-Dec-2007
Temperature : 21.10 °C
Ambient Temp. : 22.40 °C
Humidity : 51.00 RH%
Epsilon : 36.07 F/m
Sigma : 6.317 S/m
Density : 1000.00 kg/cu. m

Probe Data

Name : Probe 264
Model : E020
Type : E-Field Triangle
Serial No. : 264
Last Calib. Date : 23-Aug-2007
Frequency : 5800.00 MHz
Duty Cycle Factor: 1
Conversion Factor: 3.3
Probe Sensitivity: 0.61 0.61 0.61 $\mu\text{V}/(\text{V}/\text{m})^2$
Compression Point: 95.00 mV
Offset : 1.56 mm

Measurement Data

Crest Factor : 1
Tissue Temp. : 21.10 °C
Ambient Temp. : 22.40 °C
Area Scan : 5x5x1 : Measurement x=12mm, y=12mm, z=4mm
Zoom Scan : 7x7x7 : Measurement x=5mm, y=5mm, z=5mm
Frequency : 5800 MHz

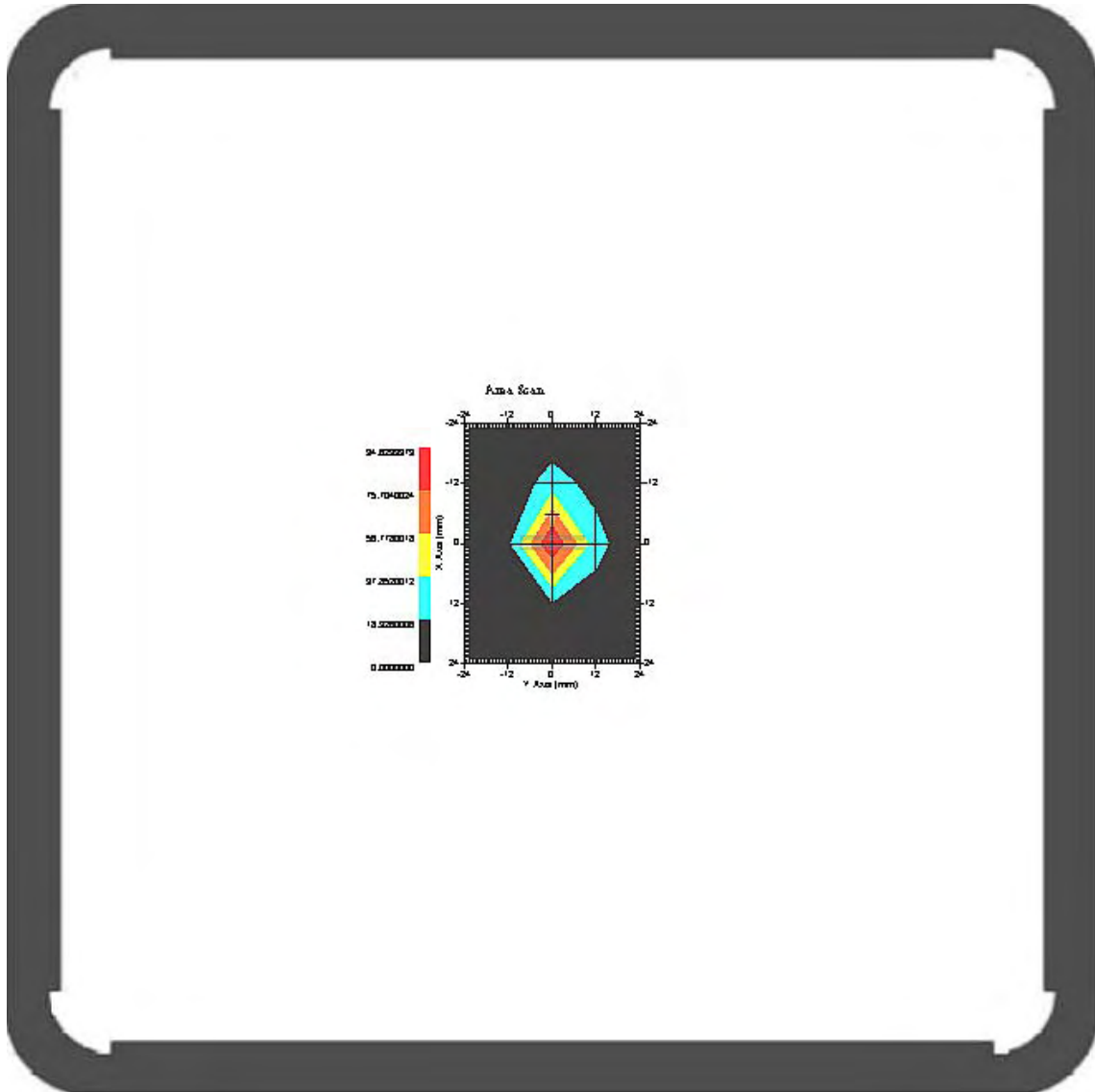

1 gram SAR value : 58.114 W/kg
10 gram SAR value : 20.154 W/kg
Area Scan Peak SAR : 94.630 W/kg
Zoom Scan Peak SAR : 214.174 W/kg

SAR-Z Axis
at Hotspot x:0.08 y:-0.01

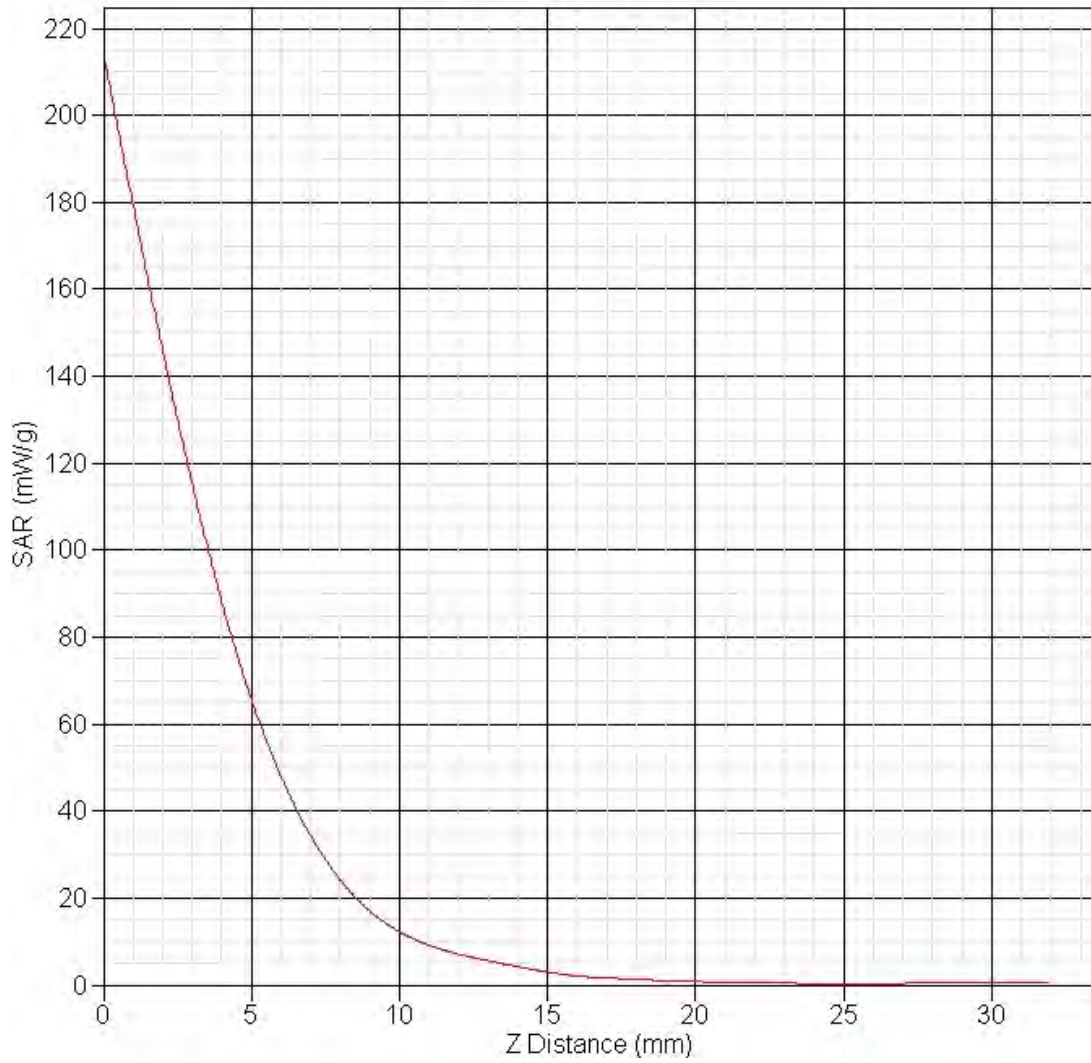

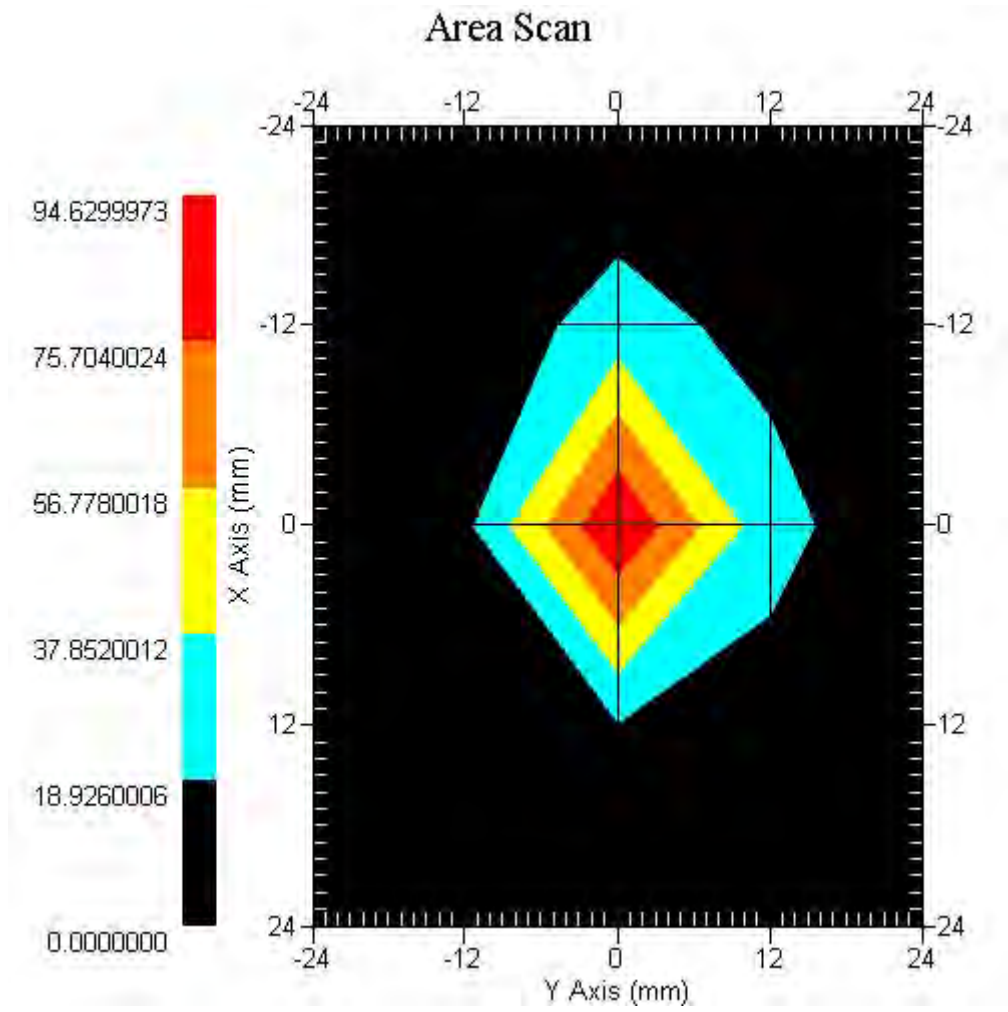

Appendix B. SAR measurement Data

ALSAS-10U VER 2.3.2 APREL Laboratories

SAR Test Report -802.11b

Report Date : 20-Dec-2007
Measurement Date : 20-Dec-2007

Product Data

Device Name : USB
Type : Other
Model : WLU108AG-MC
Frequency : 2450.00 MHz
Drift Time : 0 min(s)
Length : 82 mm
Width : 27 mm
Depth : 8 mm
Antenna Type : Internal

Phantom Data

Type : Uni-Phantom
Size (mm) : 280 x 280 x 200
Location : Center

Tissue Data

Type : BODY
Serial No. : 325-B
Frequency : 2450.00 MHz
Last Calib. Date : 20-Dec-2007
Temperature : 20.10 °C
Ambient Temp. : 21.60 °C
Humidity : 50.00 RH%
Epsilon : 53.41 F/m
Sigma : 1.868 S/m
Density : 1000.00 kg/cu. m

Probe Data

Name : Probe 264
Model : E020
Type : E-Field Triangle
Serial No. : 264
Last Calib. Date : 21-Aug-2007
Frequency : 2450.00 MHz
Duty Cycle Factor: 1
Conversion Factor: 5.2
Probe Sensitivity: 1.20 1.20 1.20 $\mu\text{V}/(\text{V}/\text{m})^2$
Compression Point: 95.00 mV
Offset : 1.56 mm

Measurement Data

Crest Factor : 1
Tissue Temp. : 20.10 °C
Ambient Temp. : 21.60 °C
Area Scan : 5x5x1 : Measurement x=12mm, y=12mm, z=4mm
Zoom Scan : 7x7x7 : Measurement x=5mm, y=5mm, z=5mm
Power Drift-Start : 0.079 W/kg
Power Drift-Finish: 0.080 W/kg
Power Drift (%) : 1.265

DUT Position : Touch EUT Front
Channel : 6

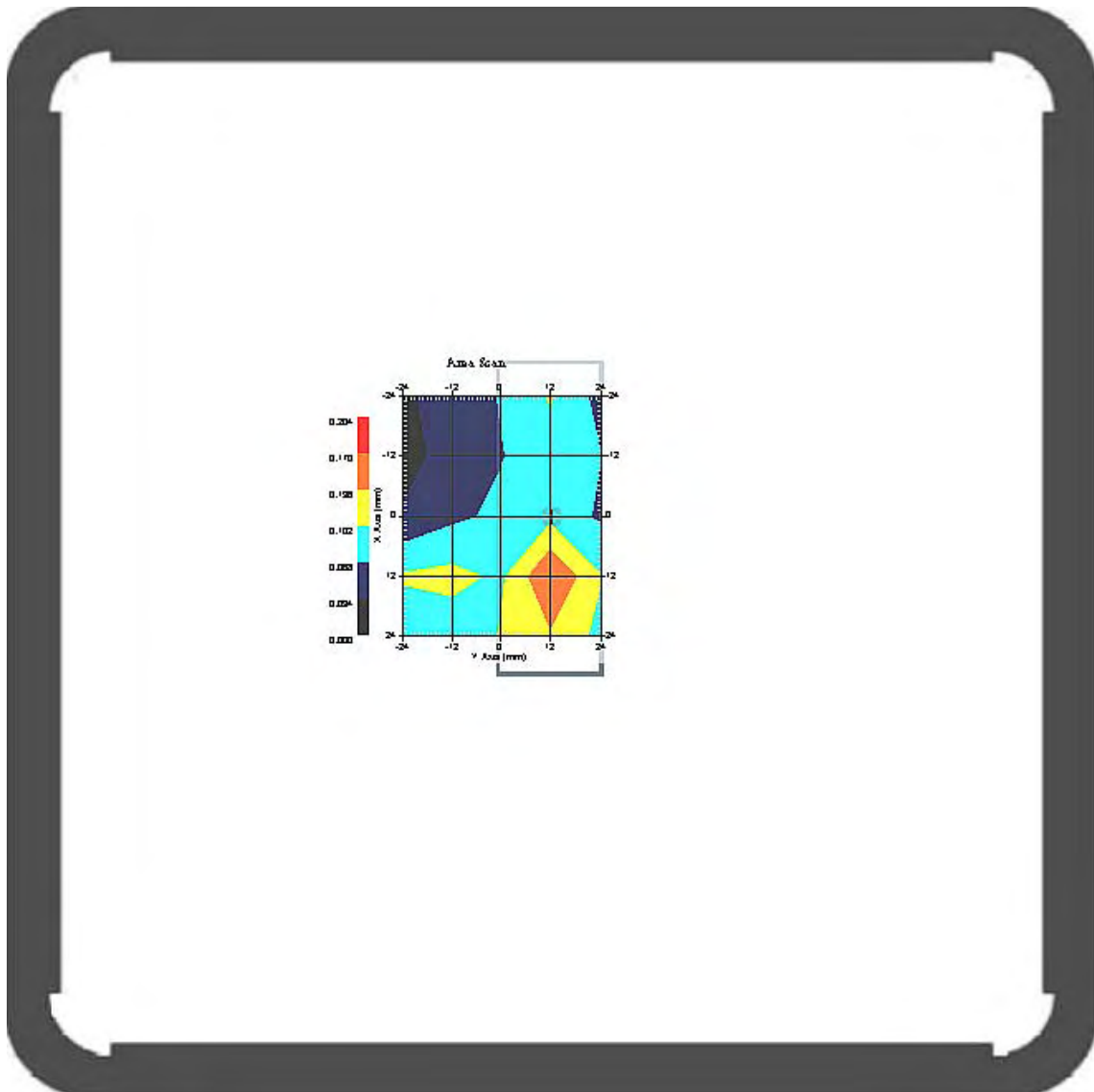

1 gram SAR value : 0.185 W/kg
10 gram SAR value : 0.133 W/kg
Area Scan Peak SAR : 0.204 W/kg
Zoom Scan Peak SAR : 0.650 W/kg

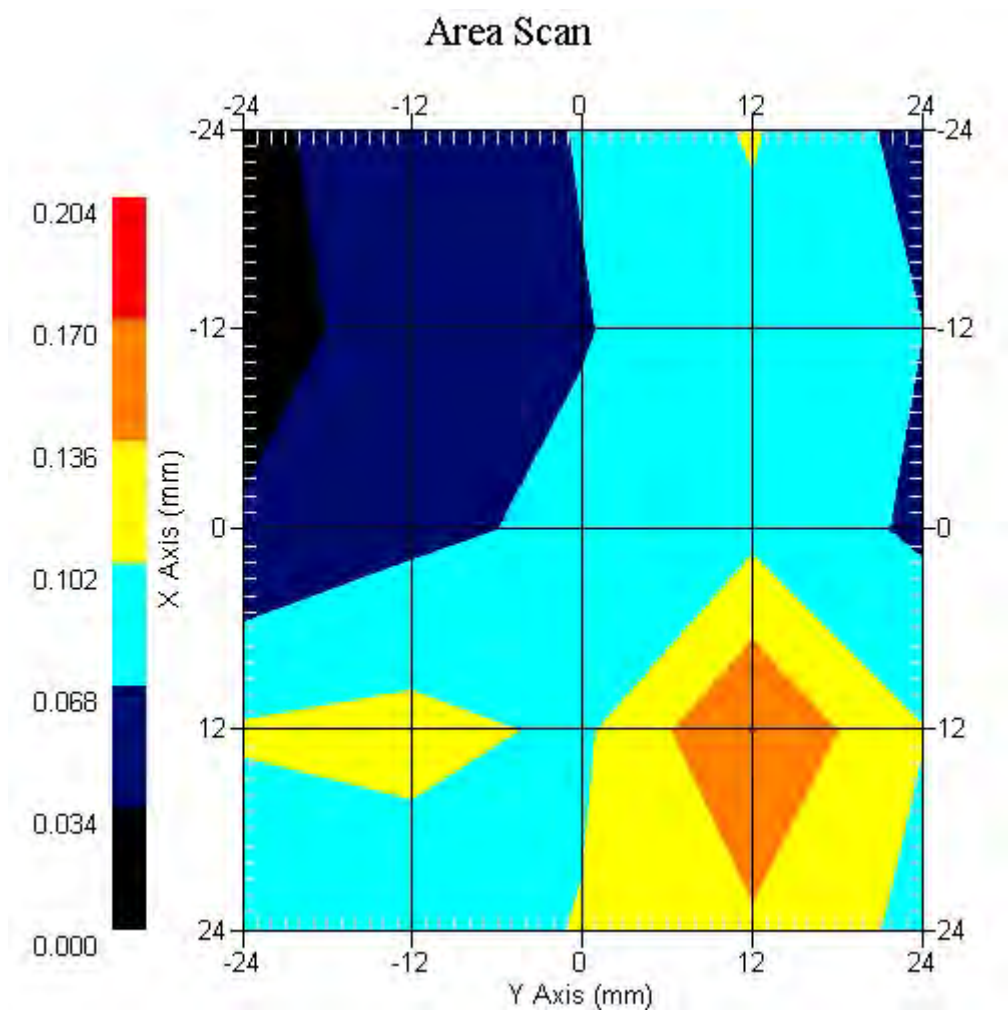

Measurement Data

Crest Factor : 1
Tissue Temp. : 20.40 °C
Ambient Temp. : 21.60 °C
Area Scan : 5x5x1 : Measurement x=12mm, y=12mm, z=4mm
Zoom Scan : 7x7x7 : Measurement x=5mm, y=5mm, z=5mm
Power Drift-Start : 0.636 W/kg
Power Drift-Finish: 0.627 W/kg
Power Drift (%) : -1.441

DUT Position : Touch EUT Back
Channel : 1

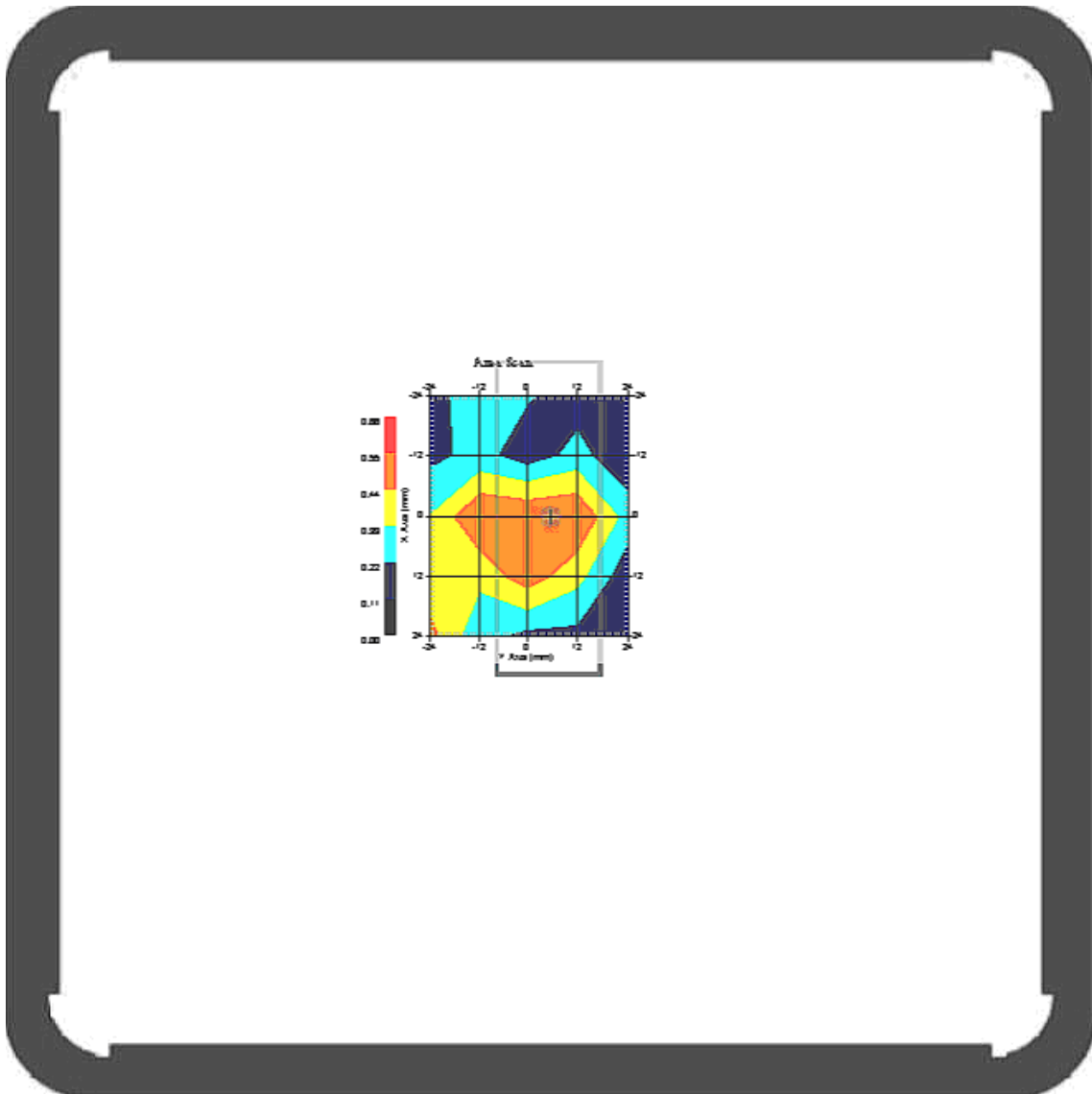

1 gram SAR value : 0.542 W/kg
10 gram SAR value : 0.227 W/kg
Area Scan Peak SAR : 0.660 W/kg
Zoom Scan Peak SAR : 1.451 W/kg

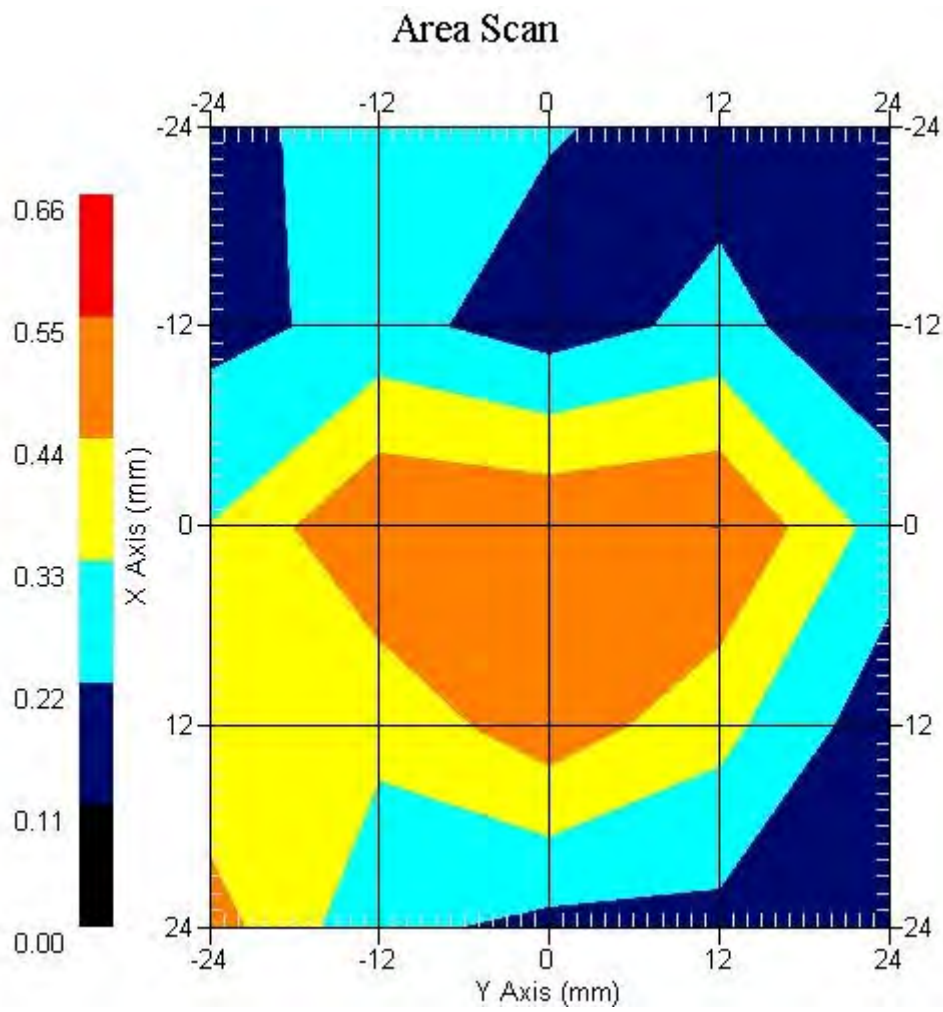

Measurement Data

Crest Factor : 1
Tissue Temp. : 20.40 °C
Ambient Temp. : 21.60 °C
Area Scan : 5x5x1 : Measurement x=12mm, y=12mm, z=4mm
Zoom Scan : 7x7x7 : Measurement x=5mm, y=5mm, z=5mm
Power Drift-Start : 0.111 W/kg
Power Drift-Finish: 0.113 W/kg
Power Drift (%) : 1.801

DUT Position : Touch EUT Back
Channel : 6

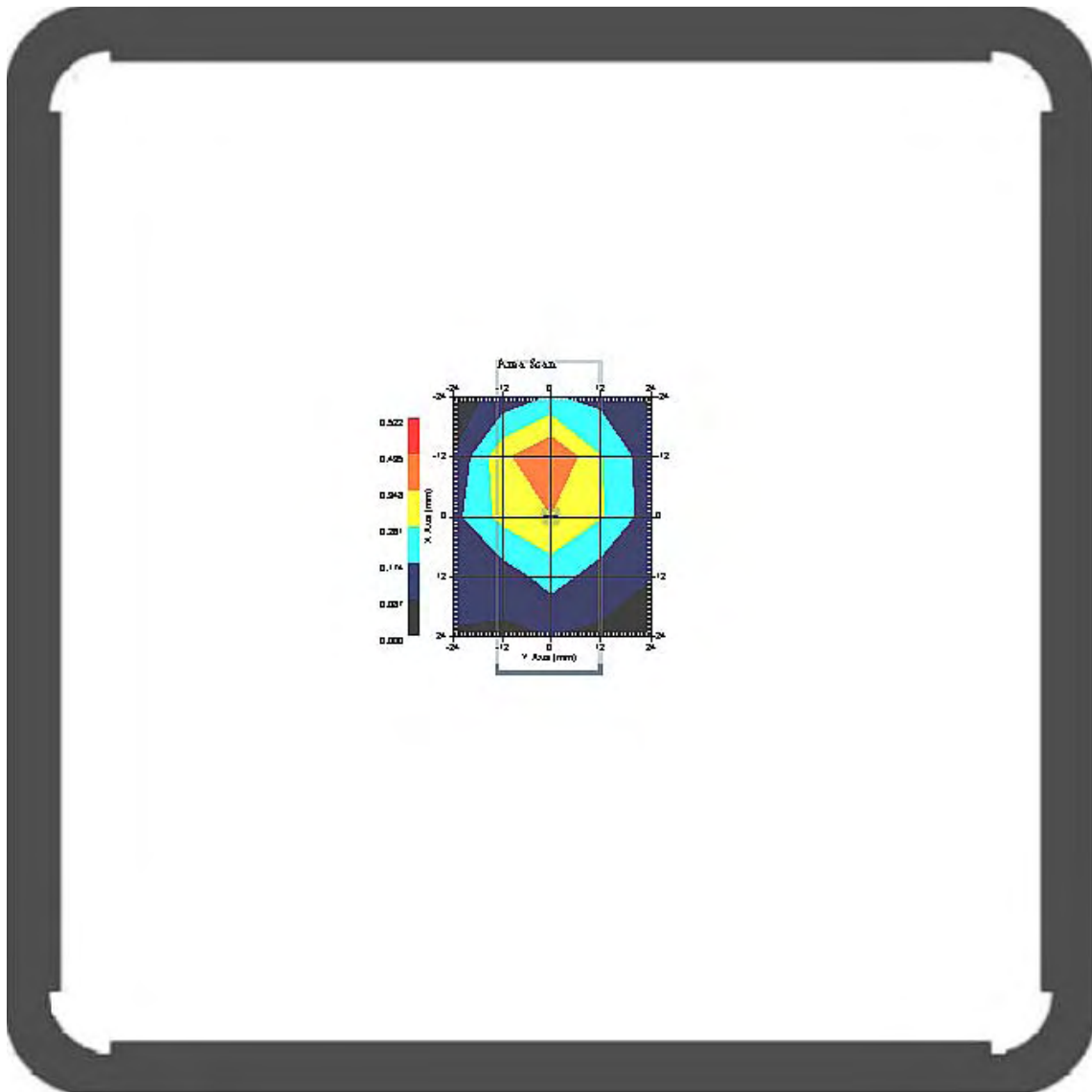

1 gram SAR value : 0.476 W/kg
10 gram SAR value : 0.198 W/kg
Area Scan Peak SAR : 0.522 W/kg
Zoom Scan Peak SAR : 0.590 W/kg

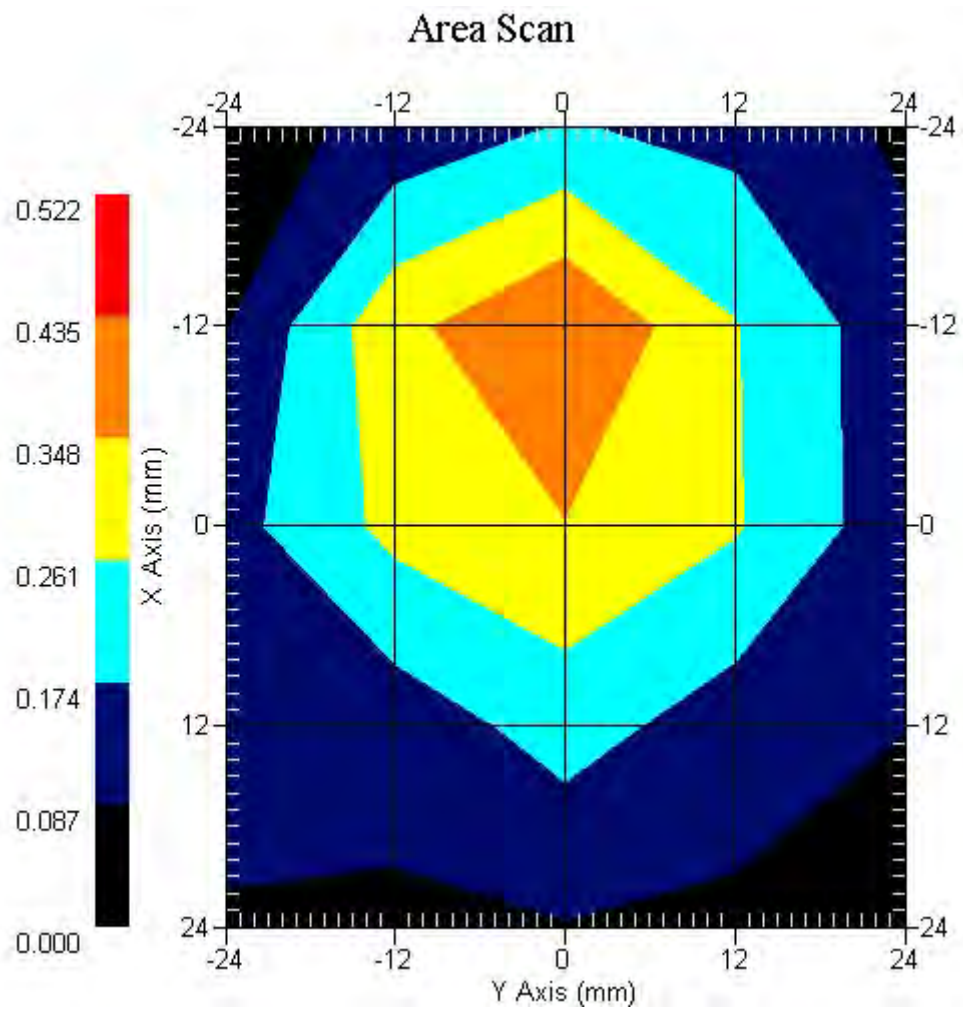

Measurement Data

Crest Factor : 1
Tissue Temp. : 20.90 °C
Ambient Temp. : 22.10 °C
Area Scan : 5x5x1 : Measurement x=12mm, y=12mm, z=4mm
Zoom Scan : 7x7x7 : Measurement x=5mm, y=5mm, z=5mm
Power Drift-Start : 0.577 W/kg
Power Drift-Finish: 0.559 W/kg
Power Drift (%) : -3.220

DUT Position : Touch EUT Back
Channel : 11

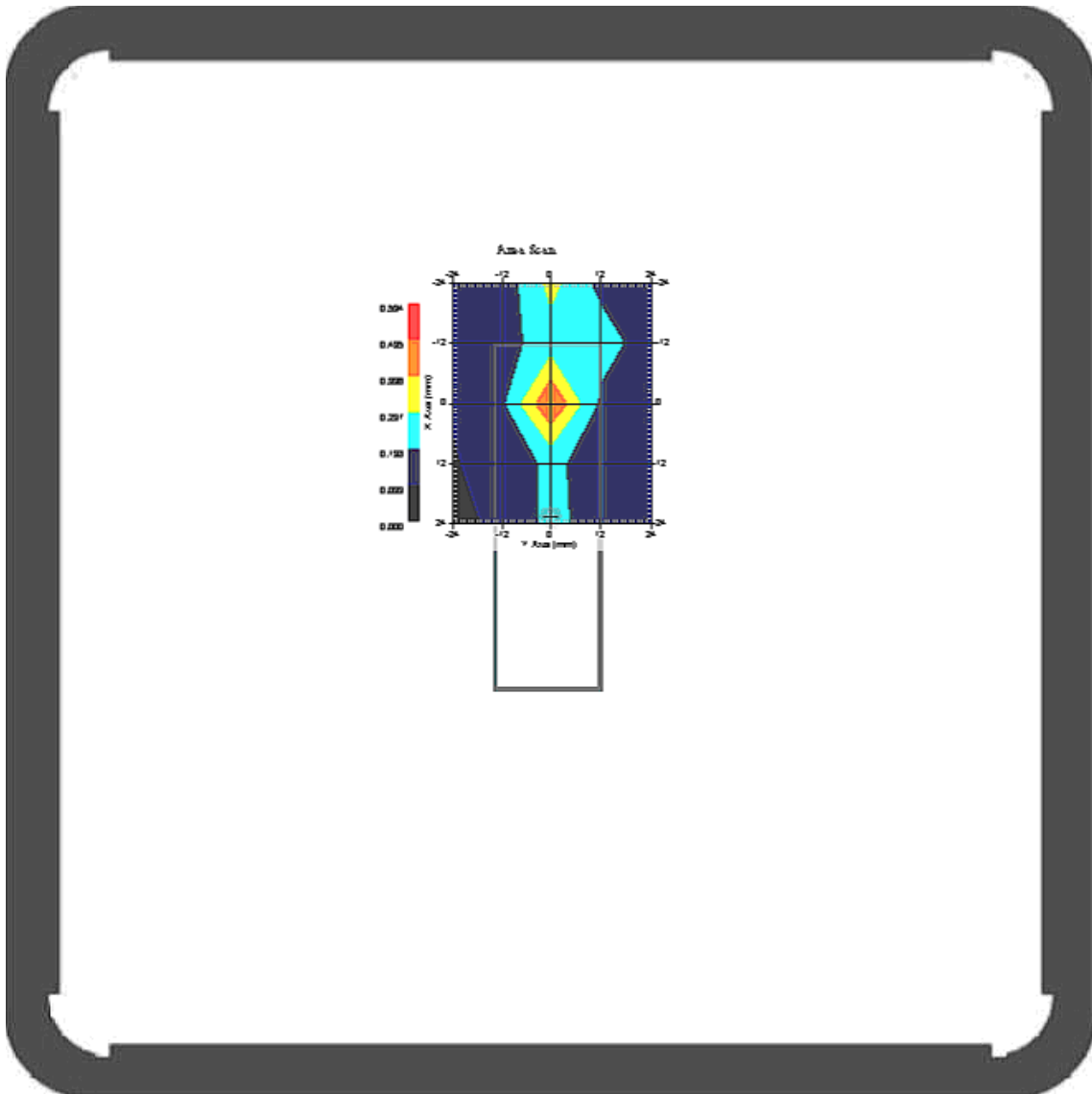

1 gram SAR value : 0.507 W/kg
10 gram SAR value : 0.172 W/kg
Area Scan Peak SAR : 0.594 W/kg
Zoom Scan Peak SAR : 0.820 W/kg

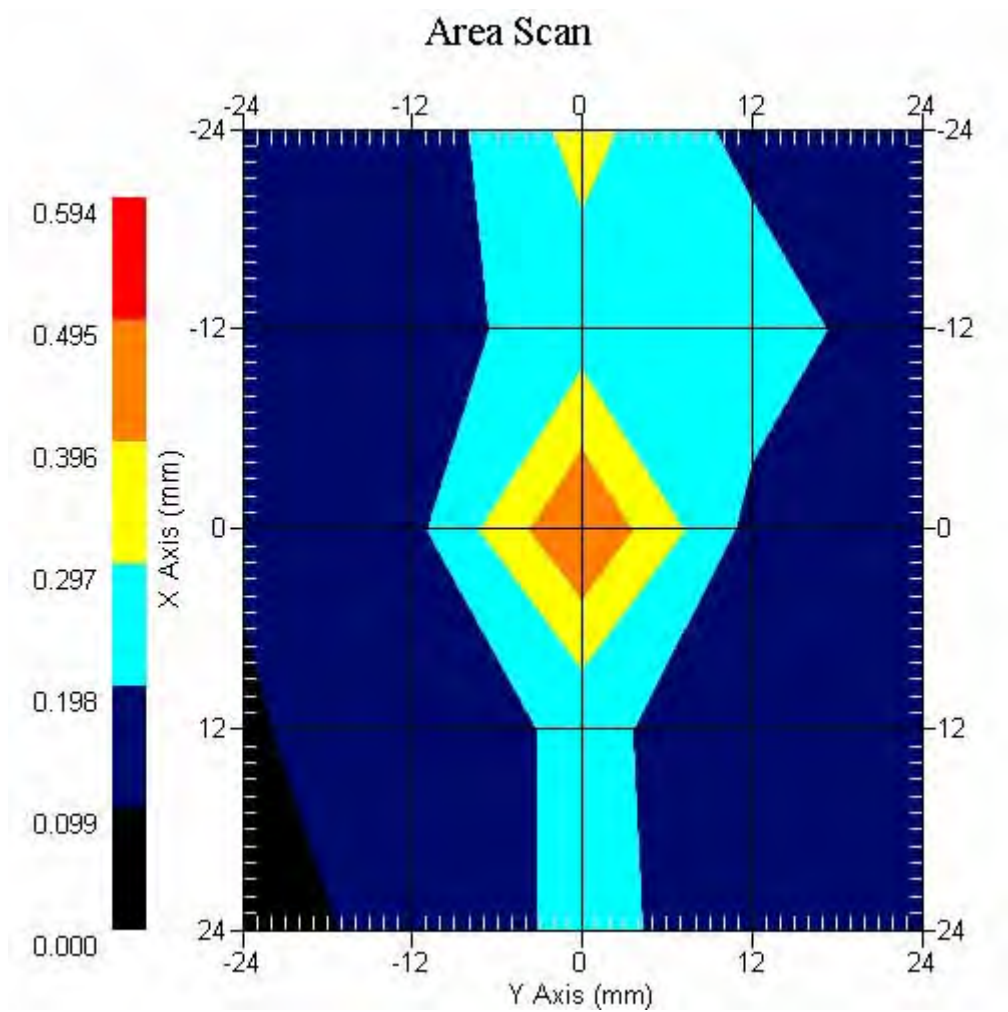

Measurement Data

Crest Factor : 1
Tissue Temp. : 20.10 °C
Ambient Temp. : 21.60 °C
Area Scan : 5x5x1 : Measurement x=12mm, y=12mm, z=4mm
Zoom Scan : 7x7x7 : Measurement x=5mm, y=5mm, z=5mm
Power Drift-Start : 0.636 W/kg
Power Drift-Finish: 0.627 W/kg
Power Drift (%) : -1.441

DUT Position : Touch EUT Top
Channel : 6

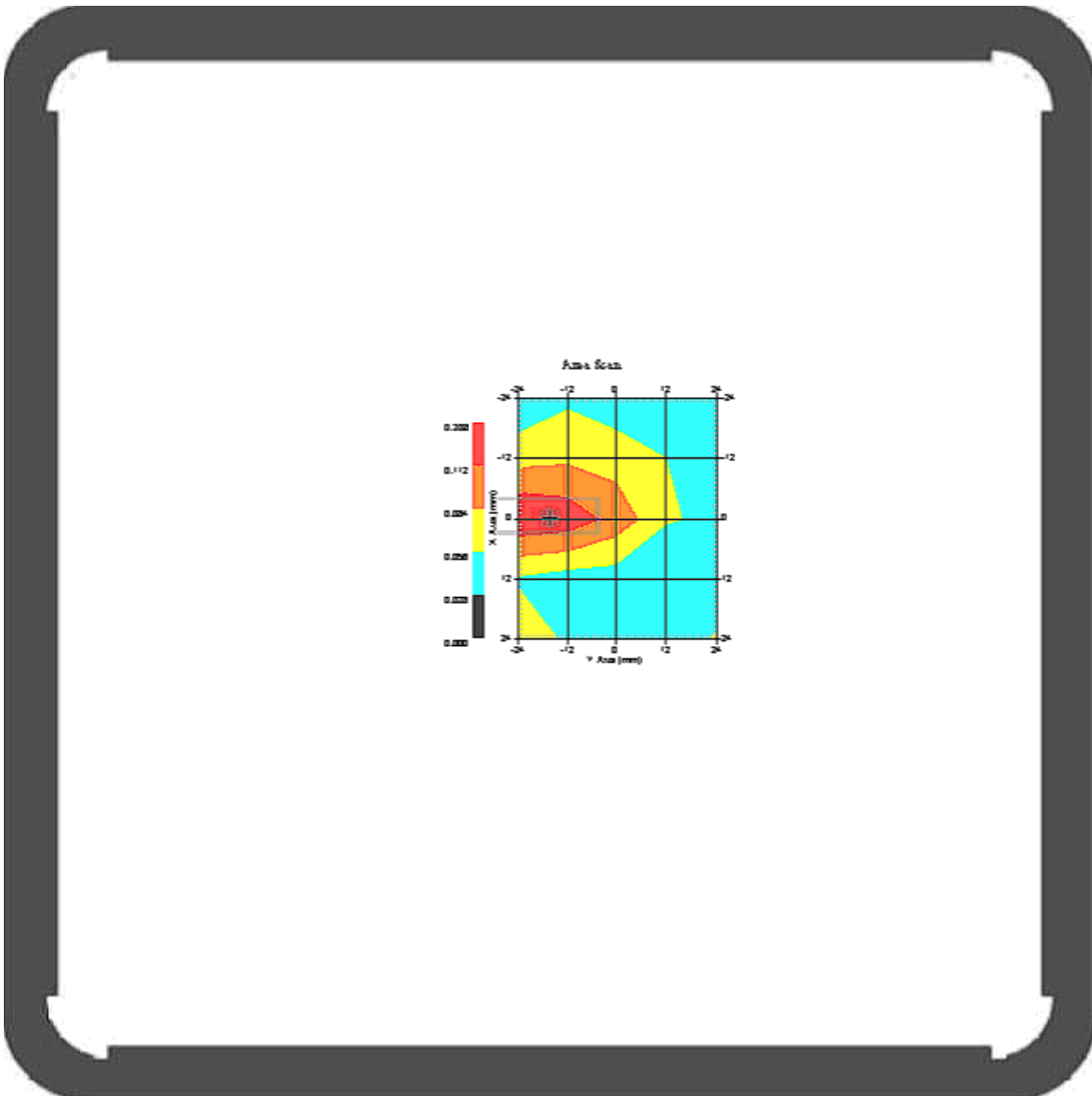

1 gram SAR value : 0.191 W/kg
10 gram SAR value : 0.227 W/kg
Area Scan Peak SAR : 0.195 W/kg
Zoom Scan Peak SAR : 1.451 W/kg

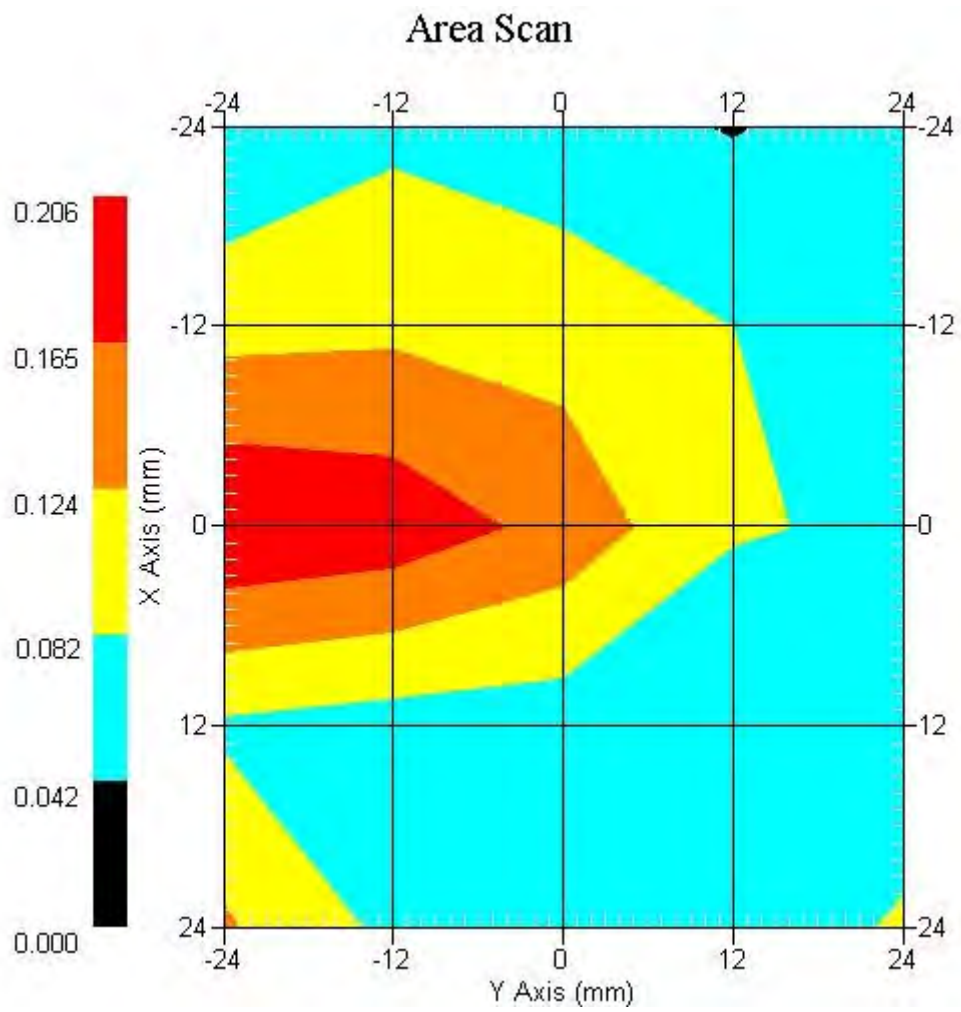

802.11b with EUT Back, Z-Axis plot

channel: 1

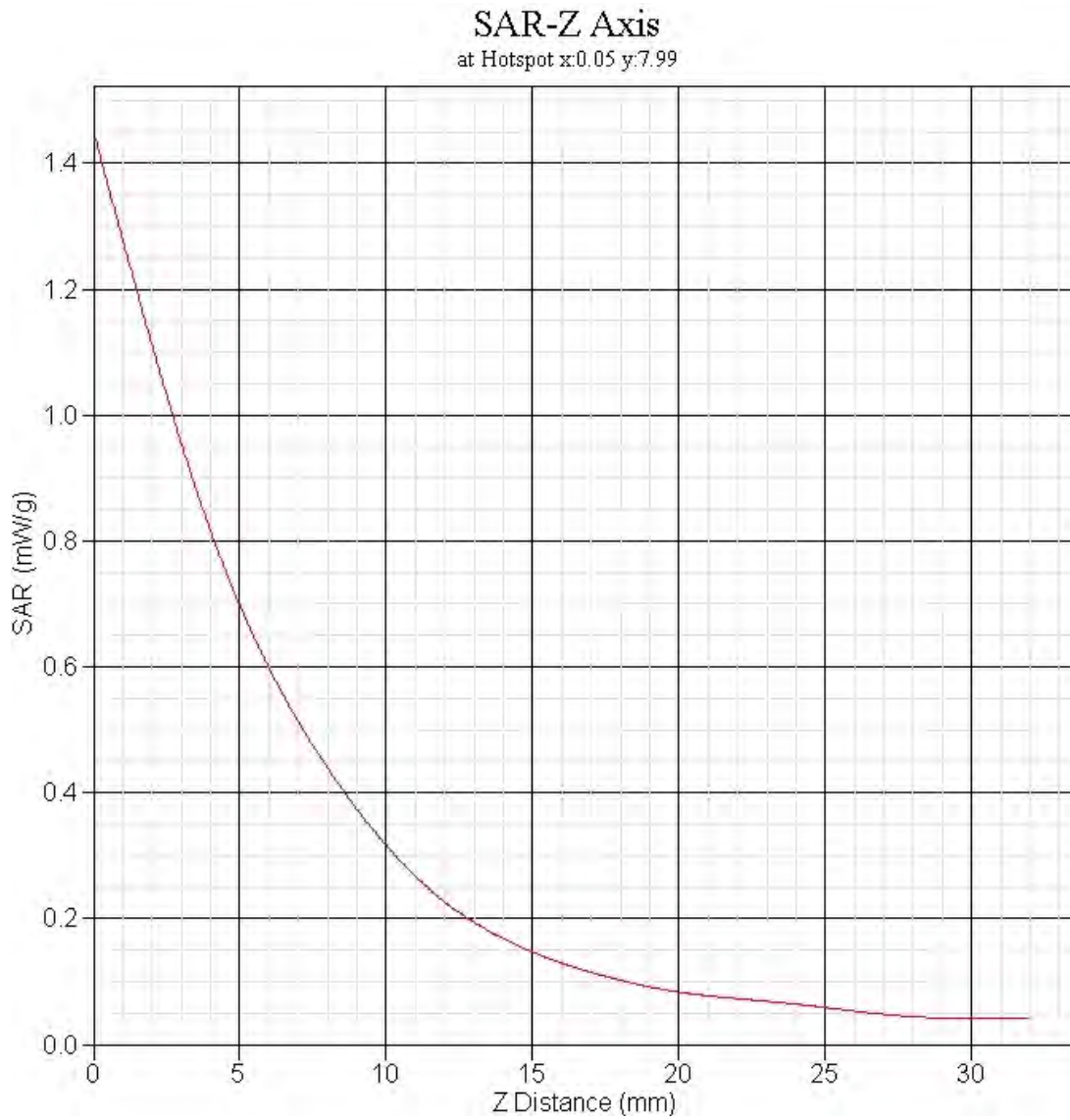

ALSAS-10U VER 2.3.2 APREL Laboratories

SAR Test Report -802.11g

Report Date : 20-Dec-2007
Measurement Date : 20-Dec-2007

Product Data

Device Name : USB
Type : Other
Model : WLU108AG-MC
Frequency : 2450.00 MHz
Drift Time : 0 min(s)
Length : 82 mm
Width : 27 mm
Depth : 8 mm
Antenna Type : Internal

Phantom Data

Type : Uni-Phantom
Size (mm) : 280 x 280 x 200
Location : Center

Tissue Data

Type : BODY
Serial No. : 325-B
Frequency : 2450.00 MHz
Last Calib. Date : 20-Dec-2007
Temperature : 20.10 °C
Ambient Temp. : 21.60 °C
Humidity : 50.00 RH%
Epsilon : 53.41 F/m
Sigma : 1.868 S/m
Density : 1000.00 kg/cu. m

Probe Data

Name : Probe 264
Model : E020
Type : E-Field Triangle
Serial No. : 264
Last Calib. Date : 21-Aug-2007
Frequency : 2450.00 MHz
Duty Cycle Factor: 1
Conversion Factor: 5.2
Probe Sensitivity: 1.20 1.20 1.20 $\mu\text{V}/(\text{V}/\text{m})^2$
Compression Point: 95.00 mV
Offset : 1.56 mm

Measurement Data

Crest Factor : 1
Tissue Temp. : 20.10 °C
Ambient Temp. : 21.60 °C
Area Scan : 5x5x1 : Measurement x=12mm, y=12mm, z=4mm
Zoom Scan : 7x7x7 : Measurement x=5mm, y=5mm, z=5mm
Power Drift-Start : 0.056 W/kg
Power Drift-Finish: 0.058 W/kg
Power Drift (%) : 3.448

DUT Position : Touch EUT Front
Channel : 6

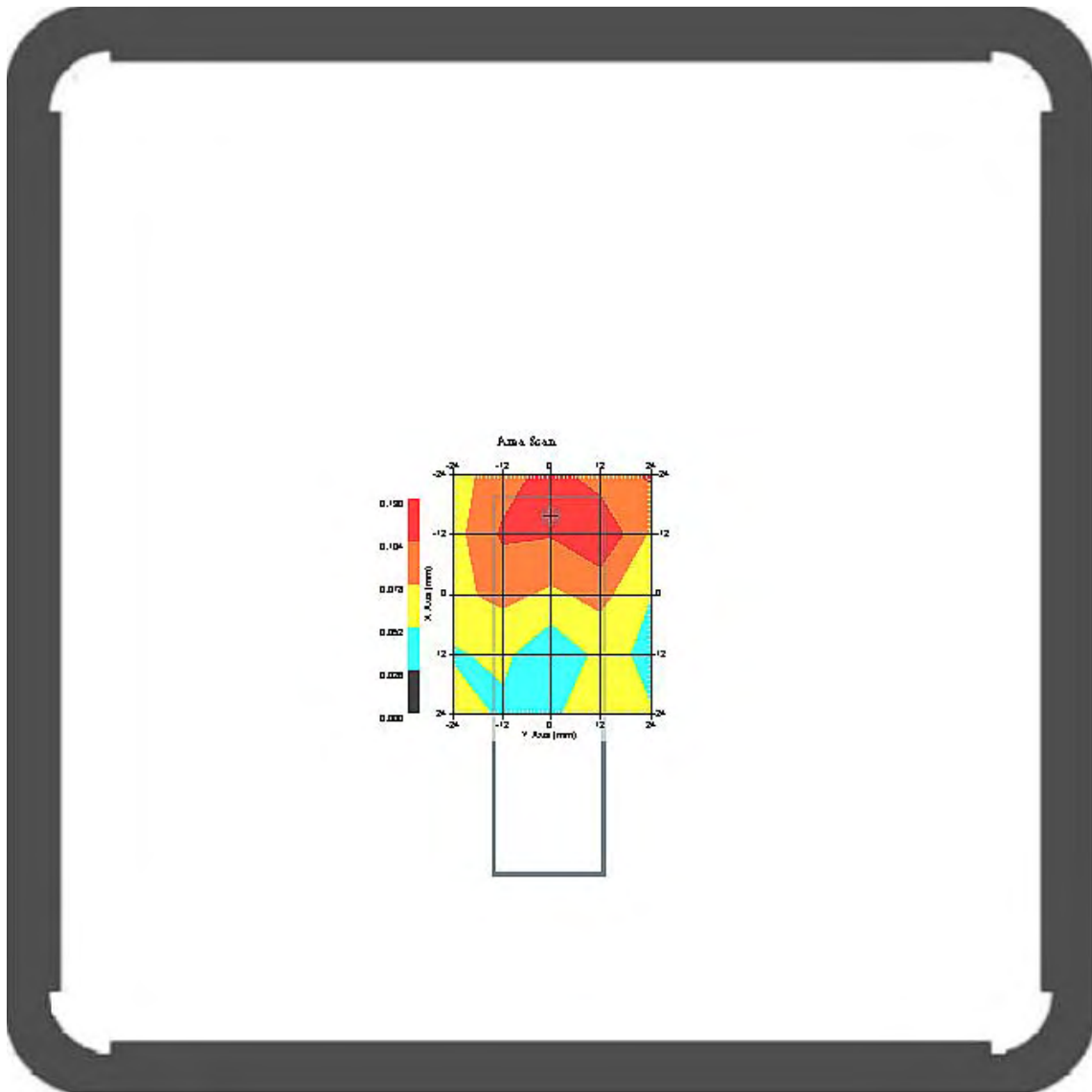

1 gram SAR value : 0.093 W/kg
10 gram SAR value : 0.140 W/kg
Area Scan Peak SAR : 0.130 W/kg
Zoom Scan Peak SAR : 0.201 W/kg

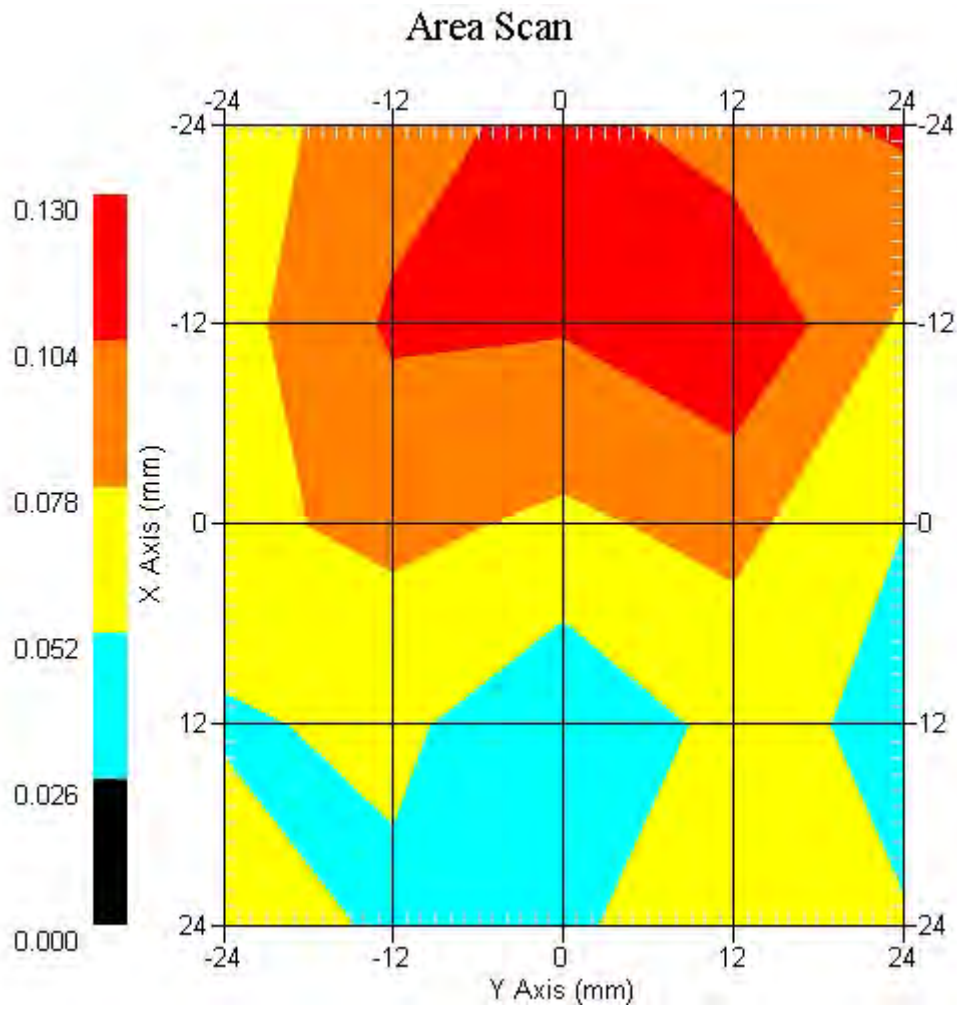

Measurement Data

Crest Factor : 1
Tissue Temp. : 20.10 °C
Ambient Temp. : 21.60 °C
Area Scan : 5x5x1 : Measurement x=12mm, y=12mm, z=4mm
Zoom Scan : 7x7x7 : Measurement x=5mm, y=5mm, z=5mm
Power Drift-Start : 0.502 W/kg
Power Drift-Finish: 0.487 W/kg
Power Drift (%) : -3.080

DUT Position : Touch EUT Back
Channel : 1

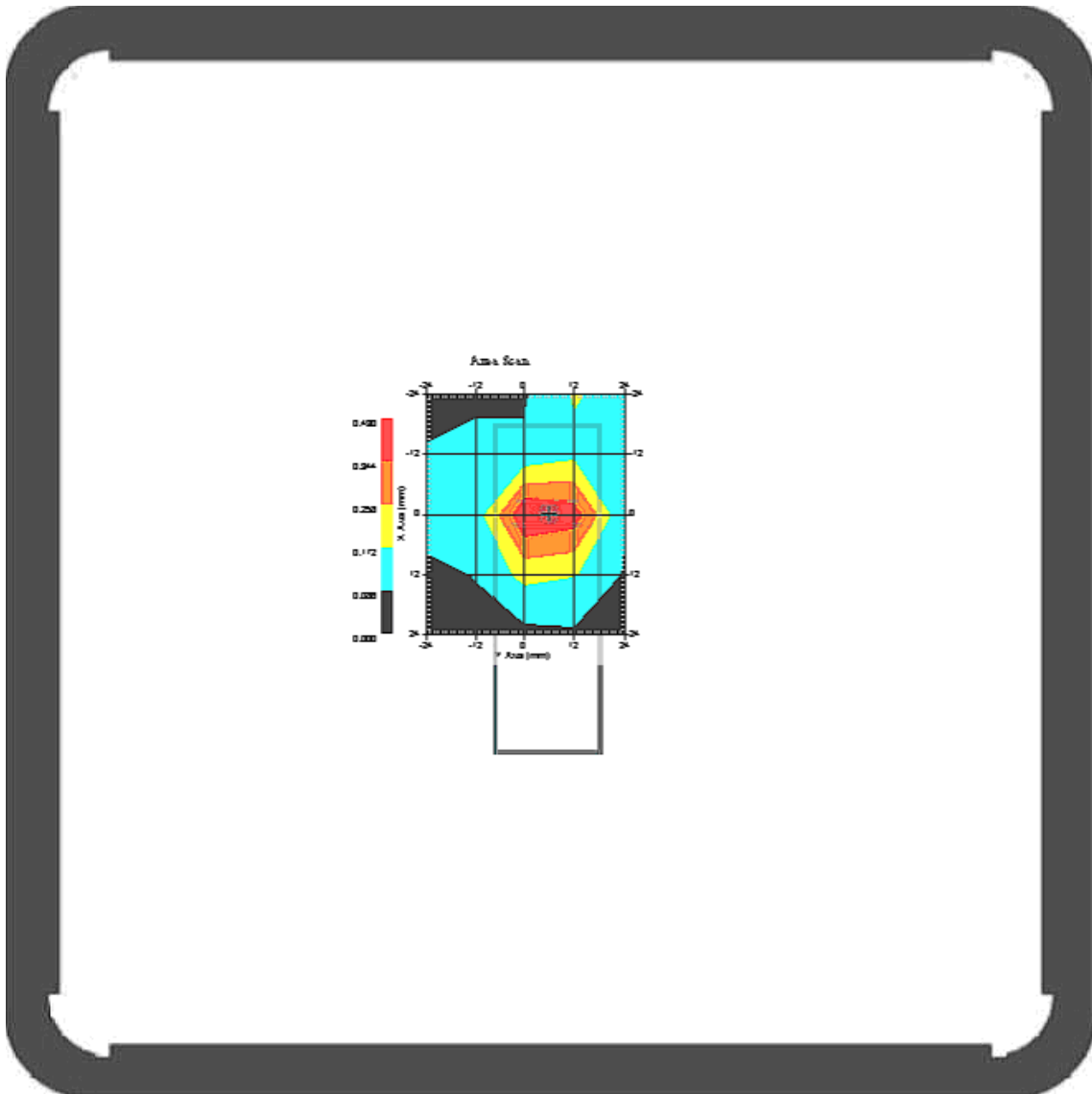

1 gram SAR value : 0.418 W/kg
10 gram SAR value : 0.190 W/kg
Area Scan Peak SAR : 0.428 W/kg
Zoom Scan Peak SAR : 0.910 W/kg

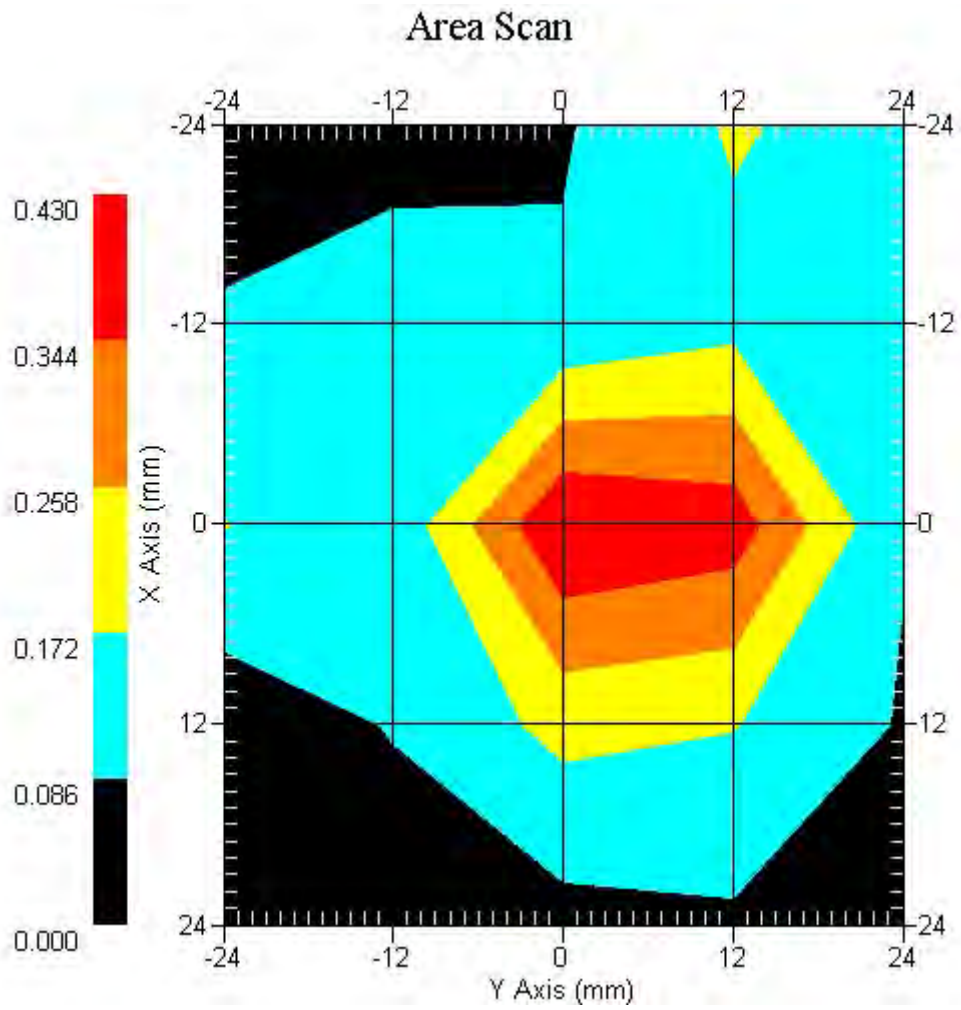

Measurement Data

Crest Factor : 1
Tissue Temp. : 20.10 °C
Ambient Temp. : 21.60 °C
Area Scan : 5x5x1 : Measurement x=12mm, y=12mm, z=4mm
Zoom Scan : 7x7x7 : Measurement x=5mm, y=5mm, z=5mm
Power Drift-Start : 0.069 W/kg
Power Drift-Finish: 0.072 W/kg
Power Drift (%) : 4.166

DUT Position : Touch EUT Back
Channel : 6

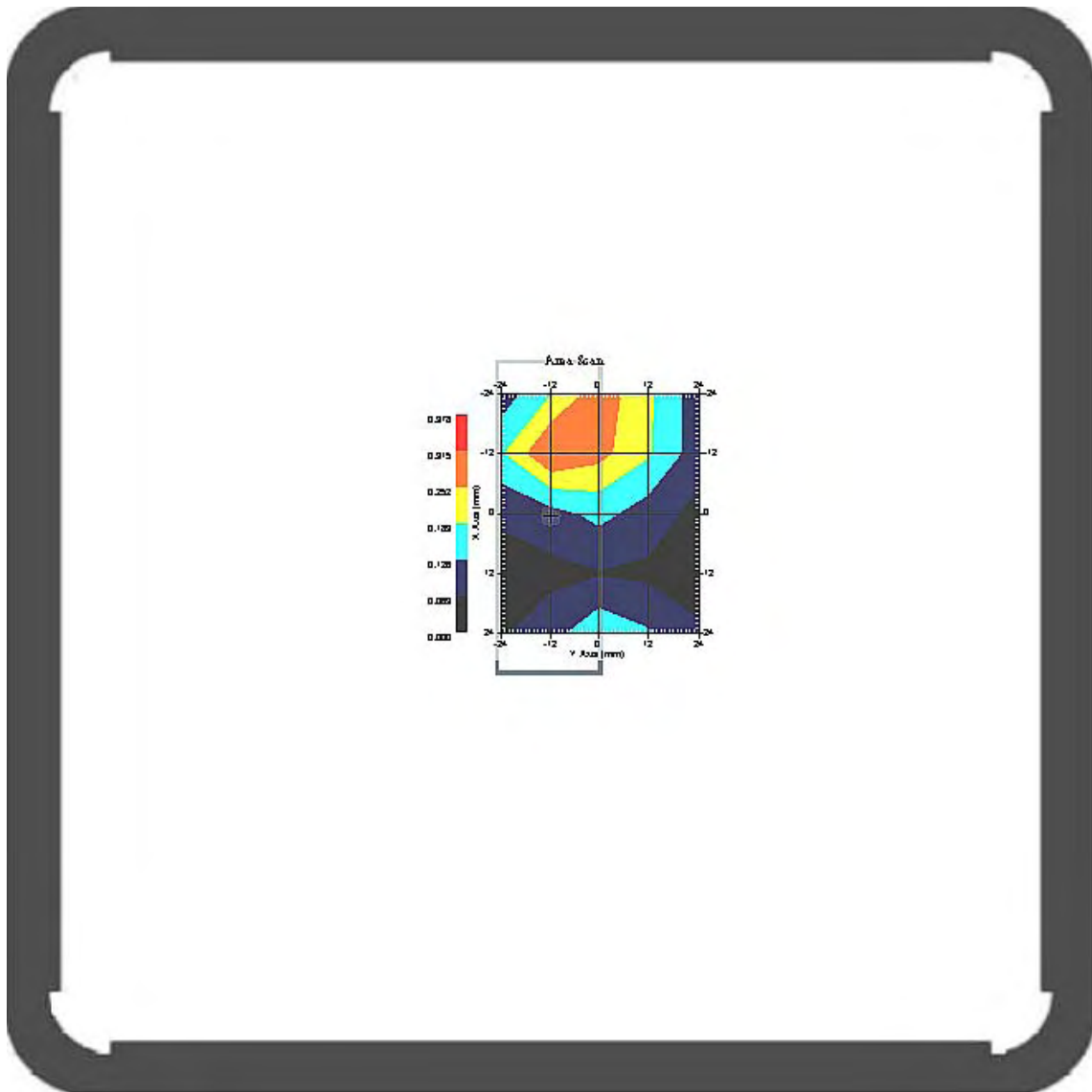

1 gram SAR value : 0.311 W/kg
10 gram SAR value : 0.190 W/kg
Area Scan Peak SAR : 0.316 W/kg
Zoom Scan Peak SAR : 0.420 W/kg

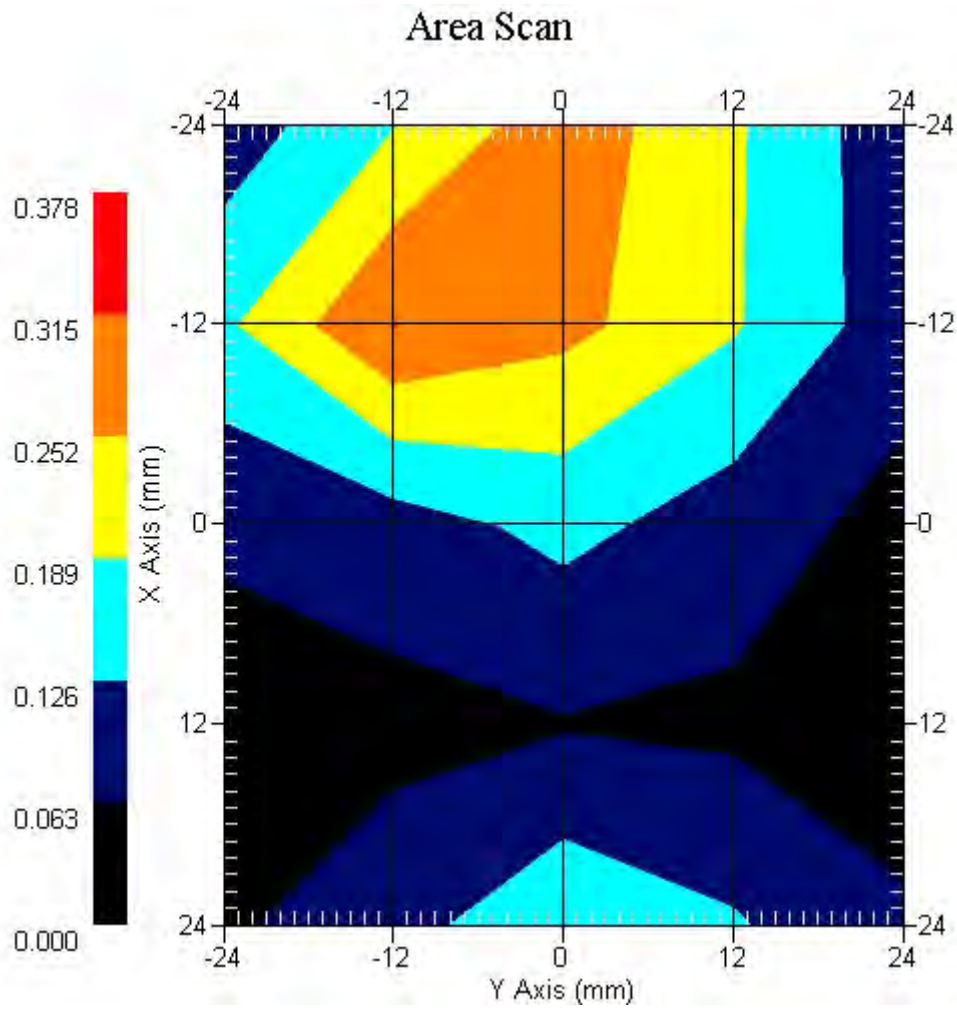

Measurement Data

Crest Factor : 1
Tissue Temp. : 20.10 °C
Ambient Temp. : 21.60 °C
Area Scan : 5x5x1 : Measurement x=12mm, y=12mm, z=4mm
Zoom Scan : 7x7x7 : Measurement x=5mm, y=5mm, z=5mm
Power Drift-Start : 0.645 W/kg
Power Drift-Finish: 0.668 W/kg
Power Drift (%) : 3.443

DUT Position : Touch EUT Back
Channel : 11

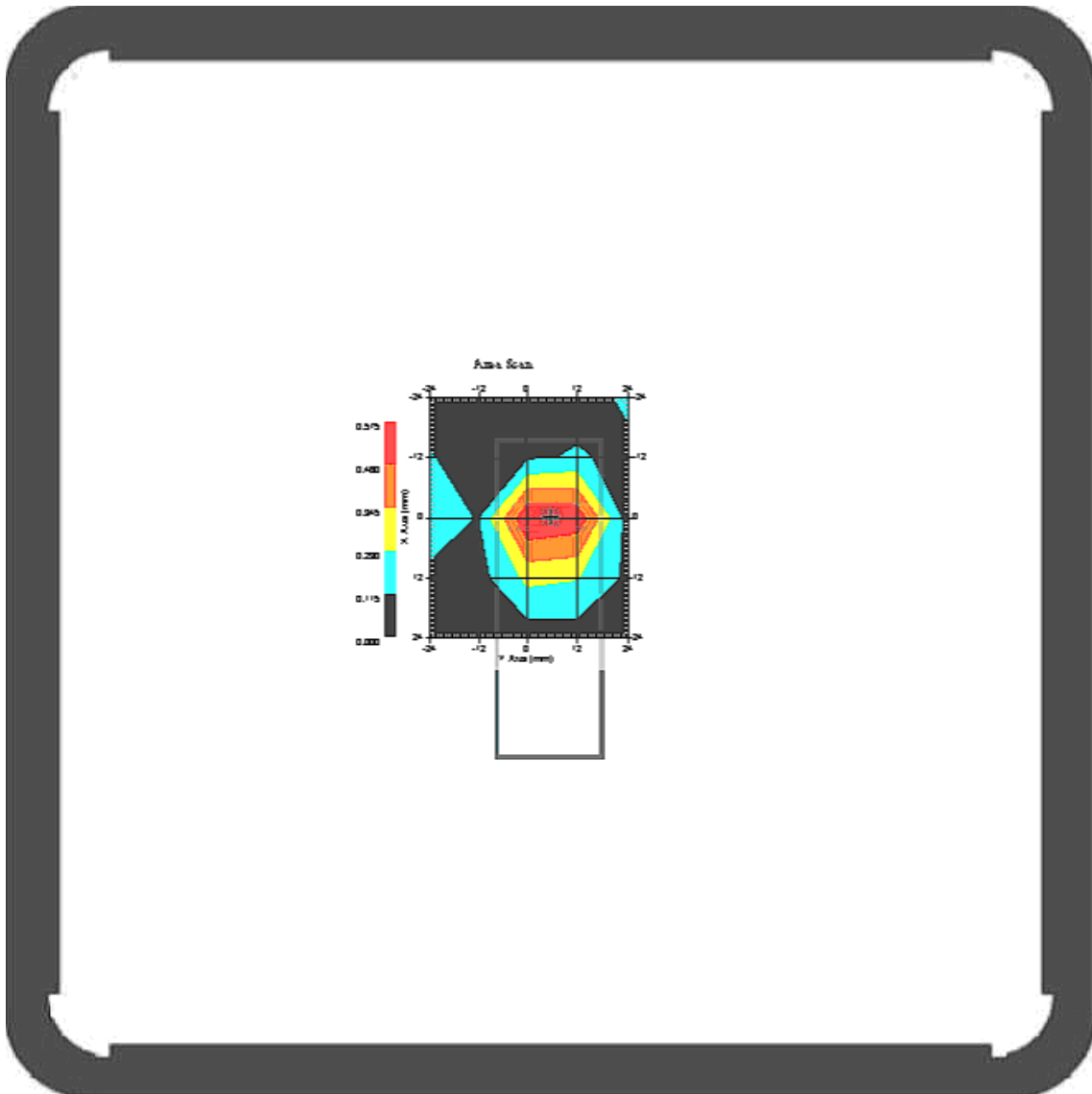

1 gram SAR value : 0.540 W/kg
10 gram SAR value : 0.247 W/kg
Area Scan Peak SAR : 0.573 W/kg
Zoom Scan Peak SAR : 1.631 W/kg

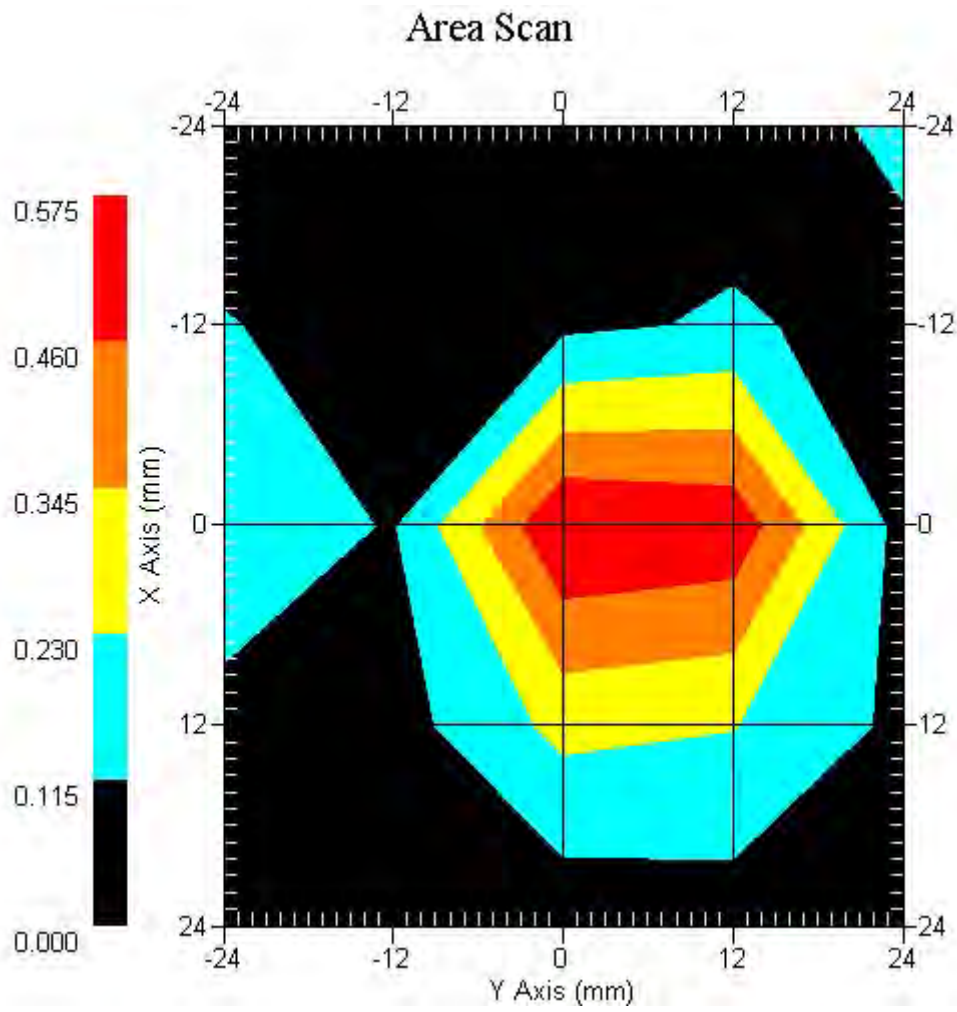

Measurement Data

Crest Factor : 1
Tissue Temp. : 20.10 °C
Ambient Temp. : 21.60 °C
Area Scan : 5x5x1 : Measurement x=12mm, y=12mm, z=4mm
Zoom Scan : 7x7x7 : Measurement x=5mm, y=5mm, z=5mm
Power Drift-Start : 0.595 W/kg
Power Drift-Finish: 0.571 W/kg
Power Drift (%) : -3.972

DUT Position : Touch EUT Top
Channel : 6

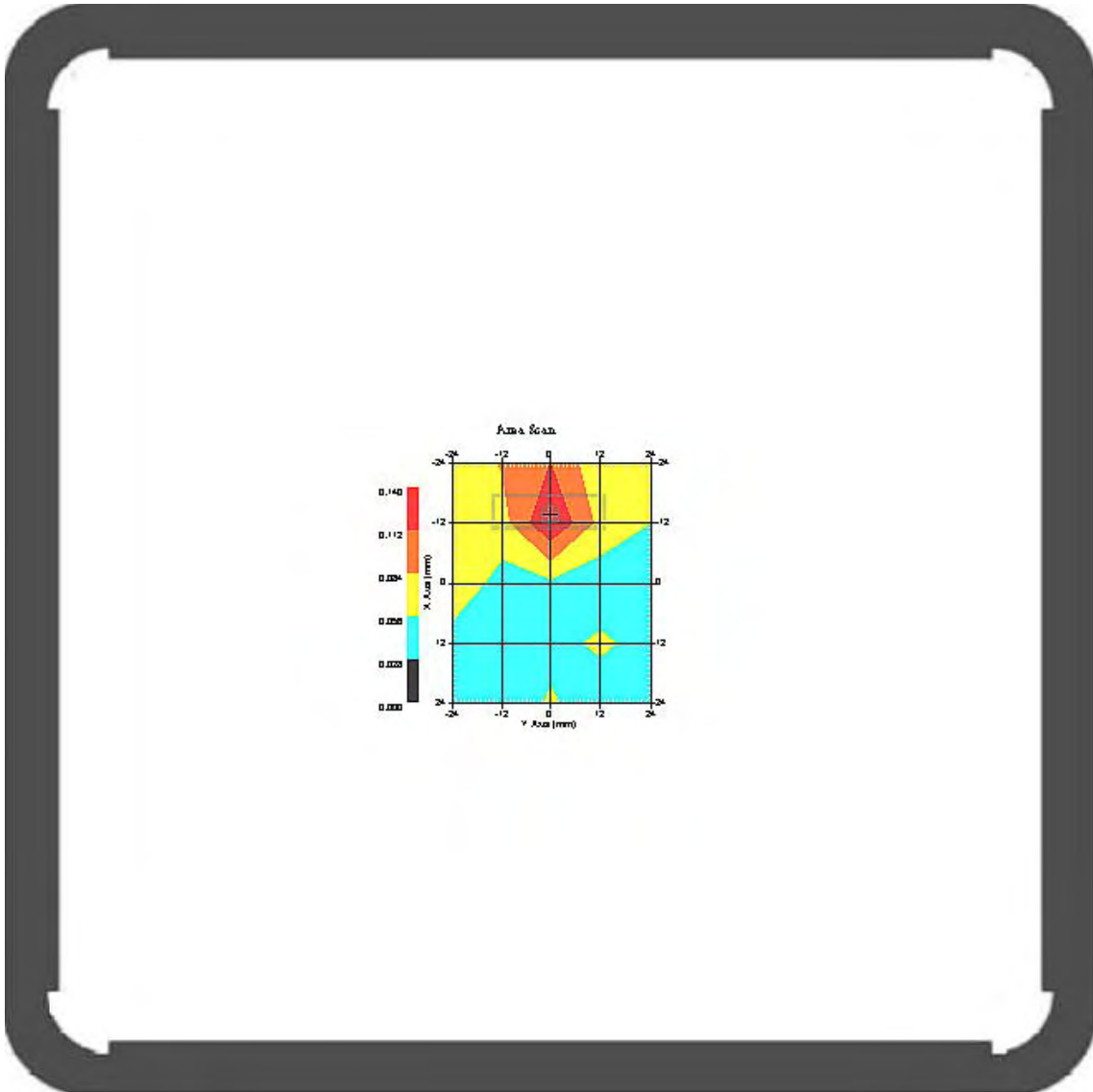

1 gram SAR value : 0.102 W/kg
10 gram SAR value : 0.065 W/kg
Area Scan Peak SAR : 0.114 W/kg
Zoom Scan Peak SAR : 0.166 W/kg

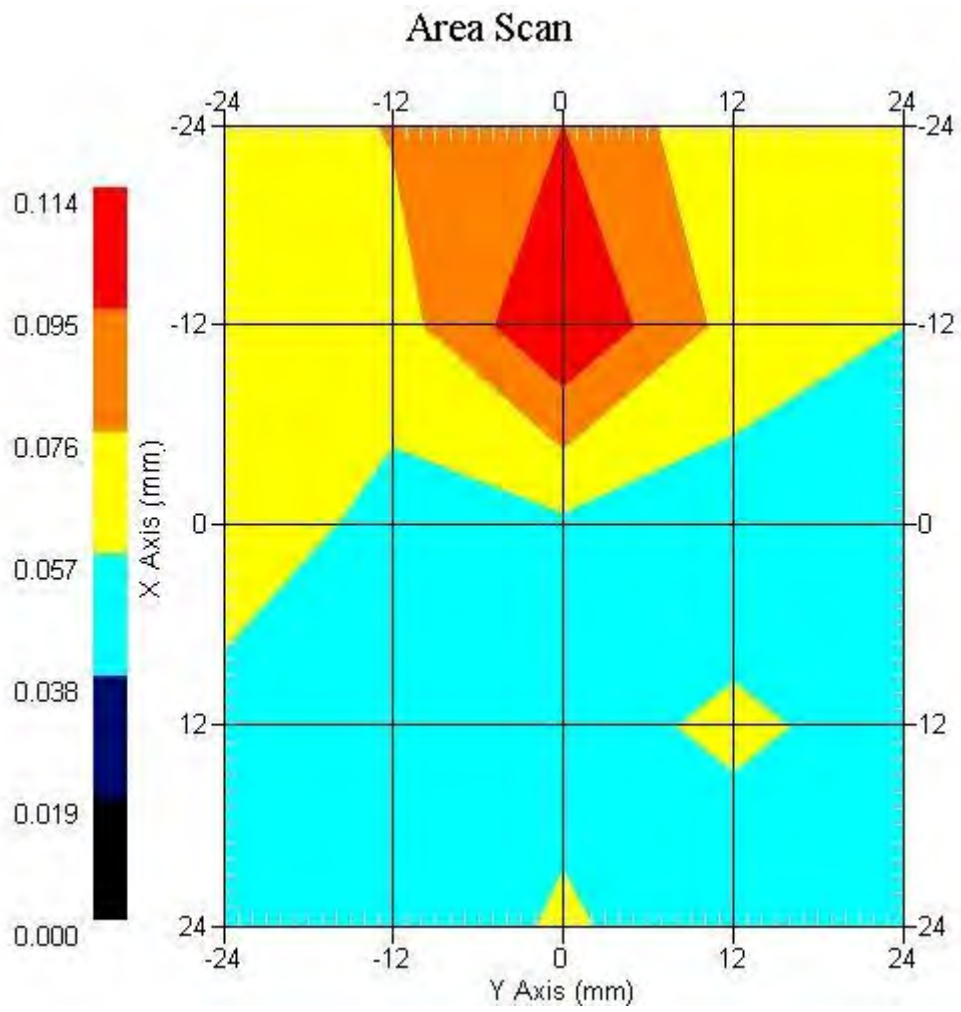

802.11g with EUT Back, Z-Axis plot
channel: 11

SAR-Z Axis
at Hotspot x:58.20 y:-1.90

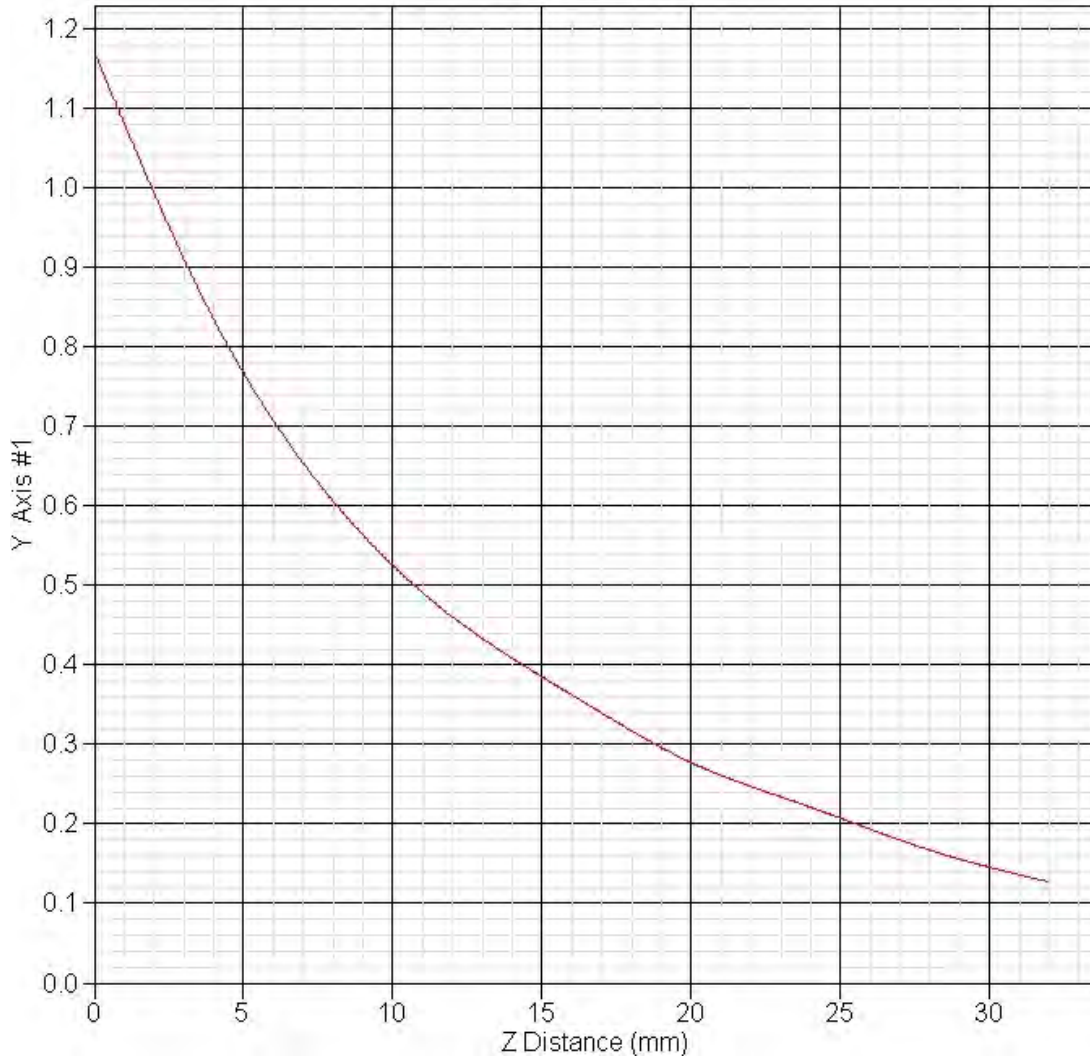

ALSAS-10U VER 2.3.2 APREL Laboratories
SAR Test Report -802.11g Super

Report Date : 20-Dec-2007
Measurement Date : 20-Dec-2007

Product Data

Device Name : USB
Type : Other
Model : WLU108AG-MC
Frequency : 2450.00 MHz
Drift Time : 0 min(s)
Length : 82 mm
Width : 27 mm
Depth : 8 mm
Antenna Type : Internal

Phantom Data

Type : Uni-Phantom
Size (mm) : 280 x 280 x 200
Location : Center

Tissue Data

Type : BODY
Serial No. : 325-B
Frequency : 2450.00 MHz
Last Calib. Date : 20-Dec-2007
Temperature : 20.10 °C
Ambient Temp. : 21.60 °C
Humidity : 50.00 RH%
Epsilon : 53.41 F/m
Sigma : 1.868 S/m
Density : 1000.00 kg/cu. m

Probe Data

Name : Probe 264
Model : E020
Type : E-Field Triangle
Serial No. : 264
Last Calib. Date : 21-Aug-2007
Frequency : 2450.00 MHz
Duty Cycle Factor: 1
Conversion Factor: 5.2
Probe Sensitivity: 1.20 1.20 1.20 $\mu\text{V}/(\text{V}/\text{m})^2$
Compression Point: 95.00 mV
Offset : 1.56 mm

Measurement Data

Crest Factor : 1
 Tissue Temp. : 20.10 °C
 Ambient Temp. : 21.60 °C
 Area Scan : 5x5x1 : Measurement x=12mm, y=12mm, z=4mm
 Zoom Scan : 7x7x7 : Measurement x=5mm, y=5mm, z=5mm
 Power Drift-Start : 0.036 W/kg
 Power Drift-Finish: 0.037 W/kg
 Power Drift (%) : 2.702

DUT Position : Touch EUT Front
 Channel : 7

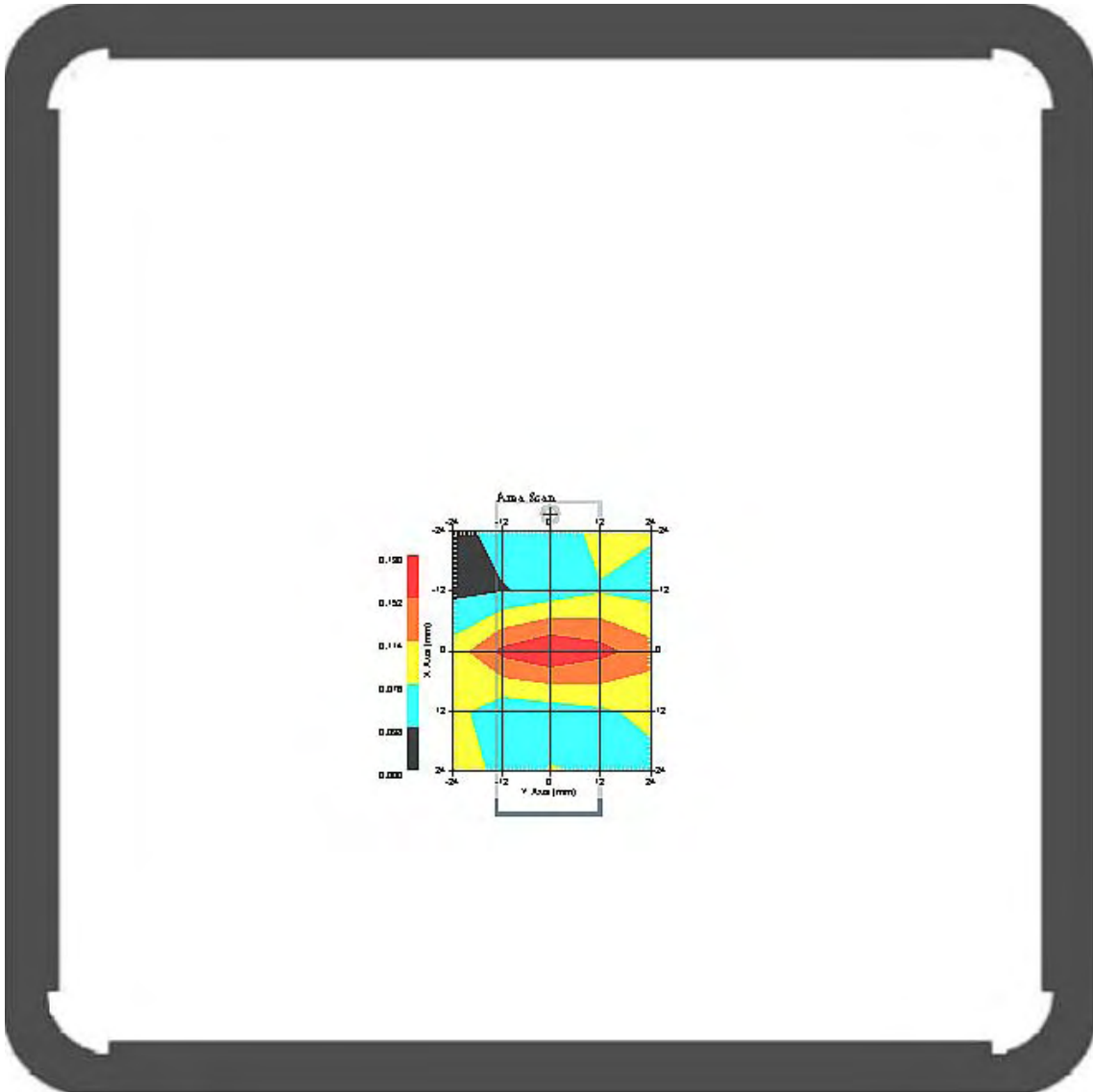

1 gram SAR value : 0.135 W/kg
 10 gram SAR value : 0.127 W/kg
 Area Scan Peak SAR : 0.189 W/kg
 Zoom Scan Peak SAR : 0.010 W/kg

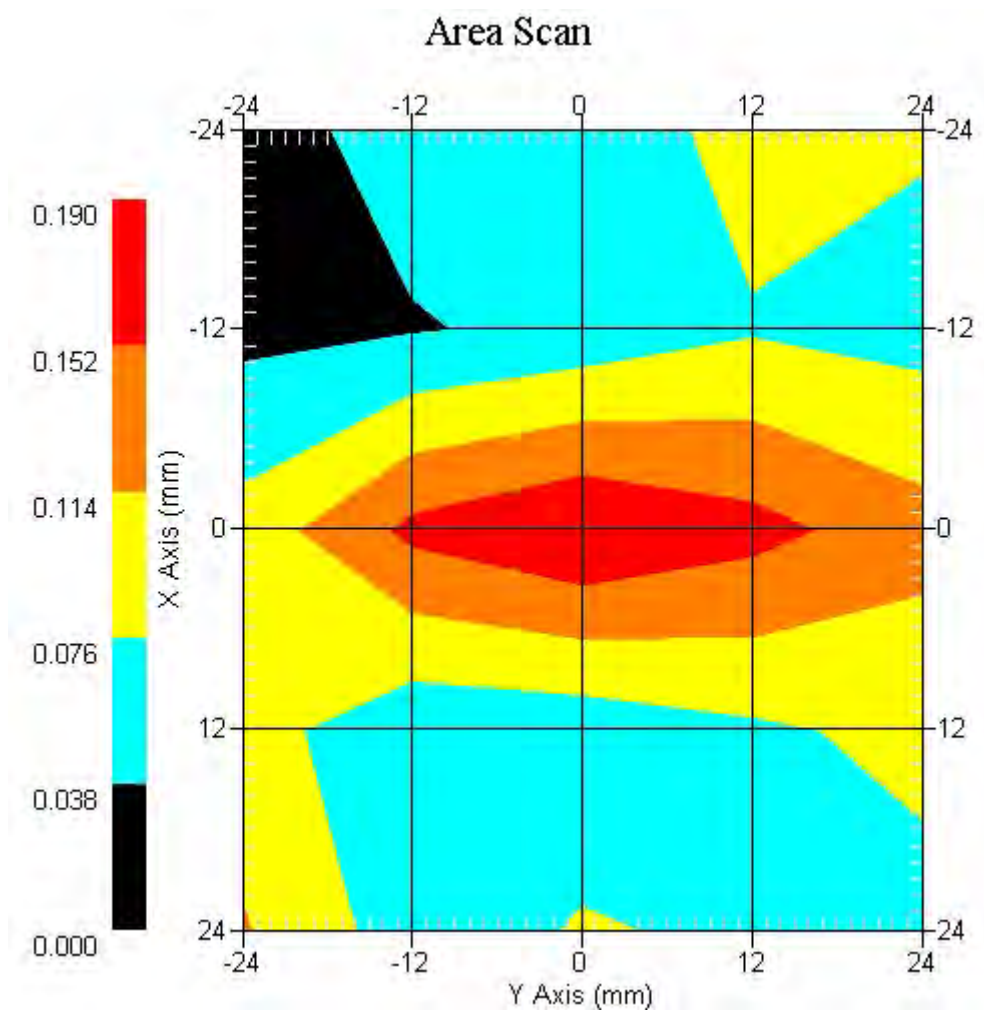

Measurement Data

Crest Factor : 1
Tissue Temp. : 20.10 °C
Ambient Temp. : 21.60 °C
Area Scan : 5x5x1 : Measurement x=12mm, y=12mm, z=4mm
Zoom Scan : 7x7x7 : Measurement x=5mm, y=5mm, z=5mm
Power Drift-Start : 0.597 W/kg
Power Drift-Finish: 0.612 W/kg
Power Drift (%) : 2.450

DUT Position : Touch EUT Back
Channel : 3

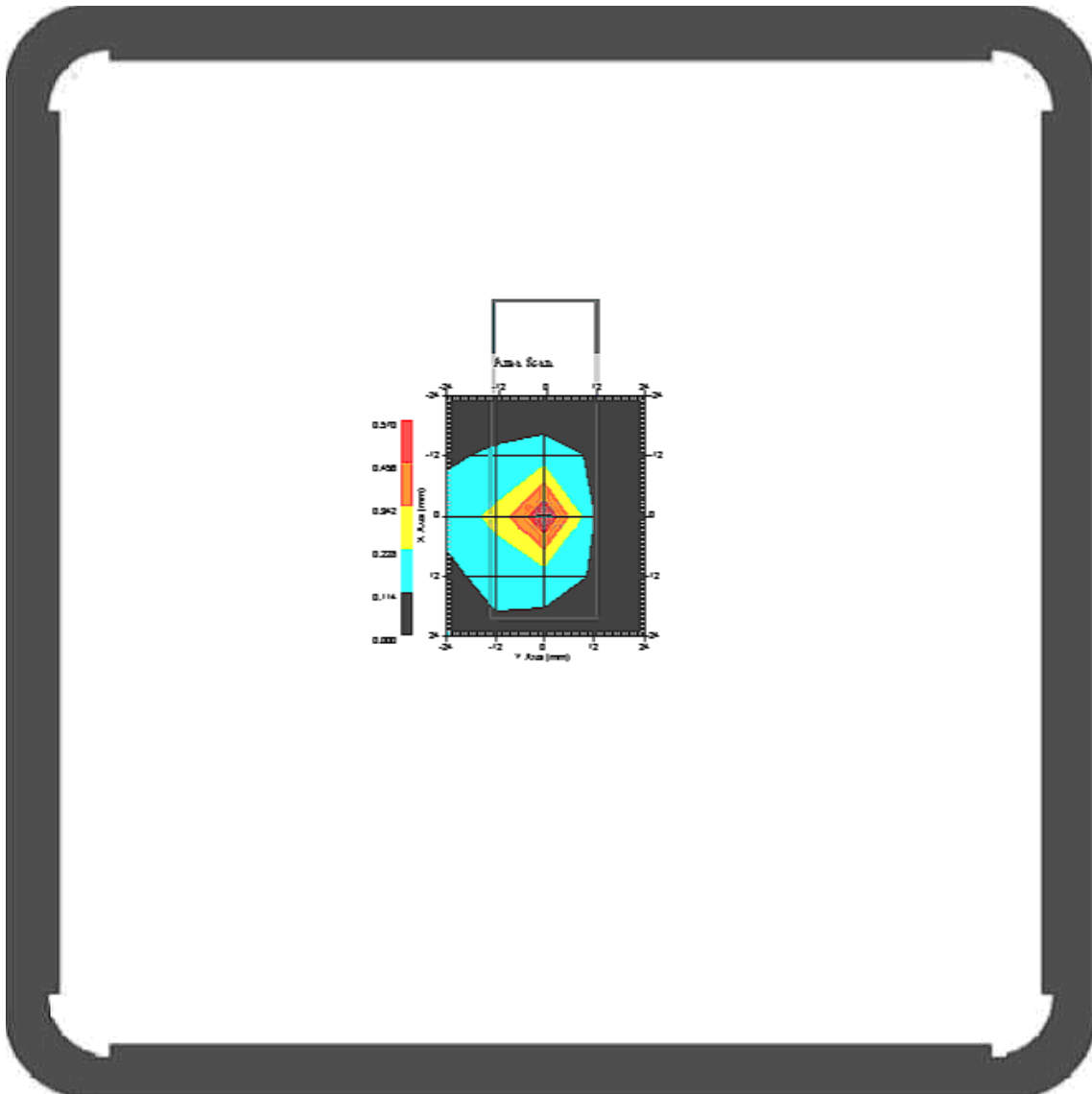

1 gram SAR value : 0.387 W/kg
10 gram SAR value : 0.176 W/kg
Area Scan Peak SAR : 0.568 W/kg
Zoom Scan Peak SAR : 1.060 W/kg

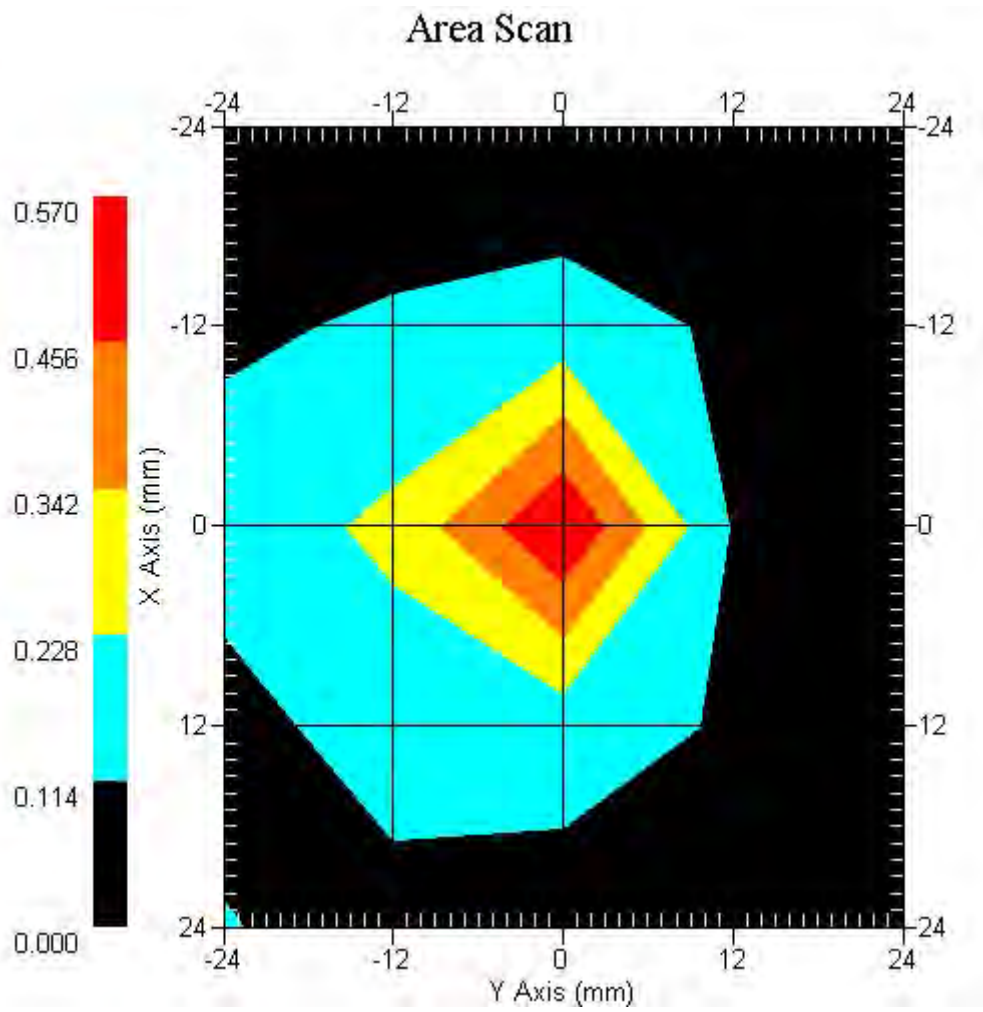

Measurement Data

Crest Factor : 1
Tissue Temp. : 20.10 °C
Ambient Temp. : 21.60 °C
Area Scan : 5x5x1 : Measurement x=12mm, y=12mm, z=4mm
Zoom Scan : 7x7x7 : Measurement x=5mm, y=5mm, z=5mm
Power Drift-Start : 0.057 W/kg
Power Drift-Finish: 0.059 W/kg
Power Drift (%) : 3.389

DUT Position : Touch EUT Back
Channel : 7

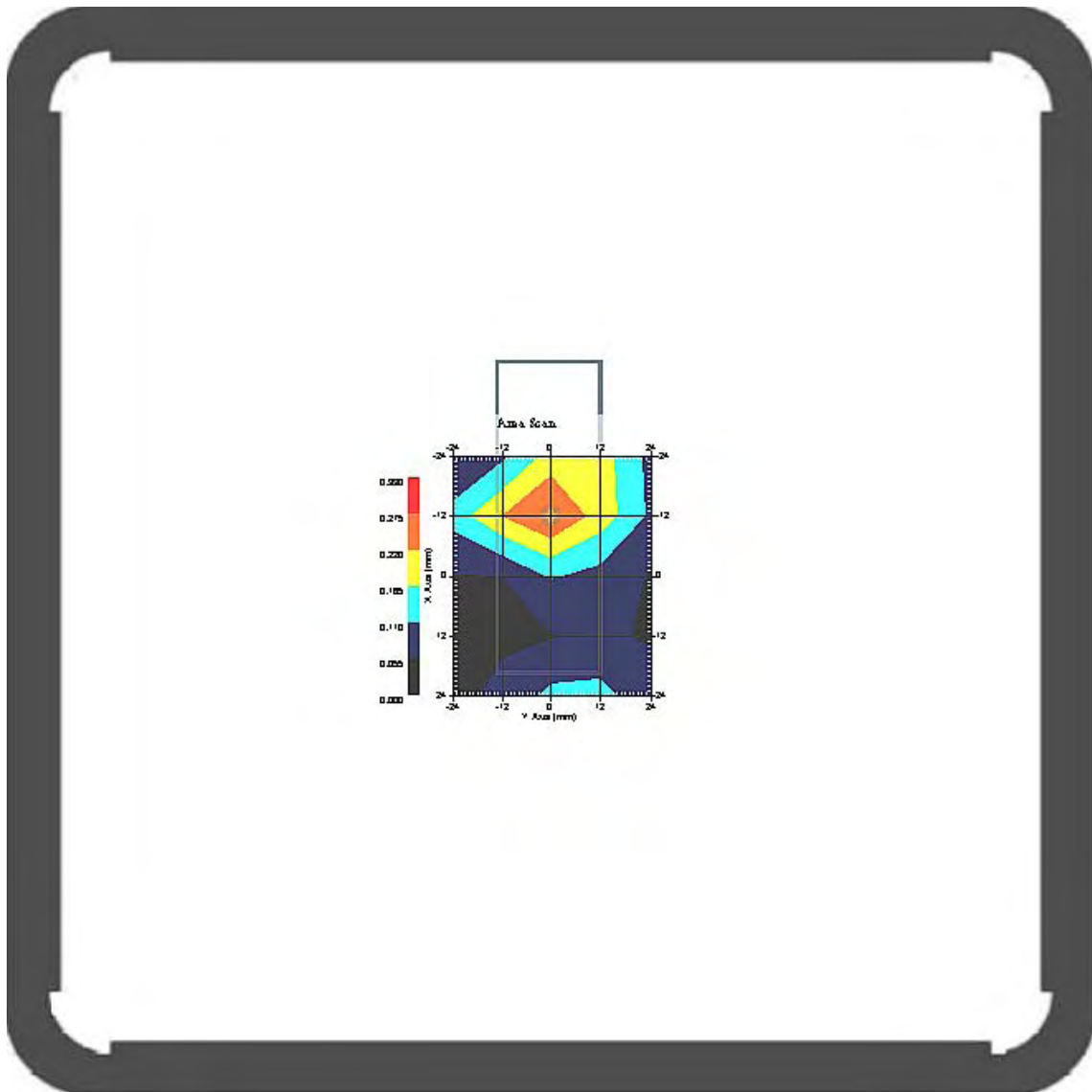

1 gram SAR value : 0.254 W/kg
10 gram SAR value : 0.141 W/kg
Area Scan Peak SAR : 0.277 W/kg
Zoom Scan Peak SAR : 0.580 W/kg

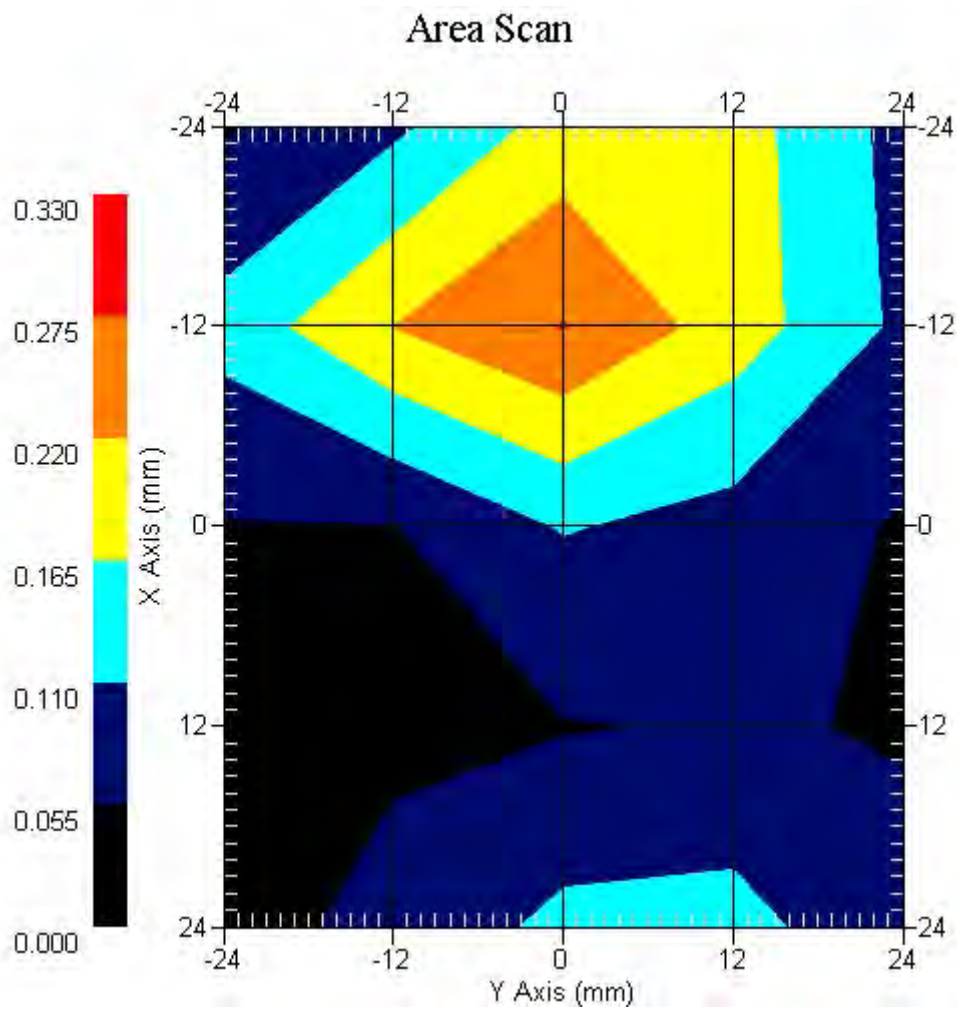

Measurement Data

Crest Factor : 1
Tissue Temp. : 20.10 °C
Ambient Temp. : 21.60 °C
Area Scan : 5x5x1 : Measurement x=12mm, y=12mm, z=4mm
Zoom Scan : 7x7x7 : Measurement x=5mm, y=5mm, z=5mm
Power Drift-Start : 0.596 W/kg
Power Drift-Finish: 0.575 W/kg
Power Drift (%) : -3.517

DUT Position : Touch EUT Back
Channel : 11

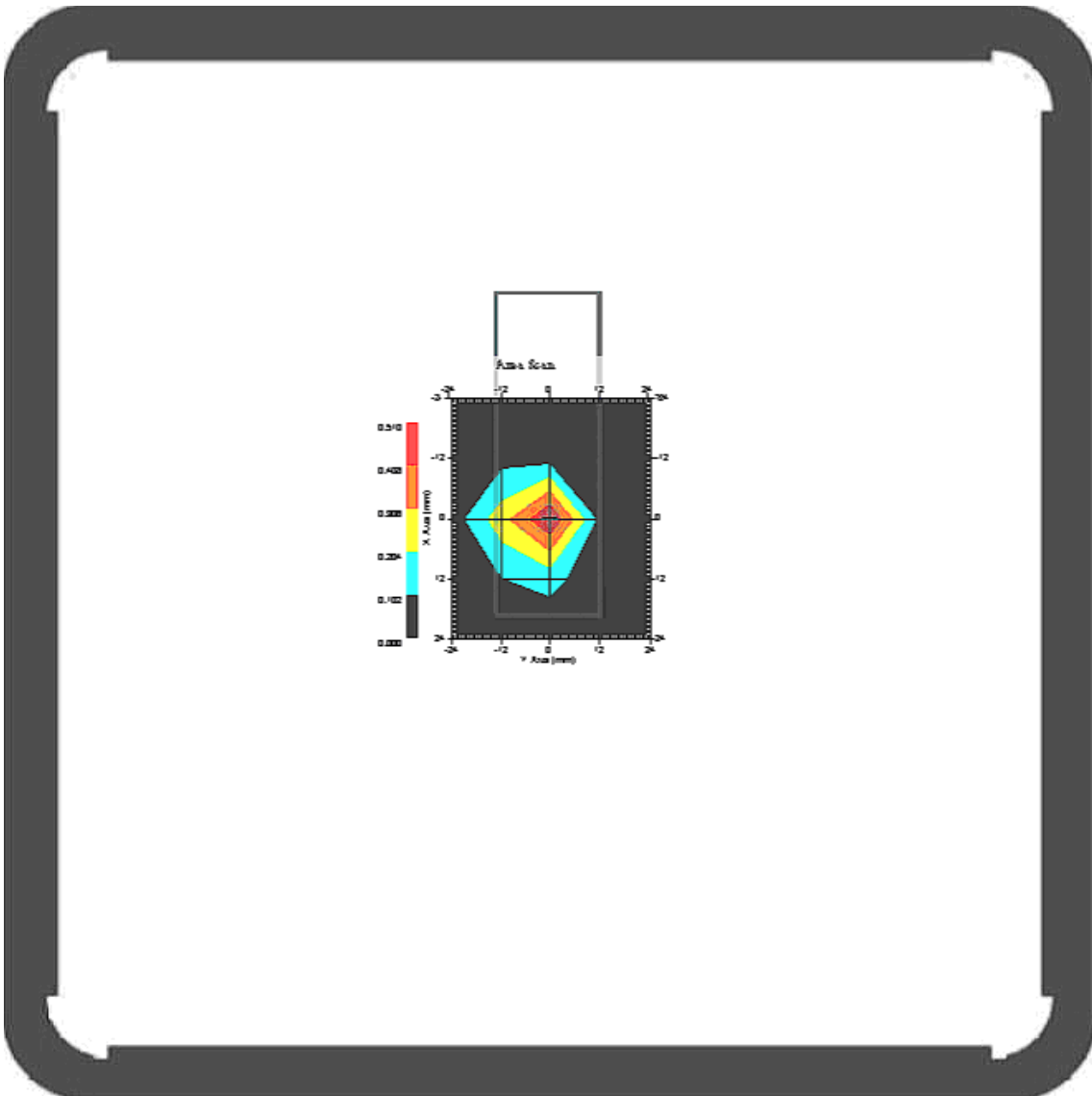

1 gram SAR value : 0.375 W/kg
10 gram SAR value : 0.185 W/kg
Area Scan Peak SAR : 0.509 W/kg
Zoom Scan Peak SAR : 1.060 W/kg

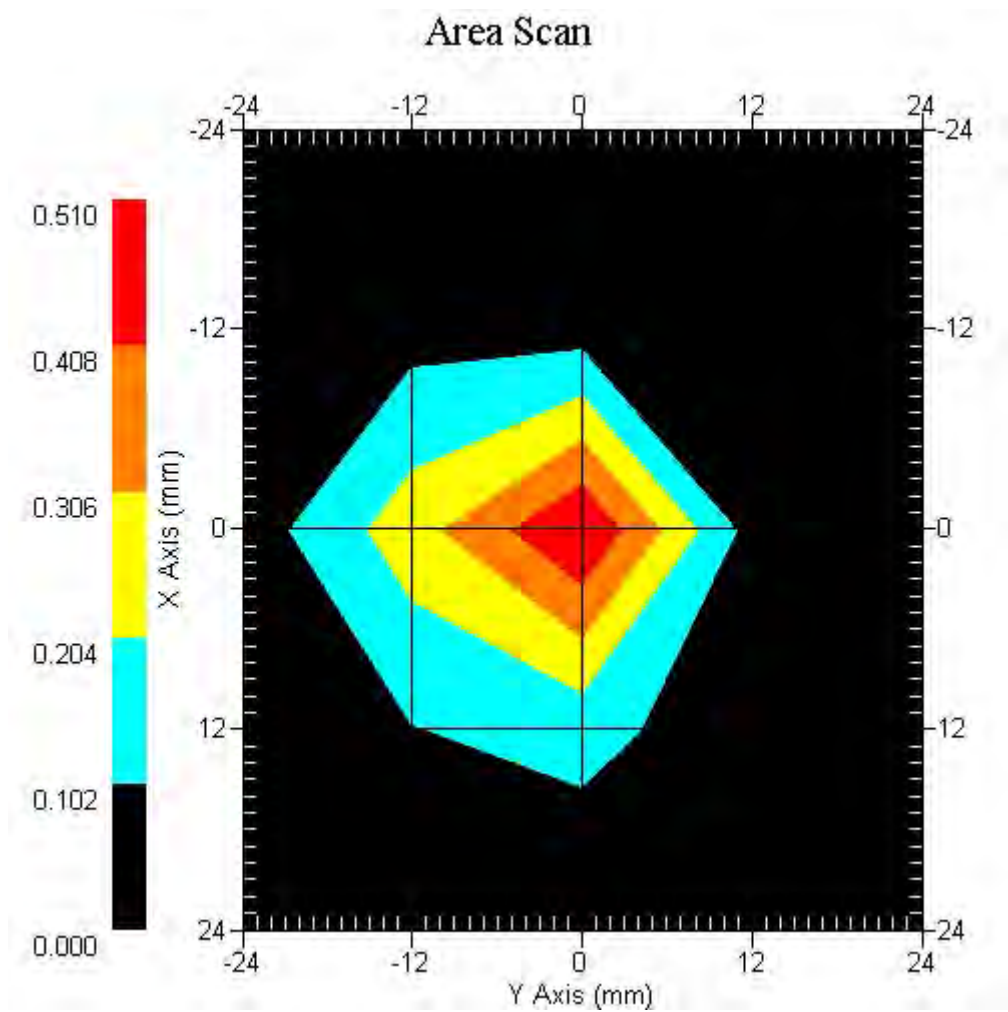

Measurement Data

Crest Factor : 1
Tissue Temp. : 20.10 °C
Ambient Temp. : 21.60 °C
Area Scan : 5x5x1 : Measurement x=12mm, y=12mm, z=4mm
Zoom Scan : 7x7x7 : Measurement x=5mm, y=5mm, z=5mm
Power Drift-Start : 0.631 W/kg
Power Drift-Finish: 0.649 W/kg
Power Drift (%) : 2.773

DUT Position : Touch EUT Top
Channel : 7

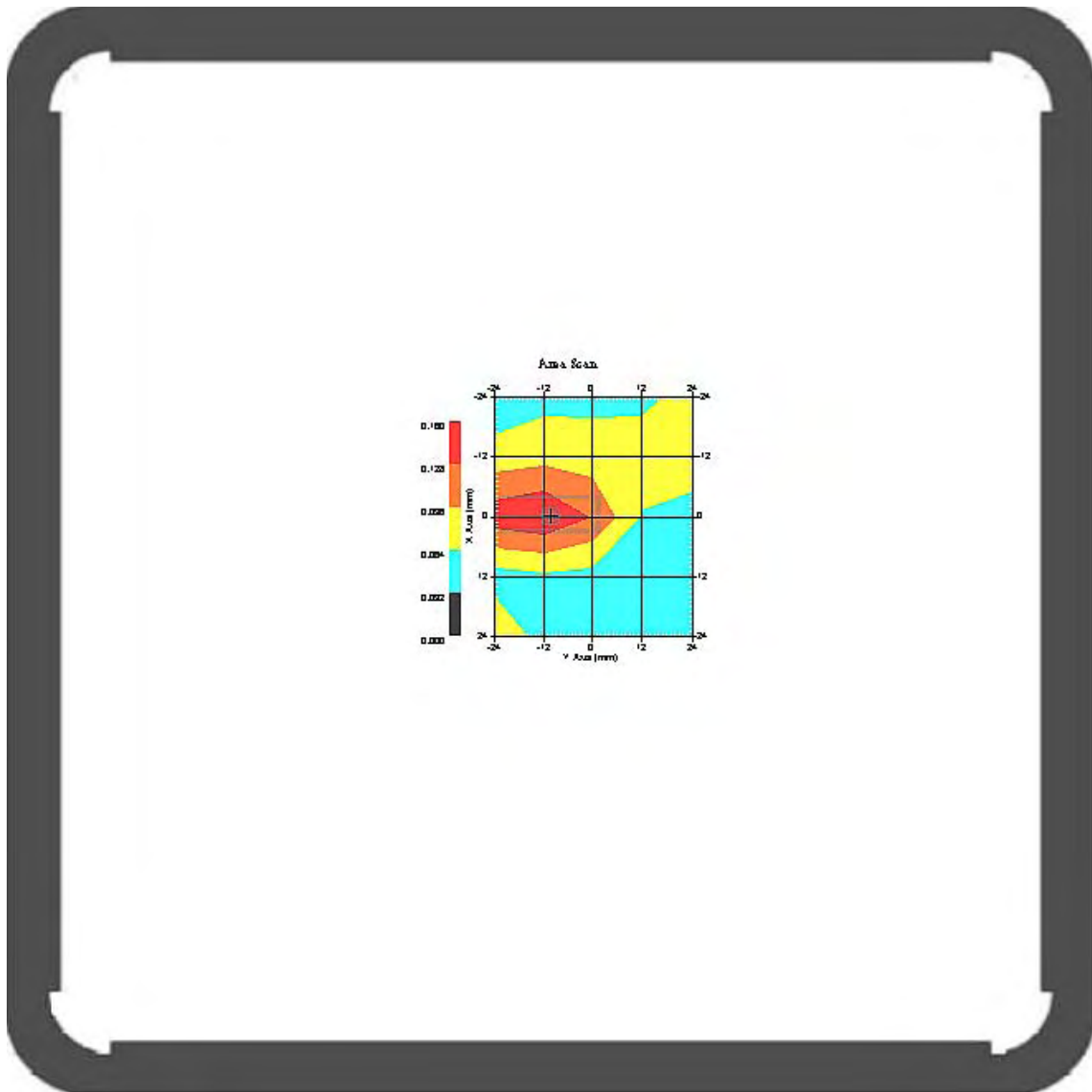

1 gram SAR value : 0.137 W/kg
10 gram SAR value : 0.076 W/kg
Area Scan Peak SAR : 0.160 W/kg
Zoom Scan Peak SAR : 0.241 W/kg

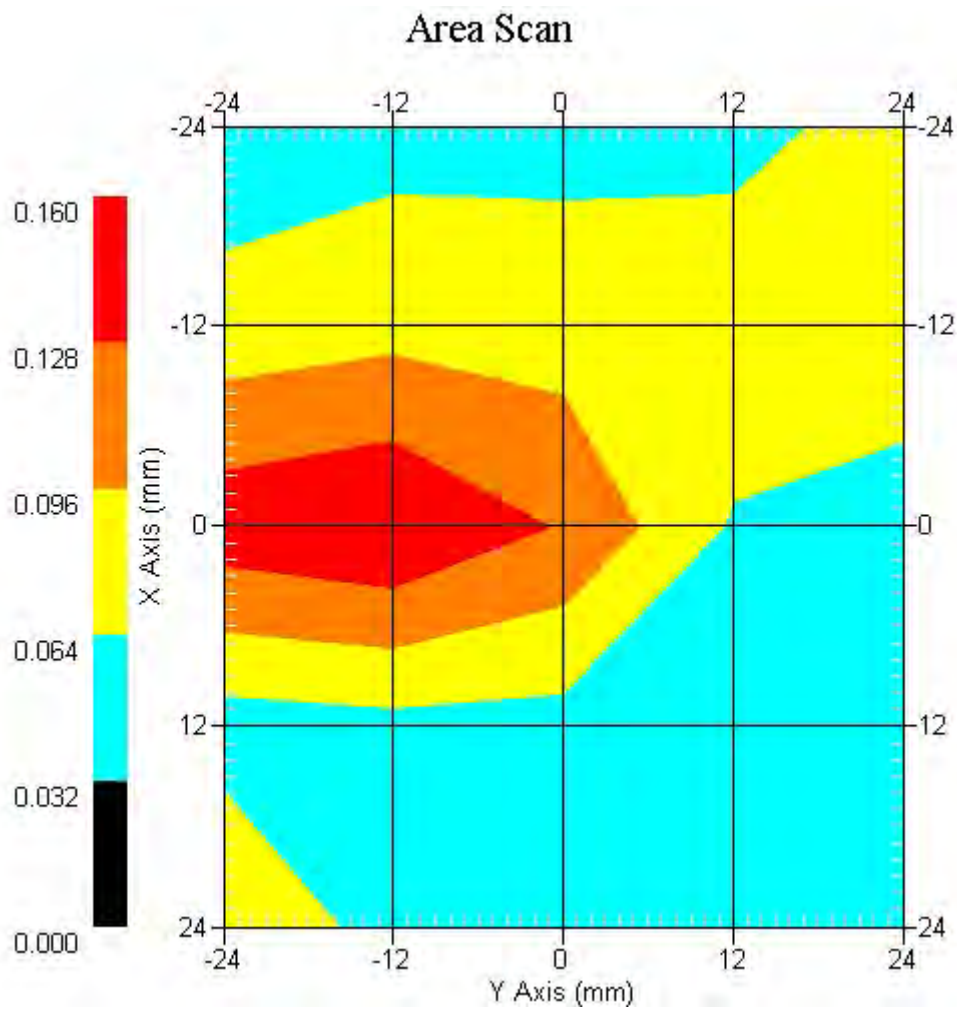

802.11g Super with EUT Back, Z-Axis plot
channel: 3

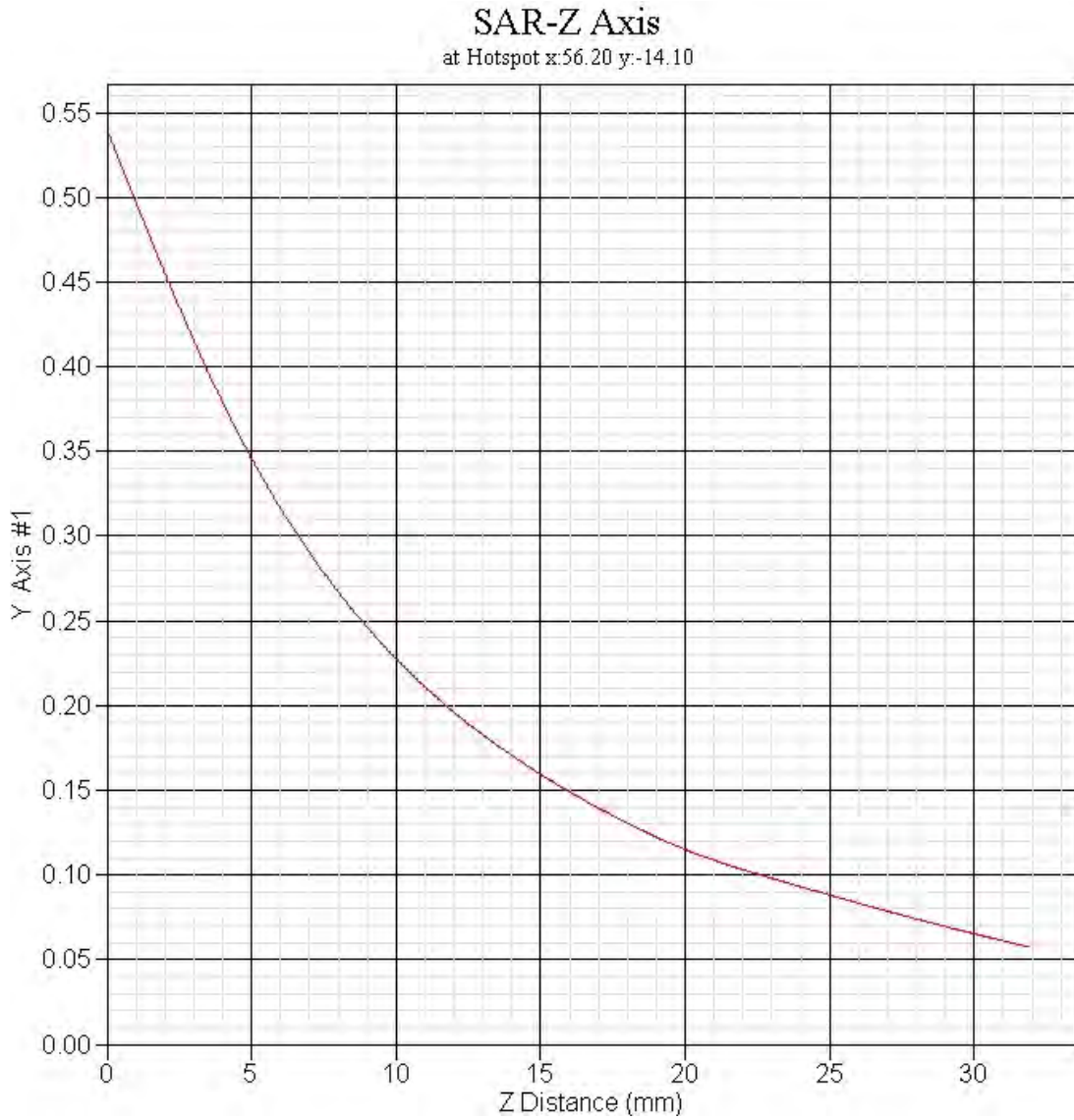

ALSAS-10U VER 2.3.2 APREL Laboratories
SAR Test Report -802.11a 5.2GHz

Report Date : 18-Dec-2007
Measurement Date : 18-Dec-2007

Product Data

Device Name : USB
Type : Other
Model : WLU108AG-MC
Frequency : 5200.00 MHz
Drift Time : 0 min(s)
Length : 82 mm
Width : 27 mm
Depth : 8 mm
Antenna Type : Internal

Phantom Data

Type : Uni-Phantom
Size (mm) : 280 x 280 x 200
Location : Center

Tissue Data

Type : BODY
Serial No. : 326-B
Frequency : 5200.00 MHz
Last Calib. Date : 18-Dec-2007
Temperature : 21.10 °C
Ambient Temp. : 22.40 °C
Humidity : 51.00 RH%
Epsilon : 47.21 F/m
Sigma : 5.314 S/m
Density : 1000.00 kg/cu. m

Probe Data

Name : Probe 264
Model : E020
Type : E-Field Triangle
Serial No. : 264
Last Calib. Date : 22-Aug-2007
Frequency : 5200.00 MHz
Duty Cycle Factor: 1
Conversion Factor: 4.5
Probe Sensitivity: 0.61 0.61 0.61 $\mu\text{V}/(\text{V}/\text{m})^2$
Compression Point: 95.00 mV
Offset : 1.56 mm

Measurement Data

Crest Factor : 1
Tissue Temp. : 21.10 °C
Ambient Temp. : 22.40 °C
Area Scan : 5x5x1 : Measurement x=12mm, y=12mm, z=4mm
Zoom Scan : 7x7x7 : Measurement x=5mm, y=5mm, z=5mm
Power Drift-Start : 0.182 W/kg
Power Drift-Finish: 0.175 W/kg
Power Drift (%) : -3.846

DUT Position : Touch EUT Front
Channel : 52

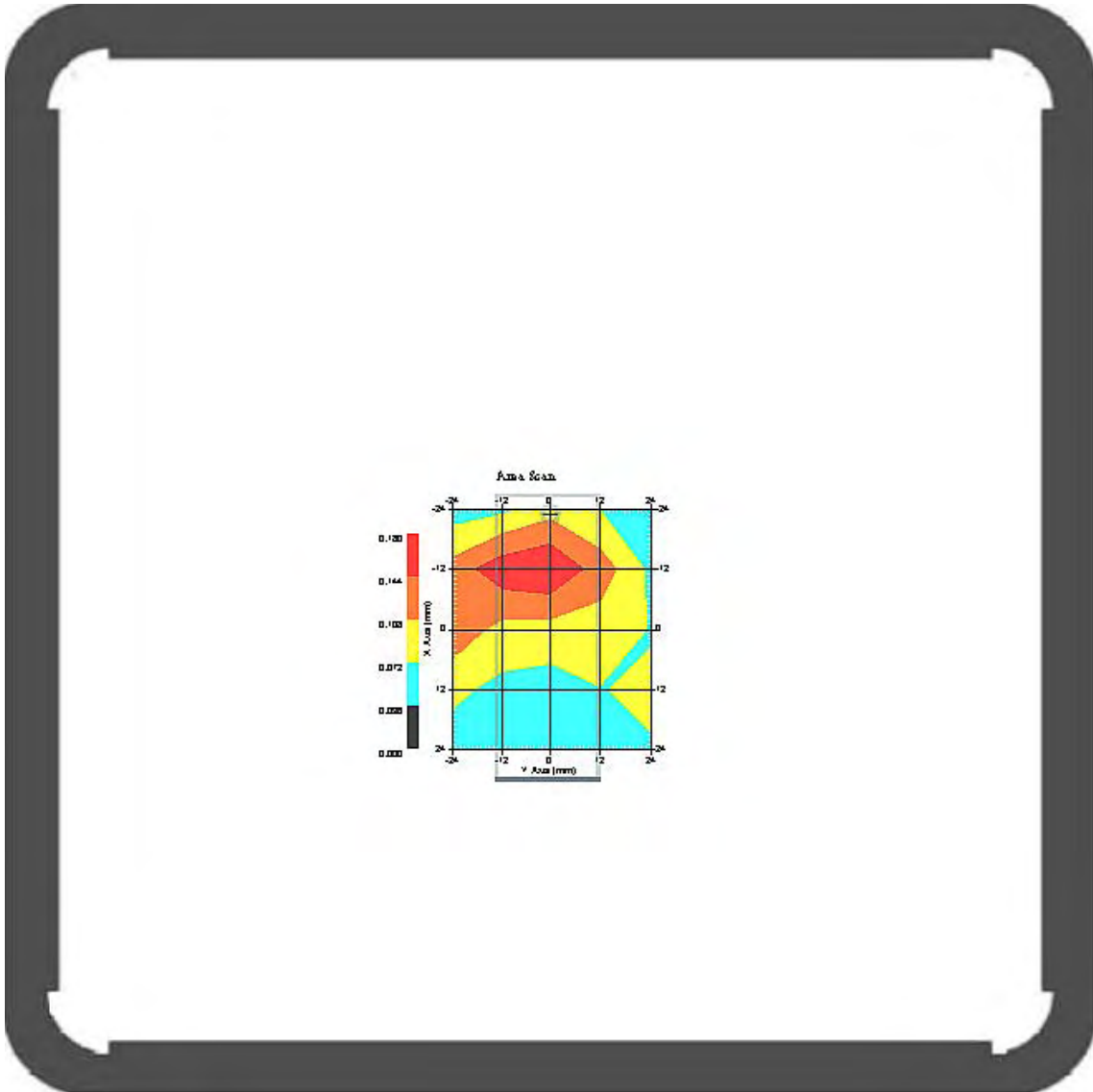

1 gram SAR value : 0.421 W/kg
10 gram SAR value : 0.306 W/kg
Area Scan Peak SAR : 0.575 W/kg
Zoom Scan Peak SAR : 0.835 W/kg

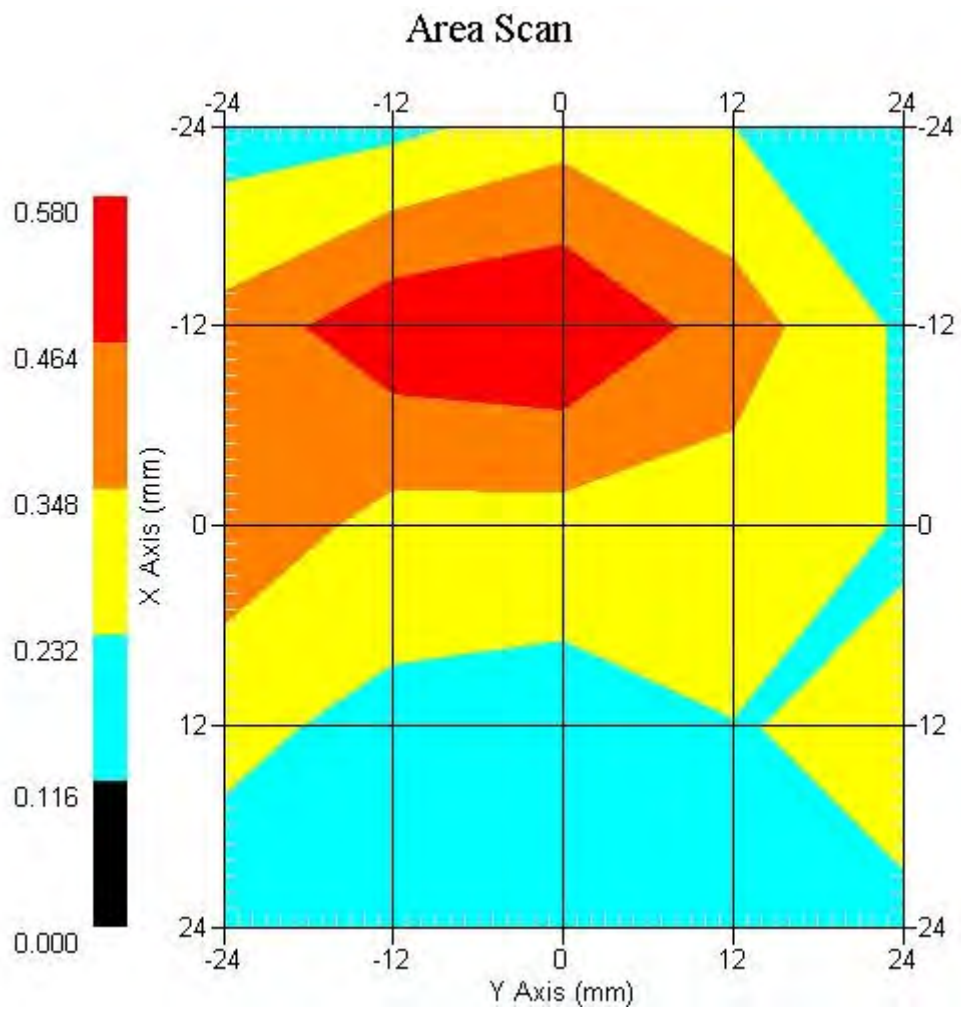

Measurement Data

Crest Factor : 1
Tissue Temp. : 21.10 °C
Ambient Temp. : 22.40 °C
Area Scan : 5x5x1 : Measurement x=12mm, y=12mm, z=4mm
Zoom Scan : 7x7x7 : Measurement x=5mm, y=5mm, z=5mm
Power Drift-Start : 0.126 W/kg
Power Drift-Finish: 0.136 W/kg
Power Drift (%) : 3.938

DUT Position : Touch EUT Back
Channel : 36

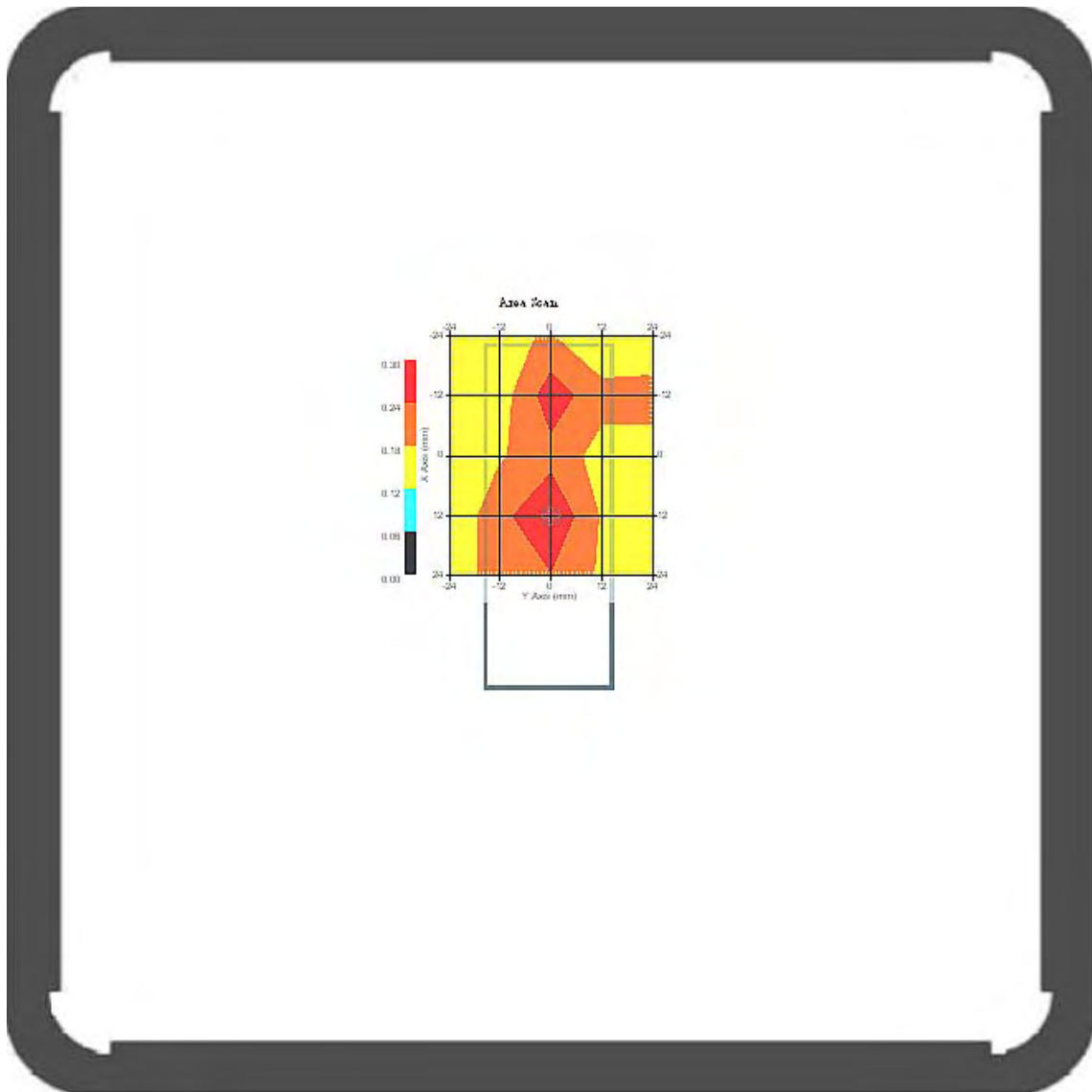

1 gram SAR value : 0.297 W/kg
10 gram SAR value : 0.180 W/kg
Area Scan Peak SAR : 0.300 W/kg
Zoom Scan Peak SAR : 0.300 W/kg

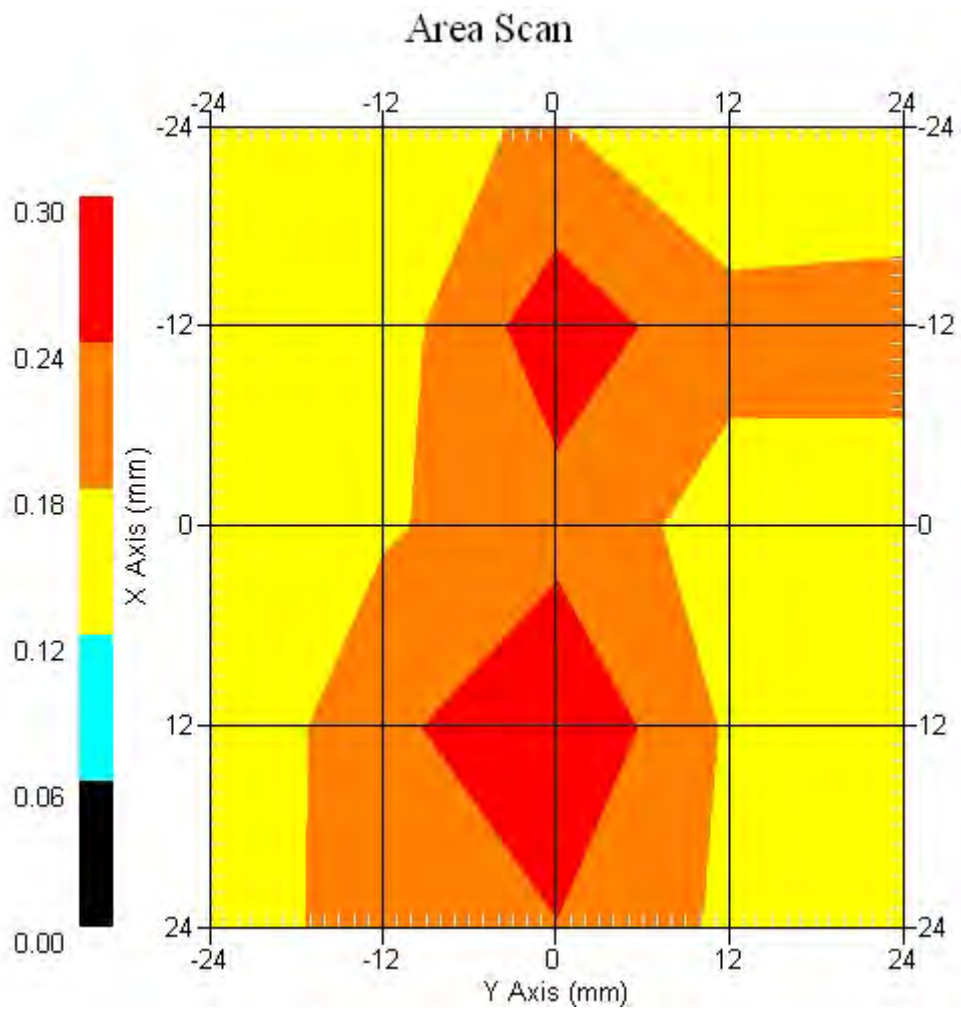

Measurement Data

Crest Factor : 1
Tissue Temp. : 21.10 °C
Ambient Temp. : 22.40 °C
Area Scan : 5x5x1 : Measurement x=12mm, y=12mm, z=4mm
Zoom Scan : 7x7x7 : Measurement x=5mm, y=5mm, z=5mm
Power Drift-Start : 0.357 W/kg
Power Drift-Finish: 0.366 W/kg
Power Drift (%) : 3.446

DUT Position : Touch EUT Back
Channel : 40

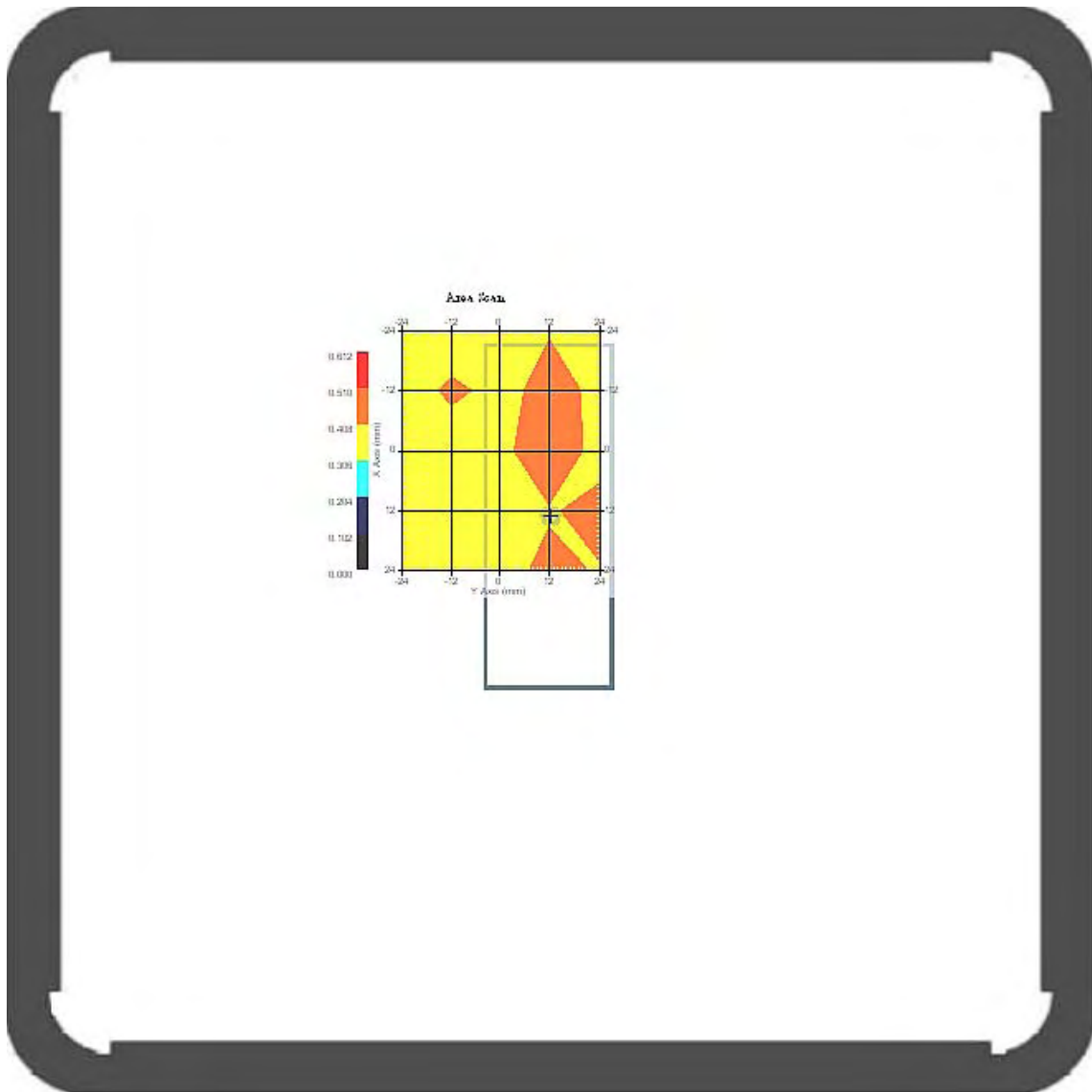

1 gram SAR value : 0.416 W/kg
10 gram SAR value : 0.348 W/kg
Area Scan Peak SAR : 0.512 W/kg
Zoom Scan Peak SAR : 0.800 W/kg

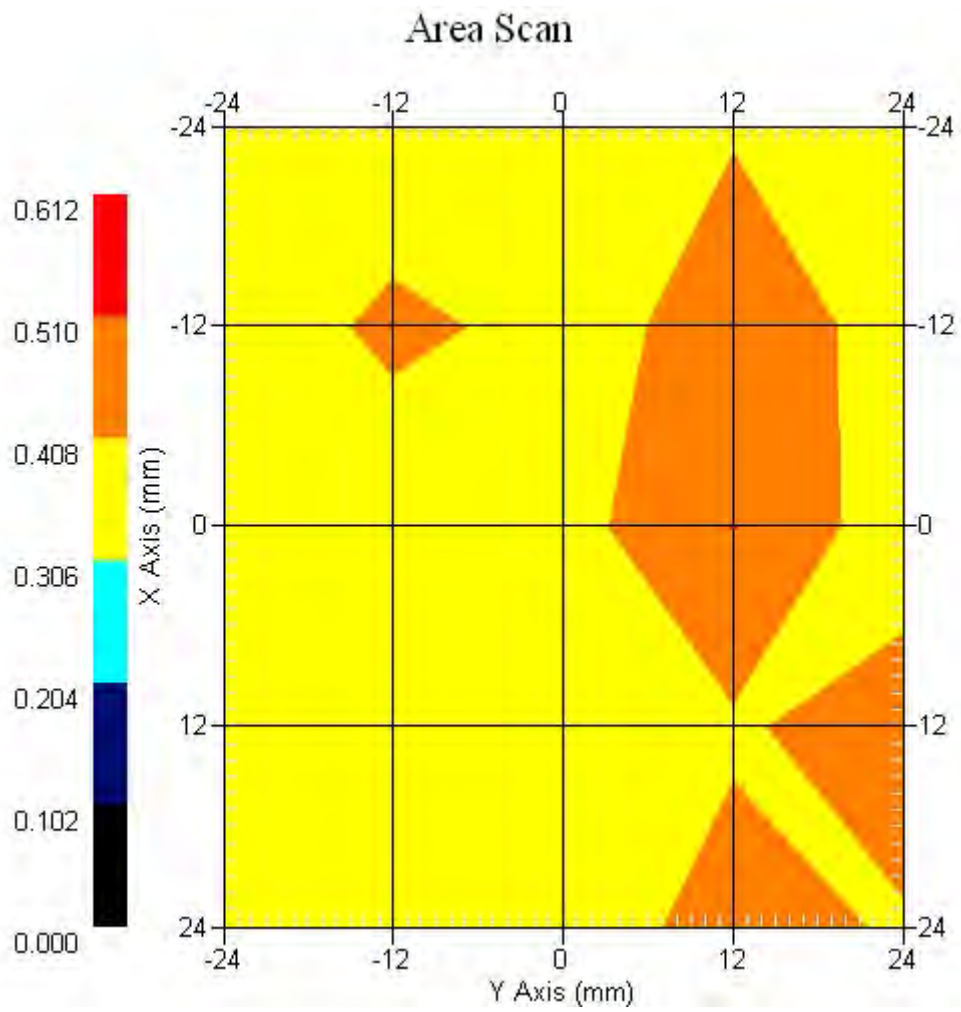

Measurement Data

Crest Factor : 1
Tissue Temp. : 21.10 °C
Ambient Temp. : 22.40 °C
Area Scan : 5x5x1 : Measurement x=12mm, y=12mm, z=4mm
Zoom Scan : 7x7x7 : Measurement x=5mm, y=5mm, z=5mm
Power Drift-Start : 0.198 W/kg
Power Drift-Finish: 0.193 W/kg
Power Drift (%) : -2.425

DUT Position : Touch EUT Back
Channel : 48

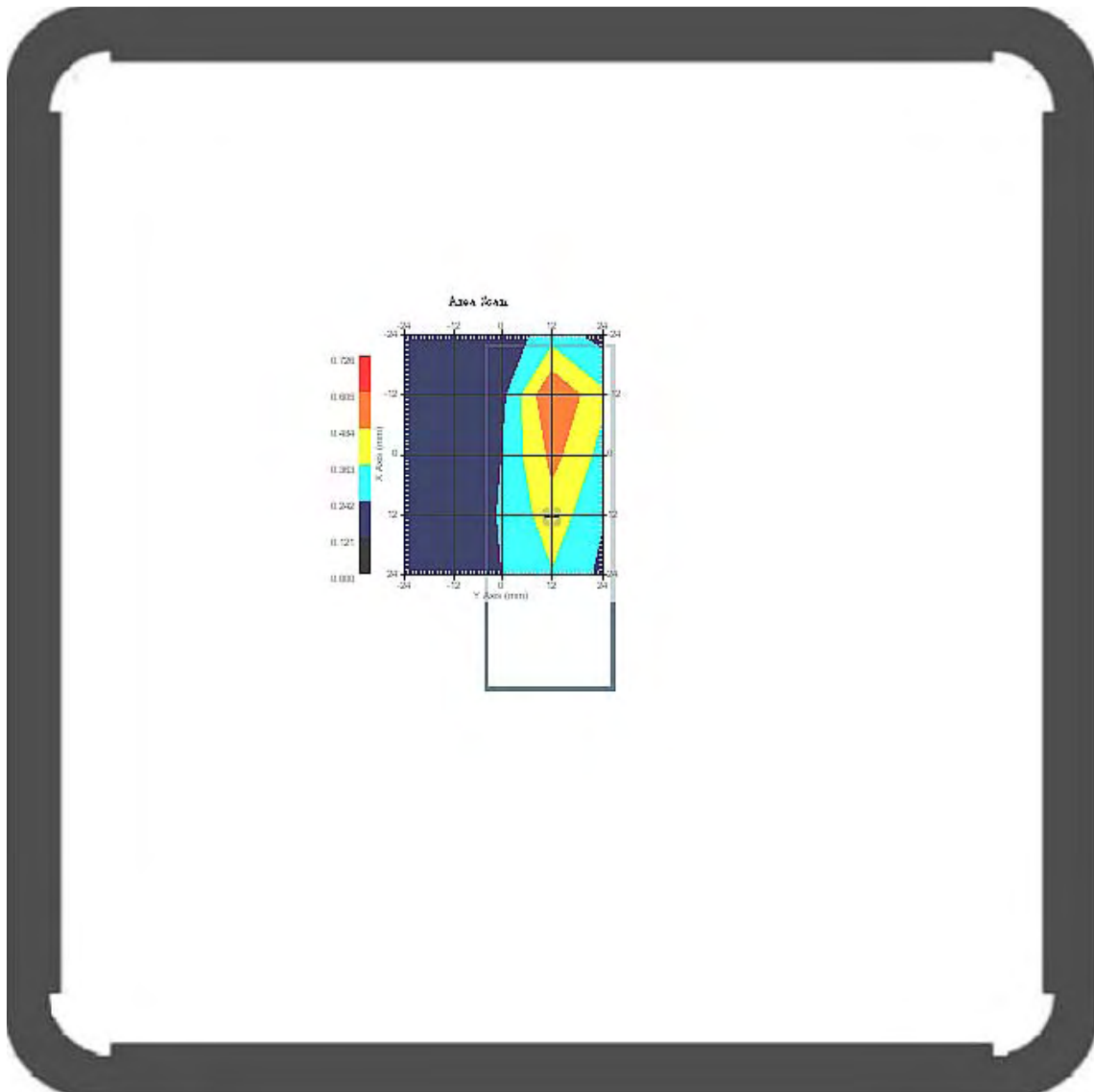

1 gram SAR value : 0.519 W/kg
10 gram SAR value : 0.301 W/kg
Area Scan Peak SAR : 0.607 W/kg
Zoom Scan Peak SAR : 1.010 W/kg

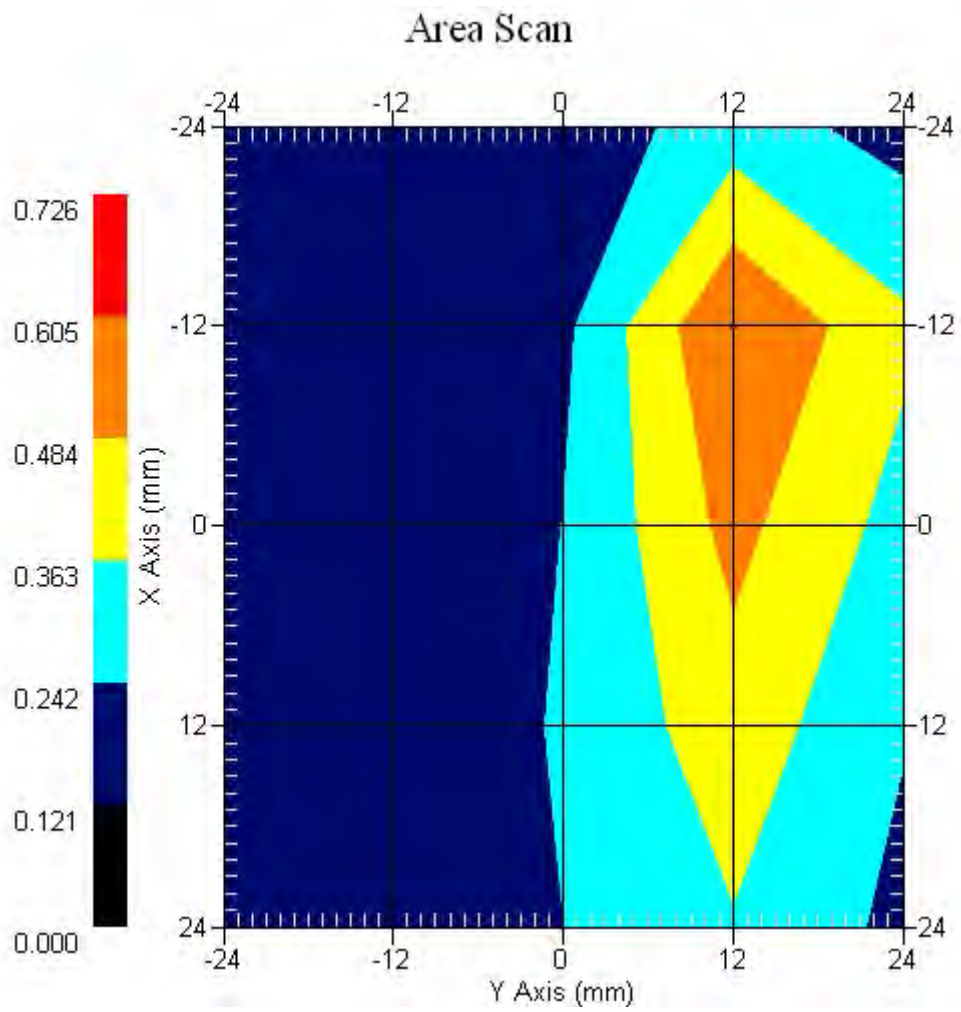

Measurement Data

Crest Factor : 1
Tissue Temp. : 21.10 °C
Ambient Temp. : 22.40 °C
Area Scan : 5x5x1 : Measurement x=12mm, y=12mm, z=4mm
Zoom Scan : 7x7x7 : Measurement x=5mm, y=5mm, z=5mm
Power Drift-Start : 0.205 W/kg
Power Drift-Finish: 0.198 W/kg
Power Drift (%) : -3.414

DUT Position : Touch EUT Back
Channel : 52

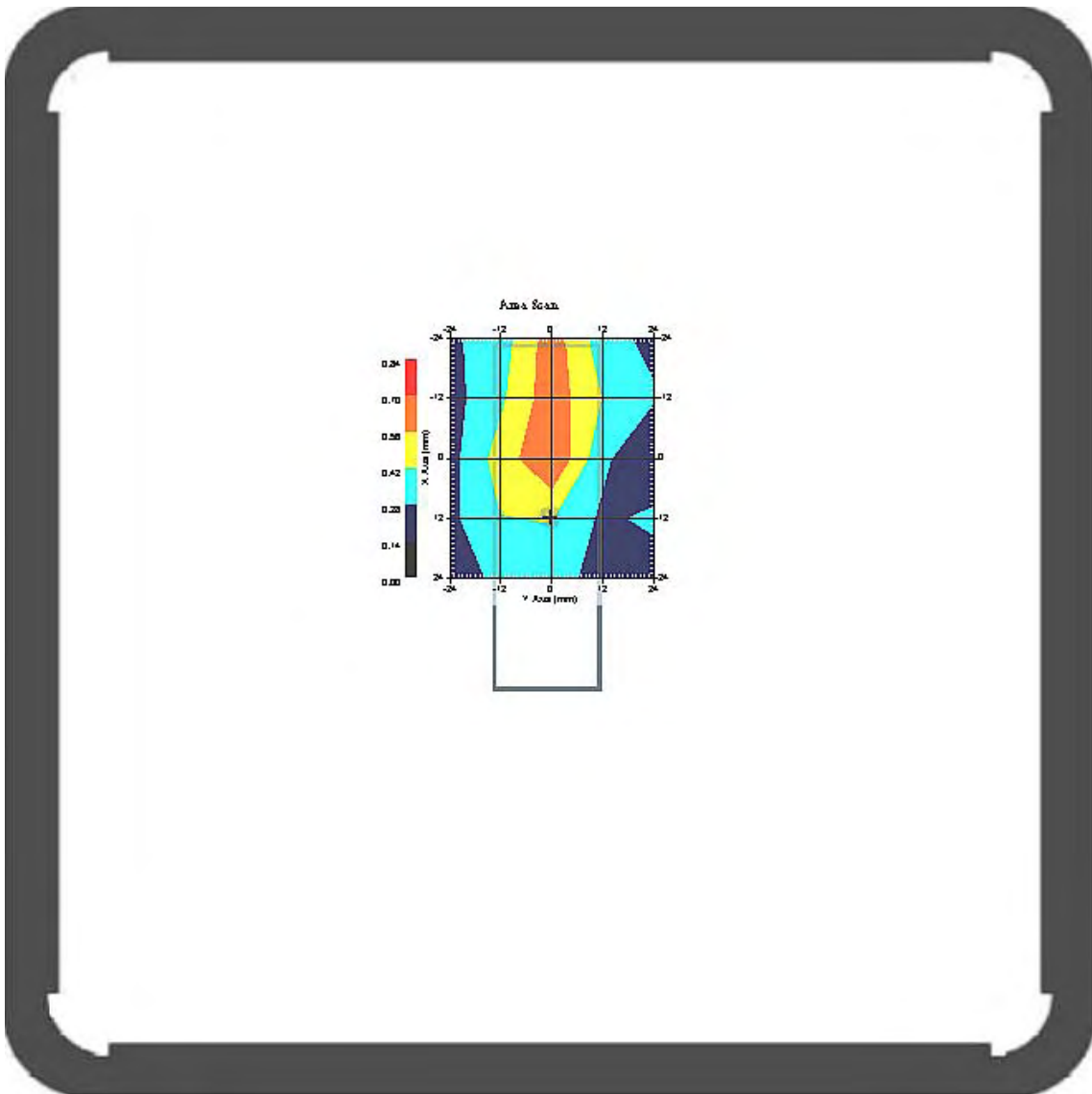

1 gram SAR value : 0.647 W/kg
10 gram SAR value : 0.394 W/kg
Area Scan Peak SAR : 0.702 W/kg
Zoom Scan Peak SAR : 1.471 W/kg

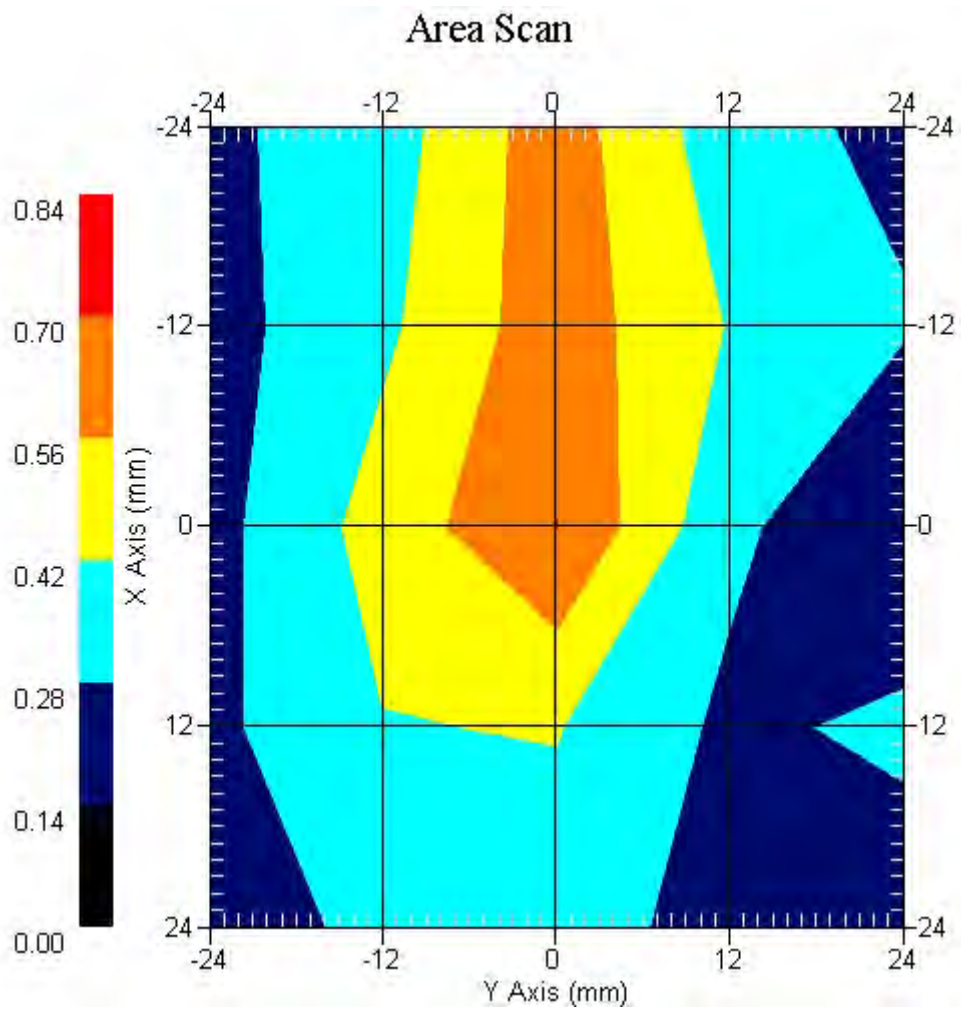

Measurement Data

Crest Factor : 1
Tissue Temp. : 21.10 °C
Ambient Temp. : 22.40 °C
Area Scan : 5x5x1 : Measurement x=12mm, y=12mm, z=4mm
Zoom Scan : 7x7x7 : Measurement x=5mm, y=5mm, z=5mm
Power Drift-Start : 0.171 W/kg
Power Drift-Finish: 0.165 W/kg
Power Drift (%) : -3.508

DUT Position : Touch EUT Back
Channel : 56

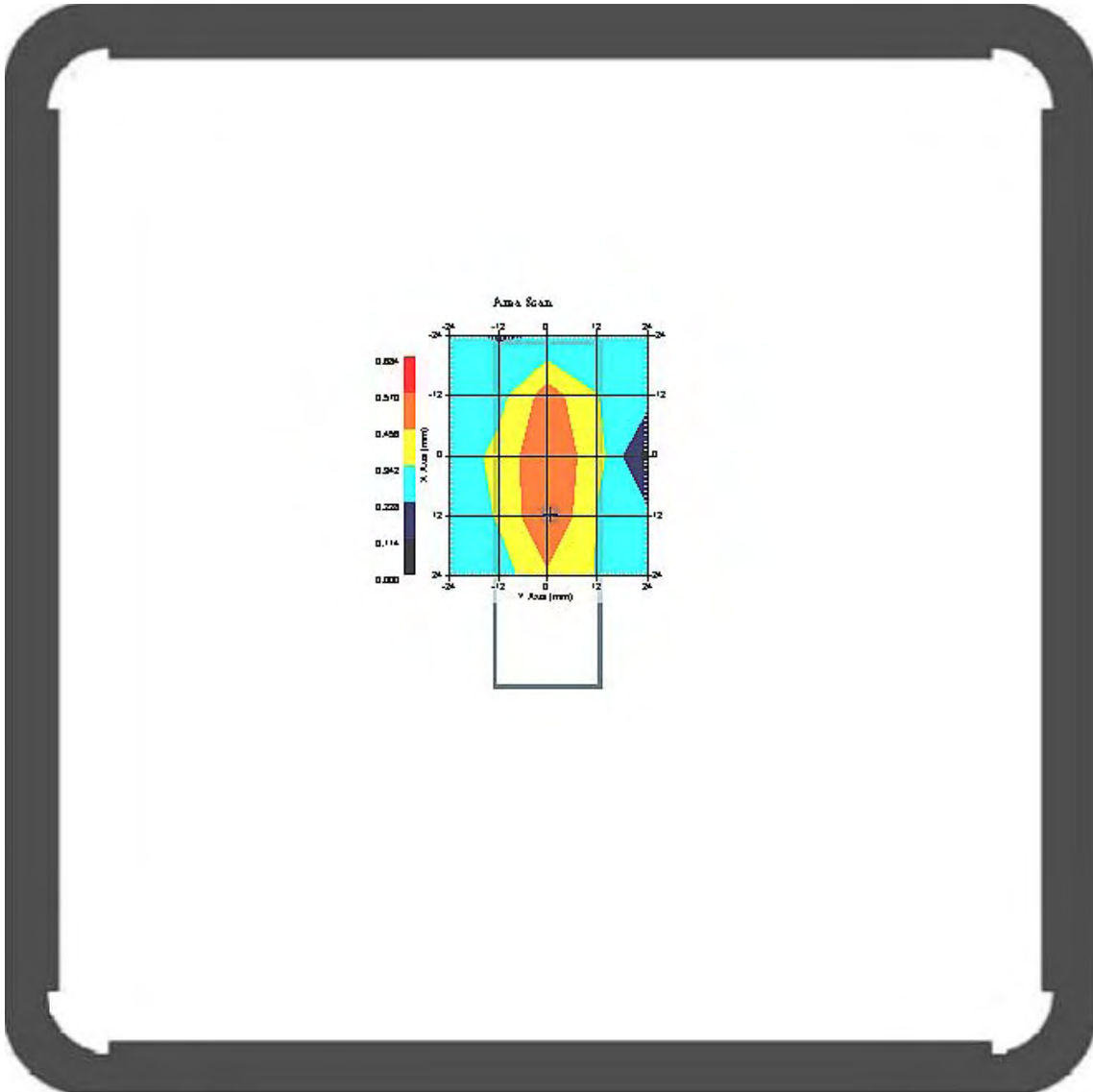

1 gram SAR value : 0.637 W/kg
10 gram SAR value : 0.402 W/kg
Area Scan Peak SAR : 0.571 W/kg
Zoom Scan Peak SAR : 1.601 W/kg

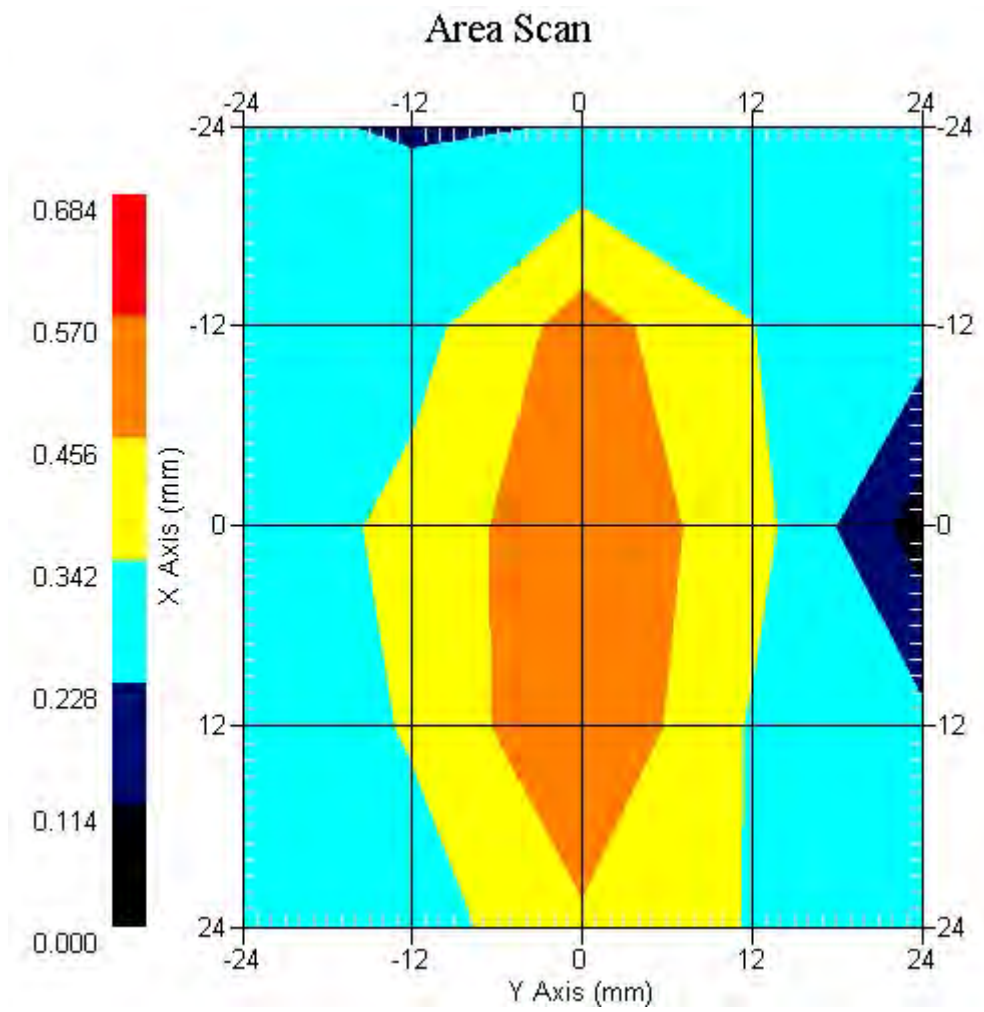

Measurement Data

Crest Factor : 1
Tissue Temp. : 21.10 °C
Ambient Temp. : 22.40 °C
Area Scan : 5x5x1 : Measurement x=12mm, y=12mm, z=4mm
Zoom Scan : 7x7x7 : Measurement x=5mm, y=5mm, z=5mm
Power Drift-Start : 0.262 W/kg
Power Drift-Finish: 0.274 W/kg
Power Drift (%) : -4.580

DUT Position : Touch EUT Back
Channel : 64

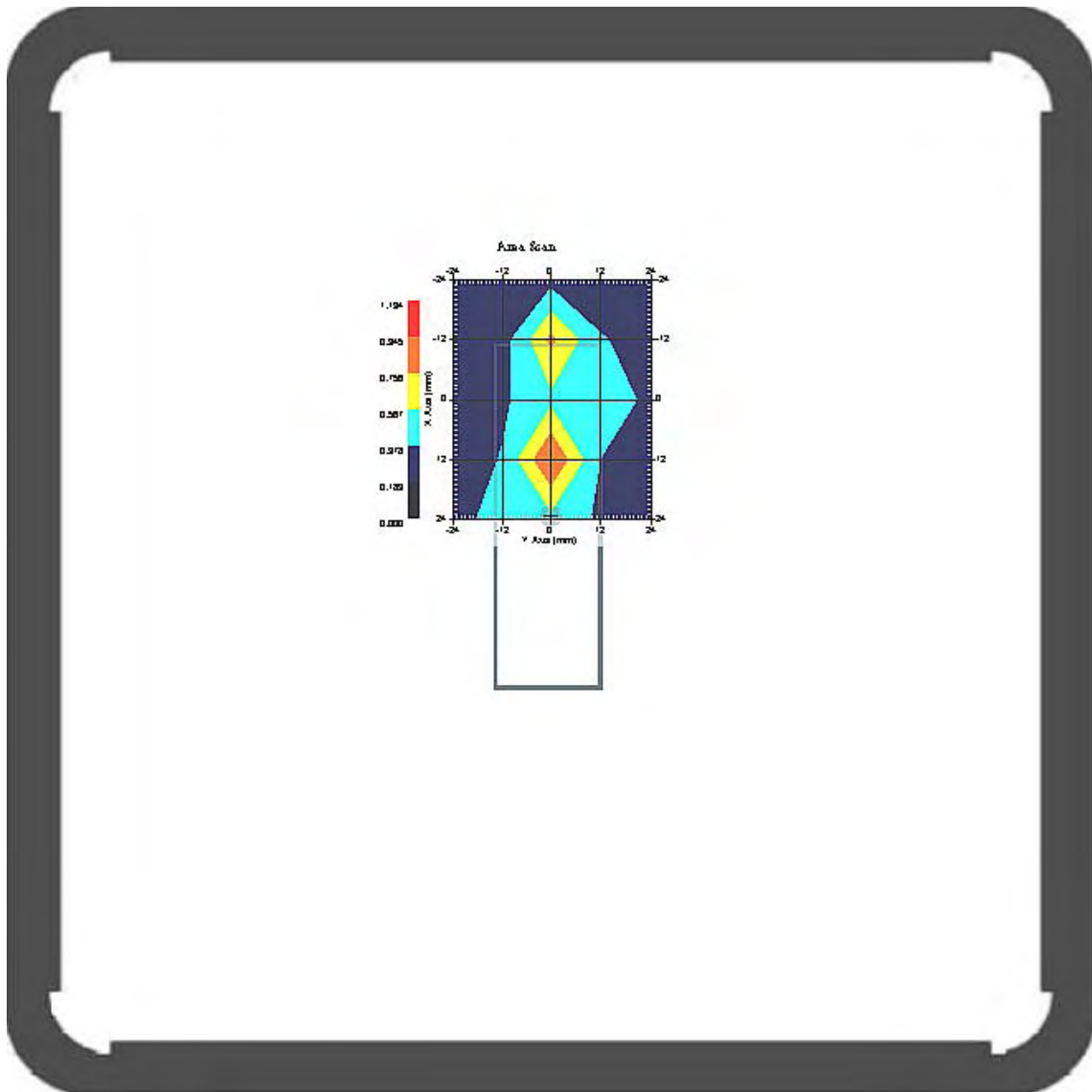

1 gram SAR value : 0.792 W/kg
10 gram SAR value : 0.463 W/kg
Area Scan Peak SAR : 0.947 W/kg
Zoom Scan Peak SAR : 1.831 W/kg

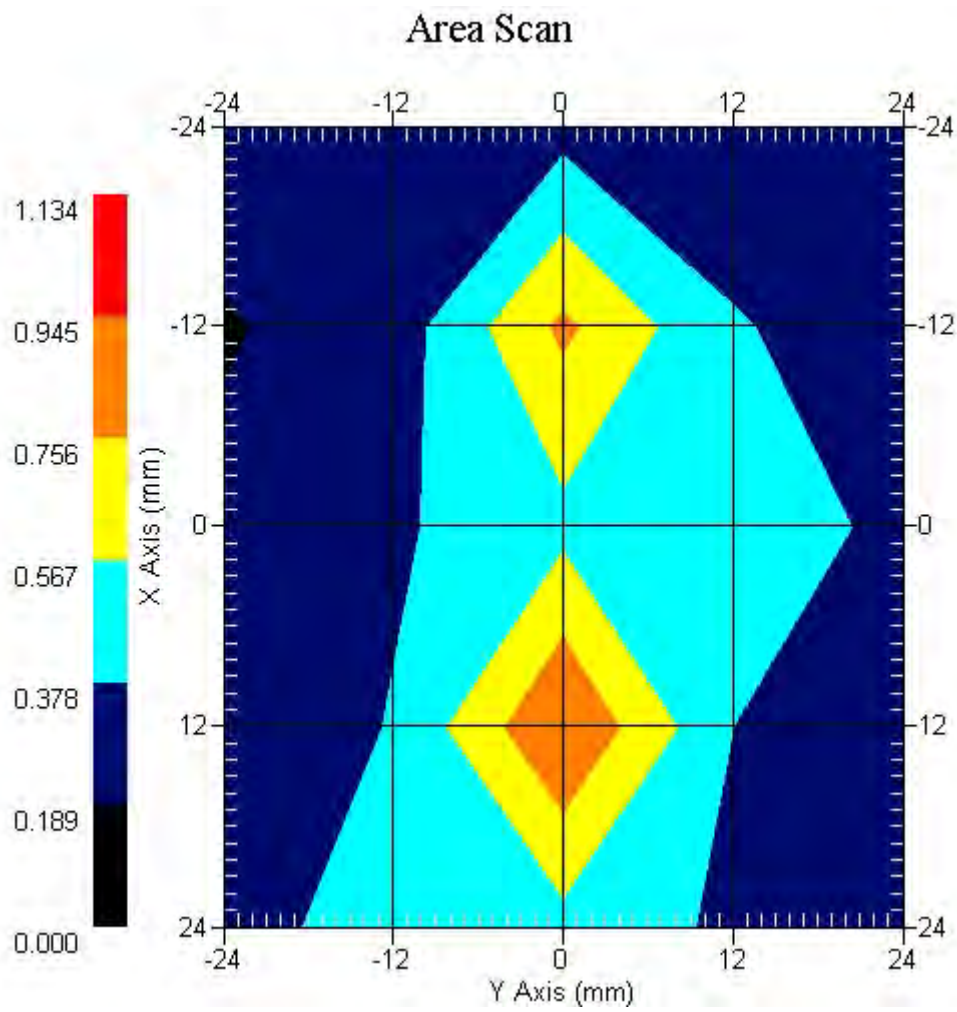

Measurement Data

Crest Factor : 1
Tissue Temp. : 21.10 °C
Ambient Temp. : 22.40 °C
Area Scan : 5x5x1 : Measurement x=12mm, y=12mm, z=4mm
Zoom Scan : 7x7x7 : Measurement x=5mm, y=5mm, z=5mm
Power Drift-Start : 0.577 W/kg
Power Drift-Finish: 0.559 W/kg
Power Drift (%) : -3.220

DUT Position : Touch EUT Top
Channel : 52

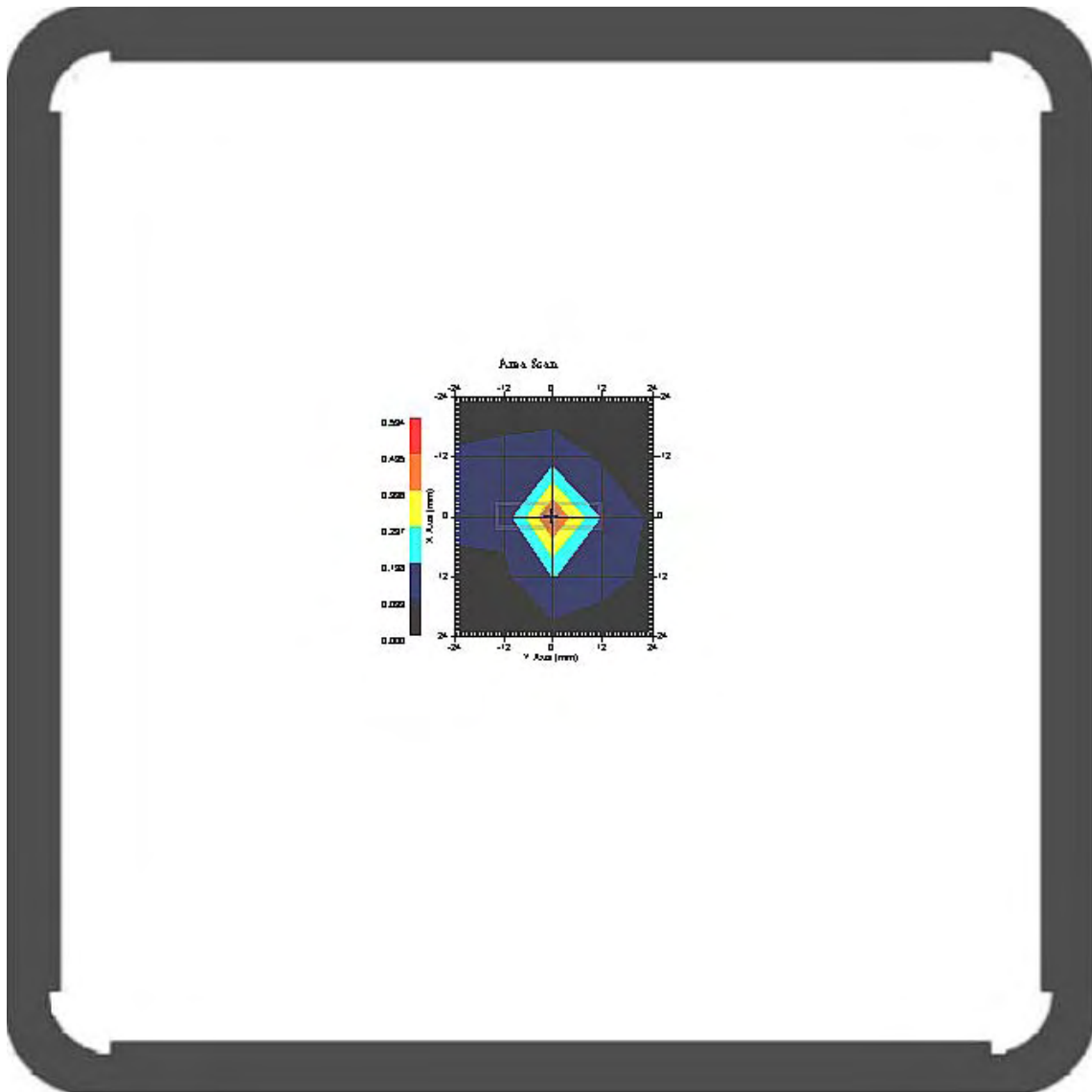

1 gram SAR value : 0.377 W/kg
10 gram SAR value : 0.172 W/kg
Area Scan Peak SAR : 0.497 W/kg
Zoom Scan Peak SAR : 0.820 W/kg

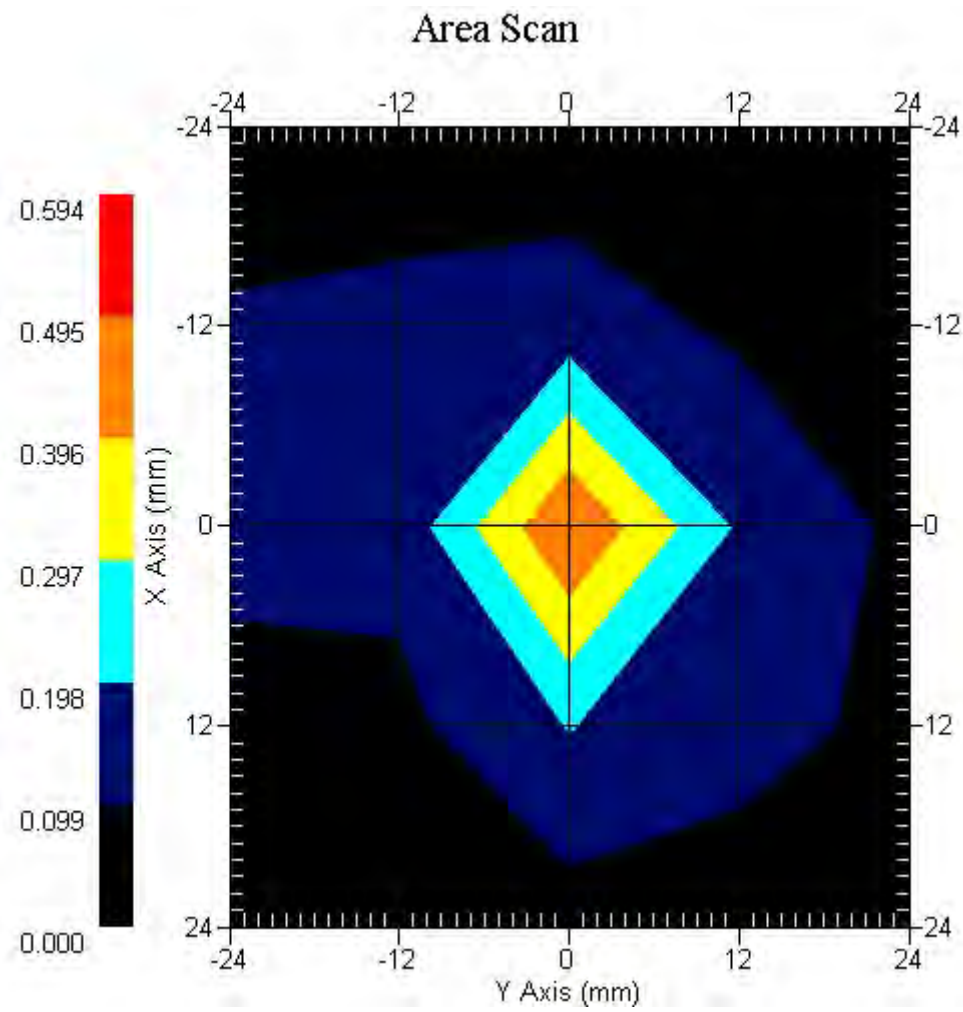

802.11a 5.2GHz with EUT Back, Z-Axis plot
channel: 64

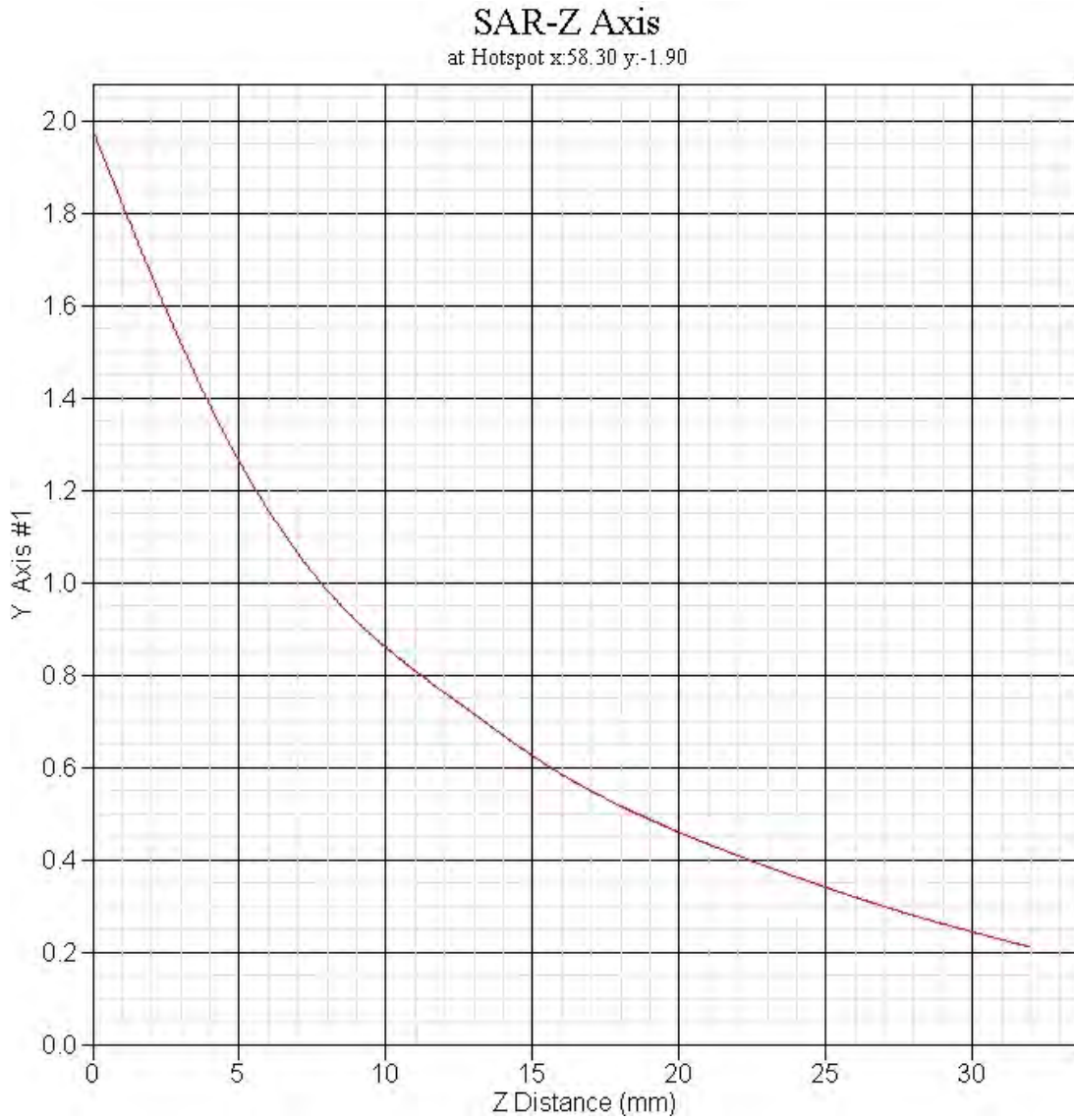

ALSAS-10U VER 2.3.2 APREL Laboratories

SAR Test Report -802.11a 5.2GHz Super

Report Date : 18-Dec-2007
Measurement Date : 18-Dec-2007

Product Data

Device Name : USB
Type : Other
Model : WLU108AG-MC
Frequency : 5200.00 MHz
Drift Time : 0 min(s)
Length : 82 mm
Width : 27 mm
Depth : 8 mm
Antenna Type : Internal

Phantom Data

Type : Uni-Phantom
Size (mm) : 280 x 280 x 200
Location : Center

Tissue Data

Type : BODY
Serial No. : 326-B
Frequency : 5200.00 MHz
Last Calib. Date : 18-Dec-2007
Temperature : 21.10 °C
Ambient Temp. : 22.40 °C
Humidity : 51.00 RH%
Epsilon : 47.21 F/m
Sigma : 5.314 S/m
Density : 1000.00 kg/cu. m

Probe Data

Name : Probe 264
Model : E020
Type : E-Field Triangle
Serial No. : 264
Last Calib. Date : 22-Aug-2007
Frequency : 5200.00 MHz
Duty Cycle Factor: 1
Conversion Factor: 4.5
Probe Sensitivity: 0.61 0.61 0.61 $\mu\text{V}/(\text{V}/\text{m})^2$
Compression Point: 95.00 mV
Offset : 1.56 mm

Measurement Data

Crest Factor : 1
Tissue Temp. : 21.10 °C
Ambient Temp. : 22.40 °C
Area Scan : 5x5x1 : Measurement x=12mm, y=12mm, z=4mm
Zoom Scan : 7x7x7 : Measurement x=5mm, y=5mm, z=5mm
Power Drift-Start : 0.207 W/kg
Power Drift-Finish: 0.211 W/kg
Power Drift (%) : -1.932

DUT Position : Touch EUT Front
Channel : 56

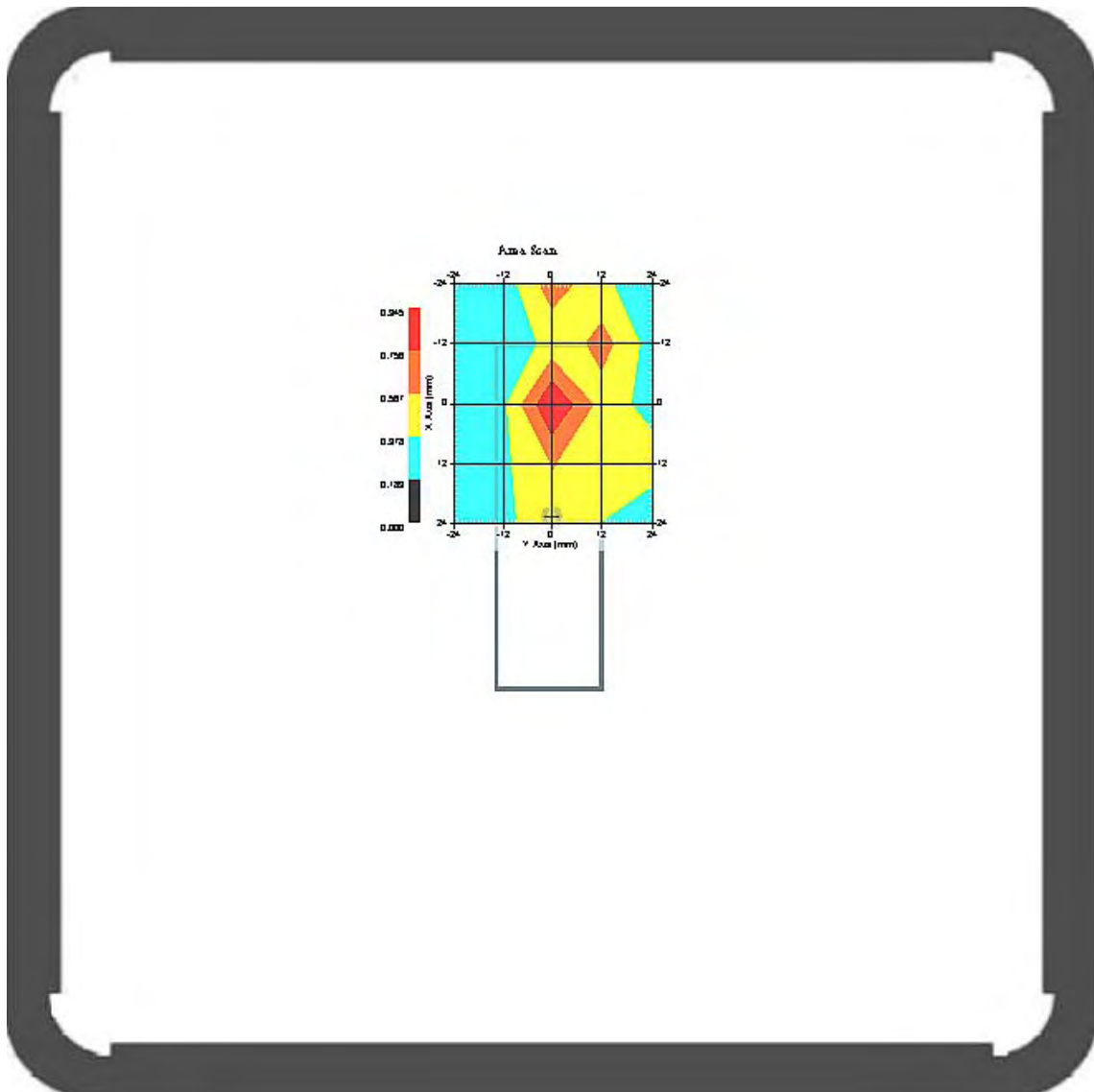

1 gram SAR value : 0.789 W/kg
10 gram SAR value : 0.534 W/kg
Area Scan Peak SAR : 0.945 W/kg
Zoom Scan Peak SAR : 1.831 W/kg

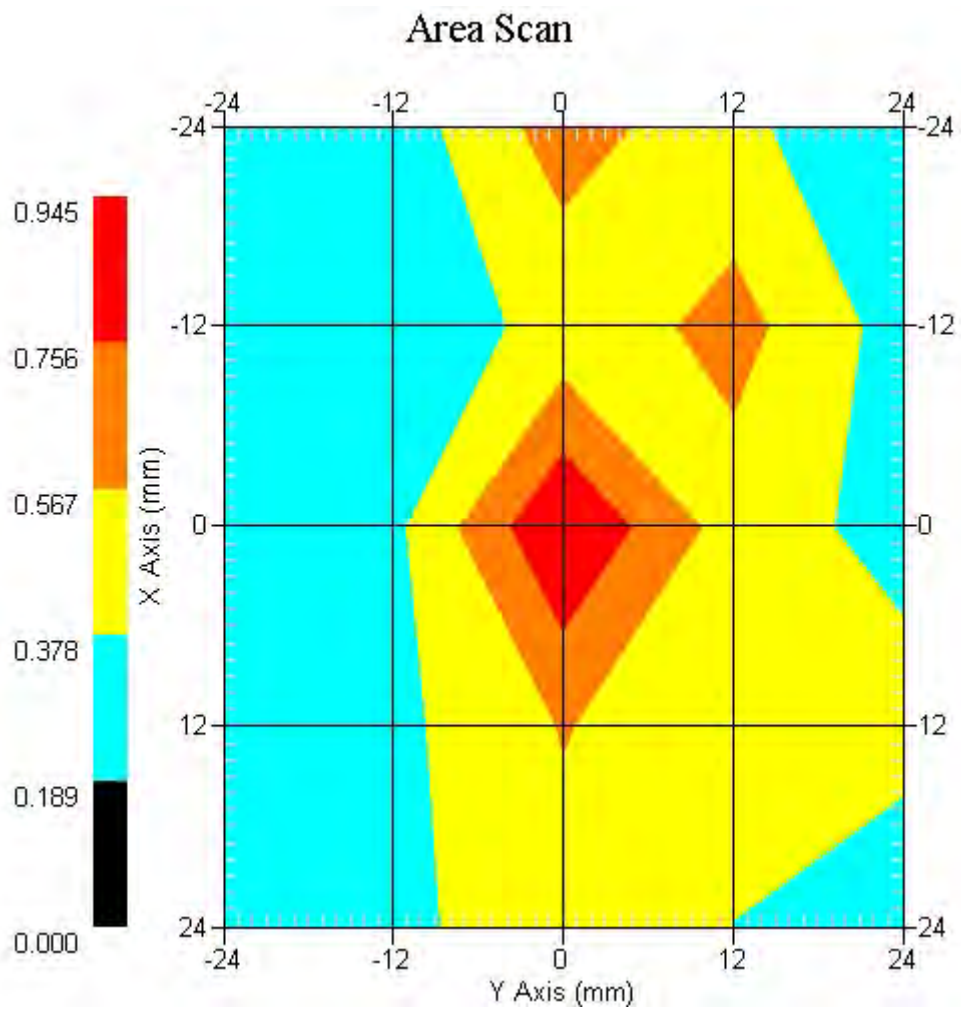

Measurement Data

Crest Factor : 1
 Tissue Temp. : 21.10 °C
 Ambient Temp. : 22.40 °C
 Area Scan : 5x5x1 : Measurement x=12mm, y=12mm, z=4mm
 Zoom Scan : 7x7x7 : Measurement x=5mm, y=5mm, z=5mm
 Power Drift-Start : 0.202 W/kg
 Power Drift-Finish: 0.195 W/kg
 Power Drift (%) : -3.465

DUT Position : Touch EUT Back
 Channel : 40

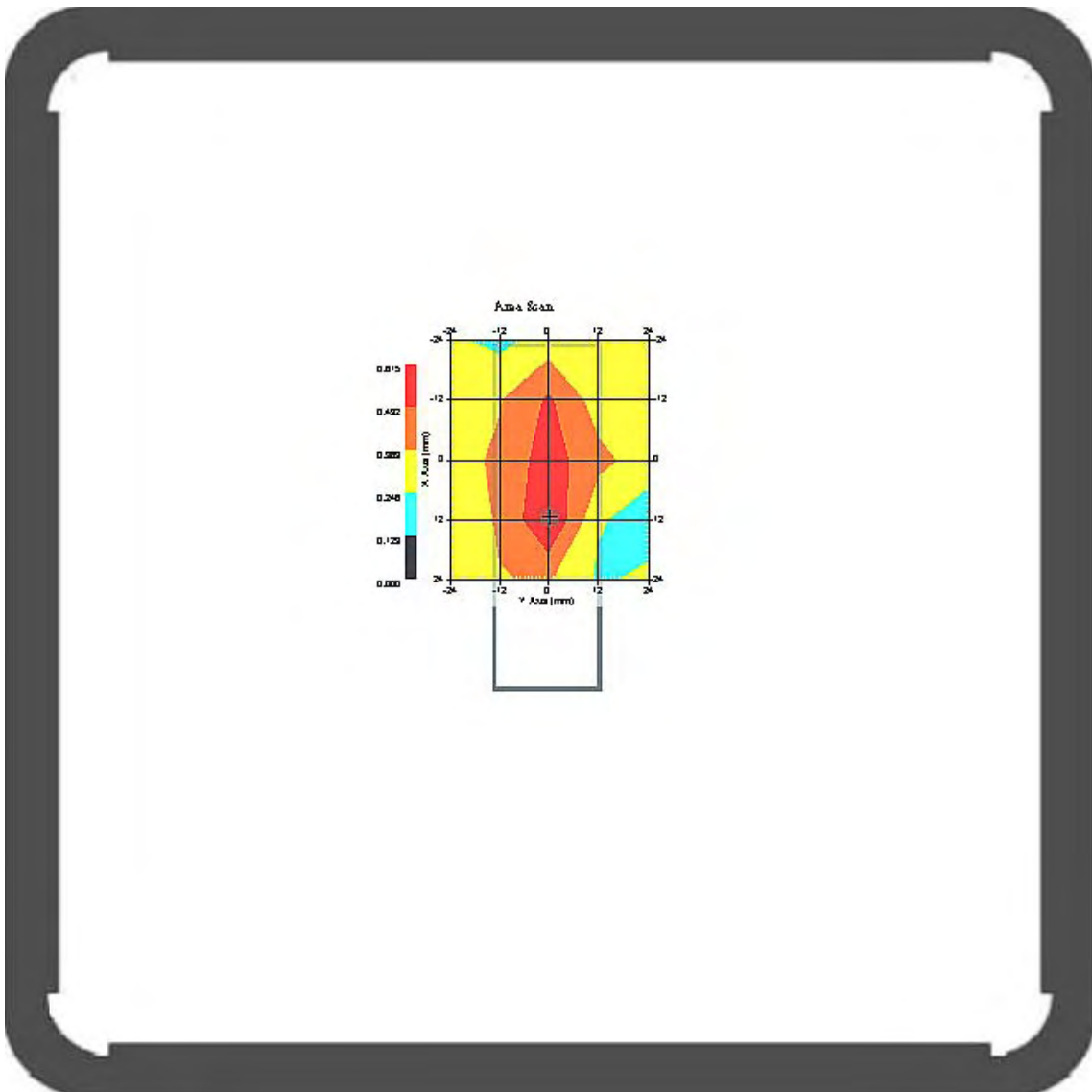

1 gram SAR value : 0.586 W/kg
 10 gram SAR value : 0.393 W/kg
 Area Scan Peak SAR : 0.614 W/kg
 Zoom Scan Peak SAR : 0.970 W/kg

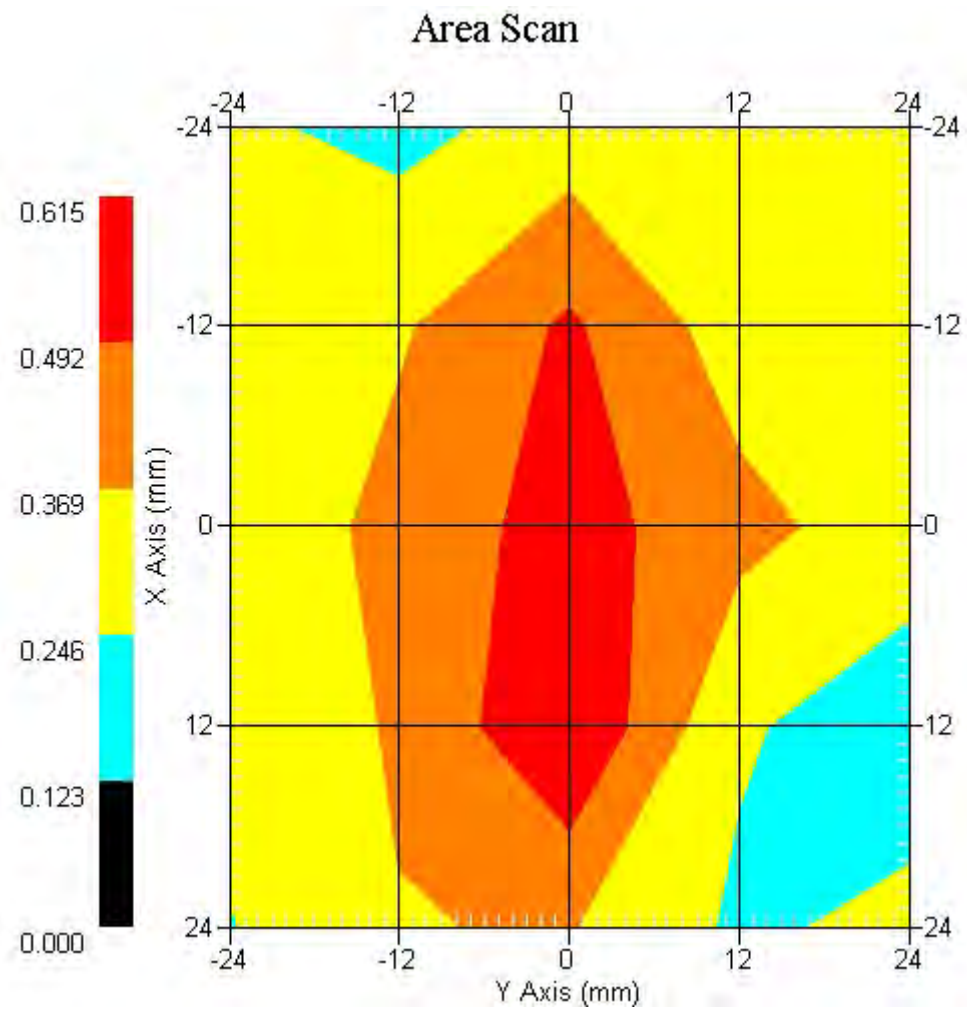

Measurement Data

Crest Factor : 1
Tissue Temp. : 21.10 °C
Ambient Temp. : 22.40 °C
Area Scan : 5x5x1 : Measurement x=12mm, y=12mm, z=4mm
Zoom Scan : 7x7x7 : Measurement x=5mm, y=5mm, z=5mm
Power Drift-Start : 0.176 W/kg
Power Drift-Finish: 0.183 W/kg
Power Drift (%) : 3.977

DUT Position : Touch EUT Back
Channel : 44

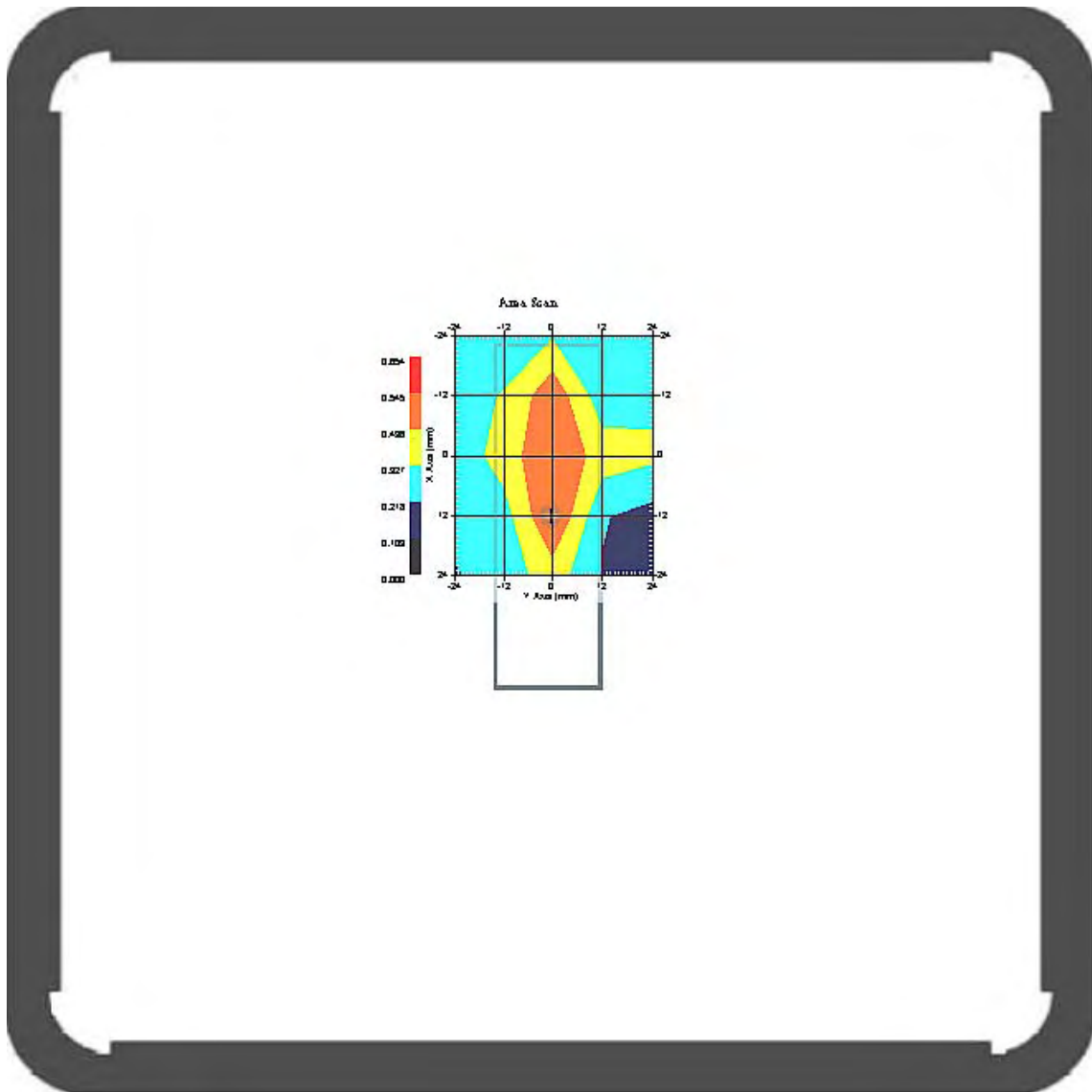

1 gram SAR value : 0.591 W/kg
10 gram SAR value : 0.390 W/kg
Area Scan Peak SAR : 0.546 W/kg
Zoom Scan Peak SAR : 0.800 W/kg

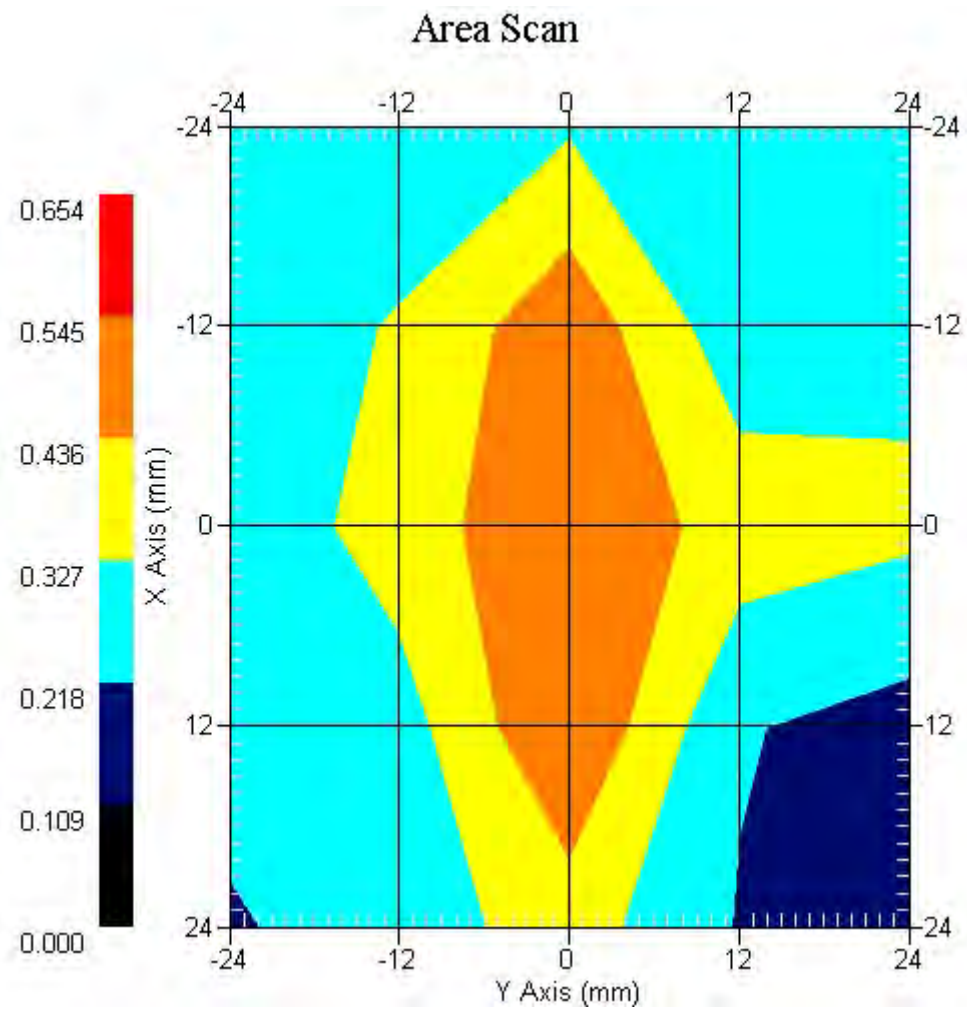

Measurement Data

Crest Factor : 1
Tissue Temp. : 21.10 °C
Ambient Temp. : 22.40 °C
Area Scan : 5x5x1 : Measurement x=12mm, y=12mm, z=4mm
Zoom Scan : 7x7x7 : Measurement x=5mm, y=5mm, z=5mm
Power Drift-Start : 0.227 W/kg
Power Drift-Finish: 0.234 W/kg
Power Drift (%) : -3.083

DUT Position : Touch EUT Back
Channel : 56

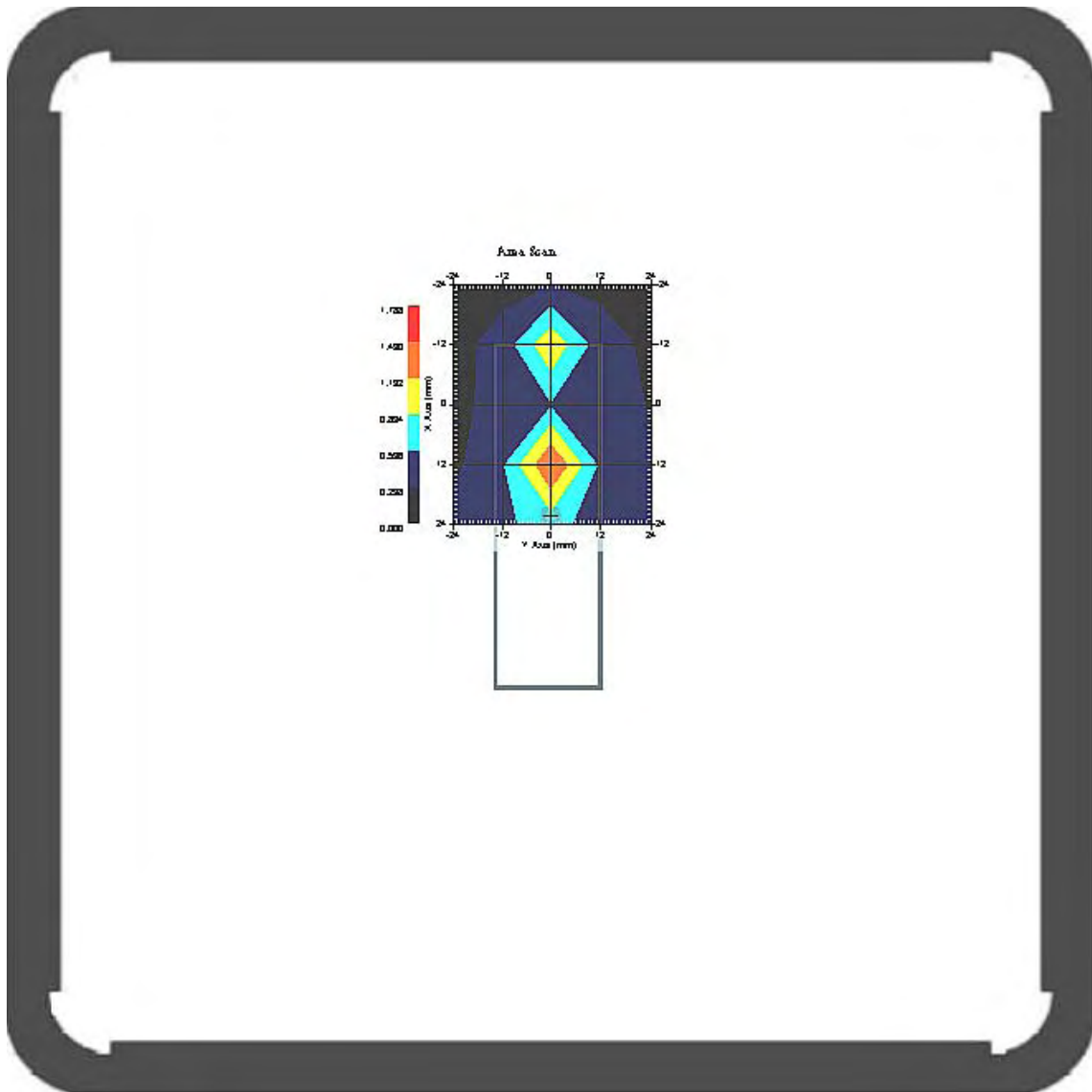

1 gram SAR value : 1.205 W/kg
10 gram SAR value : 0.612 W/kg
Area Scan Peak SAR : 1.492 W/kg
Zoom Scan Peak SAR : 3.052 W/kg

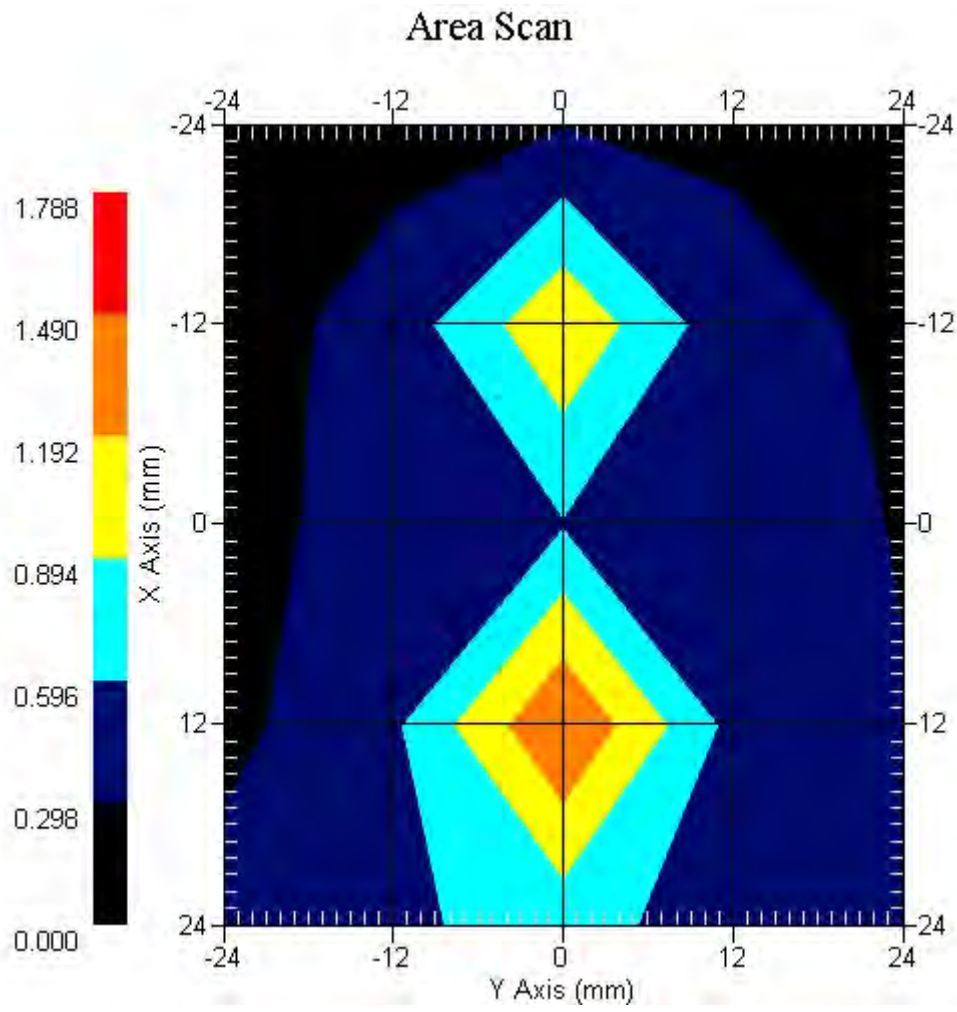

Measurement Data

Crest Factor : 1
Tissue Temp. : 21.10 °C
Ambient Temp. : 22.40 °C
Area Scan : 5x5x1 : Measurement x=12mm, y=12mm, z=4mm
Zoom Scan : 7x7x7 : Measurement x=5mm, y=5mm, z=5mm
Power Drift-Start : 0.198 W/kg
Power Drift-Finish: 0.193 W/kg
Power Drift (%) : -2.552

DUT Position : Touch EUT Back
Channel : 64

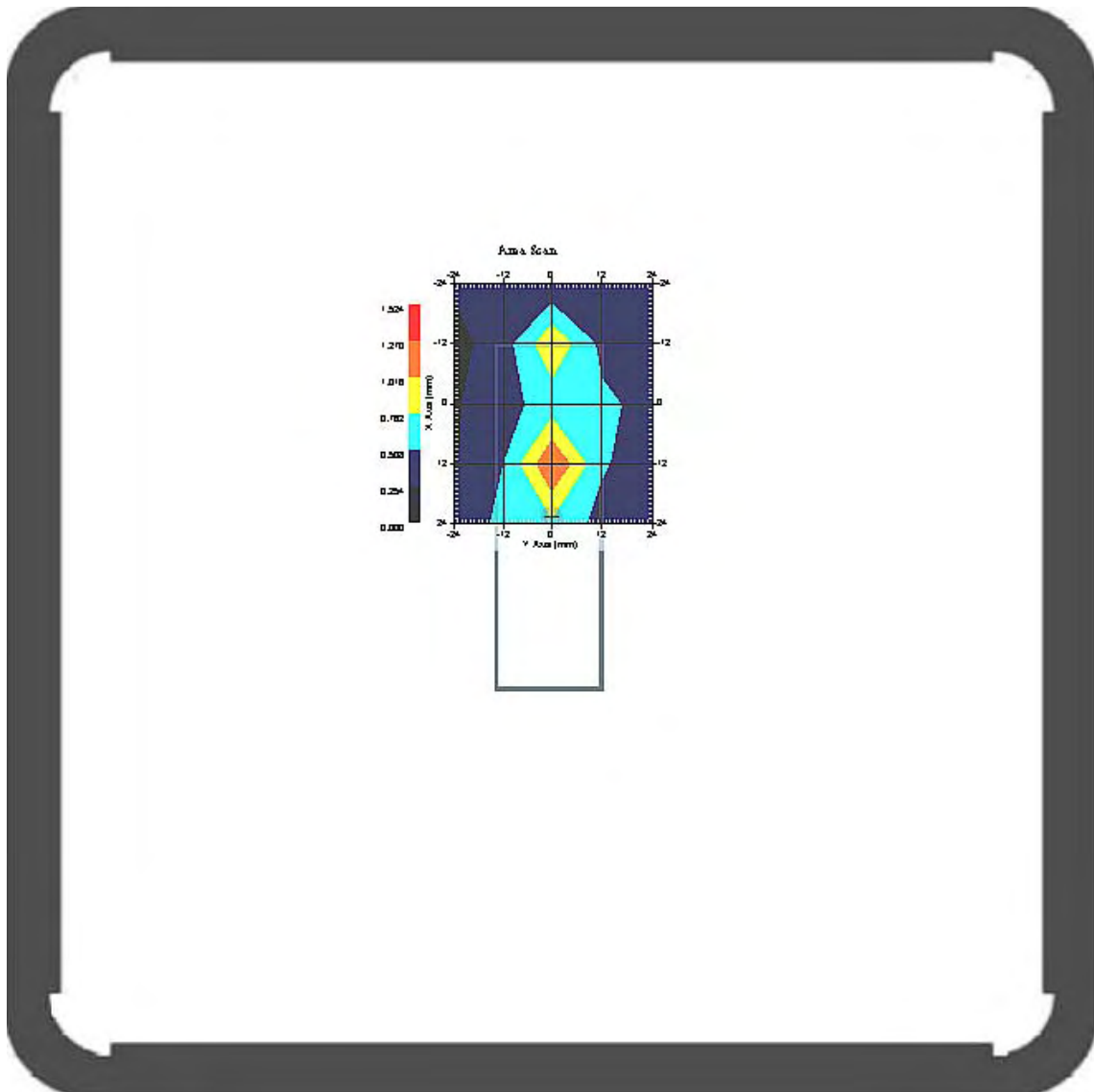

1 gram SAR value : 1.185 W/kg
10 gram SAR value : 0.603 W/kg
Area Scan Peak SAR : 1.272 W/kg
Zoom Scan Peak SAR : 2.722 W/kg

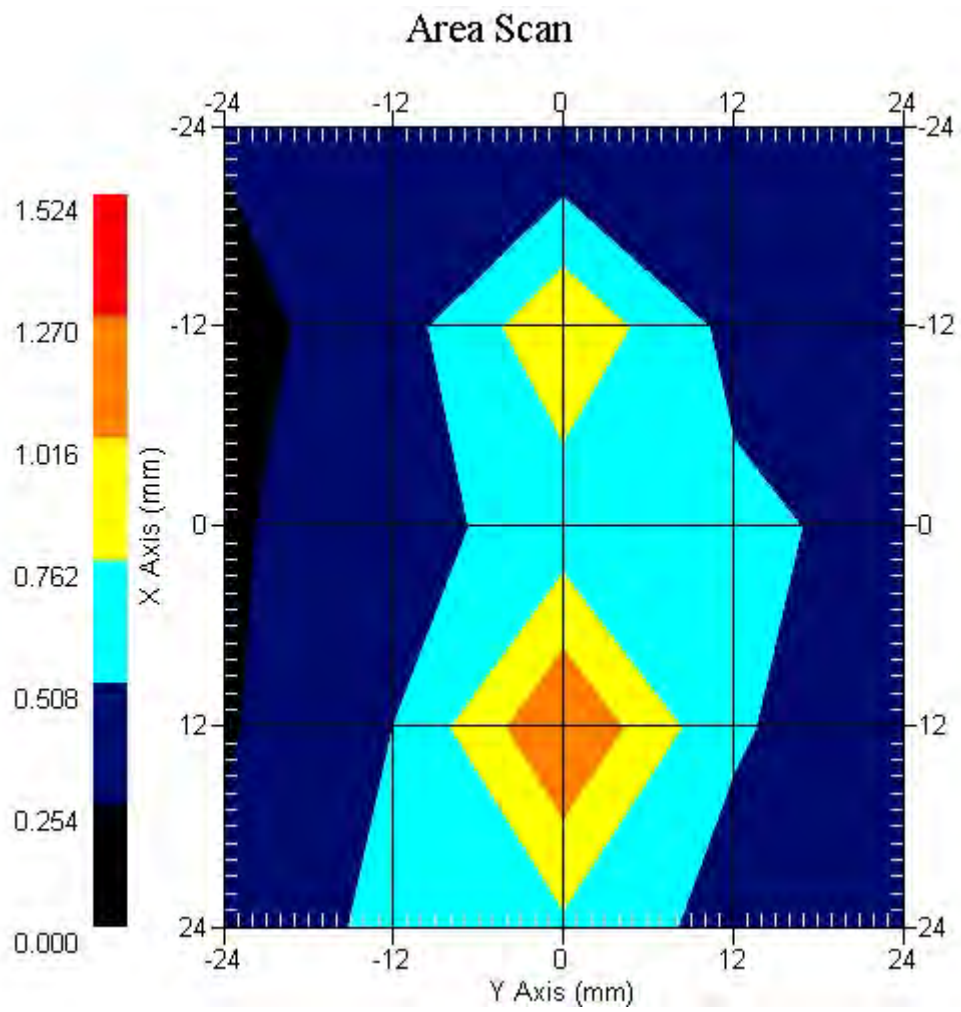

Measurement Data

Crest Factor : 1
Tissue Temp. : 21.10 °C
Ambient Temp. : 22.40 °C
Area Scan : 5x5x1 : Measurement x=12mm, y=12mm, z=4mm
Zoom Scan : 7x7x7 : Measurement x=5mm, y=5mm, z=5mm
Power Drift-Start : 0.648 W/kg
Power Drift-Finish: 0.676 W/kg
Power Drift (%) : 4.142

DUT Position : Touch EUT Top
Channel : 56

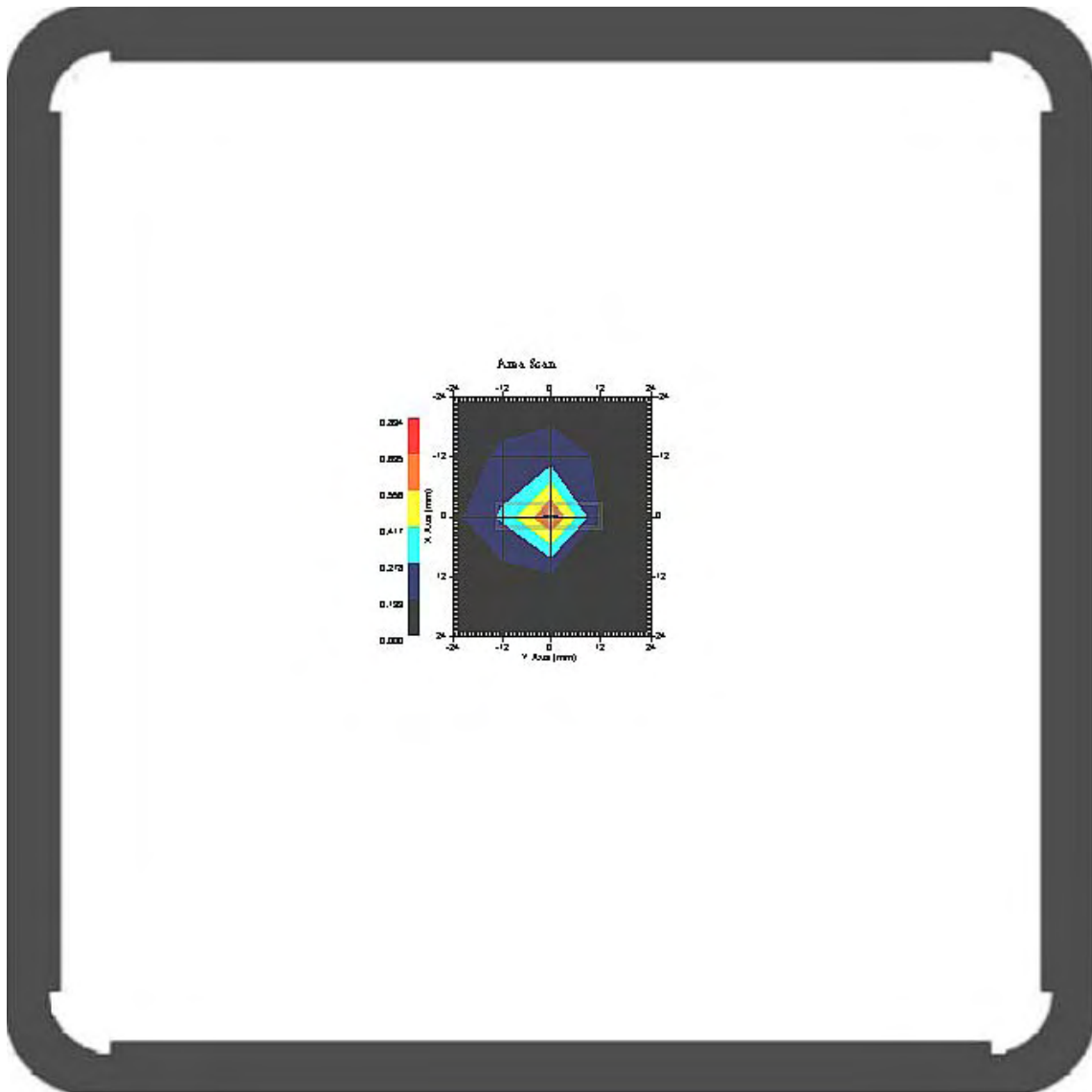

1 gram SAR value : 0.541 W/kg
10 gram SAR value : 0.231 W/kg
Area Scan Peak SAR : 0.696 W/kg
Zoom Scan Peak SAR : 1.381 W/kg

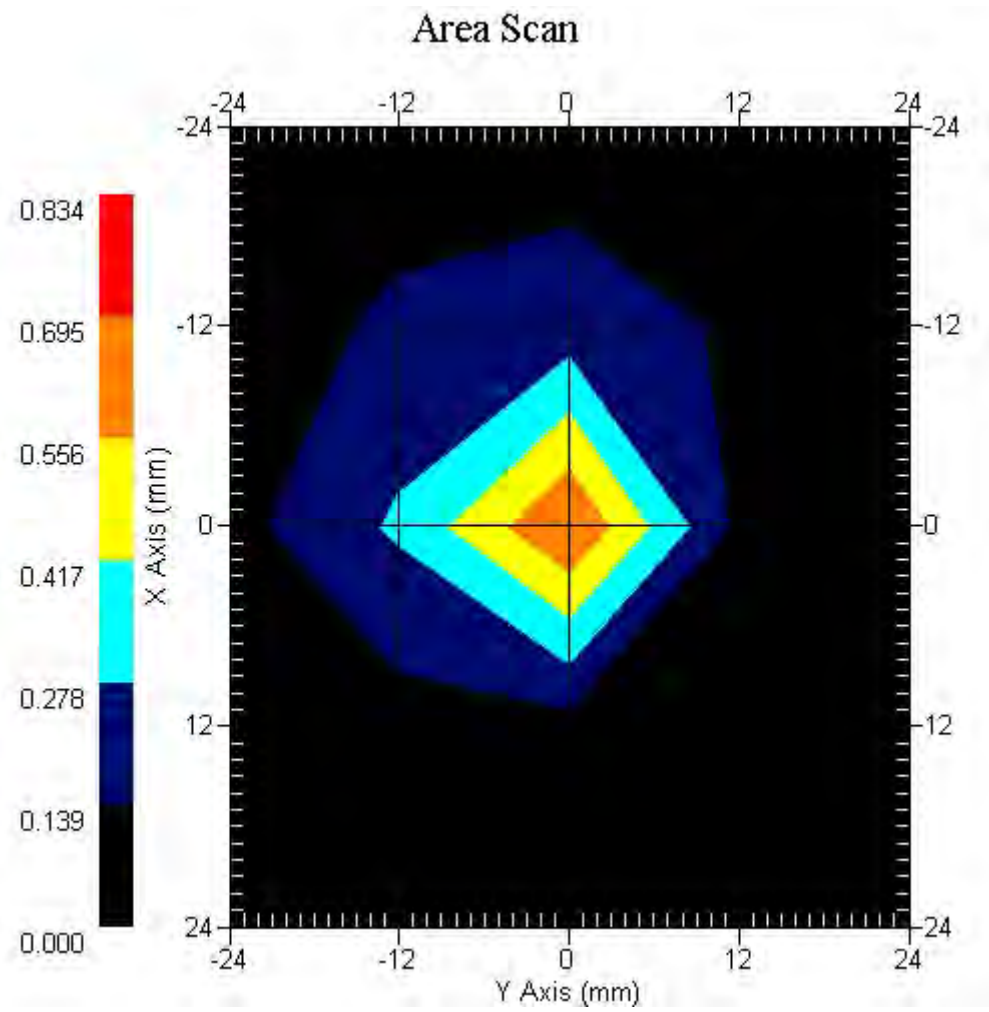

802.11a 5.2 GHz Super with EUT Back
channel: 56

SAR-Z Axis
at Hotspot x:0.00 y:-6.01

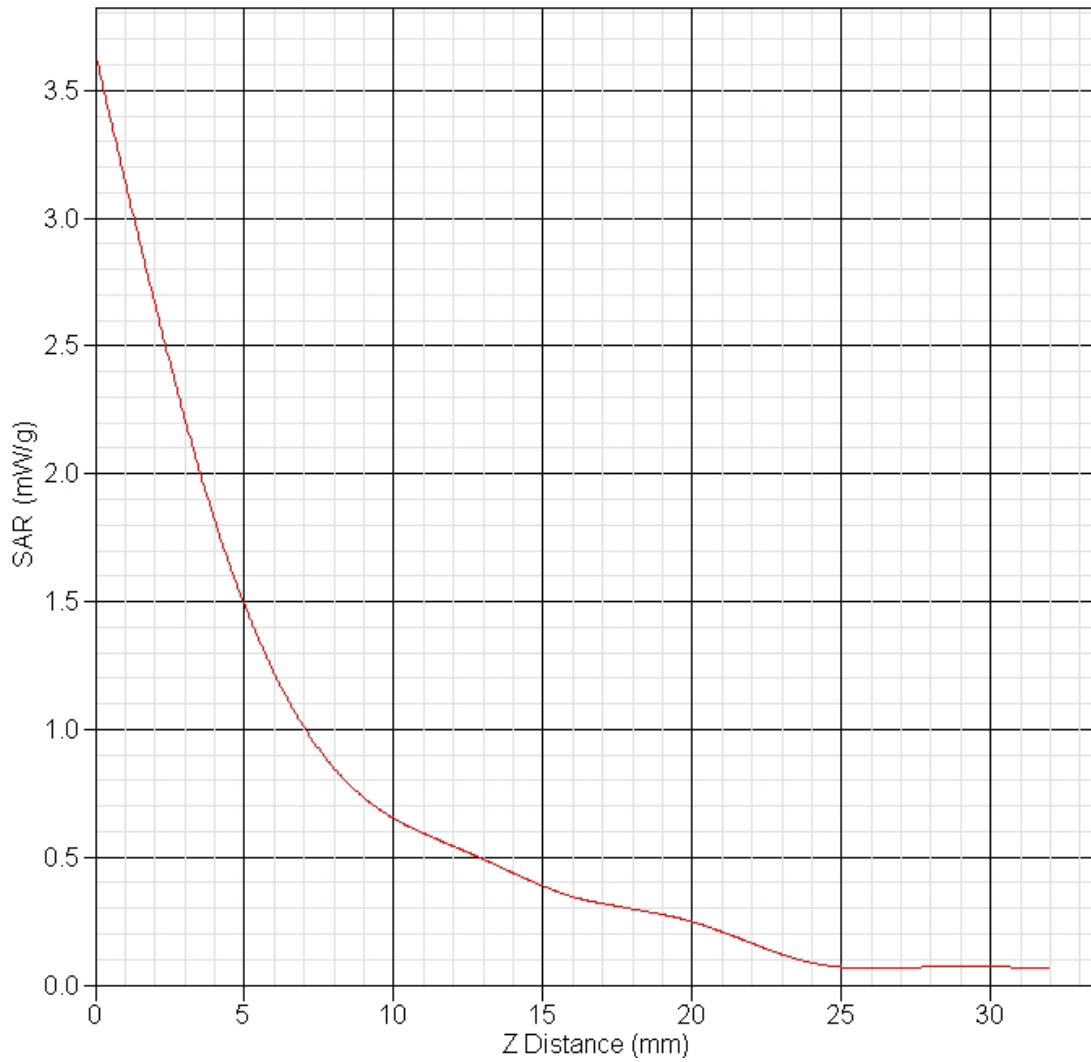

ALSAS-10U VER 2.3.2 APREL Laboratories
SAR Test Report -802.11a 5.8GHz

Report Date : 17-Dec-2007
Measurement Date : 17-Dec-2007

Product Data

Device Name : USB
Type : Other
Model : WLU108AG-MC
Frequency : 5800.00 MHz
Drift Time : 0 min(s)
Length : 82 mm
Width : 27 mm
Depth : 8 mm
Antenna Type : Internal

Phantom Data

Type : Uni-Phantom
Size (mm) : 280 x 280 x 200
Location : Center

Tissue Data

Type : BODY
Serial No. : 327-B
Frequency : 5800.00 MHz
Last Calib. Date : 17-Dec-2007
Temperature : 21.10 °C
Ambient Temp. : 22.40 °C
Humidity : 51.00 RH%
Epsilon : 48.31 F/m
Sigma : 6.124 S/m
Density : 1000.00 kg/cu. m

Probe Data

Name : Probe 264
Model : E020
Type : E-Field Triangle
Serial No. : 264
Last Calib. Date : 23-Aug-2007
Frequency : 5800.00 MHz
Duty Cycle Factor: 1
Conversion Factor: 4.3
Probe Sensitivity: 0.61 0.61 0.61 $\mu\text{V}/(\text{V}/\text{m})^2$
Compression Point: 95.00 mV
Offset : 1.56 mm

Measurement Data

Crest Factor : 1
Tissue Temp. : 21.10 °C
Ambient Temp. : 22.40 °C
Area Scan : 5x5x1 : Measurement x=12mm, y=12mm, z=4mm
Zoom Scan : 7x7x7 : Measurement x=5mm, y=5mm, z=5mm
Power Drift-Start : 0.261 W/kg
Power Drift-Finish: 0.266 W/kg
Power Drift (%) : 1.532

DUT Position : Touch EUT Front
Channel : 5800

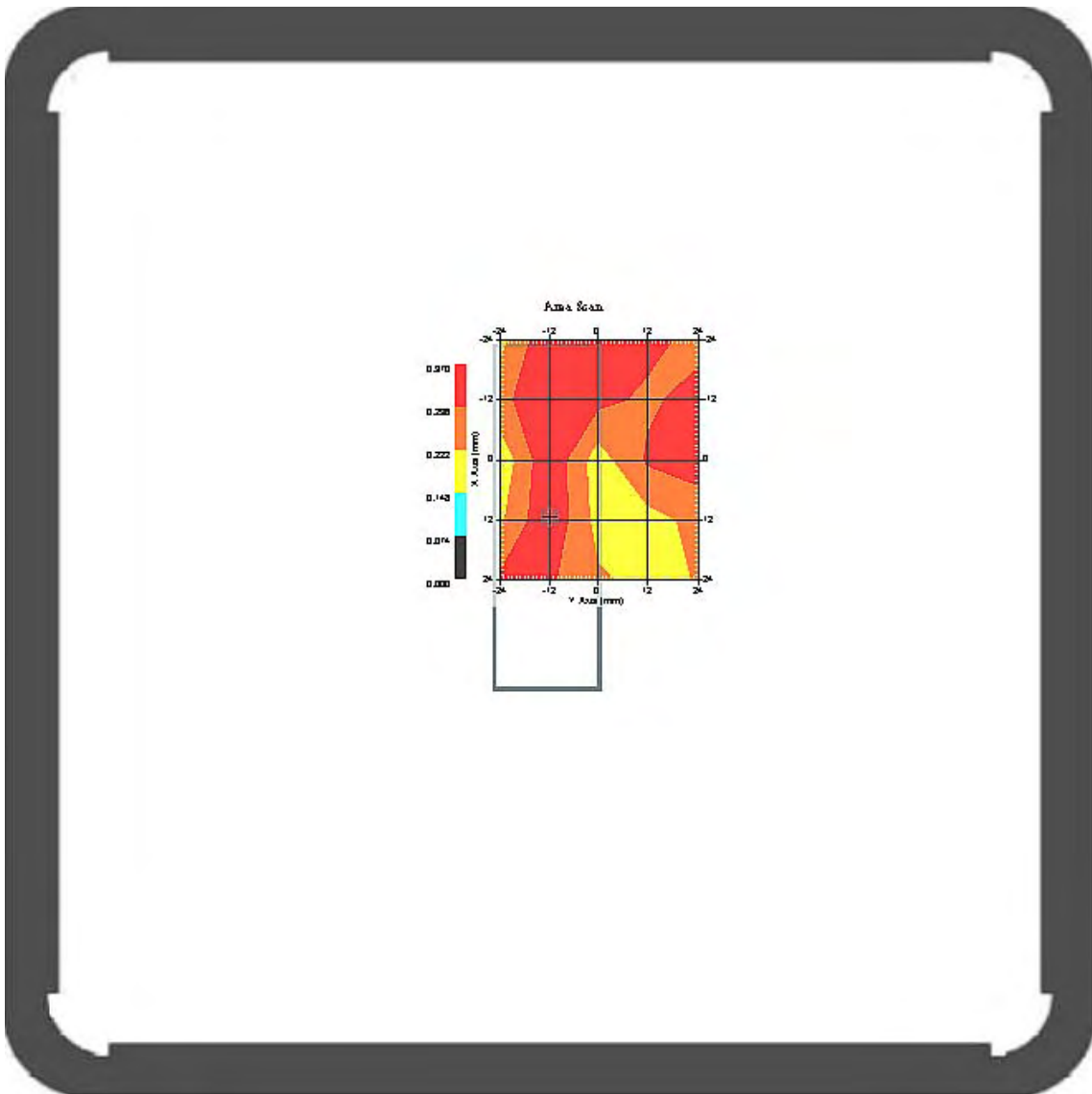

1 gram SAR value : 0.401 W/kg
10 gram SAR value : 0.378 W/kg
Area Scan Peak SAR : 0.368 W/kg
Zoom Scan Peak SAR : 0.400 W/kg

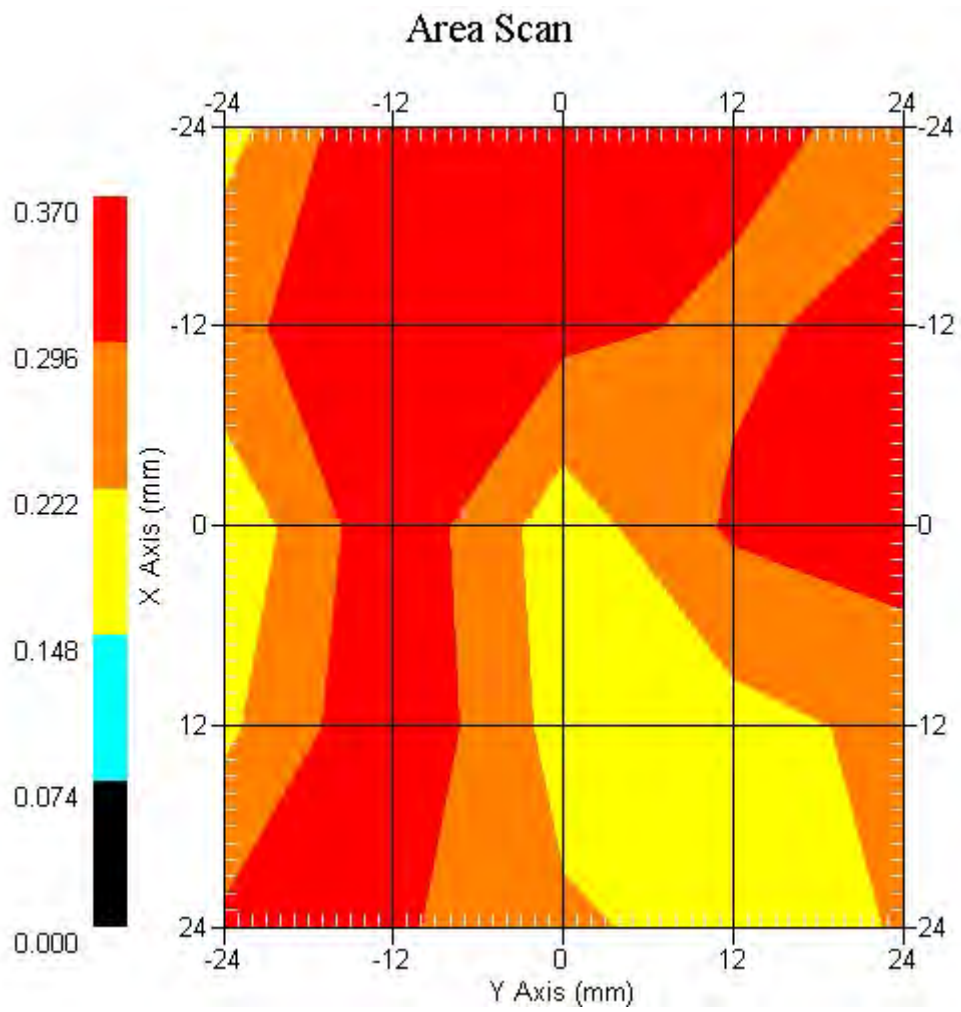

Measurement Data

Crest Factor : 1
Tissue Temp. : 21.10 °C
Ambient Temp. : 22.40 °C
Area Scan : 5x5x1 : Measurement x=12mm, y=12mm, z=4mm
Zoom Scan : 7x7x7 : Measurement x=5mm, y=5mm, z=5mm
Power Drift-Start : 0.251 W/kg
Power Drift-Finish: 0.245 W/kg
Power Drift (%) : -2.390

DUT Position : Touch EUT Back
Channel : 5740

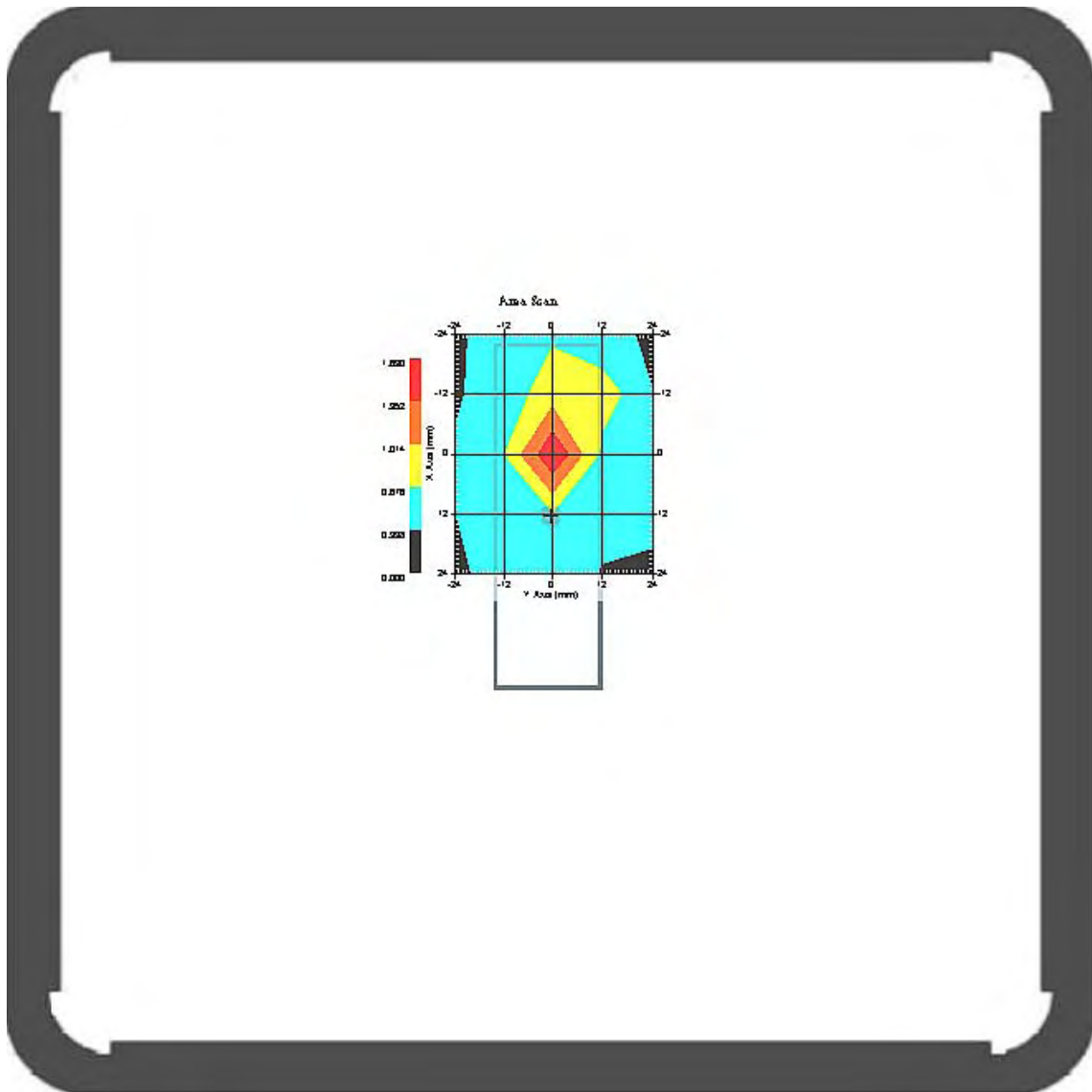

1 gram SAR value : 1.300 W/kg
10 gram SAR value : 0.659 W/kg
Area Scan Peak SAR : 1.689 W/kg
Zoom Scan Peak SAR : 3.252 W/kg

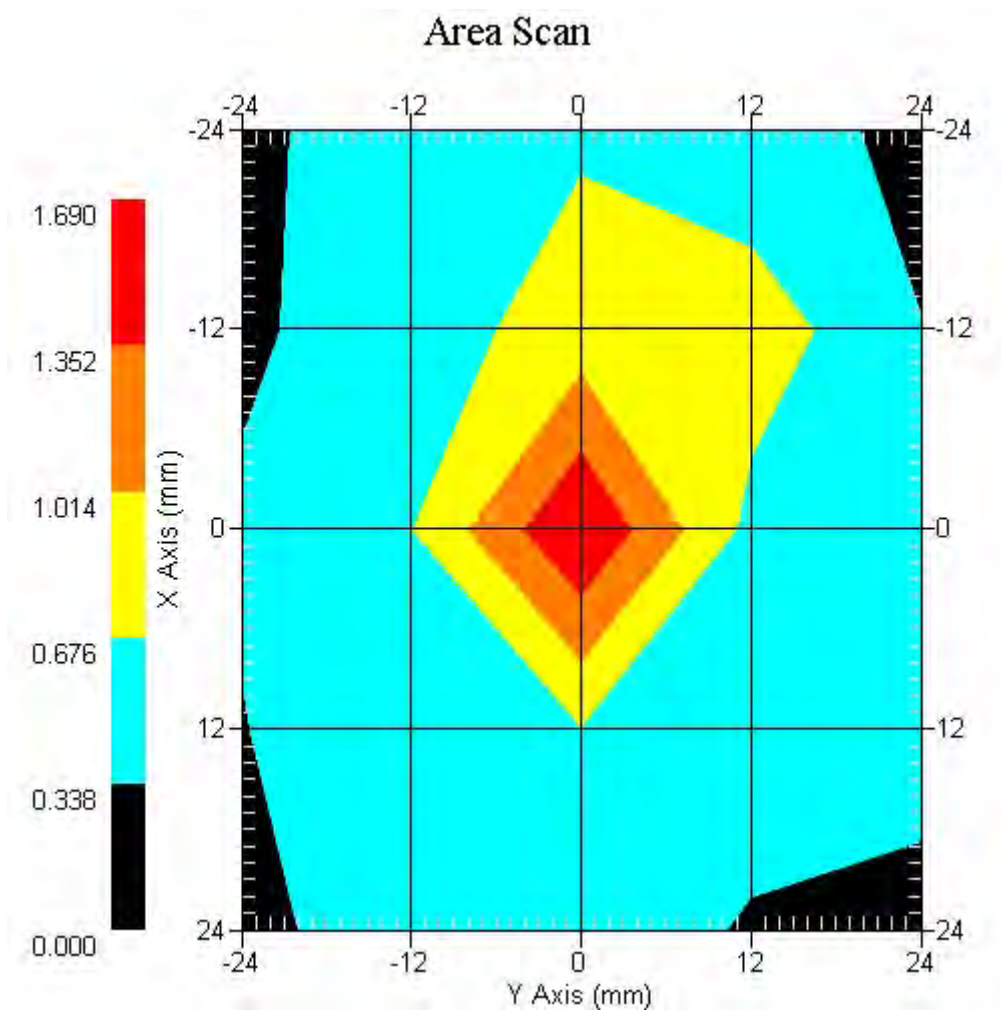

Measurement Data

Crest Factor : 1
Tissue Temp. : 21.10 °C
Ambient Temp. : 22.40 °C
Area Scan : 5x5x1 : Measurement x=12mm, y=12mm, z=4mm
Zoom Scan : 7x7x7 : Measurement x=5mm, y=5mm, z=5mm
Power Drift-Start : 0.236 W/kg
Power Drift-Finish: 0.243 W/kg
Power Drift (%) : 2.966

DUT Position : Touch EUT Back
Channel : 5800

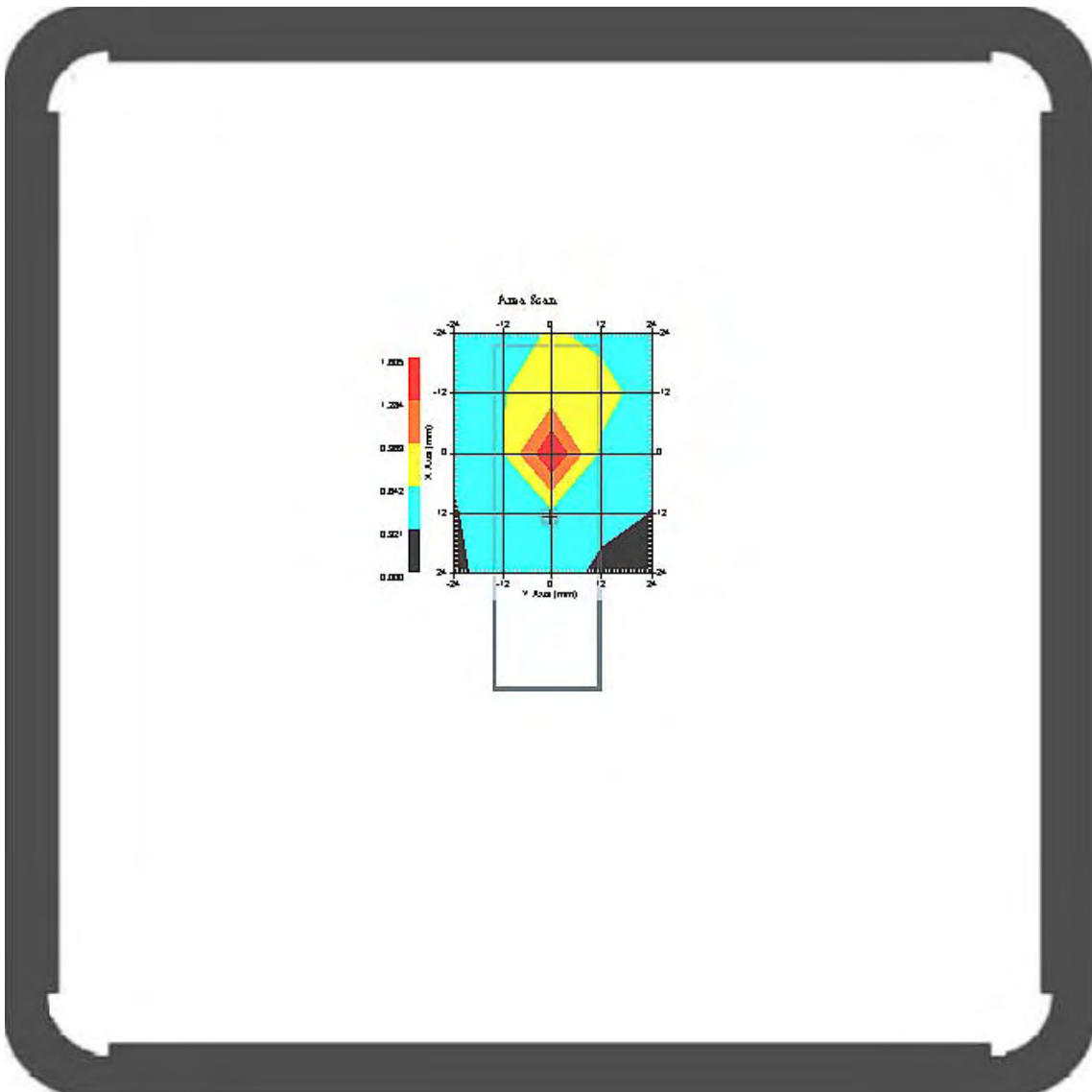

1 gram SAR value : 1.314 W/kg
10 gram SAR value : 0.661 W/kg
Area Scan Peak SAR : 1.605 W/kg
Zoom Scan Peak SAR : 3.282 W/kg

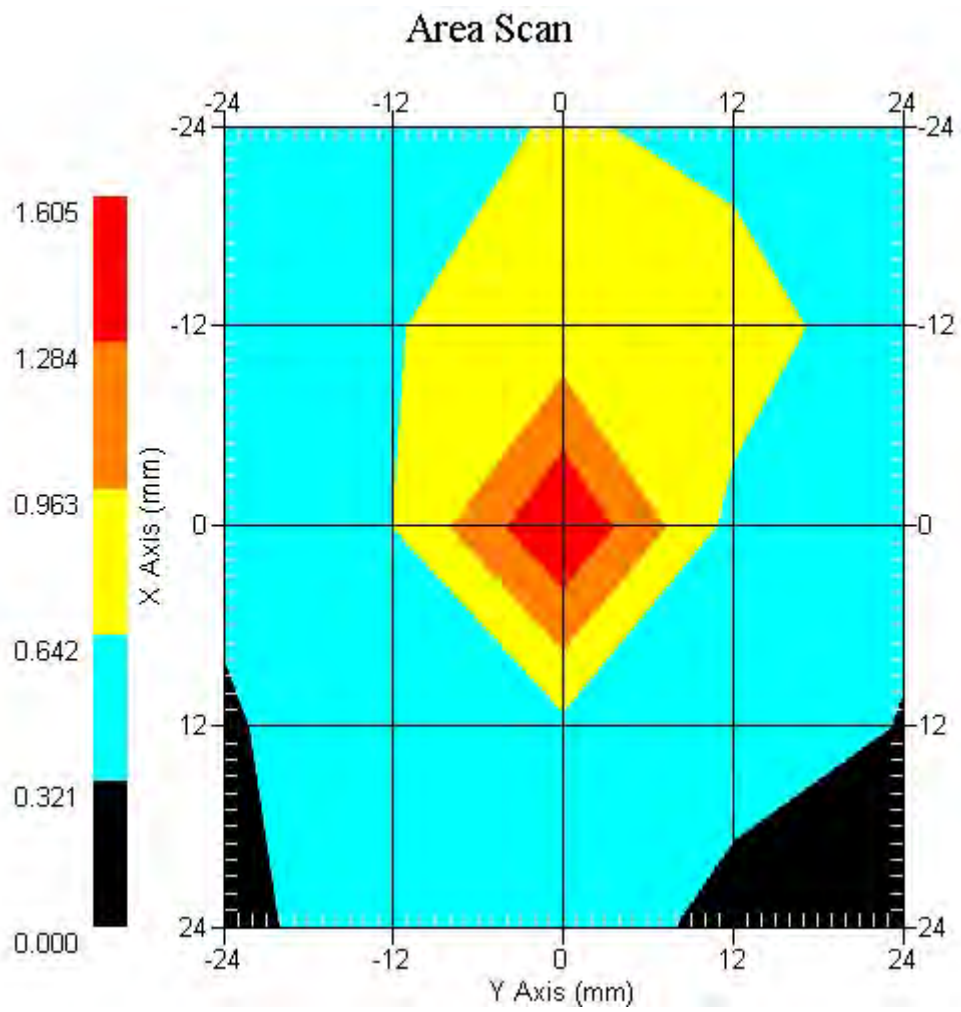

Measurement Data

Crest Factor : 1
Tissue Temp. : 21.10 °C
Ambient Temp. : 22.40 °C
Area Scan : 5x5x1 : Measurement x=12mm, y=12mm, z=4mm
Zoom Scan : 7x7x7 : Measurement x=5mm, y=5mm, z=5mm
Power Drift-Start : 0.269 W/kg
Power Drift-Finish: 0.261 W/kg
Power Drift (%) : -3.059

DUT Position : Touch EUT Back
Channel : 5840

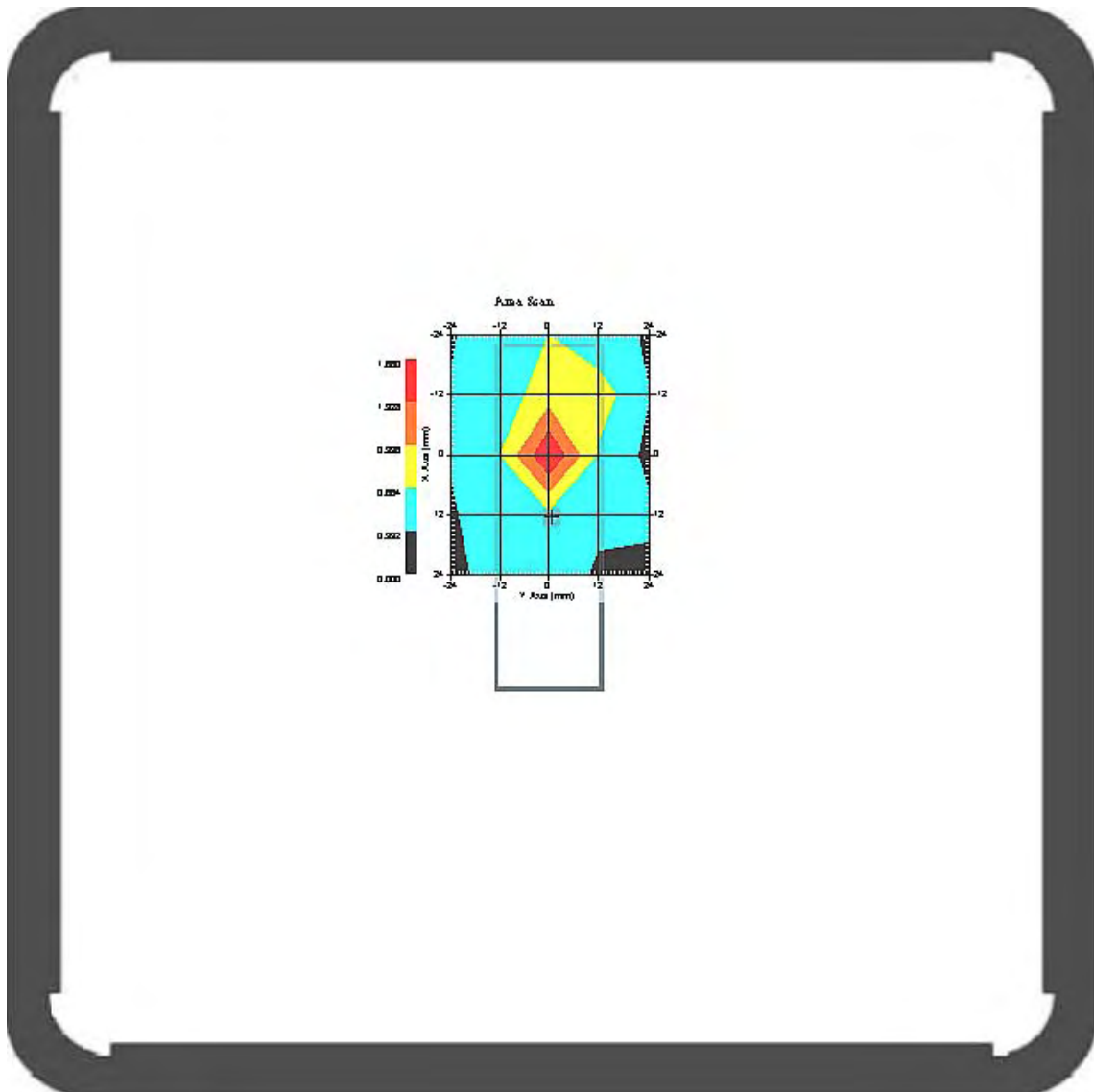

1 gram SAR value : 1.261 W/kg
10 gram SAR value : 0.657 W/kg
Area Scan Peak SAR : 1.658 W/kg
Zoom Scan Peak SAR : 3.052 W/kg

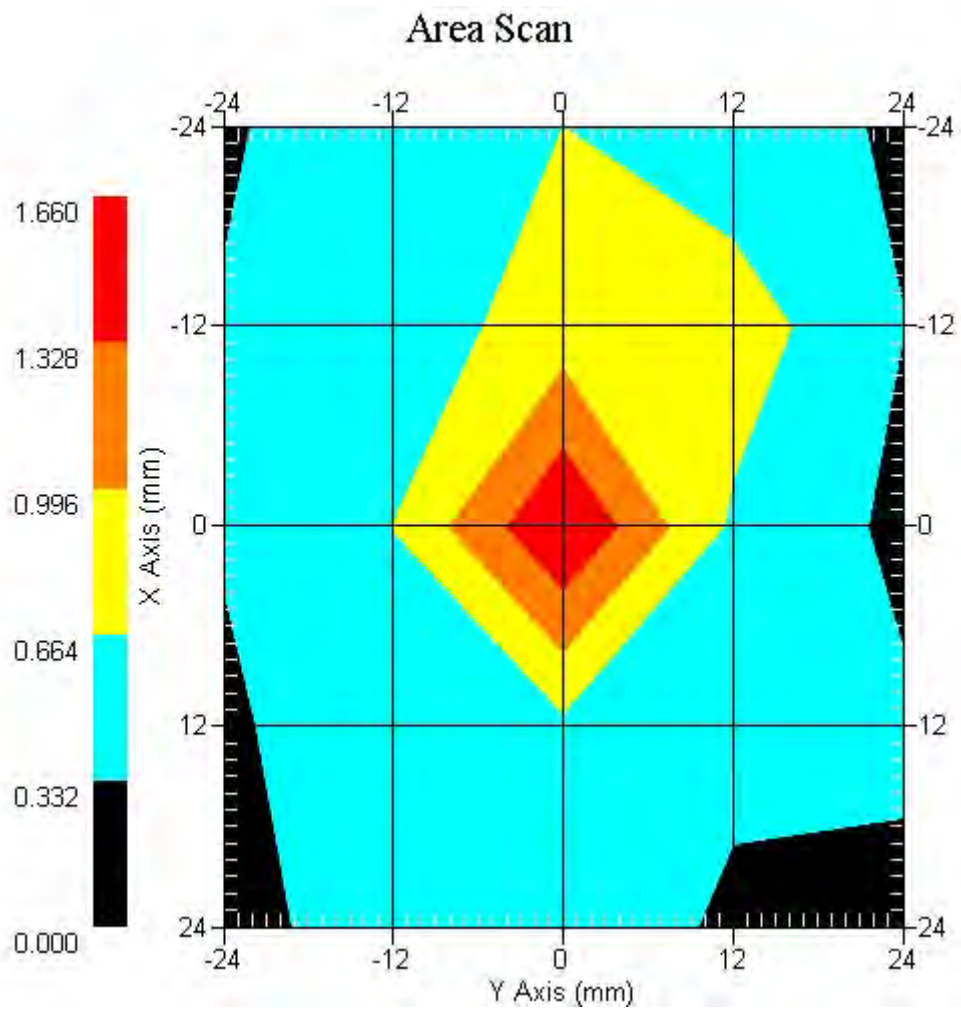

Measurement Data

Crest Factor : 1
Tissue Temp. : 21.10 °C
Ambient Temp. : 22.40 °C
Area Scan : 5x5x1 : Measurement x=12mm, y=12mm, z=4mm
Zoom Scan : 7x7x7 : Measurement x=5mm, y=5mm, z=5mm
Power Drift-Start : 0.481 W/kg
Power Drift-Finish: 0.473 W/kg
Power Drift (%) : -1.663

DUT Position : Touch EUT Top
Channel : 5800

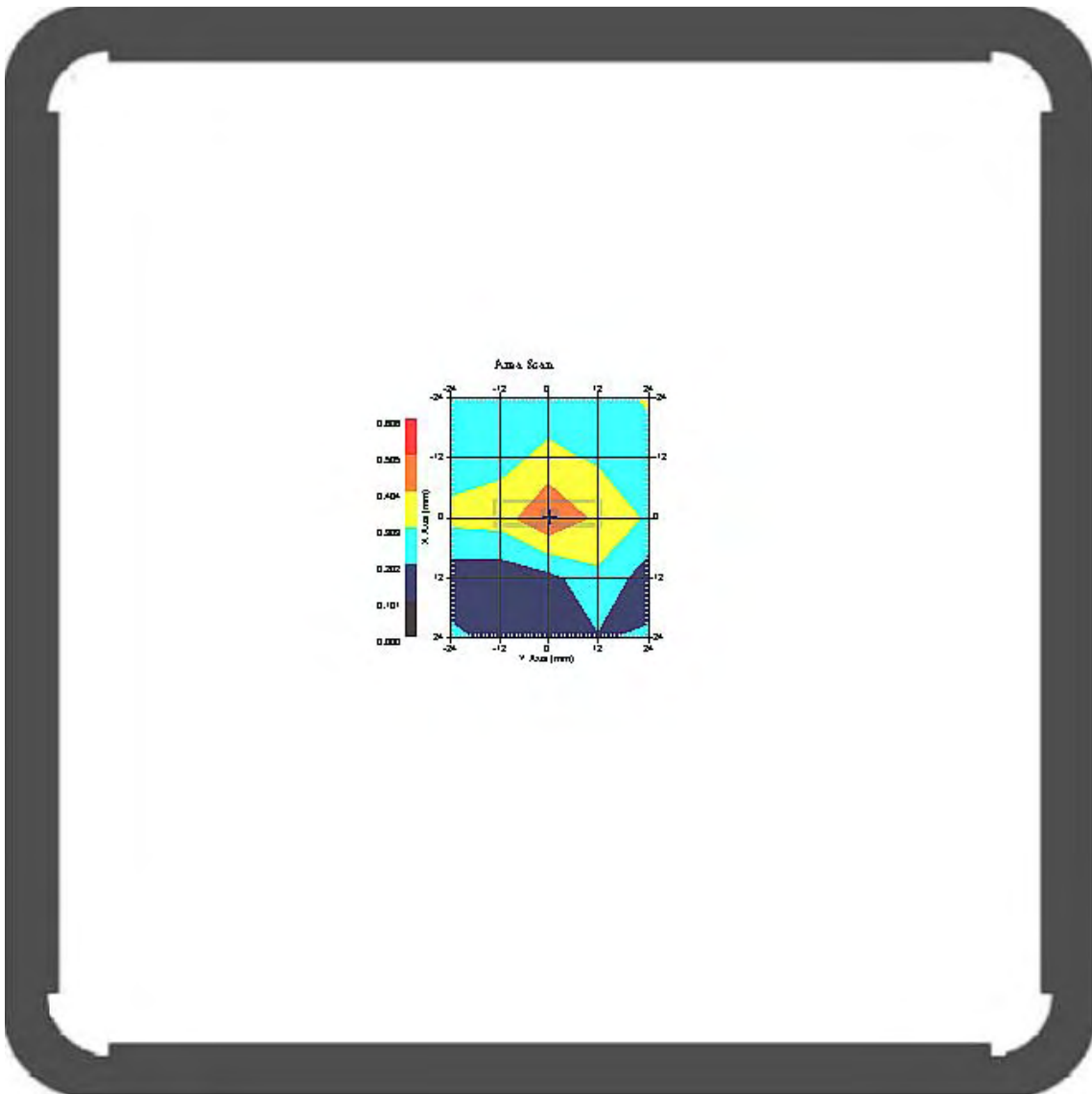

1 gram SAR value : 0.435 W/kg
10 gram SAR value : 0.321 W/kg
Area Scan Peak SAR : 0.506 W/kg
Zoom Scan Peak SAR : 0.410 W/kg

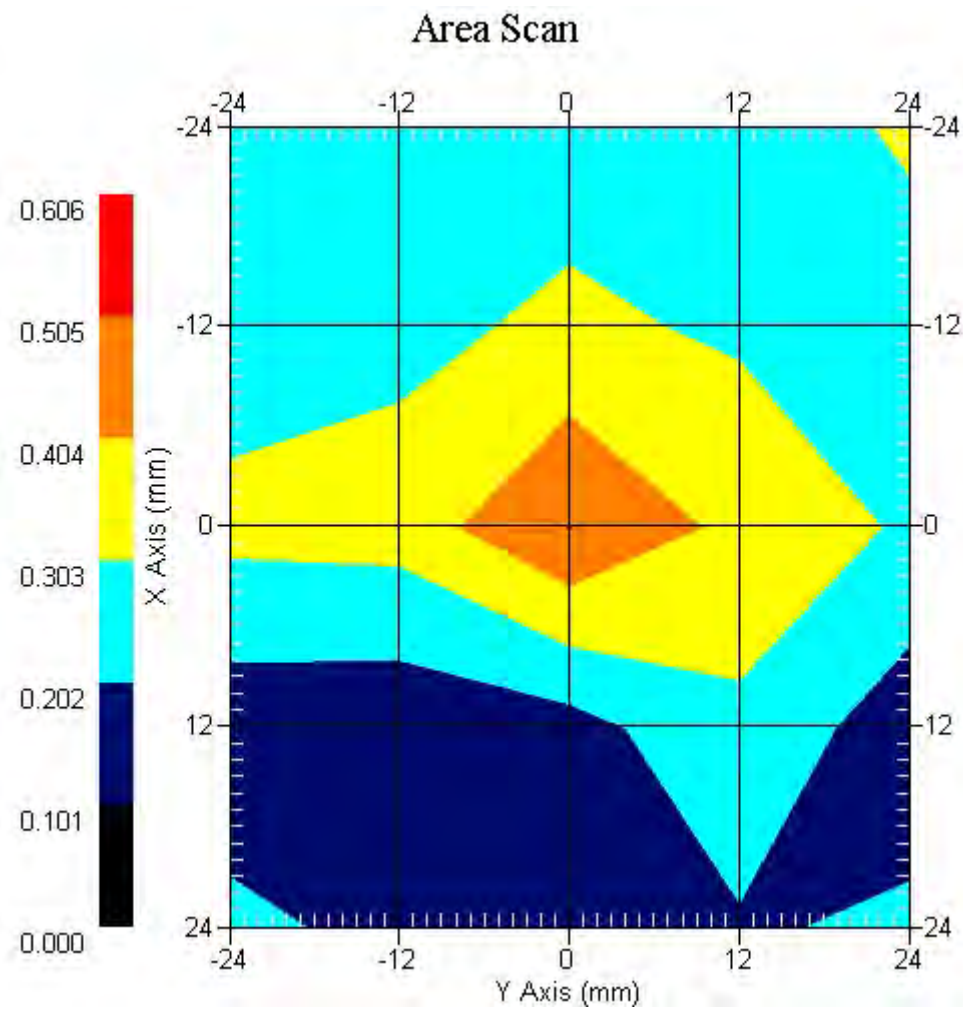

802.11a 5.8GHz with EUT Back, Z-Axis plot

channel: 12

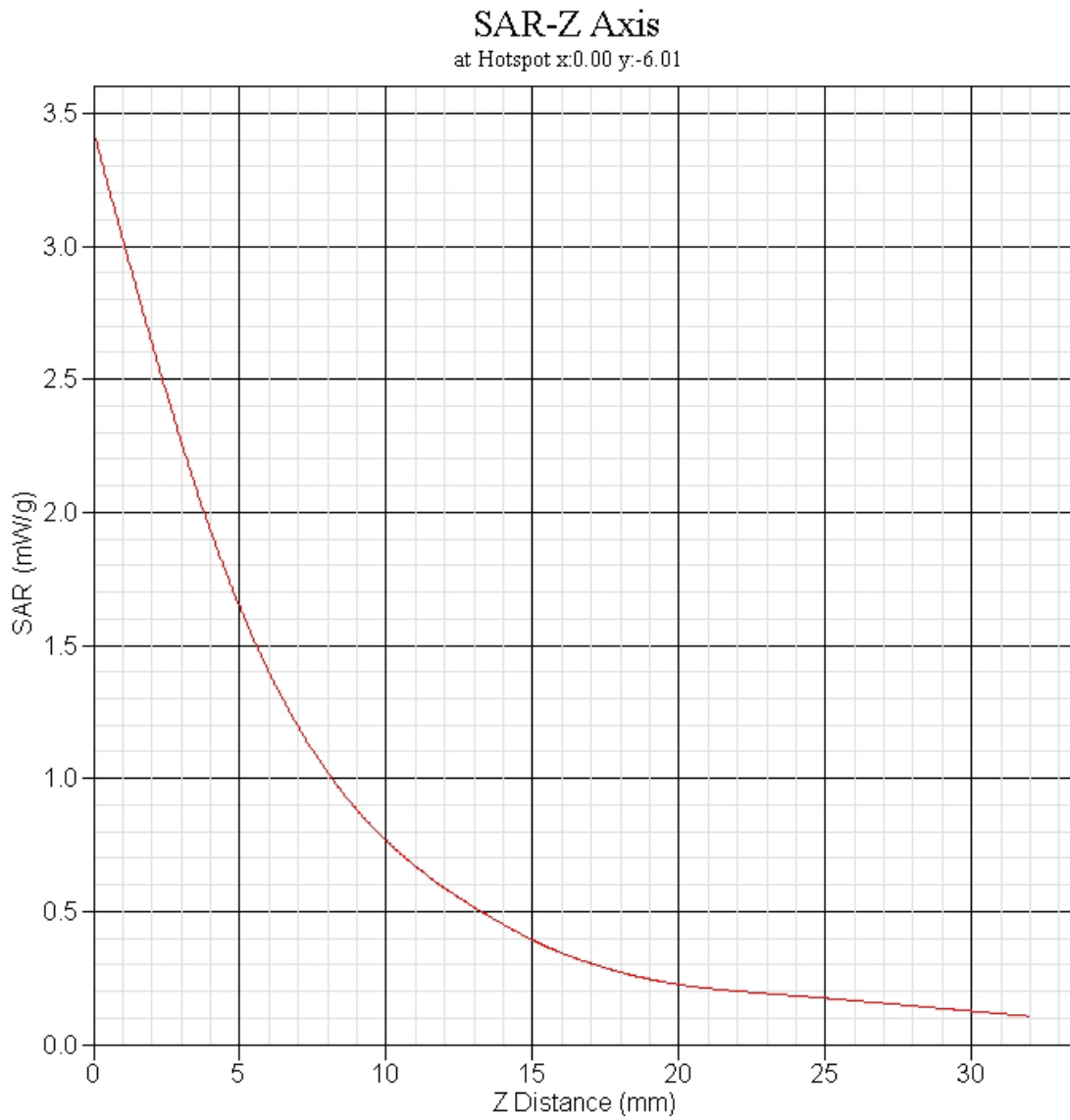

ALSAS-10U VER 2.3.2 APREL Laboratories
SAR Test Report -802.11a 5.8GHz SuperReport Date : 17-Dec-2007
Measurement Date : 17-Dec-2007

Product Data

Device Name : USB
Type : Other
Model : WLU108AG-MC
Frequency : 5800.00 MHz
Drift Time : 0 min(s)
Length : 82 mm
Width : 27 mm
Depth : 8 mm
Antenna Type : Internal

Phantom Data

Type : Uni-Phantom
Size (mm) : 280 x 280 x 200
Location : Center

Tissue Data

Type : BODY
Serial No. : 327-B
Frequency : 5800.00 MHz
Last Calib. Date : 17-Dec-2007
Temperature : 21.10 °C
Ambient Temp. : 22.40 °C
Humidity : 51.00 RH%
Epsilon : 48.31 F/m
Sigma : 6.124 S/m
Density : 1000.00 kg/cu. m

Probe Data

Name : Probe 264
Model : E020
Type : E-Field Triangle
Serial No. : 264
Last Calib. Date : 23-Aug-2007
Frequency : 5800.00 MHz
Duty Cycle Factor: 1
Conversion Factor: 4.3
Probe Sensitivity: 0.61 0.61 0.61 $\mu\text{V}/(\text{V}/\text{m})^2$
Compression Point: 95.00 mV
Offset : 1.56 mm

Measurement Data

Crest Factor : 1
Tissue Temp. : 21.10 °C
Ambient Temp. : 22.40 °C
Area Scan : 5x5x1 : Measurement x=12mm, y=12mm, z=4mm
Zoom Scan : 7x7x7 : Measurement x=5mm, y=5mm, z=5mm
Power Drift-Start : 0.261 W/kg
Power Drift-Finish: 0.266 W/kg
Power Drift (%) : 1.532

DUT Position : Touch EUT Front
Channel : 5800

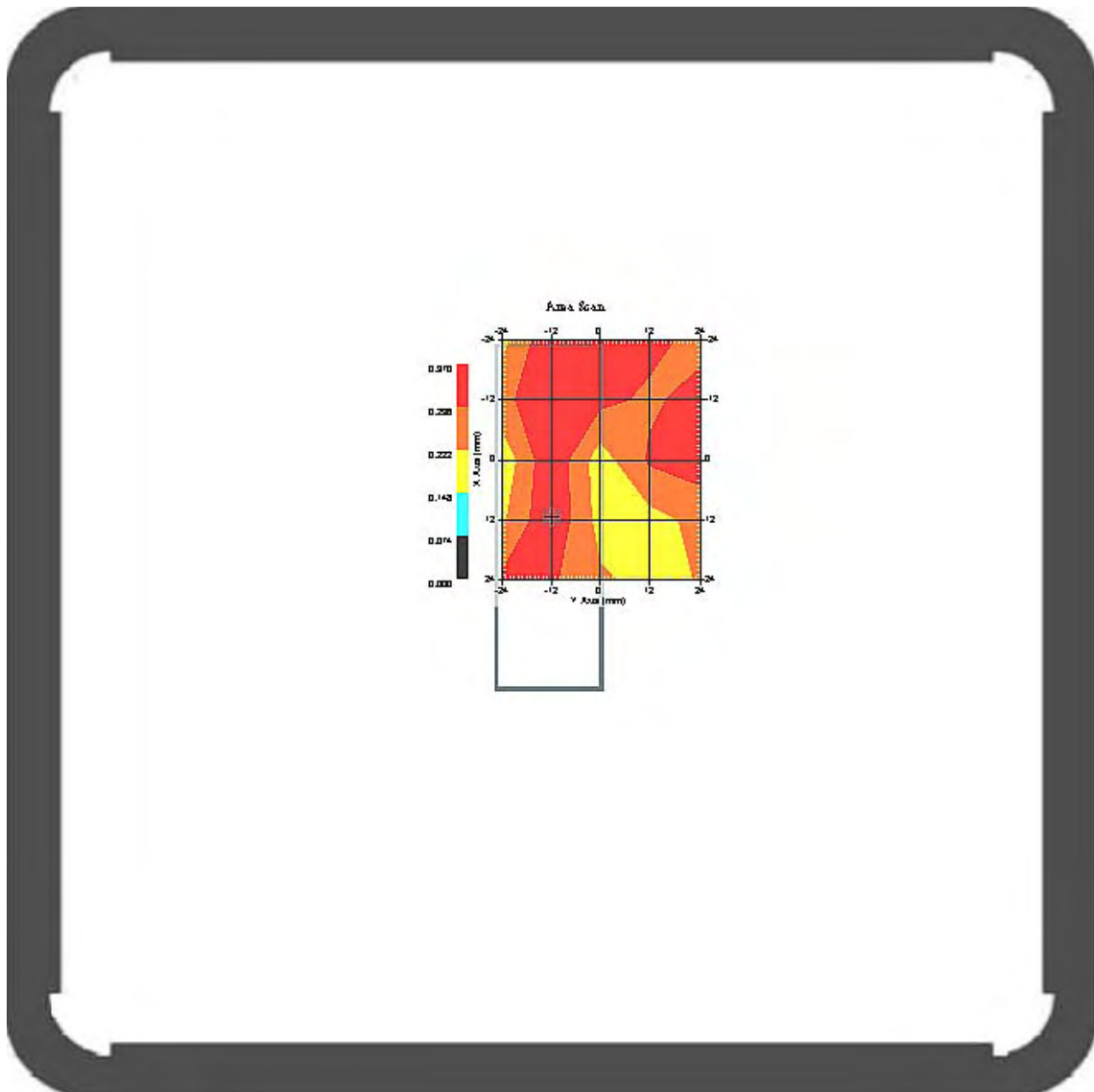

1 gram SAR value : 0.401 W/kg
10 gram SAR value : 0.378 W/kg
Area Scan Peak SAR : 0.368 W/kg
Zoom Scan Peak SAR : 0.400 W/kg

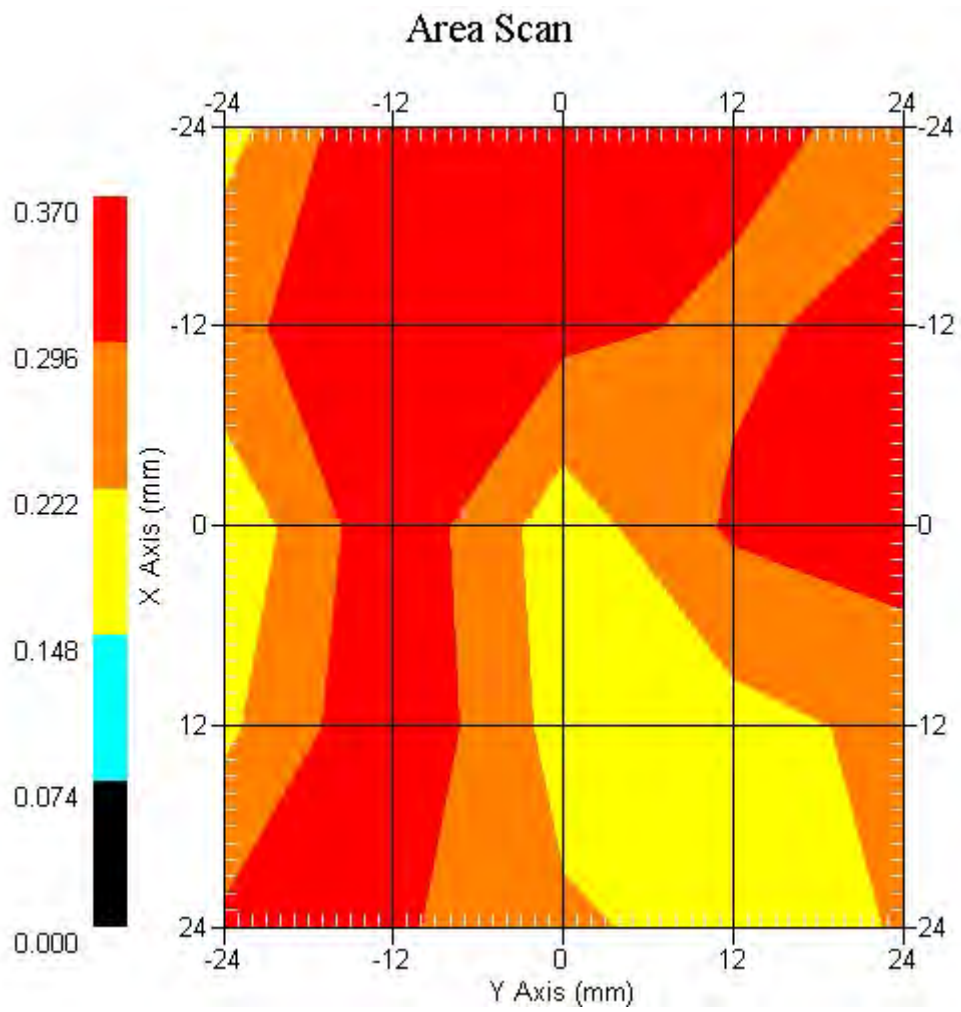

Measurement Data

Crest Factor : 1
Tissue Temp. : 21.10 °C
Ambient Temp. : 22.40 °C
Area Scan : 5x5x1 : Measurement x=12mm, y=12mm, z=4mm
Zoom Scan : 7x7x7 : Measurement x=5mm, y=5mm, z=5mm
Power Drift-Start : 0.248 W/kg
Power Drift-Finish: 0.256 W/kg
Power Drift (%) : 3.225

DUT Position : Touch EUT Back
Channel : 5760

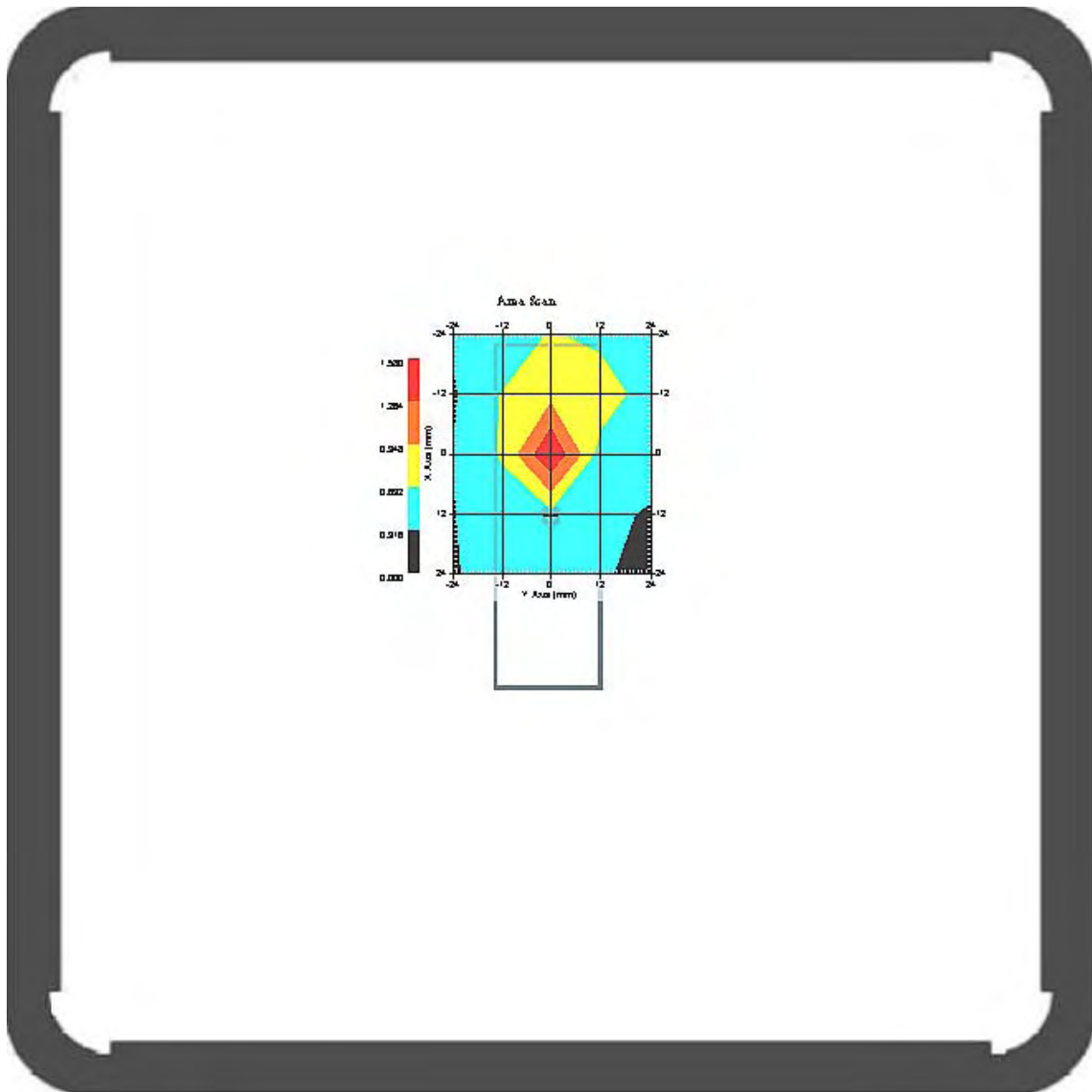

1 gram SAR value : 1.287 W/kg
10 gram SAR value : 0.645 W/kg
Area Scan Peak SAR : 1.579 W/kg
Zoom Scan Peak SAR : 3.262 W/kg

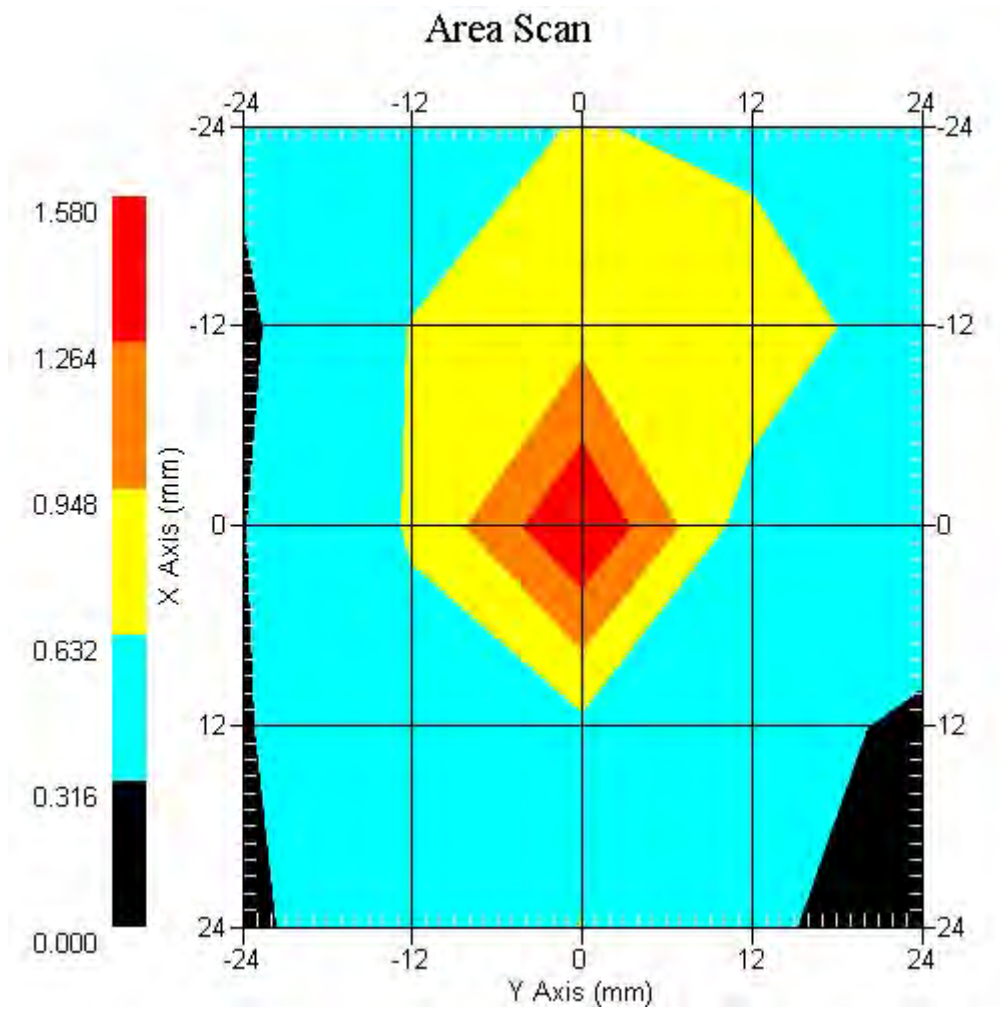

Measurement Data

Crest Factor : 1
Tissue Temp. : 21.10 °C
Ambient Temp. : 22.40 °C
Area Scan : 5x5x1 : Measurement x=12mm, y=12mm, z=4mm
Zoom Scan : 7x7x7 : Measurement x=5mm, y=5mm, z=5mm
Power Drift-Start : 0.236 W/kg
Power Drift-Finish: 0.243 W/kg
Power Drift (%) : 2.966

DUT Position : Touch EUT Back
Channel : 5800

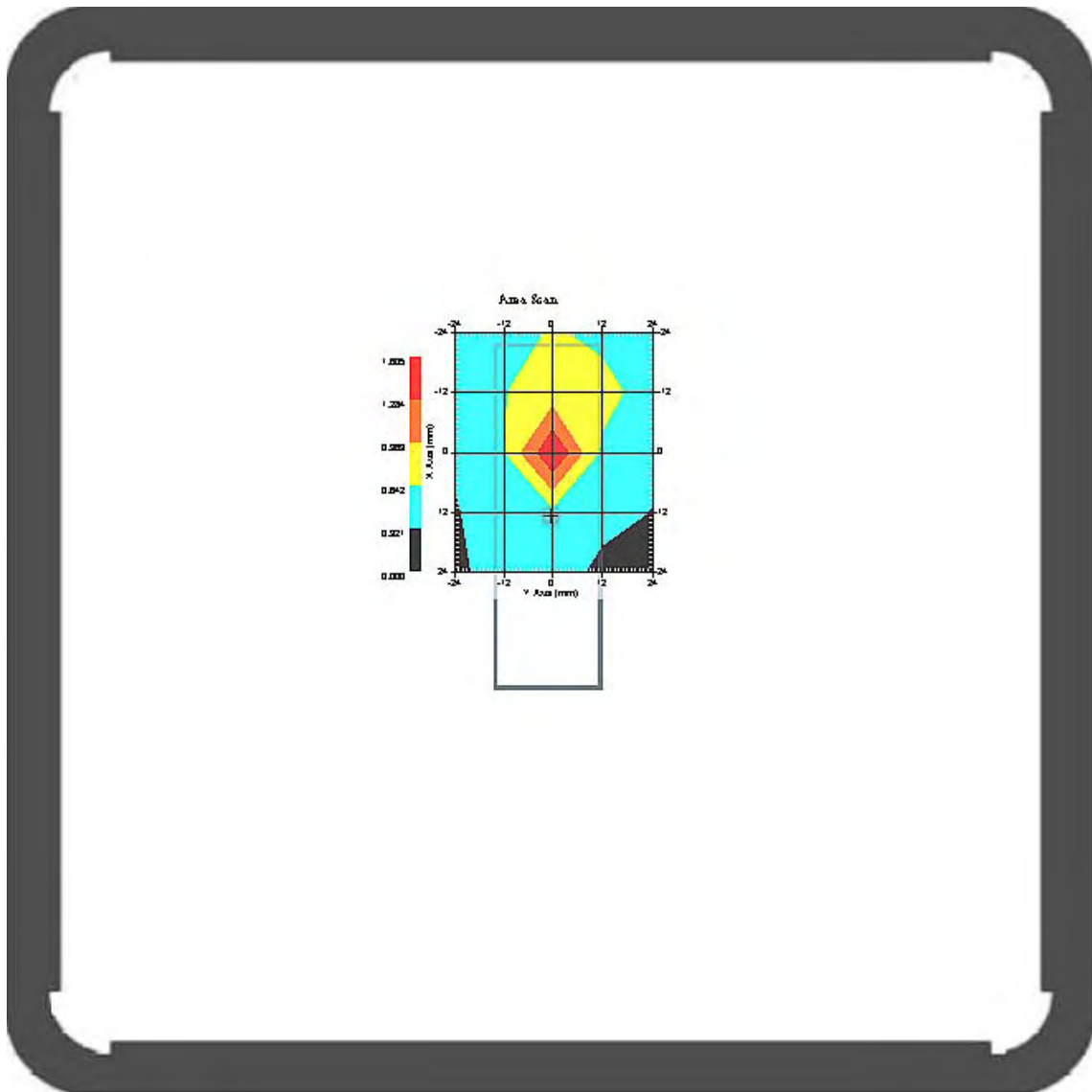

1 gram SAR value : 1.314 W/kg
10 gram SAR value : 0.661 W/kg
Area Scan Peak SAR : 1.605 W/kg
Zoom Scan Peak SAR : 3.282 W/kg

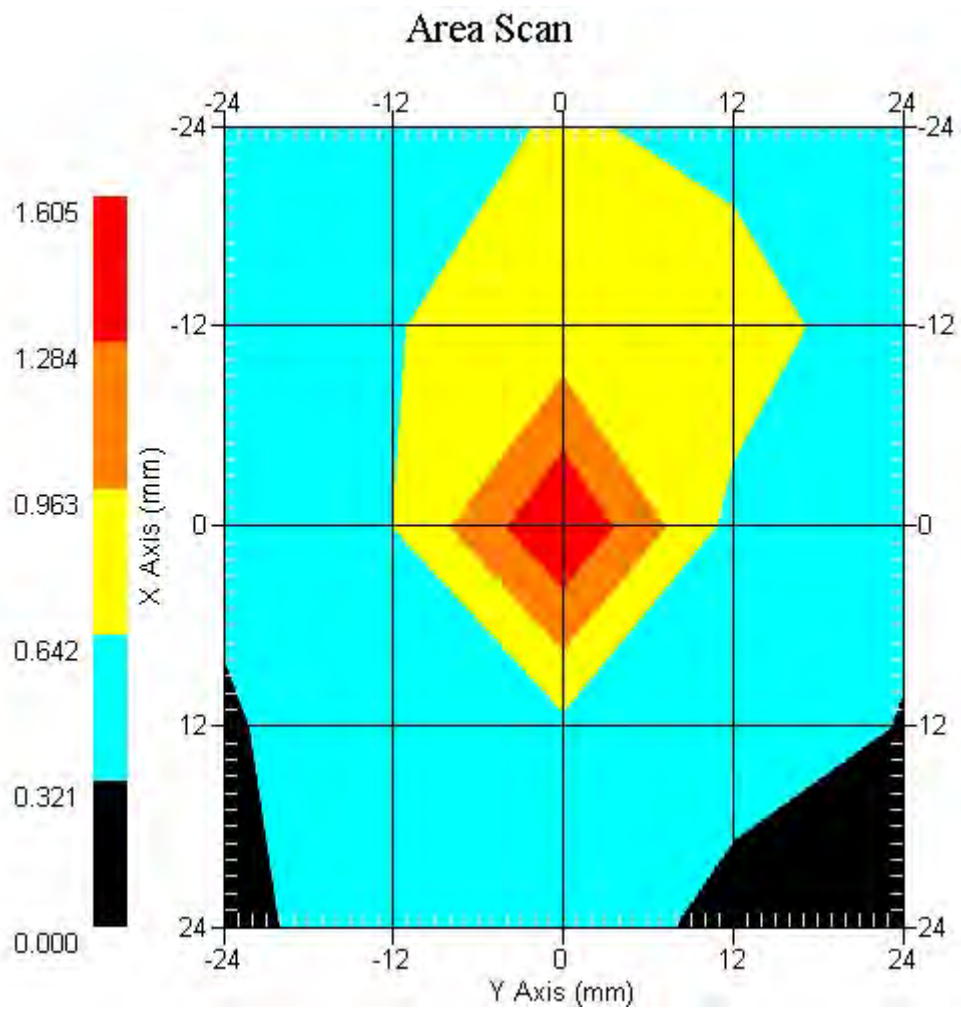

Measurement Data

Crest Factor : 1
Tissue Temp. : 21.10 °C
Ambient Temp. : 22.40 °C
Area Scan : 5x5x1 : Measurement x=12mm, y=12mm, z=4mm
Zoom Scan : 7x7x7 : Measurement x=5mm, y=5mm, z=5mm
Power Drift-Start : 0.252 W/kg
Power Drift-Finish: 0.246 W/kg
Power Drift (%) : -2.169

DUT Position : Touch EUT Back
Channel : 5820

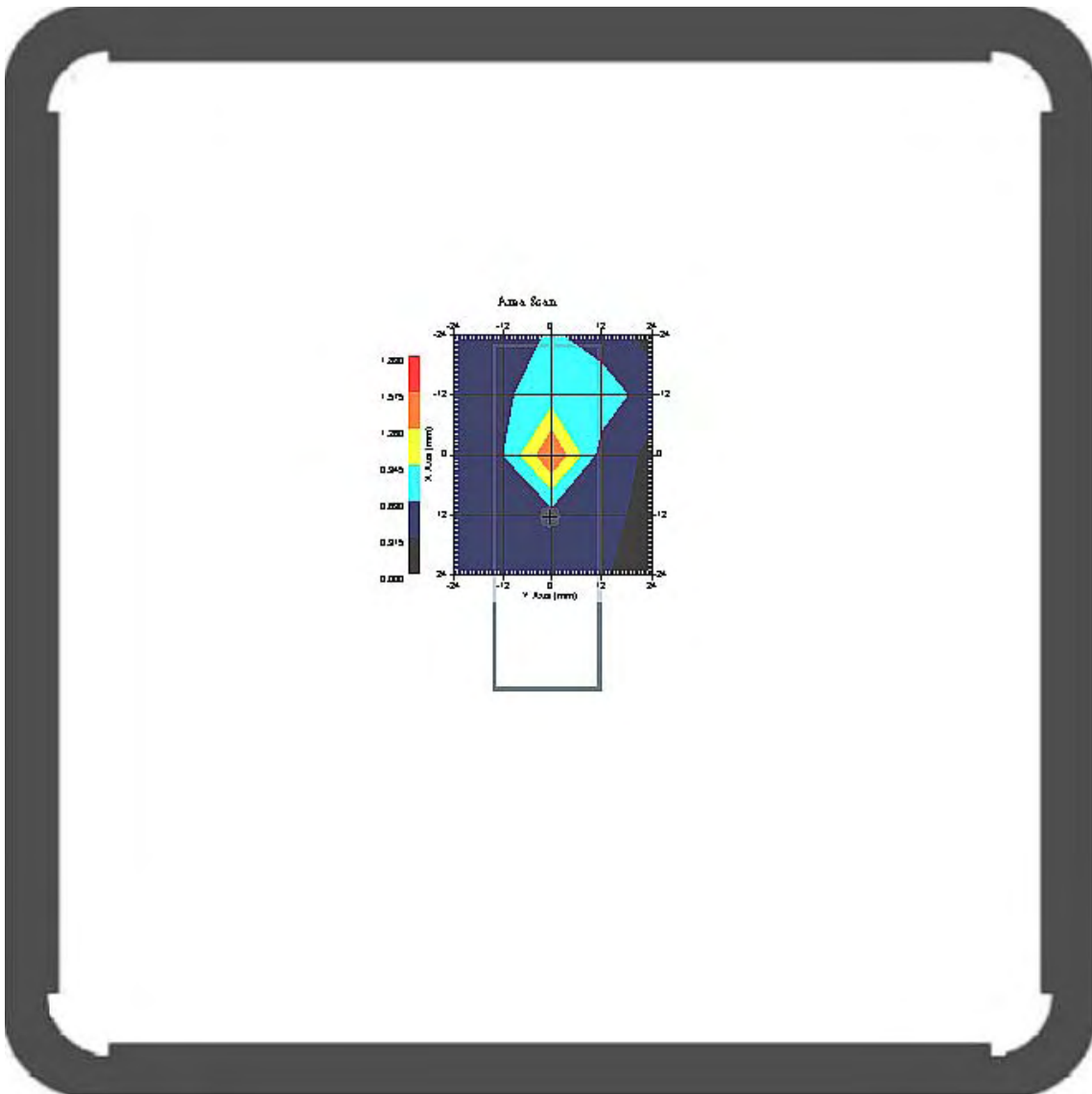

1 gram SAR value : 1.267 W/kg
10 gram SAR value : 0.632 W/kg
Area Scan Peak SAR : 1.577 W/kg
Zoom Scan Peak SAR : 3.152 W/kg

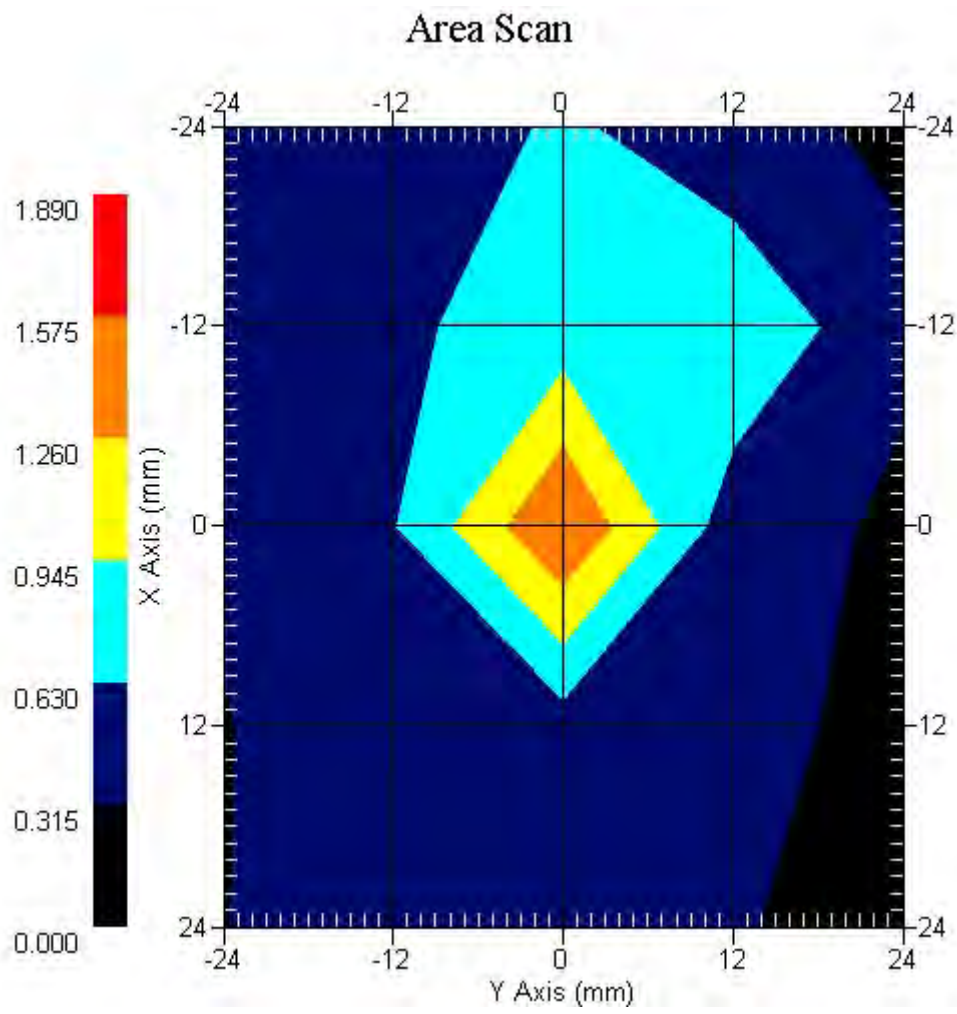

Measurement Data

Crest Factor : 1
Tissue Temp. : 21.10 °C
Ambient Temp. : 22.40 °C
Area Scan : 5x5x1 : Measurement x=12mm, y=12mm, z=4mm
Zoom Scan : 7x7x7 : Measurement x=5mm, y=5mm, z=5mm
Power Drift-Start : 0.481 W/kg
Power Drift-Finish: 0.473 W/kg
Power Drift (%) : -1.663

DUT Position : Touch EUT Top
Channel : 5800

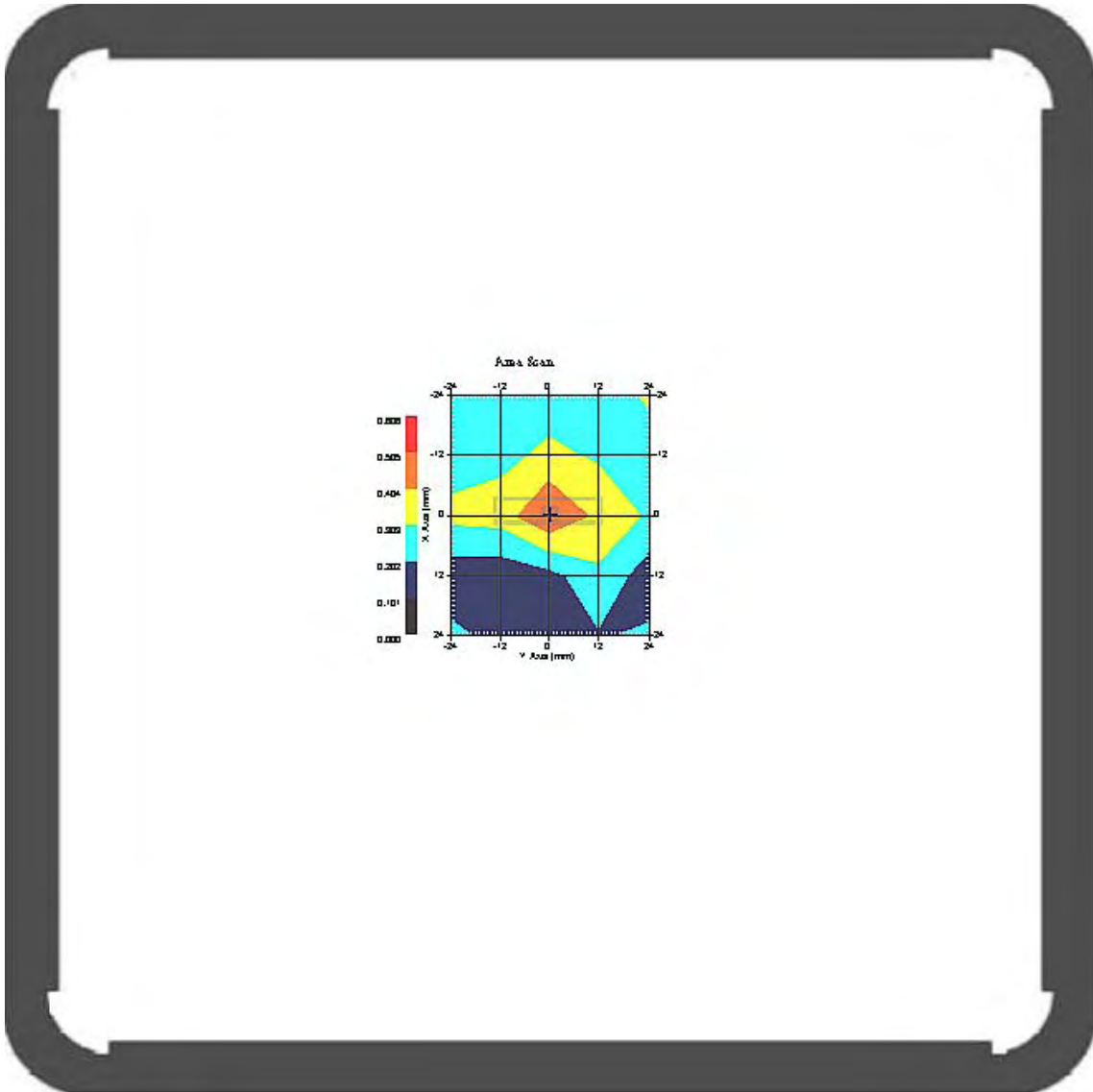

1 gram SAR value : 0.435 W/kg
10 gram SAR value : 0.321 W/kg
Area Scan Peak SAR : 0.506 W/kg
Zoom Scan Peak SAR : 0.410 W/kg

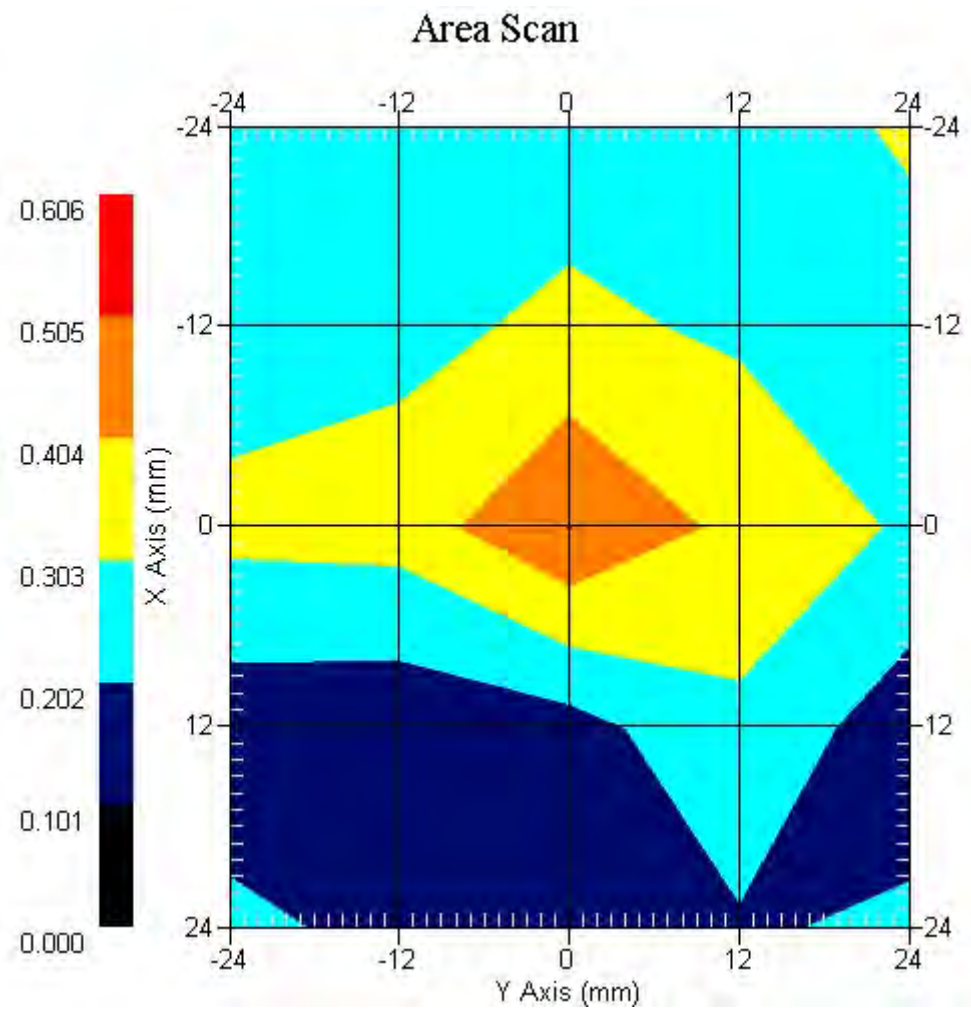

802.11a 5.8GHz Super with EUT Top, Z-Axis plot
channel: 12

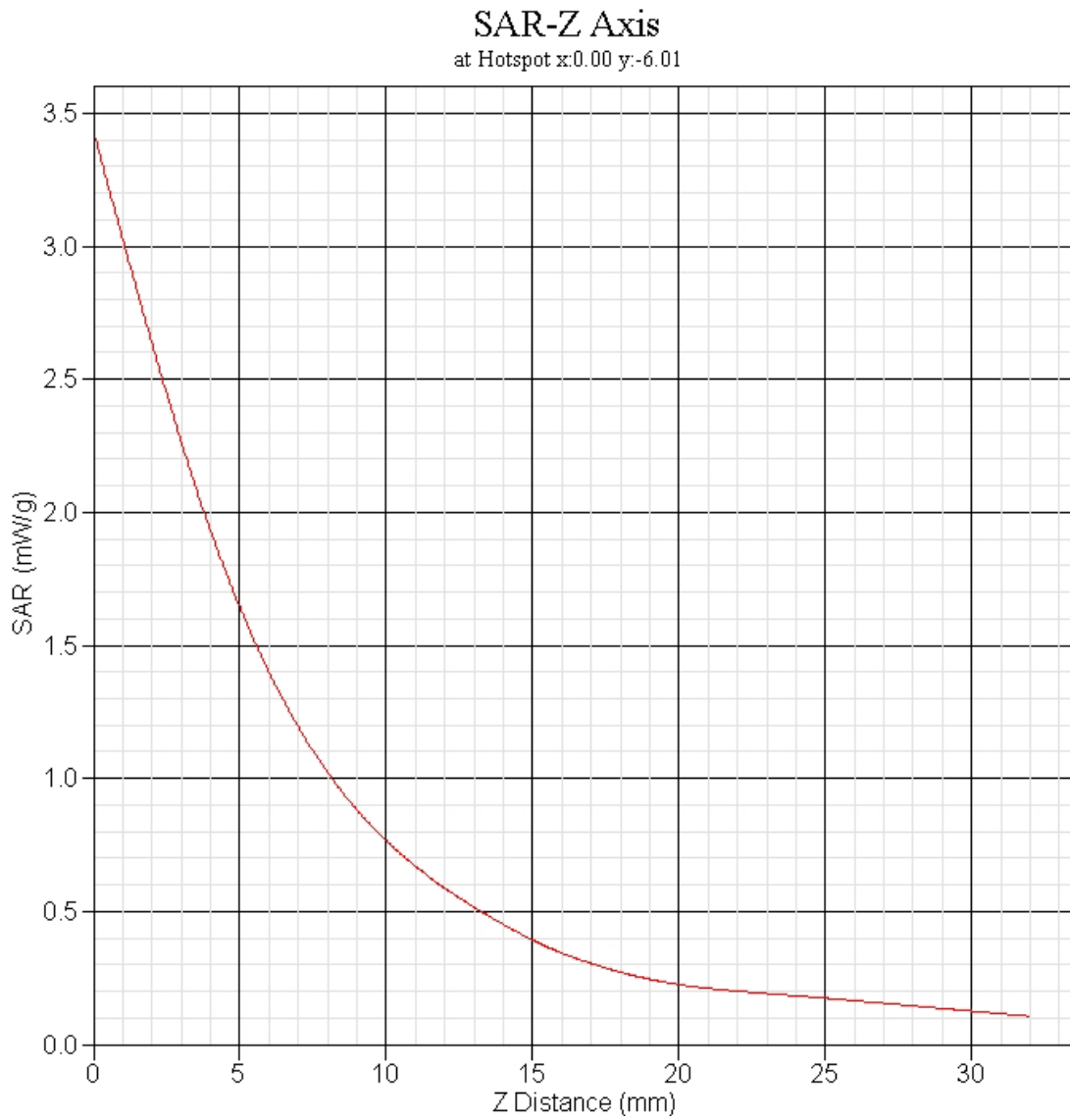

Appendix C. Test Setup Photographs & EUT Photographs

Test Setup Photographs

EUT Front

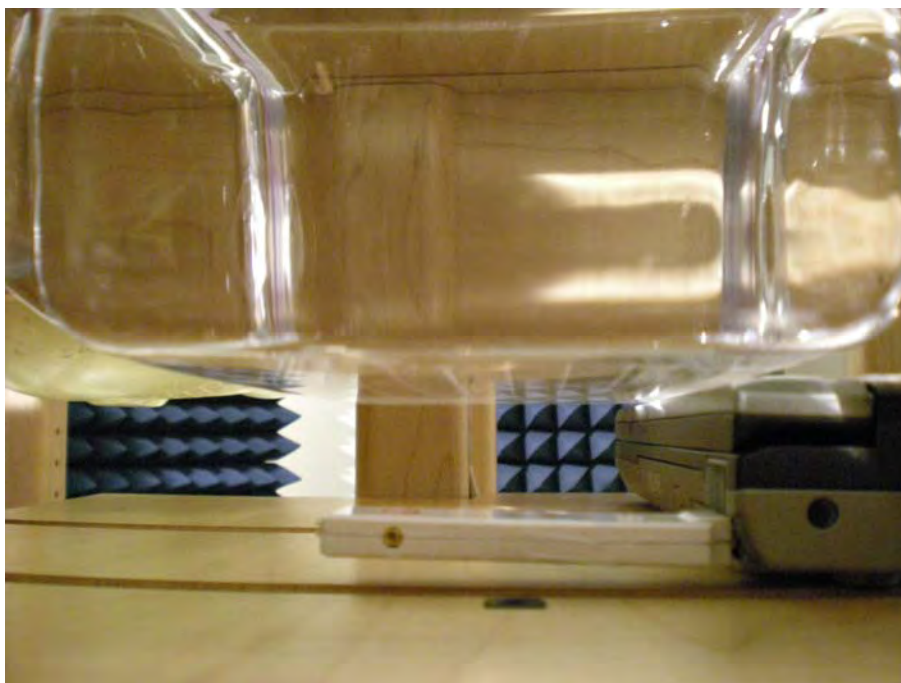

EUT Back

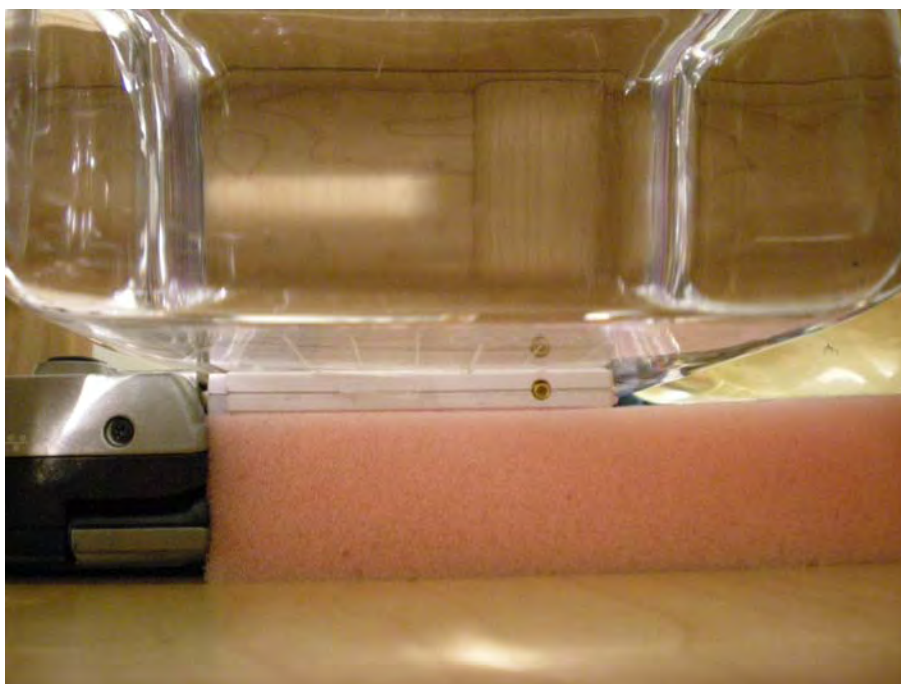

EUT Top

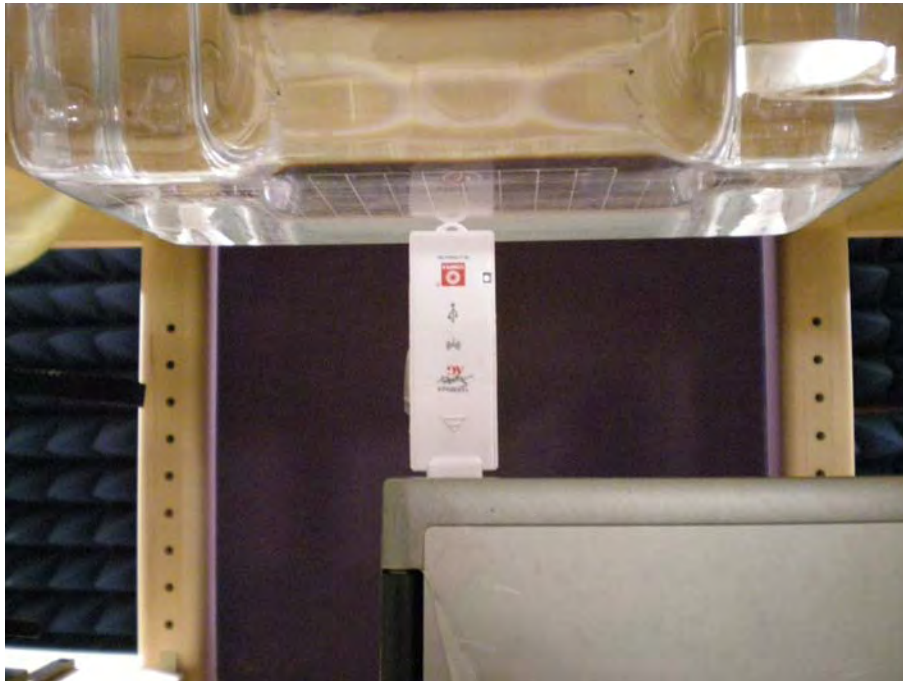

Test EUT Photographs

EUT with Notebook

